

MEASUREMENT REPORT

FCC PART 27 Subpart M

FCC ID: 2AD8UAWHHA01

Application: Nokia Solutions and Networks, OY

Application Type: Certification

Product: AirScale Indoor Radio ASiR 5G-pRRH

Model No.: AWHHA

Brand Name: Nokia

FCC Rule Part(s): Part 27 Subpart M

Test Procedure(s): ANSI C63.26-2015, KDB 971168 D01v03r01

Test Date: May 10 ~ June 04, 2020

Reviewed By:

Paddy Chen

(Paddy Chen)

Approved By:

Chenz Ker

(Chenz Ker)



Testing Laboratory
3261

The test results relate only to the samples tested.

This equipment has been shown to be capable of compliance with the applicable technical standards as indicated in the measurement report and was tested in accordance with the measurement procedures specified in ANSI C63.26-2015. Test results reported herein relate only to the item(s) tested.

The test report shall not be reproduced except in full without the written approval of MRT Technology (Taiwan) Co., Ltd.

Revision History

Report No.	Version	Description	Issue Date	Note
2005TW0004-U1	Rev. 01	Initial Report	06-04-2020	Valid

Note: This report is prepared for FCC Class II permissive supplement to MRT Original "1909TW0102-U1" Report adding LTE technology and related data

CONTENTS

Description	Page
General Information	5
1. INTRODUCTION	6
1.1. Scope	6
1.2. MRT Test Location	6
2. PRODUCT INFORMATION	7
2.1. Equipment Description	7
2.2. Emission Designator	8
2.3. Description of Available Antennas	8
2.4. Test Mode	9
2.5. EMI Suppression Device(s)/Modifications	9
2.6. Labeling Requirements	9
3. DESCRIPTION of TEST	10
3.1. Evaluation Procedure	10
3.2. Radiated Emissions	10
4. TEST EQUIPMENT CALIBRATION DATE	12
5. MEASUREMENT UNCERTAINTY	14
6. TEST RESULT	15
6.1. Summary	15
6.2. Equivalent Isotropically Radiated Power Measurement	16
6.2.1. Test Limit	16
6.2.2. Test Procedures Used	16
6.2.3. Test Setting	16
6.2.4. Test Setup	17
6.2.5. Test Result	18
6.3. Frequency Stability Measurement	24
6.3.1. Test Limit	24
6.3.2. Test Procedures Used	24
6.3.3. Test Setting	24
6.3.4. Test Setup	25
6.3.5. Test Result	26
6.4. Emission Bandwidth	27
6.4.1. Test Limit	27
6.4.2. Test Procedure	27

6.4.3.	Test Setting	27
6.4.4.	Test Setup	27
6.4.5.	Test Result	28
6.5.	Band Edge Measurement	43
6.5.1.	Test Limit	43
6.5.2.	Test Procedure Used.....	43
6.5.3.	Test Setting	43
6.5.4.	Test Setup	44
6.5.5.	Test Result	45
6.6.	Peak to Average Ratio.....	72
6.6.1.	Test Limit	72
6.6.2.	Test Procedure Used.....	72
6.6.3.	Test Setting	72
6.6.4.	Test Setup	73
6.6.5.	Test Result	74
6.7.	Conducted Spurious Emissions.....	125
6.7.1.	Test Limit	125
6.7.2.	Test Procedure Used.....	125
6.7.3.	Test Setting	125
6.7.4.	Test Setup	126
6.7.5.	Test Result	127
6.8.	Radiated Spurious Emissions Measurements	142
6.8.1.	Test Limit	142
6.8.2.	Test Procedure Used.....	142
6.8.3.	Test Setting	142
6.8.4.	Test Setup	143
6.8.5.	Test Result	144
7.	CONCLUSION	156

General Information

Applicant:	Nokia Solutions and Networks, OY
Applicant Address:	2000 W. Lucent Lane, Naperville, Illinois, United States, 60563
Manufacturer:	Nokia Solutions and Networks, OY
Manufacturer Address:	2000 W. Lucent Lane, Naperville, Illinois, United States, 60563
Test Site:	MRT Technology (Taiwan) Co., Ltd
Test Site Address:	No. 38, Fuxing Second Rd., Guishan Dist., Taoyuan City 333, Taiwan (R.O.C)

Test Facility / Accreditations

Measurements were performed at MRT Laboratory located in Fuxing Rd., Taoyuan, Taiwan (R.O.C)

- MRT facility is a FCC registered (Reg. No. TW3261) test facility with the site description report on file and is designated by the FCC as an Accredited Test Film.
- MRT facility is an IC registered (MRT Reg. No. 21723-1) test laboratory with the site description on file at Industry Canada.
- MRT Lab is accredited to ISO 17025 by the American Association for Laboratory Accreditation (TAF) under the American Association for Laboratory Accreditation Program (TAF Cert. No. 3261) in EMC, Telecommunications and Radio testing for FCC, Industry Taiwan, EU and TELEC Rules.

1. INTRODUCTION

1.1. Scope

Measurement and determination of electromagnetic emissions (EMC) of radio frequency devices including intentional and/or unintentional radiators for compliance with the technical rules and regulations of the Federal Communications Commission and the Innovation, Science and Economic Development and Engineering Bureau.

1.2. MRT Test Location

The map below shows the location of the MRT LABORATORY, its proximity to the Taoyuan City. These measurement tests were conducted at the MRT Technology (Taiwan) Co., Ltd. Facility located at No.38, Fuxing 2nd Rd., Guishan Dist., Taoyuan City 33377, Taiwan (R.O.C).

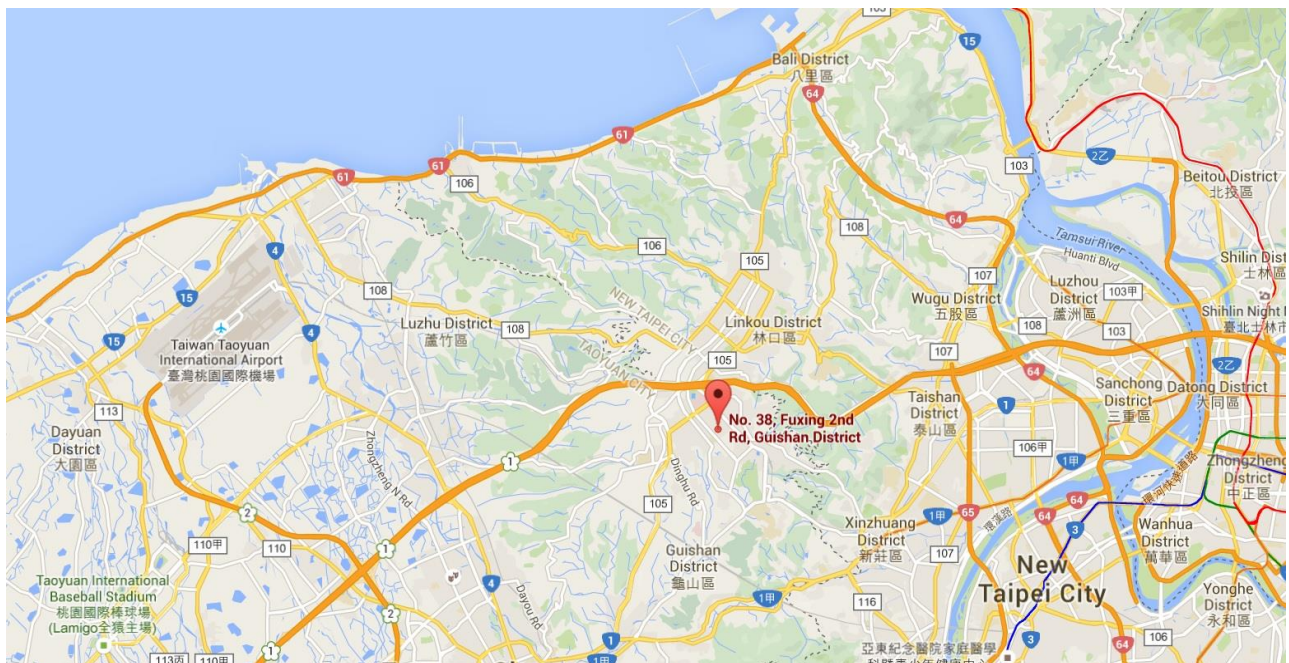

2. PRODUCT INFORMATION

2.1. Equipment Description

Product Name:	AirScale Indoor Radio ASiR 5G-pRRH
Model No.:	AWHHA
Brand Name:	Nokia
Test Device Serial No.:	NH192400228
Hardware Version:	X22
Software Version:	474924A
Power Supply Rating:	PoE (52 ~ 57Vdc)
Operating Band (s):	5G NR Band n41, LTE Band 41
5G NR n41 Carrier Bandwidth:	60MHz, 100MHz
LTE Band 41 Carrier Bandwidth:	20MHz, 20+20MHz, 20+20+20MHz
Modulation Type:	QPSK, 16QAM, 64QAM, 256QAM
Tx Frequency Range:	2496 ~ 2690 MHz
Rx Frequency Range:	2496 ~ 2690 MHz
LTE Band 41 Max EIRP Power:	20MHz: 2*2 Tx Mode: 36.23dBm; 4*4 Tx Mode:42.14dBm 20+20MHz: 2*2 Tx Mode: 36.53dBm; 4*4 Tx Mode: 42.38dBm 20+20+20 MHz: 2*2 Tx Mode:36.02dBm; 4*4 Tx Mode: 41.96dBm
Emission Designator:	Refer to Section 2.2
Antenna Specification:	Refer to Section 2.3

2.2. Emission Designator

Bandwidth (MHz)	Modulation	Emission Designator
20	QPSK	17M90G7D
	16QAM	17M80W7D
	64QAM	17M76W7D
	256QAM	17M88W7D
20+20	QPSK	37M81G7D
	16QAM	37M70W7D
	64QAM	37M68W7D
	256QAM	37M72W7D
20+20+20	QPSK	57M35G7D
	16QAM	57M38W7D
	64QAM	57M67W7D
	256QAM	57M45W7D

2.3. Description of Available Antennas

Band Support	Antenna Type	Model	Antenna Gain (dBi)	Directional Gain (dBi)	
				2*2 MIMO	4*4 MIMO
n41 Band & LTE Band 41	Omni Internal Antenna	06814	6	9.01	12.02

Note 1: This device supports both 2*2 Tx and 4*4 Tx modes of operation, configured by SW. When operating in 2*2 Tx mode, only Ant 0 & 1 ports are actively transmitting.

Note 2: The directional gain = $G_{ANT} + 10 \log (N_{ANT}/N_{SS})$ dBi, where N_{SS} = the number of independent spatial streams of data and G_{ANT} is the antenna gain in dBi.

2.4. Test Mode

Test Item	Channel Bandwidth	Modulation
Equivalent Isotropically Radiated Power	20MHz, 20+20MHz, 20+20+20MHz	QPSK, 16QAM, 64QAM, 256QAM
Emission Bandwidth	20MHz, 20+20MHz, 20+20+20MHz	QPSK, 16QAM, 64QAM, 256QAM
Band Edge Measurements	20MHz, 20+20MHz, 20+20+20MHz	QPSK, 16QAM, 64QAM, 256QAM
Conducted Spurious Emissions	20MHz, 20+20MHz, 20+20+20MHz	QPSK
Radiated Spurious Emissions	20MHz, 20+20MHz, 20+20+20MHz	QPSK, 16QAM, 64QAM, 256QAM
Peak to Average Ratio	20MHz, 20+20MHz, 20+20+20MHz	QPSK, 16QAM, 64QAM, 256QAM
Frequency Stability	20+20+20	QPSK

2.5. EMI Suppression Device(s)/Modifications

No EMI suppression device(s) were added and/or no modifications were made during testing.

2.6. Labeling Requirements

Per 2.1074 & 15.19; Docket 95-19

The label shall be permanently affixed at a conspicuous location on the device; instruction manual or pamphlet supplied to the user and be readily visible to the purchaser at the time of purchase.

However, when the device is so small wherein placement of the label with specified statement is not practical, only the FCC ID must be displayed on the device per Section 15.19(a)(5). Please see attachment for FCC ID label and label location.

3. DESCRIPTION of TEST

3.1. Evaluation Procedure

The measurement procedures described in the American National Standard for Compliance Testing of Transmitters Used in Licensed Radio Services (ANSI C63.26-2015), and the guidance provided in KDB 971168 D01v03r01 were used in the measurement.

Deviation from measurement procedure.....None

3.2. Radiated Emissions

The radiated test facilities consisted of an indoor 3 meter semi-anechoic chamber used for final measurements and exploratory measurements, when necessary. The measurement area is contained within the semi-anechoic chamber which is shielded from any ambient interference. For measurements above 1GHz absorbers are arranged on the floor between the turn table and the antenna mast in such a way so as to maximize the reduction of reflections. For measurements below 1GHz, the absorbers are removed. A turntable is used for radiated measurement. It is a continuously rotatable, remote controlled, metallic turntable and 2 meters (6.56 ft.) in diameter. The turn table is flush with the raised floor of the chamber in order to maintain its function as a ground plane. An 80cm high PVC support structure is placed on top of the turntable.

For all measurements, the spectrum was scanned through all EUT azimuths and from 1 to 4 meter receive antenna height using a broadband antenna from 30MHz up to the upper frequency shown in 15.33(b)(1) depending on the highest frequency generated or used in the device or on which the device operates or tunes. For frequencies above 1GHz, linearly polarized double ridge horn antennas were used. For frequencies below 30MHz, a calibrated loop antenna was used. When exploratory measurements were necessary, they were performed at 1 meter test distance inside the semi-anechoic chamber using broadband antennas, broadband amplifiers, and spectrum analyzers to determine the frequencies and modes producing the maximum emissions. Sufficient time for the EUT, support equipment, and test equipment was allowed in order for them to warm up to their normal operating condition. The test set-up for frequencies below 1GHz was placed on top of the 0.8 meter high, 1 x 1.5 meter table; and test set-up for frequencies 1-40GHz was placed on top of the 1.5 meter high, 1 x 1.5 meter table. The EUT, support equipment, and interconnecting cables were arranged and manipulated to maximize each emission. Appropriate precaution was taken to ensure that all emissions from the EUT were maximized and investigated. The system configuration, clock speed, mode of operation or video resolution, if applicable, turntable azimuth, and receive antenna height was noted for each frequency found.

Final measurements were made in the semi-anechoic chamber using calibrated, linearly polarized broadband and horn antennas. The test setup was configured to the setup that produced the worst case emissions. The spectrum analyzer was set to investigate all frequencies required for testing to compare the highest radiated disturbances with respect to the specified limits. The turntable

containing the EUT was rotated through 360 degrees and the height of the receive antenna was varied 1 to 4 meters and stopped at the azimuth and height producing the maximum emission. Each emission was maximized by changing the orientation of the EUT through three orthogonal planes and changing the polarity of the receive antenna, which produced the worst-case emissions. According to 3dB Beam-Width of horn antenna, the horn antenna should be always directed to the EUT when rising height.

4. TEST EQUIPMENT CALIBRATION DATE

Radiated Emissions

Instrument	Manufacturer	Type No.	Asset No.	Cali. Interval	Cali. Due Date
Active Loop Antenna	SCHWARZBECK	FMZB 1519B	MRTTWA00002	1 year	2021/04/27
Broadband TRILOG Antenna	SCHWARZBECK	VULB 9162	MRTTWA00001	1 year	2020/06/04
Broadband Hornantenna	SCHWARZBECK	BBHA 9120D	MRTTWA00003	1 year	2021/04/24
Breitband Hornantenna	SCHWARZBECK	BBHA 9170	MRTTWA00004	1 year	2021/04/24
Broadband Preamplifier	SCHWARZBECK	BBV 9718	MRTTWA00005	1 year	2021/04/24
Broadband Amplifier	SCHWARZBECK	BBV 9721	MRTTWA00006	1 year	2021/04/24
Signal Analyzer	R&S	FSV40	MRTTWA00007	1 year	2021/03/24
EMI Test Receiver	R&S	ESR3	MRTTWA00009	1 year	2021/03/25
EXA Signal Analyzer	KEYSIGHT	N9010A	MRTTWA00012	1 year	2020/10/02
EXA Signal Analyzer	KEYSIGHT	N9010B	MRTTWA00074	1 year	2020/07/11
Antenna Cable	HUBERSUHNER	SF106	MRTTWE00010	1 year	2021/06/16
Temperature/Humidity Meter	TFA	35.1078.10.IT	MRTTWA00032	1 year	2021/05/30
Cable	Rosnol	K1K50-UP026 4-K1K50-4M	MRTTWE00012	1 year	2021/06/21

Conducted Test Equipment

Instrument	Manufacturer	Type No.	Asset No.	Cali. Interval	Cali. Due Date
X-Series USB Peak and Average Power Sensor	KEYSIGHT	U2021XA	MRTTWA00014	1 year	2021/04/24
X-Series USB Peak and Average Power Sensor	KEYSIGHT	U2021XA	MRTTWA00015	1 year	2021/03/26
Wideband Radio Communication Taster	R&S	CMW 500	MRTTWA00041	1 year	2021/01/07
EXA Signal Analyzer	KEYSIGHT	N9010A	MRTTWA00012	1 year	2020/10/02
EXA Signal Analyzer	KEYSIGHT	N9010B	MRTTWA00074	1 year	2020/07/11
Signal Analyzer	R&S	FSV40	MRTTWA00007	1 year	2021/03/24
DC Power Supply	GWINSTEK	SPS-606	MRTTWA00034	Check by TRUE RMS MULTIMETER	
TRUE RMS MULTIMETER	FLUKE	117	MRTTWA00022	1 year	2020/05/29
Temperature & Humidity Chamber	TEN BILLION	TTH-B3UP	MRTTWA00036	1 year	2020/06/10
Temperature/Humidity Meter	TFA	35.1078.10.IT	MRTTWA00033	1 year	2020/05/30

Software	Version	Function
EMI Software	V3	EMI Test Software

5. MEASUREMENT UNCERTAINTY

Where relevant, the following test uncertainty levels have been estimated for tests performed on the EUT as specified in CISPR 16-4-2. This uncertainty represents an expanded uncertainty expressed at approximately the 95% confidence level using a coverage factor of $k = 2$.

Conducted Measurement
Measuring Uncertainty for a Level of Confidence of 95% ($U=2Uc(y)$): 2.53dB
Radiated Emission Measurement
Measuring Uncertainty for a Level of Confidence of 95% ($U=2Uc(y)$): 9kHz ~ 30MHz: 3.92dB 30MHz ~ 1GHz: 4.25dB 1GHz ~ 18GHz: 4.40dB

6. TEST RESULT

6.1. Summary

FCC Section(s)	Test Description	Test Limit	Test Condition	Test Result	Reference
2.1046; 27.50(h)	Equivalent Isotropically Radiated Power	Refer to Section 6.2	Conducted	Pass	Section 6.2
2.1055; 27.54	Frequency Stability	Refer to Section 6.3		Pass	Section 6.3
2.1049	Emission Bandwidth	Refer to Section 6.4		Pass	Section 6.4
2.1051; 27.53(m)	Band Edge Measurements	Refer to Section 6.5		Pass	Section 6.5
2.1046	Peak to Average Ratio	Refer to Section 6.6		Pass	Section 6.6
2.1051; 27.53(m)	Conducted Spurious Emissions	Refer to Section 6.7		Pass	Section 6.7
2.1053; 27.53(m)	Radiated Spurious Emissions	Refer to Section 6.8	Radiated	Pass	Section 6.8

Notes:

- 1) The analyzer plots shown in this section were all taken with a correction table loaded into the analyzer. The correction table was used to account for the losses of the cables and attenuators used as part of the system to connect the EUT to the analyzer at all frequencies of interest.
- 2) Pre-Scan has been conducted to determine the worst-case mode from all possible combinations between available modulations and antenna ports the worst case was found. Following model(s) was (were) selected for the final test as listed at section 2.4.
- 3) All supported modulation types were evaluated. The worst-case emission of modulation was selected. Therefore, the Frequency Stability, Conducted Spurious Emission were presented in the test report.

6.2. Equivalent Isotropically Radiated Power Measurement

6.2.1. Test Limit

According to the specific rule 27.50(h)(1), the following power limits shall apply in the BRS and EBS: Main, booster and base stations.(i) The maximum EIRP of a main, booster or base station shall not exceed $33 \text{ dBW} + 10\log(X/Y) \text{ dBW}$, where X is the actual channel width in MHz and Y is either 6 MHz if prior to transition or the station is in the MBS following transition or 5.5 MHz if the station is in the LBS and UBS following transition, except as provided in paragraph (h)(1)(ii) of this section.

60MHz Bandwidth: The EIRP limit = $33 + 30 + 10*\log (60/5.5) = 73.38\text{dBm}$

40MHz Bandwidth: The EIRP limit = $33 + 30 + 10*\log (40/5.5) = 71.62\text{dBm}$

20MHz Bandwidth: The EIRP limit = $33 + 30 + 10*\log (20/5.5) = 68.61\text{dBm}$

6.2.2. Test Procedures Used

KDB 971168 D01v03r01 - Section 5.2.4 & 5.6

ANSI C63.26-2015 - Section 5.2.4.2 & 5.2.5.5

6.2.3. Test Setting

Average power measurements were performed only when the EUT was transmitting at its maximum power control level using a broadband power meter with a pulse sensor. The power meter implemented triggering and gating capabilities which were set up such that power measurements were recorded only during the ON time of the transmitter.

The relevant equation for determining the maximum ERP or EIRP from the measured RF output power is given in Equation (1) as follows:

$$\text{ERP or EIRP} = P_{\text{Meas}} + G_{\text{T}}$$

where

ERP or EIRP effective radiated power or equivalent isotropically radiated power, respectively (expressed in the same units as P_{Meas} , e.g., dBm or dBW)

P_{Meas} measured transmitter output power or PSD, in dBm or dBW

G_{T} gain of the transmitting antenna, in dBd (ERP) or dBi (EIRP)

6.2.4. Test Setup

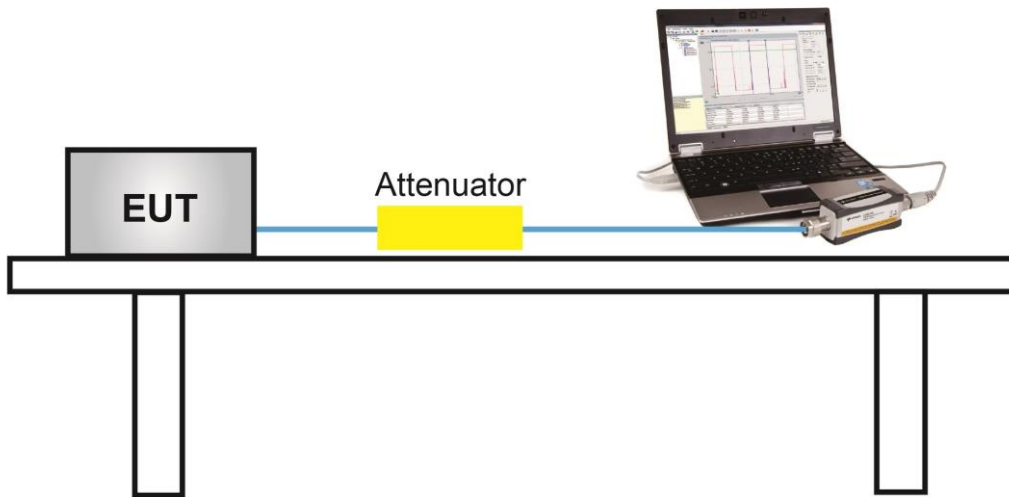

6.2.5. Test Result

Product	AirScale Indoor Radio ASiR 5G-pRRH	Test Engineer	Larry Yan
Test Site	SR2	Test Date	2020/05/13
Test Item	EIRP (2*2 Tx mode, 20MHz Bandwidth)		

Frequency (MHz)	Channel Bandwidth (MHz)	Ant 0 Power (dBm)	Ant 1 Power (dBm)	Total Power (dBm)	EIRP (dBm)	Limit (dBm)	Result
QPSK							
Bottom	20	23.71	24.24	26.99	36.00	≤ 68.61	Pass
Middle	20	24.11	24.02	27.08	36.09	≤ 68.61	Pass
Top	20	24.17	23.87	27.03	36.04	≤ 68.61	Pass
16QAM							
Bottom	20	23.87	24.40	27.15	36.16	≤ 68.61	Pass
Middle	20	24.10	23.75	26.94	35.95	≤ 68.61	Pass
Top	20	23.98	23.73	26.87	35.88	≤ 68.61	Pass
64QAM							
Bottom	20	23.74	24.18	26.98	35.99	≤ 68.61	Pass
Middle	20	24.09	23.85	26.98	35.99	≤ 68.61	Pass
Top	20	24.17	24.12	27.16	36.17	≤ 68.61	Pass
256QAM							
Bottom	20	23.83	24.14	27.00	36.01	≤ 68.61	Pass
Middle	20	23.80	23.95	26.89	35.90	≤ 68.61	Pass
Top	20	24.24	24.17	27.22	36.23	≤ 68.61	Pass

Note 1: Total Power (dBm) = $10 \cdot \log_{10} \{ 10^{[ANT\ 0\ Power\ (dBm) / 10]} + 10^{[ANT\ 1\ Power\ (dBm) / 10]} \}$ (dBm).

Note 2: EIRP (dBm) = Total Power (dBm) + Directional Gain (dBi).

Product	AirScale Indoor Radio ASiR 5G-pRRH	Test Engineer	Larry Yan
Test Site	SR2	Test Date	2020/05/13
Test Item	EIRP (4*4Tx mode, 20MHz Bandwidth)		

Frequency (MHz)	Channel Bandwidth (MHz)	Ant 0 Power (dBm)	Ant 1 Power (dBm)	Ant 2 Power (dBm)	Ant 3 Power (dBm)	Total Power (dBm)	EIRP (dBm)	Limit (dBm)	Result
QPSK									
Bottom	20	23.71	24.24	23.76	23.91	29.93	41.95	≤ 68.61	Pass
Middle	20	24.11	24.02	24.00	24.05	30.07	42.09	≤ 68.61	Pass
Top	20	24.17	23.87	24.08	23.91	30.03	42.05	≤ 68.61	Pass
16QAM									
Bottom	20	23.87	24.40	23.98	24.07	30.11	42.13	≤ 68.61	Pass
Middle	20	24.10	23.75	24.02	23.96	29.98	42.00	≤ 68.61	Pass
Top	20	23.98	23.73	23.71	23.73	29.81	41.83	≤ 68.61	Pass
64QAM									
Bottom	20	23.74	24.18	23.72	23.75	29.87	41.89	≤ 68.61	Pass
Middle	20	24.09	23.85	24.02	23.87	29.98	42.00	≤ 68.61	Pass
Top	20	24.17	24.12	24.07	24.02	30.12	42.14	≤ 68.61	Pass
256QAM									
Bottom	20	23.83	24.14	23.70	23.77	29.88	41.90	≤ 68.61	Pass
Middle	20	23.80	23.95	24.11	23.81	29.94	41.96	≤ 68.61	Pass
Top	20	24.24	24.17	24.09	23.82	30.10	42.12	≤ 68.61	Pass

Note 1: Total Power (dBm) = $10 \cdot \log_{10} \{ 10^{[ANT\ 0\ Power\ (dBm) / 10]} + 10^{[ANT\ 1\ Power\ (dBm) / 10]} + 10^{[ANT\ 2\ Power\ (dBm) / 10]} + 10^{[ANT\ 3\ Power\ (dBm) / 10]} \}$ (dBm).

Note 2: EIRP (dBm) = Total Power (dBm) + Directional Gain (dBi).

Product	AirScale Indoor Radio ASiR 5G-pRRH	Test Engineer	Larry Yan
Test Site	SR2	Test Date	2020/05/13
Test Item	EIRP (2*2 Tx mode, 20+20MHz Bandwidth)		

Frequency (MHz)	Channel Bandwidth (MHz)	Ant 0 Power (dBm)	Ant 1 Power (dBm)	Total Power (dBm)	EIRP (dBm)	Limit (dBm)	Result
QPSK							
Bottom	20+20	24.53	24.49	27.52	36.53	≤ 71.62	Pass
Middle	20+20	24.30	24.05	27.19	36.20	≤ 71.62	Pass
Top	20+20	24.07	24.11	27.10	36.11	≤ 71.62	Pass
16QAM							
Bottom	20+20	24.01	24.42	27.23	36.24	≤ 71.62	Pass
Middle	20+20	24.26	24.18	27.23	36.24	≤ 71.62	Pass
Top	20+20	24.13	24.14	27.15	36.16	≤ 71.62	Pass
64QAM							
Bottom	20+20	24.18	24.63	27.42	36.43	≤ 71.62	Pass
Middle	20+20	24.24	24.12	27.19	36.20	≤ 71.62	Pass
Top	20+20	24.21	24.05	27.14	36.15	≤ 71.62	Pass
256QAM							
Bottom	20+20	24.08	24.49	27.30	36.31	≤ 71.62	Pass
Middle	20+20	24.14	24.03	27.10	36.11	≤ 71.62	Pass
Top	20+20	24.20	24.11	27.17	36.18	≤ 71.62	Pass

Note 1: Total Power (dBm) = $10 \cdot \log_{10} \{ 10^{[\text{ANT 0 Power (dBm)} / 10]} + 10^{[\text{ANT 1 Power (dBm)} / 10]} \}$ (dBm).

Note 2: EIRP (dBm) = Total Power (dBm) + Directional Gain (dBi).

Product	AirScale Indoor Radio ASiR 5G-pRRH	Test Engineer	Larry Yan
Test Site	SR2	Test Date	2020/05/13
Test Item	EIRP (4*4 Tx mode, 20+20MHz Bandwidth)		

Frequency (MHz)	Channel Bandwidth (MHz)	Ant 0 Power (dBm)	Ant 1 Power (dBm)	Ant 2 Power (dBm)	Ant 3 Power (dBm)	Total Power (dBm)	EIRP (dBm)	Limit (dBm)	Result
QPSK									
Bottom	20+20	24.53	24.49	24.12	24.20	30.36	42.38	≤ 71.62	Pass
Middle	20+20	24.30	24.05	24.16	24.03	30.16	42.18	≤ 71.62	Pass
Top	20+20	24.07	24.11	24.27	24.30	30.21	42.23	≤ 71.62	Pass
16QAM									
Bottom	20+20	24.01	24.42	24.05	24.03	30.15	42.17	≤ 71.62	Pass
Middle	20+20	24.26	24.18	24.17	24.06	30.19	42.21	≤ 71.62	Pass
Top	20+20	24.13	24.14	24.02	24.01	30.10	42.12	≤ 71.62	Pass
64QAM									
Bottom	20+20	24.18	24.63	24.21	24.24	30.34	42.36	≤ 71.62	Pass
Middle	20+20	24.24	24.12	24.05	24.13	30.16	42.18	≤ 71.62	Pass
Top	20+20	24.21	24.05	24.22	24.10	30.17	42.19	≤ 71.62	Pass
256QAM									
Bottom	20+20	24.08	24.49	24.14	24.19	30.25	42.27	≤ 71.62	Pass
Middle	20+20	24.14	24.03	24.00	24.06	30.08	42.10	≤ 71.62	Pass
Top	20+20	24.20	24.11	24.02	24.07	30.12	42.14	≤ 71.62	Pass

Note 1: Total Power (dBm) = $10 \cdot \log_{10} \{ 10^{[ANT\ 0\ Power\ (dBm) / 10]} + 10^{[ANT\ 1\ Power\ (dBm) / 10]} + 10^{[ANT\ 2\ Power\ (dBm) / 10]} + 10^{[ANT\ 3\ Power\ (dBm) / 10]} \}$ (dBm).

Note 2: EIRP (dBm) = Total Power (dBm) + Directional Gain (dBi).

Product	AirScale Indoor Radio ASiR 5G-pRRH	Test Engineer	Larry Yan
Test Site	SR2	Test Date	2020/05/13
Test Item	EIRP (2*2 Tx mode, 20+20+20MHz Bandwidth)		

Frequency (MHz)	Channel Bandwidth (MHz)	Ant 0 Power (dBm)	Ant 1 Power (dBm)	Total Power (dBm)	EIRP (dBm)	Limit (dBm)	Result
QPSK							
Bottom	20+20+20	23.63	24.20	26.93	35.94	≤ 73.38	Pass
Middle	20+20+20	23.95	23.77	26.87	35.88	≤ 73.38	Pass
Top	20+20+20	23.79	24.12	26.97	35.98	≤ 73.38	Pass
16QAM							
Bottom	20+20+20	23.60	24.11	26.87	35.88	≤ 73.38	Pass
Middle	20+20+20	23.89	23.79	26.85	35.86	≤ 73.38	Pass
Top	20+20+20	24.01	23.95	26.99	36.00	≤ 73.38	Pass
64QAM							
Bottom	20+20+20	23.45	23.95	26.72	35.73	≤ 73.38	Pass
Middle	20+20+20	23.81	23.81	26.82	35.83	≤ 73.38	Pass
Top	20+20+20	24.00	24.00	27.01	36.02	≤ 73.38	Pass
256QAM							
Bottom	20+20+20	23.73	24.22	26.99	36.00	≤ 73.38	Pass
Middle	20+20+20	24.06	23.74	26.91	35.92	≤ 73.38	Pass
Top	20+20+20	23.96	23.98	26.98	35.99	≤ 73.38	Pass

Note 1: Total Power (dBm) = $10 \cdot \log \{ 10^{[\text{ANT 0 Power (dBm)} / 10]} + 10^{[\text{ANT 1 Power (dBm)} / 10]} \}$ (dBm).

Note 2: EIRP (dBm) = Total Power (dBm) + Directional Gain (dBi).

Product	AirScale Indoor Radio ASiR 5G-pRRH	Test Engineer	Larry Yan
Test Site	SR2	Test Date	2020/05/13
Test Item	EIRP (4*4 Tx mode, 20+20+20MHz Bandwidth)		

Frequency (MHz)	Channel Bandwidth (MHz)	Ant 0 Power (dBm)	Ant 1 Power (dBm)	Ant 2 Power (dBm)	Ant 3 Power (dBm)	Total Power (dBm)	EIRP (dBm)	Limit (dBm)	Result
QPSK									
Bottom	20+20+20	23.63	24.20	23.7	23.74	29.84	41.86	≤ 73.38	Pass
Middle	20+20+20	23.95	23.77	24.11	23.82	29.94	41.96	≤ 73.38	Pass
Top	20+20+20	23.79	24.12	23.78	23.71	29.87	41.89	≤ 73.38	Pass
16QAM									
Bottom	20+20+20	23.60	24.11	23.62	23.69	29.78	41.80	≤ 73.38	Pass
Middle	20+20+20	23.89	23.79	23.71	23.57	29.76	41.78	≤ 73.38	Pass
Top	20+20+20	24.01	23.95	23.82	23.67	29.89	41.91	≤ 73.38	Pass
64QAM									
Bottom	20+20+20	23.45	23.95	23.53	23.68	29.68	41.70	≤ 73.38	Pass
Middle	20+20+20	23.81	23.81	23.65	23.70	29.76	41.78	≤ 73.38	Pass
Top	20+20+20	24.00	24.00	23.95	23.65	29.92	41.94	≤ 73.38	Pass
256QAM									
Bottom	20+20+20	23.73	24.22	23.79	23.76	29.90	41.92	≤ 73.38	Pass
Middle	20+20+20	24.06	23.74	23.54	23.46	29.73	41.75	≤ 73.38	Pass
Top	20+20+20	23.96	23.98	23.68	23.62	29.83	41.85	≤ 73.38	Pass

Note 1: Total Power (dBm) = $10 \cdot \log_{10} \left\{ 10^{\frac{\text{ANT 0 Power (dBm)}}{10}} + 10^{\frac{\text{ANT 1 Power (dBm)}}{10}} + 10^{\frac{\text{ANT 2 Power (dBm)}}{10}} + 10^{\frac{\text{ANT 3 Power (dBm)}}{10}} \right\}$ (dBm).

Note 2: EIRP (dBm) = Total Power (dBm) + Directional Gain (dBi).

6.3. Frequency Stability Measurement

6.3.1. Test Limit

N/A

6.3.2. Test Procedures Used

KDB 971168 D01v03r01 - Section 9

ANSI C63.26-2015 - Section 5.6

6.3.3. Test Setting

Frequency Stability Under Temperature Variations:

The equipment under test was connected to an external AC or DC power supply and input rated voltage. RF output was connected to a frequency counter or spectrum analyzer via feed through attenuators. The EUT was placed inside the temperature chamber. Set the spectrum analyzer RBW low enough to obtain the desired frequency resolution and measure EUT 20°C operating frequency as reference frequency. Turn EUT off and set the chamber temperature to highest. After the temperature stabilized for approximately 30 minutes recorded the frequency. Repeat step measure with 10°C decreased per stage until the lowest temperature reached.

Frequency Stability Under Voltage Variations:

Set chamber temperature to 20°C. Use a variable AC power supply / DC power source to power the EUT and set the voltage to rated voltage. Set the spectrum analyzer RBW low enough to obtain the desired frequency resolution and recorded the frequency.

Reduce the input voltage to specify extreme voltage variation ($\pm 15\%$) and endpoint (If a product is specified to operate over a range of input voltage then the -15% variation is applied to the lowermost voltage and the $+15\%$ is applied to the uppermost voltage), record the maximum frequency change.

6.3.4. Test Setup

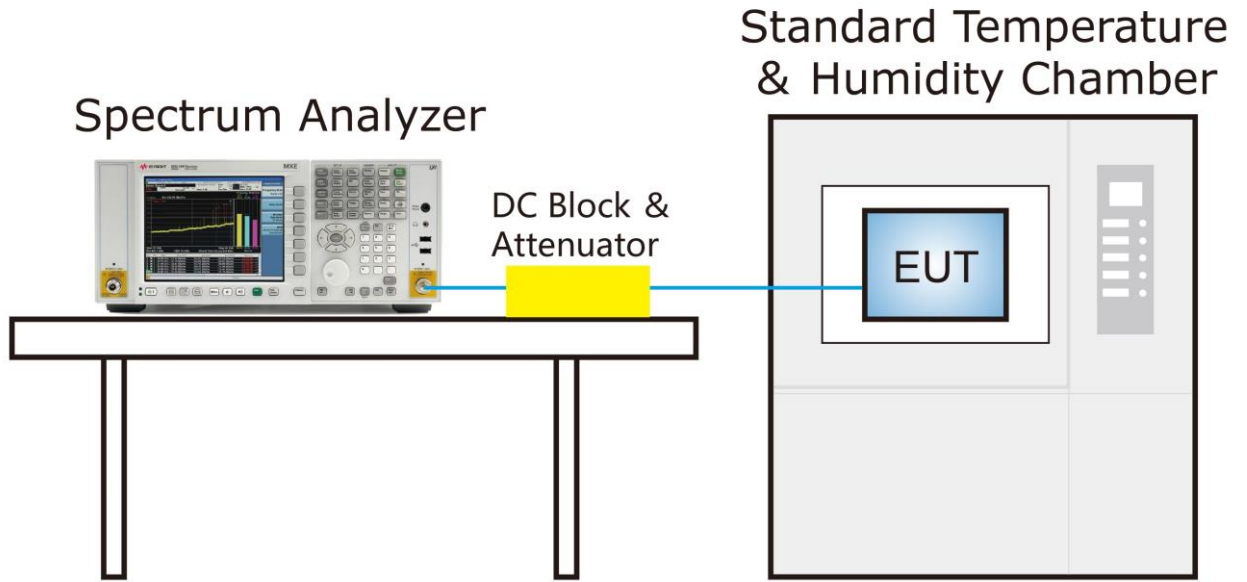

6.3.5. Test Result

Product	AirScale Indoor Radio ASiR 5G-pRRH	Test Engineer	Larry Yan
Test Site	SR2	Test Date	2020/05/13
Test Item	Frequency Stability, QPSK, 20+20+20MHz Bandwidth, Middle Channel		

Voltage (DC)	Temp (°C)	Frequency Tolerance (ppm)			
		0 minutes	2 minutes	5 minutes	10 minutes
54V	0	-0.14	-0.17	-0.18	-0.10
	+ 10	-0.14	+0.18	+0.17	-0.10
	+ 20 (Ref)	-0.18	-0.18	-0.18	-0.11
	+ 30	-0.18	+0.20	-0.19	-0.11
	+ 40	-0.18	+0.20	-0.14	-0.11
57V	+ 20	-0.17	+0.20	-0.16	-0.10
52V	+ 20	-0.16	+0.19	-0.17	-0.12

6.4. Emission Bandwidth

6.4.1. Test Limit

The emission bandwidth is defined as the width of the signal between two points, one below the carrier center frequency and one above the carrier center frequency, outside of which all emissions are attenuated at least 26 dB below the transmitter power.

6.4.2. Test Procedure

KDB 971168 D01v03r01 - Section 4.1 & 4.2

ANSI C63.26-2015 - Section 5.4.3 & 5.4.4

6.4.3. Test Setting

1. Set center frequency to the nominal EUT channel center frequency;
2. RBW = The nominal RBW shall be in the range of 1% to 5% of the anticipated OBW;
3. VBW $\geq 3 \times$ RBW;
4. Detector = Peak;
5. Trace mode = max hold;
6. Sweep = auto couple;
7. Allow the trace to stabilize;
8. The dynamic range of the spectrum analyzer at the selected RBW shall be more than 10 dB below the target “-X dB” requirement, i.e., if the requirement calls for measuring the -26 dB OBW, the spectrum analyzer noise floor at the selected RBW shall be at least 26 dB below the reference level

6.4.4. Test Setup

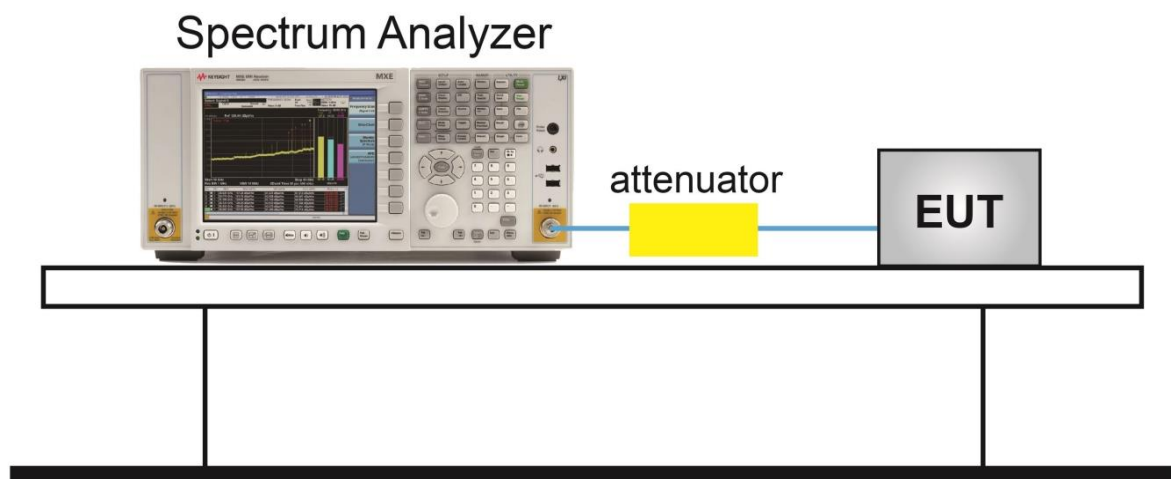

6.4.5. Test Result

Product	AirScale Indoor Radio ASiR 5G-pRRH	Test Engineer	Larry Yan
Test Site	SR2	Test Date	2020/05/14 ~ 2020/06/04
Test Item	Emission Bandwidth, 20MHz Bandwidth		

Modulation	Frequency (MHz)	Bandwidth (MHz)	26dB Bandwidth (MHz)	99% Bandwidth (MHz)
Ant 0 / Ant 0+1+2+3				
QPSK	Bottom	20	18.41	17.74
	Middle	20	18.40	17.90
	Top	20	18.37	17.76
16QAM	Bottom	20	18.21	17.56
	Middle	20	18.33	17.63
	Top	20	18.38	17.80
64QAM	Bottom	20	18.42	17.65
	Middle	20	18.42	17.76
	Top	20	18.53	17.73
256QAM	Bottom	20	18.18	17.65
	Middle	20	18.42	17.81
	Top	20	18.34	17.88

Emission Bandwidth - QPSK

Bottom Channel

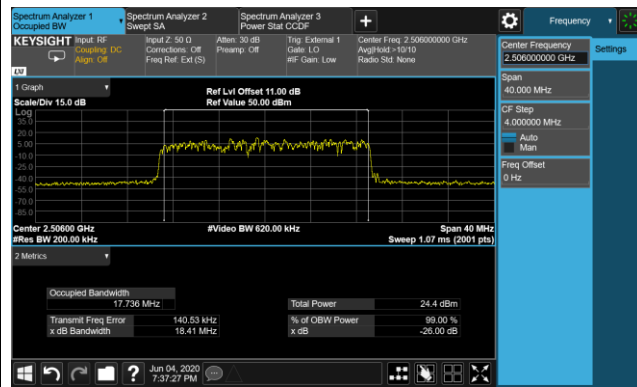

Middle Channel

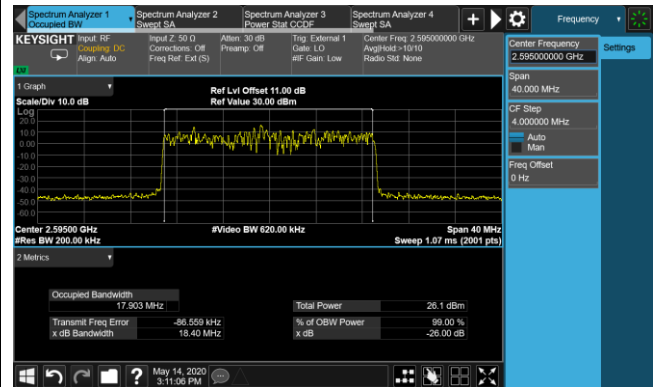

Top Channel

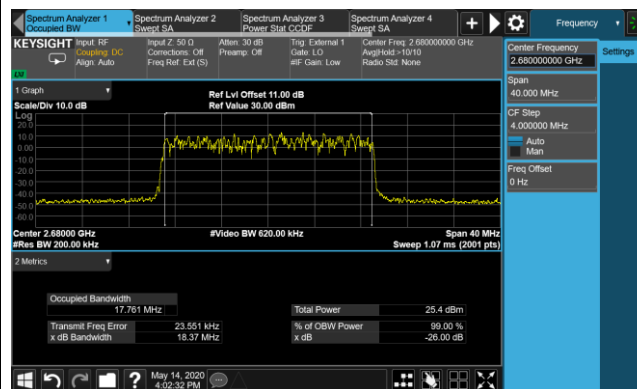

Emission Bandwidth - 16QAM

Bottom Channel

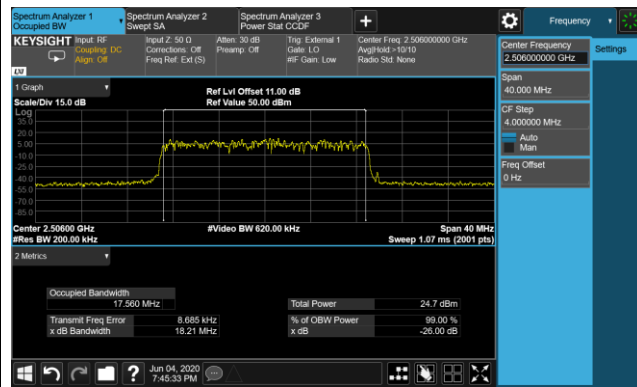

Middle Channel

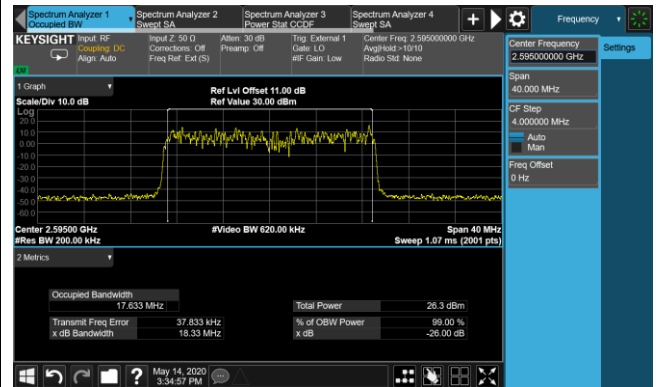

Top Channel

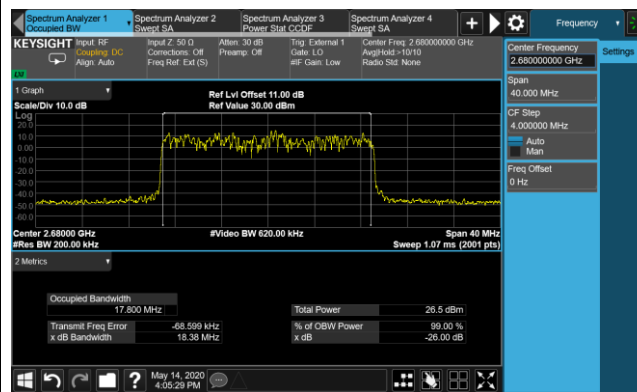

Emission Bandwidth - 64QAM

Bottom Channel

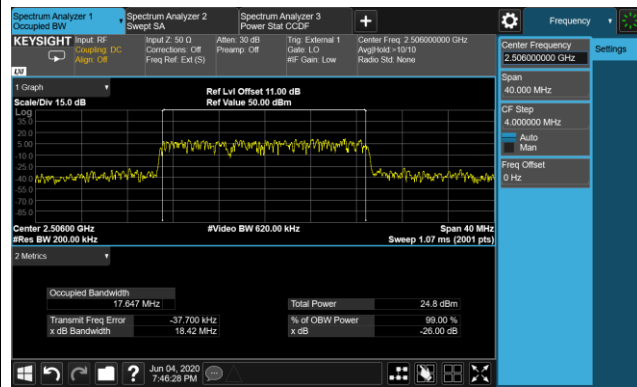

Middle Channel

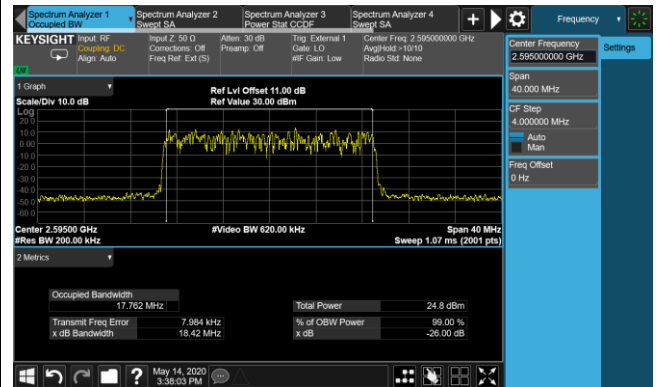

Top Channel

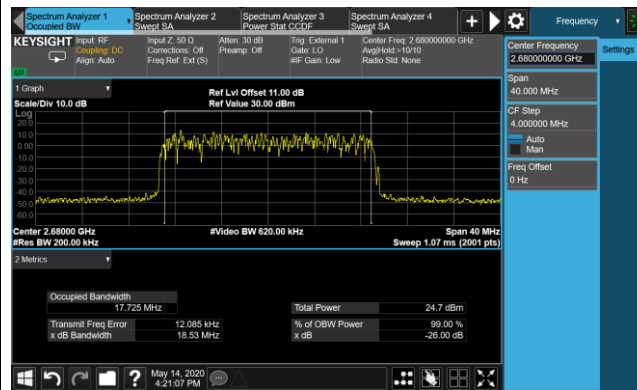

Emission Bandwidth - 256QAM

Bottom Channel

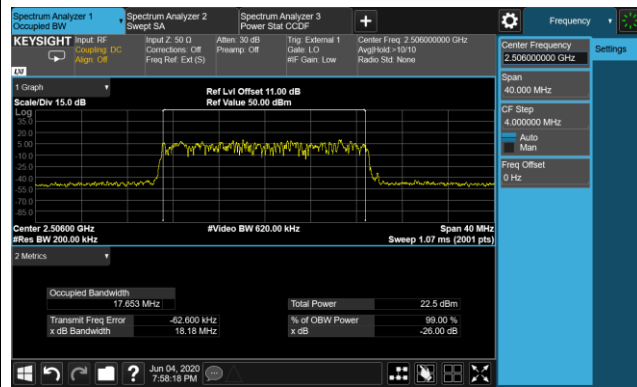

Middle Channel

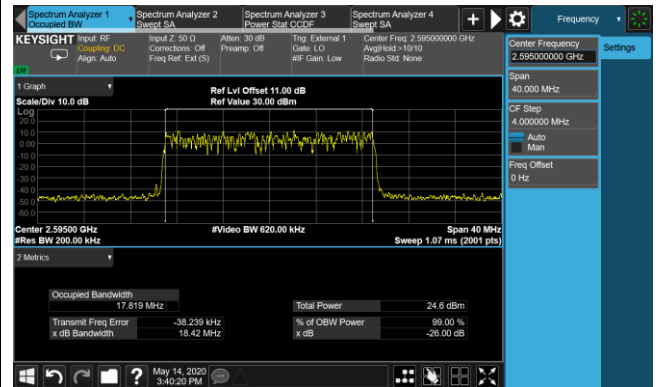

Top Channel

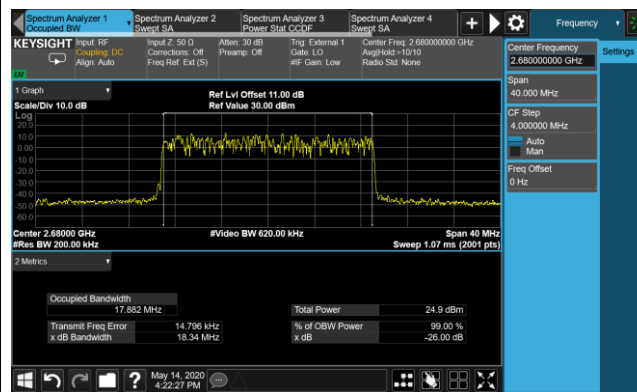

Product	AirScale Indoor Radio ASiR 5G-pRRH	Test Engineer	Larry Yan
Test Site	SR5	Test Date	2020/05/14 ~ 2020/06/04
Test Item	Emission Bandwidth, 20+20MHz Bandwidth		

Modulation	Frequency (MHz)	Bandwidth (MHz)	26dB Bandwidth (MHz)	99% Bandwidth (MHz)
Ant 0 / Ant 0+1+2+3				
QPSK	Bottom	20+20	38.88	37.81
	Middle	20+20	38.84	36.85
	Top	20+20	38.52	37.50
16QAM	Bottom	20+20	38.78	37.60
	Middle	20+20	38.91	37.42
	Top	20+20	38.88	37.34
64QAM	Bottom	20+20	38.74	37.59
	Middle	20+20	38.60	37.64
	Top	20+20	39.09	37.68
256QAM	Bottom	20+20	38.50	37.72
	Middle	20+20	38.67	37.56
	Top	20+20	38.82	37.51

Emission Bandwidth - QPSK

Bottom Channel

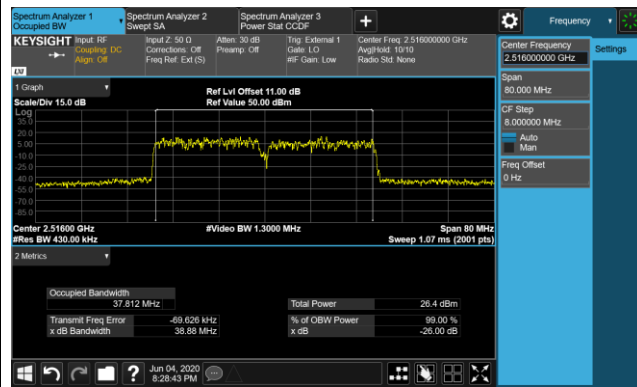

Middle Channel

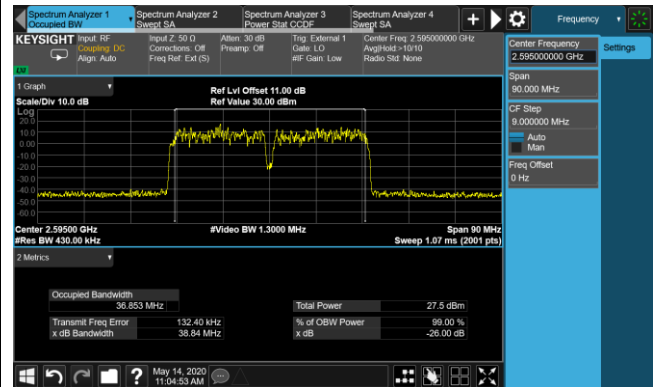

Top Channel

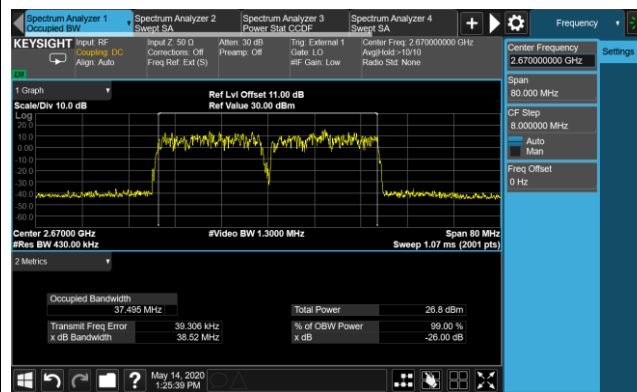

Emission Bandwidth - 16QAM

Bottom Channel

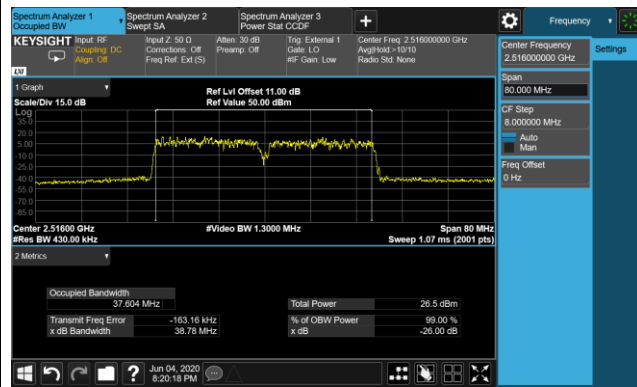

Middle Channel

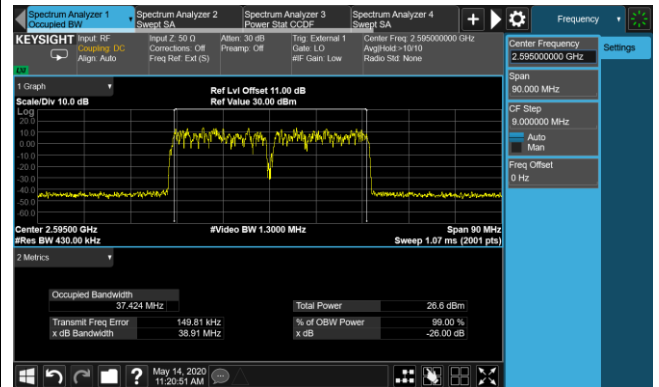

Top Channel

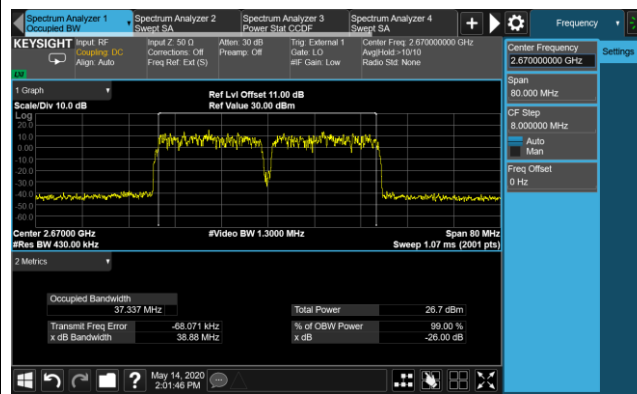

Emission Bandwidth - 64QAM

Bottom Channel

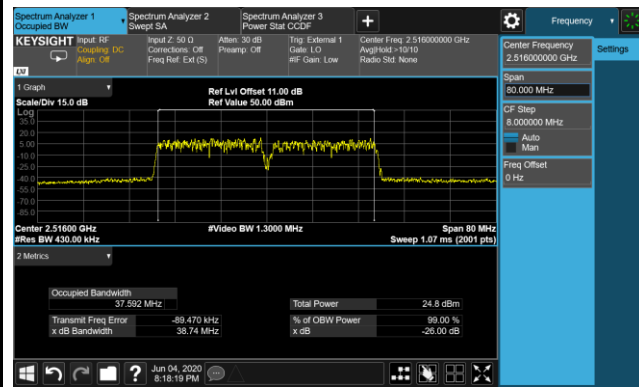

Middle Channel

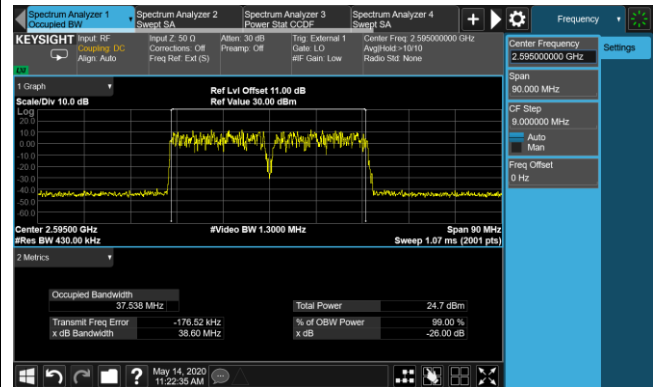

Top Channel



Emission Bandwidth - 256QAM

Bottom Channel

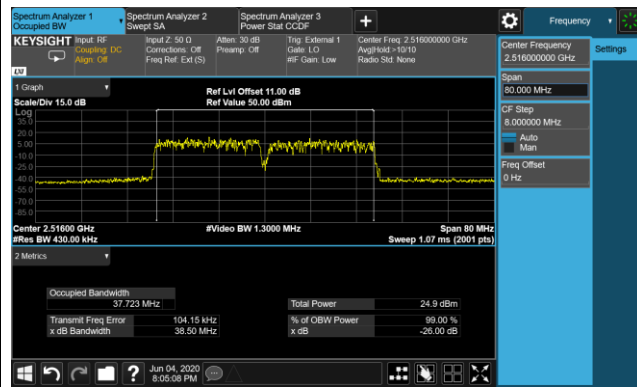

Middle Channel

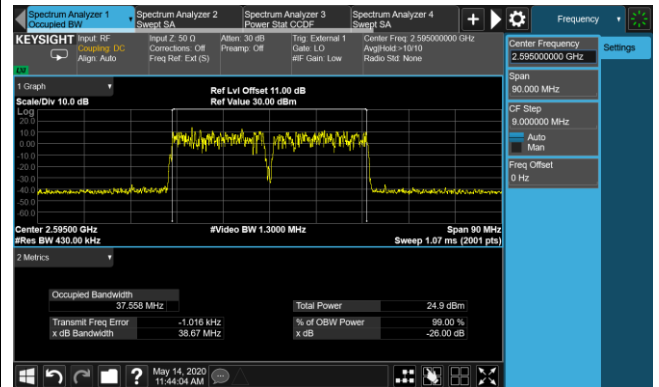

Top Channel

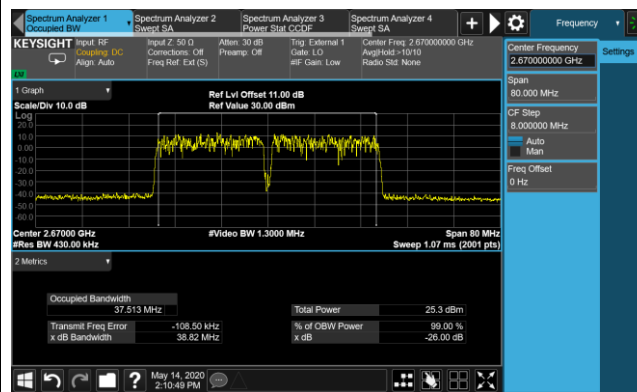

Product	AirScale Indoor Radio ASiR 5G-pRRH	Test Engineer	Larry Yan
Test Site	SR5	Test Date	2020/05/14 ~ 2020/06/04
Test Item	Emission Bandwidth, 20+20+20 MHz Bandwidth		

Modulation	Frequency (MHz)	Bandwidth (MHz)	26dB Bandwidth (MHz)	99% Bandwidth (MHz)
Ant 0 / Ant 0+1+2+3				
QPSK	Bottom	20+20+20	58.57	57.35
	Middle	20+20+20	58.85	57.20
	Top	20+20+20	58.86	57.25
16QAM	Bottom	20+20+20	58.71	57.34
	Middle	20+20+20	58.73	57.38
	Top	20+20+20	58.73	57.25
64QAM	Bottom	20+20+20	58.98	57.61
	Middle	20+20+20	58.70	57.43
	Top	20+20+20	59.04	57.67
256QAM	Bottom	20+20+20	58.79	57.29
	Middle	20+20+20	59.06	57.27
	Top	20+20+20	58.93	57.45

Emission Bandwidth - QPSK

Bottom Channel

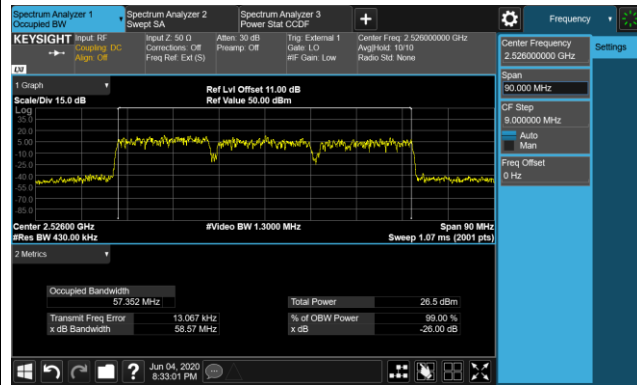

Middle Channel

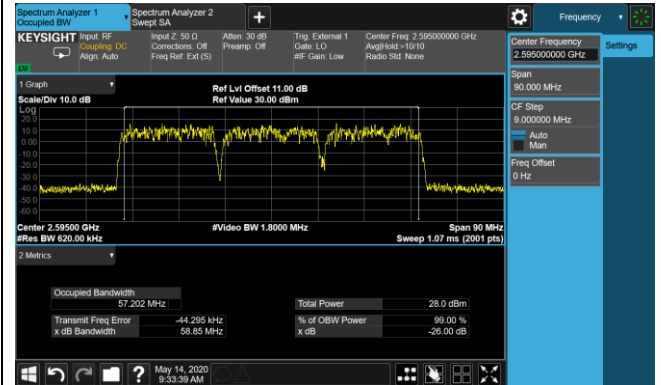

Top Channel

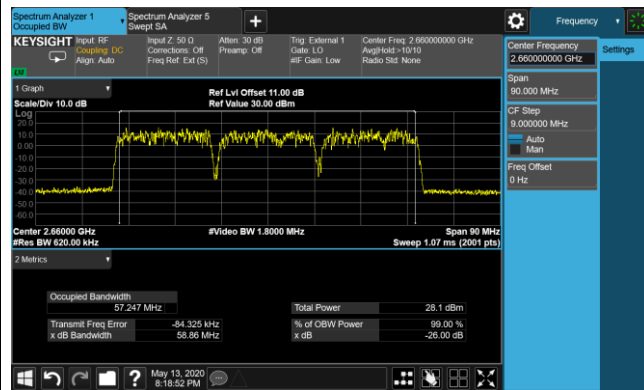

Emission Bandwidth - 16QAM

Bottom Channel

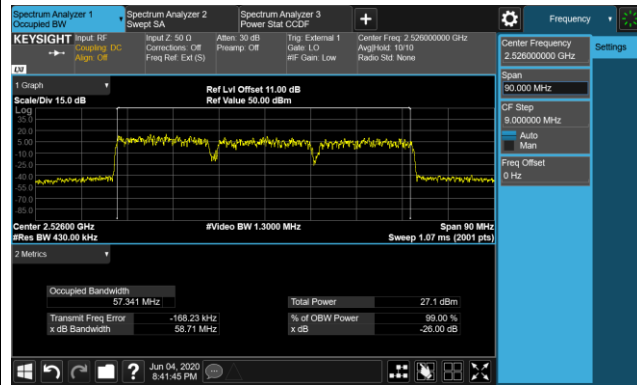

Middle Channel

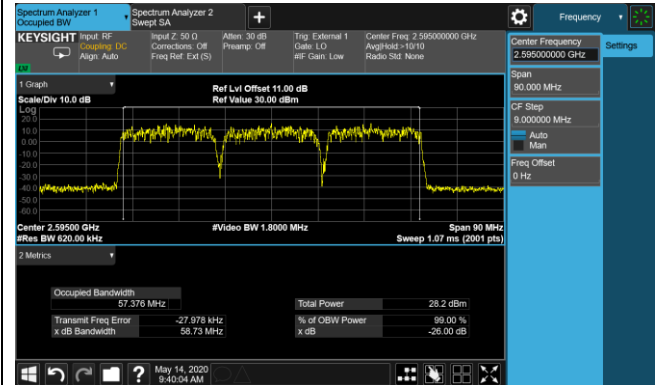

Top Channel

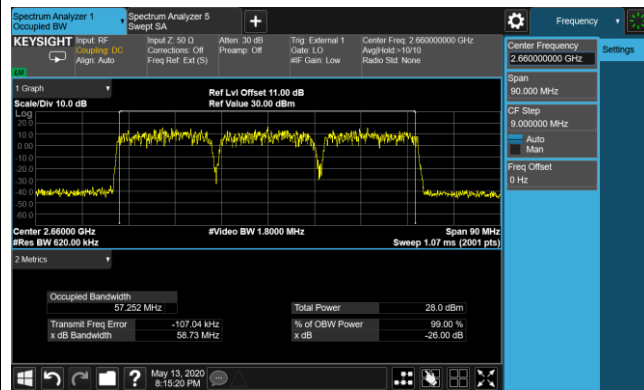

Emission Bandwidth - 64QAM

Bottom Channel

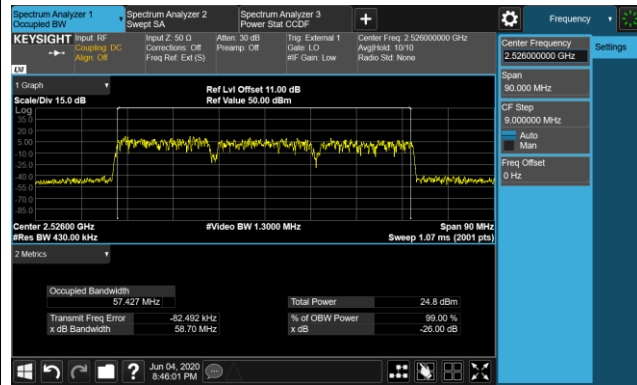

Middle Channel

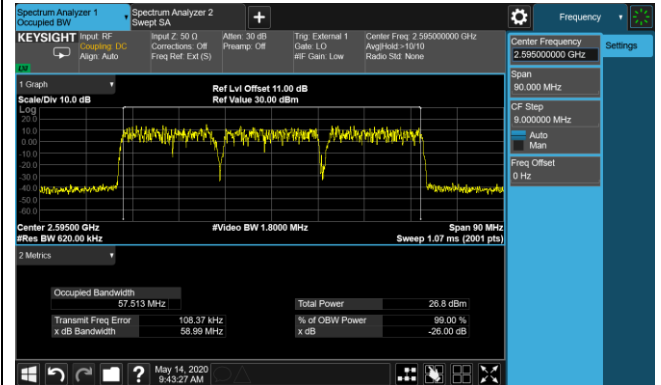

Top Channel

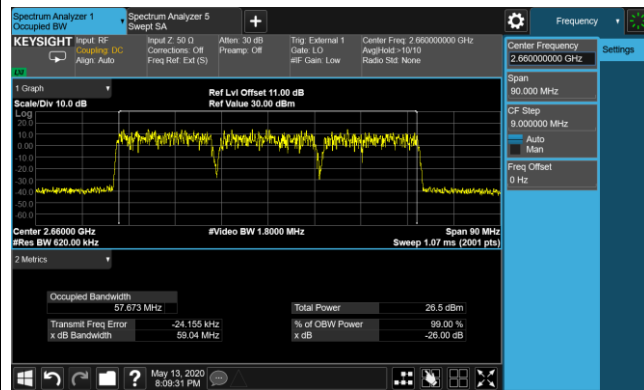

Emission Bandwidth - 256QAM

Bottom Channel

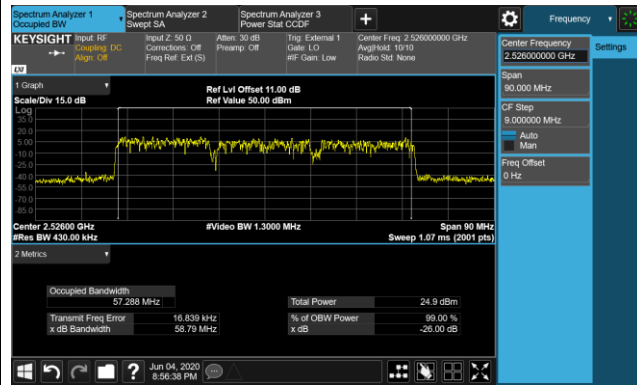

Middle Channel

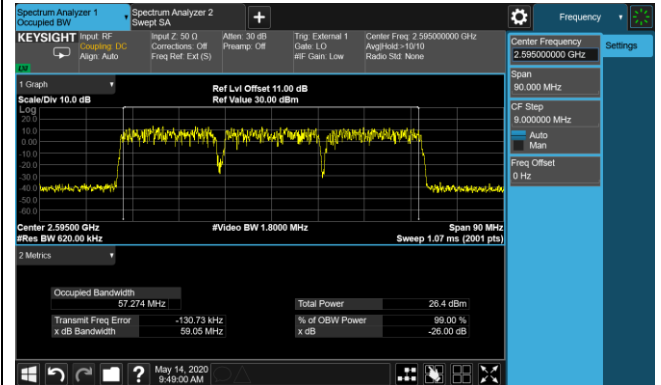

Top Channel

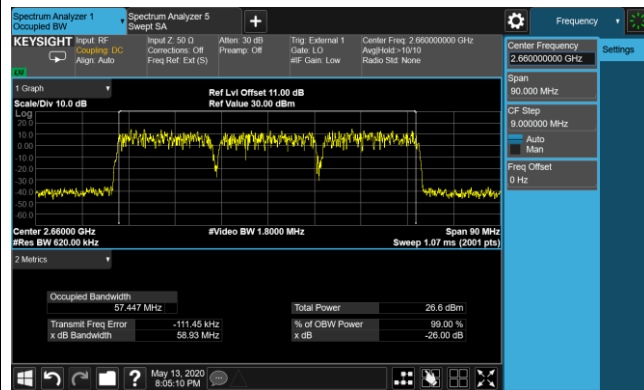

6.5. Band Edge Measurement

6.5.1. Test Limit

For all fixed digital user stations, the attenuation factor shall be not less than $43 + 10 \log (P)$ dB at the channel edge.

This device can be implement MIMO function, so the limit of spurious emissions needs to be reduced by $10 \cdot \log(\text{Numbers}_{\text{Ant}})$ according to FCC KDB 662911 D01 guidance.

The UUT can operate in either 2*2 or 4*4 MIMO mode. The 4X4 MIMO limit is applied in this test report and is adjusted to $-13 \text{ dBm} - 10 \cdot \log (4) = -19.02 \text{ dBm}$, since it is more stringent than the 2*2 MIMO limit.

6.5.2. Test Procedure Used

KDB 971168 D01v03r01 - Section 6.1

ANSI C63.26-2015 - Section 5.7.1

6.5.3. Test Setting

1. Set the analyzer frequency to low or high channel.
1. RBW = The nominal RBW shall be in the range of 1% to 5% of the anticipated OBW;
2. VBW $\geq 3 \cdot$ RBW
3. Sweep time = auto
4. Detector = power averaging (rms)
5. Set sweep trigger to "free run."
6. Trace average at least 100 traces in power averaging (rms) mode if sweep is set to auto-couple.

To accurately determine the average power over the on and off time of the transmitter, it can be necessary to increase the number of traces to be averaged above 100, or if using a manually configured sweep time, increase the sweep time.

6.5.4. Test Setup

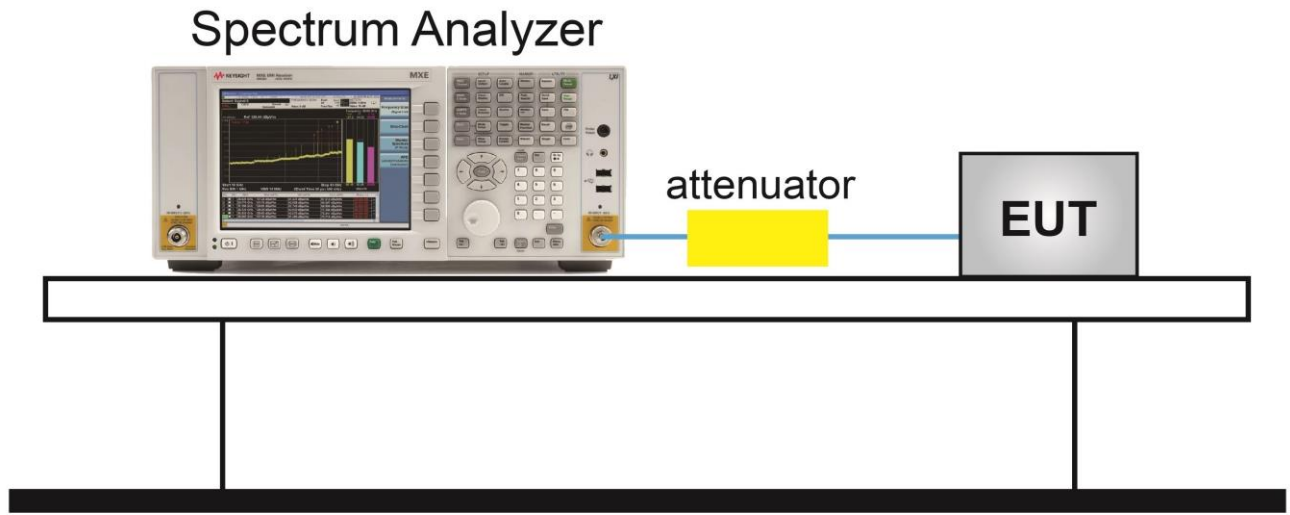

6.5.5. Test Result

Product	AirScale Indoor Radio ASiR 5G-pRRH	Test Engineer	Larry Yan
Test Site	SR2	Test Date	2020/05/14 ~ 2020/06/04
Test Item	Band Edge, 20MHz Bandwidth		

Frequency (MHz)	Channel Bandwidth (MHz)	Max Band Edge (dBm)				Limit (dBm)	Result
		Ant 0	Ant 1	Ant 2	Ant 3		
QPSK							
Bottom	20	-46.12	-43.46	-46.53	-46.62	≤ -19.02	Pass
Top	20	-44.82	-44.20	-44.69	-45.25	≤ -19.02	Pass
16QAM							
Bottom	20	-44.62	-45.41	-46.36	-46.55	≤ -19.02	Pass
Top	20	-45.95	-45.93	-45.71	-45.75	≤ -19.02	Pass
64QAM							
Bottom	20	-46.16	-45.89	-45.87	-46.60	≤ -19.02	Pass
Top	20	-45.27	-45.93	-45.61	-45.71	≤ -19.02	Pass
256QAM							
Bottom	20	-46.35	-45.69	-46.44	-46.18	≤ -19.02	Pass
Top	20	-45.46	-45.28	-45.06	-45.84	≤ -19.02	Pass

Band Edge - Ant 0 (QPSK)

Bottom Channel

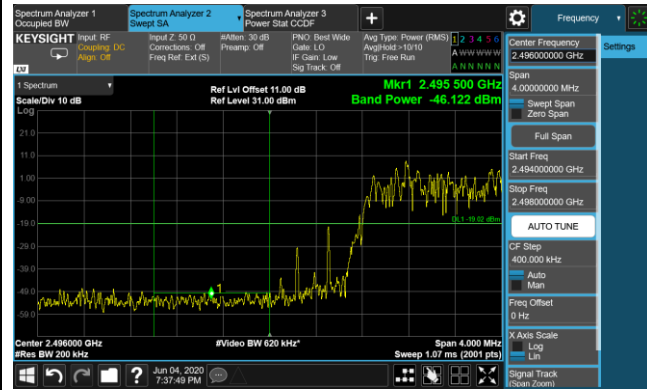

Top Channel

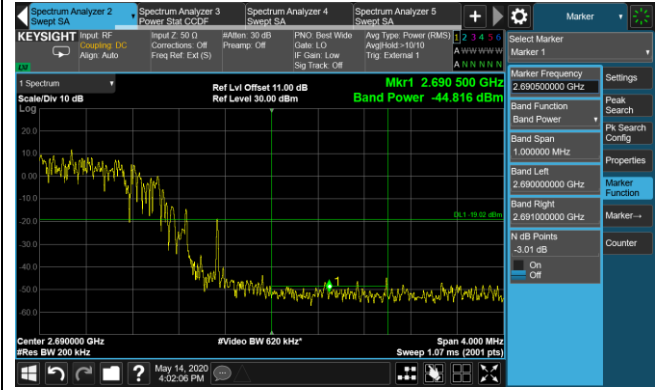

Band Edge - Ant 0 (16QAM)

Bottom Channel

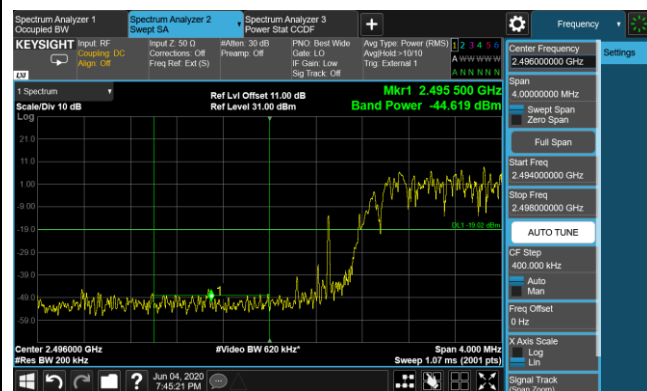

Top Channel

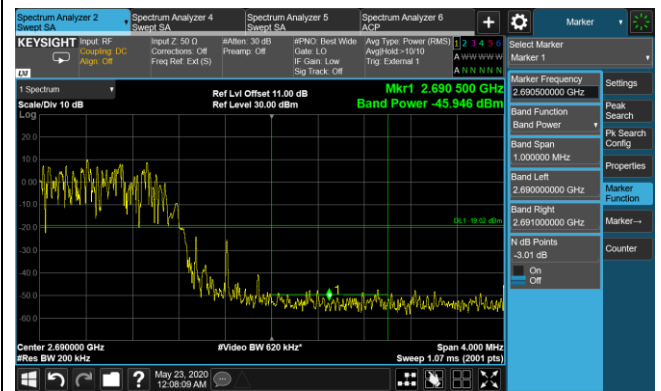

Band Edge - Ant 0 (64QAM)

Bottom Channel

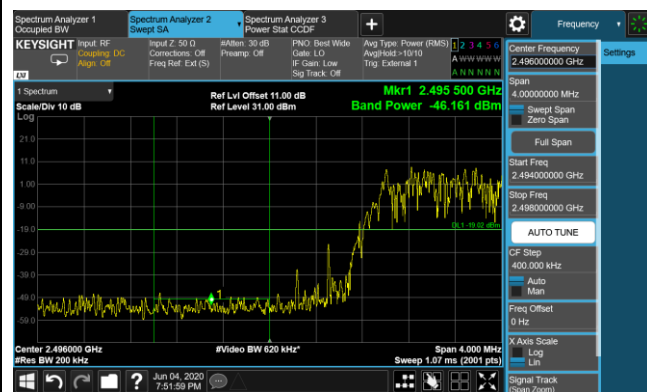

Top Channel



Band Edge - Ant 0 (256QAM)

Bottom Channel

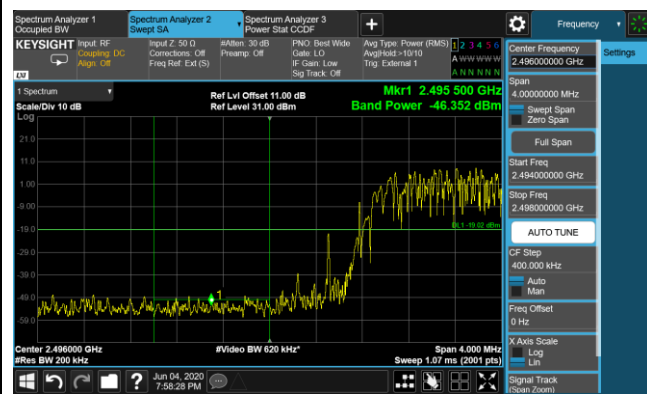

Top Channel

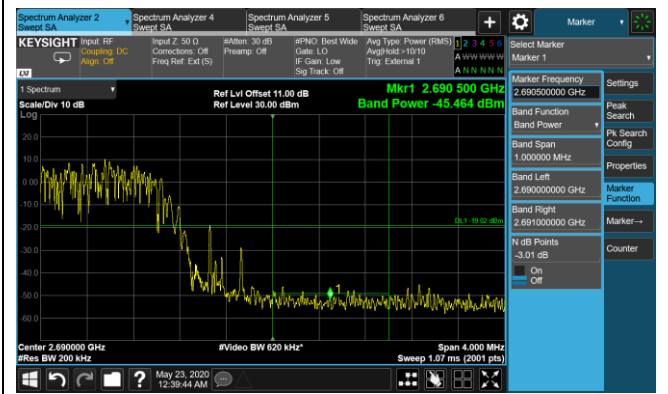

Band Edge - Ant 1 (QPSK)

Bottom Channel

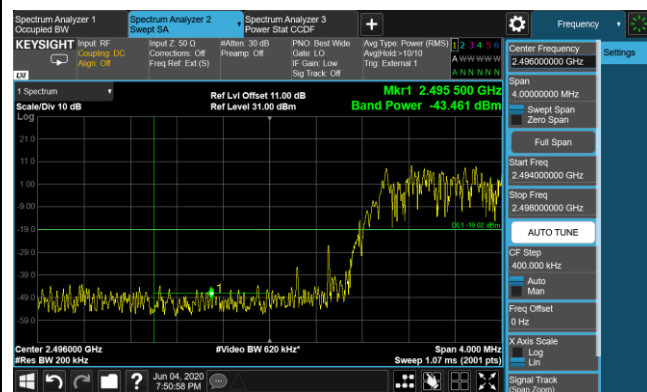

Top Channel

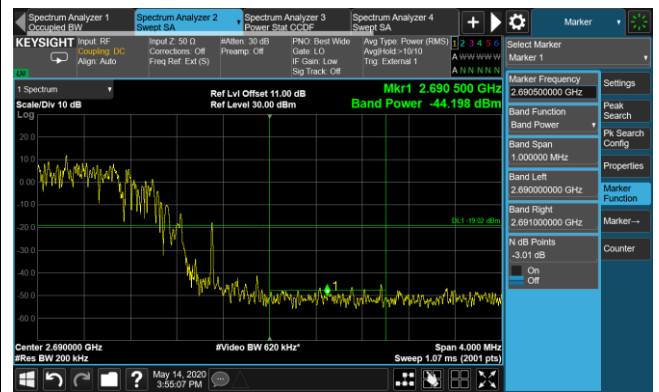

Band Edge - Ant 1 (16QAM)

Bottom Channel

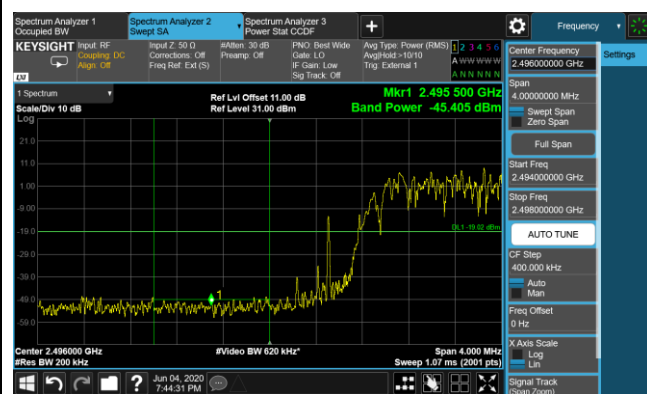

Top Channel

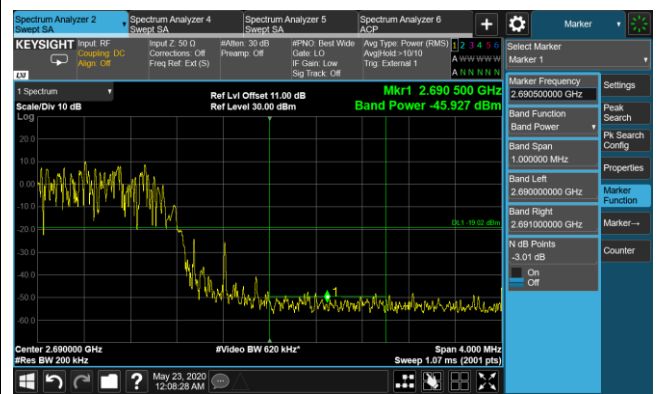

Band Edge - Ant 1 (64QAM)

Bottom Channel

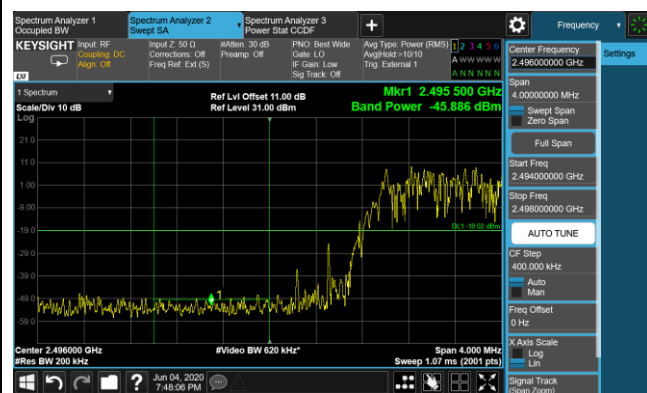

Top Channel



Band Edge - Ant 1 (256QAM)

Bottom Channel

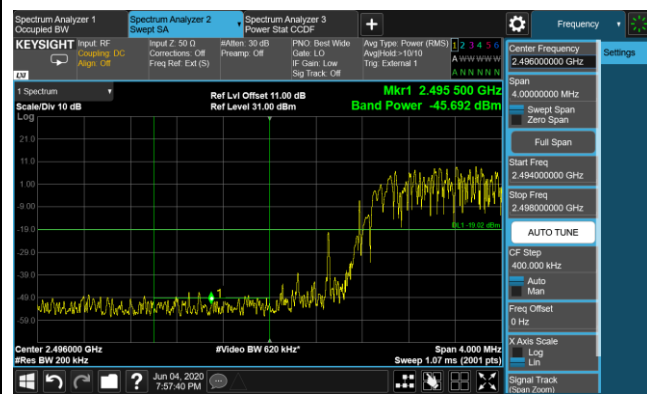

Top Channel

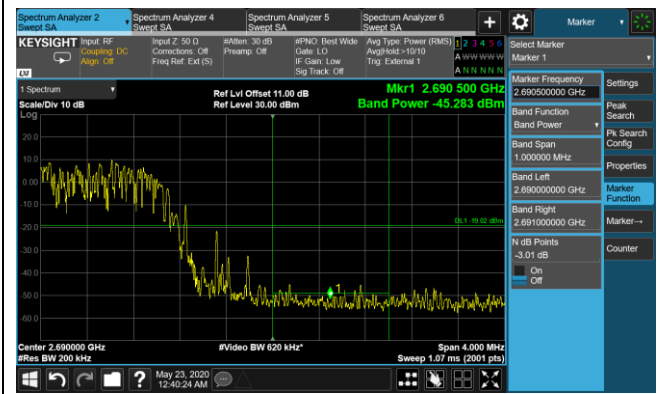

Band Edge - Ant 2 (QPSK)

Bottom Channel

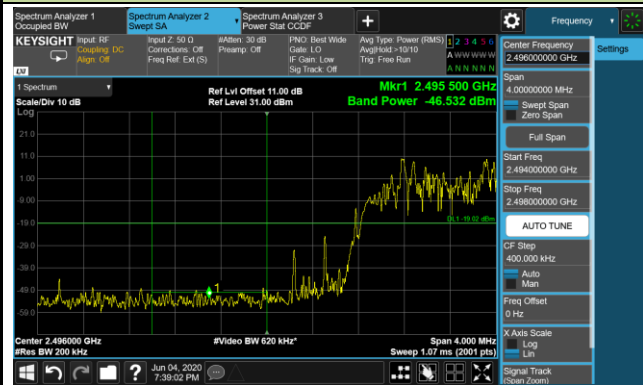

Top Channel



Band Edge - Ant 2 (16QAM)

Bottom Channel

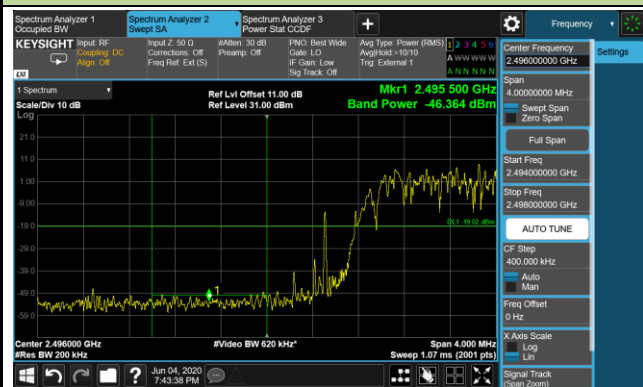

Top Channel

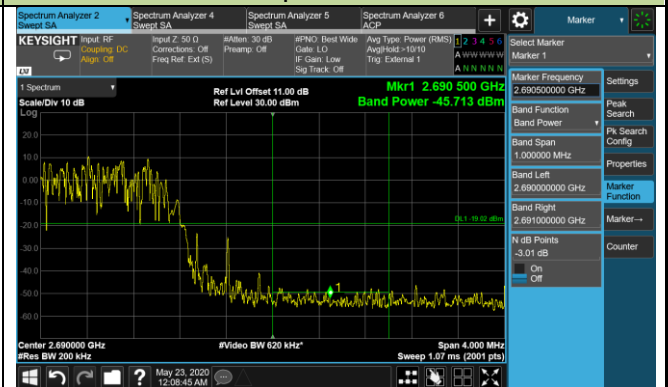

Band Edge - Ant 2 (64QAM)

Bottom Channel

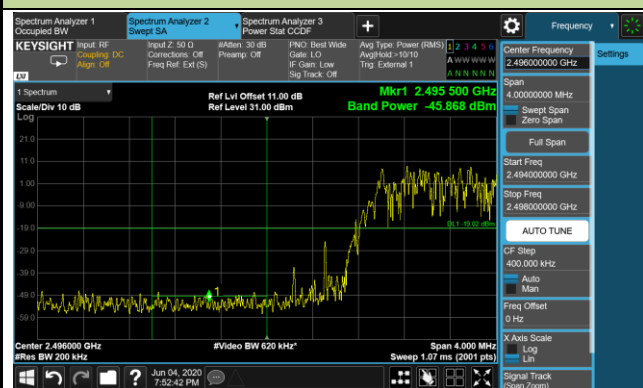

Top Channel

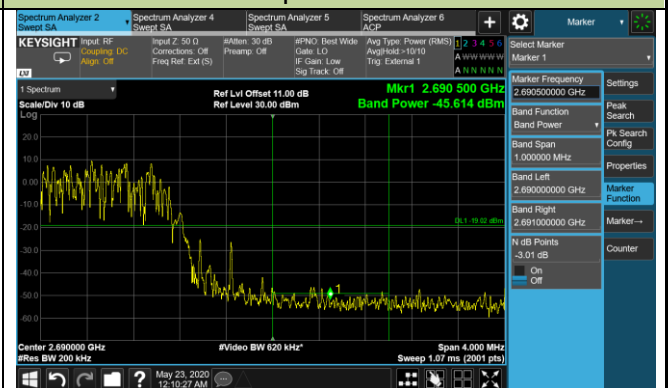

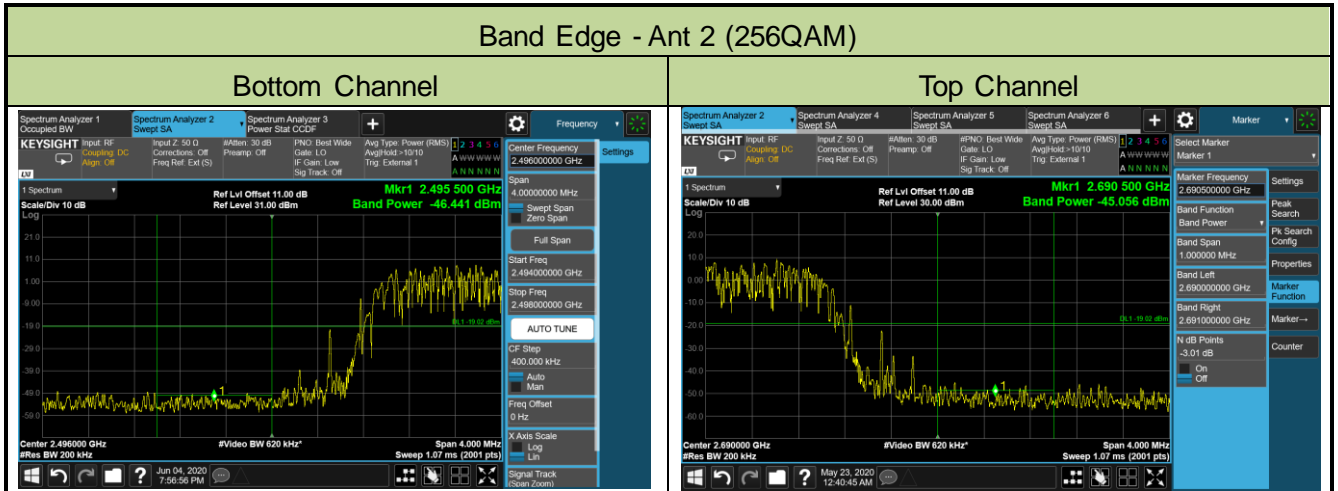

Band Edge - Ant 3 (QPSK)

Bottom Channel

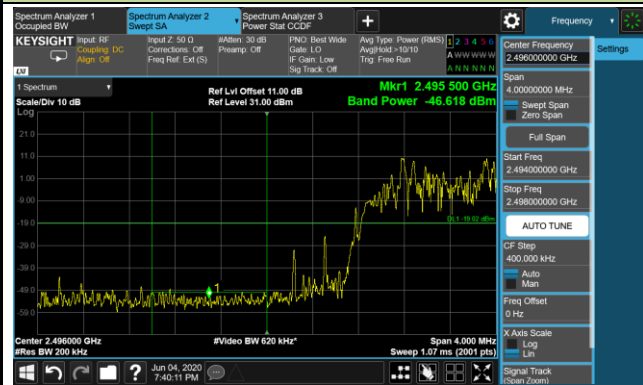

Top Channel



Band Edge - Ant 3 (16QAM)

Bottom Channel

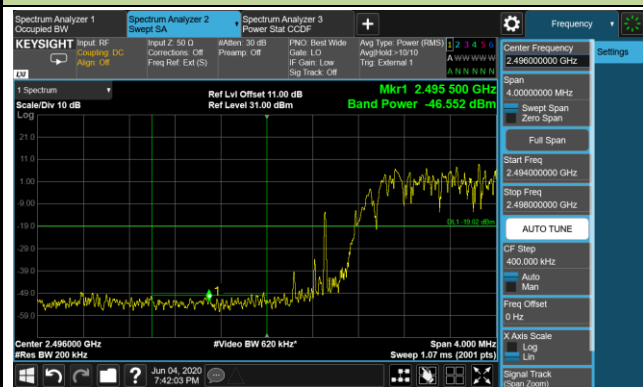

Top Channel



Band Edge - Ant 3 (64QAM)

Bottom Channel

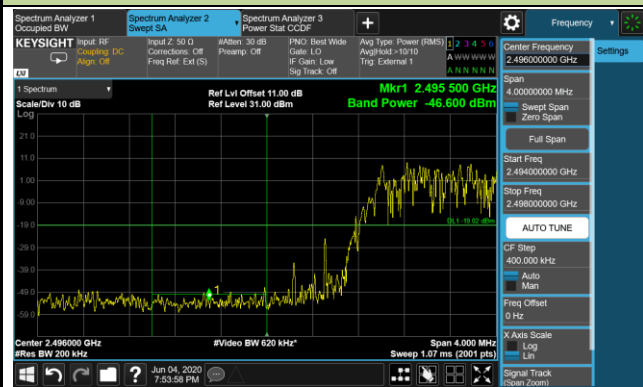

Top Channel

