

# MEASUREMENT REPORT

## FCC PART 24 Subpart E

---

**FCC ID:** 2AD8UAHFIH01

**Application:** Nokia Solutions and Networks, OY

**Application Type:** Certification

**Product:** AirScale Indoor Radio ASiR-pRRH

**Model No.:** AHFIH

**Brand Name:** Nokia

**FCC Rule Part(s):** Part 24 Subpart E

**Test Procedure(s):** ANSI C63.26-2015

**Test Date:** December 03, 2020 ~ February 04, 2021

Reviewed By:

*Paddy Chen*

( Paddy Chen )

Approved By:

*Chenz Ker*

(Chenz Ker)



Testing Laboratory  
3261

The test results relate only to the samples tested.

This equipment has been shown to be capable of compliance with the applicable technical standards as indicated in the measurement report and was tested in accordance with the measurement procedures specified in ANSI C63.26-2015. Test results reported herein relate only to the item(s) tested.

The test report shall not be reproduced except in full without the written approval of MRT Technology (Taiwan) Co., Ltd.

---

## Revision History

Report No.	Version	Description	Issue Date	Note
2006TW0003-U3	Rev. 01	Initial Report	12-05-2020	Invalid
2006TW0003-U3	Rev. 02	Updated with TCB's comment	02-06-2021	Valid

Note: This report is prepared for FCC Class II permissive supplement to MRT Original Report No. 2006TW0005-U1, to evaluate added Band 25 NB-IoT & an updated Duplexer component of the Band 25 circuit and spot check data.

---

## CONTENTS

Description	Page
<b>General Information.....</b>	<b>5</b>
<b>1. INTRODUCTION.....</b>	<b>6</b>
1.1. Scope.....	6
1.2. MRT Test Location .....	6
<b>2. PRODUCT INFORMATION.....</b>	<b>7</b>
2.1. Equipment Description .....	7
2.2. Description of Available Antennas .....	7
2.3. EMI Suppression Device(s)/Modifications.....	7
2.4. Labeling Requirements.....	7
<b>3. DESCRIPTION of TEST.....</b>	<b>8</b>
3.1. Evaluation Procedure .....	8
3.2. Radiated Emissions.....	8
<b>4. TEST EQUIPMENT CALIBRATION DATE.....</b>	<b>10</b>
<b>5. MEASUREMENT UNCERTAINTY .....</b>	<b>11</b>
<b>6. TEST RESULT .....</b>	<b>12</b>
6.1. Summary.....	12
6.2. Equivalent Isotropically Radiated Power Measurement .....	13
6.2.1. Test Limit .....	13
6.2.2. Test Procedures Used .....	13
6.2.3. Test Setting.....	13
6.2.4. Test Setup .....	13
6.2.5. Test Result.....	14
6.3. Frequency Stability Measurement .....	17
6.3.1. Test Limit .....	17
6.3.2. Test Procedures Used .....	17
6.3.3. Test Setting.....	17
6.3.4. Test Setup .....	18
6.3.5. Test Result.....	19
6.4. Emission Bandwidth .....	20
6.4.1. Test Limit .....	20
6.4.2. Test Procedure .....	20
6.4.3. Test Setting.....	20
6.4.4. Test Setup .....	21

---

6.4.5.	Test Result.....	22
6.5.	Band Edge Measurement.....	27
6.5.1.	Test Limit .....	27
6.5.2.	Test Procedure Used .....	27
6.5.3.	Test Setting.....	27
6.5.4.	Test Setup .....	28
6.5.5.	Test Result.....	29
<b>7.</b>	<b>CONCLUSION .....</b>	<b>36</b>

## General Information

<b>Applicant:</b>	Nokia Solutions and Networks, OY
<b>Applicant Address:</b>	2000 W. Lucent Lane, Naperville, Illinois, United States, 60563
<b>Manufacturer:</b>	Nokia Solutions and Networks, OY
<b>Manufacturer Address:</b>	2000 W. Lucent Lane, Naperville, Illinois, United States, 60563
<b>Test Site:</b>	MRT Technology (Taiwan) Co., Ltd
<b>Test Site Address:</b>	No. 38, Fuxing Second Rd., Guishan Dist., Taoyuan City 333, Taiwan (R.O.C)

### Test Facility / Accreditations

Measurements were performed at MRT Laboratory located in Fuxing Rd., Taoyuan, Taiwan ( R.O.C )

- MRT facility is a FCC registered (Reg. No. TW3261) test facility with the site description report on file and is designated by the FCC as an Accredited Test Film.
- MRT facility is an IC registered (MRT Reg. No. 21723-1) test laboratory with the site description on file at Industry Canada.
- MRT Lab is accredited to ISO 17025 by the American Association for Laboratory Accreditation (TAF) under the American Association for Laboratory Accreditation Program (TAF Cert. No. 3261) in EMC, Telecommunications and Radio testing for FCC, Industry Taiwan, EU and TELEC Rules.

## 1. INTRODUCTION

### 1.1. Scope

Measurement and determination of electromagnetic emissions (EMC) of radio frequency devices including intentional and/or unintentional radiators for compliance with the technical rules and regulations of the Federal Communications Commission and the Industry Canada Certification and Engineering Bureau.

### 1.2. MRT Test Location

The map below shows the location of the MRT LABORATORY, its proximity to the Taoyuan City. These measurement tests were conducted at the MRT Technology (Taiwan) Co., Ltd. Facility located at No.38, Fuxing 2nd Rd., Guishan Dist., Taoyuan City 33377, Taiwan (R.O.C).

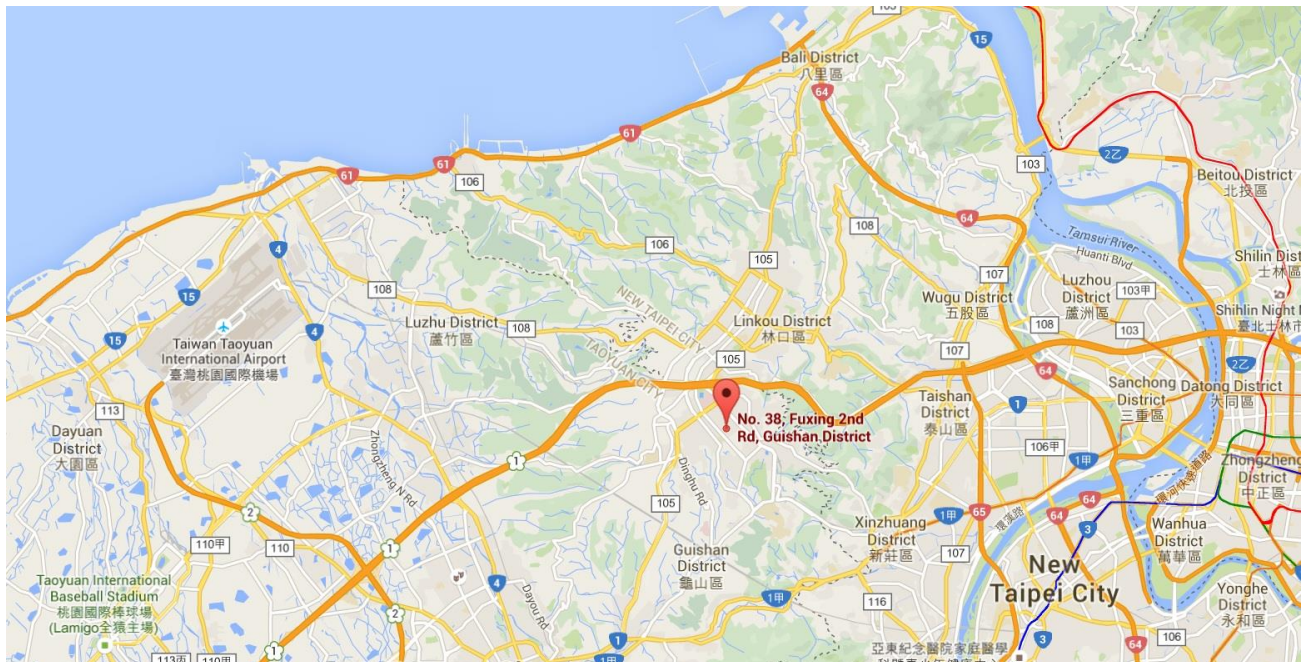

## 2. PRODUCT INFORMATION

### 2.1. Equipment Description

Product Name:	AirScale Indoor Radio ASiR-pRRH
Model No.:	AHFIH
Brand Name:	Nokia
Test Device Serial No.:	NH203500565
Hardware Version:	A103
Software Version:	FL18A
Voltage Range:	PoE: 52 ~ 57Vdc
NB-IoT Operating Band (s):	FDD Band 25
Sub Carrier Spacing:	15kHz
NB-IoT Operating Type:	Guard-band; In-band
Modulation Type:	QPSK
T <sub>x</sub> Frequency Range:	Band 25: 1930 ~ 1995 MHz
R <sub>x</sub> Frequency Range:	Band 25: 1850 ~ 1915 MHz
Antenna Specification:	Refer to Section 2.2

### 2.2. Description of Available Antennas

Band Support	Antenna Type	Model	Antenna Gain
LTE Band 25	Omni-Directional	CMQ69273P	5.7dBi

Note: The transmit signals are completely uncorrelated with each other, directional gain =  $G_{ANT}$  dBi,  $G_{ANT}$  is the antenna gain in dBi.

### 2.3. EMI Suppression Device(s)/Modifications

No EMI suppression device(s) were added and/or no modifications were made during testing.

### 2.4. Labeling Requirements

Per 2.1074 & 15.19; Docket 95-19

The label shall be permanently affixed at a conspicuous location on the device; instruction manual or pamphlet supplied to the user and be readily visible to the purchaser at the time of purchase.

However, when the device is so small wherein placement of the label with specified statement is not practical, only the FCC ID must be displayed on the device per Section 15.19(a)(5). Please see attachment for FCC ID label and label location.

### **3. DESCRIPTION of TEST**

#### **3.1. Evaluation Procedure**

The measurement procedure described in the document titled “American National Standard for Compliance Testing of Transmitters Used in Licensed Radio Services ” (ANSI C63.10-2013) was used in the measurement.

#### **3.2. Radiated Emissions**

The radiated test facilities consisted of an indoor 3 meter semi-anechoic chamber used for final measurements and exploratory measurements, when necessary. The measurement area is contained within the semi-anechoic chamber which is shielded from any ambient interference. For measurements above 1GHz absorbers are arranged on the floor between the turn table and the antenna mast in such a way so as to maximize the reduction of reflections. For measurements below 1GHz, the absorbers are removed. A turntable is used for radiated measurement. It is a continuously rotatable, remote controlled, metallic turntable and 2 meters (6.56 ft.) in diameter. The turn table is flush with the raised floor of the chamber in order to maintain its function as a ground plane. An 80cm high PVC support structure is placed on top of the turntable.

For all measurements, the spectrum was scanned through all EUT azimuths and from 1 to 4 meter receive antenna height using a broadband antenna from 30MHz up to the upper frequency shown in 15.33(b)(1) depending on the highest frequency generated or used in the device or on which the device operates or tunes. For frequencies above 1GHz, linearly polarized double ridge horn antennas were used. For frequencies below 30MHz, a calibrated loop antenna was used. When exploratory measurements were necessary, they were performed at 1 meter test distance inside the semi-anechoic chamber using broadband antennas, broadband amplifiers, and spectrum analyzers to determine the frequencies and modes producing the maximum emissions. Sufficient time for the EUT, support equipment, and test equipment was allowed in order for them to warm up to their normal operating condition. The test set-up for frequencies below 1GHz was placed on top of the 0.8 meter high, 1 x 1.5 meter table; and test set-up for frequencies 1-40GHz was placed on top of the 1.5 meter high, 1 x 1.5 meter table. The EUT, support equipment, and interconnecting cables were arranged and manipulated to maximize each emission. Appropriate precaution was taken to ensure that all emissions from the EUT were maximized and investigated. The system configuration, clock speed, mode of operation or video resolution, if applicable, turntable azimuth, and receive antenna height was noted for each frequency found.

Final measurements were made in the semi-anechoic chamber using calibrated, linearly polarized broadband and horn antennas. The test setup was configured to the setup that produced the worst case emissions. The spectrum analyzer was set to investigate all frequencies required for testing to compare the highest radiated disturbances with respect to the specified limits. The turntable containing the EUT was rotated through 360 degrees and the height of the receive antenna was



varied 1 to 4 meters and stopped at the azimuth and height producing the maximum emission. Each emission was maximized by changing the orientation of the EUT through three orthogonal planes and changing the polarity of the receive antenna, which produced the worst-case emissions. According to 3dB Beam-Width of horn antenna, the horn antenna should be always directed to the EUT when rising height.

## 4. TEST EQUIPMENT CALIBRATION DATE

### Radiated Emissions

Instrument	Manufacturer	Type No.	Asset No.	Cali. Interval	Cali. Due Date
Active Loop Antenna	SCHWARZBECK	FMZB 1519	MRTSUE06025	1 year	2021/11/13
Bilog Period Antenna	SCHWARZBECK	VULB 9162	MRTSUE06022	1 year	2021/10/13
Broadband Hornantenna	SCHWARZBECK	BBHA 9120D	MRTSUE06023	1 year	2021/10/13
Breitband Hornantenna	SCHWARZBECK	BBHA 9170	MRTSUE06024	1 year	2021/12/29
Broadband Coaxial Preamplifier	SCHWARZBECK	BBV 9718	MRTSUE06176	1 year	2021/11/15
Preamplifier	SCHWARZBECK	BBV 9721	MRTSUE06121	1 year	2021/06/11
Signal Analyzer	R&S	FSV40	MRTSUE06218	1 year	2021/04/14
EMI Test Receiver	R&S	ESR3	MRTSUE06612	1 year	2021/07/31
EXA Signal Analyzer	KEYSIGHT	N9010B	MRTSUE06559	1 year	2021/08/08
EMC Cable	HUBERSUHNER	SF106	MRTSUE06594	1 year	2021/11/14
Temperature/Humidity Meter	TFA	35.1078.10.IT	MRTSUE06362	1 year	2021/03/29

### Conducted Test Equipment

Instrument	Manufacturer	Type No.	Asset No.	Cali. Interval	Cali. Due Date
X-Series USB Peak and Average Power Sensor	KEYSIGHT	U2021XA	MRTSUE06446	1 year	2021/06/30
X-Series USB Peak and Average Power Sensor	KEYSIGHT	U2021XA	MRTSUE06446	1 year	2021/06/30
Wideband Radio Communication Taster	R&S	CMW 500	MRTSUE06243	1 year	2021/11/17
EXA Signal Analyzer	KEYSIGHT	N9010B	MRTSUE06559	1 year	2021/08/08
Signal Analyzer	R&S	FSV40	MRTSUE06218	1 year	2021/04/14
DC Power Supply	GWINSTEK	SPS-606	MRTSUE06016	Check by TRUE RMS MULTIMETER	
TRUE RMS MULTIMETER	FLUKE	117	MRTSUE06080	1 year	2021/05/06
Temperature & Humidity Chamber	TEN BILLION	TTH-B3UP	MRTSUE06051	1 year	2021/11/07
Temperature/Humidity Meter	TFA	35.1078.10.IT	MRTSUE06362	1 year	2021/03/29

Software	Version	Function
EMI Software	V3	EMI Test Software

## 5. MEASUREMENT UNCERTAINTY

Where relevant, the following test uncertainty levels have been estimated for tests performed on the EUT as specified in CISPR 16-4-2. This uncertainty represents an expanded uncertainty expressed at approximately the 95% confidence level using a coverage factor of  $k = 2$ .

Conducted Measurement
Measuring Uncertainty for a Level of Confidence of 95% ( $U=2Uc(y)$ ): 2.65dB
Radiated Emission Measurement
Measuring Uncertainty for a Level of Confidence of 95% ( $U=2Uc(y)$ ): 9kHz ~ 30MHz: 3.92dB 30MHz ~ 1GHz: 4.25dB 1GHz ~ 18GHz: 4.40dB

## 6. TEST RESULT

### 6.1. Summary

FCC Section(s)	Test Description	Test Limit	Test Condition	Test Result	Reference
2.1046; 24.232(a)(2)	Equivalent Isotropically Radiated Power	Refer to Section 6.2	Conducted	Pass	Section 6.2
24.238(a)	Band Edge Measurements	Refer to Section 6.3		Pass	Section 6.3

**Notes:**

- 1) The analyzer plots shown in this section were all taken with a correction table loaded into the analyzer. The correction table was used to account for the losses of the cables and attenuators used as part of the system to connect the EUT to the analyzer at all frequencies of interest.
- 2) The Band-edge is presented the worst test data in the test report.

## 6.2. Equivalent Isotropically Radiated Power Measurement

### 6.2.1. Test Limit

The Radiated Equivalent Isotropically Power shall be according to the specific rule Part 24.232(a)(2) that are limited to EIRP of 1640 watts/MHz when transmitting with an emission bandwidth greater than 1 MHz.

### 6.2.2. Test Procedures Used

KDB 971168 D01v03r01 - Section 5.2.4 & 5.8

ANSI C63.26-2015 - Section 5.2.4.2 & 5.2.7

### 6.2.3. Test Setting

#### Average Power Measurement

Average power measurements were performed only when the EUT was transmitting at its maximum power control level using a broadband power meter with a pulse sensor. The power meter implemented triggering and gating capabilities which were set up such that power measurements were recorded only during the ON time of the transmitter.

### 6.2.4. Test Setup

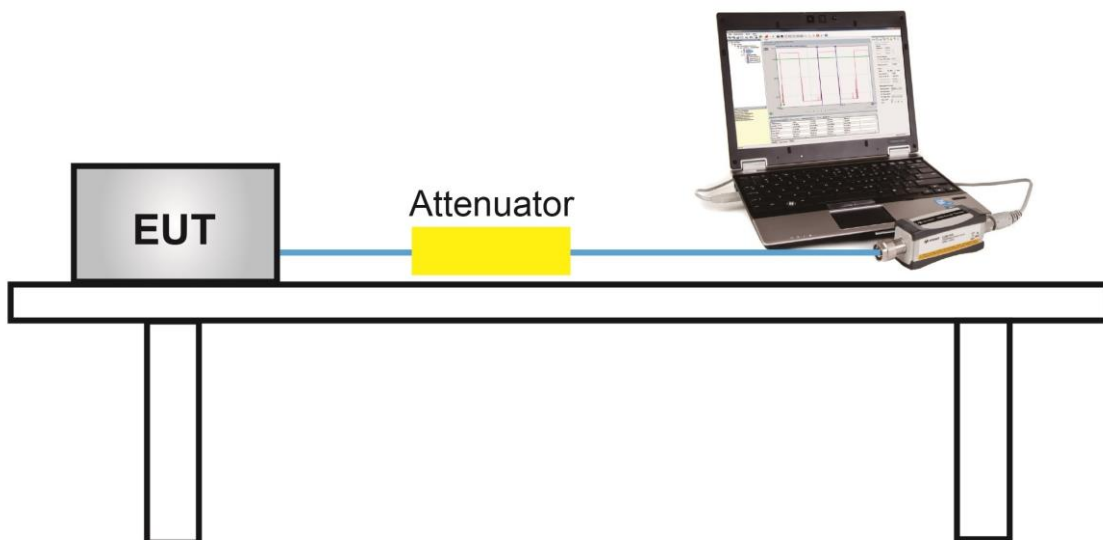

### 6.2.5. Test Result

Product	AirScale Indoor Radio ASiR-pRRH	Test Engineer	Peter Xu
Test Site	SR2	Test Date	2020/12/03 ~ 2020/12/04
Test Configuration	NB-IoT Band 25		

Frequency (MHz)	Carrier Position (kHz)	Channel Bandwidth (MHz)	Ant 0 Power (dBm)	Ant 1 Power (dBm)	Total Power (dBm)
Guard band					
1935.0	-4597.5	10	23.38	23.22	26.31
	4597.5	10	23.39	23.43	26.42
1962.5	-4597.5	10	23.54	23.35	26.46
	4597.5	10	23.44	23.36	26.41
1990.0	-4597.5	10	23.29	23.50	26.41
	4597.5	10	23.23	23.48	26.37
1937.5	-6892.5	15	23.55	23.51	26.54
	6892.5	15	23.84	23.69	26.78
1962.5	-6892.5	15	23.35	23.33	26.35
	6892.5	15	23.21	23.39	26.31
1987.5	-6892.5	15	23.46	23.62	26.55
	6892.5	15	23.32	23.45	26.40
1940.0	-9097.5	20	23.46	23.59	26.54
	9097.5	20	23.45	23.38	26.43
1962.5	-9097.5	20	23.46	23.53	26.51
	9097.5	20	23.79	23.68	26.75
1985.0	-9097.5	20	23.21	23.19	26.21
	9097.5	20	23.39	23.28	26.35

Note: Total Power (dBm) =  $10 \cdot \log \{ 10^{[ANT\ 0\ Power\ (dBm) / 10]} + 10^{[ANT\ 1\ Power\ (dBm) / 10]} \}$  (dBm).

Frequency (MHz)	Carrier Position (kHz)	Channel Bandwidth (MHz)	Ant 0 Power (dBm)	Ant 1 Power (dBm)	Total Power (dBm)
In band					
1935.0	4	10	23.26	23.18	26.23
	45	10	23.37	23.28	26.34
1962.5	4	10	22.95	22.72	25.85
	45	10	23.01	22.69	25.86
1990.0	4	10	23.21	22.90	26.07
	45	10	23.15	23.03	26.10
1937.5	2	15	23.04	22.98	26.02
	72	15	23.15	23.09	26.13
1962.5	2	15	23.25	22.94	26.11
	72	15	23.23	22.92	26.09
1987.5	2	15	23.21	22.83	26.03
	72	15	23.14	22.93	26.05
1940.0	4	20	23.35	23.27	26.32
	95	20	23.41	23.36	26.40
1962.5	4	20	23.15	22.85	26.01
	95	20	23.02	22.72	25.88
1985.0	4	20	23.31	23.24	26.29
	95	20	23.29	23.18	26.25

Note: Total Power (dBm) =  $10 \cdot \log \{ 10^{[ANT\ 0\ Power\ (dBm) / 10]} + 10^{[ANT\ 1\ Power\ (dBm) / 10]} \}$  (dBm).

Product	AirScale Indoor Radio ASiR-pRRH	Test Engineer	Peter Xu
Test Site	SR2	Test Date	2021/02/05
Test Configuration	NB-IoT Band 25		

Frequency (MHz)	Channel Bandwidth (MHz)	Reading Level (dBm)	Factor (dB)	EIRP (dBm)	Limit (dBm)
Guard band					
1935.0	10	26.21	4.87	31.08	< 62.15
1962.5	10	26.43	4.97	31.40	< 62.15
1990.0	10	25.51	5.90	31.41	< 62.15
1937.5	15	26.26	4.83	31.09	< 62.15
1962.5	15	25.93	4.97	30.90	< 62.15
1987.5	15	25.18	5.83	31.01	< 62.15
1940.0	20	25.77	4.79	30.56	< 62.15
1962.5	20	25.13	4.97	30.10	< 62.15
1985.0	20	24.90	5.76	30.66	< 62.15
In band					
1935.0	10	25.91	4.87	30.78	< 62.15
1962.5	10	26.08	4.97	31.05	< 62.15
1990.0	10	25.20	5.90	31.10	< 62.15
1937.5	15	26.26	4.83	31.09	< 62.15
1962.5	15	26.04	4.97	31.01	< 62.15
1987.5	15	25.37	5.83	31.20	< 62.15
1940.0	20	25.91	4.79	30.70	< 62.15
1962.5	20	25.40	4.97	30.37	< 62.15
1985.0	20	25.05	5.76	30.81	< 62.15



### **6.3. Frequency Stability Measurement**

#### **6.3.1. Test Limit**

N/A

#### **6.3.2. Test Procedures Used**

KDB 971168 D01v03r01 - Section 9

ANSI C63.26-2015 - Section 5.6

#### **6.3.3. Test Setting**

##### **Frequency Stability Under Temperature Variations:**

The equipment under test was connected to an external AC or DC power supply and input rated voltage. RF output was connected to a frequency counter or spectrum analyzer via feed through attenuators. The EUT was placed inside the temperature chamber. Set the spectrum analyzer RBW low enough to obtain the desired frequency resolution and measure EUT 20°C operating frequency as reference frequency. Turn EUT off and set the chamber temperature to highest. After the temperature stabilized for approximately 30 minutes recorded the frequency. Repeat step measure with 10°C decreased per stage until the lowest temperature reached.

##### **Frequency Stability Under Voltage Variations:**

Set chamber temperature to 20°C. Use a variable AC power supply / DC power source to power the EUT and set the voltage to rated voltage. Set the spectrum analyzer RBW low enough to obtain the desired frequency resolution and recorded the frequency.

Reduce the input voltage to specify extreme voltage variation ( $\pm 15\%$ ) and endpoint (If a product is specified to operate over a range of input voltage then the  $-15\%$  variation is applied to the lowermost voltage and the  $+15\%$  is applied to the uppermost voltage), record the maximum frequency change.

### 6.3.4. Test Setup

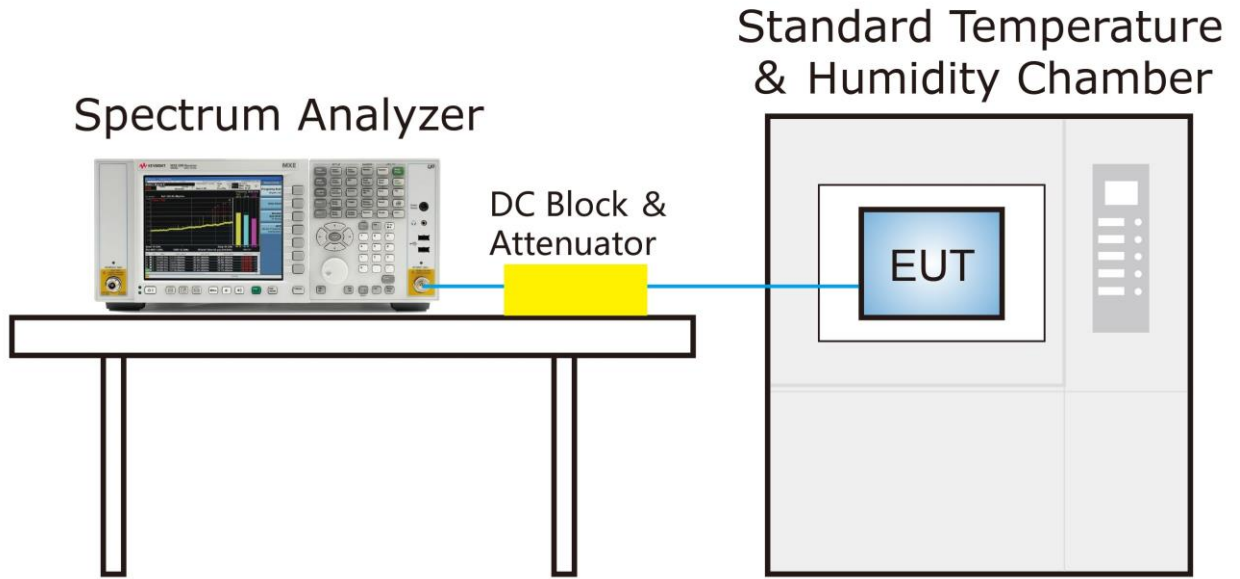

### 6.3.5. Test Result

Product	AirScale Indoor Radio ASiR-pRRH	Test Engineer	Peter Xu
Test Site	SR2	Test Date	2021/02/03
Test Item	Frequency Stability - NB-lot Band 25, Guard band, 1962.5MHz		

Voltage (DC)	Temp (°C)	Frequency Tolerance (ppm)
54V	- 30	-0.0294
	- 20	-0.0295
	- 10	-0.0294
	0	-0.0295
	+ 10	-0.0297
	+ 20 (Ref)	-0.0296
	+ 30	-0.0294
	+ 40	-0.0299
	+ 50	-0.0297
57V	+ 20	-0.0297
52V	+ 20	-0.0295

## **6.4. Emission Bandwidth**

### **6.4.1. Test Limit**

The emission bandwidth is defined as the width of the signal between two points, one below the carrier center frequency and one above the carrier center frequency, outside of which all emissions are attenuated at least 26 dB below the transmitter power.

### **6.4.2. Test Procedure**

KDB 971168 D01v03r01 - Section 4.1 & 4.2

ANSI C63.26-2015 - Section 5.4.3 & 5.4.4

### **6.4.3. Test Setting**

1. Set center frequency to the nominal EUT channel center frequency;
2. RBW = The nominal RBW shall be in the range of 1% to 5% of the anticipated OBW;
3. VBW  $\geq 3 \times$  RBW;
4. Detector = Peak;
5. Trace mode = max hold;
6. Sweep = auto couple;
7. Allow the trace to stabilize;
8. The dynamic range of the spectrum analyzer at the selected RBW shall be more than 10 dB below the target “-X dB” requirement, i.e., if the requirement calls for measuring the -26 dB OBW, the spectrum analyzer noise floor at the selected RBW shall be at least 26 dB below the reference level

### 6.4.4. Test Setup

## Spectrum Analyzer

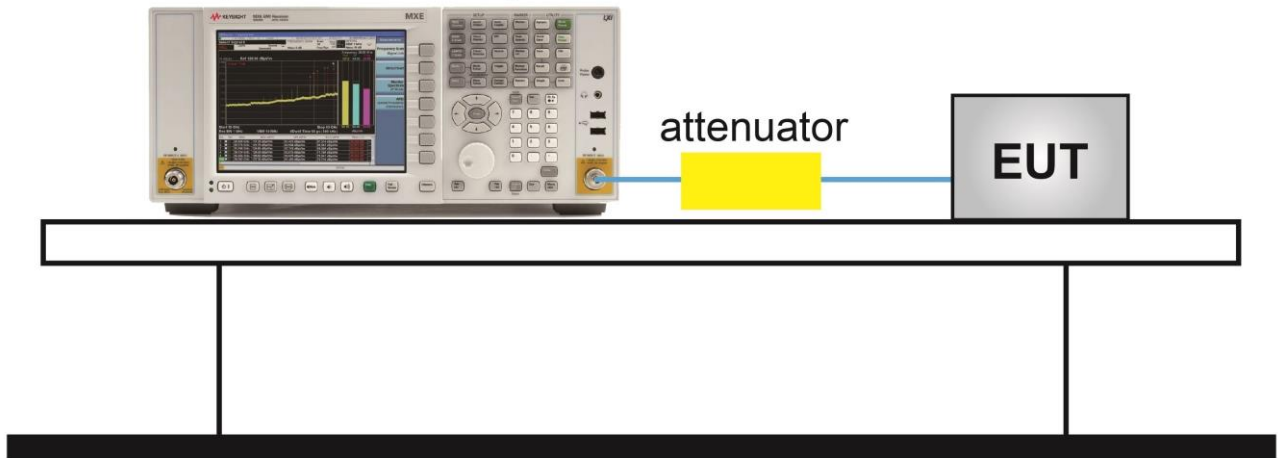

### 6.4.5. Test Result

Product	AirScale Indoor Radio ASiR-pRRH	Test Engineer	Peter Xu
Test Site	SR2	Test Date	2021/02/02
Test Configuration	NB-IoT Band 25		

Frequency (MHz)	Carrier Position (kHz)	Bandwidth (MHz)	26dB Bandwidth (MHz)	99% Bandwidth (MHz)
Guard band				
1935.0	-4597.5	10	9.84	9.24
	4597.5	10	9.82	9.21
1962.5	-4597.5	10	9.87	9.20
	4597.5	10	9.83	9.21
1990.0	-4597.5	10	9.85	9.24
	4597.5	10	9.81	9.23
1937.5	-6892.5	15	14.75	13.75
	6892.5	15	14.62	13.77
1962.5	-6892.5	15	14.86	13.81
	6892.5	15	14.78	13.80
1987.5	-6892.5	15	14.84	13.84
	6892.5	15	14.74	13.80
1940.0	-9097.5	20	19.69	18.19
	9097.5	20	19.43	18.15
1962.5	-9097.5	20	19.57	18.21
	9097.5	20	19.68	18.21
1985.0	-9097.5	20	19.65	18.26
	9097.5	20	19.76	18.25

Band 25 Guard band

10MHz Channel Bandwidth - Carrier Position 4597.5 kHz

Bottom Channel

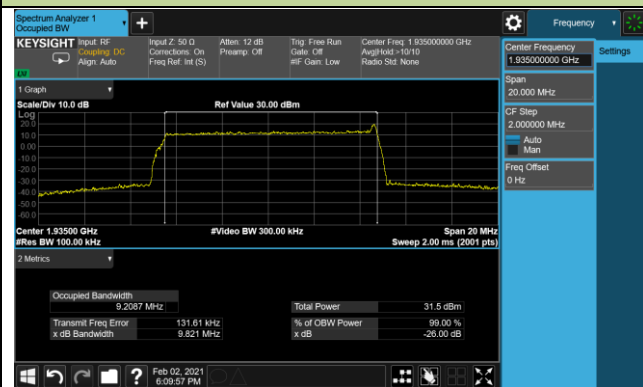

Middle Channel



Top Channel

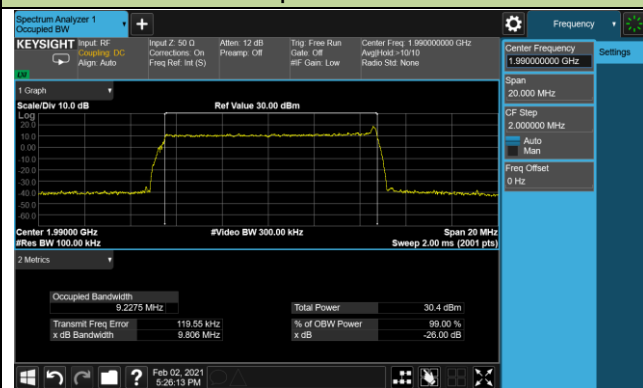

15MHz Channel Bandwidth - Carrier Position 6892.5 kHz

Bottom Channel

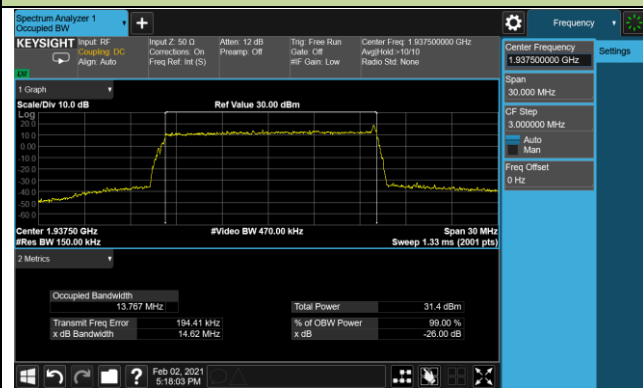

Middle Channel

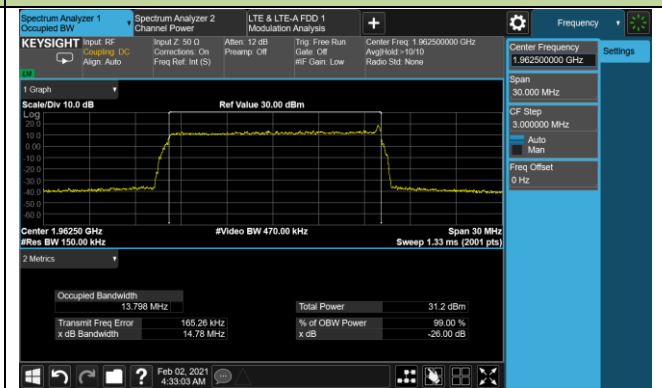

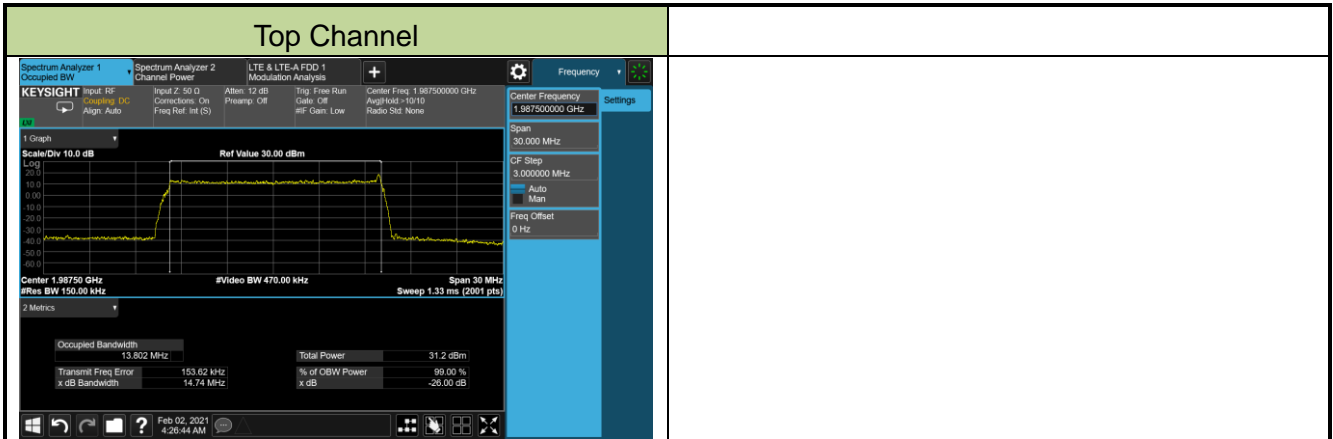

### 20MHz Channel Bandwidth - Carrier Position 9097.5 kHz

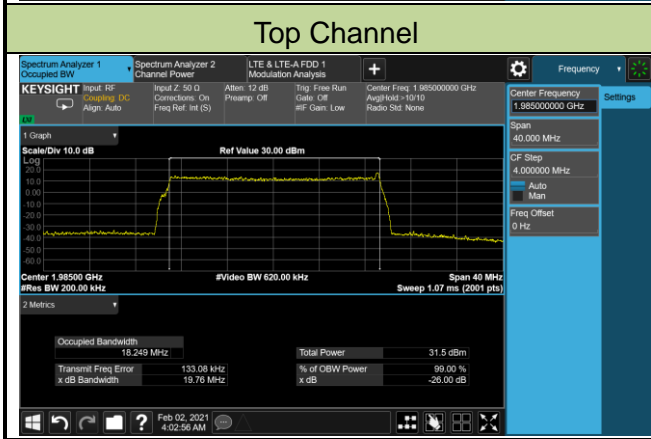
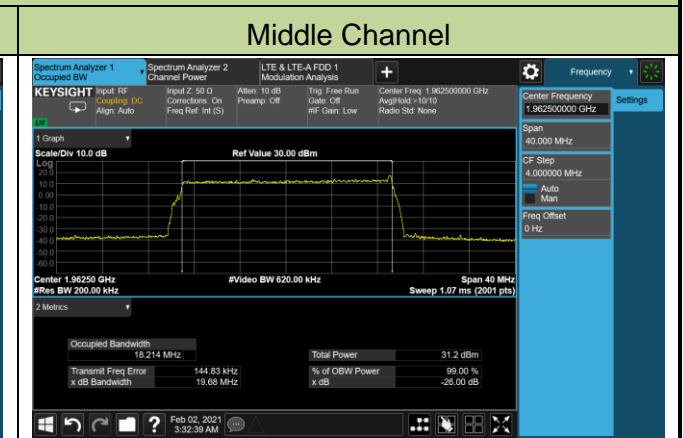
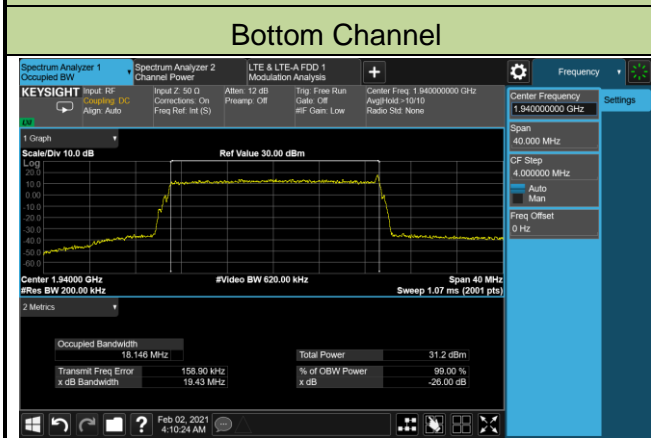

### 10MHz Channel Bandwidth - Carrier Position -4597.5 kHz

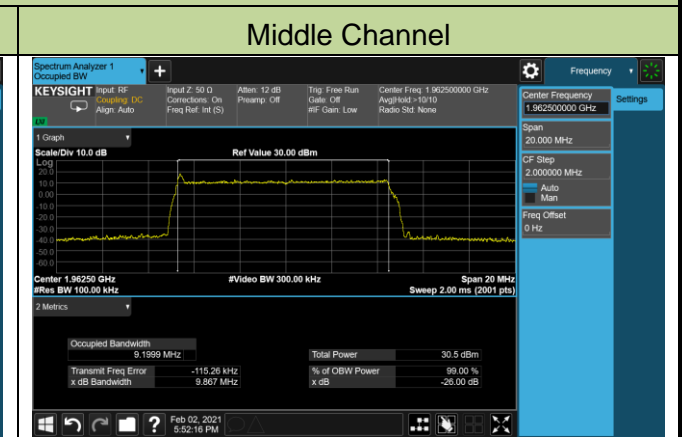
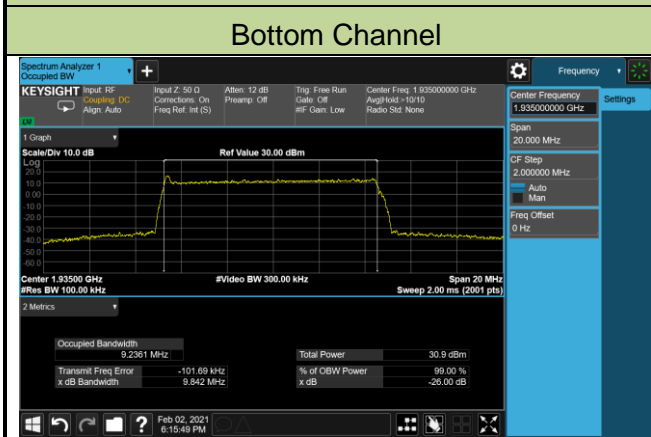



**Top Channel**

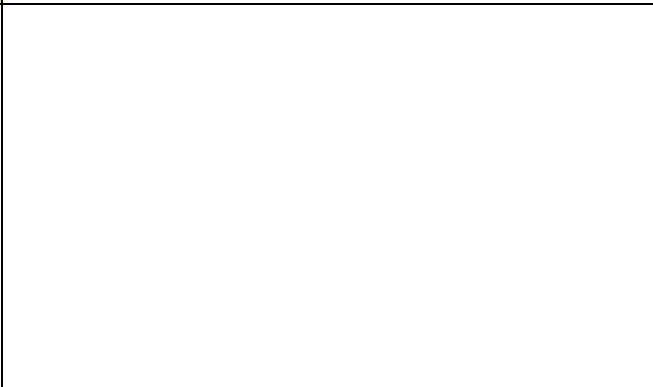

**15MHz Channel Bandwidth - Carrier Position -6892.5 kHz**

**Bottom Channel**



**Middle Channel**

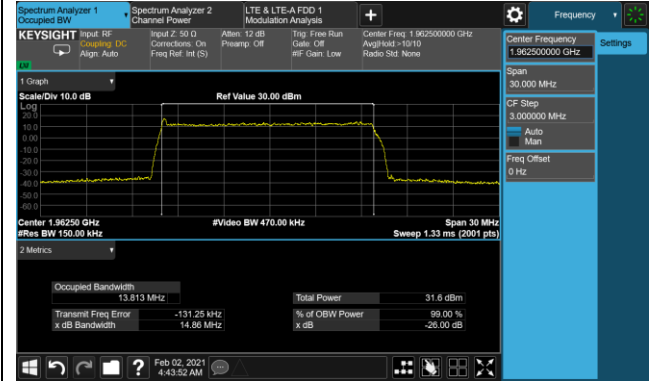

**Top Channel**

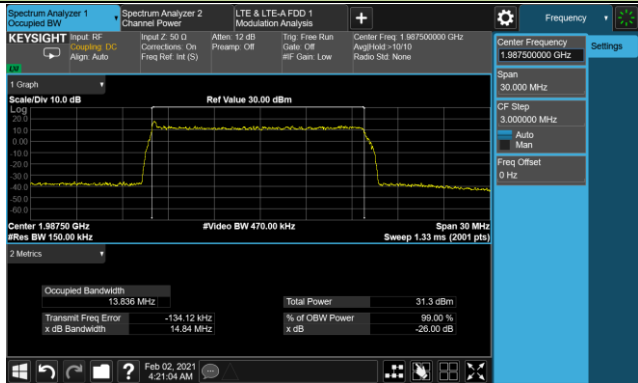

**Middle Channel**

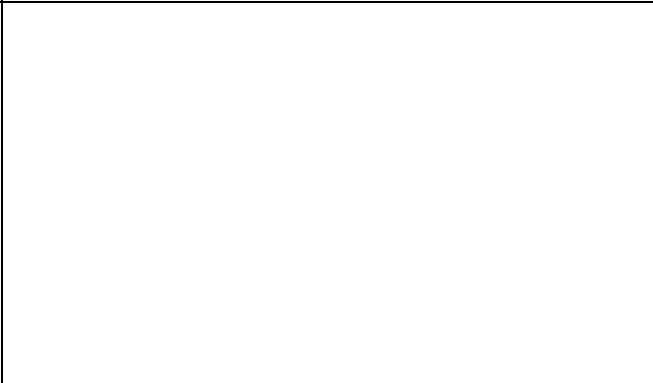

**20MHz Channel Bandwidth - Carrier Position -9097.5 kHz**

**Bottom Channel**

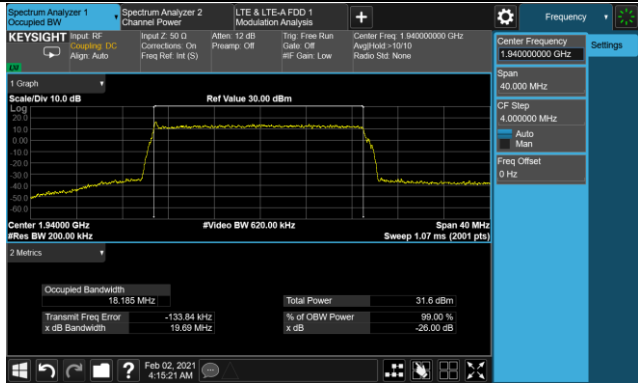

**Middle Channel**

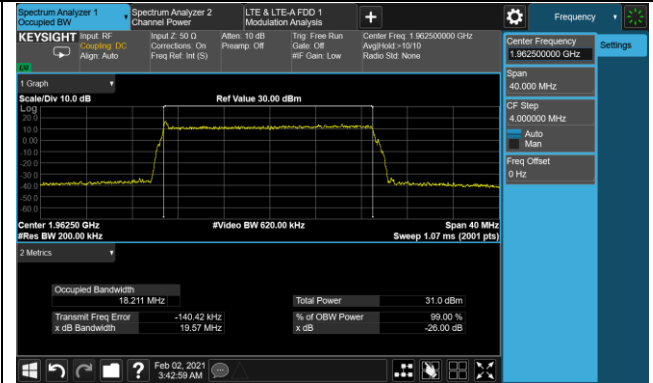

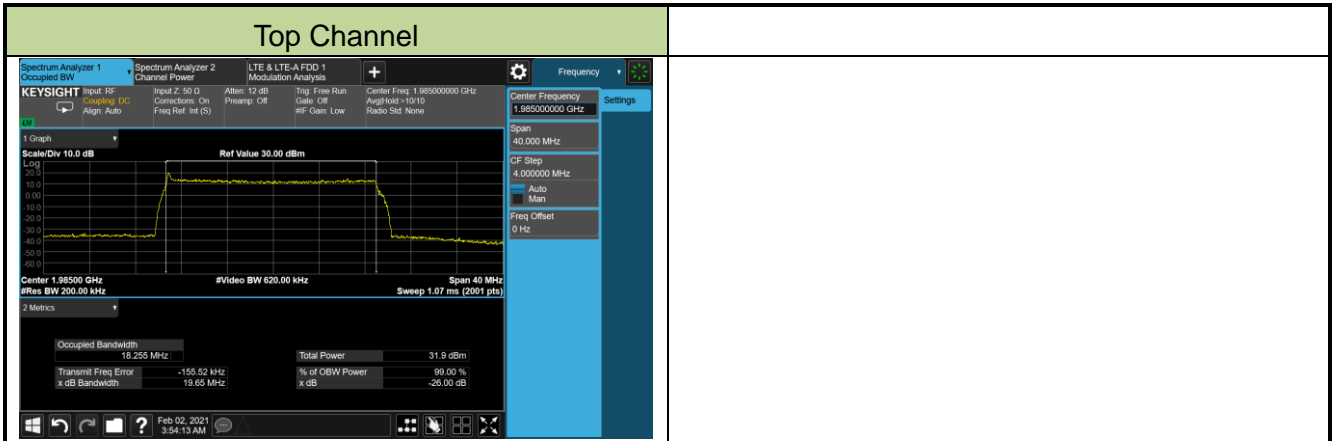

## 6.5. Band Edge Measurement

### 6.5.1. Test Limit

The power of any emission outside of the authorized operating frequency ranges must be attenuated below the transmitting power (P) by a factor of at least  $43 + 10 \log(P)$  dB. The emission limit equal to -13dBm.

This device can be implement MIMO function, so the limit of spurious emissions needs to be reduced by  $10 \cdot \log(\text{Numbers}_{\text{Ant}})$  according to FCC KDB 662911 D01 guidance.

The limit is adjusted to  $-13 \text{ dBm} - 10 \cdot \log(2) = -16.01 \text{ dBm}$

### 6.5.2. Test Procedure Used

KDB 971168 D01v03r01 - Section 6.1

ANSI C63.26-2015 - Section 5.7.1

### 6.5.3. Test Setting

1. Set the analyzer frequency to low or high channel.
1. RBW = The nominal RBW shall be in the range of 1% to 5% of the anticipated OBW;
2. VBW  $\geq 3 \cdot$ RBW
3. Sweep time = auto
4. Detector = power averaging (rms)
5. Set sweep trigger to "free run."
6. Trace average at least 100 traces in power averaging (rms) mode if sweep is set to auto-couple.

To accurately determine the average power over the on and off time of the transmitter, it can be necessary to increase the number of traces to be averaged above 100, or if using a manually configured sweep time, increase the sweep time.

### 6.5.4. Test Setup

#### Spectrum Analyzer

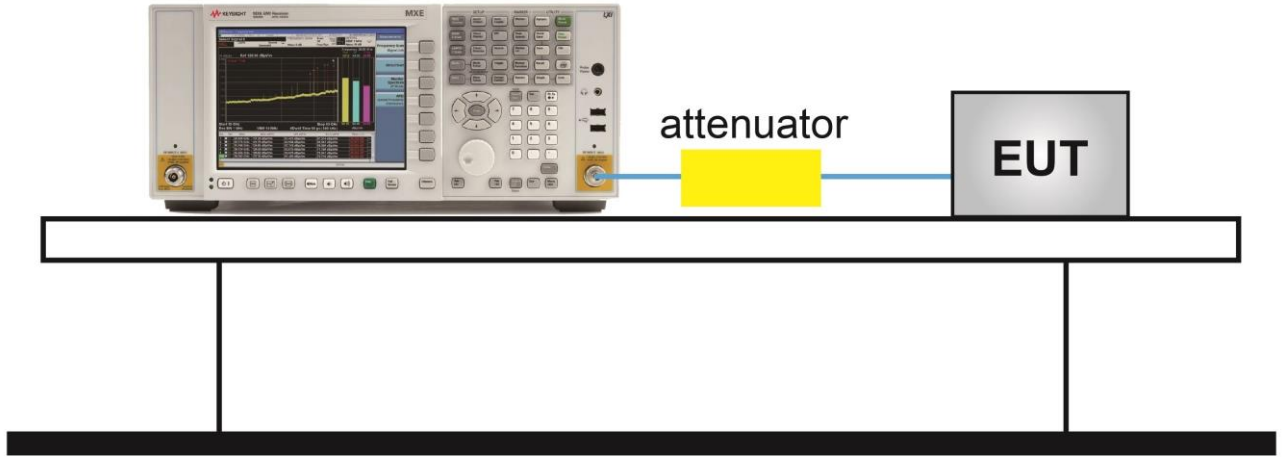

### 6.5.5. Test Result

Product	AirScale Indoor Radio ASiR-pRRH	Test Engineer	Peter Xu
Test Site	SR6	Test Date	2020/12/03 ~ 2020/12/04
Test Configuration	NB-IoT Band 25		

Frequency (MHz)	Carrier Position (kHz)	Channel Bandwidth (MHz)	Max Band Edge (dBm)		Limit (dBm)	Result
			Ant 0	Ant 1		
Guard band						
1935.0	-4597.5	10	-30.74	-31.45	≤ -16.01	Pass
1990.0	4597.5	10	-32.44	-33.36	≤ -16.01	Pass
1937.5	-6892.5	15	-33.16	-33.78	≤ -16.01	Pass
1987.5	6892.5	15	-35.59	-34.88	≤ -16.01	Pass
1940.0	-9097.5	20	-35.18	-35.74	≤ -16.01	Pass
1985.0	9097.5	20	-36.56	-36.06	≤ -16.01	Pass
In band						
1935.0	4	10	-31.33	-32.00	≤ -16.01	Pass
1990.0	45	10	-34.61	-34.59	≤ -16.01	Pass
1937.5	2	15	-33.79	-34.92	≤ -16.01	Pass
1987.5	72	15	-35.95	-34.79	≤ -16.01	Pass
1940.0	2	20	-35.11	-36.09	≤ -16.01	Pass
1985.0	95	20	-37.23	-36.63	≤ -16.01	Pass

### Gurad Band 10MHz Channel Bandwidth - Ant 0

#### Bottom Channel



#### Top Channel

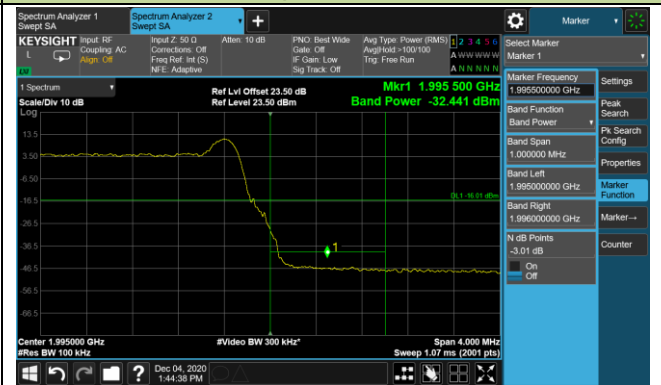

### Gurad Band 10MHz Channel Bandwidth - Ant 1

#### Bottom Channel

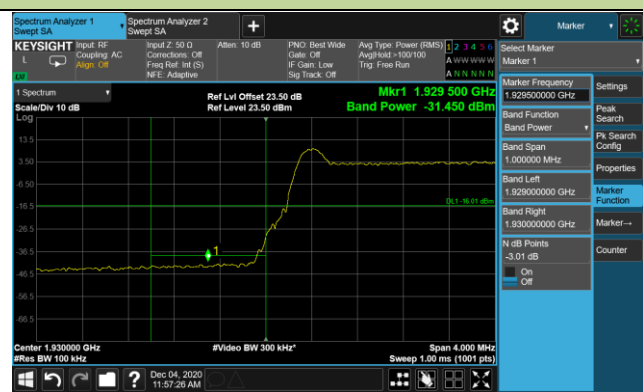

#### Top Channel



### Gurad Band 15MHz Channel Bandwidth - Ant 0

#### Bottom Channel



#### Top Channel



### Gurad Band 15MHz Channel Bandwidth - Ant 1

#### Bottom Channel



#### Top Channel

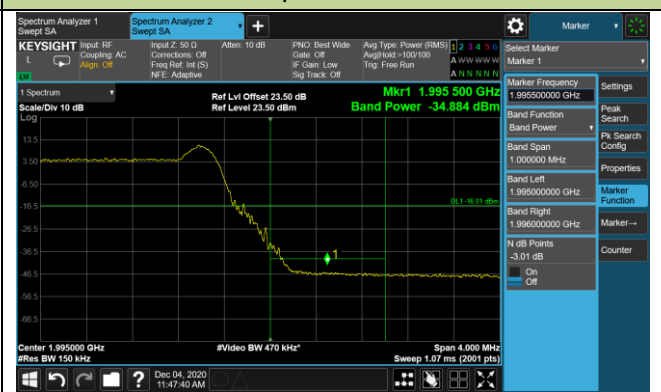

### Gurad Band 20MHz Channel Bandwidth - Ant 0

#### Bottom Channel

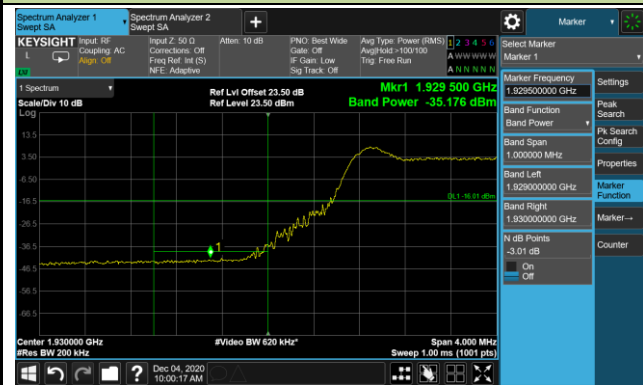

#### Top Channel



### Gurad Band 20MHz Channel Bandwidth - Ant 1

#### Bottom Channel



#### Top Channel

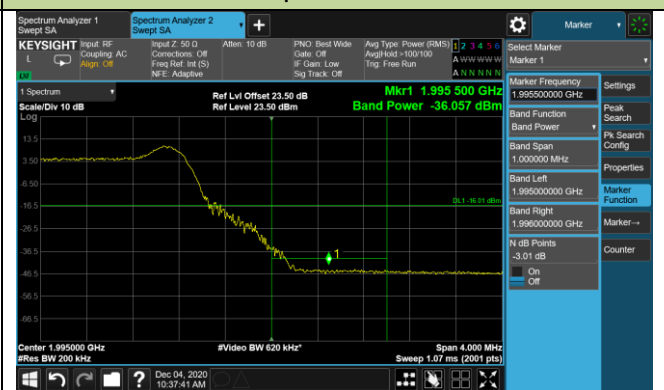



### In Band 10MHz Channel Bandwidth - Ant 0

#### Bottom Channel

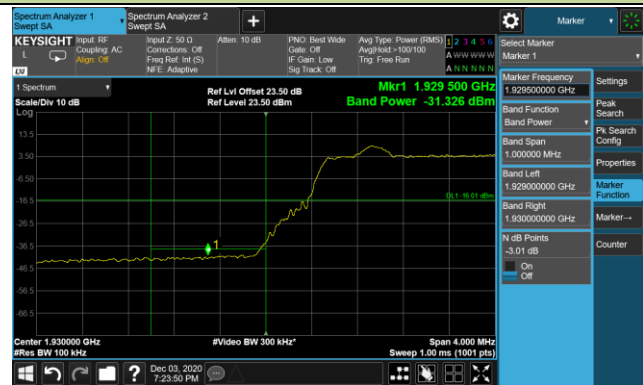

#### Top Channel



### In Band 10MHz Channel Bandwidth - Ant 1

#### Bottom Channel



#### Top Channel



### In Band 15MHz Channel Bandwidth - Ant 0

#### Bottom Channel



#### Top Channel



### In Band 15MHz Channel Bandwidth - Ant 1

#### Bottom Channel



#### Top Channel



### In Band 20MHz Channel Bandwidth - Ant 0

#### Bottom Channel



#### Top Channel



### In Band 20MHz Channel Bandwidth - Ant 1

#### Bottom Channel

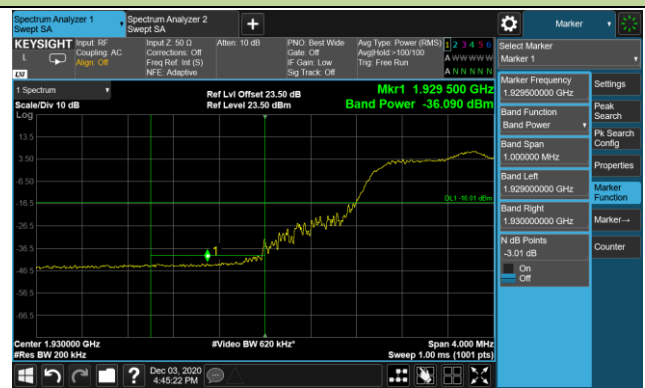

#### Top Channel

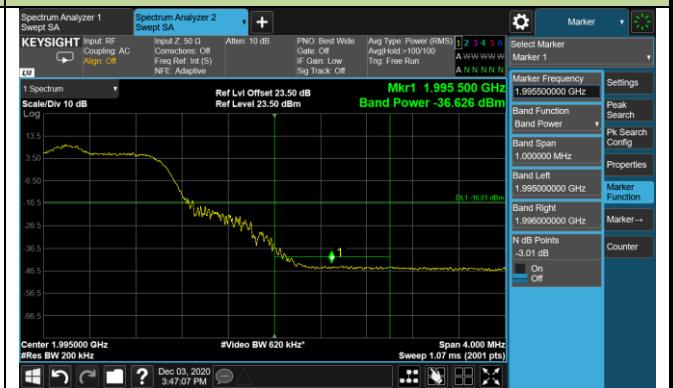

## 7. CONCLUSION

The data collected relate only the item(s) tested and show that the **AirScale Indoor Radio ASiR-pRRH** is compliance with FCC Rules.

---

The End