

## FCC Test Report (Part 22\_C2PC (Class II Permissive Change))

**Report No.:** RF180905C04A

**FCC ID:** 2AD8UAHCE01

**Test Model:** AHCE

**Received Date:** Jan. 30, 2019

**Test Date:** Feb. 27 ~ Feb. 28, 2019 and Apr. 30 ~ May 02, 2019

**Issued Date:** May 13, 2019

**Applicant:** Nokia Solutions and Networks, OY

**Address:** 2000 W. Lucent Lane, Naperville, IL 60563, USA

**Issued By:** Bureau Veritas Consumer Products Services (H.K.) Ltd., Taoyuan Branch

**Lab Address:** No. 47-2, 14th Ling, Chia Pau Vil., Lin Kou Dist., New Taipei City, Taiwan (R.O.C.)

**Test Location:** No. 19, Hwa Ya 2nd Rd., Wen Hwa Vil., Kwei Shan Dist., Taoyuan City 33383, TAIWAN (R.O.C.)

**FCC Registration /  
Designation Number:** 788550 / TW0003



This report is for your exclusive use. Any copying or replication of this report to or for any other person or entity, or use of our name or trademark, is permitted only with our prior written permission. This report sets forth our findings solely with respect to the test samples identified herein. The results set forth in this report are not indicative or representative of the quality or characteristics of the lot from which a test sample was taken or any similar or identical product unless specifically and expressly noted. Our report includes all of the tests requested by you and the results thereof based upon the information that you provided to us. You have 60 days from date of issuance of this report to notify us of any material error or omission caused by our negligence, provided, however, that such notice shall be in writing and shall specifically address the issue you wish to raise. A failure to raise such issue within the prescribed time shall constitute your unqualified acceptance of the completeness of this report, the tests conducted and the correctness of the report contents. Unless specific mention, the uncertainty of measurement has been explicitly taken into account to declare the compliance or non-compliance to the specification. The report must not be used by the client to claim product certification, approval, or endorsement by TAF or any government agencies

## Table of Contents

<b>Release Control Record</b> .....	<b>4</b>
<b>1 Certificate of Conformity</b> .....	<b>5</b>
<b>2 Summary of Test Results</b> .....	<b>6</b>
2.1 Measurement Uncertainty.....	6
2.2 Test Site and Instruments.....	7
<b>3 General Information</b> .....	<b>8</b>
3.1 General Description of EUT.....	8
3.2 Configuration of System under Test.....	10
3.2.1 Description of Support Units.....	10
3.3 Test Mode Applicability and Tested Channel Detail.....	11
3.4 EUT Operating Conditions.....	12
3.5 General Description of Applied Standards.....	12
<b>4 Test Types and Results</b> .....	<b>13</b>
4.1 Output Power Measurement.....	13
4.1.1 Limits of Output Power Measurement.....	13
4.1.2 Test Procedures.....	13
4.1.3 Test Setup.....	14
4.1.4 Test Results.....	15
4.2 Modulation Characteristics Measurement.....	19
4.2.1 Limits of Modulation Characteristics.....	19
4.2.2 Test Procedure.....	19
4.2.3 Test Setup.....	19
4.2.4 Test Results.....	20
4.3 Frequency Stability Measurement.....	21
4.3.1 Limits of Frequency Stability Measurement.....	21
4.3.2 Test Procedure.....	21
4.3.3 Test Setup.....	21
4.3.4 Test Results.....	22
4.4 Occupied Bandwidth Measurement.....	24
4.4.1 Test Procedure.....	24
4.4.2 Test Setup.....	24
4.4.3 Test Result.....	25
4.5 Band Edge Measurement.....	29
4.5.1 Limits of Band Edge Measurement.....	29
4.5.2 Test Setup.....	29
4.5.3 Test Procedures.....	29
4.5.4 Test Results.....	30
4.6 Peak to Average Ratio.....	38
4.6.1 Limits of Peak to Average Ratio Measurement.....	38
4.6.2 Test Setup.....	38
4.6.3 Test Procedures.....	38
4.6.4 Test Results.....	39
4.7 Conducted Spurious Emissions.....	43
4.7.1 Limits of Conducted Spurious Emissions Measurement.....	43
4.7.2 Test Setup.....	43
4.7.3 Test Procedure.....	43
4.7.4 Test Results.....	44
4.8 Radiated Emission Measurement.....	76
4.8.1 Limits of Radiated Emission Measurement.....	76
4.8.2 Test Procedure.....	76
4.8.3 Deviation from Test Standard.....	76
4.8.4 Test Setup.....	77
4.8.5 Test Results.....	78

<b>5</b>	<b>Pictures of Test Arrangements.....</b>	<b>90</b>
	<b>Appendix – Information of the Testing Laboratories .....</b>	<b>91</b>

### Release Control Record

Issue No.	Description	Date Issued
RF180905C04A	Original release	May 13, 2019

## 1 Certificate of Conformity

**Product:** AirScale Micro Remote Radio Head

**Brand:** Nokia

**Test Model:** AHCE

**Sample Status:** Engineering sample

**Applicant:** Nokia Solutions and Networks, OY

**Test Date:** Feb. 27 ~ Feb. 28, 2019 and Apr. 30 ~ May 02, 2019

**Standards:** FCC Part 22, Subpart H

The above equipment has been tested by **Bureau Veritas Consumer Products Services (H.K.) Ltd., Taoyuan Branch**, and found compliance with the requirement of the above standards. The test record, data evaluation & Equipment Under Test (EUT) configurations represented herein are true and accurate accounts of the measurements of the sample's RF characteristics under the conditions specified in this report.

**Prepared by :** Pettie Chen , **Date:** May 13, 2019  
Pettie Chen / Senior Specialist

**Approved by :** Bruce Chen , **Date:** May 13, 2019  
Bruce Chen / Project Engineer

## 2 Summary of Test Results

Applied Standard: FCC Part 22 & Part 2			
FCC Clause	Test Item	Result	Remarks
2.1046 22.913 (a)	Effective radiated power	Pass	Meet the requirement of limit.
2.1047	Modulation characteristics	Pass	Meet the requirement
---	Peak To Average Ratio	Pass	Meet the requirement of limit.
2.1055 22.355	Frequency Stability	Pass	Meet the requirement of limit.
2.1049	Occupied Bandwidth	Pass	Meet the requirement of limit.
22.917	Band Edge Measurements	Pass	Meet the requirement of limit.
2.1051 22.917	Conducted Spurious Emissions	Pass	Meet the requirement of limit.
2.1053 22.917	Radiated Spurious Emissions	Pass	Meet the requirement of limit. Minimum passing margin is -4.9dB at 36.79MHz.

### 2.1 Measurement Uncertainty

Where relevant, the following measurement uncertainty levels have been estimated for tests performed on the EUT as specified in CISPR 16-4-2:

Measurement	Frequency	Expanded Uncertainty (k=2) ( $\pm$ )
Radiated Emissions up to 1 GHz	9kHz ~ 30MHz	3.04 dB
	30MHz ~ 200MHz	3.59 dB
	200MHz ~ 1000MHz	3.60 dB
Radiated Emissions above 1 GHz	1GHz ~ 18GHz	2.29 dB
	18GHz ~ 40GHz	2.29 dB

## 2.2 Test Site and Instruments

Description & Manufacturer	Model No.	Serial No.	Cal. Date	Cal. Due
Test Receiver KEYSIGHT	N9038A	MY55420137	Apr. 11, 2018	Apr. 10, 2019
			Apr. 15, 2019	Apr. 14, 2020
Spectrum Analyzer ROHDE & SCHWARZ	FSP40	100269	May 29, 2018	May 28, 2019
BILOG Antenna SCHWARZBECK	VULB9168	9168-160	Nov. 21, 2018	Nov. 20, 2019
HORN Antenna SCHWARZBECK	BBHA 9120 D	9120D-1169	Nov. 25, 2018	Nov. 24, 2019
HORN Antenna SCHWARZBECK	BBHA 9170	BBHA9170241	Nov. 25, 2018	Nov. 24, 2019
Loop Antenna TESEQ	HLA 6121	45745	Jun. 14, 2018	Jun. 13, 2019
Preamplifier Agilent (Below 1GHz)	8447D	2944A10638	Aug. 08, 2018	Aug. 07, 2019
Preamplifier Agilent (Above 1GHz)	8449B	3008A01924	Feb. 22, 2018	Feb. 21, 2019
			Feb. 21, 2019	Feb. 20, 2020
RF signal cable HUBER+SUHNER&EMCI	SUCOFLEX 104 & EMC104-SM-SM8000	CABLE-CH9-02 (248780+171006)	Jan. 19, 2019	Jan. 18, 2020
RF signal cable HUBER+SUHNER	SUCOFLEX 104	CABLE-CH9-(250795/4)	Aug. 08, 2018	Aug. 07, 2019
RF signal cable Woken	8D-FB	Cable-CH9-01	Jul. 31, 2018	Jul. 30, 2019
Software BV ADT	ADT_Radiated_ V7.6.15.9.5	NA	NA	NA
Antenna Tower EMCO	2070/2080	512.835.4684	NA	NA
Turn Table EMCO	2087-2.03	NA	NA	NA
Antenna Tower & Turn BV ADT	AT100	AT93021705	NA	NA
Turn Table BV ADT	TT100	TT93021705	NA	NA
Turn Table Controller BV ADT	SC100	SC93021705	NA	NA
Boresight Antenna Fixture	FBA-01	FBA-SIP01	NA	NA
JFW 20dB attenuation	50HF-020-SMA	NA	NA	NA
Radio Communication Analyzer	MT8821C	6261786083	Dec. 11, 2018	Dec. 10, 2019
WIT Standard Temperature And Humidity Chamber	TH-4S-C	W981030	Jun. 04, 2018	Jun. 03, 2019
True RMS Clamp Meter Fluke	325	31130711WS	May 22, 2018	May 21, 2019

Note: 1. The calibration interval of the above test instruments is 12 months and the calibrations are traceable to NML/ROC and NIST/USA.  
2. The test was performed in HwaYa Chamber 9.

### 3 General Information

#### 3.1 General Description of EUT

Product	AirScale Micro Remote Radio Head	
Brand	Nokia	
Test Model	AHCE	
FCC ID	2AD8UAHCE01	
Sample Status	Engineering sample	
Power Supply Rating	I/P: 100-240Vac, 50/60Hz, 3A MAX O/P: -54Vdc, 3A MAX	
Modulation Type	QPSK	
Operating Frequency	LTE Band 5 (Channel Bandwidth 10MHz)	874MHz ~ 889MHz
Max. ERP Power	LTE Band 5 (Channel Bandwidth 10MHz) NB-IoT Guard Band	87297.137mW (49.41dBm)
	LTE Band 5 (Channel Bandwidth 10MHz) NB-IoT In-Band	100000mW (50.00dBm)
Emission Designator		QPSK
	LTE Band 5 (Channel Bandwidth 10MHz) NB-IoT Guard Band	9M20G7D
	LTE Band 5 (Channel Bandwidth 10MHz) NB-IoT In-Band	8M94G7D
Antenna Gain	8dBi	
S/N	474044A	
HW Version	X21	
SW Version	FDD-LTE 18A	
Accessory Device	Refer to Note as below	
Cable Supplied	NA	

Note:

- This report is prepared for FCC class II permissive change. This is a supplementary report of Report No.: RF180905C04. The differences between them are as below information:
  - ◆ LTE B5 add NB-IoT Guard Band
  - ◆ LTE B5 add NB-IoT In-band
- For above changes, only NB-IoT Guard Band and In-band mode test results has to be performed. The other test items were copied from the original test report (Report No.: RF180905C04) and all data was verified to meet the requirements.
- The EUT contains following accessory devices.

AC PSU (Optional)	
Brand	Nokia
Model	APAB
Sales Item	474130A.102
S/N	U7174800066
Remark	SUPLET/S818A160-220S54W
Input Power	100-240Vac, 50-60Hz, 3A MAX
Output Power	-54Vdc, 3A MAX



4. The EUT incorporates a MIMO function. Physically, the EUT provides 4 completed transmitters and 4 receivers.

Modulation Mode	TX Function
N-TM (QPSK)	1TX
N-TM (QPSK)	2TX
N-TM (QPSK)	3TX
N-TM (QPSK)	4TX

5. The antenna gain for reference only, the test was done with 50ohm terminator on antenna port.

### 3.2 Configuration of System under Test

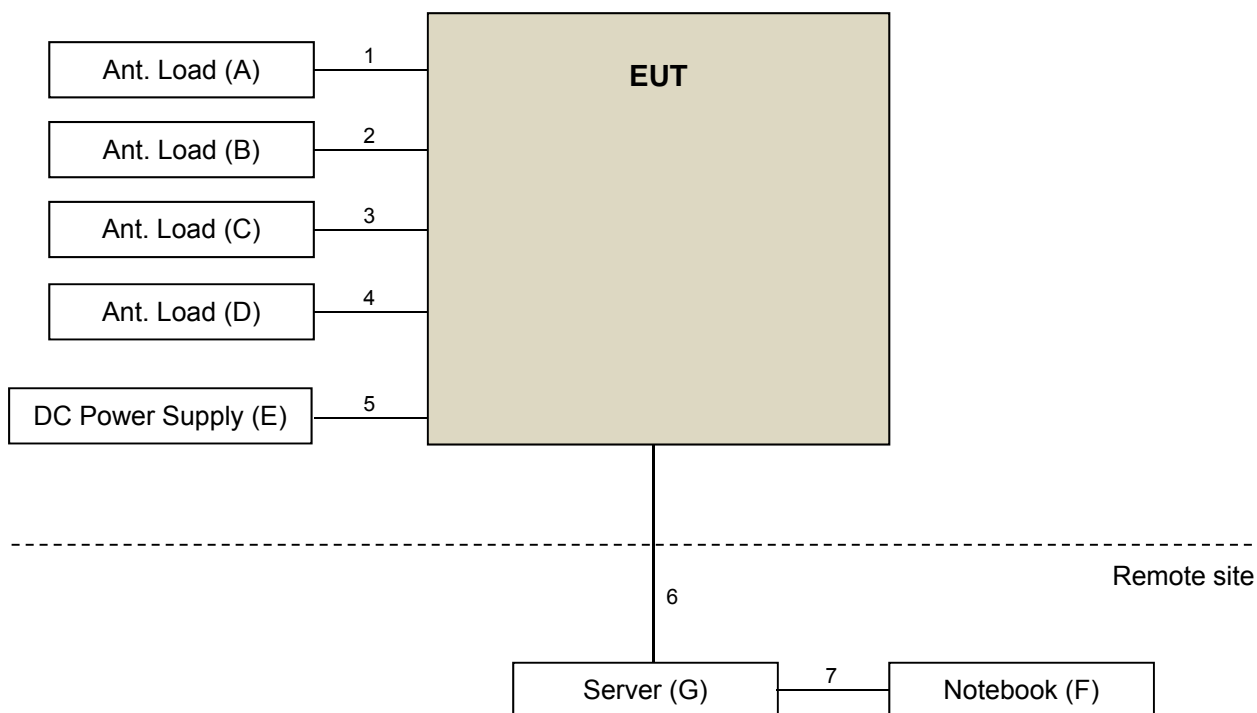

#### 3.2.1 Description of Support Units

The EUT has been tested as an independent unit together with other necessary accessories or support units. The following support units or accessories were used to form a representative test configuration during the tests.

ID	Product	Brand	Model No.	Serial No.	FCC ID	Remarks
A.	Ant. Load	NA	NA	NA	NA	Provided by manufacturer
B.	Ant. Load	NA	NA	NA	NA	Provided by manufacturer
C.	Ant. Load	NA	NA	NA	NA	Provided by manufacturer
D.	Ant. Load	NA	NA	NA	NA	Provided by manufacturer
E.	DC Power Supply	MEAN WELL	RSP-500-48	EB8B336856	NA	-
F.	Notebook	DELL	E5420	BPQ8MQ1	FCC DoC Approved	-
G.	Server	NA	NA	NA	NA	Provided by manufacturer

Note:

1. All power cords of the above support units are non-shielded (1.8m).
2. Item E, F, G acted as communication partners to transfer data.

ID	Descriptions	Qty.	Length (m)	Shielding (Yes/No)	Cores (Qty.)	Remarks
1.	Ant. Cable	1	1	Y	0	-
2.	Ant. Cable	1	1	Y	0	-
3.	Ant. Cable	1	1	Y	0	-
4.	Ant. Cable	1	1	Y	0	-
5.	DC Cable	1	1	Y	0	-
6.	Fiber Cable	1	5	N	0	-
7.	RJ45 Cable	1	1	N	0	-

### 3.3 Test Mode Applicability and Tested Channel Detail

Pre-Scan has been conducted to determine the worst-case mode from all possible combinations between available modulations, data rates, XYZ axis and antenna ports. The worst case was found when positioned on X-plane. Following channel(s) was (were) selected for the final test as listed below:

#### NB-IoT Guard Band

EUT Configure Mode	Test item	Channel	Center Carrier Frequency of E-UTRA channel	Bottom Freq.	Top Freq.	Channel Bandwidth	Modulation	Mode
-	ERP	2450 to 2600	874.0 MHz 881.5 MHz 889.0 MHz	869.4025 MHz 876.9025 MHz 884.4025 MHz	878.5975 MHz 886.0975 MHz 893.5975 MHz	10MHz	QPSK	1RB
-	Modulation characteristics	2450 to 2600	881.5 MHz	876.9025 MHz	886.0975 MHz	10MHz	QPSK	1RB
-	Frequency Stability	2450 to 2600	881.5 MHz	876.9025 MHz	886.0975 MHz	10MHz	QPSK	1RB
-	Occupied Bandwidth	2450 to 2600	874.0 MHz 881.5 MHz 889.0 MHz	869.4025 MHz 876.9025 MHz 884.4025 MHz	878.5975 MHz 886.0975 MHz 893.5975 MHz	10MHz	QPSK	1RB
-	Band Edge	2450 to 2600	874.0 MHz 889.0 MHz	869.4025 MHz 884.4025 MHz	878.5975 MHz 893.5975 MHz	10MHz	QPSK	1RB
-	Peak to Average Ratio	2450 to 2600	874.0 MHz 881.5 MHz 889.0 MHz	869.4025 MHz 876.9025 MHz 884.4025 MHz	878.5975 MHz 886.0975 MHz 893.5975 MHz	10MHz	QPSK	1RB
-	Conducted Emission	2450 to 2600	874.0 MHz 881.5 MHz 889.0 MHz	869.4025 MHz 876.9025 MHz 884.4025 MHz	878.5975 MHz 886.0975 MHz 893.5975 MHz	10MHz	QPSK	1RB
-	Radiated Emission Below 1GHz	2450 to 2600	881.5 MHz	876.9025 MHz	-	10MHz	QPSK	1RB
-	Radiated Emission Above 1GHz	2450 to 2600	874.0 MHz 881.5 MHz 889.0 MHz	869.4025 MHz 876.9025 MHz 884.4025 MHz	878.5975 MHz 886.0975 MHz 893.5975 MHz	10MHz	QPSK	1RB

#### NB-IoT In-Band

EUT Configure Mode	Test item	Channel	Center Carrier Frequency of E-UTRA channel	Bottom Freq.	Top Freq.	Channel Bandwidth	Modulation	Mode
-	ERP	2450 to 2600	874.0 MHz 881.5 MHz 889.0 MHz	870.22 MHz 877.72 MHz 885.22 MHz	877.60 MHz 885.10 MHz 892.60 MHz	10MHz	QPSK	1RB
-	Modulation characteristics	2450 to 2600	881.5 MHz	877.72 MHz	885.10 MHz	10MHz	QPSK	1RB
-	Frequency Stability	2450 to 2600	881.5 MHz	877.72 MHz	885.10 MHz	10MHz	QPSK	1RB
-	Occupied Bandwidth	2450 to 2600	874.0 MHz 881.5 MHz 889.0 MHz	870.22 MHz 877.72 MHz 885.22 MHz	877.60 MHz 885.10 MHz 892.60 MHz	10MHz	QPSK	1RB
-	Band Edge	2450 to 2600	874.0 MHz 889.0 MHz	870.22 MHz 885.22 MHz	877.60 MHz 892.60 MHz	10MHz	QPSK	1RB
-	Peak to Average Ratio	2450 to 2600	874.0 MHz 881.5 MHz 889.0 MHz	870.22 MHz 877.72 MHz 885.22 MHz	877.60 MHz 885.10 MHz 892.60 MHz	10MHz	QPSK	1RB
-	Conducted Emission	2450 to 2600	874.0 MHz 881.5 MHz 889.0 MHz	870.22 MHz 877.72 MHz 885.22 MHz	877.60 MHz 885.10 MHz 892.60 MHz	10MHz	QPSK	1RB
-	Radiated Emission Below 1GHz	2450 to 2600	881.5 MHz	877.72 MHz	-	10MHz	QPSK	1RB
-	Radiated Emission Above 1GHz	2450 to 2600	874.0 MHz 881.5 MHz 889.0 MHz	870.22 MHz 877.72 MHz 885.22 MHz	877.60 MHz 885.10 MHz 892.60 MHz	10MHz	QPSK	1RB

Test Condition:

Test Item	Environmental Conditions	Input Power	Tested By
ERP	24deg. C, 64%RH	120Vac, 60Hz	James Yang
Modulation characteristics	24deg. C, 64%RH	120Vac, 60Hz	James Yang
Frequency Stability	24deg. C, 64%RH	-54Vdc	James Yang
Occupied Bandwidth	24deg. C, 64%RH	120Vac, 60Hz	James Yang
Band Edge	24deg. C, 64%RH	120Vac, 60Hz	James Yang
Peak To Average Ratio	24deg. C, 64%RH	120Vac, 60Hz	James Yang
Conducted Emission	24deg. C, 64%RH	120Vac, 60Hz	James Yang
Radiated Emission	25deg. C, 65%RH 22deg. C, 68%RH	120Vac, 60Hz	Greg Lin Han Wu

### 3.4 EUT Operating Conditions

The EUT makes a call to the communication simulator. The communication simulator station system controlled a EUT to export maximum output power under transmission mode and specific channel frequency

### 3.5 General Description of Applied Standards

The EUT is a RF Product. According to the specifications of the manufacturer, it must comply with the requirements of the following standards:

**FCC 47 CFR Part 2**

**FCC 47 CFR Part 22**

**KDB 971168 D01 Power Meas License Digital Systems v03r01**

**KDB 662911 D01 Multiple Transmitter Output v02r01**

**ANSI/TIA/EIA-603-E 2016**

**ANSI 63.26-2015**

All test items have been performed and recorded as per the above standards.

## 4 Test Types and Results

### 4.1 Output Power Measurement

#### 4.1.1 Limits of Output Power Measurement

The ERP of transmitters in the Cellular Radiotelephone Service must not exceed the limits in this section.

- (i) 500 watts per emission; or
- (ii) 400 watts/MHz (PSD) per sector.

#### 4.1.2 Test Procedures

##### EIRP / ERP Measurement:

- a. All measurements were done at low, middle and high operational frequency range. RBW and VBW is 10MHz for LTE mode.
- b. Substitution method is used for E.I.R.P measurement. In the semi-anechoic chamber, EUT placed on the 0.8m(below or equal 1GHz) and/or 1.5m(above 1GHz) height of Turn Table, rotated the table around 360 degrees to search the maximum radiation power and receiver antenna shall be rotated vertical and horizontal polarization and moved height from 1m to 4m to find the maximum polar radiated power. The "Read Value" is the spectrum reading the maximum power value.
- c. The substitution horn antenna is substituted for EUT at the same position and signals generator export the CW signal to the substitution antenna via a TX cable. Rotated the Turn Table and moved receiving antenna to find the maximum radiation power. Adjust output power level of S.G to get a Value of spectrum reading equal to "Read Value" of step b. Record the power level of S.G
- d. EIRP = Output power level of S.G – TX cable loss + Antenna gain of substitution horn. E.R.P power can be calculated form E.I.R.P power by subtracting the gain of dipole, E.R.P power = E.I.R.P power - 2.15dB.

Where:

$$\text{EIRP / ERP} = P_{\text{Meas}} + G_T - L_C$$

$P_{\text{Meas}}$  : Measure transmitter output power.

$G_T$  : Gain of the transmitting antenna.

$L_C$  : signal attenuation in the connecting cable between the transmitter and antenna.

##### Conducted Power Measurement:

The EUT was set up for the maximum power with LTE link data modulation and link up with simulator. Set the EUT to transmit under low, middle and high channel and record the power level shown on simulator.

### 4.1.3 Test Setup

ERP Measurement:

**For Radiated Emission below or equal 1GHz**

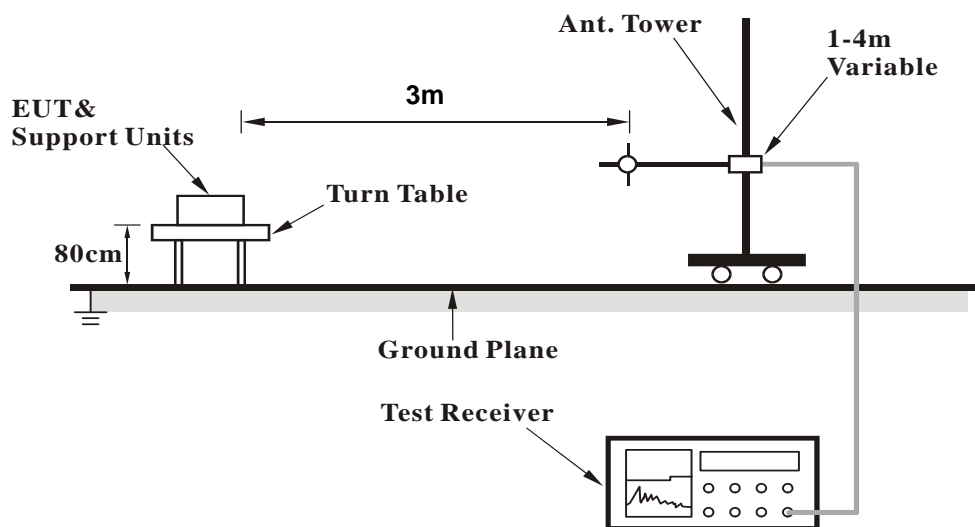

**For Radiated Emission above 1GHz**

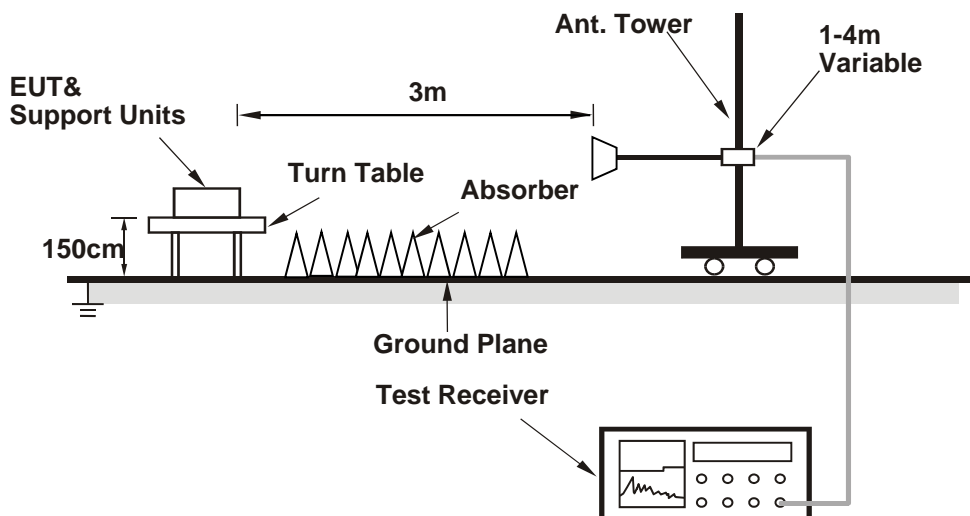

For the actual test configuration, please refer to the attached file (Test Setup Photo).

Conducted Power Measurement:

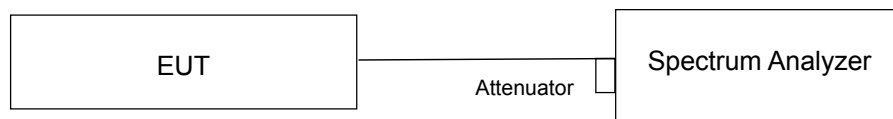

For the actual test configuration, please refer to the attached file (Test Setup Photo).

#### 4.1.4 Test Results

##### Conducted Power For NB-IoT Guard Band:

For 1TX:

Band / BW	Chain	QPSK_IoT Signal at bottom			QPSK_IoT Signal at top		
		Low	Mid	High	Low	Mid	High
		874.0	881.5	889.0	874.0	881.5	889.0
		MHz	MHz	MHz	MHz	MHz	MHz
5 / 10M	0	37.30	37.30	37.56	37.25	37.30	37.28
	1	37.25	37.32	37.44	37.23	37.25	37.15
	2	37.24	37.41	37.55	37.55	37.49	37.51
	3	37.40	37.35	<b>37.60</b>	37.59	37.48	<b>37.62</b>

For 2TX:

Band / BW	Chain	QPSK_IoT Signal at bottom			QPSK_IoT Signal at top		
		Low	Mid	High	Low	Mid	High
		874.0	881.5	889.0	874.0	881.5	889.0
		MHz	MHz	MHz	MHz	MHz	MHz
5 / 10M	0+1	40.29	40.32	40.51	40.25	40.29	40.23
	2+3	40.33	40.39	40.59	40.58	40.50	40.58

For 3TX:

Band / BW	Chain	QPSK_IoT Signal at bottom			QPSK_IoT Signal at top		
		Low	Mid	High	Low	Mid	High
		874.0	881.5	889.0	874.0	881.5	889.0
		MHz	MHz	MHz	MHz	MHz	MHz
5 / 10M	0+1+2	42.03	42.11	42.29	42.12	42.12	42.09

For 4TX:

Band / BW	Chain	QPSK_IoT Signal at bottom			QPSK_IoT Signal at top		
		Low	Mid	High	Low	Mid	High
		874.0	881.5	889.0	874.0	881.5	889.0
		MHz	MHz	MHz	MHz	MHz	MHz
5 / 10M	0+1+2+3	43.32	43.37	43.56	43.43	43.40	43.41

**For NB-IoT In-Band:**

**For 1TX:**

Band / BW	Chain	QPSK_IoT Signal at bottom			QPSK_IoT Signal at top		
		Low	Mid	High	Low	Mid	High
		874.0	881.5	889.0	874.0	881.5	889.0
		MHz	MHz	MHz	MHz	MHz	MHz
5 / 10M	0	37.96	37.87	37.75	37.40	37.95	37.82
	1	38.07	38.07	38.05	37.56	37.95	37.82
	2	38.26	37.82	38.30	37.85	38.05	37.96
	3	38.22	37.84	38.27	37.79	37.49	37.90

**For 2TX:**

Band / BW	Chain	QPSK_IoT Signal at bottom			QPSK_IoT Signal at top		
		Low	Mid	High	Low	Mid	High
		874.0	881.5	889.0	874.0	881.5	889.0
		MHz	MHz	MHz	MHz	MHz	MHz
5 / 10M	0+1	41.03	40.98	40.91	40.49	40.96	40.83
	2+3	41.25	40.84	41.30	40.83	40.79	40.94

**For 3TX:**

Band / BW	Chain	QPSK_IoT Signal at bottom			QPSK_IoT Signal at top		
		Low	Mid	High	Low	Mid	High
		874.0	881.5	889.0	874.0	881.5	889.0
		MHz	MHz	MHz	MHz	MHz	MHz
5 / 10M	0+1+2	42.87	42.69	42.81	42.38	42.75	42.64

**For 4TX:**

Band / BW	Chain	QPSK_IoT Signal at bottom			QPSK_IoT Signal at top		
		Low	Mid	High	Low	Mid	High
		874.0	881.5	889.0	874.0	881.5	889.0
		MHz	MHz	MHz	MHz	MHz	MHz
5 / 10M	0+1+2+3	44.15	43.92	44.12	43.67	43.89	43.90



**ERP Power  
For NB-IoT Guard Band:**

For 1TX:

Band / BW	Chain	QPSK_IoT Signal at bottom			QPSK_IoT Signal at top		
		Low	Mid	High	Low	Mid	High
		874.0	881.5	889.0	874.0	881.5	889.0
		MHz	MHz	MHz	MHz	MHz	MHz
5 / 10M	0	43.15	43.15	43.41	43.10	43.15	43.13
	1	43.10	43.17	43.29	43.08	43.10	43.00
	2	43.09	43.26	43.40	43.40	43.34	43.36
	3	43.25	43.20	43.45	43.44	43.33	43.47

For 2TX:

Band / BW	Chain	QPSK_IoT Signal at bottom			QPSK_IoT Signal at top		
		Low	Mid	High	Low	Mid	High
		874.0	881.5	889.0	874.0	881.5	889.0
		MHz	MHz	MHz	MHz	MHz	MHz
5 / 10M	0+1	46.14	46.17	46.36	46.10	46.14	46.08
	2+3	46.18	46.24	46.44	46.43	46.35	46.43

For 3TX:

Band / BW	Chain	QPSK_IoT Signal at bottom			QPSK_IoT Signal at top		
		Low	Mid	High	Low	Mid	High
		874.0	881.5	889.0	874.0	881.5	889.0
		MHz	MHz	MHz	MHz	MHz	MHz
5 / 10M	0+1+2	47.88	47.96	48.14	47.97	47.97	47.94

For 4TX:

Band / BW	Chain	QPSK_IoT Signal at bottom			QPSK_IoT Signal at top		
		Low	Mid	High	Low	Mid	High
		874.0	881.5	889.0	874.0	881.5	889.0
		MHz	MHz	MHz	MHz	MHz	MHz
5 / 10M	0+1+2+3	49.17	49.22	<b>49.41</b>	49.28	49.25	49.26

Note:

1. ERP (dBm) = Conducted Output Power (dBm) + antenna gain (dBi) – 2.15.
2. The 2TX MIMO power was select worst 2 chain total calculation.
3. The 3TX MIMO power was select worst 3 chain total calculation.

**For NB-IoT In-Band:**

**For 1TX:**

Band / BW	Chain	QPSK_IoT Signal at bottom			QPSK_IoT Signal at top		
		Low	Mid	High	Low	Mid	High
		874.0	881.5	889.0	874.0	881.5	889.0
		MHz	MHz	MHz	MHz	MHz	MHz
5 / 10M	0	43.81	43.72	43.60	43.25	43.80	43.67
	1	43.92	43.92	43.90	43.41	43.80	43.67
	2	44.11	43.67	44.15	43.70	43.90	43.81
	3	44.07	43.69	44.12	43.64	43.34	43.75

**For 2TX:**

Band / BW	Chain	QPSK_IoT Signal at bottom			QPSK_IoT Signal at top		
		Low	Mid	High	Low	Mid	High
		874.0	881.5	889.0	874.0	881.5	889.0
		MHz	MHz	MHz	MHz	MHz	MHz
5 / 10M	0+1	46.88	46.83	46.76	46.34	46.81	46.68
	2+3	47.10	46.69	47.15	46.68	46.64	46.79

**For 3TX:**

Band / BW	Chain	QPSK_IoT Signal at bottom			QPSK_IoT Signal at top		
		Low	Mid	High	Low	Mid	High
		874.0	881.5	889.0	874.0	881.5	889.0
		MHz	MHz	MHz	MHz	MHz	MHz
5 / 10M	0+1+2	48.72	48.54	48.66	48.23	48.60	48.49

**For 4TX:**

Band / BW	Chain	QPSK_IoT Signal at bottom			QPSK_IoT Signal at top		
		Low	Mid	High	Low	Mid	High
		874.0	881.5	889.0	874.0	881.5	889.0
		MHz	MHz	MHz	MHz	MHz	MHz
5 / 10M	0+1+2+3	50.00	49.77	49.97	49.52	49.74	49.75

**Note:**

1. ERP (dBm) = Conducted Output Power (dBm) + antenna gain (dBi) – 2.15.
2. The 2TX MIMO power was select worst 2 chain total calculation.
3. The 3TX MIMO power was select worst 3 chain total calculation.

## 4.2 Modulation Characteristics Measurement

### 4.2.1 Limits of Modulation Characteristics

N/A

### 4.2.2 Test Procedure

Connect the EUT to Communication Simulator via the antenna connector, the frequency band is set as EUT supported Modulation and Channels, the EUT output is matched with 50 ohm load, the waveform quality and constellation of the EUT was tested.

### 4.2.3 Test Setup

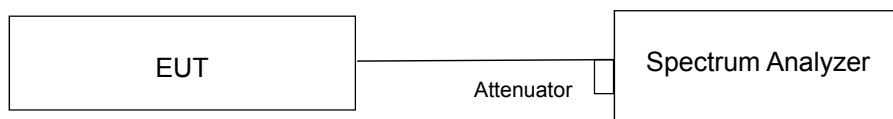

### 4.2.4 Test Results

#### For NB-IoT Guard Band:

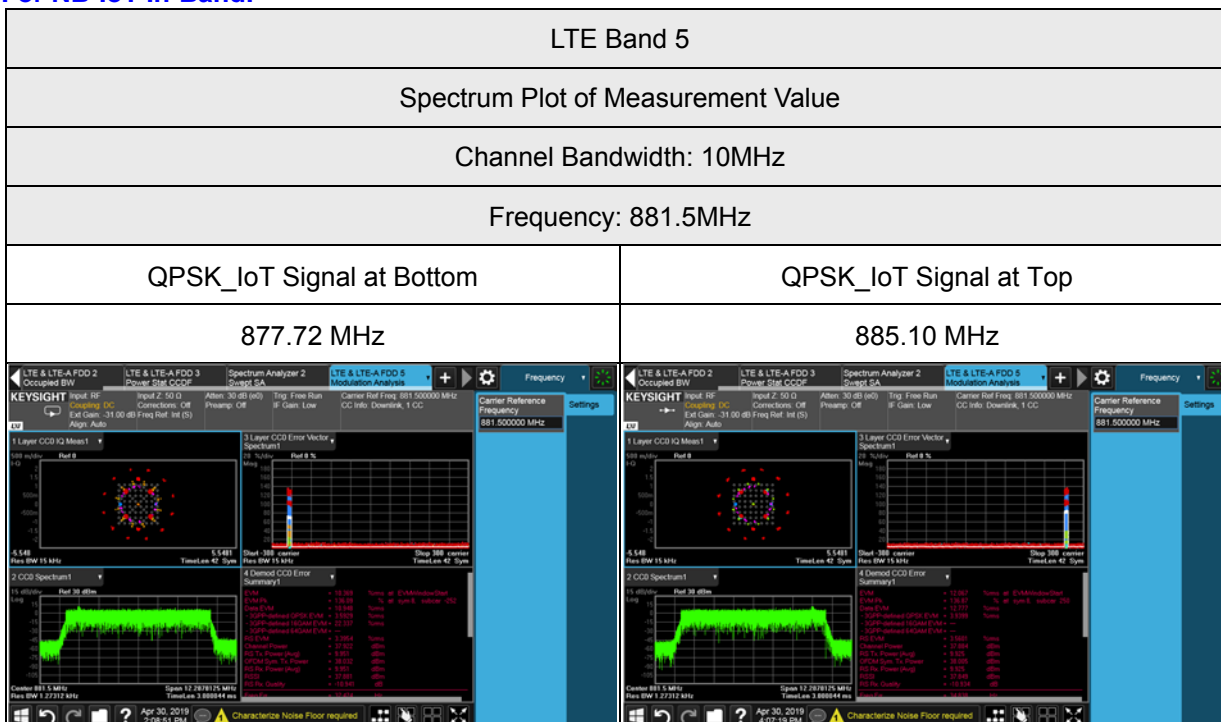
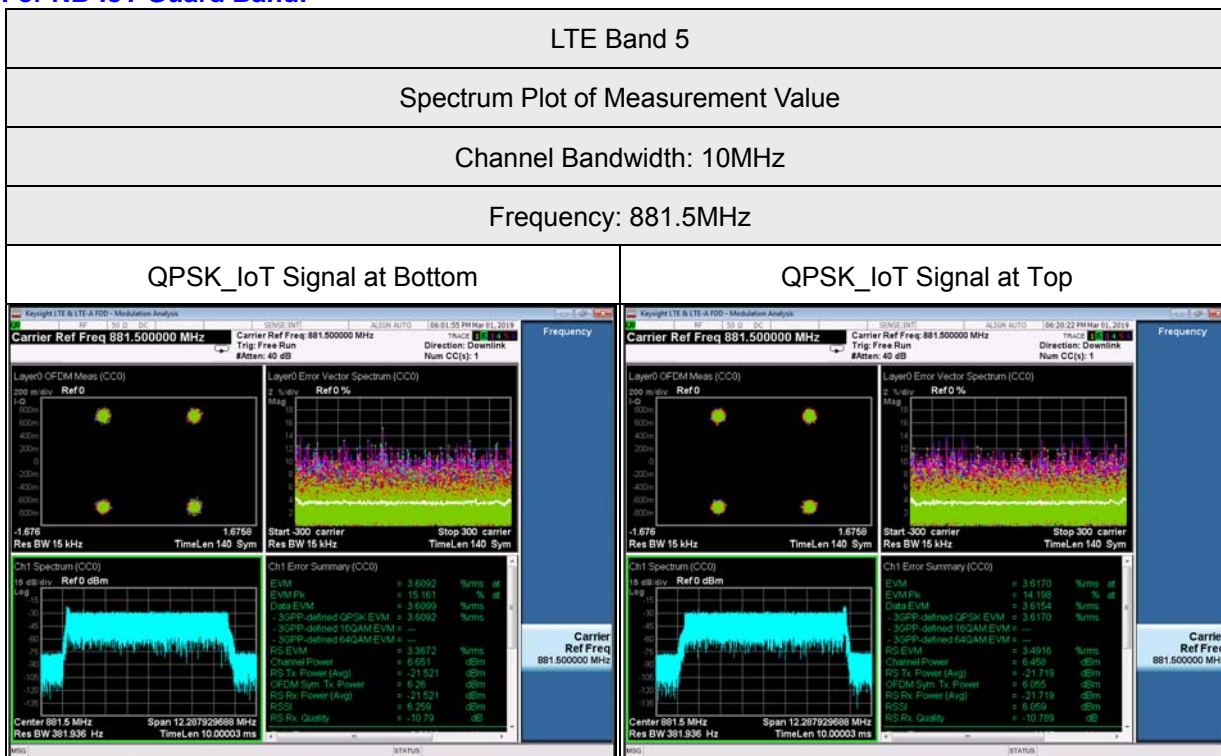

### 4.3 Frequency Stability Measurement

#### 4.3.1 Limits of Frequency Stability Measurement

1.5 ppm is for base and fixed station.

#### 4.3.2 Test Procedure

- Device is placed at the oven room. The oven room could control the temperatures and humidity. Power warm up is at least 15 min and power applied should perform before recording frequency error.
- EUT is connected the external power supply to control the DC input power. The test voltage range is from minimum to maximum working voltage. Each step shall be record the frequency error rate.
- The temperature range step is 10 degrees in this test items. All temperature levels shall be hold the  $\pm 0.5$  °C during the measurement testing. The each temperature step shall be at least 0.5 hours, consider the EUT could be test under the stability condition.

NOTE: The frequency error was recorded frequency error from the communication simulator.

#### 4.3.3 Test Setup

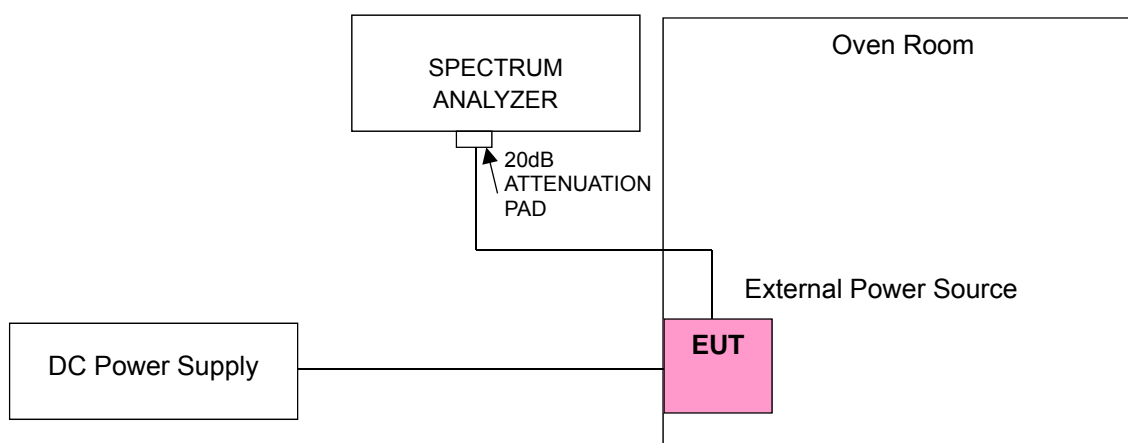

#### 4.3.4 Test Results

##### For NB-IoT Guard Band:

Frequency Error vs. Voltage

Voltage (Volts)	LTE Band 5
	Frequency error (ppm)
-62.1	0.02670
-54.0	0.03606
-45.9	0.03541

Note: The applicant defined the normal working voltage is from -45.9Vdc to -62.1Vdc.

TEMP. (°C)	LTE Band 5
	Frequency error (ppm)
50	0.02416
40	0.05660
30	0.06483
20	0.03606
10	0.01695
0	0.06419
-10	0.04883
-20	0.03887
-30	0.02840

**For NB-IoT In-Band:**

Frequency Error vs. Voltage

Voltage (Volts)	LTE Band 5
	Frequency error (ppm)
-62.1	0.001
-54.0	0.003
-45.9	0.004

Note: The applicant defined the normal working voltage is from -45.9Vdc to -62.1Vdc.

TEMP. (°C)	LTE Band 5
	Frequency error (ppm)
50	-0.001
40	-0.004
30	-0.004
20	-0.003
10	0.002
0	0.001
-10	0.001
-20	0.004
-30	0.004

## 4.4 Occupied Bandwidth Measurement

### 4.4.1 Test Procedure

The EUT makes a call to the communication simulator. All measurements were done at low, middle and high operational frequency range. The communication simulator station system controlled a EUT to export maximum output power under transmission mode and specific channel frequency. Use OBW measurement function of Spectrum analyzer to measure 99 % occupied bandwidth.

### 4.4.2 Test Setup

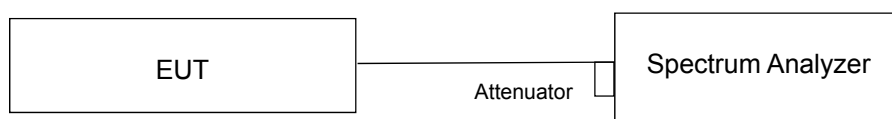



### 4.4.3 Test Result

#### For NB-IoT Guard Band:

Channel Bandwidth: 10MHz									
26dBc Bandwidth (MHz)									
QPSK_IoT Signal at bottom					QPSK_IoT Signal at top				
Freq. (MHz)	Chain 0	Chain 1	Chain 2	Chain 3	Freq. (MHz)	Chain 0	Chain 1	Chain 2	Chain 3
874.0	9.647	9.659	9.676	9.680	874.0	9.642	9.610	9.630	9.629
881.5	<b>9.684</b>	9.637	9.662	9.640	881.5	9.657	<b>9.681</b>	9.658	9.658
889.0	9.610	9.610	9.644	9.600	889.0	9.674	9.667	9.667	9.667

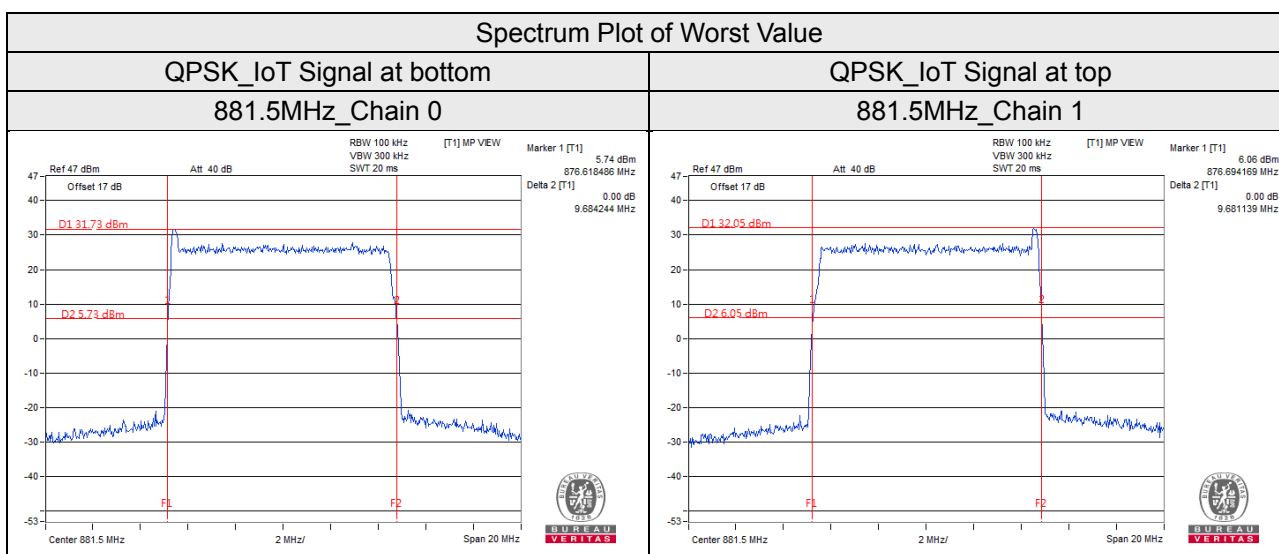

**For NB-IoT In-Band:**

Channel Bandwidth: 10MHz									
26dBc Bandwidth (MHz)									
QPSK_IoT Signal at bottom					QPSK_IoT Signal at top				
Freq. (MHz)	Chain 0	Chain 1	Chain 2	Chain 3	Freq. (MHz)	Chain 0	Chain 1	Chain 2	Chain 3
874.0	9.159	9.175	9.119	9.167	874.0	9.144	9.176	9.215	9.167
881.5	9.248	<b>9.299</b>	9.266	9.239	881.5	9.218	9.341	9.244	9.221
889.0	9.244	9.227	9.235	9.263	889.0	9.269	<b>9.342</b>	9.235	9.303

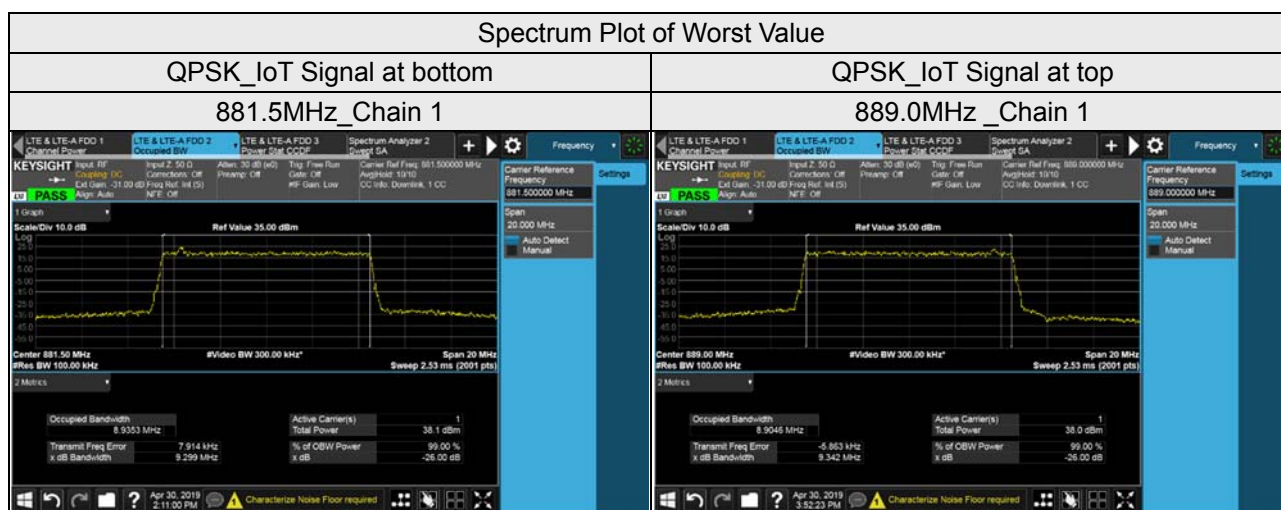

**For NB-IoT Guard Band:**

Channel Bandwidth: 10MHz									
Occupied Bandwidth (MHz)									
QPSK_IoT Signal at bottom					QPSK_IoT Signal at top				
Freq. (MHz)	Chain 0	Chain 1	Chain 2	Chain 3	Freq. (MHz)	Chain 0	Chain 1	Chain 2	Chain 3
874.0	9.20	9.20	9.16	9.20	874.0	9.16	9.16	9.16	9.16
881.5	9.20	9.16	9.20	9.20	881.5	9.16	9.20	9.20	9.20
889.0	9.16	9.16	9.16	9.16	889.0	9.20	9.20	9.20	9.16

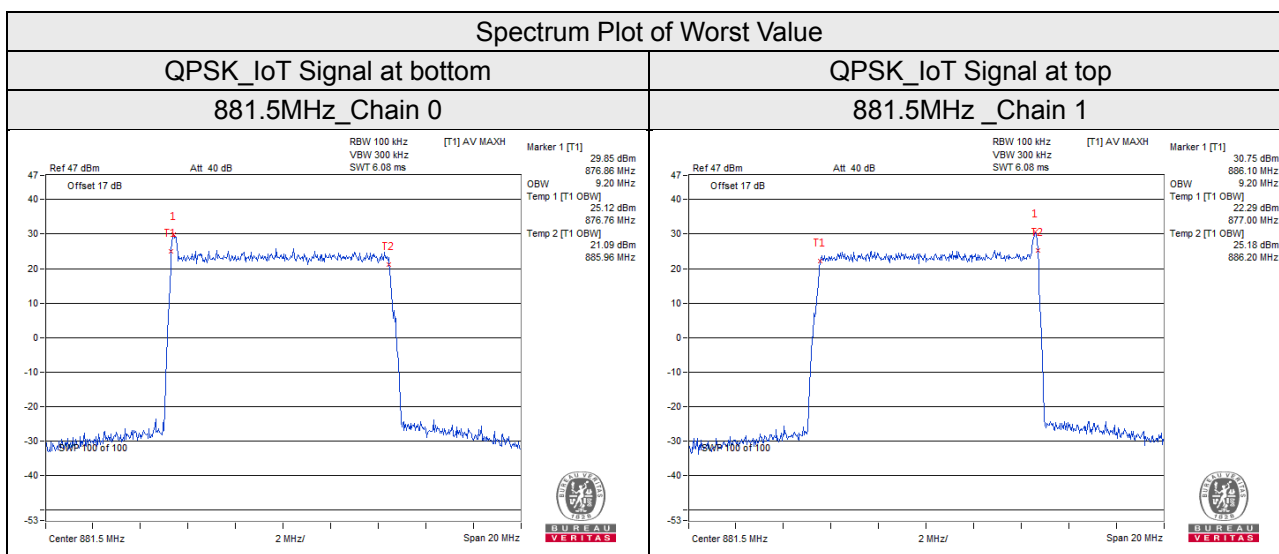

**For NB-IoT In-Band:**

Channel Bandwidth: 10MHz									
Occupied Bandwidth (MHz)									
QPSK_IoT Signal at bottom					QPSK_IoT Signal at top				
Freq. (MHz)	Chain 0	Chain 1	Chain 2	Chain 3	Freq. (MHz)	Chain 0	Chain 1	Chain 2	Chain 3
874.0	8.9219	8.9199	8.9197	8.9247	874.0	8.9217	8.9190	8.9200	8.9135
881.5	8.9190	8.9353	8.9269	<b>8.9488</b>	881.5	8.9208	8.9234	8.9220	8.9391
889.0	8.9316	8.9110	8.9066	8.9212	889.0	8.9147	8.9046	<b>8.9440</b>	8.9328

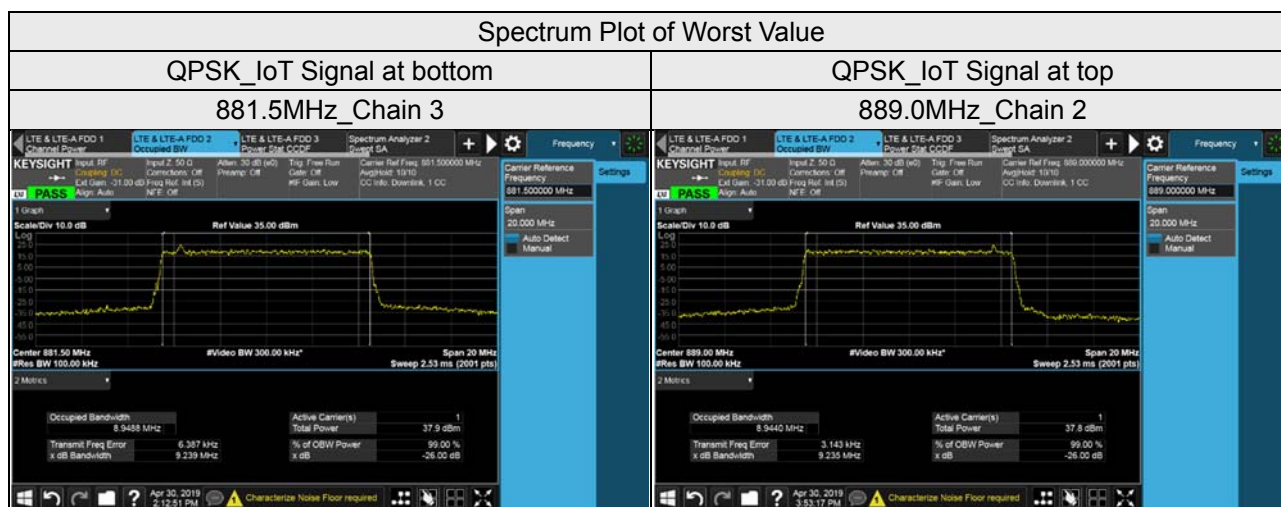

## 4.5 Band Edge Measurement

### 4.5.1 Limits of Band Edge Measurement

Power of any emission outside of the authorized operating frequency ranges must be attenuated below the transmitting power (P) by a factor of at least  $43 + 10 \log(P)$  dB. In the 1 MHz bands immediately outside and adjacent to the frequency block a resolution bandwidth of at least one percent of the emission bandwidth of the fundamental emission of the transmitter may be employed.

Note: The device has 4x4 MIMO function, so the limit of spurious emissions needs to be reduced by  $-13 - 10 \cdot \log(4) = -19.02$  dBm according to FCC KDB 662911 D01 guidance.

### 4.5.2 Test Setup

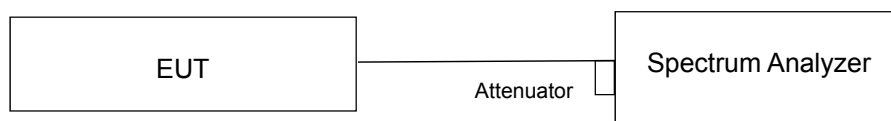

### 4.5.3 Test Procedures

- All measurements were done at low and high operational frequency range.
- The center frequency of spectrum is the band edge frequency and span is 1.5MHz. RB of the spectrum is 100kHz and VB of the spectrum is 300kHz (LTE Channel Bandwidth 10MHz).
- Record the max trace plot into the test report.

### 4.5.4 Test Results

For NB-IoT Guard Band:  
QPSK\_IoT Signal at Bottom

Chain 0

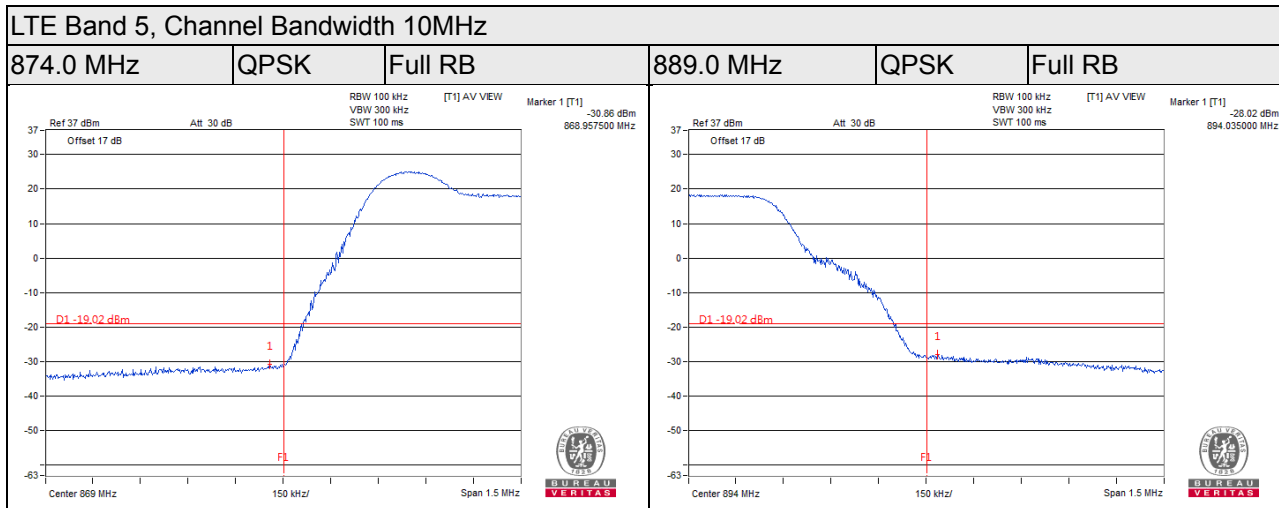

Chain 1

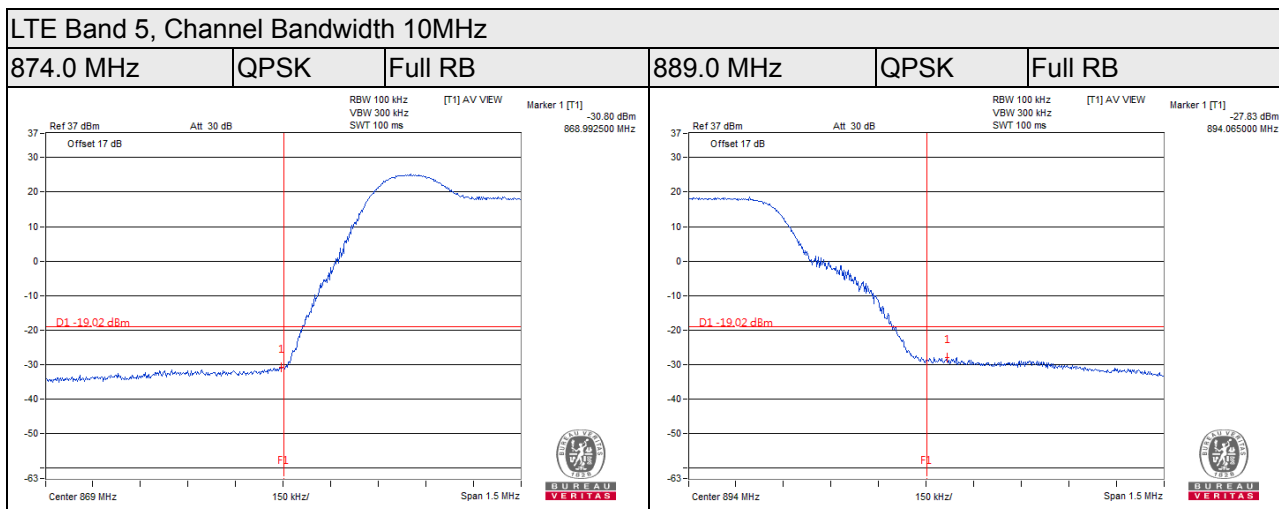

### Chain 2

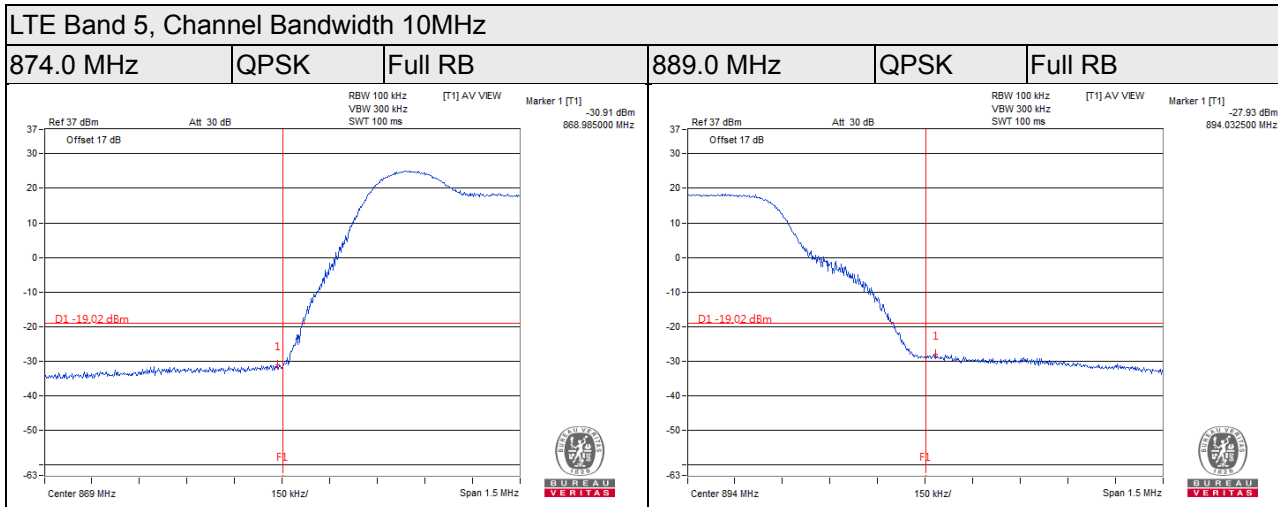

### Chain 3

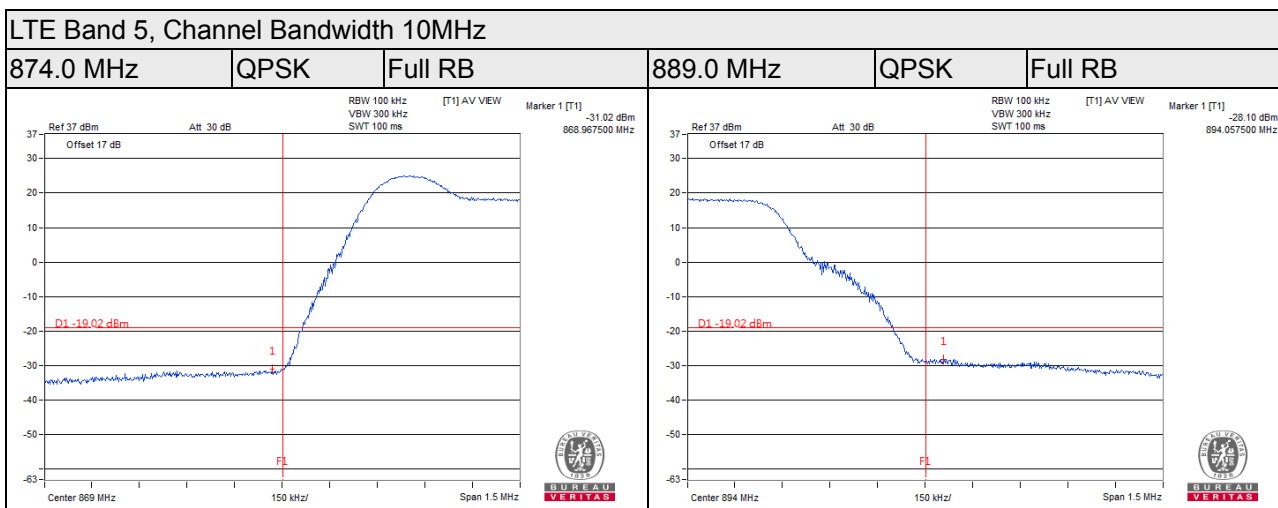

## QPSK\_IoT Signal at Top

### Chain 0

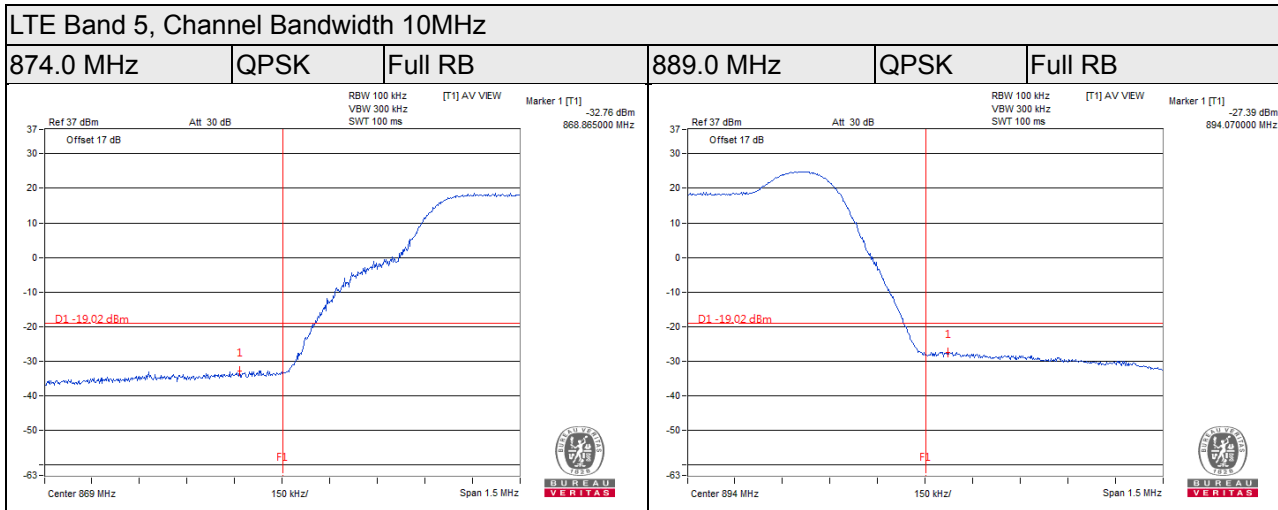

### Chain 1

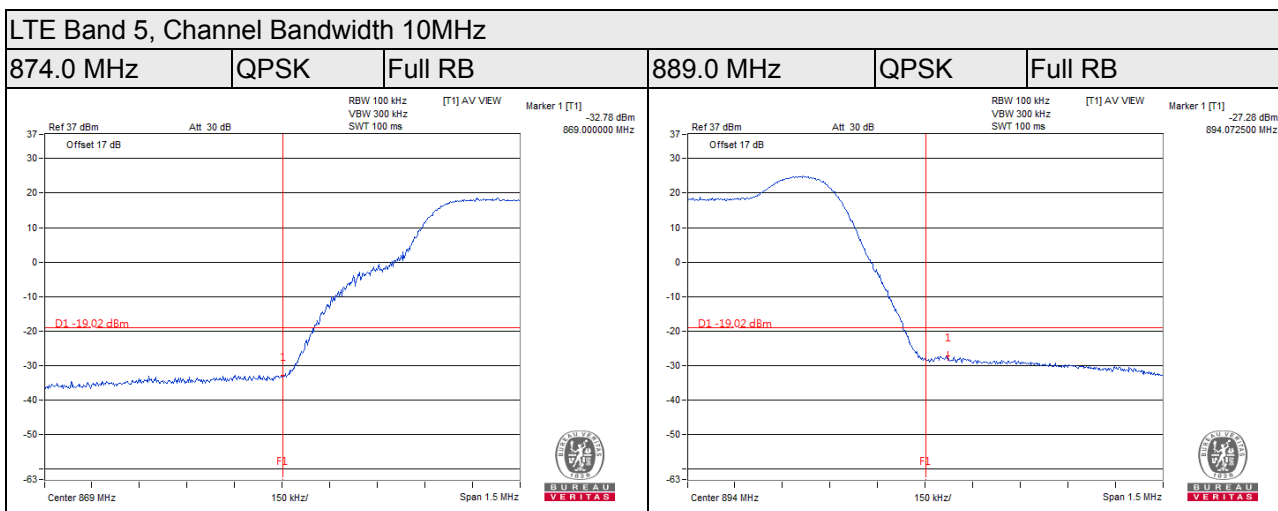



### Chain 2

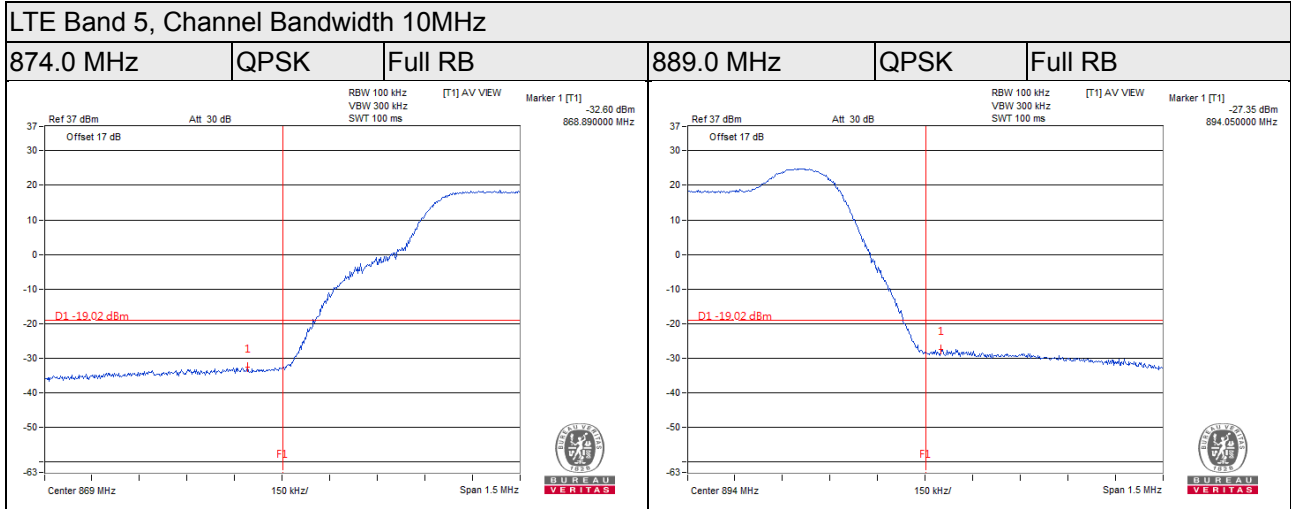

### Chain 3

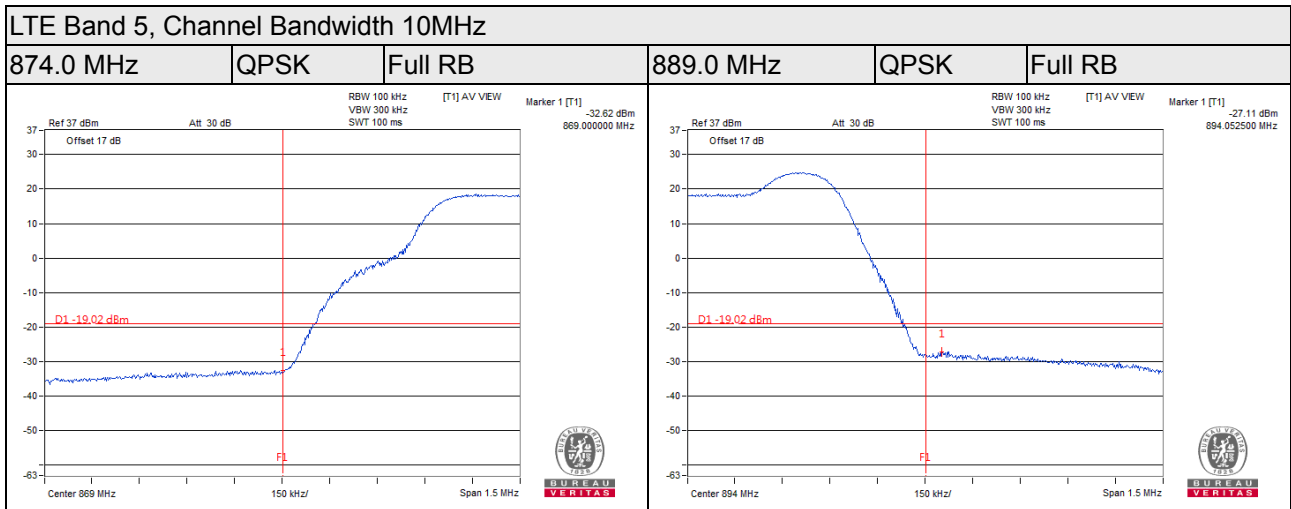

**For NB-IoT In-Band:  
QPSK\_IoT Signal at Bottom**

Chain 0

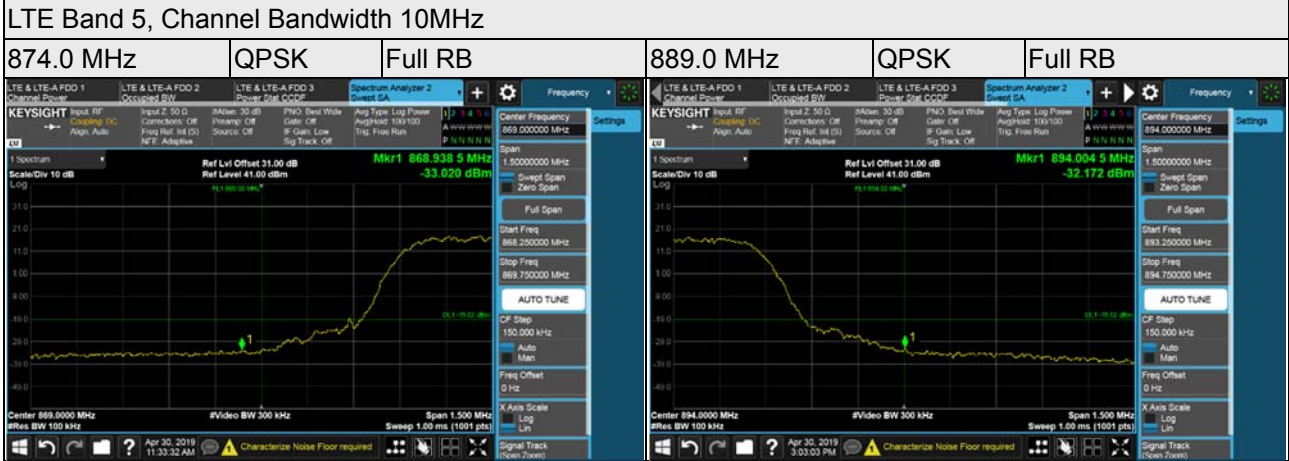

Chain 1

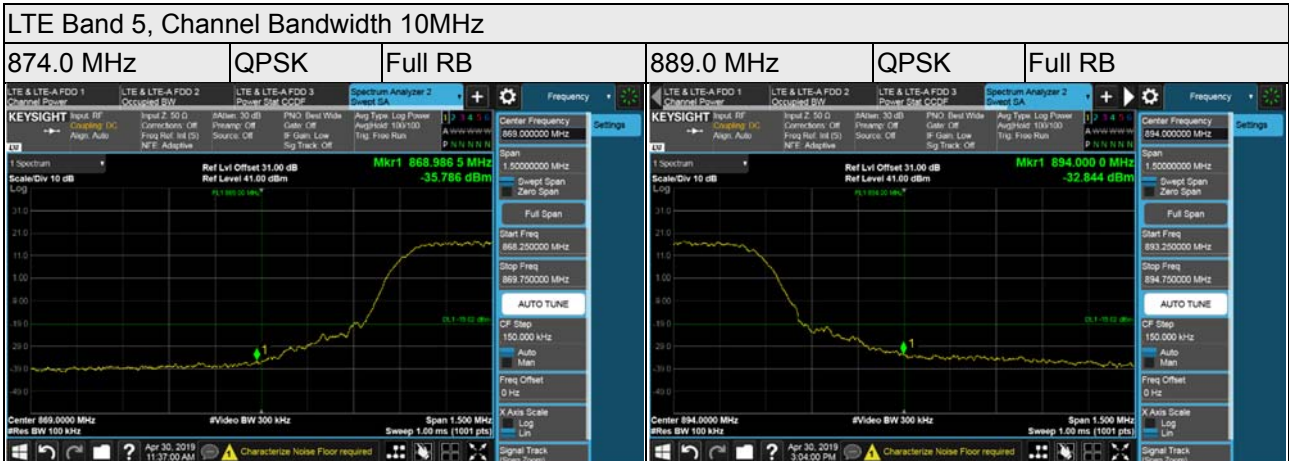

Chain 2

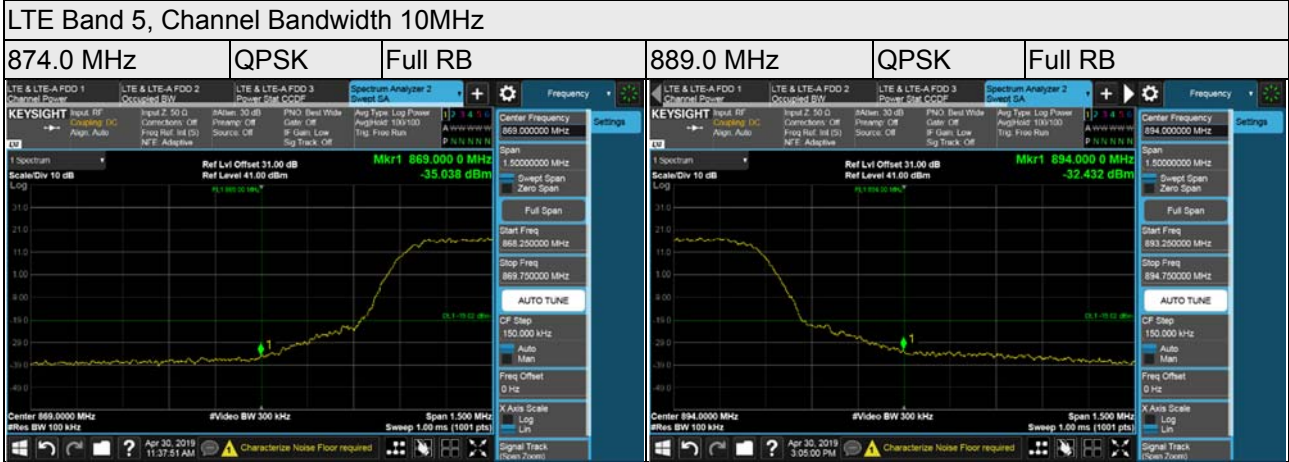

Chain 3

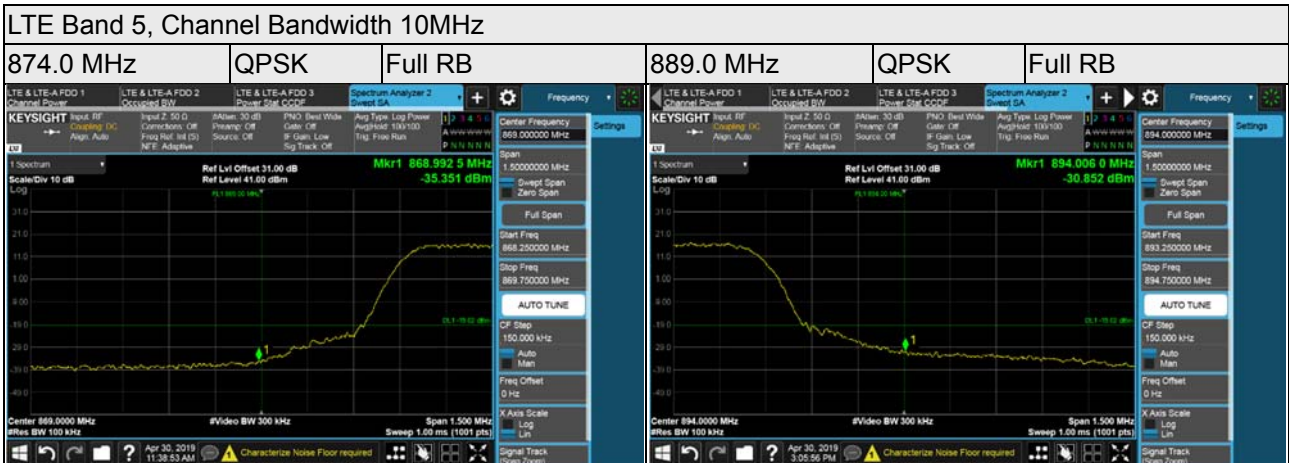

## QPSK\_IoT Signal at Top

### Chain 0

LTE Band 5, Channel Bandwidth 10MHz

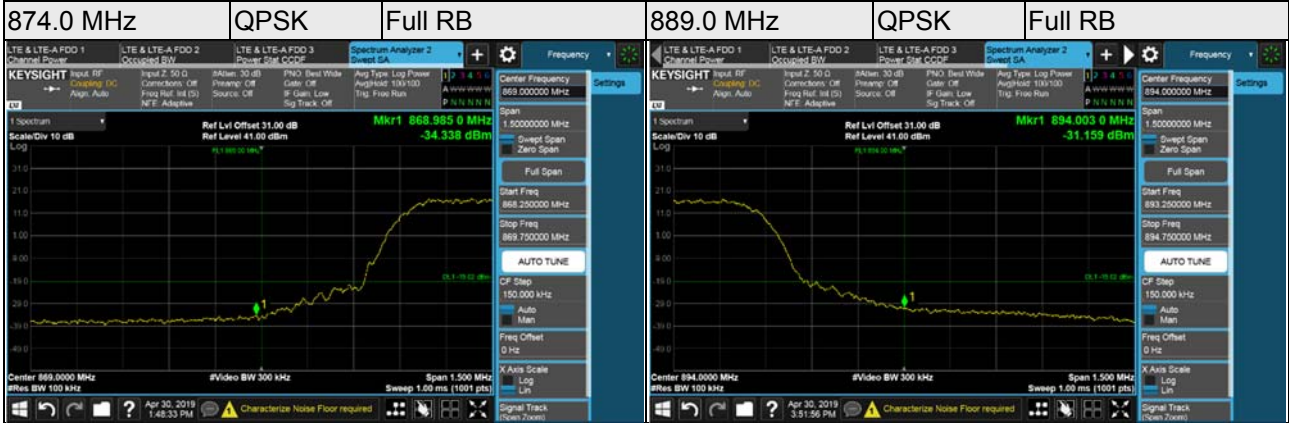

### Chain 1

LTE Band 5, Channel Bandwidth 10MHz



### Chain 2

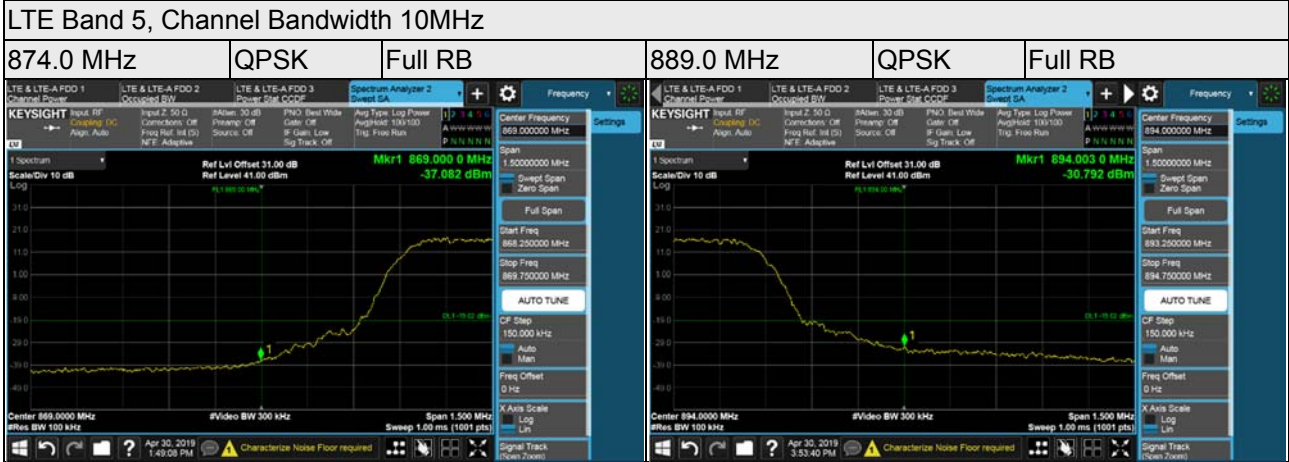

### Chain 3

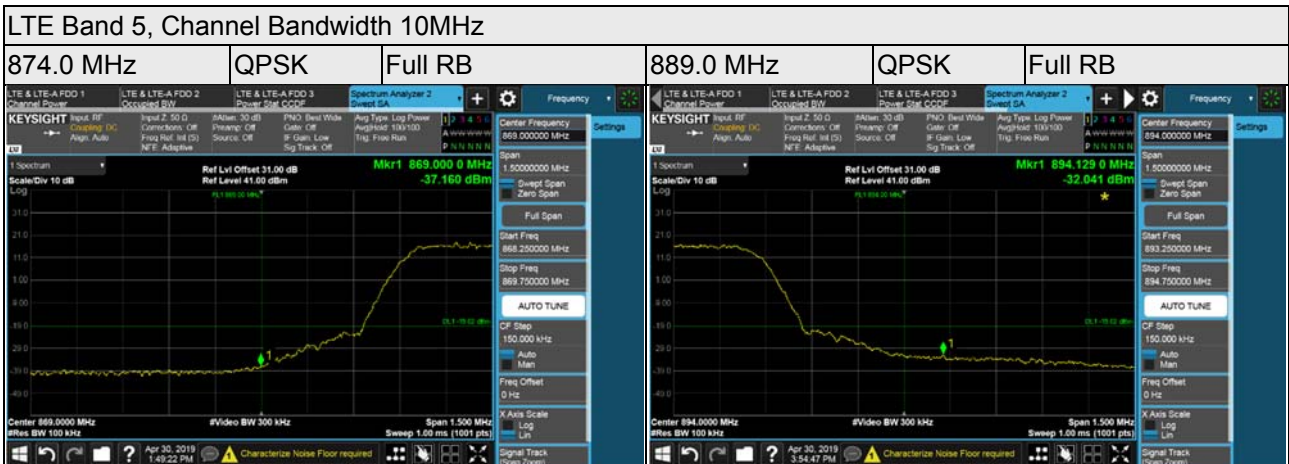



## 4.6 Peak to Average Ratio

### 4.6.1 Limits of Peak to Average Ratio Measurement

In measuring transmissions in this band using an average power technique, the peak to-average ratio (PAR) of the transmission may not exceed 13 dB

### 4.6.2 Test Setup

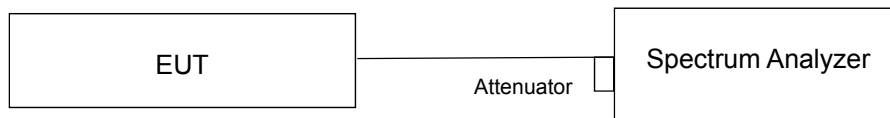

### 4.6.3 Test Procedures

- Set resolution/measurement bandwidth  $\geq$  signal's occupied bandwidth;
- Set the number of counts to a value that stabilizes the measured CCDF curve;
- Record the maximum PAPR level associated with a probability of 0.1%.

#### 4.6.4 Test Results

For NB-IoT Guard Band:  
QPSK\_IoT Signal at Bottom

LTE Band 5, Channel Bandwidth 10MHz				
Frequency (MHz)	Peak To Average Ratio (dB)			
	Chain 0	Chain 1	Chain 2	Chain 3
874.0	7.43	7.42	7.43	7.42
881.5	7.21	7.20	7.20	7.20
889.0	7.37	7.37	7.38	7.37

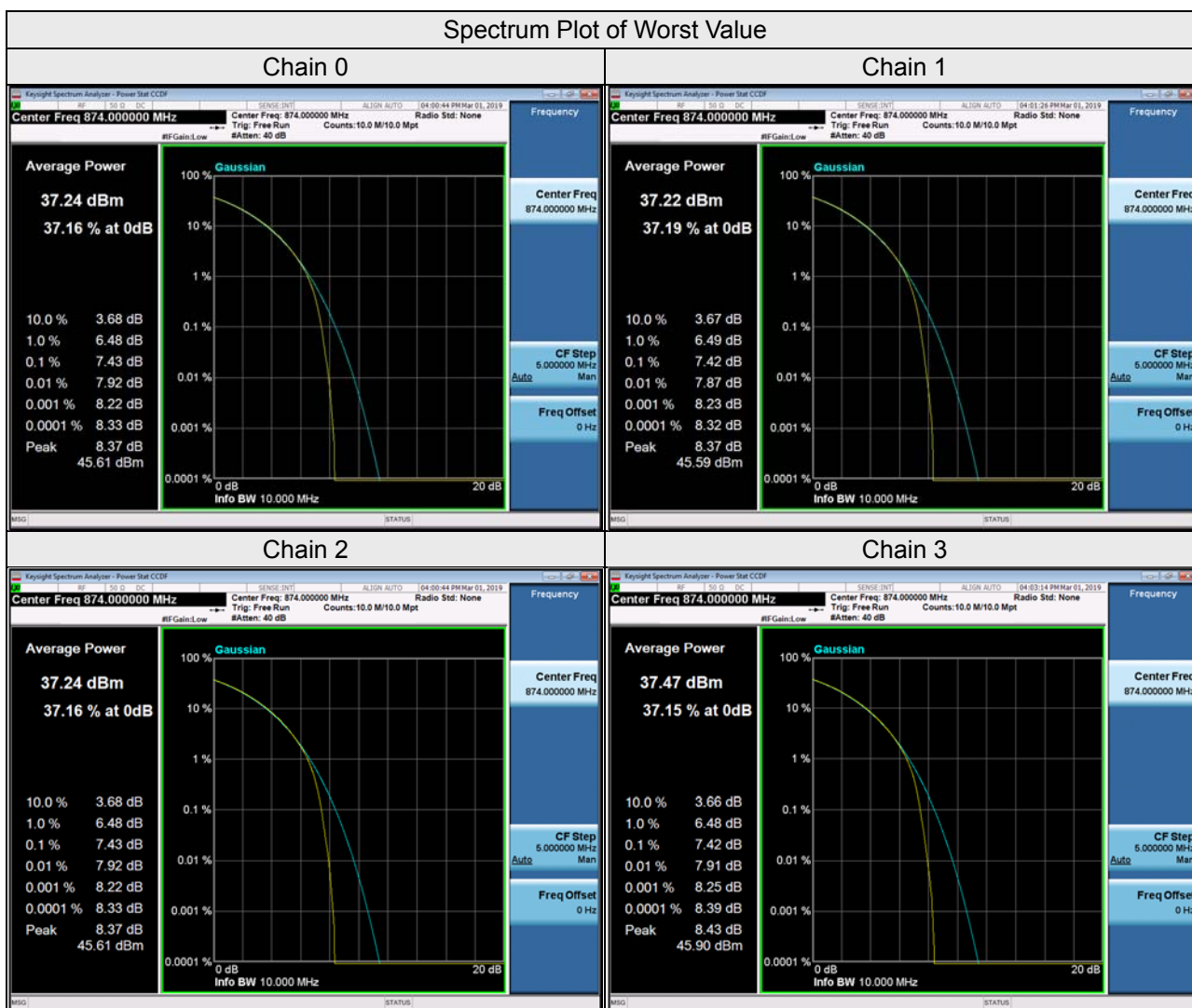

QPSK\_IoT Signal at Top

LTE Band 5, Channel Bandwidth 10MHz				
Frequency (MHz)	Peak To Average Ratio (dB)			
	Chain 0	Chain 1	Chain 2	Chain 3
874.0	7.43	7.41	7.44	7.42
881.5	7.20	7.20	7.20	7.20
889.0	7.38	7.38	7.37	7.37

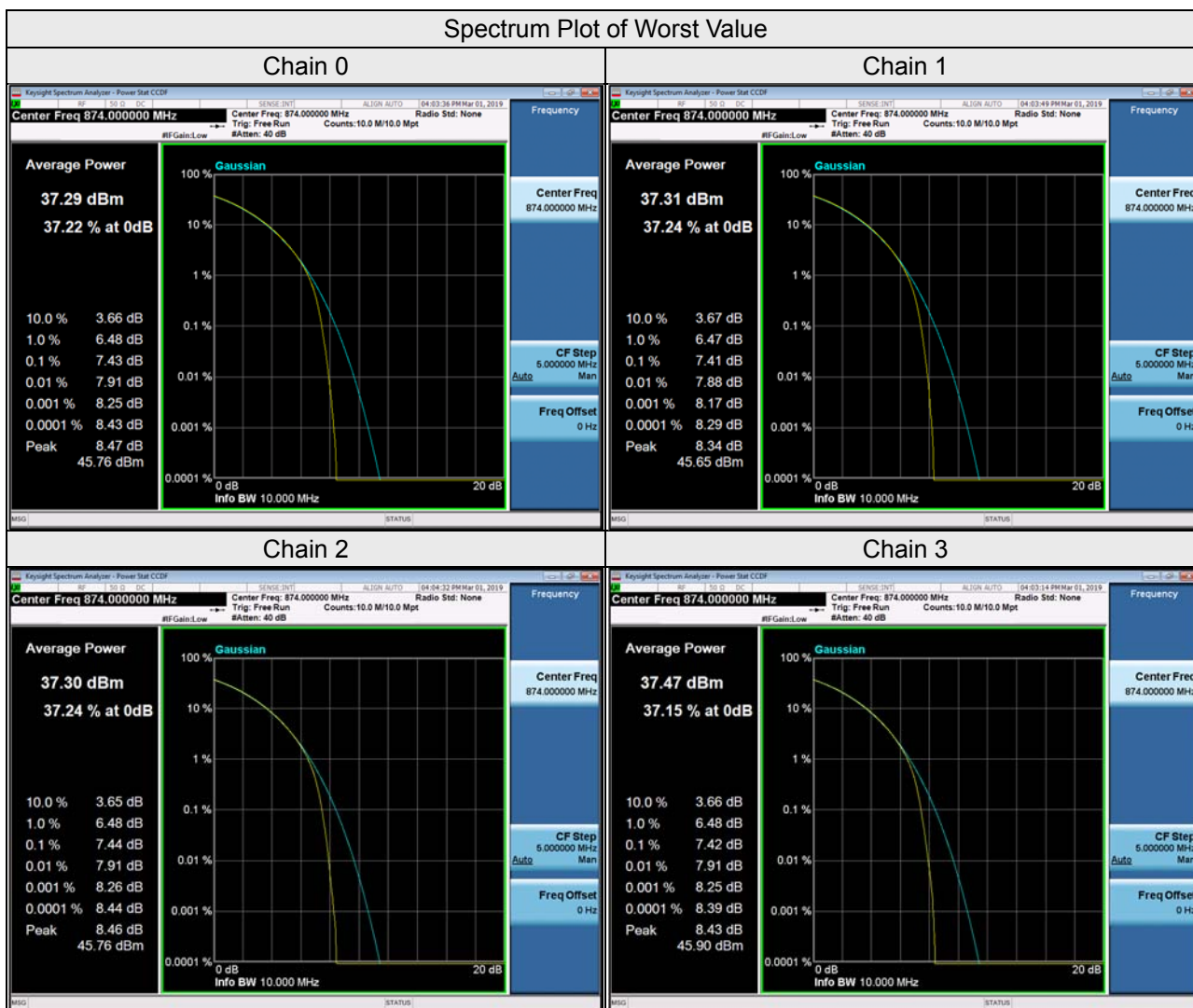



**For NB-IoT In-Band:  
QPSK\_IoT Signal at Bottom**

LTE Band 5, Channel Bandwidth 10MHz				
Frequency (MHz)	Peak To Average Ratio (dB)			
	Chain 0	Chain 1	Chain 2	Chain 3
874.0	7.47	7.45	7.49	7.49
881.5	7.33	7.32	7.33	7.34
889.0	7.45	7.45	7.45	7.46

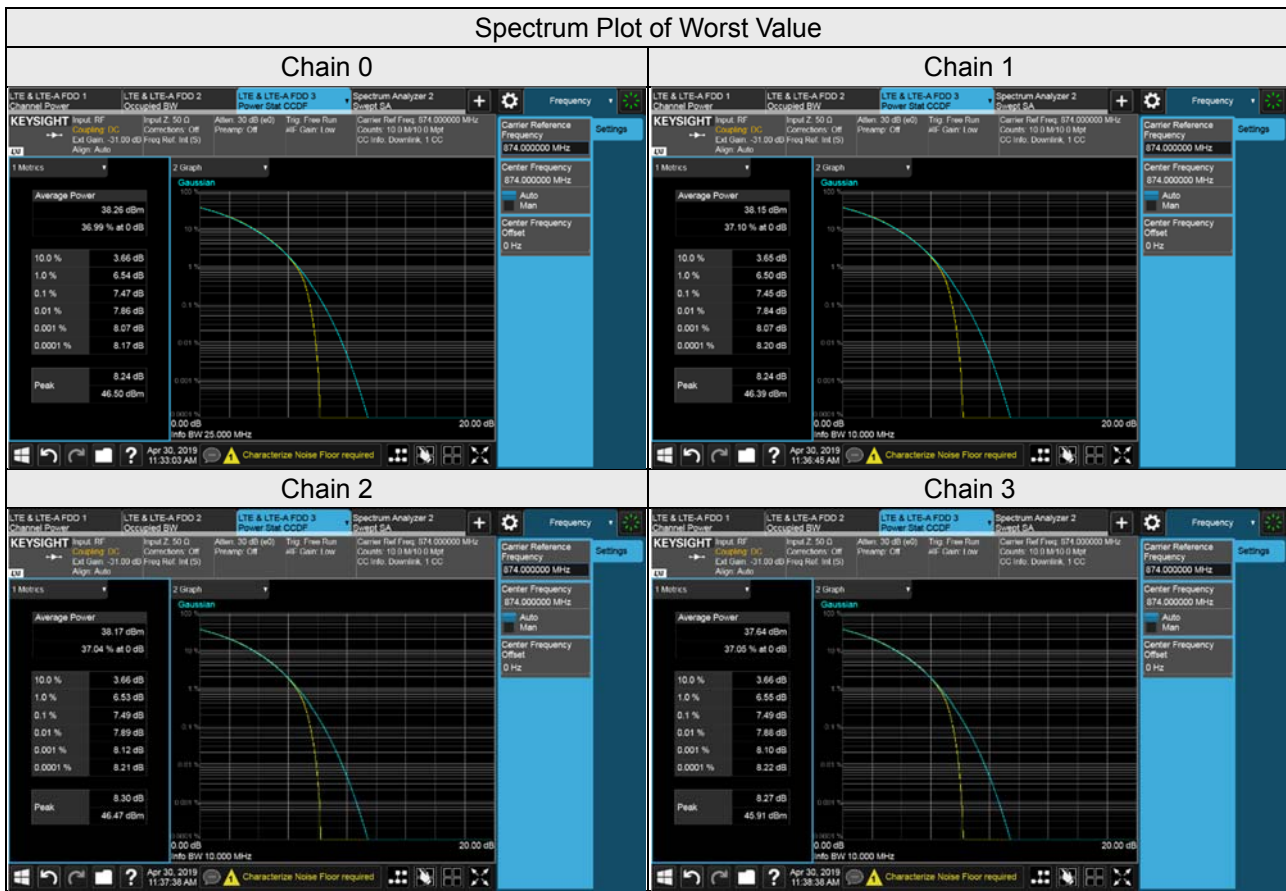

### QPSK\_IoT Signal at Top

LTE Band 5, Channel Bandwidth 10MHz				
Frequency (MHz)	Peak To Average Ratio (dB)			
	Chain 0	Chain 1	Chain 2	Chain 3
874.0	7.45	7.47	7.49	7.44
881.5	7.34	7.31	7.32	7.31
889.0	7.49	7.49	7.50	7.48

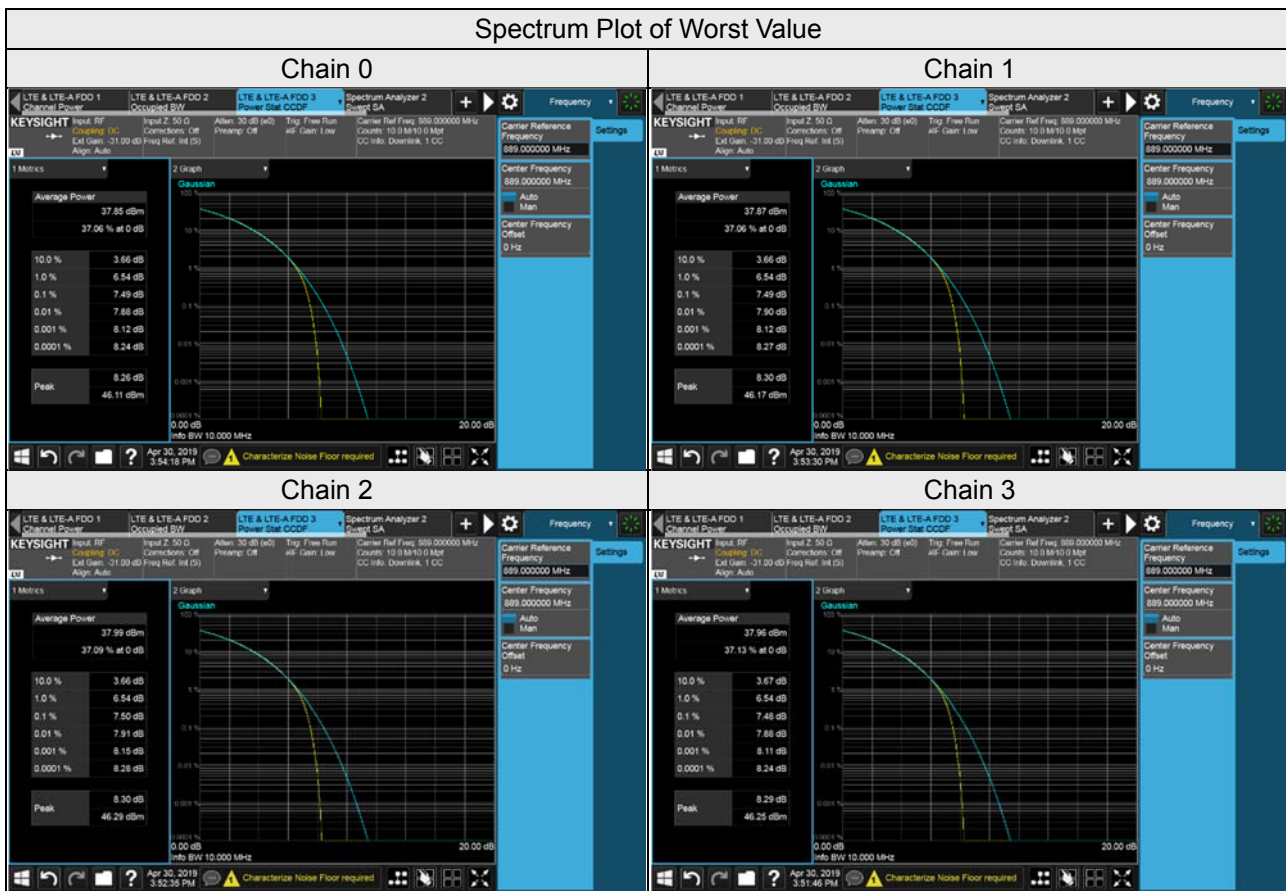

## 4.7 Conducted Spurious Emissions

### 4.7.1 Limits of Conducted Spurious Emissions Measurement

The power of any emission outside of the authorized operating frequency ranges must be attenuated below the transmitting power (P) by a factor of at least  $43 + 10 \log(P)$  dB.

Note: The device has 4x4 MIMO function, so the limit of spurious emissions needs to be reduced by  $-13 - 10 \cdot \log(4) = -19.02$  dBm according to FCC KDB 662911 D01 guidance.

### 4.7.2 Test Setup

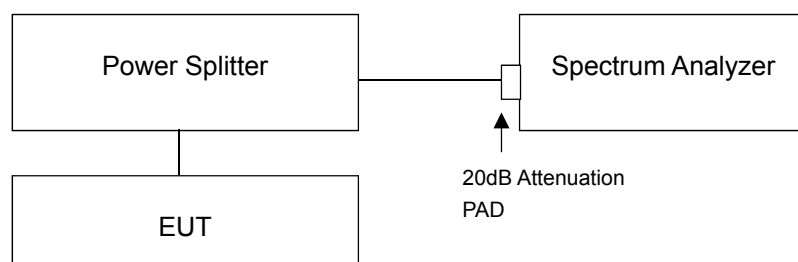

### 4.7.3 Test Procedure

- The EUT makes a phone call to the communication simulator. All measurements were done at low, middle and high operational frequency range.
- Measuring frequency range is from 9 kHz to 1GHz. 20dB attenuation pad is connected with spectrum. RBW= 300kHz and VBW= 1MHz is used for conducted emission measurement.
- Measuring frequency range is from 1GHz to 26.5GHz. 20dB attenuation pad is connected with spectrum. RBW= 1MHz and VBW= 3MHz is used for conducted emission measurement.

### 4.7.4 Test Results

For NB-IoT Guard Band:  
QPSK\_IoT Signal at Bottom

Chain 0

LTE Band 5, Channel Bandwidth 10MHz

874.0MHz

Frequency Range : 9kHz~1GHz

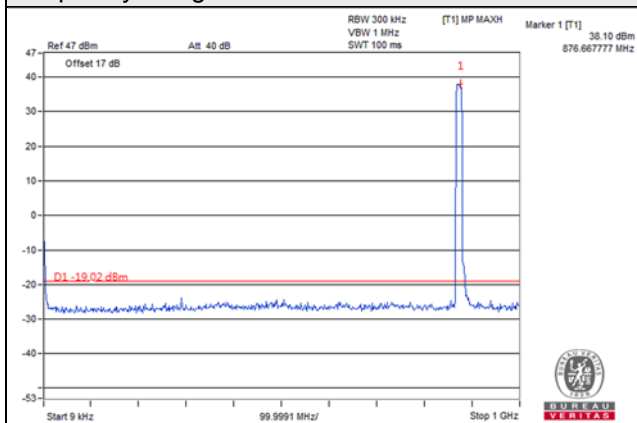

Frequency Range : 1GHz~10GHz

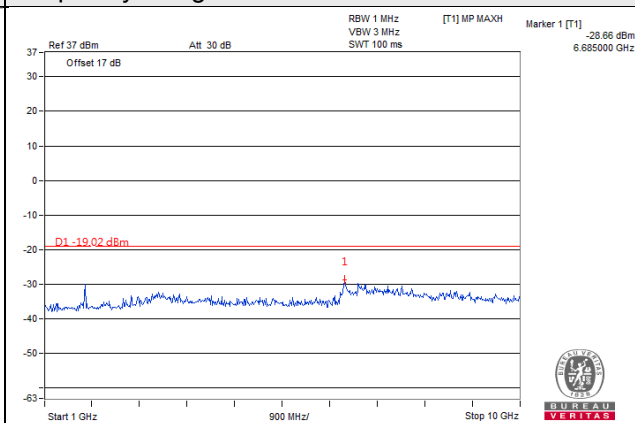

Frequency Range : 10GHz~26.5GHz

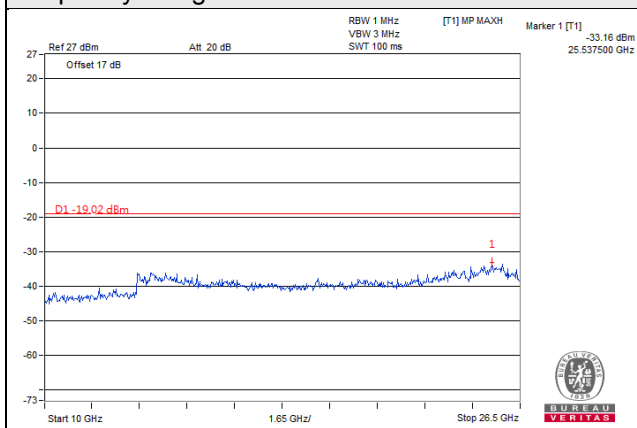

LTE Band 5, Channel Bandwidth 10MHz

881.5MHz

Frequency Range : 9kHz~1GHz

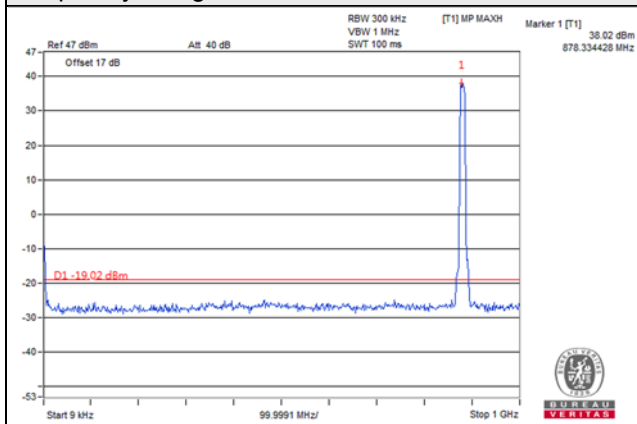

Frequency Range : 1GHz~10GHz

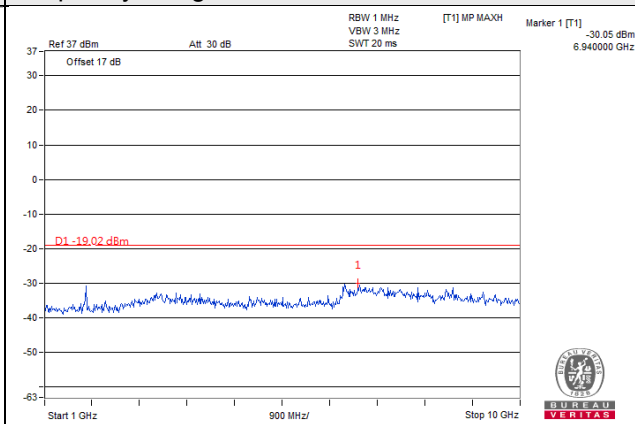

Frequency Range : 10GHz~26.5GHz

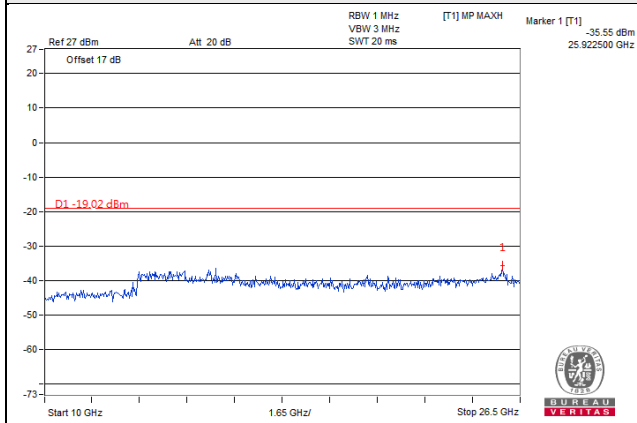

LTE Band 5, Channel Bandwidth 10MHz

889.0MHz

Frequency Range : 9kHz~1GHz

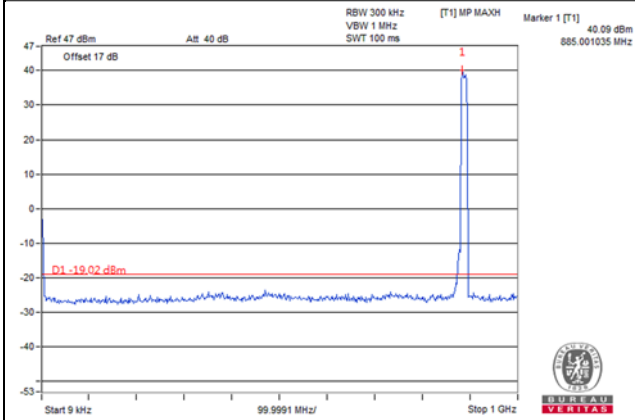

Frequency Range : 1GHz~10GHz

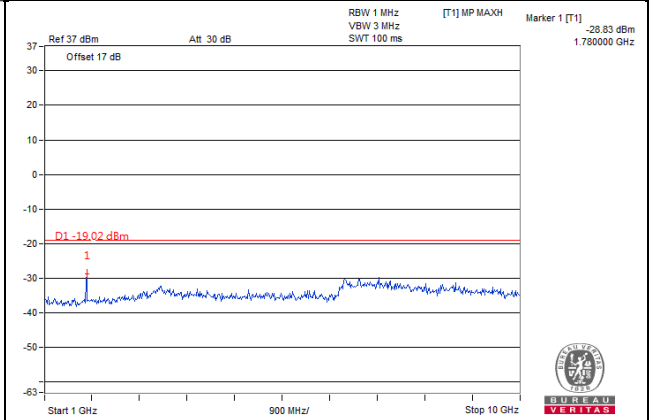

Frequency Range : 10GHz~26.5GHz

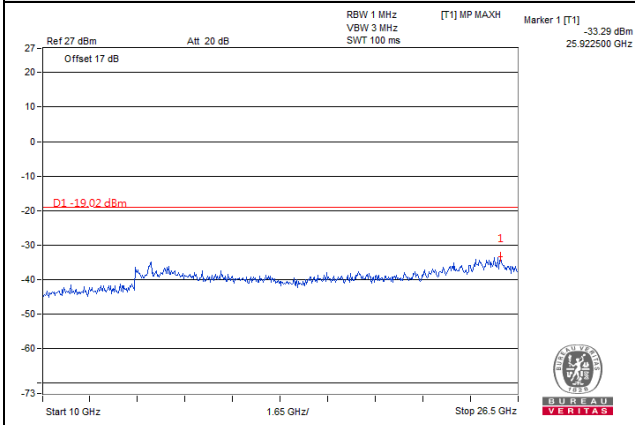

Chain 1

LTE Band 5, Channel Bandwidth 10MHz

874.0MHz

Frequency Range : 9kHz~1GHz

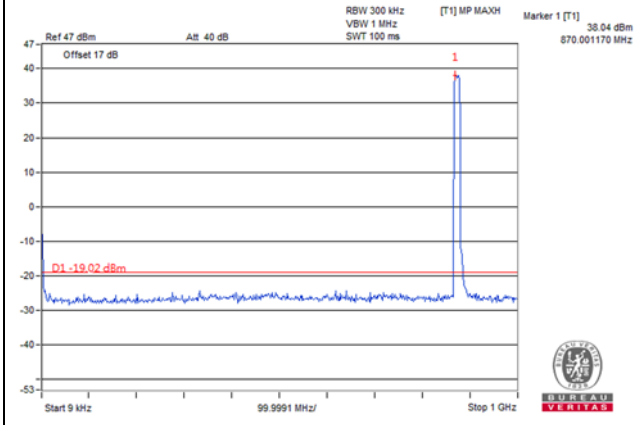

Frequency Range : 1GHz~10GHz

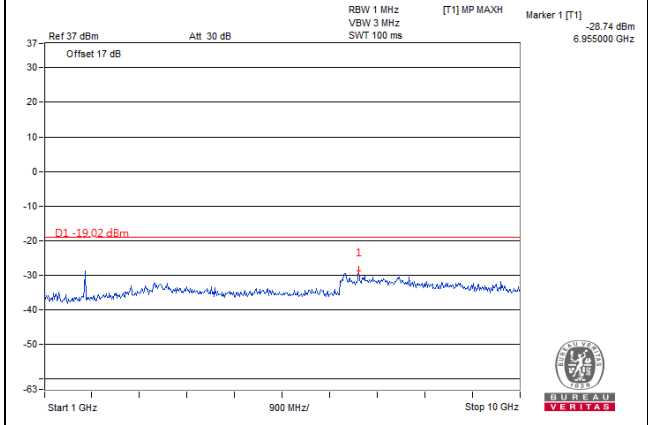

Frequency Range : 10GHz~26.5GHz

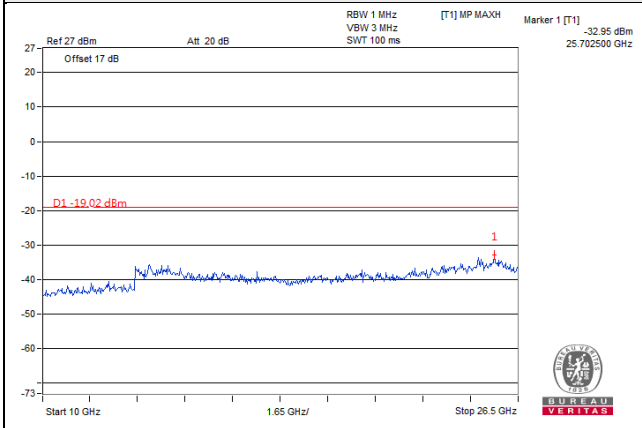

LTE Band 5, Channel Bandwidth 10MHz

881.5MHz

Frequency Range : 9kHz~1GHz

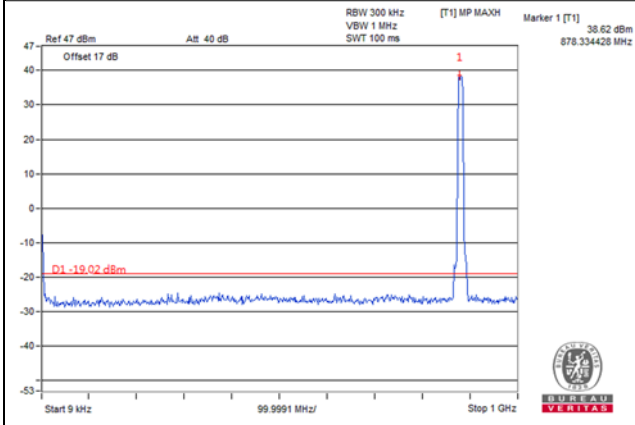

Frequency Range : 1GHz~10GHz

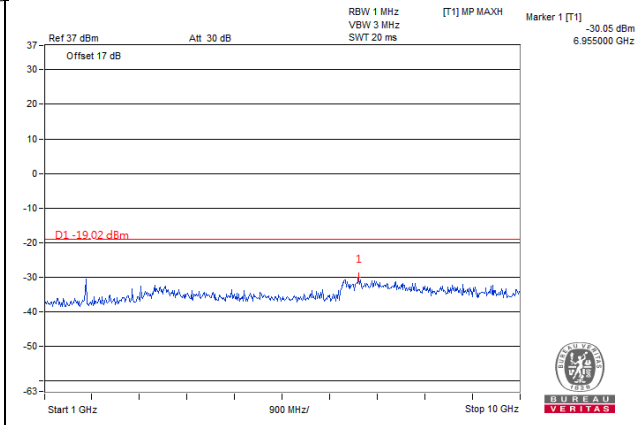

Frequency Range : 10GHz~26.5GHz

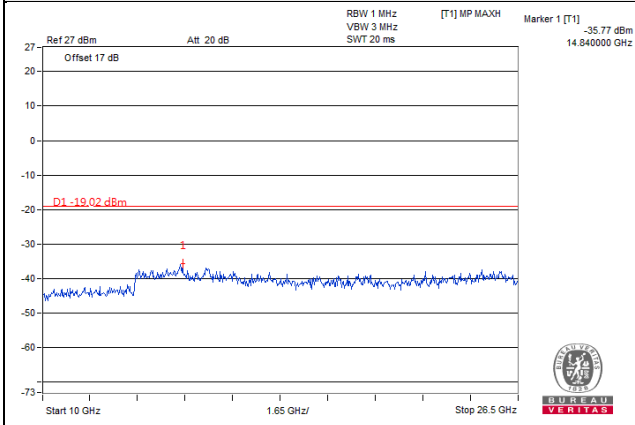



LTE Band 5, Channel Bandwidth 10MHz

889.0MHz

Frequency Range : 9kHz~1GHz

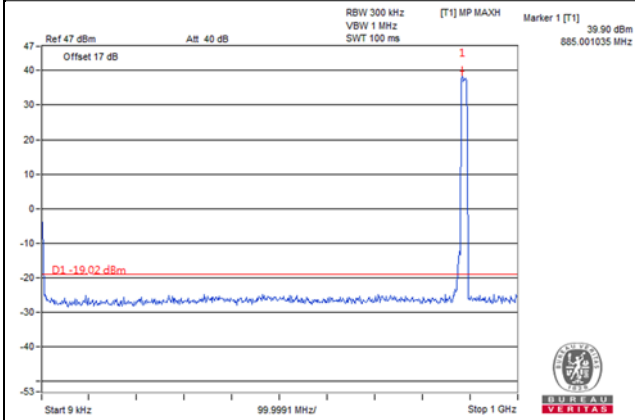

Frequency Range : 1GHz~10GHz

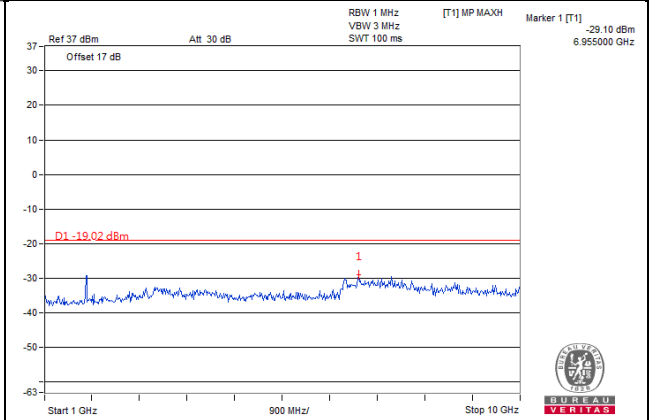

Frequency Range : 10GHz~26.5GHz

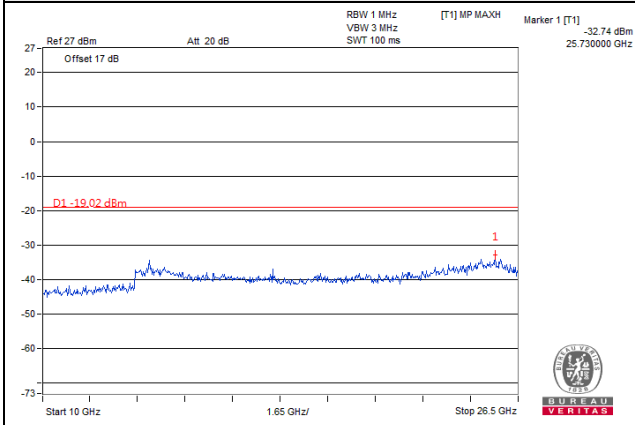

Chain 2

LTE Band 5, Channel Bandwidth 10MHz

874.0MHz

Frequency Range : 9kHz~1GHz

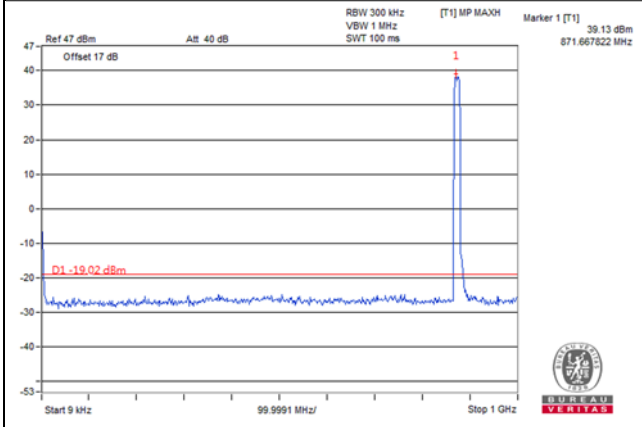

Frequency Range : 1GHz~10GHz

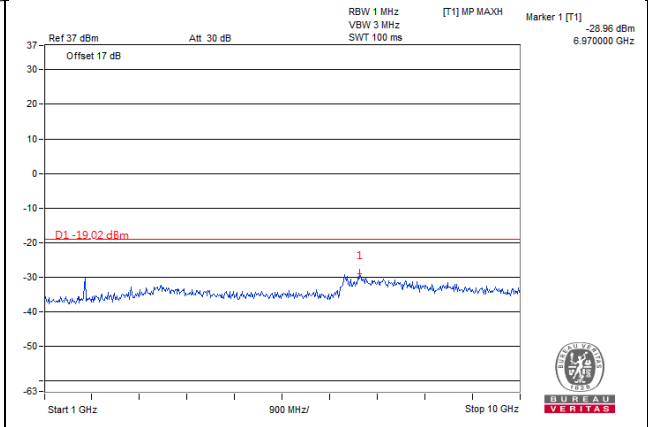

Frequency Range : 10GHz~26.5GHz

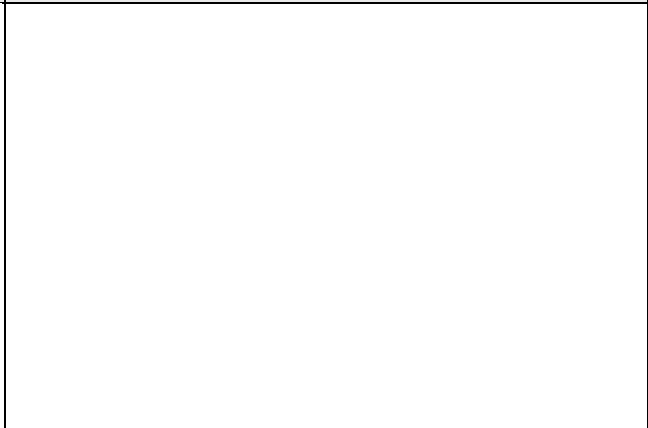
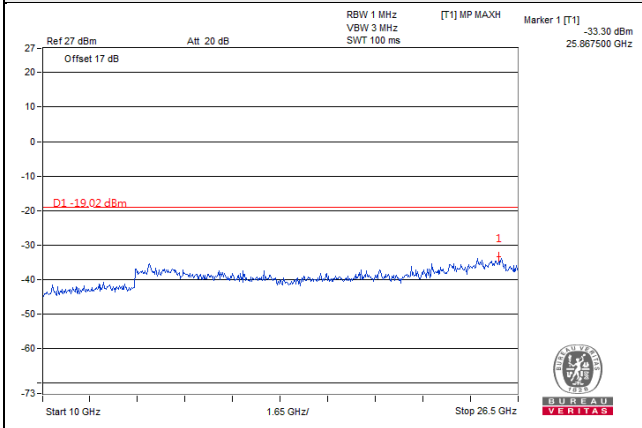

LTE Band 5, Channel Bandwidth 10MHz

881.5MHz

Frequency Range : 9kHz~1GHz

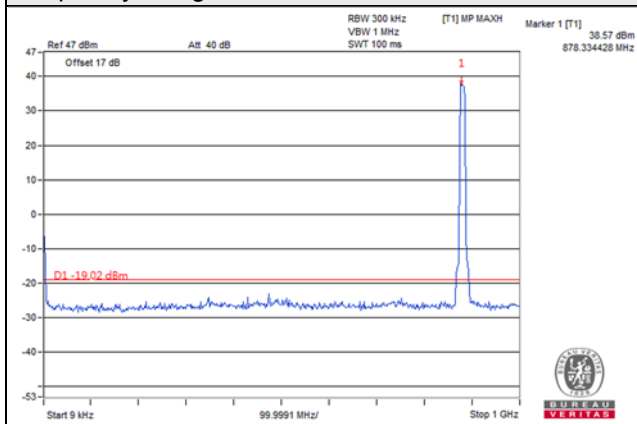

Frequency Range : 1GHz~10GHz

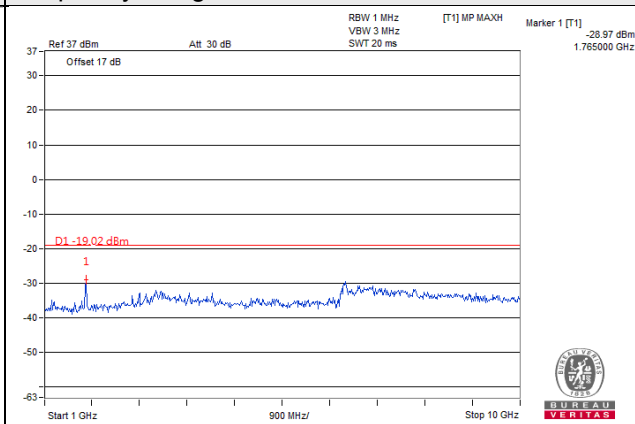

Frequency Range : 10GHz~26.5GHz

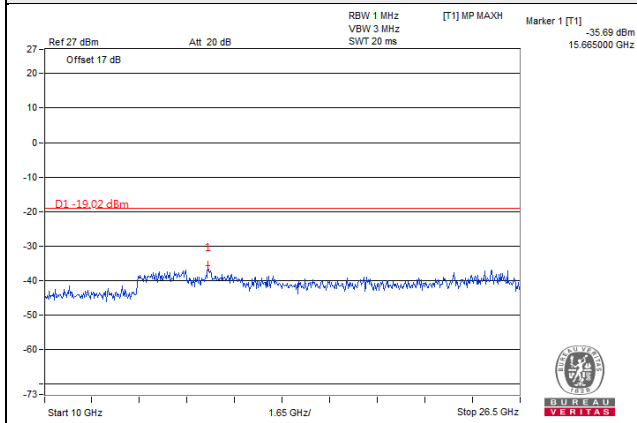

LTE Band 5, Channel Bandwidth 10MHz

889.0MHz

Frequency Range : 9kHz~1GHz

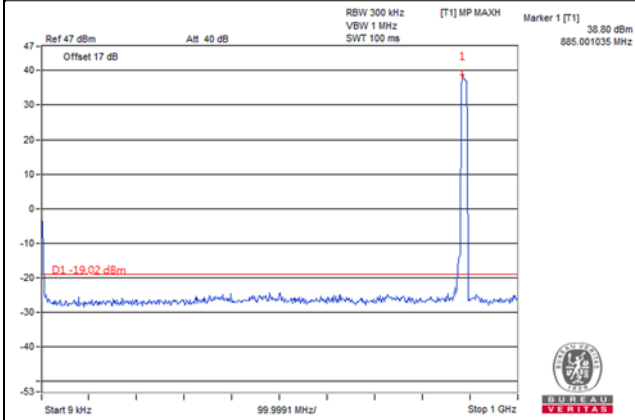

Frequency Range : 1GHz~10GHz

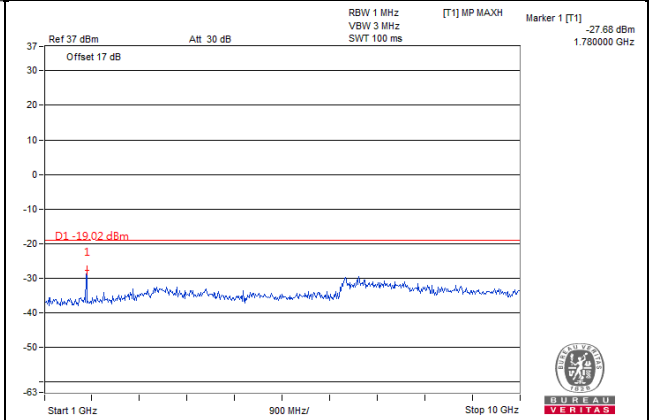

Frequency Range : 10GHz~26.5GHz

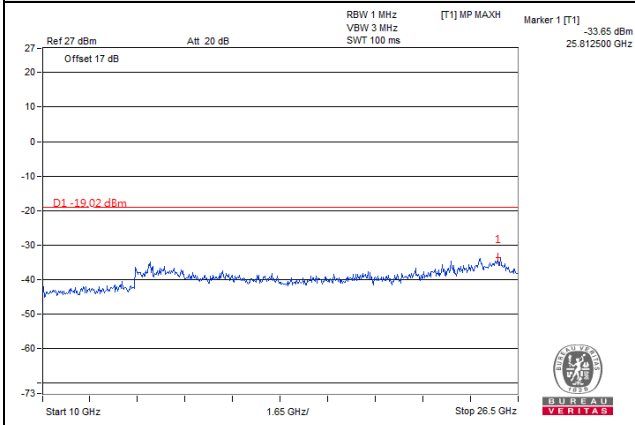

Chain 3

LTE Band 5, Channel Bandwidth 10MHz

874.0MHz

Frequency Range : 9kHz~1GHz

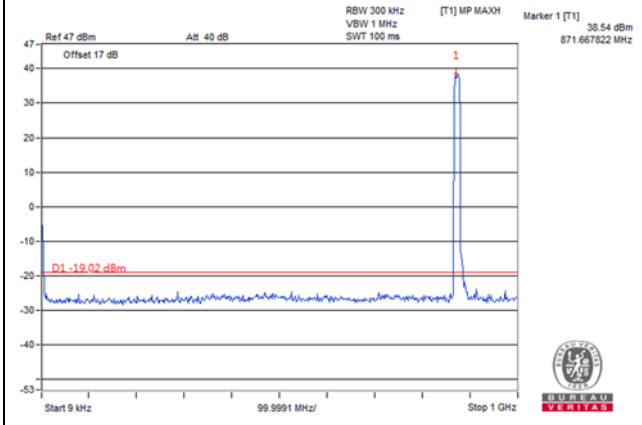

Frequency Range : 1GHz~10GHz

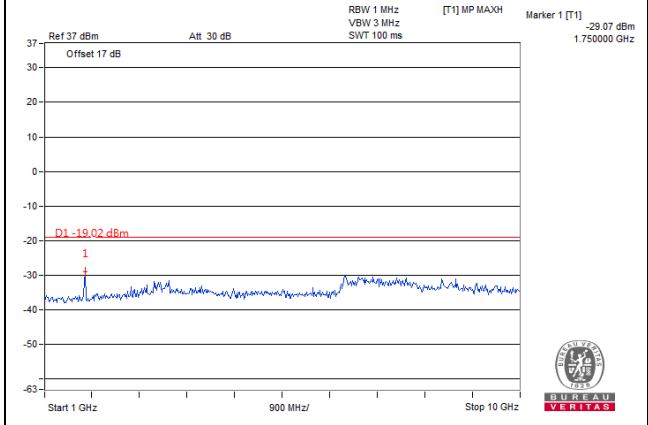

Frequency Range : 10GHz~26.5GHz

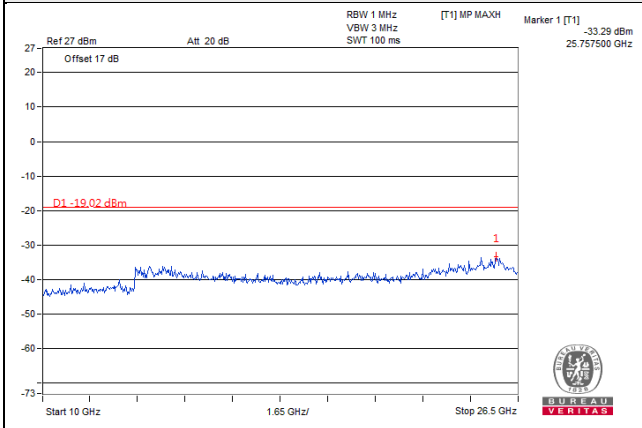

LTE Band 5, Channel Bandwidth 10MHz

881.5MHz

Frequency Range : 9kHz~1GHz

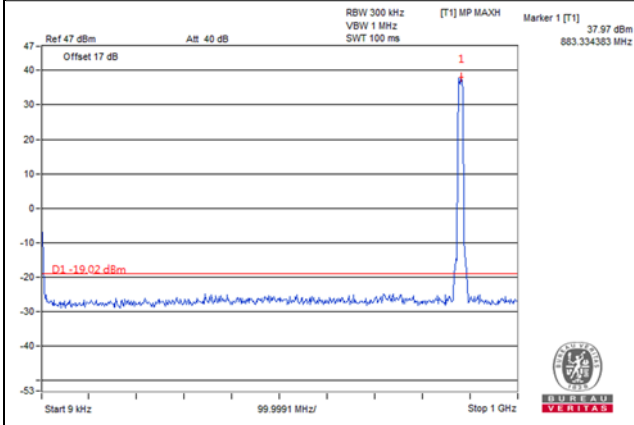

Frequency Range : 1GHz~10GHz

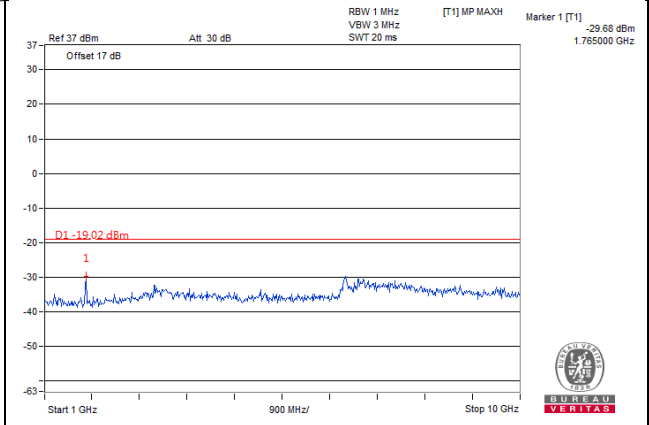

Frequency Range : 10GHz~26.5GHz

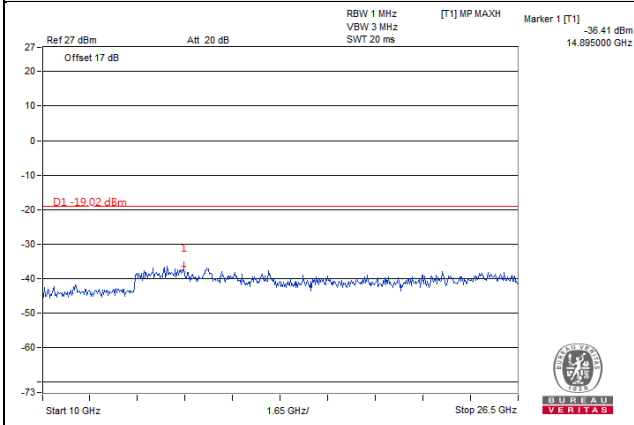

LTE Band 5, Channel Bandwidth 10MHz

889.0MHz

Frequency Range : 9kHz~1GHz

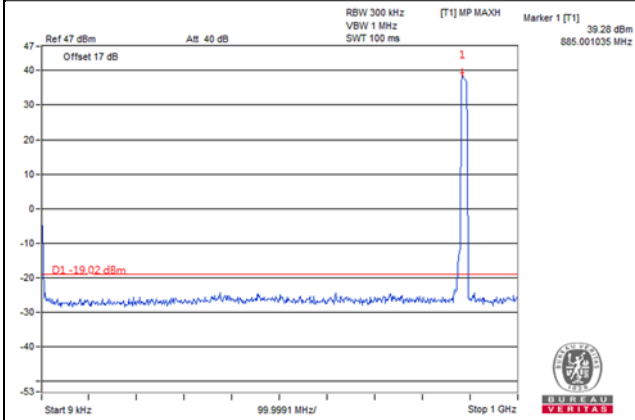

Frequency Range : 1GHz~10GHz

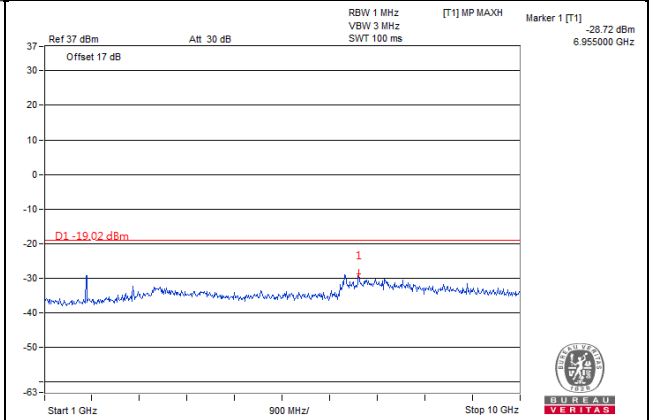

Frequency Range : 10GHz~26.5GHz

