

## FCC Test Report (Part 22)

**Report No.:** RF180905C04

**FCC ID:** 2AD8UAHCE01

**Test Model:** AHCE

**Received Date:** Sep. 05, 2018

**Test Date:** Sep. 10 ~ Sep. 12, 2018

**Issued Date:** Sep. 19, 2018

**Applicant:** Nokia Solutions and Networks, OY

**Address:** 2000 W. Lucent Lane, Naperville, IL 60563, USA

**Issued By:** Bureau Veritas Consumer Products Services (H.K.) Ltd., Taoyuan Branch

**Lab Address:** No. 47-2, 14th Ling, Chia Pau Vil., Lin Kou Dist., New Taipei City, Taiwan (R.O.C.)

**Test Location:** No. 19, Hwa Ya 2nd Rd., Wen Hwa Vil., Kwei Shan Dist., Taoyuan City 33383, TAIWAN (R.O.C.)

**FCC Registration /  
Designation Number:** 788550 / TW0003



This report is for your exclusive use. Any copying or replication of this report to or for any other person or entity, or use of our name or trademark, is permitted only with our prior written permission. This report sets forth our findings solely with respect to the test samples identified herein. The results set forth in this report are not indicative or representative of the quality or characteristics of the lot from which a test sample was taken or any similar or identical product unless specifically and expressly noted. Our report includes all of the tests requested by you and the results thereof based upon the information that you provided to us. You have 60 days from date of issuance of this report to notify us of any material error or omission caused by our negligence, provided, however, that such notice shall be in writing and shall specifically address the issue you wish to raise. A failure to raise such issue within the prescribed time shall constitute your unqualified acceptance of the completeness of this report, the tests conducted and the correctness of the report contents. Unless specific mention, the uncertainty of measurement has been explicitly taken into account to declare the compliance or non-compliance to the specification. The report must not be used by the client to claim product certification, approval, or endorsement by TAF or any government agencies

## Table of Contents

<b>Release Control Record</b> .....	<b>4</b>
<b>1 Certificate of Conformity</b> .....	<b>5</b>
<b>2 Summary of Test Results</b> .....	<b>6</b>
2.1 Measurement Uncertainty.....	6
2.2 Test Site and Instruments.....	7
<b>3 General Information</b> .....	<b>8</b>
3.1 General Description of EUT.....	8
3.2 Configuration of System under Test.....	10
3.2.1 Description of Support Units.....	10
3.3 Test Mode Applicability and Tested Channel Detail.....	11
3.4 EUT Operating Conditions.....	14
3.5 General Description of Applied Standards.....	14
<b>4 Test Types and Results</b> .....	<b>15</b>
4.1 Output Power Measurement.....	15
4.1.1 Limits of Output Power Measurement.....	15
4.1.2 Test Procedures.....	15
4.1.3 Test Setup.....	16
4.1.4 Test Results.....	17
4.2 Modulation Characteristics Measurement.....	33
4.2.1 Limits of Modulation Characteristics.....	33
4.2.2 Test Procedure.....	33
4.2.3 Test Setup.....	33
4.2.4 Test Results.....	34
4.3 Frequency Stability Measurement.....	36
4.3.1 Limits of Frequency Stability Measurement.....	36
4.3.2 Test Procedure.....	36
4.3.3 Test Setup.....	36
4.3.4 Test Results.....	37
4.4 Occupied Bandwidth Measurement.....	38
4.4.1 Test Procedure.....	38
4.4.2 Test Setup.....	38
4.4.3 Test Result.....	39
4.5 Band Edge Measurement.....	49
4.5.1 Limits of Band Edge Measurement.....	49
4.5.2 Test Setup.....	49
4.5.3 Test Procedures.....	49
4.5.4 Test Results.....	50
4.6 Peak to Average Ratio.....	60
4.6.1 Limits of Peak to Average Ratio Measurement.....	60
4.6.2 Test Setup.....	60
4.6.3 Test Procedures.....	60
4.6.4 Test Results.....	61
4.7 Conducted Spurious Emissions.....	63
4.7.1 Limits of Conducted Spurious Emissions Measurement.....	63
4.7.2 Test Setup.....	63
4.7.3 Test Procedure.....	63
4.7.4 Test Results.....	64
4.8 Radiated Emission Measurement.....	116
4.8.1 Limits of Radiated Emission Measurement.....	116
4.8.2 Test Procedure.....	116
4.8.3 Deviation from Test Standard.....	116
4.8.4 Test Setup.....	117
4.8.5 Test Results.....	118

<b>5</b>	<b>Pictures of Test Arrangements.....</b>	<b>137</b>
	<b>Appendix – Information on the Testing Laboratories .....</b>	<b>138</b>

### Release Control Record

Issue No.	Description	Date Issued
RF180905C04	Original release	Sep. 19, 2018

## 1 Certificate of Conformity

**Product:** AirScale Micro Remote Radio Head

**Brand:** Nokia

**Test Model:** AHCE

**Sample Status:** Engineering sample

**Applicant:** Nokia Solutions and Networks, OY

**Test Date:** Sep. 10 ~ Sep. 12, 2018

**Standards:** FCC Part 22, Subpart H

The above equipment has been tested by **Bureau Veritas Consumer Products Services (H.K.) Ltd., Taoyuan Branch**, and found compliance with the requirement of the above standards. The test record, data evaluation & Equipment Under Test (EUT) configurations represented herein are true and accurate accounts of the measurements of the sample's RF characteristics under the conditions specified in this report.

**Prepared by :** , **Date:** Sep. 19, 2018  
Polly Chien / Specialist

**Approved by :** , **Date:** Sep. 19, 2018  
Bruce Chen / Project Engineer

## 2 Summary of Test Results

Applied Standard: FCC Part 22 & Part 2			
FCC Clause	Test Item	Result	Remarks
2.1046 22.913 (a)	Effective radiated power	Pass	Meet the requirement of limit.
2.1047	Modulation characteristics	Pass	Meet the requirement
---	Peak To Average Ratio	Pass	Meet the requirement of limit.
2.1055 22.355	Frequency Stability	Pass	Meet the requirement of limit.
2.1049	Occupied Bandwidth	Pass	Meet the requirement of limit.
22.917	Band Edge Measurements	Pass	Meet the requirement of limit.
2.1051 22.917	Conducted Spurious Emissions	Pass	Meet the requirement of limit.
2.1053 22.917	Radiated Spurious Emissions	Pass	Meet the requirement of limit. Minimum passing margin is -24.8dB at 60.07MHz.

### 2.1 Measurement Uncertainty

Where relevant, the following measurement uncertainty levels have been estimated for tests performed on the EUT as specified in CISPR 16-4-2:

Measurement	Frequency	Expanded Uncertainty (k=2) ( $\pm$ )
Radiated Emissions up to 1 GHz	30MHz ~ 200MHz	3.59 dB
	200MHz ~1000MHz	3.60 dB
Radiated Emissions above 1 GHz	1GHz ~ 18GHz	2.29 dB
	18GHz ~ 40GHz	2.29 dB

## 2.2 Test Site and Instruments

Description & Manufacturer	Model No.	Serial No.	Cal. Date	Cal. Due
Test Receiver KEYSIGHT	N9038A	MY55420137	Apr. 11, 2018	Apr. 10, 2019
Spectrum Analyzer ROHDE & SCHWARZ	FSP40	100269	May 29, 2018	May 28, 2019
BILOG Antenna SCHWARZBECK	VULB9168	9168-148	Dec. 11, 2017	Dec. 10, 2018
HORN Antenna SCHWARZBECK	BBHA 9120 D	9120D-1169	Dec. 12, 2017	Dec. 11, 2018
HORN Antenna SCHWARZBECK	BBHA 9170	BBHA9170241	Dec. 01, 2017	Nov. 30, 2018
Loop Antenna TESEQ	HLA 6121	45745	Jun. 14, 2018	Jun. 13, 2019
Preamplifier Agilent (Below 1GHz)	8447D	2944A10638	Aug. 08, 2018	Aug. 07, 2019
Preamplifier Agilent (Above 1GHz)	8449B	3008A01638	Feb. 22, 2018	Feb. 21, 2019
RF signal cable HUBER+SUHNER&EMCI	SUCOFLEX 104 & EMC104-SM-SM8000	CABLE-CH9-02 (248780+171006)	Jan. 15, 2018	Jan. 14, 2019
RF signal cable HUBER+SUHNER	SUCOFLEX 104	CABLE-CH9-(250795/4)	Aug. 08, 2018	Aug. 07, 2019
RF signal cable Woken	8D-FB	Cable-CH9-01	Jul. 31, 2018	Jul. 30, 2019
Software BV ADT	ADT_Radiated_ V7.6.15.9.5	NA	NA	NA
Antenna Tower EMCO	2070/2080	512.835.4684	NA	NA
Turn Table EMCO	2087-2.03	NA	NA	NA
Antenna Tower & Turn BV ADT	AT100	AT93021705	NA	NA
Turn Table BV ADT	TT100	TT93021705	NA	NA
Turn Table Controller BV ADT	SC100	SC93021705	NA	NA
Boresight Antenna Fixture	FBA-01	FBA-SIP01	NA	NA
WIT Standard Temperature And Humidity Chamber	TH-4S-C	W981030	Jun. 04, 2018	Jun. 03, 2019
Mini-Circuits Power Splitter	ZN2PD-9G	NA	Jun. 21, 2018	Jun. 20, 2019
JFW 20dB attenuation	50HF-020-SMA	NA	NA	NA

- Note:
1. The calibration interval of the above test instruments is 12 months and the calibrations are traceable to NML/ROC and NIST/USA.
  2. The test was performed in HwaYa Chamber 9.
  3. The FCC Designation Number is TW0003. The number will be varied with the Lab location and scope as attached.
  4. The IC Site Registration No. is IC 7450F-9.

### 3 General Information

#### 3.1 General Description of EUT

Product	AirScale Micro Remote Radio Head				
Brand	Nokia				
Test Model	AHCE				
Sample Status	Engineering sample				
Power Supply Rating	I/P: 100-240Vac, 50/60Hz, 3A MAX O/P: -54Vdc, 3A MAX				
Modulation Type	QPSK, 16QAM, 64QAM, 256QAM				
Operating Frequency	LTE Band 5 (Channel Bandwidth 1.4MHz)	869.7MHz ~ 893.3MHz			
	LTE Band 5 (Channel Bandwidth 3MHz)	870.5MHz ~ 892.5MHz			
	LTE Band 5 (Channel Bandwidth 5MHz)	871.5MHz ~ 891.5MHz			
	LTE Band 5 (Channel Bandwidth 10MHz)	874MHz ~ 889MHz			
	LTE Band 5 (Channel Bandwidth 1.4MHz +1.4MHz+1.4MHz+1.4MHz)	871.8MHz ~ 891.2MHz			
	LTE Band 5 (Channel Bandwidth 3MHz +3MHz+3MHz+3MHz)	875MHz ~ 888MHz			
	LTE Band 5 (Channel Bandwidth 5MHz +5MHz+5MHz+5MHz)	879MHz ~ 884MHz			
	LTE Band 5 (Channel Bandwidth 10MHz +10MHz+5MHz)	881.5MHz			
Max. ERP Power	LTE Band 5 (Channel Bandwidth 1.4MHz)	311171.634mW (54.93dBm)			
	LTE Band 5 (Channel Bandwidth 3MHz)	311888.958mW (54.94dBm)			
	LTE Band 5 (Channel Bandwidth 5MHz)	309741.930mW (54.91dBm)			
	LTE Band 5 (Channel Bandwidth 10MHz)	311888.958mW (54.94dBm)			
	LTE Band 5 (Channel Bandwidth 1.4MHz +1.4MHz+1.4MHz+1.4MHz)	298538.262mW (54.75dBm)			
	LTE Band 5 (Channel Bandwidth 3MHz +3MHz+3MHz+3MHz)	297851.643mW (54.74dBm)			
	LTE Band 5 (Channel Bandwidth 5MHz +5MHz+5MHz+5MHz)	299916.252mW (54.77dBm)			
	LTE Band 5 (Channel Bandwidth 10MHz +10MHz+5MHz)	303389.118mW (54.82dBm)			
Emission Designator		QPSK	16QAM	64QAM	256QAM
	LTE Band 5 (Channel Bandwidth 1.4MHz)	1M11G7D	1M11W7D	1M11W7D	1M11W7D
	LTE Band 5 (Channel Bandwidth 3MHz)	2M70G7D	2M70W7D	2M70W7D	2M70W7D
	LTE Band 5 (Channel Bandwidth 5MHz)	4M48G7D	4M48W7D	4M48W7D	4M48W7D
	LTE Band 5 (Channel Bandwidth 10MHz)	8M96G7D	8M96W7D	8M96W7D	8M96W7D
	LTE Band 5 (Channel Bandwidth 10MHz +10MHz+5MHz)	24M1G7D	24M2D7W	24M1D7W	24M1D7W
	Antenna Gain	8dBi			
S/N	474044A				
HW Version	X21				
SW Version	FDD-LTE 18A				
Accessory Device	Refer to Note as below				
Cable Supplied	NA				



Note:

1. The EUT contains following accessory devices.

AC PSU (Optional)	
Brand	Nokia
Model	APAB
Sales Item	474130A.102
S/N	U7174800066
Remark	SUPLET/S818A160-220S54W
Input Power	100-240Vac, 50-60Hz, 3A MAX
Output Power	-54Vdc, 3A MAX

2. The EUT incorporates a MIMO function. Physically, the EUT provides 4 completed transmitters and 4 receivers.

Modulation Mode	TX Function
QPSK, 16QAM, 64QAM, 256QAM	1TX
QPSK, 16QAM, 64QAM, 256QAM	2TX
QPSK, 16QAM, 64QAM, 256QAM	3TX
QPSK, 16QAM, 64QAM, 256QAM	4TX

3. For multi-carrier, after the pretest LTE Band 5 (Channel Bandwidth 1.4MHz +1.4MHz+1.4MHz+1.4MHz), (Channel Bandwidth 3MHz+3MHz+3MHz+3MHz), (Channel Bandwidth 5MHz +5MHz+5MHz+5MHz) and (Channel Bandwidth 10MHz +10MHz+5MHz), the LTE Band 5 (Channel Bandwidth 10MHz +10MHz+5MHz) were found to be the worst case test modes for all final test except power measurement test.
4. The antenna gain for reference only, the test was done with 50ohm terminator on antenna port.

### 3.2 Configuration of System under Test

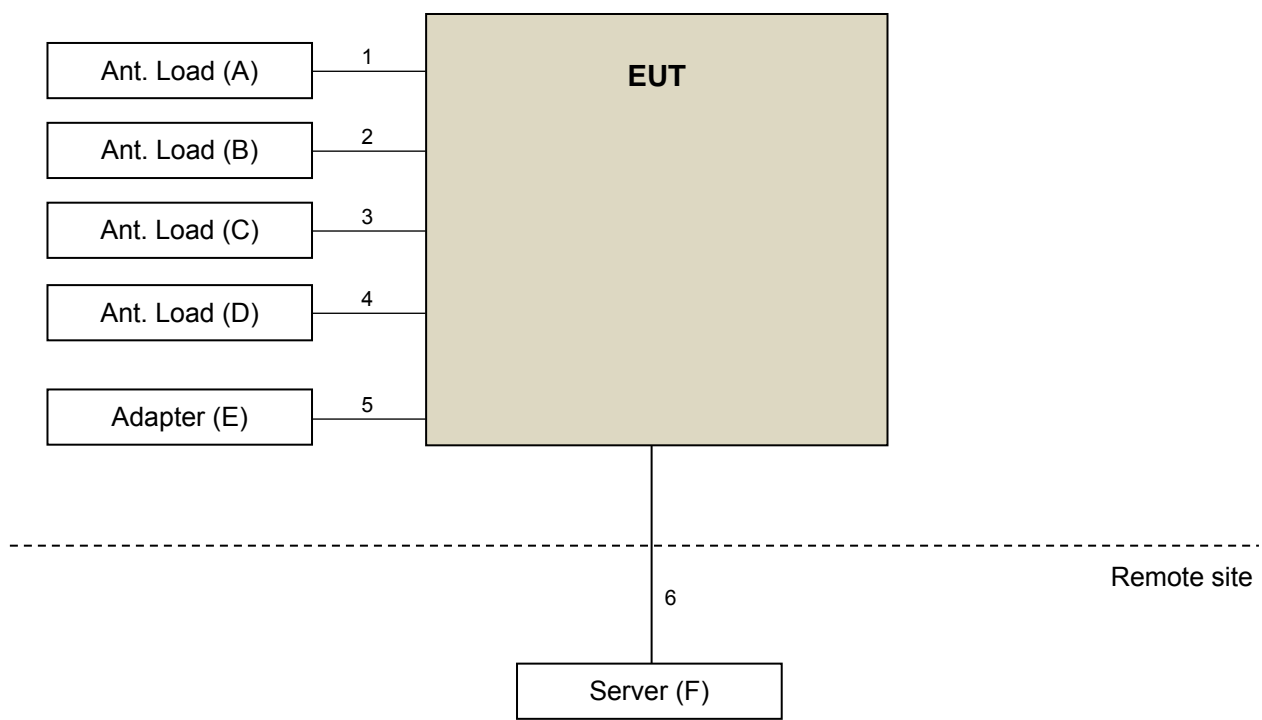

#### 3.2.1 Description of Support Units

The EUT has been tested as an independent unit together with other necessary accessories or support units. The following support units or accessories were used to form a representative test configuration during the tests.

ID	Product	Brand	Model No.	Serial No.	FCC ID	Remarks
A.	Ant. Load	NA	NA	NA	NA	Provided by manufacturer
B.	Ant. Load	NA	NA	NA	NA	Provided by manufacturer
C.	Ant. Load	NA	NA	NA	NA	Provided by manufacturer
D.	Ant. Load	NA	NA	NA	NA	Provided by manufacturer
E.	Adapter	Nokia	APAB	U7174800066	NA	Provided by manufacturer
F.	Server	NA	NA	NA	NA	Provided by manufacturer

Note:

1. All power cords of the above support units are non-shielded (1.8m).
2. Item E acted as a communication partner to transfer data.

ID	Descriptions	Qty.	Length (m)	Shielding (Yes/No)	Cores (Qty.)	Remarks
1.	Ant. Cable	1	1	Y	0	-
2.	Ant. Cable	1	1	Y	0	-
3.	Ant. Cable	1	1	Y	0	-
4.	Ant. Cable	1	1	Y	0	-
5.	DC Cable	1	0.55	Y	0	Provided by manufacturer
6.	Fiber Cable	2	10	N	0	-

### 3.3 Test Mode Applicability and Tested Channel Detail

Pre-Scan has been conducted to determine the worst-case mode from all possible combinations between available modulations, data rates, XYZ axis and antenna ports. The worst case was found when positioned on X-plane. Following channel(s) was (were) selected for the final test as listed below:

#### LTE Band 5

EUT Configure Mode	Test item	Available channel	Tested channel	Channel Bandwidth	Modulation	Mode
-	ERP	2407 to 2643	2407(869.7MHz), 2525(881.5MHz), 2643(893.3MHz)	1.4MHz	QPSK / 16QAM / 64QAM / 256QAM	Full RB
		2415 to 2635	2415(870.5MHz), 2525(881.5MHz), 2635(892.5MHz)	3MHz	QPSK / 16QAM / 64QAM / 256QAM	Full RB
		2425 to 2625	2425(871.5MHz), 2525(881.5MHz), 2625(891.5MHz)	5MHz	QPSK / 16QAM / 64QAM / 256QAM	Full RB
		2450 to 2600	2450(874.0MHz), 2525(881.5MHz), 2600(889.0MHz)	10MHz	QPSK / 16QAM / 64QAM / 256QAM	Full RB
-	Modulation characteristics	2450 to 2600	2525(881.5MHz),	1.4MHz	QPSK / 16QAM / 64QAM / 256QAM	Full RB
				10MHz	QPSK / 16QAM / 64QAM / 256QAM	Full RB
-	Frequency Stability	2407 to 2643	2525(881.5MHz)	1.4MHz	QPSK	Full RB
		2415 to 2635	2525(881.5MHz)	3MHz	QPSK	Full RB
		2425 to 2625	2525(881.5MHz)	5MHz	QPSK	Full RB
		2450 to 2600	2525(881.5MHz)	10MHz	QPSK	Full RB
-	Occupied Bandwidth	2407 to 2643	2407(869.7MHz), 2525(881.5MHz), 2643(893.3MHz)	1.4MHz	QPSK / 16QAM / 64QAM / 256QAM	Full RB
		2415 to 2635	2415(870.5MHz), 2525(881.5MHz), 2635(892.5MHz)	3MHz	QPSK / 16QAM / 64QAM / 256QAM	Full RB
		2425 to 2625	2425(871.5MHz), 2525(881.5MHz), 2625(891.5MHz)	5MHz	QPSK / 16QAM / 64QAM / 256QAM	Full RB
		2450 to 2600	2450(874.0MHz), 2525(881.5MHz), 2600(889.0MHz)	10MHz	QPSK / 16QAM / 64QAM / 256QAM	Full RB
-	Band Edge	2407 to 2643	2407(869.7MHz), 2643(893.3MHz)	1.4MHz	QPSK	Full RB
		2415 to 2635	2415(870.5MHz), 2635(892.5MHz)	3MHz	QPSK	Full RB
		2425 to 2625	2425(871.5MHz), 2625(891.5MHz)	5MHz	QPSK	Full RB
		2450 to 2600	2450(874.0MHz), 2600(889.0MHz)	10MHz	QPSK	Full RB

EUT Configure Mode	Test item	Available channel	Tested channel	Channel Bandwidth	Modulation	Mode
-	Peak to Average Ratio	2407 to 2643	2407(869.7MHz), 2525(881.5MHz), 2643(893.3MHz)	1.4MHz	QPSK / 16QAM / 64QAM / 256QAM	Full RB
		2415 to 2635	2415(870.5MHz), 2525(881.5MHz), 2635(892.5MHz)	3MHz	QPSK / 16QAM / 64QAM / 256QAM	Full RB
		2425 to 2625	2425(871.5MHz), 2525(881.5MHz), 2625(891.5MHz)	5MHz	QPSK / 16QAM / 64QAM / 256QAM	Full RB
		2450 to 2600	2450(874.0MHz), 2525(881.5MHz), 2600(889.0MHz)	10MHz	QPSK / 16QAM / 64QAM / 256QAM	Full RB
-	Conducted Emission	2407 to 2643	2407(869.7MHz), 2525(881.5MHz), 2643(893.3MHz)	1.4MHz	QPSK	Full RB
		2415 to 2635	2415(870.5MHz), 2525(881.5MHz), 2635(892.5MHz)	3MHz	QPSK	Full RB
		2425 to 2625	2425(871.5MHz), 2525(881.5MHz), 2625(891.5MHz)	5MHz	QPSK	Full RB
		2450 to 2600	2450(874.0MHz), 2525(881.5MHz), 2600(889.0MHz)	10MHz	QPSK	Full RB
-	Radiated Emission Below 1GHz	2407 to 2643	2525(881.5MHz)	1.4MHz	QPSK	Full RB
		2415 to 2635	2525(881.5MHz)	3MHz	QPSK	Full RB
		2425 to 2625	2525(881.5MHz)	5MHz	QPSK	Full RB
		2450 to 2600	2525(881.5MHz)	10MHz	QPSK	Full RB
-	Radiated Emission Above 1GHz	2407 to 2643	2407(869.7MHz), 2525(881.5MHz), 2643(893.3MHz)	1.4MHz	QPSK	Full RB
		2415 to 2635	2415(870.5MHz), 2525(881.5MHz), 2635(892.5MHz)	3MHz	QPSK	Full RB
		2425 to 2625	2425(871.5MHz), 2525(881.5MHz), 2625(891.5MHz)	5MHz	QPSK	Full RB
		2450 to 2600	2450(874.0MHz), 2525(881.5MHz), 2600(889.0MHz)	10MHz	QPSK	Full RB

multi-carrier

EUT Configure Mode	Test item	Available channel	Tested channel	Channel Bandwidth	Modulation	Mode
-	ERP	2428 to 2622	2428 (871.8MHz) 2525 (881.5MHz) 2622 (891.2MHz)	1.4MHz+ 1.4MHz+ 1.4MHz+ 1.4MHz	QPSK / 16QAM / 64QAM / 256QAM	Full RB
		2460 to 2590	2460 (875.0MHz) 2525 (881.5MHz) 2590 (888.0MHz)	3MHz+ 3MHz+ 3MHz+ 3MHz	QPSK / 16QAM / 64QAM / 256QAM	Full RB
		2500 to 2550	2500 (879.0MHz) 2550 (884.0MHz)	5MHz+ 5MHz+ 5MHz+ 5MHz	QPSK / 16QAM / 64QAM / 256QAM	Full RB
		2525	2525 (881.5MHz)	10MHz+ 10MHz+ 5MHz	QPSK / 16QAM / 64QAM / 256QAM	Full RB
-	Emission Bandwidth	2525	2525 (881.5MHz)	10MHz+ 10MHz+ 5MHz	QPSK / 16QAM / 64QAM / 256QAM	Full RB
-	Band Edge	2525	2525 (881.5MHz)	10MHz+ 10MHz+ 5MHz	QPSK	Full RB
-	Conducted Emission	2525	2525 (881.5MHz)	10MHz+ 10MHz+ 5MHz	QPSK	Full RB
-	Radiated Emission below 1GHz	2525	2525 (881.5MHz)	10MHz+ 10MHz+ 5MHz	QPSK	Full RB
-	Radiated Emission above 1GHz	2525	2525 (881.5MHz)	10MHz+ 10MHz+ 5MHz	QPSK	Full RB

Note: The conducted output power for QPSK, 16QAM, 64QAM and 256QAM measured value of QPSK is higher than 16QAM, 64QAM and 256QAM mode. Therefore, only Emission Bandwidth test item had been tested under QPSK, 16QAM, 64QAM and 256QAM modes, the other test items were performed under QPSK mode only.

Test Condition:

Test Item	Environmental Conditions	Input Power	Tested By
ERP	24deg. C, 64%RH	120Vac, 60Hz	James Yang
Modulation characteristics	24deg. C, 64%RH	120Vac, 60Hz	James Yang
Frequency Stability	24deg. C, 64%RH	54Vdc	James Yang
Occupied Bandwidth	24deg. C, 64%RH	120Vac, 60Hz	James Yang
Band Edge	24deg. C, 64%RH	120Vac, 60Hz	James Yang
Peak To Average Ratio	24deg. C, 64%RH	120Vac, 60Hz	James Yang
Conducted Emission	24deg. C, 64%RH	120Vac, 60Hz	James Yang
Radiated Emission	25deg. C, 65%RH	120Vac, 60Hz	Greg Lin

### **3.4 EUT Operating Conditions**

The EUT makes a call to the communication simulator. The communication simulator station system controlled a EUT to export maximum output power under transmission mode and specific channel frequency

### **3.5 General Description of Applied Standards**

The EUT is a RF Product. According to the specifications of the manufacturer, it must comply with the requirements of the following standards:

**FCC 47 CFR Part 2**

**FCC 47 CFR Part 22**

**KDB 971168 D01 Power Meas License Digital Systems v03r01**

**KDB 662911 D01 Multiple Transmitter Output v02r01**

**ANSI/TIA/EIA-603-E 2016**

**ANSI 63.26-2015**

All test items have been performed and recorded as per the above standards.

## 4 Test Types and Results

### 4.1 Output Power Measurement

#### 4.1.1 Limits of Output Power Measurement

The ERP of transmitters in the Cellular Radiotelephone Service must not exceed the limits in this section.

- (i) 500 watts per emission; or
- (ii) 400 watts/MHz (PSD) per sector.

#### 4.1.2 Test Procedures

##### EIRP / ERP Measurement:

- a. All measurements were done at low, middle and high operational frequency range. RBW and VBW is 10MHz for LTE mode.
- b. Substitution method is used for E.I.R.P measurement. In the semi-anechoic chamber, EUT placed on the 0.8m(below or equal 1GHz) and/or 1.5m(above 1GHz) height of Turn Table, rotated the table around 360 degrees to search the maximum radiation power and receiver antenna shall be rotated vertical and horizontal polarization and moved height from 1m to 4m to find the maximum polar radiated power. The "Read Value" is the spectrum reading the maximum power value.
- c. The substitution horn antenna is substituted for EUT at the same position and signals generator export the CW signal to the substitution antenna via a TX cable. Rotated the Turn Table and moved receiving antenna to find the maximum radiation power. Adjust output power level of S.G to get a Value of spectrum reading equal to "Read Value" of step b. Record the power level of S.G
- d. EIRP = Output power level of S.G – TX cable loss + Antenna gain of substitution horn. E.R.P power can be calculated form E.I.R.P power by subtracting the gain of dipole, E.R.P power = E.I.R.P power - 2.15dB.

Where:

$$\text{EIRP / ERP} = P_{\text{Meas}} + G_{\text{T}} - L_{\text{C}}$$

$P_{\text{Meas}}$  : Measure transmitter output power.

$G_{\text{T}}$  : Gain of the transmitting antenna.

$L_{\text{C}}$  : signal attenuation in the connecting cable between the transmitter and antenna.

##### Conducted Power Measurement:

The EUT was set up for the maximum power with LTE link data modulation and link up with simulator. Set the EUT to transmit under low, middle and high channel and record the power level shown on simulator.

### 4.1.3 Test Setup

ERP Measurement:

**For Radiated Emission below or equal 1GHz**

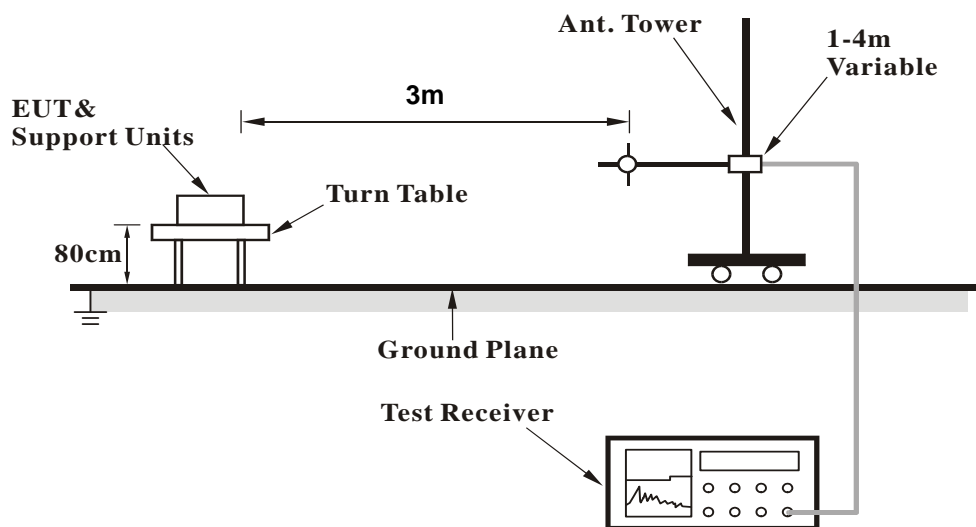

**For Radiated Emission above 1GHz**

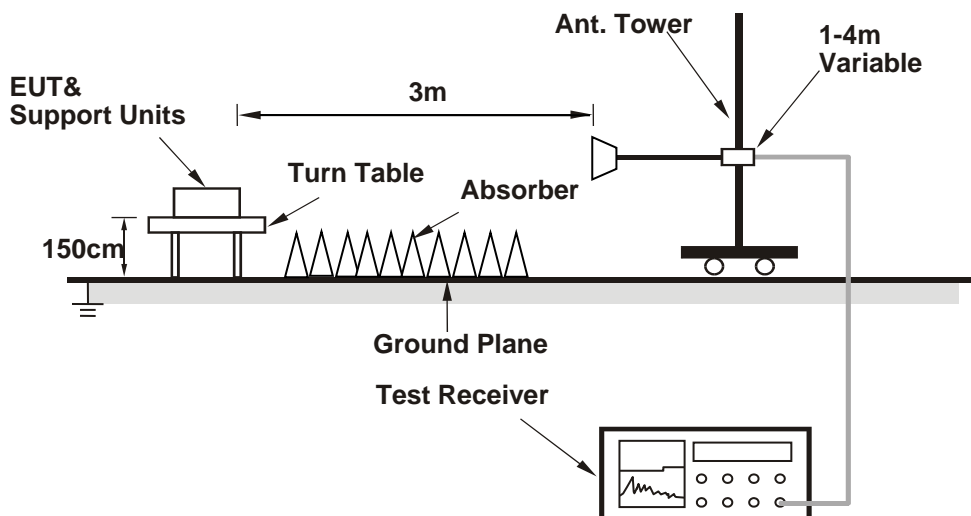

For the actual test configuration, please refer to the attached file (Test Setup Photo).

Conducted Power Measurement:



For the actual test configuration, please refer to the attached file (Test Setup Photo).



#### 4.1.4 Test Results

For 1TX:

Conducted Output Power (dBm)

Band / BW	Ant	QPSK			16QAM			64QAM			256QAM		
		Low CH	Mid CH	High CH	Low CH	Mid CH	High CH	Low CH	Mid CH	High CH	Low CH	Mid CH	High CH
		2407	2525	2643	2407	2525	2643	2407	2525	2643	2407	2525	2643
		869.7 MHz	881.5 MHz	893.3 MHz	869.7 MHz	881.5 MHz	893.3 MHz	869.7 MHz	881.5 MHz	893.3 MHz	869.7 MHz	881.5 MHz	893.3 MHz
5 / 1.4M	Chain 0	37.02	37.03	36.53	36.99	36.99	36.47	36.97	36.97	36.44	36.95	36.94	36.41
	Chain 1	37.01	37.03	36.60	36.95	36.98	36.53	36.93	36.96	36.48	36.91	36.93	36.47
	Chain 2	37.05	37.08	36.63	37.02	37.05	36.55	36.98	37.02	36.56	36.95	36.97	36.54
	Chain 3	37.01	37.02	36.48	36.98	36.95	36.48	36.96	36.93	36.39	36.92	36.89	36.44

Band / BW	Ant	QPSK			16QAM			64QAM			256QAM		
		Low CH	Mid CH	High CH	Low CH	Mid CH	High CH	Low CH	Mid CH	High CH	Low CH	Mid CH	High CH
		2415	2525	2635	2415	2525	2635	2415	2525	2635	2415	2525	2635
		870.5 MHz	881.5 MHz	892.5 MHz	870.5 MHz	881.5 MHz	892.5 MHz	870.5 MHz	881.5 MHz	892.5 MHz	870.5 MHz	881.5 MHz	892.5 MHz
5 / 3M	Chain 0	36.88	36.99	36.73	36.87	36.96	36.71	36.84	36.93	36.69	36.81	36.87	36.63
	Chain 1	36.98	37.08	36.83	36.95	37.03	36.78	36.93	36.98	36.73	36.89	36.94	36.68
	Chain 2	37.01	37.10	36.85	36.97	37.04	36.79	36.92	36.99	36.77	36.88	36.93	36.73
	Chain 3	36.97	37.04	36.76	36.94	36.99	36.72	36.9	36.93	36.68	36.85	36.87	36.62

Band / BW	Ant	QPSK			16QAM			64QAM			256QAM		
		Low CH	Mid CH	High CH	Low CH	Mid CH	High CH	Low CH	Mid CH	High CH	Low CH	Mid CH	High CH
		2425	2525	2625	2425	2525	2625	2425	2525	2625	2425	2525	2625
		871.5 MHz	881.5 MHz	891.5 MHz	871.5 MHz	881.5 MHz	891.5 MHz	871.5 MHz	881.5 MHz	891.5 MHz	871.5 MHz	881.5 MHz	891.5 MHz
5 / 5M	Chain 0	36.99	36.98	36.89	36.95	36.97	36.87	36.88	36.94	36.85	36.85	36.91	36.81
	Chain 1	37.00	37.03	36.86	36.98	36.99	36.83	36.92	36.95	36.78	36.89	36.92	36.74
	Chain 2	36.98	37.05	36.88	36.94	37.01	36.84	36.91	36.97	36.79	36.87	36.93	36.75
	Chain 3	37.03	37.01	36.87	36.99	36.95	36.82	36.94	36.91	36.78	36.89	36.86	36.73

Band / BW	Ant	QPSK			16QAM			64QAM			256QAM		
		Low CH	Mid CH	High CH	Low CH	Mid CH	High CH	Low CH	Mid CH	High CH	Low CH	Mid CH	High CH
		2450	2525	2600	2450	2525	2600	2450	2525	2600	2450	2525	2600
		874 MHz	881.5 MHz	889 MHz	874 MHz	881.5 MHz	889 MHz	874 MHz	881.5 MHz	889 MHz	874 MHz	881.5 MHz	889 MHz
5 / 10M	Chain 0	37.04	36.96	37.04	37.02	36.92	37.01	36.98	36.89	36.97	36.93	36.84	36.93
	Chain 1	37.08	36.96	37.10	37.03	36.93	37.05	36.97	36.88	36.99	36.92	36.85	36.94
	Chain 2	36.99	36.99	37.04	36.95	36.94	36.99	36.91	36.91	36.94	36.87	36.87	36.89
	Chain 3	37.02	37.01	37.02	36.98	36.97	36.97	36.94	36.92	36.91	36.88	36.88	36.87

Band / BW	Ant	QPSK			16QAM			64QAM			256QAM		
		Low CH	Mid CH	High CH	Low CH	Mid CH	High CH	Low CH	Mid CH	High CH	Low CH	Mid CH	High CH
		2428	2525	2622	2428	2525	2622	2428	2525	2622	2428	2525	2622
		871.8 MHz	881.5 MHz	891.2 MHz	871.8 MHz	881.5 MHz	891.2 MHz	871.8 MHz	881.5 MHz	891.2 MHz	871.8 MHz	881.5 MHz	891.2 MHz
multi-carrier / 1.4M +1.4M +1.4M +1.4M	Chain 0	36.81	36.85	36.81	36.82	36.83	36.82	36.85	36.84	36.83	36.81	36.82	36.85
	Chain 1	36.83	36.89	36.84	36.83	36.85	36.86	36.83	36.88	36.82	36.86	36.88	36.86
	Chain 2	36.80	36.81	36.83	36.85	36.86	36.85	36.84	36.87	36.85	36.80	36.86	36.80
	Chain 3	36.83	36.82	36.81	36.82	36.84	36.81	36.87	36.85	36.86	36.85	36.86	36.84

Band / BW	Ant	QPSK			16QAM			64QAM			256QAM		
		Low CH	Mid CH	High CH	Low CH	Mid CH	High CH	Low CH	Mid CH	High CH	Low CH	Mid CH	High CH
		2460	2525	2590	2460	2525	2590	2460	2525	2590	2460	2525	2590
		875 MHz	881.5 MHz	888 MHz	875 MHz	881.5 MHz	888 MHz	875 MHz	881.5 MHz	888 MHz	875 MHz	881.5 MHz	888 MHz
multi-carrier / 3M +3M +3M +3M	Chain 0	36.78	36.82	36.80	36.80	36.82	36.81	36.83	36.82	36.84	36.82	36.81	36.81
	Chain 1	36.80	36.90	36.87	36.79	36.88	36.84	36.85	36.88	36.81	36.83	36.88	36.85
	Chain 2	36.77	36.85	36.86	36.81	36.87	36.85	36.81	36.86	36.82	36.80	36.84	36.83
	Chain 3	36.82	36.84	36.83	36.78	36.84	36.83	36.86	36.84	36.85	36.85	36.83	36.82

Band / BW	Ant	QPSK		16QAM		64QAM		256QAM	
		Low CH	High CH	Low CH	High CH	Low CH	High CH	Low CH	High CH
		2500	2550	2500	2550	2500	2550	2500	2550
		879 MHz	884 MHz	879 MHz	884 MHz	879 MHz	884 MHz	879 MHz	884 MHz
multi-carrier / 5M +5M +5M +5M	Chain 0	36.87	36.82	36.86	36.85	36.85	36.84	36.87	36.83
	Chain 1	36.90	36.88	36.91	36.88	36.90	36.87	36.89	36.87
	Chain 2	36.91	36.87	36.87	36.87	36.88	36.86	36.88	36.85
	Chain 3	36.85	36.85	36.86	36.86	36.88	36.85	36.88	36.84

Band / BW	Ant	QPSK	16QAM	64QAM	256QAM
		Mid CH	Mid CH	Mid CH	Mid CH
		2525	2525	2525	2525
		881.5 MHz	881.5 MHz	881.5 MHz	881.5 MHz
multi-carrier / 10M+10M+5M	Chain 0	36.92	36.91	36.89	36.88
	Chain 1	36.96	36.96	36.94	36.90
	Chain 2	36.95	36.92	36.91	36.85
	Chain 3	36.87	36.97	36.93	36.88

ERP Power

Band / BW	Ant	QPSK			16QAM			64QAM			256QAM		
		Low CH	Mid CH	High CH	Low CH	Mid CH	High CH	Low CH	Mid CH	High CH	Low CH	Mid CH	High CH
		2407	2525	2643	2407	2525	2643	2407	2525	2643	2407	2525	2643
		869.7 MHz	881.5 MHz	893.3 MHz	869.7 MHz	881.5 MHz	893.3 MHz	869.7 MHz	881.5 MHz	893.3 MHz	869.7 MHz	881.5 MHz	893.3 MHz
5 / 1.4M	Chain 0	42.87	42.88	42.38	42.84	42.84	42.32	42.82	42.82	42.29	42.80	42.79	42.26
	Chain 1	42.86	42.88	42.45	42.80	42.83	42.38	42.78	42.81	42.33	42.76	42.78	42.32
	Chain 2	42.90	42.93	42.48	42.87	42.90	42.40	42.83	42.87	42.41	42.80	42.82	42.39
	Chain 3	42.86	42.87	42.33	42.83	42.80	42.33	42.81	42.78	42.24	42.77	42.74	42.29

Band / BW	Ant	QPSK			16QAM			64QAM			256QAM		
		Low CH	Mid CH	High CH	Low CH	Mid CH	High CH	Low CH	Mid CH	High CH	Low CH	Mid CH	High CH
		2415	2525	2635	2415	2525	2635	2415	2525	2635	2415	2525	2635
		870.5 MHz	881.5 MHz	892.5 MHz	870.5 MHz	881.5 MHz	892.5 MHz	870.5 MHz	881.5 MHz	892.5 MHz	870.5 MHz	881.5 MHz	892.5 MHz
5 / 3M	Chain 0	42.73	42.84	42.58	42.72	42.81	42.56	42.69	42.78	42.54	42.66	42.72	42.48
	Chain 1	42.83	42.93	42.68	42.80	42.88	42.63	42.78	42.83	42.58	42.74	42.79	42.53
	Chain 2	42.86	42.95	42.70	42.82	42.89	42.64	42.77	42.84	42.62	42.73	42.78	42.58
	Chain 3	42.82	42.89	42.61	42.79	42.84	42.57	42.75	42.78	42.53	42.70	42.72	42.47

Band / BW	Ant	QPSK			16QAM			64QAM			256QAM		
		Low CH	Mid CH	High CH	Low CH	Mid CH	High CH	Low CH	Mid CH	High CH	Low CH	Mid CH	High CH
		2425	2525	2625	2425	2525	2625	2425	2525	2625	2425	2525	2625
		871.5 MHz	881.5 MHz	891.5 MHz	871.5 MHz	881.5 MHz	891.5 MHz	871.5 MHz	881.5 MHz	891.5 MHz	871.5 MHz	881.5 MHz	891.5 MHz
5 / 5M	Chain 0	42.84	42.83	42.74	42.80	42.82	42.72	42.73	42.79	42.70	42.70	42.76	42.66
	Chain 1	42.85	42.88	42.71	42.83	42.84	42.68	42.77	42.80	42.63	42.74	42.77	42.59
	Chain 2	42.83	42.90	42.73	42.79	42.86	42.69	42.76	42.82	42.64	42.72	42.78	42.60
	Chain 3	42.88	42.86	42.72	42.84	42.80	42.67	42.79	42.76	42.63	42.74	42.71	42.58

Band / BW	Ant	QPSK			16QAM			64QAM			256QAM		
		Low CH	Mid CH	High CH	Low CH	Mid CH	High CH	Low CH	Mid CH	High CH	Low CH	Mid CH	High CH
		2450	2525	2600	2450	2525	2600	2450	2525	2600	2450	2525	2600
		874 MHz	881.5 MHz	889 MHz	874 MHz	881.5 MHz	889 MHz	874 MHz	881.5 MHz	889 MHz	874 MHz	881.5 MHz	889 MHz
5 / 10M	Chain 0	42.89	42.81	42.89	42.87	42.77	42.86	42.83	42.74	42.82	42.78	42.69	42.78
	Chain 1	42.93	42.81	42.95	42.88	42.78	42.90	42.82	42.73	42.84	42.77	42.70	42.79
	Chain 2	42.84	42.84	42.89	42.80	42.79	42.84	42.76	42.76	42.79	42.72	42.72	42.74
	Chain 3	42.87	42.86	42.87	42.83	42.82	42.82	42.79	42.77	42.76	42.73	42.73	42.72

Band / BW	Ant	QPSK			16QAM			64QAM			256QAM		
		Low CH	Mid CH	High CH	Low CH	Mid CH	High CH	Low CH	Mid CH	High CH	Low CH	Mid CH	High CH
		2428	2525	2622	2428	2525	2622	2428	2525	2622	2428	2525	2622
		871.8	881.5	891.2	871.8	881.5	891.2	871.8	881.5	891.2	871.8	881.5	891.2
		MHz	MHz	MHz	MHz	MHz	MHz	MHz	MHz	MHz	MHz	MHz	MHz
multi-carrier / 1.4M +1.4M +1.4M +1.4M	Chain 0	42.66	42.70	42.66	42.67	42.68	42.67	42.70	42.69	42.68	42.66	42.67	42.70
	Chain 1	42.68	42.74	42.69	42.68	42.70	42.71	42.68	42.73	42.67	42.71	42.73	42.71
	Chain 2	42.65	42.66	42.68	42.70	42.71	42.70	42.69	42.72	42.70	42.65	42.71	42.65
	Chain 3	42.68	42.67	42.66	42.67	42.69	42.66	42.72	42.70	42.71	42.70	42.71	42.69

Band / BW	Ant	QPSK			16QAM			64QAM			256QAM		
		Low CH	Mid CH	High CH	Low CH	Mid CH	High CH	Low CH	Mid CH	High CH	Low CH	Mid CH	High CH
		2460	2525	2590	2460	2525	2590	2460	2525	2590	2460	2525	2590
		875	881.5	888	875	881.5	888	875	881.5	888	875	881.5	888
		MHz	MHz	MHz	MHz	MHz	MHz	MHz	MHz	MHz	MHz	MHz	MHz
multi-carrier / 3M +3M +3M +3M	Chain 0	42.63	42.67	42.65	42.65	42.67	42.66	42.68	42.67	42.69	42.67	42.66	42.66
	Chain 1	42.65	42.75	42.72	42.64	42.73	42.69	42.70	42.73	42.66	42.68	42.73	42.70
	Chain 2	42.62	42.70	42.71	42.66	42.72	42.70	42.66	42.71	42.67	42.65	42.69	42.68
	Chain 3	42.67	42.69	42.68	42.63	42.69	42.68	42.71	42.69	42.70	42.70	42.68	42.67

Band / BW	Ant	QPSK		16QAM		64QAM		256QAM	
		Low CH	High CH	Low CH	High CH	Low CH	High CH	Low CH	High CH
		2500	2550	2500	2550	2500	2550	2500	2550
		879	884	879	884	879	884	879	884
		MHz	MHz	MHz	MHz	MHz	MHz	MHz	MHz
multi-carrier / 5M +5M +5M +5M	Chain 0	36.87	36.82	36.86	36.85	36.85	36.84	36.87	36.83
	Chain 1	36.90	36.88	36.91	36.88	36.90	36.87	36.89	36.87
	Chain 2	36.91	36.87	36.87	36.87	36.88	36.86	36.88	36.85
	Chain 3	36.85	36.85	36.86	36.86	36.88	36.85	36.88	36.84

Band / BW	Ant	QPSK	16QAM	64QAM	256QAM
		Mid CH	Mid CH	Mid CH	Mid CH
		2525	2525	2525	2525
		881.5	881.5	881.5	881.5
		MHz	MHz	MHz	MHz
multi-carrier / 10M +10M +5M	Chain 0	42.77	42.76	42.74	42.73
	Chain 1	42.81	42.70	42.79	42.75
	Chain 2	42.80	42.77	42.76	42.70
	Chain 3	42.72	42.77	42.78	42.73

Note: ERP (dBm) = Conducted Output Power (dBm) + antenna gain (dBi) – 2.15.

For 2TX:

Conducted Output Power (dBm)

Band / BW	Ant	QPSK			16QAM			64QAM			256QAM		
		Low CH	Mid CH	High CH	Low CH	Mid CH	High CH	Low CH	Mid CH	High CH	Low CH	Mid CH	High CH
		2407	2525	2643	2407	2525	2643	2407	2525	2643	2407	2525	2643
		869.7 MHz	881.5 MHz	893.3 MHz	869.7 MHz	881.5 MHz	893.3 MHz	869.7 MHz	881.5 MHz	893.3 MHz	869.7 MHz	881.5 MHz	893.3 MHz
5 / 1.4M	Chain 1	37.01	37.08	36.60	36.95	37.05	36.53	36.93	37.02	36.48	36.91	36.97	36.47
	Chain 2	37.05	37.04	36.63	37.02	37.03	36.55	36.98	36.98	36.56	36.95	36.62	36.54
	Total Power	40.04	40.07	39.63	40.00	40.05	39.55	39.97	40.01	39.53	39.94	39.81	39.52

Band / BW	Ant	QPSK			16QAM			64QAM			256QAM		
		Low CH	Mid CH	High CH	Low CH	Mid CH	High CH	Low CH	Mid CH	High CH	Low CH	Mid CH	High CH
		2415	2525	2635	2415	2525	2635	2415	2525	2635	2415	2525	2635
		870.5 MHz	881.5 MHz	892.5 MHz	870.5 MHz	881.5 MHz	892.5 MHz	870.5 MHz	881.5 MHz	892.5 MHz	870.5 MHz	881.5 MHz	892.5 MHz
5 / 3M	Chain 1	36.98	37.10	36.83	36.95	37.04	36.78	36.93	36.99	36.73	36.89	36.94	36.68
	Chain 2	37.01	37.08	36.85	36.97	37.03	36.79	36.92	36.98	36.77	36.88	36.93	36.73
	Total Power	40.01	40.10	39.85	39.97	40.05	39.80	39.94	40.00	39.76	39.90	39.95	39.72

Band / BW	Ant	QPSK			16QAM			64QAM			256QAM		
		Low CH	Mid CH	High CH	Low CH	Mid CH	High CH	Low CH	Mid CH	High CH	Low CH	Mid CH	High CH
		2425	2525	2625	2425	2525	2625	2425	2525	2625	2425	2525	2625
		871.5 MHz	881.5 MHz	891.5 MHz	871.5 MHz	881.5 MHz	891.5 MHz	871.5 MHz	881.5 MHz	891.5 MHz	871.5 MHz	881.5 MHz	891.5 MHz
5 / 5M	Chain 1	37.00	37.05	36.86	36.98	37.07	36.83	36.92	36.97	36.78	36.89	36.93	36.74
	Chain 2	36.98	37.03	36.88	36.94	36.99	36.84	36.91	36.95	36.79	36.87	36.92	36.75
	Total Power	40.00	40.05	39.88	39.97	40.04	39.85	39.93	39.97	39.80	39.89	39.94	39.76

Band / BW	Ant	QPSK			16QAM			64QAM			256QAM		
		Low CH	Mid CH	High CH	Low CH	Mid CH	High CH	Low CH	Mid CH	High CH	Low CH	Mid CH	High CH
		2450	2525	2600	2450	2525	2600	2450	2525	2600	2450	2525	2600
		874 MHz	881.5 MHz	889 MHz	874 MHz	881.5 MHz	889 MHz	874 MHz	881.5 MHz	889 MHz	874 MHz	881.5 MHz	889 MHz
5 / 10M	Chain 1	37.08	36.96	37.10	37.03	36.93	37.05	36.97	36.88	36.99	36.92	36.88	36.94
	Chain 2	36.99	36.99	37.04	36.95	36.94	37.02	36.96	36.91	36.97	36.91	36.87	36.92
	Total Power	40.05	39.99	40.08	40.00	39.95	40.05	39.98	39.91	39.99	39.93	39.89	39.94

Band / BW	Ant	QPSK			16QAM			64QAM			256QAM		
		Low CH	Mid CH	High CH	Low CH	Mid CH	High CH	Low CH	Mid CH	High CH	Low CH	Mid CH	High CH
		2428	2525	2622	2428	2525	2622	2428	2525	2622	2428	2525	2622
		871.8 MHz	881.5 MHz	891.2 MHz	871.8 MHz	881.5 MHz	891.2 MHz	871.8 MHz	881.5 MHz	891.2 MHz	871.8 MHz	881.5 MHz	891.2 MHz
multi-carrier / 1.4M +1.4M +1.4M +1.4M	Chain 1	36.83	36.89	36.84	36.83	36.85	36.86	36.83	36.88	36.82	36.86	36.88	36.86
	Chain 2	36.80	36.81	36.83	36.85	36.86	36.85	36.84	36.87	36.85	36.80	36.86	36.80
	Total Power	39.83	39.86	39.85	39.85	39.87	39.87	39.85	39.89	39.85	39.84	39.88	39.84

Band / BW	Ant	QPSK			16QAM			64QAM			256QAM		
		Low CH	Mid CH	High CH	Low CH	Mid CH	High CH	Low CH	Mid CH	High CH	Low CH	Mid CH	High CH
		2460	2525	2590	2460	2525	2590	2460	2525	2590	2460	2525	2590
		875 MHz	881.5 MHz	888 MHz	875 MHz	881.5 MHz	888 MHz	875 MHz	881.5 MHz	888 MHz	875 MHz	881.5 MHz	888 MHz
multi-carrier / 3M +3M +3M +3M	Chain 1	36.80	36.90	36.87	36.79	36.88	36.84	36.85	36.88	36.81	36.83	36.88	36.85
	Chain 2	36.77	36.85	36.86	36.81	36.87	36.85	36.81	36.86	36.82	36.80	36.84	36.83
	Total Power	39.80	39.89	39.88	39.81	39.89	39.86	39.84	39.88	39.83	39.83	39.87	39.85

Band / BW	Ant	QPSK		16QAM		64QAM		256QAM	
		Low CH	High CH	Low CH	High CH	Low CH	High CH	Low CH	High CH
		2500	2550	2500	2550	2500	2550	2500	2550
		879 MHz	884 MHz	879 MHz	884 MHz	879 MHz	884 MHz	879 MHz	884 MHz
multi-carrier / 5M +5M +5M +5M	Chain 1	36.90	36.88	36.91	36.88	36.90	36.87	36.89	36.87
	Chain 2	36.91	36.87	36.87	36.87	36.88	36.86	36.88	36.85
	Total Power	39.92	39.89	39.90	39.89	39.90	39.88	39.90	39.87

Band / BW	Ant	QPSK	16QAM	64QAM	256QAM
		Mid CH	Mid CH	Mid CH	Mid CH
		2525	2525	2525	2525
		881.5 MHz	881.5 MHz	881.5 MHz	881.5 MHz
multi-carrier / 10M+10M+5M	Chain 1	36.96	36.93	36.94	36.90
	Chain 2	36.95	36.92	36.91	36.89
	Total Power	39.97	39.94	39.94	39.91

Note: The 2TX MIMO power was select worst 2 chain total calculation.

ERP Power

Band / BW	Ant	QPSK			16QAM			64QAM			256QAM		
		Low CH	Mid CH	High CH	Low CH	Mid CH	High CH	Low CH	Mid CH	High CH	Low CH	Mid CH	High CH
		2407	2525	2643	2407	2525	2643	2407	2525	2643	2407	2525	2643
		869.7 MHz	881.5 MHz	893.3 MHz	869.7 MHz	881.5 MHz	893.3 MHz	869.7 MHz	881.5 MHz	893.3 MHz	869.7 MHz	881.5 MHz	893.3 MHz
5 / 1.4M	Total Power	40.04	40.07	39.63	40.00	40.05	39.55	39.97	40.01	39.53	39.94	39.81	39.52
	Directional Gain	11.01	11.01	11.01	11.01	11.01	11.01	11.01	11.01	11.01	11.01	11.01	11.01
	ERP	48.90	48.93	48.49	48.86	48.91	48.41	48.83	48.87	48.39	48.80	48.67	48.38

Band / BW	Ant	QPSK			16QAM			64QAM			256QAM		
		Low CH	Mid CH	High CH	Low CH	Mid CH	High CH	Low CH	Mid CH	High CH	Low CH	Mid CH	High CH
		2415	2525	2635	2415	2525	2635	2415	2525	2635	2415	2525	2635
		870.5 MHz	881.5 MHz	892.5 MHz	870.5 MHz	881.5 MHz	892.5 MHz	870.5 MHz	881.5 MHz	892.5 MHz	870.5 MHz	881.5 MHz	892.5 MHz
5 / 3M	Total Power	40.01	40.10	39.85	39.97	40.05	39.80	39.94	40.00	39.76	39.90	39.95	39.72
	Directional Gain	11.01	11.01	11.01	11.01	11.01	11.01	11.01	11.01	11.01	11.01	11.01	11.01
	ERP	48.87	48.96	48.71	48.83	48.91	48.66	48.80	48.86	48.62	48.76	48.81	48.58

Band / BW	Ant	QPSK			16QAM			64QAM			256QAM		
		Low CH	Mid CH	High CH	Low CH	Mid CH	High CH	Low CH	Mid CH	High CH	Low CH	Mid CH	High CH
		2425	2525	2625	2425	2525	2625	2425	2525	2625	2425	2525	2625
		871.5 MHz	881.5 MHz	891.5 MHz	871.5 MHz	881.5 MHz	891.5 MHz	871.5 MHz	881.5 MHz	891.5 MHz	871.5 MHz	881.5 MHz	891.5 MHz
5 / 5M	Total Power	40.00	40.05	39.88	39.97	40.04	39.85	39.93	39.97	39.80	39.89	39.94	39.76
	Directional Gain	11.01	11.01	11.01	11.01	11.01	11.01	11.01	11.01	11.01	11.01	11.01	11.01
	ERP	48.86	48.91	48.74	48.83	48.90	48.71	48.79	48.83	48.66	48.75	48.80	48.62

Band / BW	Ant	QPSK			16QAM			64QAM			256QAM		
		Low CH	Mid CH	High CH	Low CH	Mid CH	High CH	Low CH	Mid CH	High CH	Low CH	Mid CH	High CH
		2450	2525	2600	2450	2525	2600	2450	2525	2600	2450	2525	2600
		874 MHz	881.5 MHz	889 MHz	874 MHz	881.5 MHz	889 MHz	874 MHz	881.5 MHz	889 MHz	874 MHz	881.5 MHz	889 MHz
5 / 10M	Total Power	40.05	39.99	40.08	40.00	39.95	40.05	39.98	39.91	39.99	39.93	39.89	39.94
	Directional Gain	11.01	11.01	11.01	11.01	11.01	11.01	11.01	11.01	11.01	11.01	11.01	11.01
	ERP	48.91	48.85	48.94	48.86	48.81	48.91	48.84	48.77	48.85	48.79	48.75	48.80

Band / BW	Ant	QPSK			16QAM			64QAM			256QAM		
		Low CH	Mid CH	High CH	Low CH	Mid CH	High CH	Low CH	Mid CH	High CH	Low CH	Mid CH	High CH
		2428	2525	2622	2428	2525	2622	2428	2525	2622	2428	2525	2622
		871.8 MHz	881.5 MHz	891.2 MHz	871.8 MHz	881.5 MHz	891.2 MHz	871.8 MHz	881.5 MHz	891.2 MHz	871.8 MHz	881.5 MHz	891.2 MHz
multi-carrier / 1.4M +1.4M +1.4M+ 1.4M	Total Power	39.83	39.86	39.85	39.85	39.87	39.87	39.85	39.89	39.85	39.84	39.88	39.84
	Directional Gain	11.01	11.01	11.01	11.01	11.01	11.01	11.01	11.01	11.01	11.01	11.01	11.01
	ERP	48.69	48.72	48.71	48.71	48.73	48.73	48.71	48.75	48.71	48.70	48.74	48.70

Band / BW	Ant	QPSK			16QAM			64QAM			256QAM		
		Low CH	Mid CH	High CH	Low CH	Mid CH	High CH	Low CH	Mid CH	High CH	Low CH	Mid CH	High CH
		2460	2525	2590	2460	2525	2590	2460	2525	2590	2460	2525	2590
		875 MHz	881.5 MHz	888 MHz	875 MHz	881.5 MHz	888 MHz	875 MHz	881.5 MHz	888 MHz	875 MHz	881.5 MHz	888 MHz
multi-carrier / 3M +3M +3M +3M	Total Power	39.80	39.89	39.88	39.81	39.89	39.86	39.84	39.88	39.83	39.83	39.87	39.85
	Directional Gain	11.01	11.01	11.01	11.01	11.01	11.01	11.01	11.01	11.01	11.01	11.01	11.01
	ERP	48.66	48.75	48.74	48.67	48.75	48.72	48.70	48.74	48.69	48.69	48.73	48.71

Band / BW	Ant	QPSK		16QAM		64QAM		256QAM	
		Low CH	High CH	Low CH	High CH	Low CH	High CH	Low CH	High CH
		2500	2550	2500	2550	2500	2550	2500	2550
		879 MHz	884 MHz	879 MHz	884 MHz	879 MHz	884 MHz	879 MHz	884 MHz
multi-carrier / 5M +5M +5M +5M	Total Power	39.92	39.89	39.90	39.89	39.90	39.88	39.90	39.87
	Directional Gain	11.01	11.01	11.01	11.01	11.01	11.01	11.01	11.01
	ERP	48.78	48.75	48.76	48.75	48.76	48.74	48.76	48.73

Band / BW	Ant	QPSK	16QAM	64QAM	256QAM
		Mid CH	Mid CH	Mid CH	Mid CH
		2525	2525	2525	2525
		881.5 MHz	881.5 MHz	881.5 MHz	881.5 MHz
multi-carrier / 10M+10 M+5M	Total Power	39.97	39.94	39.94	39.91
	Directional Gain	11.01	11.01	11.01	11.01
	ERP	48.83	48.80	48.80	48.77

**Note:**

1. ERP (dBm) = Conducted Output Power (dBm) + antenna gain (dBi) – 2.15.
2. The 2TX MIMO power was select worst 2 chain total calculation.



For 3TX:

Conducted Output Power (dBm)

Band / BW	Ant	QPSK			16QAM			64QAM			256QAM		
		Low CH	Mid CH	High CH	Low CH	Mid CH	High CH	Low CH	Mid CH	High CH	Low CH	Mid CH	High CH
		2407	2525	2643	2407	2525	2643	2407	2525	2643	2407	2525	2643
		869.7 MHz	881.5 MHz	893.3 MHz	869.7 MHz	881.5 MHz	893.3 MHz	869.7 MHz	881.5 MHz	893.3 MHz	869.7 MHz	881.5 MHz	893.3 MHz
5 / 1.4M	Chain 1	37.01	37.08	36.60	36.95	37.05	36.53	36.93	37.02	36.48	36.91	36.97	36.47
	Chain 2	37.05	37.04	36.63	37.02	37.03	36.55	36.98	36.98	36.56	36.95	36.62	36.54
	Chain 3	37.01	37.02	36.48	36.98	36.95	36.48	36.96	36.93	36.39	36.92	36.89	36.44
	Total Power	41.79	41.82	41.34	41.75	41.78	41.29	41.73	41.75	41.25	41.70	41.60	41.25

Band / BW	Ant	QPSK			16QAM			64QAM			256QAM		
		Low CH	Mid CH	High CH	Low CH	Mid CH	High CH	Low CH	Mid CH	High CH	Low CH	Mid CH	High CH
		2415	2525	2635	2415	2525	2635	2415	2525	2635	2415	2525	2635
		870.5 MHz	881.5 MHz	892.5 MHz	870.5 MHz	881.5 MHz	892.5 MHz	870.5 MHz	881.5 MHz	892.5 MHz	870.5 MHz	881.5 MHz	892.5 MHz
5 / 3M	Chain 1	36.98	37.10	36.83	36.95	37.04	36.78	36.93	36.99	36.73	36.89	36.94	36.68
	Chain 2	37.01	37.08	36.85	36.97	37.03	36.79	36.92	36.98	36.77	36.88	36.93	36.73
	Chain 3	36.97	37.04	36.76	36.94	36.99	36.72	36.9	36.93	36.68	36.85	36.87	36.62
	Total Power	41.76	41.84	41.58	41.72	41.79	41.53	41.69	41.74	41.50	41.64	41.68	41.45

Band / BW	Ant	QPSK			16QAM			64QAM			256QAM		
		Low CH	Mid CH	High CH	Low CH	Mid CH	High CH	Low CH	Mid CH	High CH	Low CH	Mid CH	High CH
		2425	2525	2625	2425	2525	2625	2425	2525	2625	2425	2525	2625
		871.5 MHz	881.5 MHz	891.5 MHz	871.5 MHz	881.5 MHz	891.5 MHz	871.5 MHz	881.5 MHz	891.5 MHz	871.5 MHz	881.5 MHz	891.5 MHz
5 / 5M	Chain 1	37.00	37.05	36.86	36.98	37.07	36.83	36.92	36.97	36.78	36.89	36.93	36.74
	Chain 2	36.98	37.03	36.88	36.94	36.99	36.84	36.91	36.95	36.79	36.87	36.92	36.75
	Chain 3	37.03	37.01	36.87	36.99	36.95	36.82	36.94	36.91	36.78	36.89	36.86	36.73
	Total Power	41.77	41.80	41.64	41.74	41.77	41.60	41.69	41.71	41.55	41.65	41.67	41.51

Band / BW	Ant	QPSK			16QAM			64QAM			256QAM		
		Low CH	Mid CH	High CH	Low CH	Mid CH	High CH	Low CH	Mid CH	High CH	Low CH	Mid CH	High CH
		2450	2525	2600	2450	2525	2600	2450	2525	2600	2450	2525	2600
		874 MHz	881.5 MHz	889 MHz	874 MHz	881.5 MHz	889 MHz	874 MHz	881.5 MHz	889 MHz	874 MHz	881.5 MHz	889 MHz
5 / 10M	Chain 1	37.08	36.96	37.10	37.03	36.93	37.05	36.97	36.88	36.99	36.92	36.88	36.94
	Chain 2	36.99	36.99	37.04	36.95	36.94	37.02	36.96	36.91	36.97	36.91	36.87	36.92
	Chain 3	37.02	37.01	37.02	36.98	36.97	36.97	36.94	36.92	36.91	36.88	36.88	36.87
	Total Power	41.80	41.76	41.82	41.76	41.72	41.78	41.73	41.67	41.73	41.67	41.65	41.68

Band / BW	Ant	QPSK			16QAM			64QAM			256QAM		
		Low CH	Mid CH	High CH	Low CH	Mid CH	High CH	Low CH	Mid CH	High CH	Low CH	Mid CH	High CH
		2428	2525	2622	2428	2525	2622	2428	2525	2622	2428	2525	2622
		871.8 MHz	881.5 MHz	891.2 MHz	871.8 MHz	881.5 MHz	891.2 MHz	871.8 MHz	881.5 MHz	891.2 MHz	871.8 MHz	881.5 MHz	891.2 MHz
multi-carrier / 1.4M +1.4M +1.4M +1.4M	Chain 1	36.83	36.89	36.84	36.83	36.85	36.86	36.83	36.88	36.82	36.86	36.88	36.86
	Chain 2	36.80	36.81	36.83	36.85	36.86	36.85	36.84	36.87	36.85	36.80	36.86	36.80
	Chain 3	36.83	36.82	36.81	36.82	36.84	36.81	36.87	36.85	36.86	36.85	36.86	36.84
	Total Power	41.59	41.61	41.60	41.60	41.62	41.61	41.62	41.64	41.61	41.61	41.64	41.60

Band / BW	Ant	QPSK			16QAM			64QAM			256QAM		
		Low CH	Mid CH	High CH	Low CH	Mid CH	High CH	Low CH	Mid CH	High CH	Low CH	Mid CH	High CH
		2460	2525	2590	2460	2525	2590	2460	2525	2590	2460	2525	2590
		875 MHz	881.5 MHz	888 MHz	875 MHz	881.5 MHz	888 MHz	875 MHz	881.5 MHz	888 MHz	875 MHz	881.5 MHz	888 MHz
multi-carrier / 3M +3M +3M +3M	Chain 1	36.80	36.90	36.87	36.79	36.88	36.84	36.85	36.88	36.81	36.83	36.88	36.85
	Chain 2	36.77	36.85	36.86	36.81	36.87	36.85	36.81	36.86	36.82	36.80	36.84	36.83
	Chain 3	36.82	36.84	36.83	36.78	36.84	36.83	36.86	36.84	36.85	36.85	36.83	36.82
	Total Power	41.57	41.63	41.62	41.56	41.63	41.61	41.61	41.63	41.60	41.60	41.62	41.60

Band / BW	Ant	QPSK		16QAM		64QAM		256QAM	
		Low CH	High CH	Low CH	High CH	Low CH	High CH	Low CH	High CH
		2500	2550	2500	2550	2500	2550	2500	2550
		879 MHz	884 MHz	879 MHz	884 MHz	879 MHz	884 MHz	879 MHz	884 MHz
multi-carrier / 5M +5M +5M +5M	Chain 1	36.90	36.88	36.91	36.88	36.90	36.87	36.89	36.87
	Chain 2	36.91	36.87	36.87	36.87	36.88	36.86	36.88	36.85
	Chain 3	36.85	36.85	36.86	36.86	36.88	36.85	36.88	36.84
	Total Power	41.66	41.64	41.65	41.64	41.66	41.63	41.65	41.62

Band / BW	Ant	QPSK	16QAM	64QAM	256QAM
		Mid CH	Mid CH	Mid CH	Mid CH
		2525	2525	2525	2525
		881.5 MHz	881.5 MHz	881.5 MHz	881.5 MHz
multi-carrier / 10M+10M+5M	Chain 1	36.96	36.93	36.94	36.90
	Chain 2	36.95	36.92	36.91	36.89
	Chain 3	36.87	36.92	36.93	36.88
	Total Power	41.70	41.69	41.70	41.66

Note: The 3TX MIMO power was select worst 3 chain total calculation.

ERP Power

Band / BW	Ant	QPSK			16QAM			64QAM			256QAM		
		Low CH	Mid CH	High CH	Low CH	Mid CH	High CH	Low CH	Mid CH	High CH	Low CH	Mid CH	High CH
		2407	2525	2643	2407	2525	2643	2407	2525	2643	2407	2525	2643
		869.7 MHz	881.5 MHz	893.3 MHz	869.7 MHz	881.5 MHz	893.3 MHz	869.7 MHz	881.5 MHz	893.3 MHz	869.7 MHz	881.5 MHz	893.3 MHz
5 / 1.4M	Total Power	41.79	41.82	41.34	41.75	41.78	41.29	41.73	41.75	41.25	41.70	41.60	41.25
	Directional Gain	12.77	12.77	12.77	12.77	12.77	12.77	12.77	12.77	12.77	12.77	12.77	12.77
	ERP	52.41	52.44	51.96	52.37	52.40	51.91	52.35	52.37	51.87	52.32	52.22	51.87

Band / BW	Ant	QPSK			16QAM			64QAM			256QAM		
		Low CH	Mid CH	High CH	Low CH	Mid CH	High CH	Low CH	Mid CH	High CH	Low CH	Mid CH	High CH
		2415	2525	2635	2415	2525	2635	2415	2525	2635	2415	2525	2635
		870.5 MHz	881.5 MHz	892.5 MHz	870.5 MHz	881.5 MHz	892.5 MHz	870.5 MHz	881.5 MHz	892.5 MHz	870.5 MHz	881.5 MHz	892.5 MHz
5 / 3M	Total Power	41.76	41.84	41.58	41.72	41.79	41.53	41.69	41.74	41.50	41.64	41.68	41.45
	Directional Gain	12.77	12.77	12.77	12.77	12.77	12.77	12.77	12.77	12.77	12.77	12.77	12.77
	ERP	52.38	52.46	52.20	52.34	52.41	52.15	52.31	52.36	52.12	52.26	52.30	52.07

Band / BW	Ant	QPSK			16QAM			64QAM			256QAM		
		Low CH	Mid CH	High CH	Low CH	Mid CH	High CH	Low CH	Mid CH	High CH	Low CH	Mid CH	High CH
		2425	2525	2625	2425	2525	2625	2425	2525	2625	2425	2525	2625
		871.5 MHz	881.5 MHz	891.5 MHz	871.5 MHz	881.5 MHz	891.5 MHz	871.5 MHz	881.5 MHz	891.5 MHz	871.5 MHz	881.5 MHz	891.5 MHz
5 / 5M	Total Power	41.77	41.80	41.64	41.74	41.77	41.60	41.69	41.71	41.55	41.65	41.67	41.51
	Directional Gain	12.77	12.77	12.77	12.77	12.77	12.77	12.77	12.77	12.77	12.77	12.77	12.77
	ERP	52.39	52.42	52.26	52.36	52.39	52.22	52.31	52.33	52.17	52.27	52.29	52.13

Band / BW	Ant	QPSK			16QAM			64QAM			256QAM		
		Low CH	Mid CH	High CH	Low CH	Mid CH	High CH	Low CH	Mid CH	High CH	Low CH	Mid CH	High CH
		2450	2525	2600	2450	2525	2600	2450	2525	2600	2450	2525	2600
		874 MHz	881.5 MHz	889 MHz	874 MHz	881.5 MHz	889 MHz	874 MHz	881.5 MHz	889 MHz	874 MHz	881.5 MHz	889 MHz
5 / 10M	Total Power	41.80	41.76	41.82	41.76	41.72	41.78	41.73	41.67	41.73	41.67	41.65	41.68
	Directional Gain	12.77	12.77	12.77	12.77	12.77	12.77	12.77	12.77	12.77	12.77	12.77	12.77
	ERP	52.42	52.38	52.44	52.38	52.34	52.40	52.35	52.29	52.35	52.29	52.27	52.30

Band / BW	Ant	QPSK			16QAM			64QAM			256QAM		
		Low CH	Mid CH	High CH	Low CH	Mid CH	High CH	Low CH	Mid CH	High CH	Low CH	Mid CH	High CH
		2428	2525	2622	2428	2525	2622	2428	2525	2622	2428	2525	2622
		871.8 MHz	881.5 MHz	891.2 MHz	871.8 MHz	881.5 MHz	891.2 MHz	871.8 MHz	881.5 MHz	891.2 MHz	871.8 MHz	881.5 MHz	891.2 MHz
multi-carrier / 1.4M +1.4M +1.4M +1.4M	Total Power	41.59	41.61	41.60	41.60	41.62	41.61	41.62	41.64	41.61	41.61	41.64	41.60
	Directional Gain	12.77	12.77	12.77	12.77	12.77	12.77	12.77	12.77	12.77	12.77	12.77	12.77
	ERP	52.21	52.23	52.22	52.22	52.24	52.23	52.24	52.26	52.23	52.23	52.26	52.22

Band / BW	Ant	QPSK			16QAM			64QAM			256QAM		
		Low CH	Mid CH	High CH	Low CH	Mid CH	High CH	Low CH	Mid CH	High CH	Low CH	Mid CH	High CH
		2460	2525	2590	2460	2525	2590	2460	2525	2590	2460	2525	2590
		875 MHz	881.5 MHz	888 MHz	875 MHz	881.5 MHz	888 MHz	875 MHz	881.5 MHz	888 MHz	875 MHz	881.5 MHz	888 MHz
multi-carrier / 3M +3M +3M +3M	Total Power	41.57	41.63	41.62	41.56	41.63	41.61	41.61	41.63	41.60	41.60	41.62	41.60
	Directional Gain	12.77	12.77	12.77	12.77	12.77	12.77	12.77	12.77	12.77	12.77	12.77	12.77
	ERP	52.19	52.25	52.24	52.18	52.25	52.23	52.23	52.25	52.22	52.22	52.24	52.22

Band / BW	Ant	QPSK		16QAM		64QAM		256QAM	
		Low CH	High CH	Low CH	High CH	Low CH	High CH	Low CH	High CH
		2500	2550	2500	2550	2500	2550	2500	2550
		879 MHz	884 MHz	879 MHz	884 MHz	879 MHz	884 MHz	879 MHz	884 MHz
multi-carrier / 5M +5M +5M +5M	Total Power	41.66	41.64	41.65	41.64	41.66	41.63	41.65	41.62
	Directional Gain	12.77	12.77	12.77	12.77	12.77	12.77	12.77	12.77
	ERP	52.28	52.26	52.27	52.26	52.28	52.25	52.27	52.24

Band / BW	Ant	QPSK	16QAM	64QAM	256QAM
		Mid CH	Mid CH	Mid CH	Mid CH
		2525	2525	2525	2525
		881.5 MHz	881.5 MHz	881.5 MHz	881.5 MHz
multi-carrier / 10M+10M+5M	Total Power	41.70	41.69	41.70	41.66
	Directional Gain	12.77	12.77	12.77	12.77
	ERP	52.32	52.31	52.32	52.28

**Note:**

1. ERP (dBm) = Conducted Output Power (dBm) + antenna gain (dBi) – 2.15.
2. The 3TX MIMO power was select worst 3 chain total calculation.

For 4TX:

Conducted Output Power (dBm)

Band / BW	Ant	QPSK			16QAM			64QAM			256QAM		
		Low CH	Mid CH	High CH	Low CH	Mid CH	High CH	Low CH	Mid CH	High CH	Low CH	Mid CH	High CH
		2407	2525	2643	2407	2525	2643	2407	2525	2643	2407	2525	2643
		869.7 MHz	881.5 MHz	893.3 MHz	869.7 MHz	881.5 MHz	893.3 MHz	869.7 MHz	881.5 MHz	893.3 MHz	869.7 MHz	881.5 MHz	893.3 MHz
5 / 1.4M	Chain 0	37.02	37.03	36.53	36.99	36.99	36.47	36.97	36.97	36.44	36.95	36.94	36.41
	Chain 1	37.01	37.08	36.60	36.95	37.05	36.53	36.93	37.02	36.48	36.91	36.97	36.47
	Chain 2	37.05	37.04	36.63	37.02	37.03	36.55	36.98	36.98	36.56	36.95	36.62	36.54
	Chain 3	37.01	37.02	36.48	36.98	36.95	36.48	36.96	36.93	36.39	36.92	36.89	36.44
	Total Power	43.04	43.06	42.58	43.01	43.03	42.53	42.98	43.00	42.49	42.95	42.88	42.49

Band / BW	Ant	QPSK			16QAM			64QAM			256QAM		
		Low CH	Mid CH	High CH	Low CH	Mid CH	High CH	Low CH	Mid CH	High CH	Low CH	Mid CH	High CH
		2415	2525	2635	2415	2525	2635	2415	2525	2635	2415	2525	2635
		870.5 MHz	881.5 MHz	892.5 MHz	870.5 MHz	881.5 MHz	892.5 MHz	870.5 MHz	881.5 MHz	892.5 MHz	870.5 MHz	881.5 MHz	892.5 MHz
5 / 3M	Chain 0	36.88	36.99	36.73	36.87	36.96	36.71	36.84	36.93	36.69	36.81	36.87	36.63
	Chain 1	36.98	37.10	36.83	36.95	37.04	36.78	36.93	36.99	36.73	36.89	36.94	36.68
	Chain 2	37.01	37.08	36.85	36.97	37.03	36.79	36.92	36.98	36.77	36.88	36.93	36.73
	Chain 3	36.97	37.04	36.76	36.94	36.99	36.72	36.9	36.93	36.68	36.85	36.87	36.62
	Total Power	42.98	43.07	42.81	42.95	43.03	42.77	42.92	42.98	42.74	42.88	42.92	42.69

Band / BW	Ant	QPSK			16QAM			64QAM			256QAM		
		Low CH	Mid CH	High CH	Low CH	Mid CH	High CH	Low CH	Mid CH	High CH	Low CH	Mid CH	High CH
		2425	2525	2625	2425	2525	2625	2425	2525	2625	2425	2525	2625
		871.5 MHz	881.5 MHz	891.5 MHz	871.5 MHz	881.5 MHz	891.5 MHz	871.5 MHz	881.5 MHz	891.5 MHz	871.5 MHz	881.5 MHz	891.5 MHz
5 / 5M	Chain 0	36.99	36.98	36.89	36.95	36.97	36.87	36.88	36.94	36.85	36.85	36.91	36.81
	Chain 1	37.00	37.05	36.86	36.98	37.07	36.83	36.92	36.97	36.78	36.89	36.93	36.74
	Chain 2	36.98	37.03	36.88	36.94	36.99	36.84	36.91	36.95	36.79	36.87	36.92	36.75
	Chain 3	37.03	37.01	36.87	36.99	36.95	36.82	36.94	36.91	36.78	36.89	36.86	36.73
	Total Power	43.02	43.04	42.90	42.99	43.02	42.86	42.93	42.96	42.82	42.90	42.93	42.78

Band / BW	Ant	QPSK			16QAM			64QAM			256QAM		
		Low CH	Mid CH	High CH	Low CH	Mid CH	High CH	Low CH	Mid CH	High CH	Low CH	Mid CH	High CH
		2450	2525	2600	2450	2525	2600	2450	2525	2600	2450	2525	2600
		874 MHz	881.5 MHz	889 MHz	874 MHz	881.5 MHz	889 MHz	874 MHz	881.5 MHz	889 MHz	874 MHz	881.5 MHz	889 MHz
5 / 10M	Chain 0	37.04	36.96	37.04	37.02	36.92	37.01	36.95	36.89	36.94	36.87	36.84	36.91
	Chain 1	37.08	36.96	37.10	37.03	36.93	37.05	36.97	36.88	36.99	36.92	36.88	36.94
	Chain 2	36.99	36.99	37.04	36.95	36.94	37.02	36.96	36.91	36.97	36.91	36.87	36.92
	Chain 3	37.02	37.01	37.02	36.98	36.97	36.97	36.94	36.92	36.91	36.88	36.88	36.87
	Total Power	43.05	43.00	43.07	43.02	42.96	43.03	42.98	42.92	42.97	42.92	42.89	42.93

Band / BW	Ant	QPSK			16QAM			64QAM			256QAM		
		Low CH	Mid CH	High CH	Low CH	Mid CH	High CH	Low CH	Mid CH	High CH	Low CH	Mid CH	High CH
		2428	2525	2622	2428	2525	2622	2428	2525	2622	2428	2525	2622
		871.8	881.5	891.2	871.8	881.5	891.2	871.8	881.5	891.2	871.8	881.5	891.2
		MHz	MHz	MHz	MHz	MHz	MHz	MHz	MHz	MHz	MHz	MHz	MHz
multi-carrier / 1.4M +1.4M +1.4M	Chain 0	36.81	36.85	36.81	36.82	36.83	36.82	36.85	36.84	36.83	36.81	36.82	36.85
	Chain 1	36.83	36.89	36.84	36.83	36.85	36.86	36.83	36.88	36.82	36.86	36.88	36.86
	Chain 2	36.80	36.81	36.83	36.85	36.86	36.85	36.84	36.87	36.85	36.80	36.86	36.80
	Chain 3	36.83	36.82	36.81	36.82	36.84	36.81	36.87	36.85	36.86	36.85	36.86	36.84
	Total Power	42.84	42.86	42.84	42.85	42.87	42.86	42.87	42.88	42.86	42.85	42.88	42.86

Band / BW	Ant	QPSK			16QAM			64QAM			256QAM		
		Low CH	Mid CH	High CH	Low CH	Mid CH	High CH	Low CH	Mid CH	High CH	Low CH	Mid CH	High CH
		2460	2525	2590	2460	2525	2590	2460	2525	2590	2460	2525	2590
		875	881.5	888	875	881.5	888	875	881.5	888	875	881.5	888
		MHz	MHz	MHz	MHz	MHz	MHz	MHz	MHz	MHz	MHz	MHz	MHz
multi-carrier / 3M +3M +3M +3M	Chain 0	36.78	36.82	36.80	36.80	36.82	36.81	36.83	36.82	36.84	36.82	36.81	36.81
	Chain 1	36.80	36.90	36.87	36.79	36.88	36.84	36.85	36.88	36.81	36.83	36.88	36.85
	Chain 2	36.77	36.85	36.86	36.81	36.87	36.85	36.81	36.86	36.82	36.80	36.84	36.83
	Chain 3	36.82	36.84	36.83	36.78	36.84	36.83	36.86	36.84	36.85	36.85	36.83	36.82
	Total Power	42.81	42.87	42.86	42.82	42.87	42.85	42.86	42.87	42.85	42.85	42.86	42.85

Band / BW	Ant	QPSK		16QAM		64QAM		256QAM	
		Low CH	High CH	Low CH	High CH	Low CH	High CH	Low CH	High CH
		2500	2550	2500	2550	2500	2550	2500	2550
		879	884	879	884	879	884	879	884
		MHz	MHz	MHz	MHz	MHz	MHz	MHz	MHz
multi-carrier / 5M +5M +5M +5M	Chain 0	36.87	36.82	36.86	36.85	36.85	36.84	36.87	36.83
	Chain 1	36.90	36.88	36.91	36.88	36.90	36.87	36.89	36.87
	Chain 2	36.91	36.87	36.87	36.87	36.88	36.86	36.88	36.85
	Chain 3	36.85	36.85	36.86	36.86	36.88	36.85	36.88	36.84
	Total Power	42.90	42.88	42.90	42.89	42.90	42.88	42.90	42.87

Band / BW	Ant	QPSK	16QAM	64QAM	256QAM
		Mid CH	Mid CH	Mid CH	Mid CH
		2525	2525	2525	2525
		881.5	881.5	881.5	881.5
		MHz	MHz	MHz	MHz
multi-carrier / 10M+10M+5M	Chain 0	36.92	36.91	36.89	36.88
	Chain 1	36.96	36.93	36.94	36.90
	Chain 2	36.95	36.92	36.91	36.89
	Chain 3	36.87	36.92	36.93	36.88
	Total Power	42.95	42.94	42.94	42.91

ERP Power

Band / BW	Ant	QPSK			16QAM			64QAM			256QAM		
		Low CH	Mid CH	High CH	Low CH	Mid CH	High CH	Low CH	Mid CH	High CH	Low CH	Mid CH	High CH
		2407	2525	2643	2407	2525	2643	2407	2525	2643	2407	2525	2643
		869.7 MHz	881.5 MHz	893.3 MHz	869.7 MHz	881.5 MHz	893.3 MHz	869.7 MHz	881.5 MHz	893.3 MHz	869.7 MHz	881.5 MHz	893.3 MHz
5 / 1.4M	Total Power	43.04	43.06	42.58	43.01	43.03	42.53	42.98	43.00	42.49	42.95	42.88	42.49
	Directional Gain	14.02	14.02	14.02	14.02	14.02	14.02	14.02	14.02	14.02	14.02	14.02	14.02
	ERP	54.91	<b>54.93</b>	54.45	54.88	54.90	54.40	54.85	54.87	54.36	54.82	54.75	54.36

Band / BW	Ant	QPSK			16QAM			64QAM			256QAM		
		Low CH	Mid CH	High CH	Low CH	Mid CH	High CH	Low CH	Mid CH	High CH	Low CH	Mid CH	High CH
		2415	2525	2635	2415	2525	2635	2415	2525	2635	2415	2525	2635
		870.5 MHz	881.5 MHz	892.5 MHz	870.5 MHz	881.5 MHz	892.5 MHz	870.5 MHz	881.5 MHz	892.5 MHz	870.5 MHz	881.5 MHz	892.5 MHz
5 / 3M	Total Power	42.98	43.07	42.81	42.95	43.03	42.77	42.92	42.98	42.74	42.88	42.92	42.69
	Directional Gain	14.02	14.02	14.02	14.02	14.02	14.02	14.02	14.02	14.02	14.02	14.02	14.02
	ERP	54.85	<b>54.94</b>	54.68	54.82	54.90	54.64	54.79	54.85	54.61	54.75	54.79	54.56

Band / BW	Ant	QPSK			16QAM			64QAM			256QAM		
		Low CH	Mid CH	High CH	Low CH	Mid CH	High CH	Low CH	Mid CH	High CH	Low CH	Mid CH	High CH
		2425	2525	2625	2425	2525	2625	2425	2525	2625	2425	2525	2625
		871.5 MHz	881.5 MHz	891.5 MHz	871.5 MHz	881.5 MHz	891.5 MHz	871.5 MHz	881.5 MHz	891.5 MHz	871.5 MHz	881.5 MHz	891.5 MHz
5 / 5M	Total Power	43.02	43.04	42.90	42.99	43.02	42.86	42.93	42.96	42.82	42.90	42.93	42.78
	Directional Gain	14.02	14.02	14.02	14.02	14.02	14.02	14.02	14.02	14.02	14.02	14.02	14.02
	ERP	54.89	<b>54.91</b>	54.77	54.86	54.89	54.73	54.80	54.83	54.69	54.77	54.80	54.65

Band / BW	Ant	QPSK			16QAM			64QAM			256QAM		
		Low CH	Mid CH	High CH	Low CH	Mid CH	High CH	Low CH	Mid CH	High CH	Low CH	Mid CH	High CH
		2450	2525	2600	2450	2525	2600	2450	2525	2600	2450	2525	2600
		874 MHz	881.5 MHz	889 MHz	874 MHz	881.5 MHz	889 MHz	874 MHz	881.5 MHz	889 MHz	874 MHz	881.5 MHz	889 MHz
5 / 10M	Total Power	43.05	43.00	43.07	43.02	42.96	43.03	42.98	42.92	42.97	42.92	42.89	42.93
	Directional Gain	14.02	14.02	14.02	14.02	14.02	14.02	14.02	14.02	14.02	14.02	14.02	14.02
	ERP	54.92	54.87	<b>54.94</b>	54.89	54.83	54.90	54.85	54.79	54.84	54.79	54.76	54.80

Band / BW	Ant	QPSK			16QAM			64QAM			256QAM		
		Low CH	Mid CH	High CH	Low CH	Mid CH	High CH	Low CH	Mid CH	High CH	Low CH	Mid CH	High CH
		2428	2525	2622	2428	2525	2622	2428	2525	2622	2428	2525	2622
		871.8 MHz	881.5 MHz	891.2 MHz	871.8 MHz	881.5 MHz	891.2 MHz	871.8 MHz	881.5 MHz	891.2 MHz	871.8 MHz	881.5 MHz	891.2 MHz
multi-carrier / 1.4M +1.4M +1.4M +1.4M	Total Power	42.84	42.86	42.84	42.85	42.87	42.86	42.87	42.88	42.86	42.85	42.88	42.86
	Directional Gain	14.02	14.02	14.02	14.02	14.02	14.02	14.02	14.02	14.02	14.02	14.02	14.02
	ERP	54.71	54.73	54.71	54.72	54.74	54.73	54.74	<b>54.75</b>	54.73	54.72	54.75	54.73

Band / BW	Ant	QPSK			16QAM			64QAM			256QAM		
		Low CH	Mid CH	High CH	Low CH	Mid CH	High CH	Low CH	Mid CH	High CH	Low CH	Mid CH	High CH
		2460	2525	2590	2460	2525	2590	2460	2525	2590	2460	2525	2590
		875 MHz	881.5 MHz	888 MHz	875 MHz	881.5 MHz	888 MHz	875 MHz	881.5 MHz	888 MHz	875 MHz	881.5 MHz	888 MHz
multi-carrier / 3M +3M +3M +3M	Total Power	42.81	42.87	42.86	42.82	42.87	42.85	42.86	42.87	42.85	42.85	42.86	42.85
	Directional Gain	14.02	14.02	14.02	14.02	14.02	14.02	14.02	14.02	14.02	14.02	14.02	14.02
	ERP	54.68	<b>54.74</b>	54.73	54.69	<b>54.74</b>	54.72	54.73	<b>54.74</b>	54.72	54.72	54.73	54.72

Band / BW	Ant	QPSK		16QAM		64QAM		256QAM	
		Low CH	High CH	Low CH	High CH	Low CH	High CH	Low CH	High CH
		2500	2550	2500	2550	2500	2550	2500	2550
		879 MHz	884 MHz	879 MHz	884 MHz	879 MHz	884 MHz	879 MHz	884 MHz
multi-carrier / 5M +5M +5M +5M	Total Power	42.90	42.88	42.90	42.89	42.90	42.88	42.90	42.87
	Directional Gain	14.02	14.02	14.02	14.02	14.02	14.02	14.02	14.02
	ERP	<b>54.77</b>	54.75	<b>54.77</b>	54.76	<b>54.77</b>	54.75	<b>54.77</b>	54.74

Band / BW	Ant	QPSK	16QAM	64QAM	256QAM
		Mid CH	Mid CH	Mid CH	Mid CH
		2525	2525	2525	2525
		881.5 MHz	881.5 MHz	881.5 MHz	881.5 MHz
Multi-carrier / 10M+10M+5M	Total Power	42.95	42.94	42.94	42.91
	Directional Gain	14.02	14.02	14.02	14.02
	ERP	<b>54.82</b>	54.81	54.81	54.78

Note: ERP (dBm) = Conducted Output Power (dBm) + antenna gain (dBi) – 2.15.



## 4.2 Modulation Characteristics Measurement

### 4.2.1 Limits of Modulation Characteristics

N/A

### 4.2.2 Test Procedure

Connect the EUT to Communication Simulator via the antenna connector, The frequency band is set as EUT supported Modulation and Channels, the EUT output is matched with 50 ohm load, the waveform quality and constellation of the EUT was tested.

### 4.2.3 Test Setup



### 4.2.4 Test Results

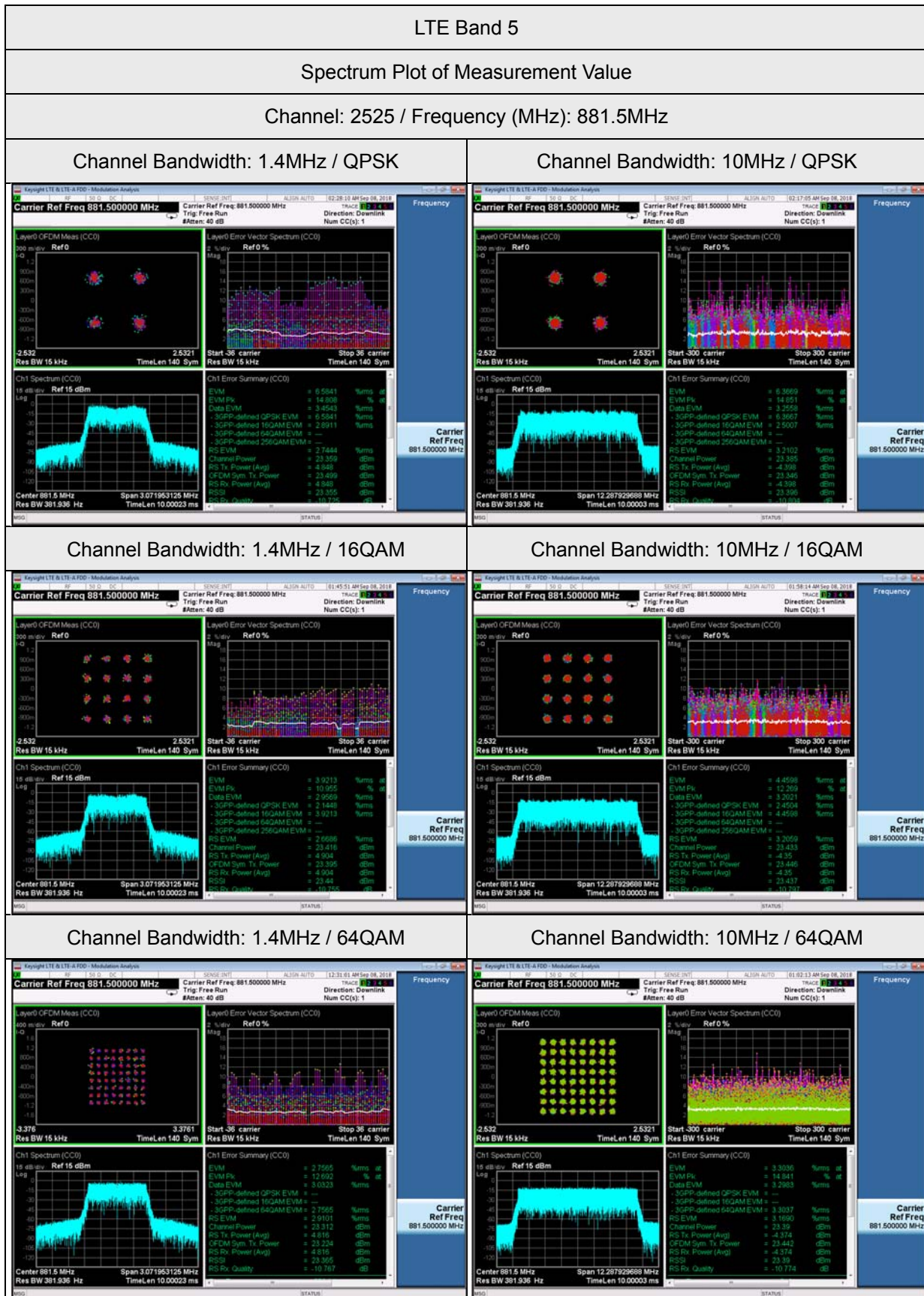

### Channel Bandwidth: 1.4MHz /256QAM

### Channel Bandwidth: 10MHz / 256QAM

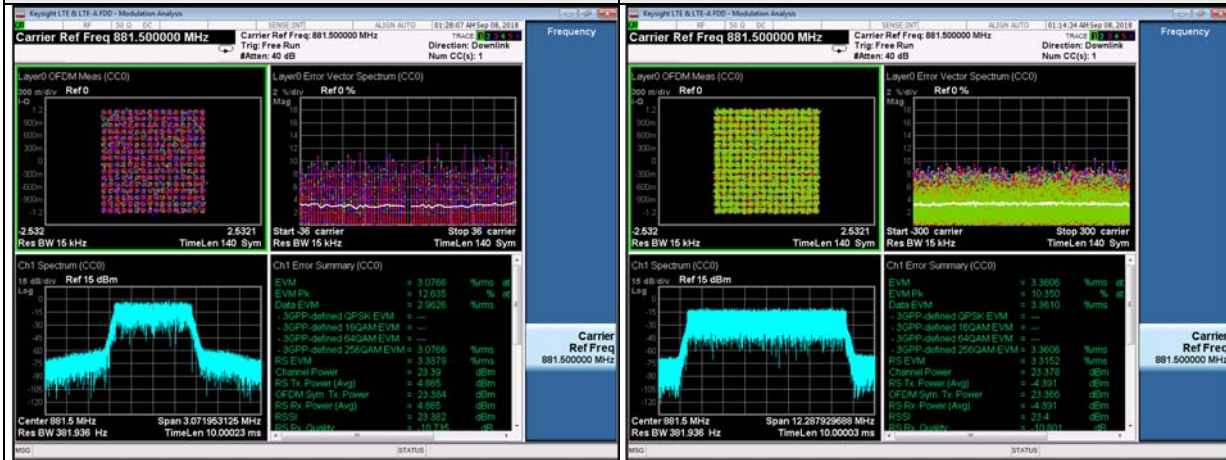

### 4.3 Frequency Stability Measurement

#### 4.3.1 Limits of Frequency Stability Measurement

1.5 ppm is for base and fixed station.

#### 4.3.2 Test Procedure

- Device is placed at the oven room. The oven room could control the temperatures and humidity. Power warm up is at least 15 min and power applied should perform before recording frequency error.
- EUT is connected the external power supply to control the DC input power. The test voltage range is from minimum to maximum working voltage. Each step shall be record the frequency error rate.
- The temperature range step is 10 degrees in this test items. All temperature levels shall be hold the  $\pm 0.5$  °C during the measurement testing. The each temperature step shall be at least 0.5 hours, consider the EUT could be test under the stability condition.

NOTE: The frequency error was recorded frequency error from the communication simulator.

#### 4.3.3 Test Setup

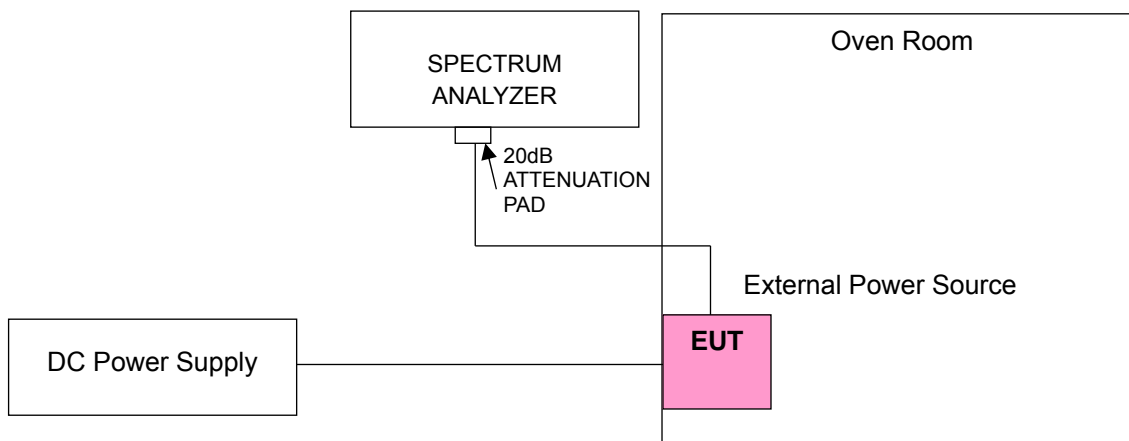

#### 4.3.4 Test Results

##### Frequency Error vs. Voltage

Voltage (Volts)	Frequency Error (ppm)				Limit (ppm)
	1.4MHz	3MHz	5MHz	10MHz	
45.9	0.03308	0.01584	0.05842	0.08742	1.5
54.0	0.05072	0.01582	0.05817	0.01116	1.5
62.1	0.01558	0.05817	0.02613	0.05813	1.5

Note: The applicant defined the normal working voltage is from 45.9Vdc to 62.1Vdc.

##### Frequency Error vs. Temperature

Voltage (Volts)	Frequency Error (ppm)				Limit (ppm)
	1.4MHz	3MHz	5MHz	10MHz	
50	0.07530	0.06469	0.01894	0.05158	1.5
40	0.05314	0.05165	0.05847	0.05154	1.5
30	0.00140	0.03164	0.02155	0.01586	1.5
20	0.00228	0.03189	0.01515	0.01515	1.5
10	0.07427	0.06315	0.01212	0.05158	1.5
0	0.06343	0.01582	0.00517	0.05199	1.5
-10	0.07250	0.06165	0.05168	0.05820	1.5
-20	0.05298	0.04165	0.01521	0.08193	1.5
-30	0.02146	0.01892	0.05296	0.05296	1.5

## 4.4 Occupied Bandwidth Measurement

### 4.4.1 Test Procedure

The EUT makes a call to the communication simulator. All measurements were done at low, middle and high operational frequency range. The communication simulator station system controlled a EUT to export maximum output power under transmission mode and specific channel frequency. Use OBW measurement function of Spectrum analyzer to measure 99 % occupied bandwidth.

### 4.4.2 Test Setup

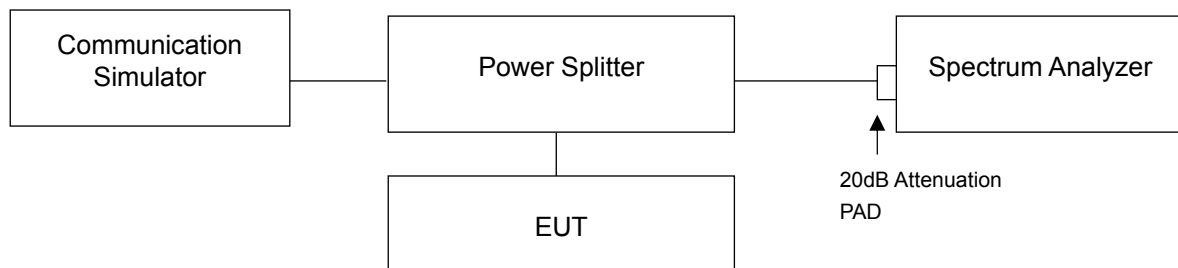

### 4.4.3 Test Result

#### Single Mode

Channel Bandwidth: 1.4MHz									
26dBc Bandwidth (MHz)									
Channel	Frequency (MHz)	QPSK				16QAM			
		Chain 0	Chain 1	Chain 2	Chain 3	Chain 0	Chain 1	Chain 2	Chain 3
2407	869.7	1.24	1.24	1.24	1.25	1.25	1.24	1.25	1.24
2525	881.5	1.24	1.24	1.25	1.25	1.24	1.24	1.25	1.25
2643	893.3	1.24	1.24	1.25	1.24	1.24	1.24	1.24	1.25
Channel	Frequency (MHz)	64QAM				256QAM			
		Chain 0	Chain 1	Chain 2	Chain 3	Chain 0	Chain 1	Chain 2	Chain 3
2407	869.7	1.24	1.24	1.25	1.24	1.25	1.24	1.25	1.25
2525	881.5	1.24	1.24	1.25	1.24	1.24	1.24	1.25	1.24
2643	893.3	1.23	1.24	1.23	1.25	1.24	1.24	1.25	1.24

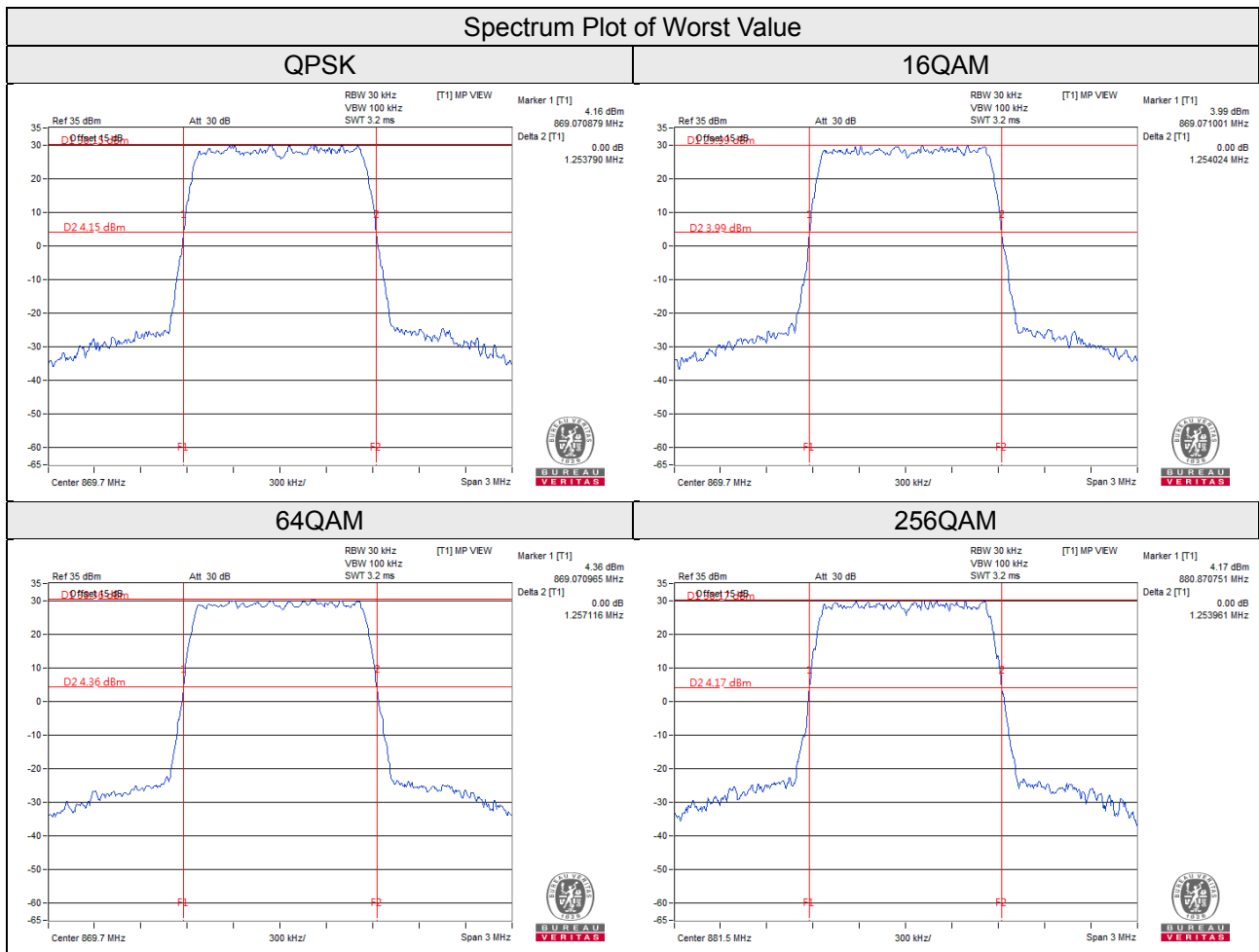

Channel Bandwidth: 1.4MHz									
Occupied Bandwidth (MHz)									
Channel	Frequency (MHz)	QPSK				16QAM			
		Chain 0	Chain 1	Chain 2	Chain 3	Chain 0	Chain 1	Chain 2	Chain 3
2407	869.7	1.11	1.11	1.11	1.11	1.11	1.11	1.11	1.11
2525	881.5	1.11	1.11	1.11	1.11	1.11	1.11	1.11	1.11
2643	893.3	1.11	1.11	1.10	1.11	1.11	1.11	1.11	1.10
Channel	Frequency (MHz)	64QAM				256QAM			
		Chain 0	Chain 1	Chain 2	Chain 3	Chain 0	Chain 1	Chain 2	Chain 3
2407	869.7	1.11	1.11	1.11	1.11	1.11	1.11	1.11	1.11
2525	881.5	1.10	1.10	1.10	1.11	1.11	1.11	1.11	1.10
2643	893.3	1.10	1.11	1.10	1.10	1.11	1.10	1.10	1.11

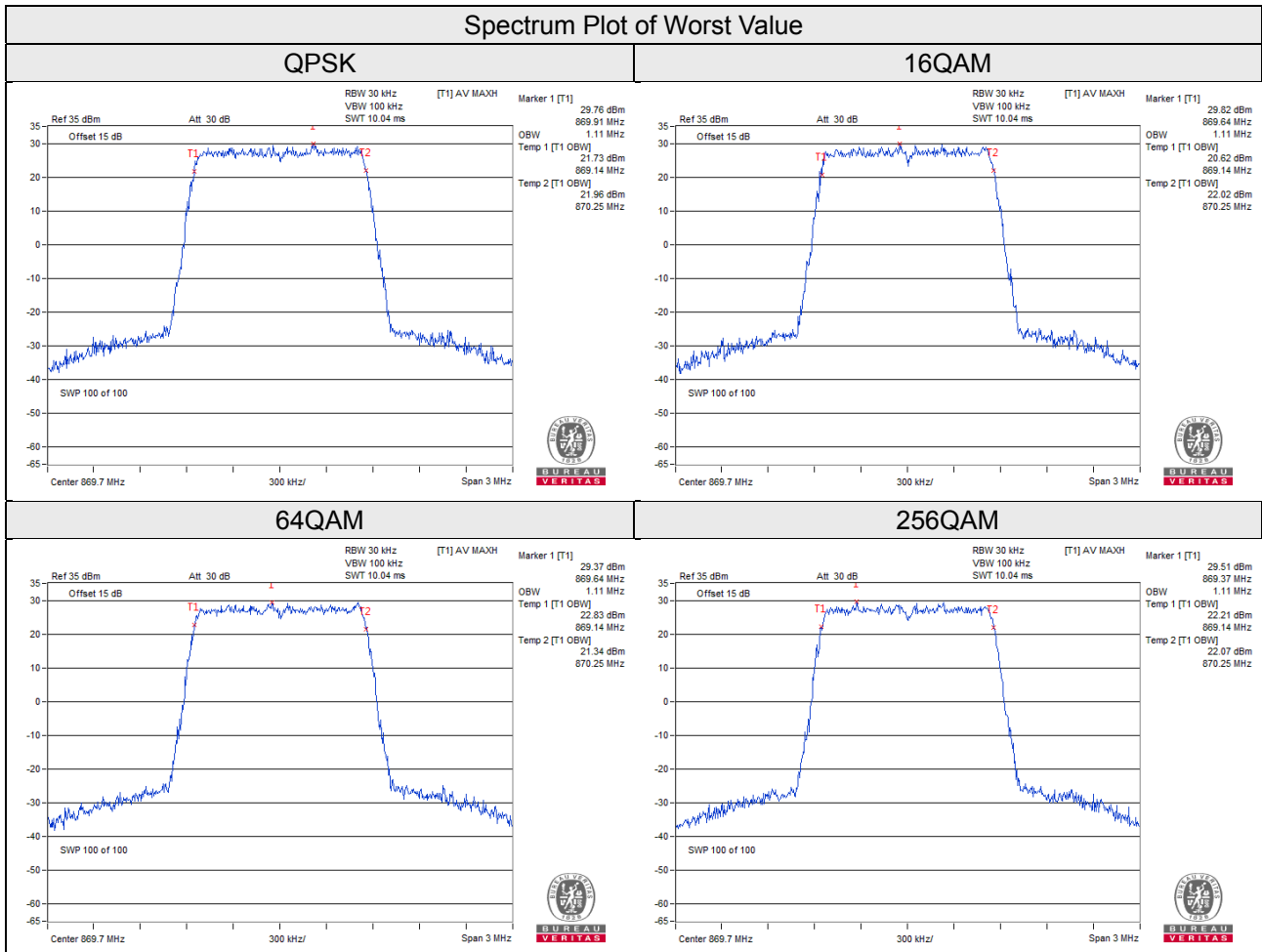



Channel Bandwidth: 3MHz									
26dBc Bandwidth (MHz)									
Channel	Frequency (MHz)	QPSK				16QAM			
		Chain 0	Chain 1	Chain 2	Chain 3	Chain 0	Chain 1	Chain 2	Chain 3
2415	870.5	2.93	2.92	2.92	2.92	2.91	2.91	2.92	2.92
2525	881.5	2.91	2.90	2.92	2.92	2.92	2.90	2.92	2.91
2635	892.5	2.91	2.91	2.90	2.90	2.92	2.90	2.91	2.92
Channel	Frequency (MHz)	64QAM				256QAM			
		Chain 0	Chain 1	Chain 2	Chain 3	Chain 0	Chain 1	Chain 2	Chain 3
2415	870.5	2.91	2.91	2.92	2.92	2.91	2.91	2.92	2.92
2525	881.5	2.93	2.91	2.92	2.92	2.92	2.91	2.92	2.91
2635	892.5	2.92	2.90	2.91	2.91	2.92	2.90	2.92	2.92

**Spectrum Plot of Worst Value**

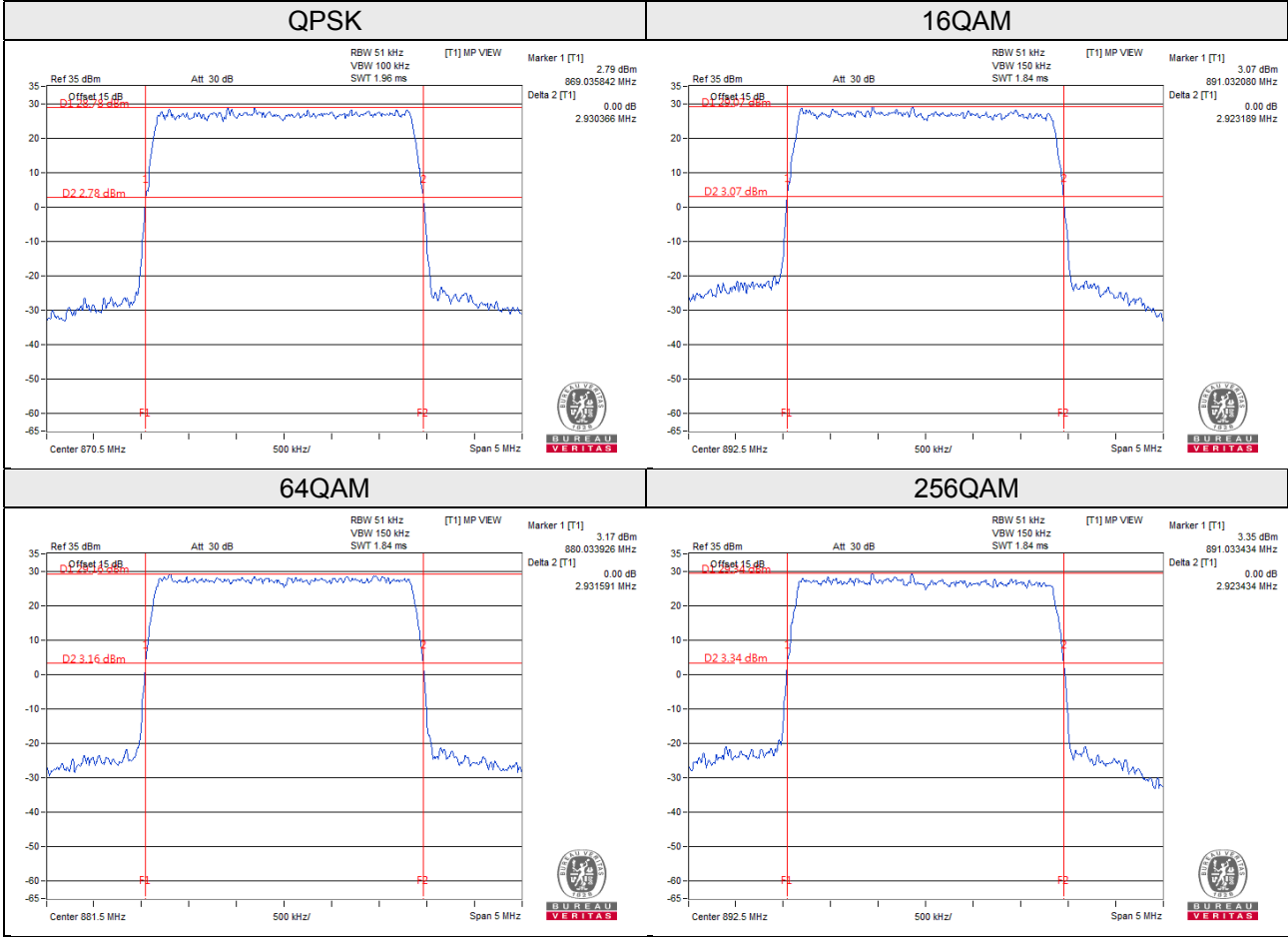

Channel Bandwidth: 3MHz									
Occupied Bandwidth (MHz)									
Channel	Frequency (MHz)	QPSK				16QAM			
		Chain 0	Chain 1	Chain 2	Chain 3	Chain 0	Chain 1	Chain 2	Chain 3
2415	870.5	2.70	2.70	2.70	2.70	2.70	2.70	2.70	2.70
2525	881.5	2.70	2.70	2.70	2.70	2.70	2.70	2.70	2.70
2635	892.5	2.70	2.69	2.69	2.70	2.69	2.70	2.70	2.70
Channel	Frequency (MHz)	64QAM				256QAM			
		Chain 0	Chain 1	Chain 2	Chain 3	Chain 0	Chain 1	Chain 2	Chain 3
2415	870.5	2.70	2.70	2.70	2.70	2.70	2.69	2.70	2.70
2525	881.5	2.70	2.70	2.70	2.70	2.70	2.70	2.70	2.70
2635	892.5	2.70	2.70	2.69	2.69	2.69	2.70	2.70	2.69

**Spectrum Plot of Worst Value**

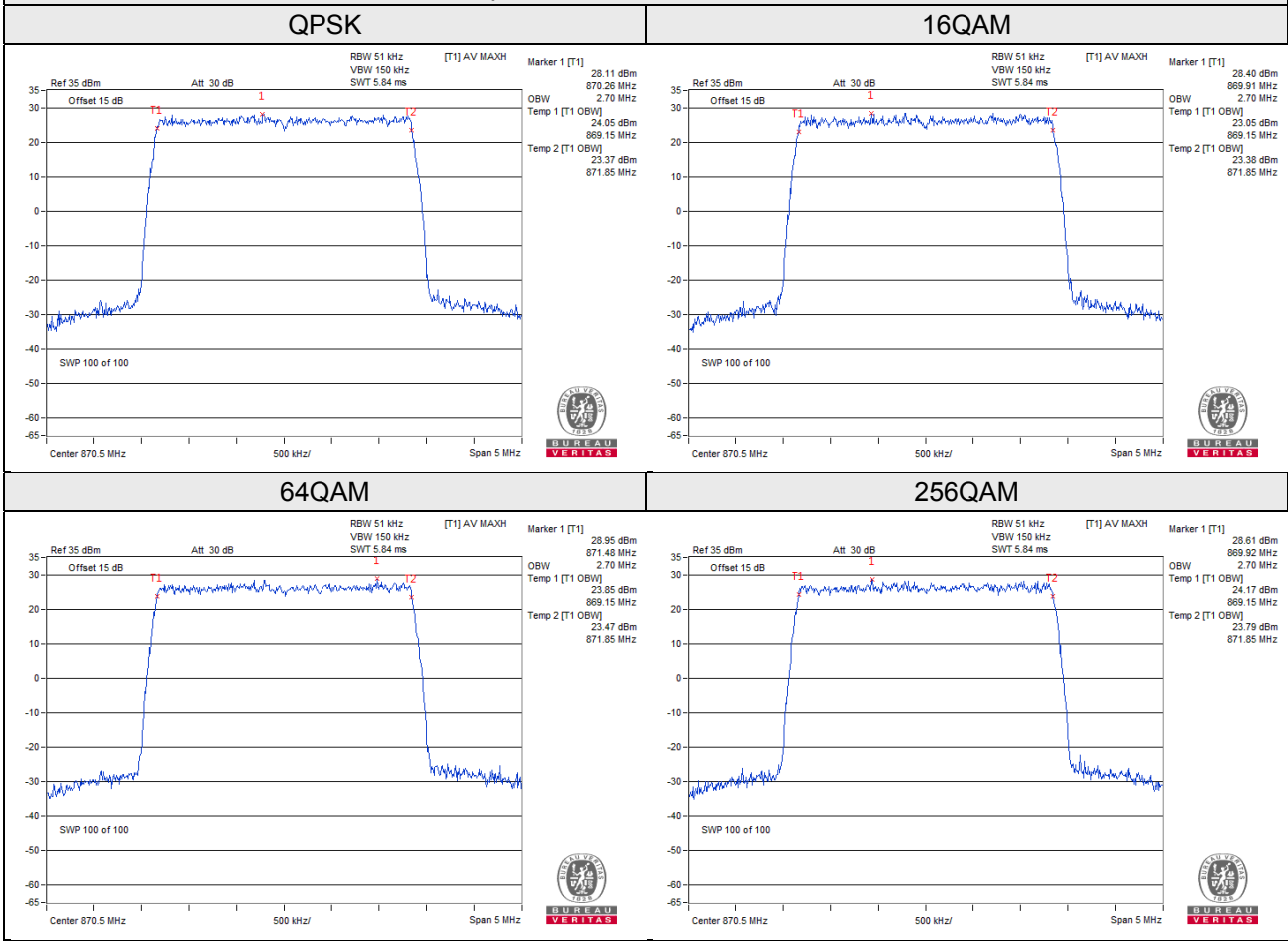

Channel Bandwidth: 5MHz									
26dBc Bandwidth (MHz)									
Channel	Frequency (MHz)	QPSK				16QAM			
		Chain 0	Chain 1	Chain 2	Chain 3	Chain 0	Chain 1	Chain 2	Chain 3
2425	871.5	4.77	4.77	4.76	4.75	4.78	4.74	4.76	4.76
2525	881.5	4.78	4.77	4.78	4.78	4.78	4.78	4.76	4.77
2625	891.5	4.77	4.77	4.77	4.76	4.78	4.77	4.77	4.75
Channel	Frequency (MHz)	64QAM				256QAM			
		Chain 0	Chain 1	Chain 2	Chain 3	Chain 0	Chain 1	Chain 2	Chain 3
2425	871.5	4.76	4.76	4.76	4.77	4.77	4.76	4.77	4.76
2525	881.5	4.78	4.77	4.79	4.77	4.78	4.77	4.77	4.77
2625	891.5	4.77	4.77	4.77	4.76	4.77	4.78	4.78	4.78

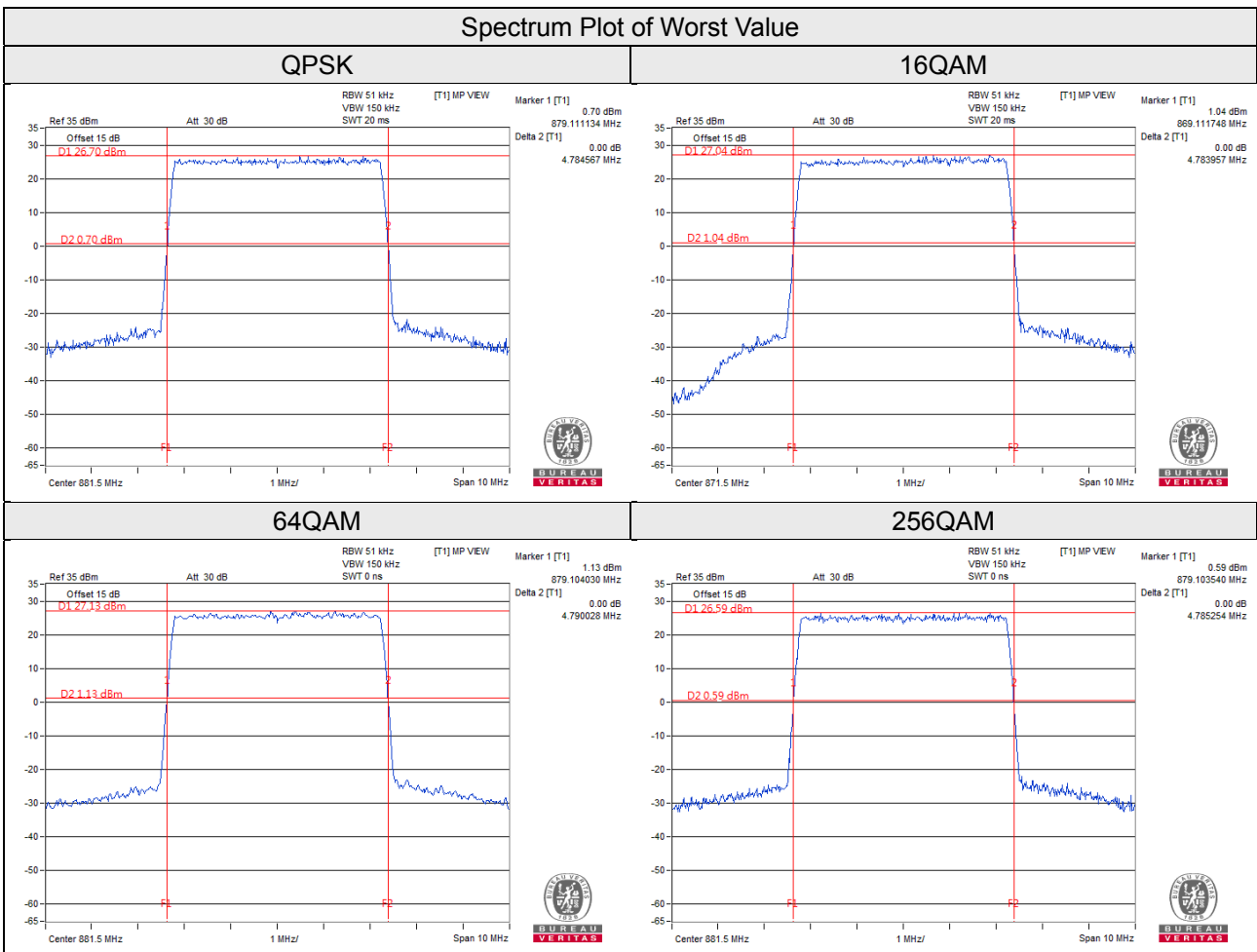

Channel Bandwidth: 5MHz									
Occupied Bandwidth (MHz)									
Channel	Frequency (MHz)	QPSK				16QAM			
		Chain 0	Chain 1	Chain 2	Chain 3	Chain 0	Chain 1	Chain 2	Chain 3
2425	871.5	4.48	4.48	4.48	4.48	4.48	4.46	4.48	4.48
2525	881.5	4.48	4.48	4.48	4.48	4.48	4.48	4.48	4.48
2625	891.5	4.48	4.46	4.48	4.48	4.46	4.46	4.48	4.48
Channel	Frequency (MHz)	64QAM				256QAM			
		Chain 0	Chain 1	Chain 2	Chain 3	Chain 0	Chain 1	Chain 2	Chain 3
2425	871.5	4.48	4.48	4.48	4.48	4.48	4.46	4.48	4.48
2525	881.5	4.48	4.48	4.48	4.48	4.48	4.48	4.48	4.48
2625	891.5	4.46	4.46	4.48	4.48	4.46	4.46	4.48	4.48

**Spectrum Plot of Worst Value**

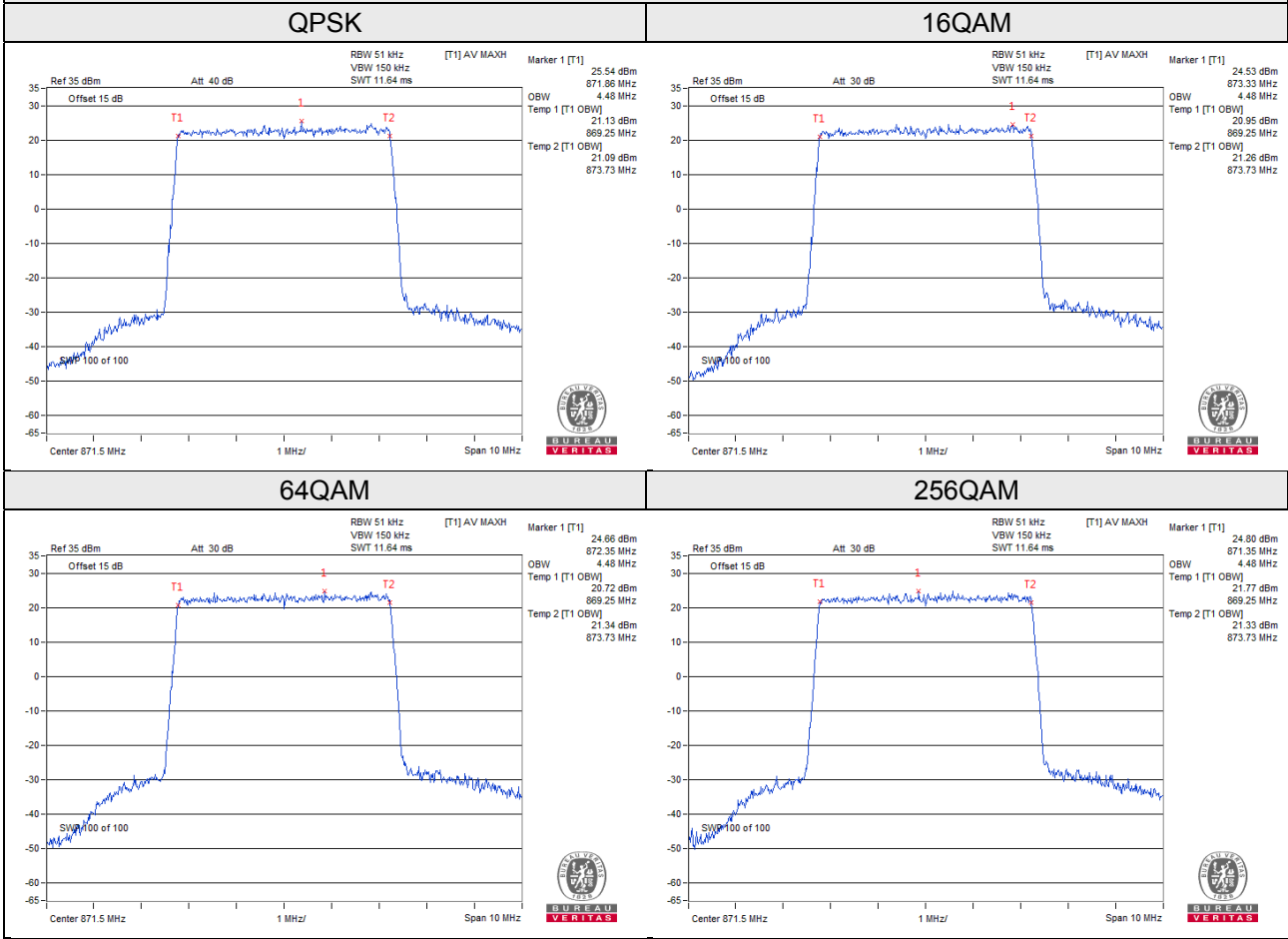

Channel Bandwidth: 10MHz									
26dBc Bandwidth (MHz)									
Channel	Frequency (MHz)	QPSK				16QAM			
		Chain 0	Chain 1	Chain 2	Chain 3	Chain 0	Chain 1	Chain 2	Chain 3
2450	874.0	9.52	9.54	9.52	9.49	9.53	9.54	9.54	9.53
2525	881.5	9.50	9.54	9.53	9.51	9.52	9.54	9.53	9.53
2600	889.0	9.52	9.47	9.50	9.54	9.50	9.51	9.50	9.50
Channel	Frequency (MHz)	64QAM				256QAM			
		Chain 0	Chain 1	Chain 2	Chain 3	Chain 0	Chain 1	Chain 2	Chain 3
2450	874.0	9.53	9.54	9.48	9.50	9.51	9.54	9.50	9.54
2525	881.5	9.53	9.53	9.54	9.54	9.49	9.54	9.52	9.53
2600	889.0	9.53	9.52	9.51	9.51	9.55	9.53	9.51	9.50

### Spectrum Plot of Worst Value

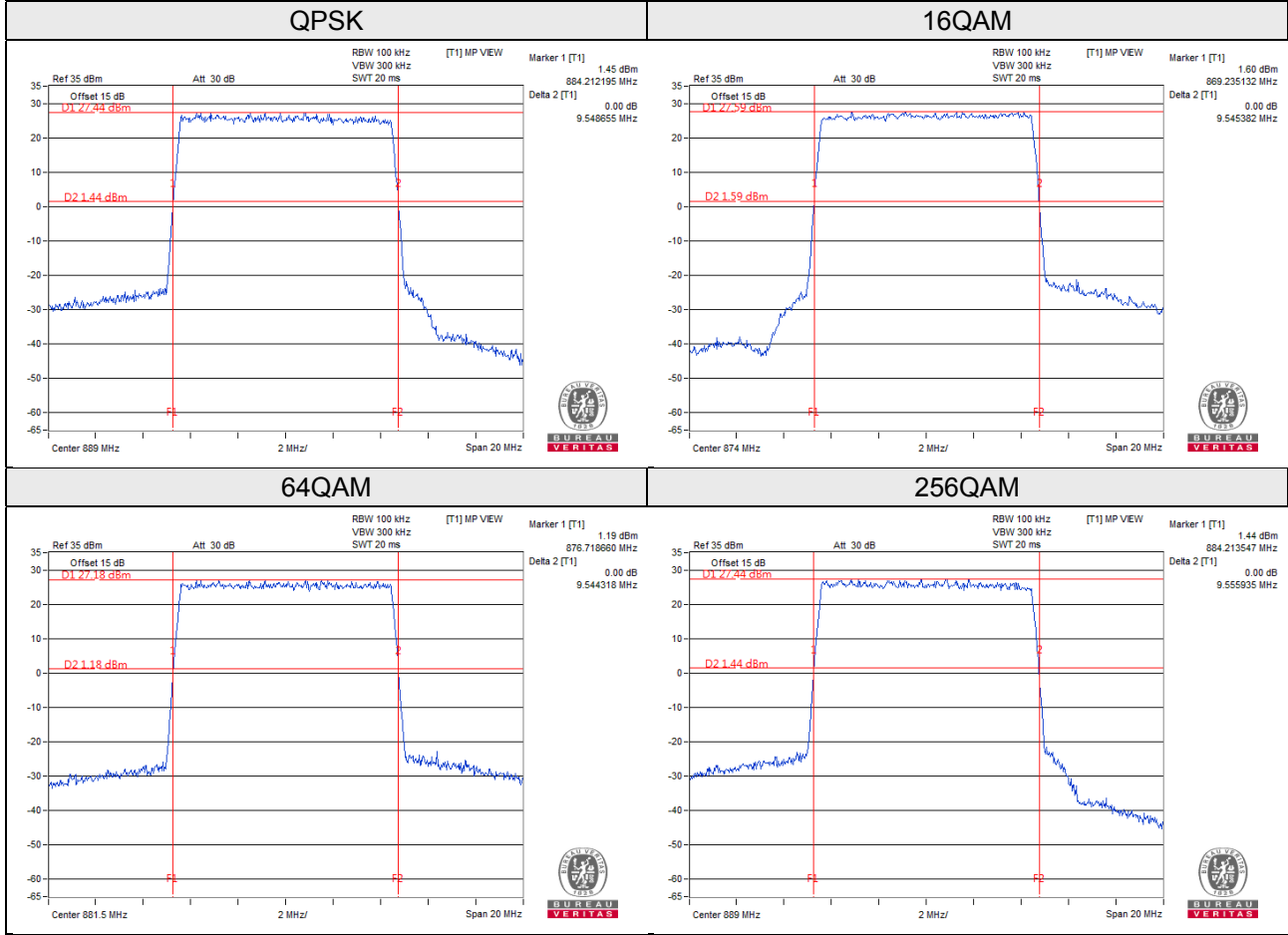

Channel Bandwidth: 10MHz									
Occupied Bandwidth (MHz)									
Channel	Frequency (MHz)	QPSK				16QAM			
		Chain 0	Chain 1	Chain 2	Chain 3	Chain 0	Chain 1	Chain 2	Chain 3
2450	874.0	8.96	8.93	8.96	8.93	8.96	8.93	8.93	8.93
2525	881.5	8.96	8.96	8.93	8.96	8.96	8.96	8.93	8.96
2600	889.0	8.93	8.93	8.96	8.93	8.96	8.93	8.96	8.93
Channel	Frequency (MHz)	64QAM				256QAM			
		Chain 0	Chain 1	Chain 2	Chain 3	Chain 0	Chain 1	Chain 2	Chain 3
2450	874.0	8.93	8.93	8.93	8.93	8.96	8.93	8.93	8.96
2525	881.5	8.96	8.96	8.96	8.96	8.96	8.96	8.96	8.96
2600	889.0	8.93	8.93	8.93	8.93	8.93	8.93	8.93	8.93

**Spectrum Plot of Worst Value**

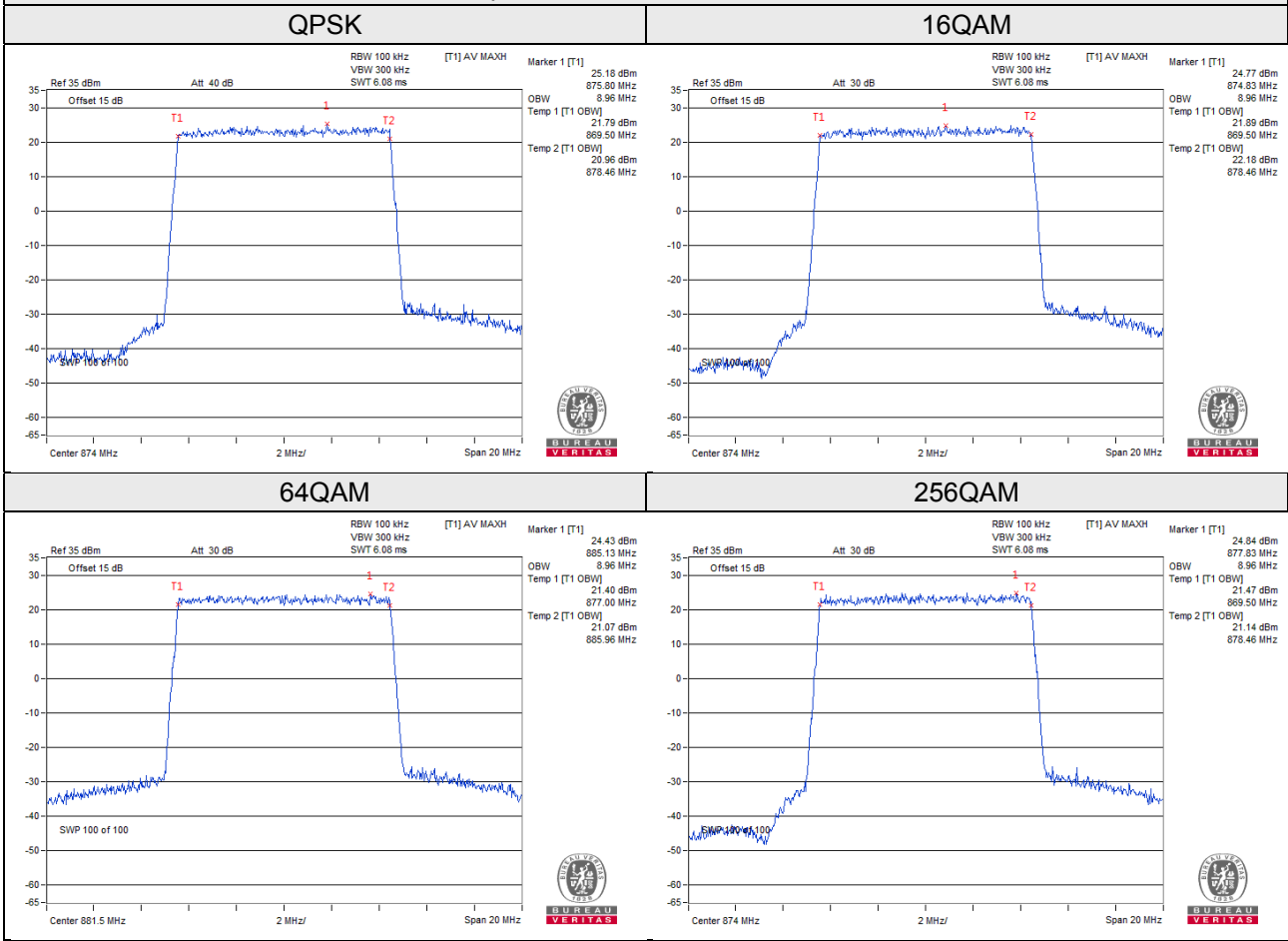

multi-carrier

Channel Bandwidth: 10MHz + 10MHz + 5MHz									
26dBc Bandwidth (MHz)									
Channel	Frequency (MHz)	QPSK				16QAM			
		Chain 0	Chain 1	Chain 2	Chain 3	Chain 0	Chain 1	Chain 2	Chain 3
2525	881.5	25.42	25.39	25.38	25.38	25.41	25.37	25.41	25.39
Channel	Frequency (MHz)	64QAM				256QAM			
		Chain 0	Chain 1	Chain 2	Chain 3	Chain 0	Chain 1	Chain 2	Chain 3
2525	881.5	25.38	25.36	25.39	25.39	25.40	25.38	25.41	25.37

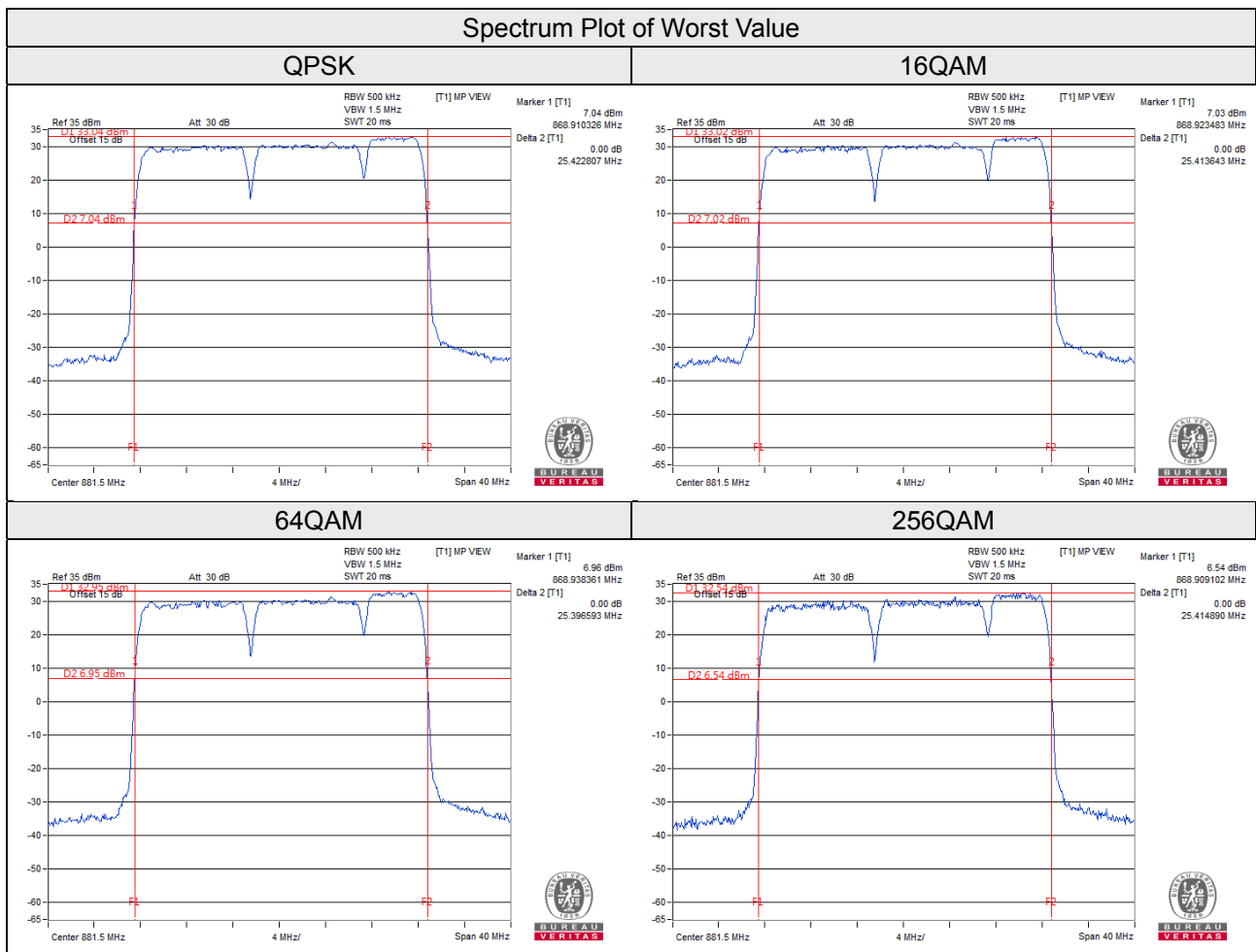

Channel Bandwidth: 10MHz + 10MHz + 5MHz

Occupied Bandwidth (MHz)

Channel	Frequency (MHz)	QPSK				16QAM			
		Chain 0	Chain 1	Chain 2	Chain 3	Chain 0	Chain 1	Chain 2	Chain 3
2525	881.5	24.13	24.13	24.13	24.13	24.26	24.20	24.13	24.13
Channel	Frequency (MHz)	64QAM				256QAM			
		Chain 0	Chain 1	Chain 2	Chain 3	Chain 0	Chain 1	Chain 2	Chain 3
2525	881.5	24.13	24.13	24.06	24.13	24.06	24.13	24.13	24.13

Spectrum Plot of Worst Value

QPSK

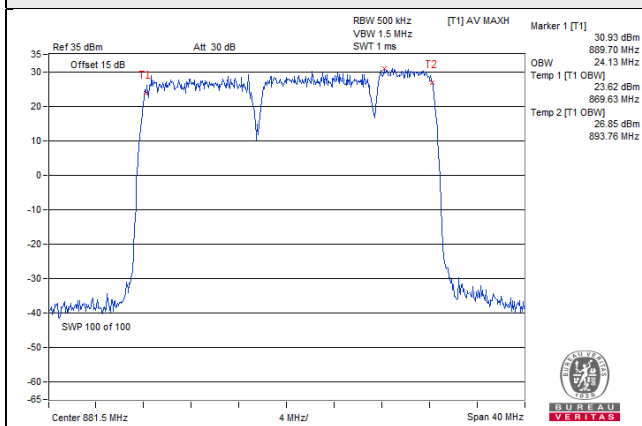

16QAM

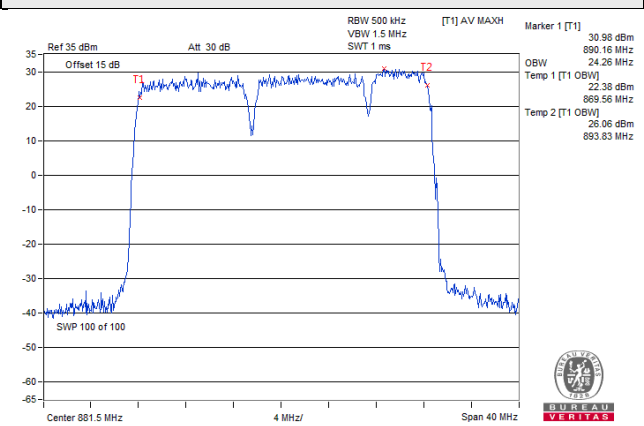

64QAM

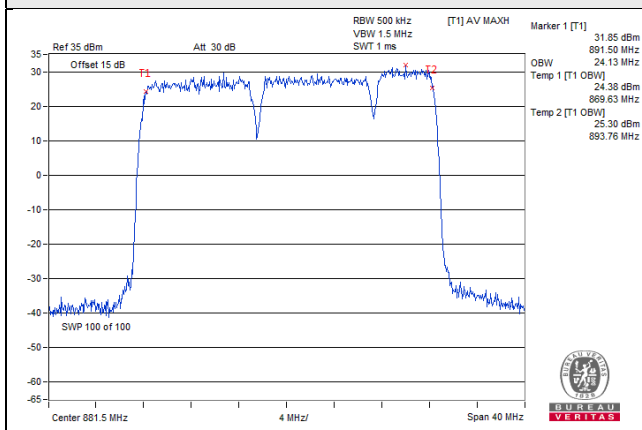

256QAM

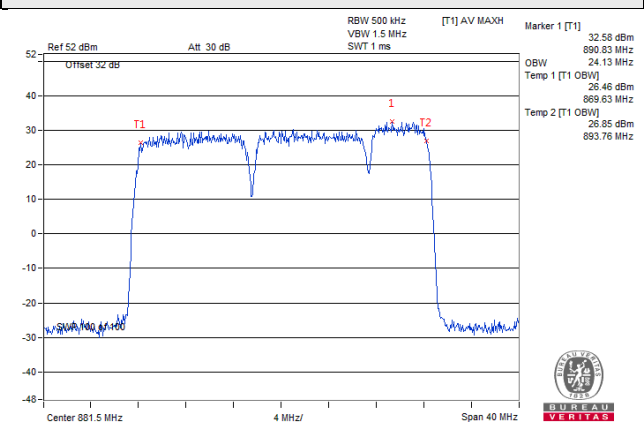



## 4.5 Band Edge Measurement

### 4.5.1 Limits of Band Edge Measurement

Power of any emission outside of the authorized operating frequency ranges must be attenuated below the transmitting power (P) by a factor of at least  $43 + 10 \log(P)$  dB. In the 1 MHz bands immediately outside and adjacent to the frequency block a resolution bandwidth of at least one percent of the emission bandwidth of the fundamental emission of the transmitter may be employed.

Note: The device has 4x4 MIMO function, so the limit of spurious emissions needs to be reduced by  $-13 - 10 \log(4) = -19.02$  dBm according to FCC KDB 66291 D01 guidance.

### 4.5.2 Test Setup

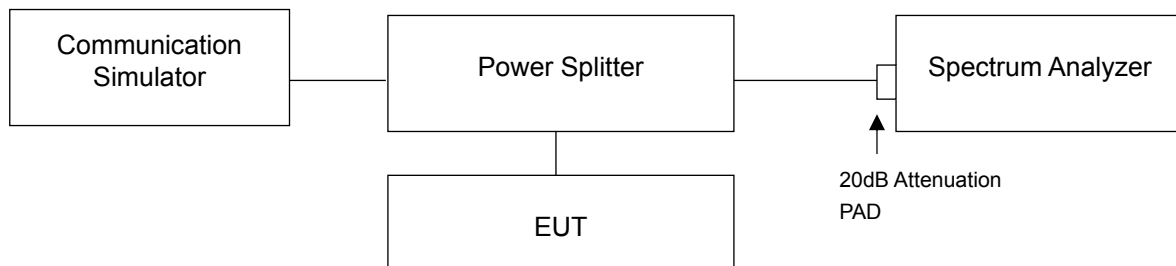

### 4.5.3 Test Procedures

- All measurements were done at low and high operational frequency range.
- The center frequency of spectrum is the band edge frequency and span is 1.5MHz. RB of the spectrum is 30kHz and VB of the spectrum is 100kHz (LTE Channel Bandwidth 1.4MHz).
- The center frequency of spectrum is the band edge frequency and span is 1.5MHz. RB of the spectrum is 51kHz and VB of the spectrum is 150kHz (LTE Channel Bandwidth 3MHz and 5MHz).
- The center frequency of spectrum is the band edge frequency and span is 1.5MHz. RB of the spectrum is 100kHz and VB of the spectrum is 300kHz (LTE Channel Bandwidth 10MHz).
- Record the max trace plot into the test report.

### 4.5.4 Test Results

#### Single Mode (Chain 0)

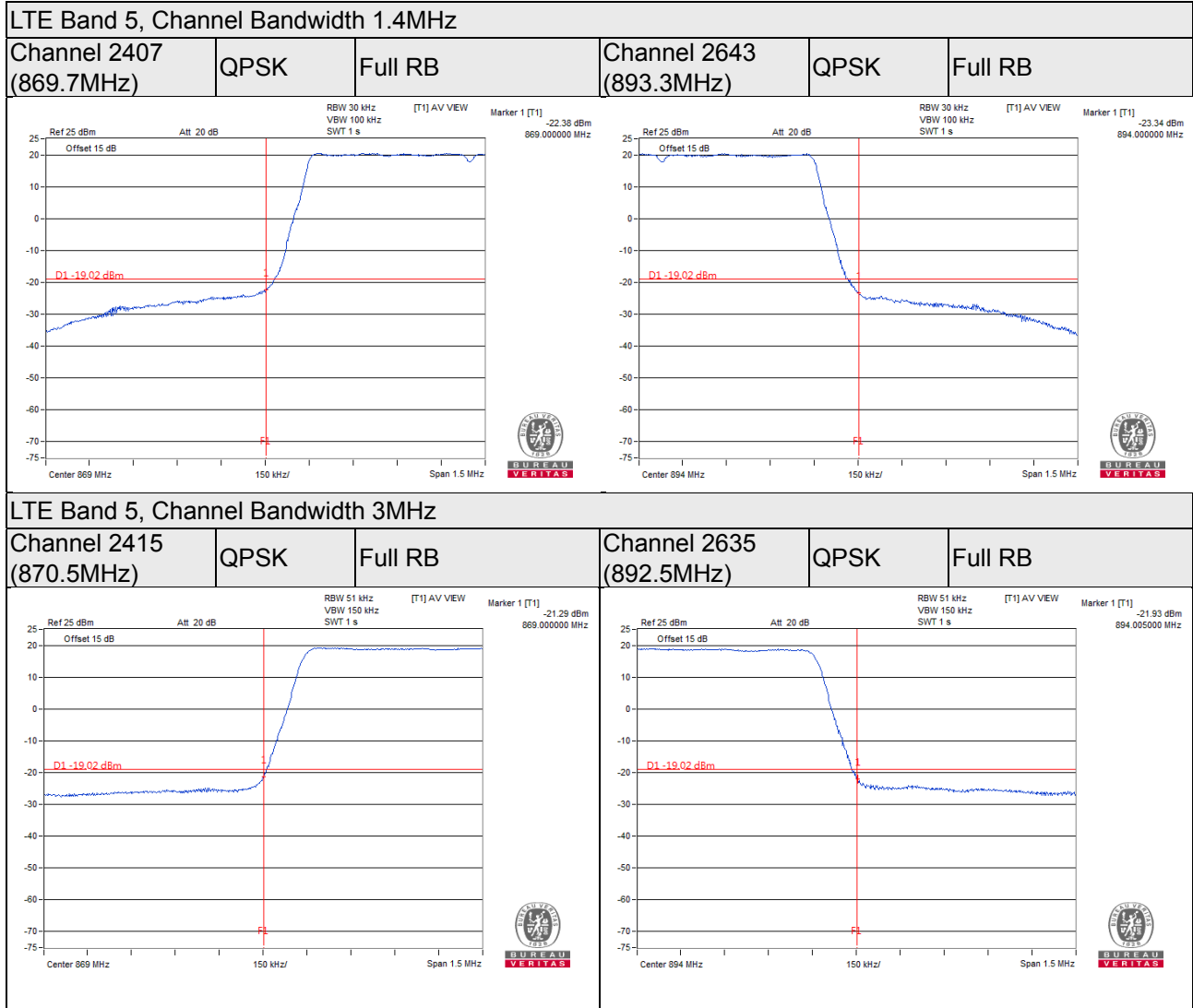

LTE Band 5, Channel Bandwidth 5MHz

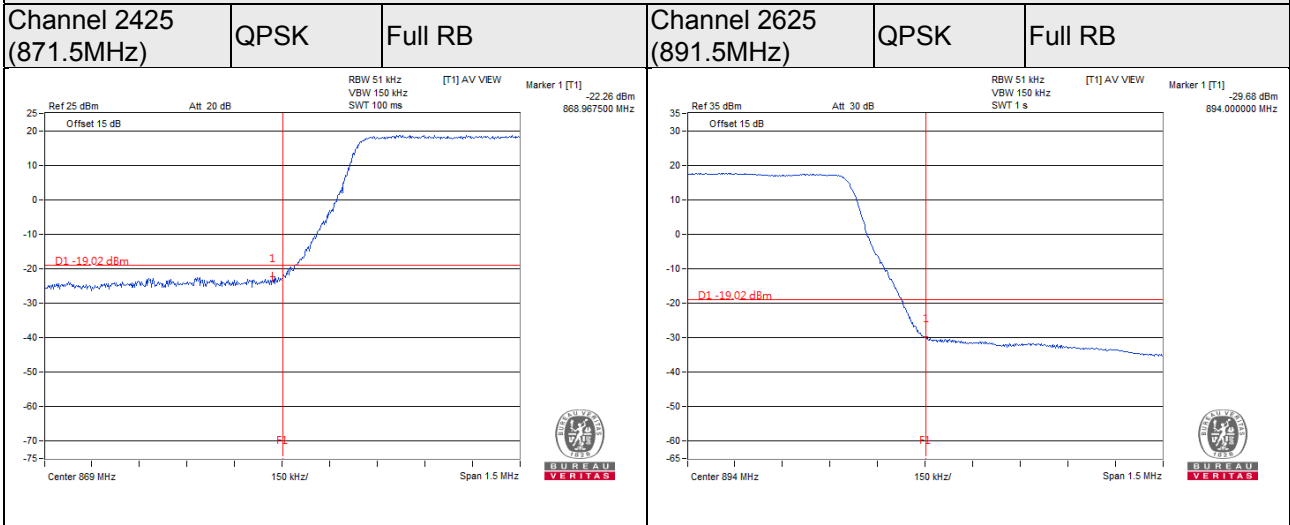

LTE Band 5, Channel Bandwidth 10MHz

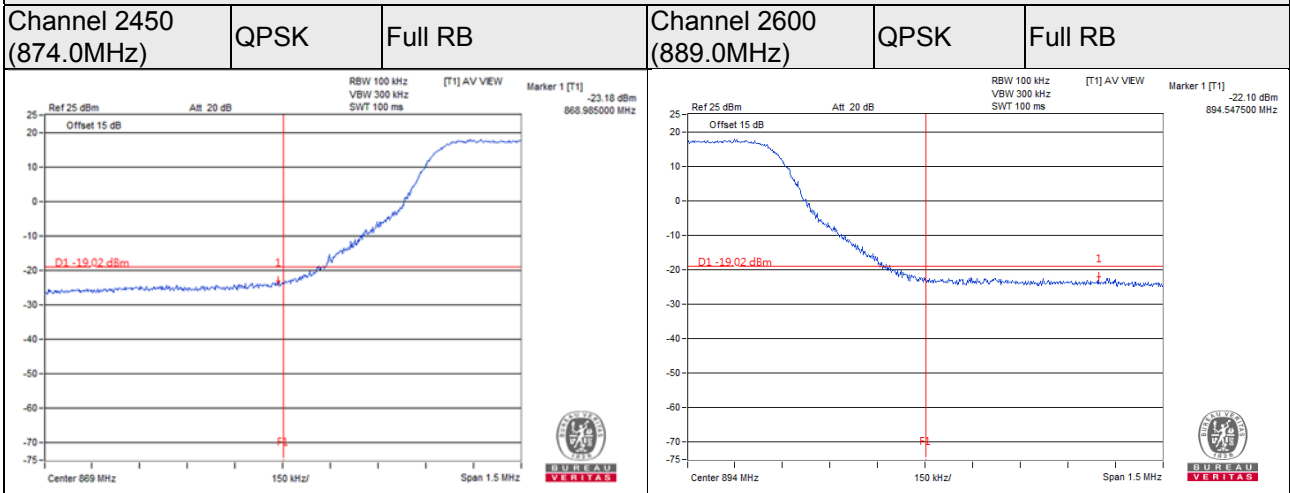

### Single Mode (Chain 1)

#### LTE Band 5, Channel Bandwidth 1.4MHz

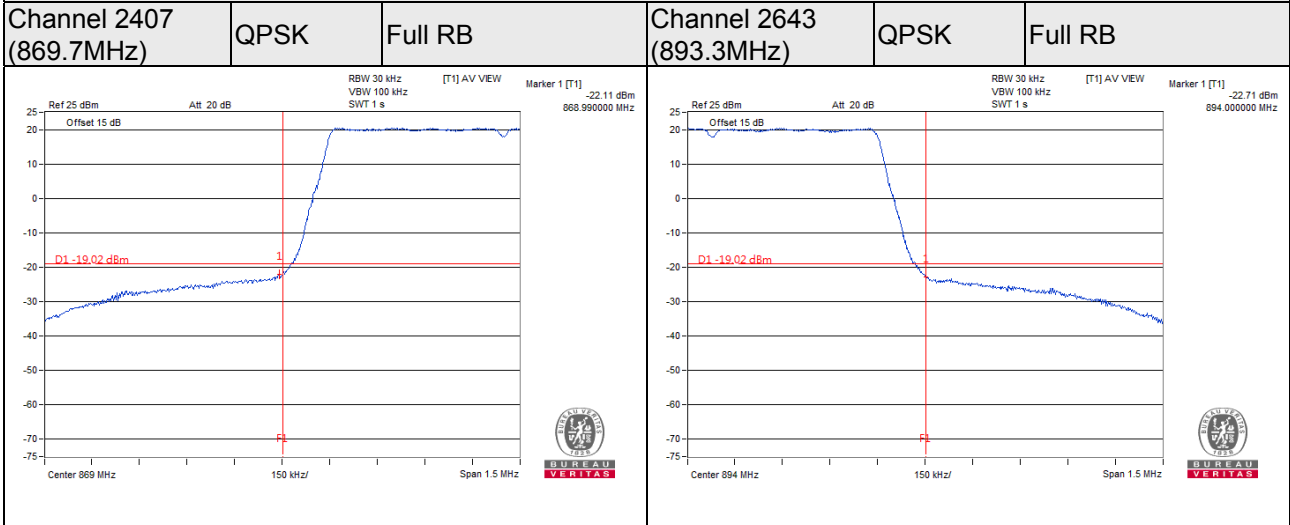

#### LTE Band 5, Channel Bandwidth 3MHz

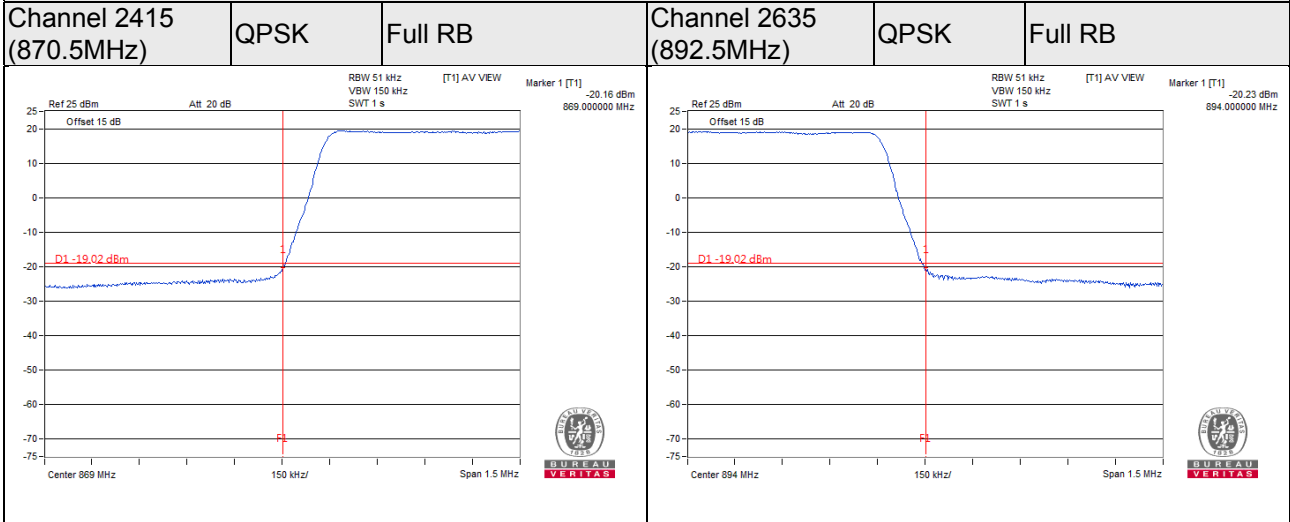

**LTE Band 5, Channel Bandwidth 5MHz**

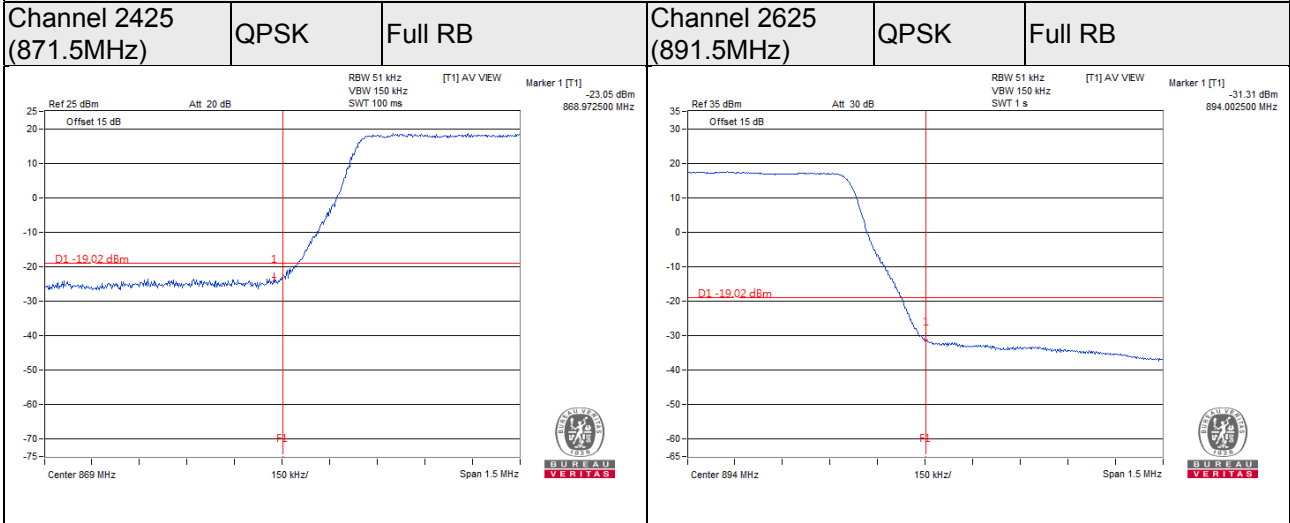

**LTE Band 5, Channel Bandwidth 10MHz**

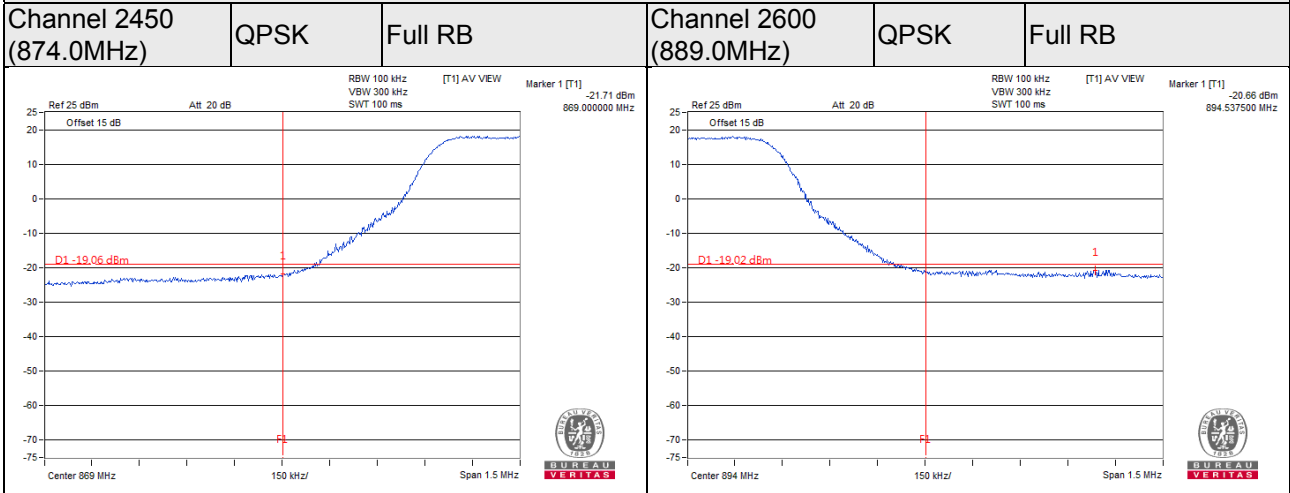

### Single Mode (Chain 2)

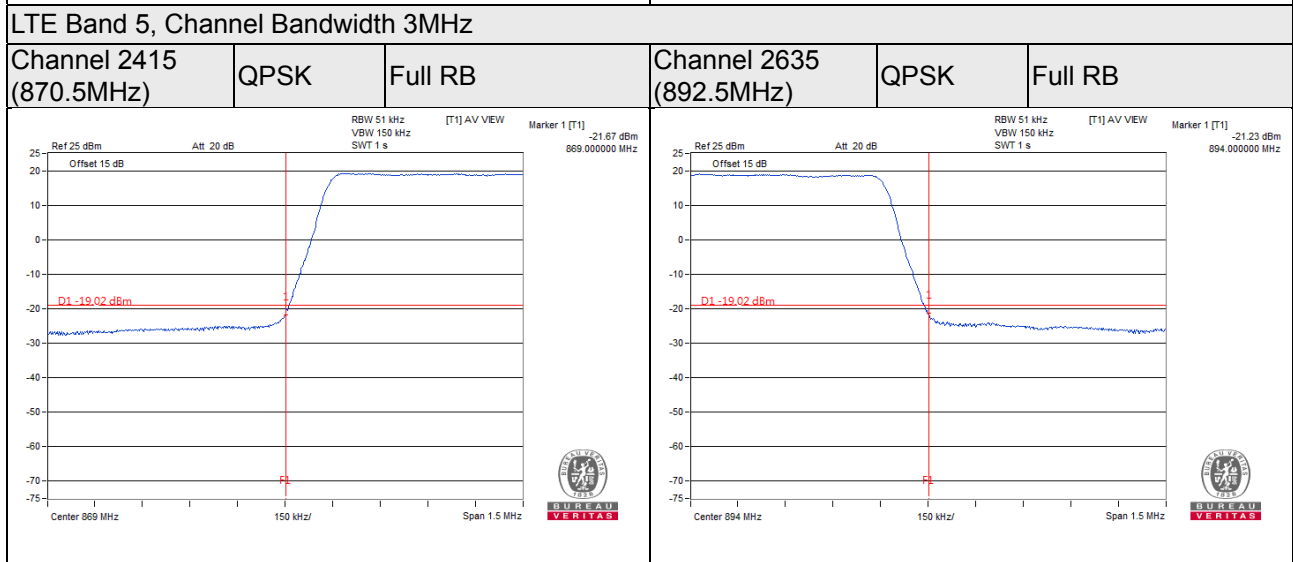
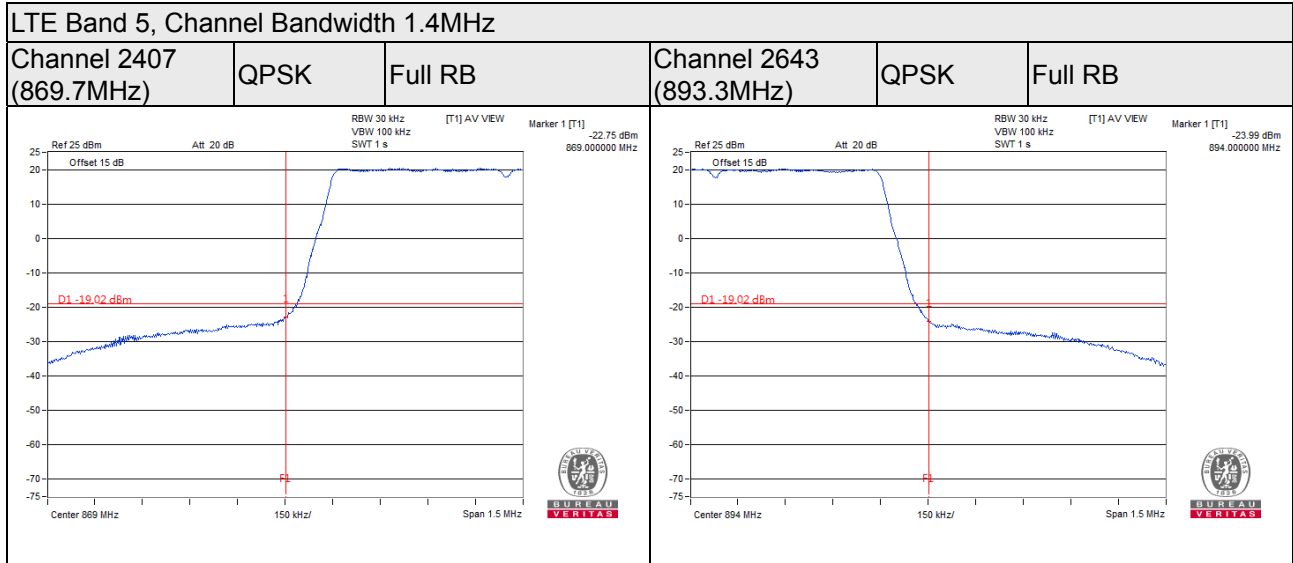

**LTE Band 5, Channel Bandwidth 5MHz**

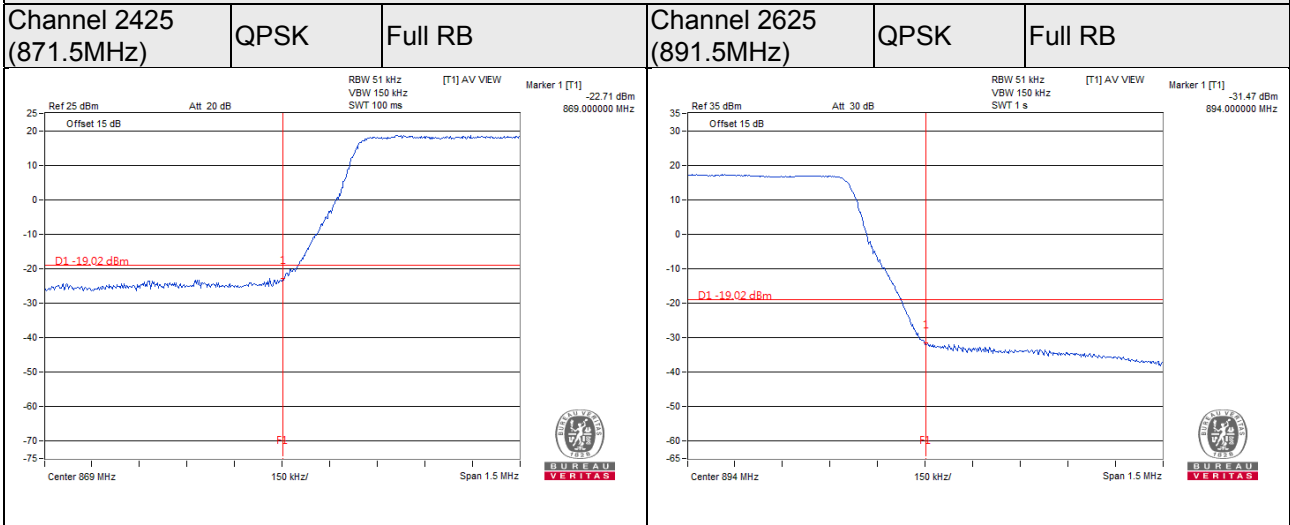

**LTE Band 5, Channel Bandwidth 10MHz**

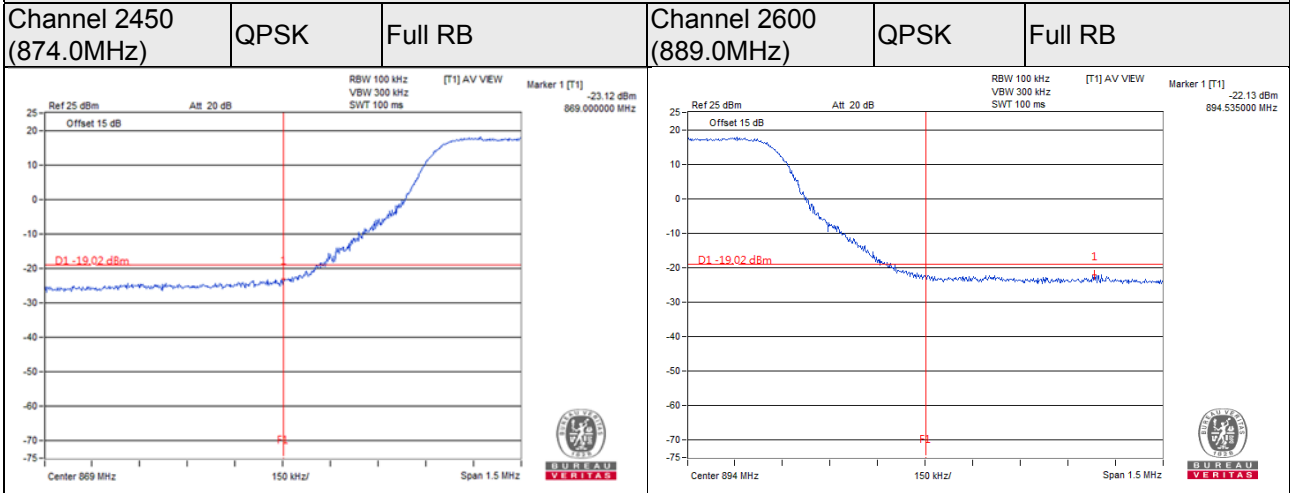

### Single Mode (Chain 3)

#### LTE Band 5, Channel Bandwidth 1.4MHz

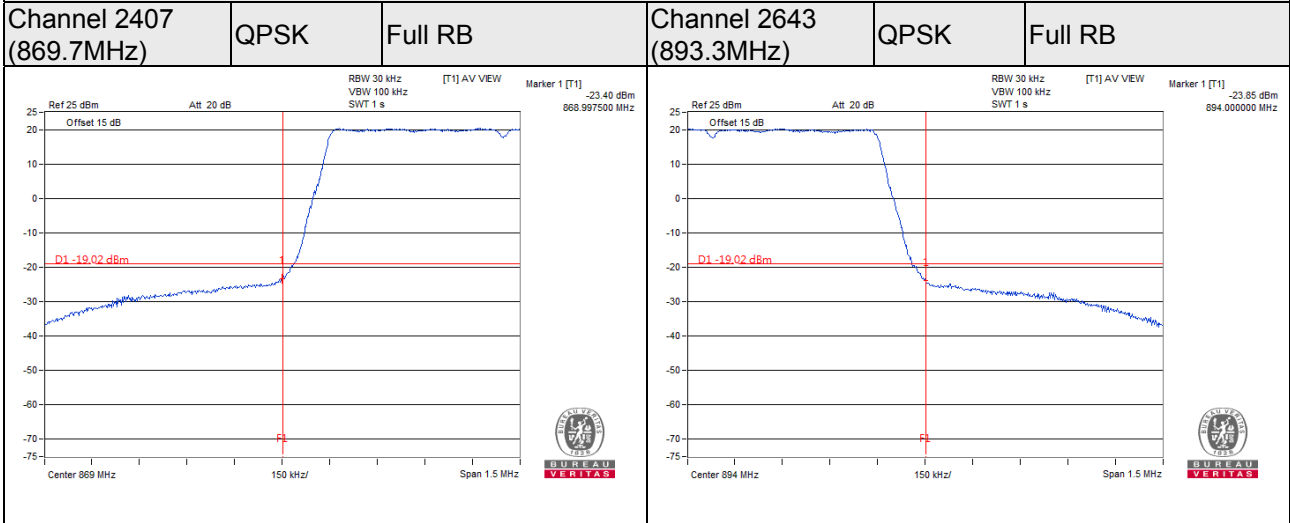

#### LTE Band 5, Channel Bandwidth 3MHz

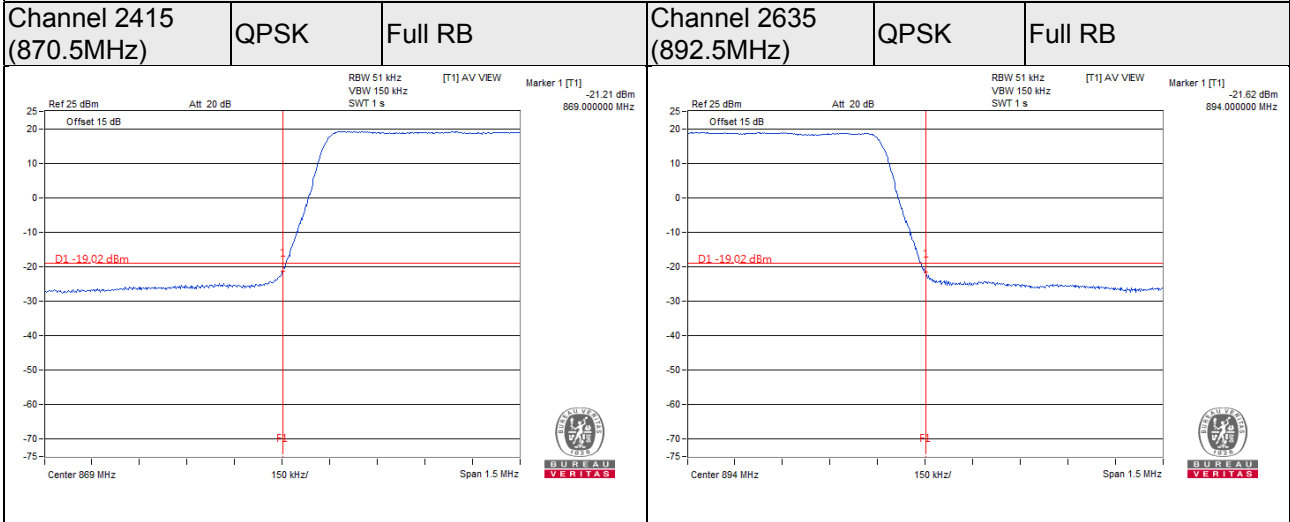



**LTE Band 5, Channel Bandwidth 5MHz**

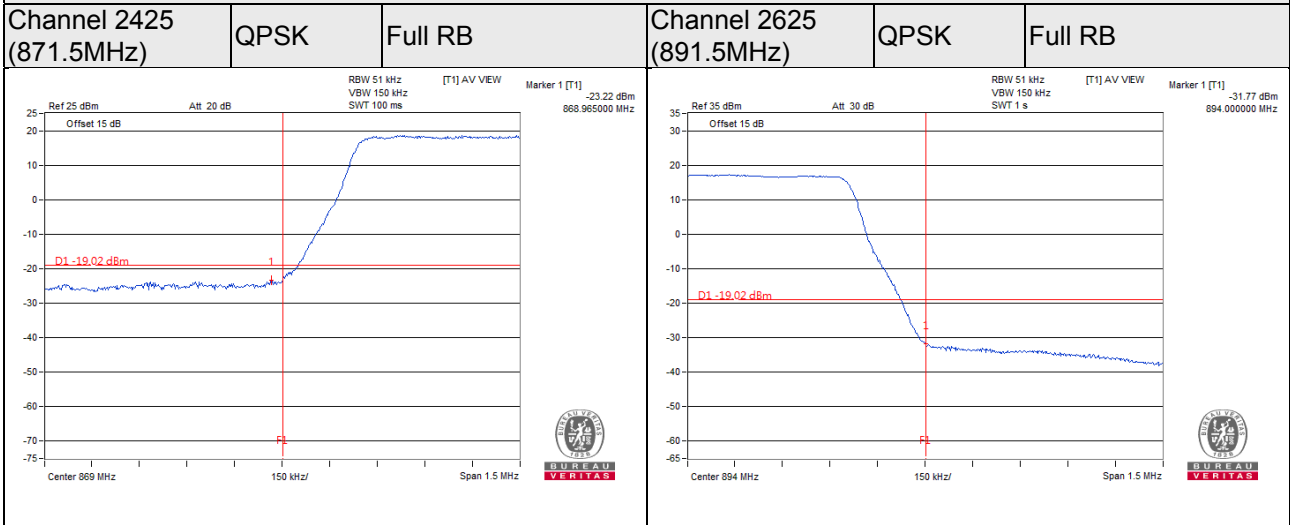

**LTE Band 5, Channel Bandwidth 10MHz**

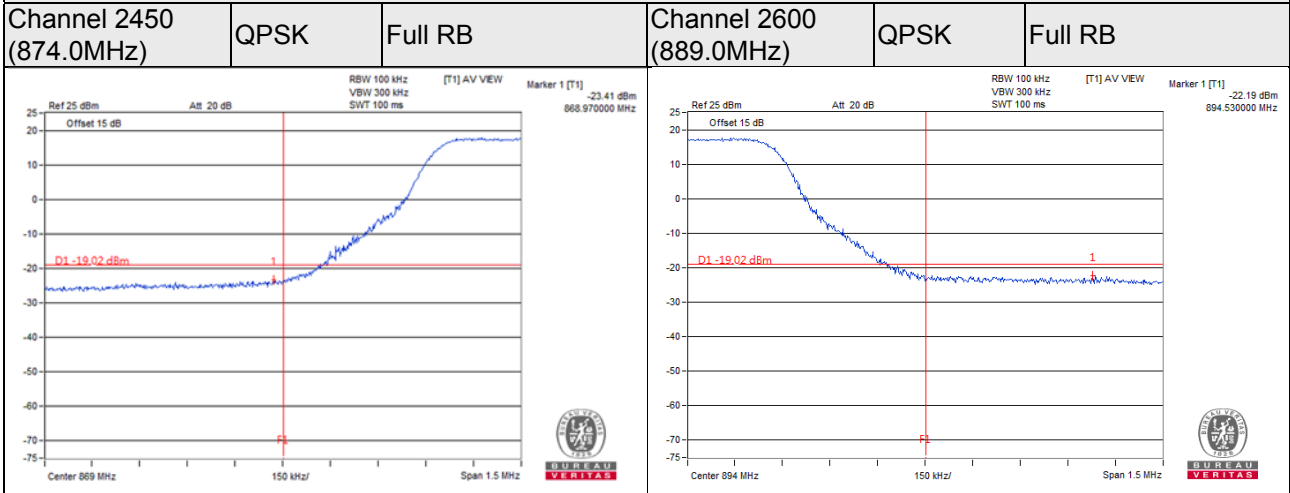

multi-carrier (Chain 0)

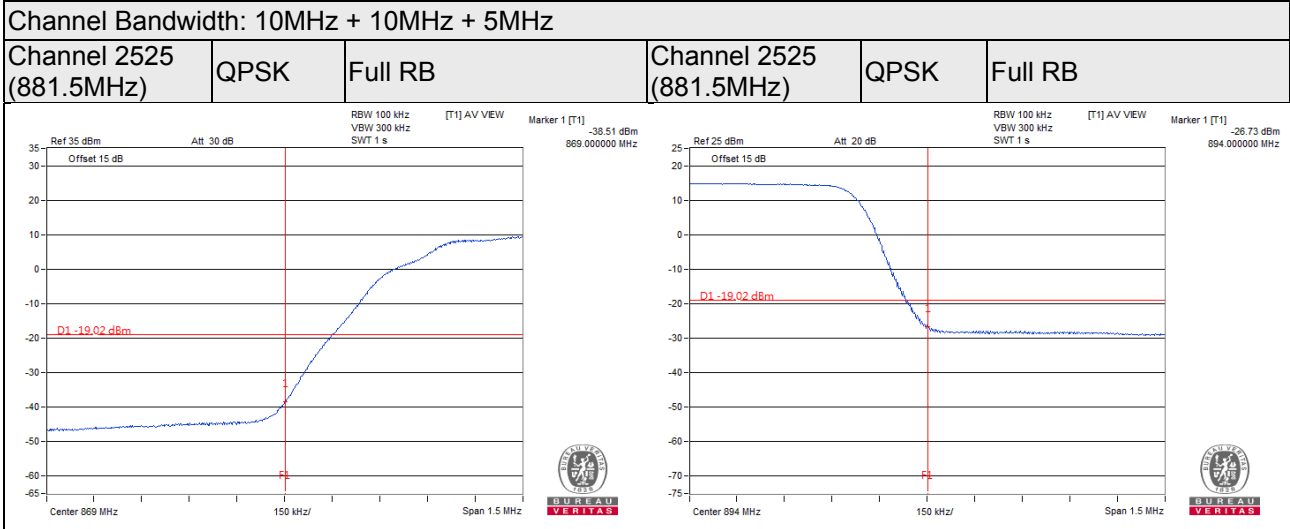

multi-carrier (Chain 1)

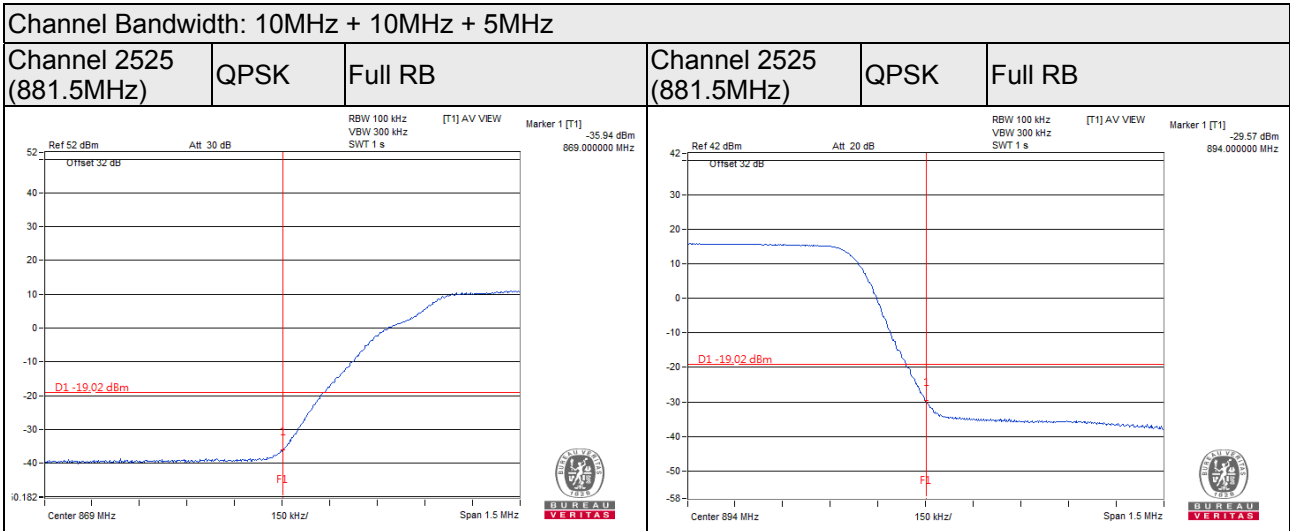

multi-carrier (Chain 2)

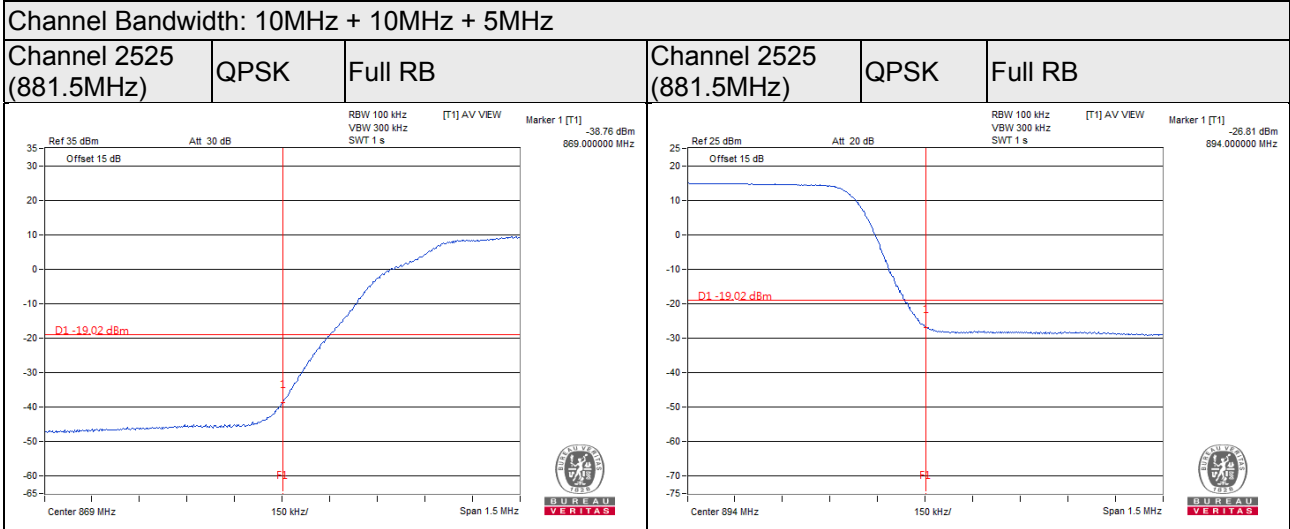

multi-carrier (Chain 3)

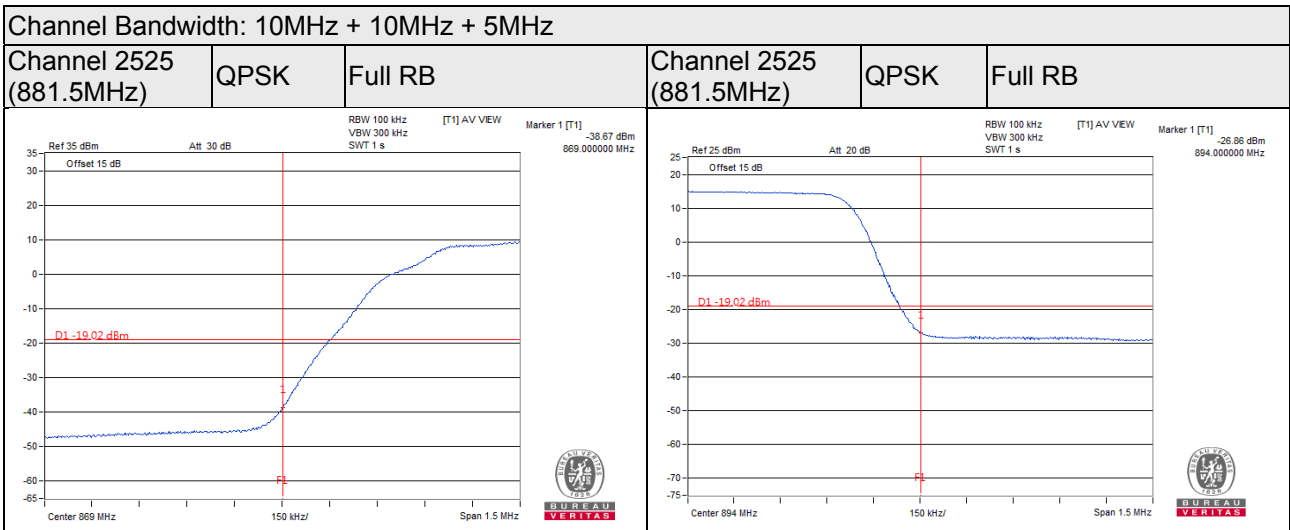

## 4.6 Peak to Average Ratio

### 4.6.1 Limits of Peak to Average Ratio Measurement

In measuring transmissions in this band using an average power technique, the peak to-average ratio (PAR) of the transmission may not exceed 13 dB

### 4.6.2 Test Setup

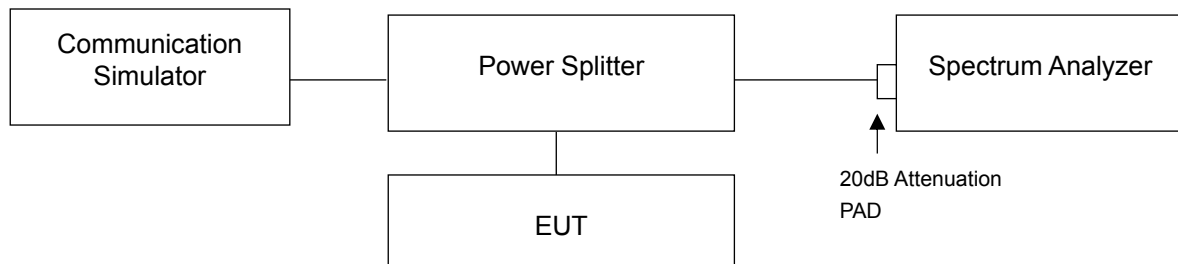

### 4.6.3 Test Procedures

- Set resolution/measurement bandwidth  $\geq$  signal's occupied bandwidth;
- Set the number of counts to a value that stabilizes the measured CCDF curve;
- Record the maximum PAPR level associated with a probability of 0.1%.

#### 4.6.4 Test Results

LTE Band 5, Channel Bandwidth 1.4MHz					
Channel	Frequency (MHz)	Peak To Average Ratio (dB)			
		QPSK	16QAM	64QAM	256QAM
2407	869.7	7.18	7.18	7.17	7.17
2525	881.5	7.20	7.19	7.19	7.19
2643	893.3	7.23	7.23	7.22	7.22

LTE Band 5, Channel Bandwidth 3MHz					
Channel	Frequency (MHz)	Peak To Average Ratio (dB)			
		QPSK	16QAM	64QAM	256QAM
2415	870.5	7.19	7.19	7.18	7.18
2525	881.5	7.16	7.16	7.16	7.16
2635	892.5	7.22	7.22	7.23	7.22

LTE Band 5, Channel Bandwidth 5MHz					
Channel	Frequency (MHz)	Peak To Average Ratio (dB)			
		QPSK	16QAM	64QAM	256QAM
2425	871.5	7.25	7.25	7.25	7.25
2525	881.5	7.76	7.17	7.18	7.18
2625	891.5	7.27	7.27	7.26	7.53

LTE Band 5, Channel Bandwidth 10MHz					
Channel	Frequency (MHz)	Peak To Average Ratio (dB)			
		QPSK	16QAM	64QAM	256QAM
2450	874.0	7.37	7.37	7.37	7.37
2525	881.5	7.18	7.17	7.17	7.18
2600	889.0	7.54	7.34	7.32	7.33

### Spectrum Plot of Worst Value

1.4MHz / QPSK

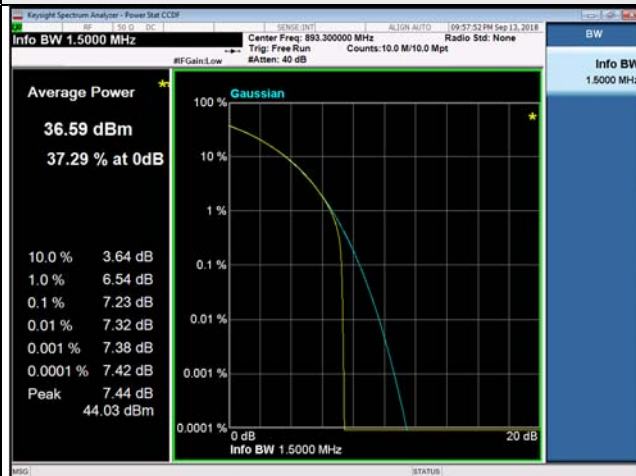

3MHz / 64QAM

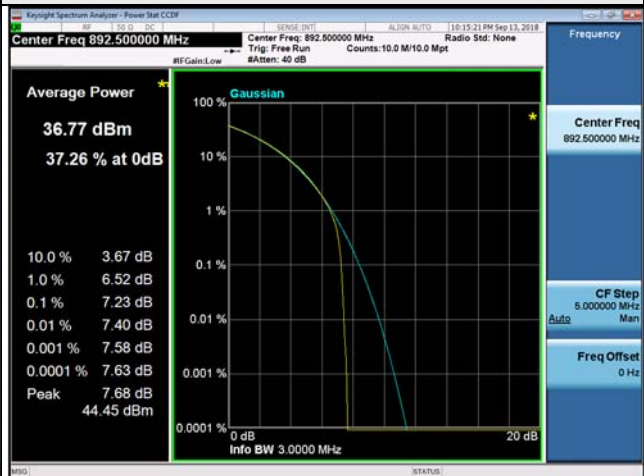

5MHz / QPSK

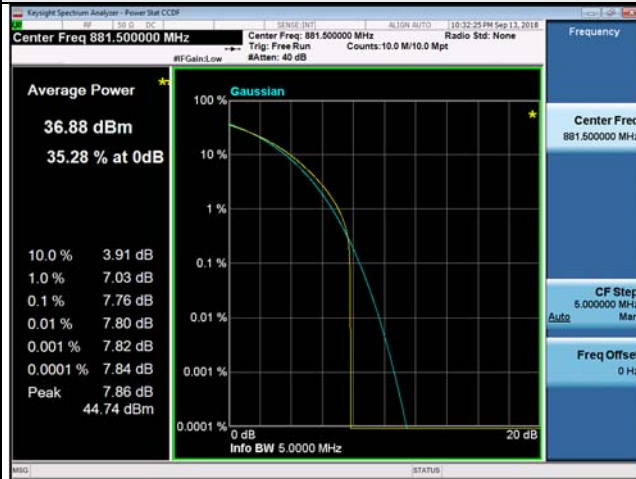

10MHz / QPSK

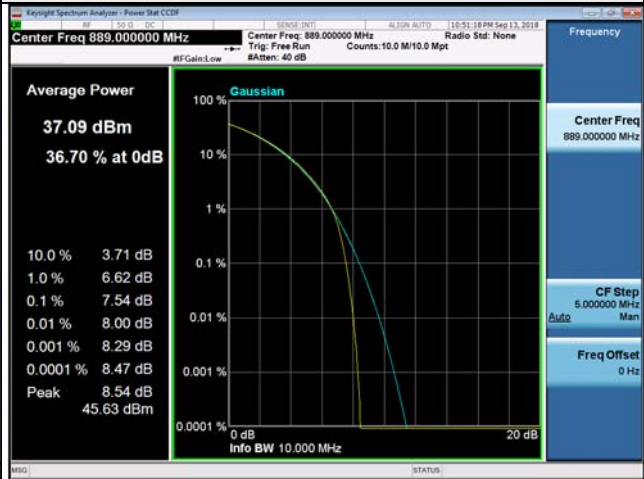

## 4.7 Conducted Spurious Emissions

### 4.7.1 Limits of Conducted Spurious Emissions Measurement

The power of any emission outside of the authorized operating frequency ranges must be attenuated below the transmitting power (P) by a factor of at least  $43 + 10 \log(P)$  dB.

Note: The device has 4x4 MIMO function, so the limit of spurious emissions needs to be reduced by  $-13 - 10 \cdot \log(4) = -19.02$  dBm according to FCC KDB 66291 D01 guidance.

### 4.7.2 Test Setup

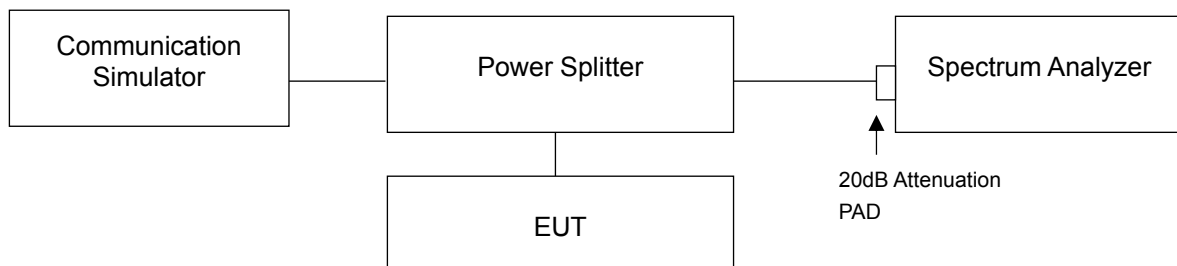

### 4.7.3 Test Procedure

- The EUT makes a phone call to the communication simulator. All measurements were done at low, middle and high operational frequency range.
- Measuring frequency range is from 9 kHz to 1GHz. 20dB attenuation pad is connected with spectrum. RBW=100kHz and VBW=300kHz is used for conducted emission measurement.
- Measuring frequency range is from 1GHz to 26.5GHz. 20dB attenuation pad is connected with spectrum. RBW=1MHz and VBW=3MHz is used for conducted emission measurement.

#### 4.7.4 Test Results

##### Single Mode (Chain 0)

LTE Band 5, Channel Bandwidth 1.4MHz

Channel 2407 (869.7MHz)

Frequency Range : 9kHz~1GHz

Frequency Range : 1GHz~10GHz

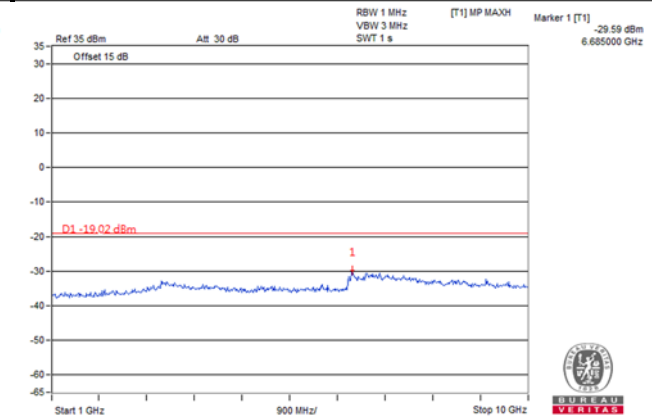
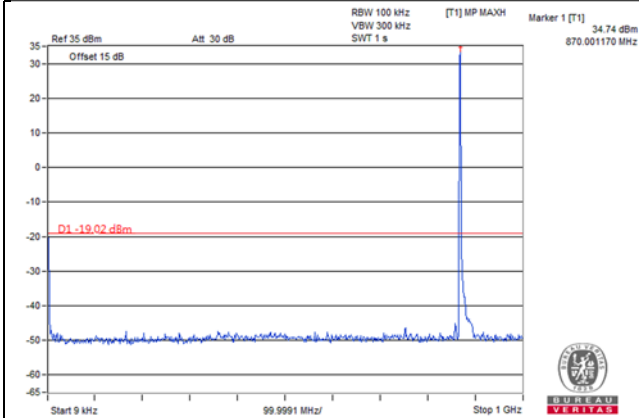

Frequency Range : 10GHz~26.5GHz

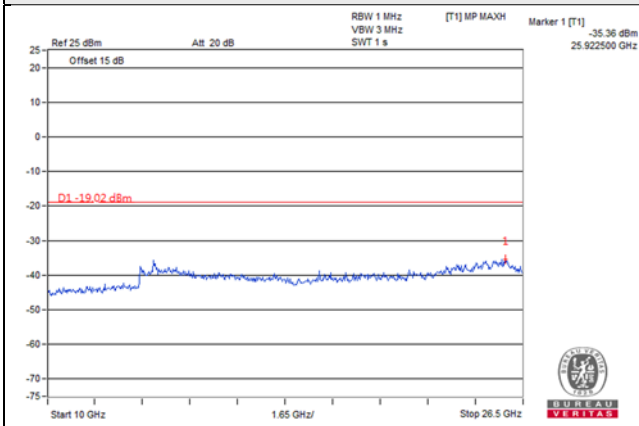



LTE Band 5, Channel Bandwidth 1.4MHz

Channel 2525 (881.5MHz)

Frequency Range : 9kHz~1GHz

Frequency Range : 1GHz~10GHz

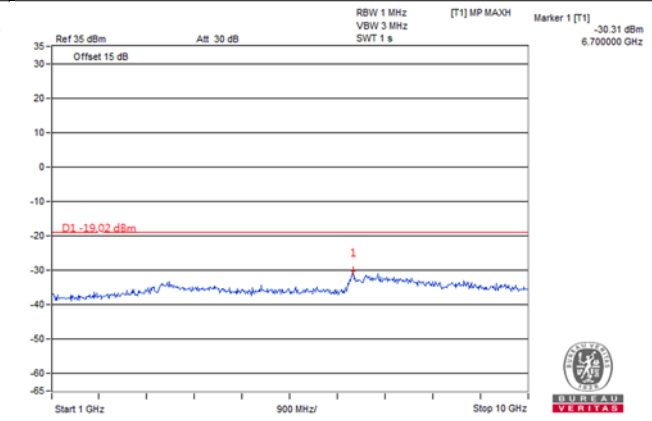
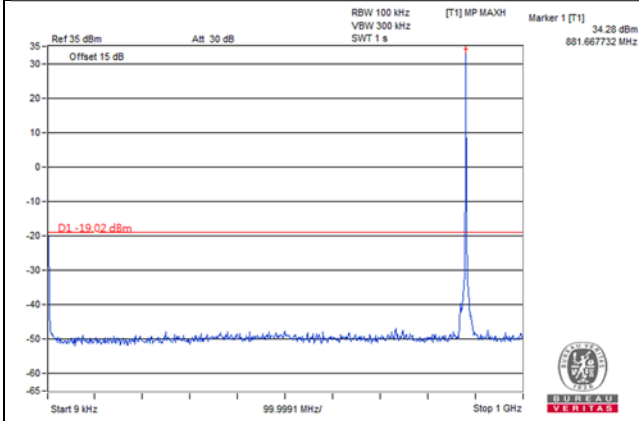

Frequency Range : 10GHz~26.5GHz

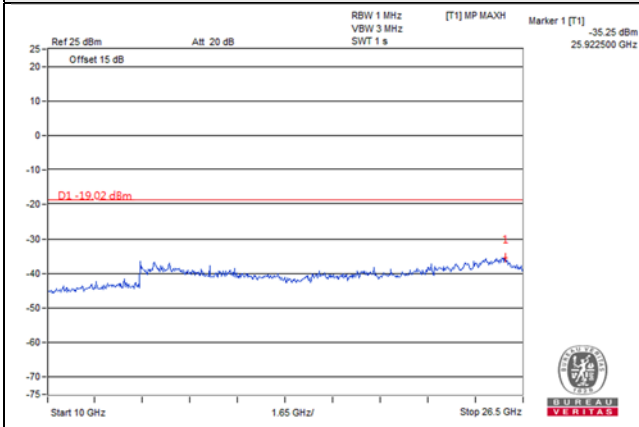

LTE Band 5, Channel Bandwidth 1.4MHz

Channel 2643 (893.3MHz)

Frequency Range : 9kHz~1GHz

Frequency Range : 1GHz~10GHz

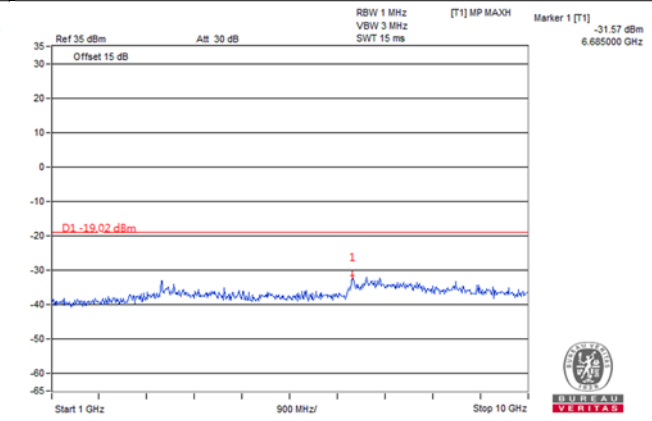
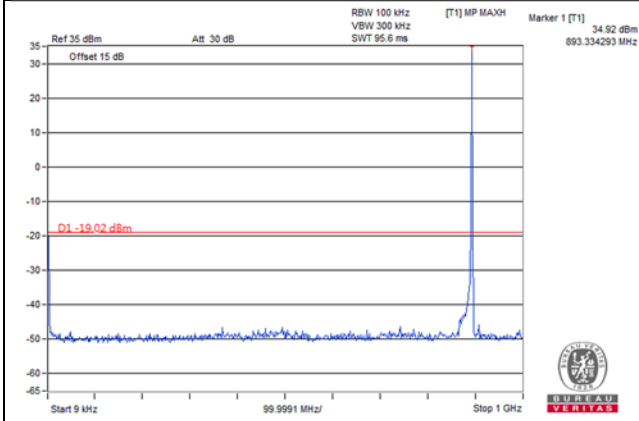

Frequency Range : 10GHz~26.5GHz

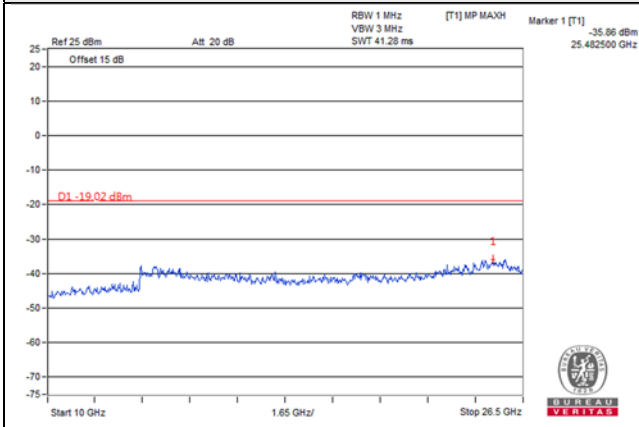

LTE Band 5, Channel Bandwidth 3MHz

Channel 2415 (870.5MHz)

Frequency Range : 9kHz~1GHz

Frequency Range : 1GHz~10GHz

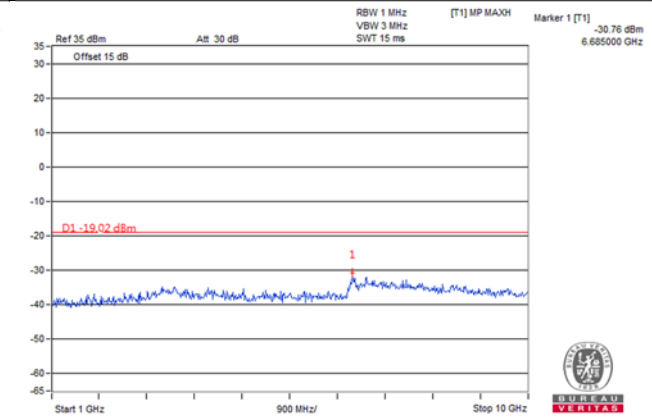
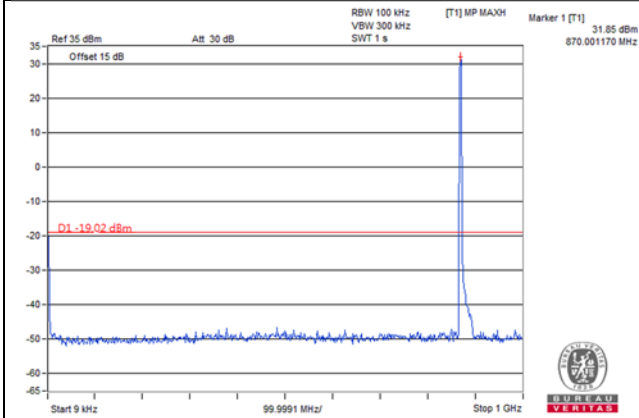

Frequency Range : 10GHz~26.5GHz

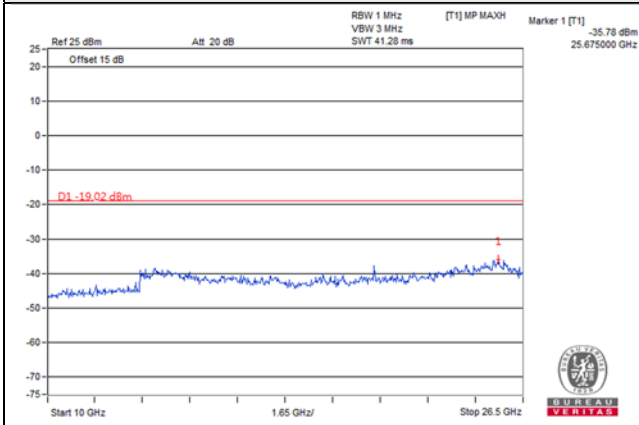

LTE Band 5, Channel Bandwidth 3MHz

Channel 2525 (881.5MHz)

Frequency Range : 9kHz~1GHz

Frequency Range : 1GHz~10GHz

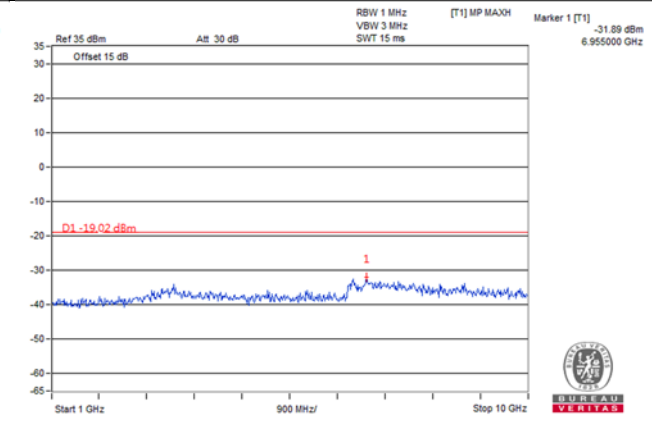
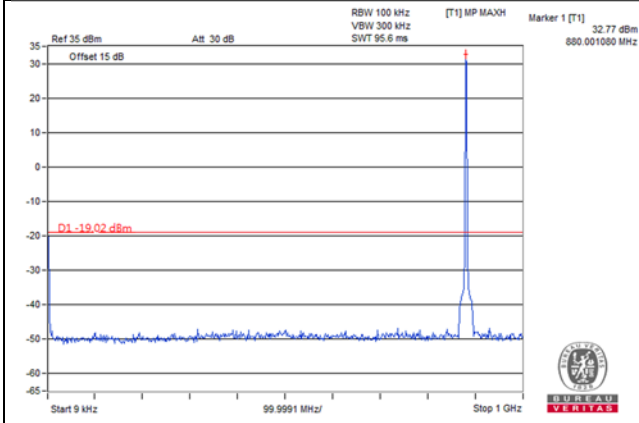

Frequency Range : 10GHz~26.5GHz

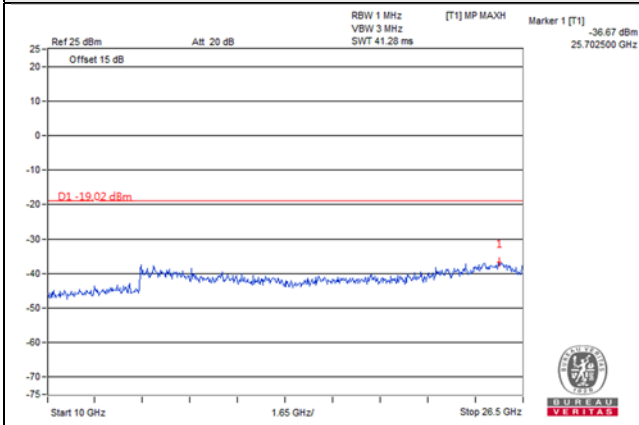

LTE Band 5, Channel Bandwidth 3MHz

Channel 2635 (892.5MHz)

Frequency Range : 9kHz~1GHz

Frequency Range : 1GHz~10GHz

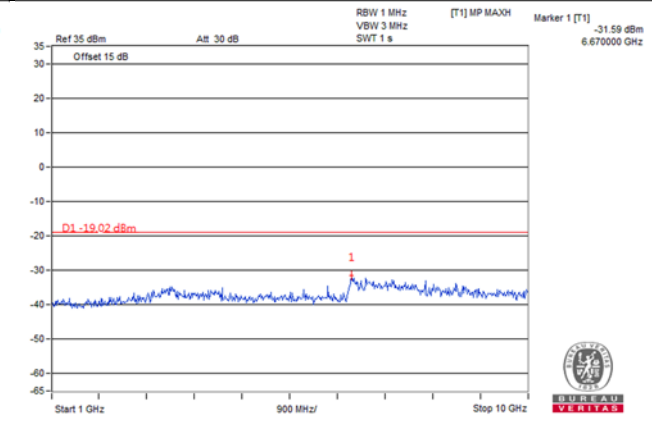
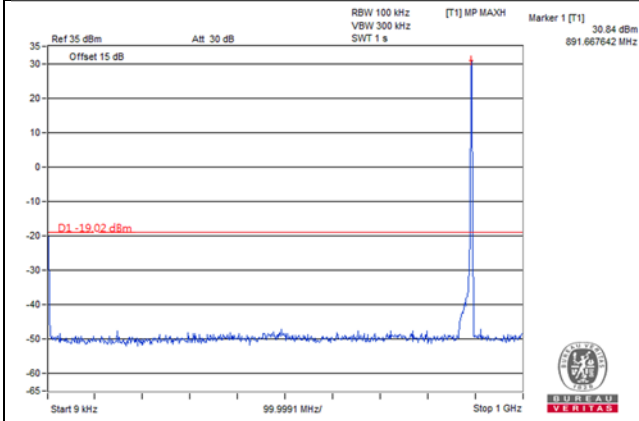

Frequency Range : 10GHz~26.5GHz

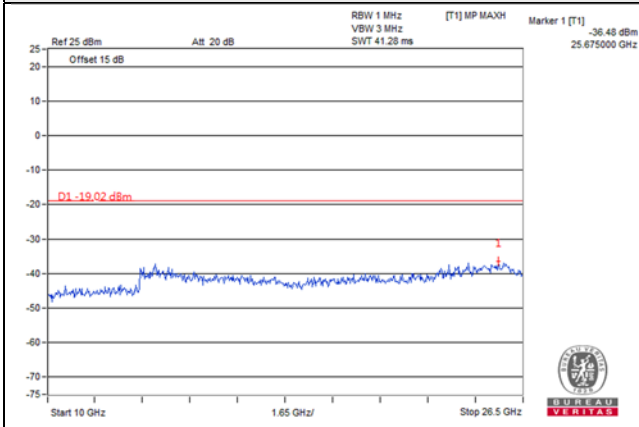

LTE Band 5, Channel Bandwidth 5MHz

Channel 2425 (871.5MHz)

Frequency Range : 9kHz~1GHz

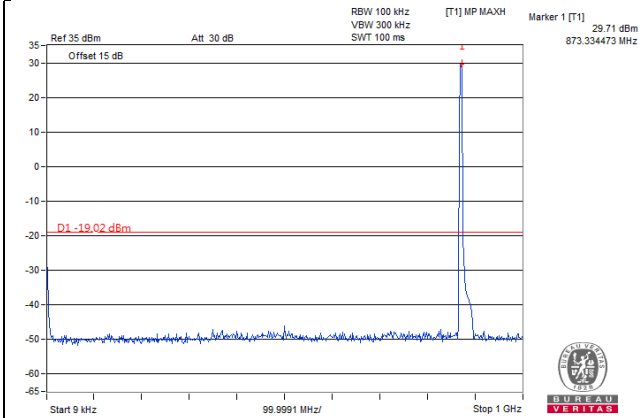

Frequency Range : 1GHz~10GHz

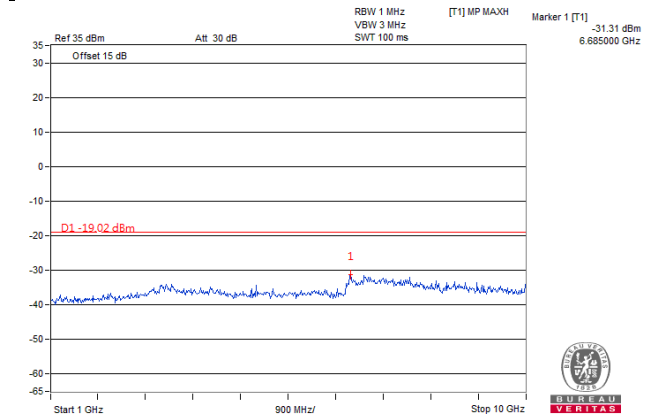

Frequency Range : 10GHz~26.5GHz

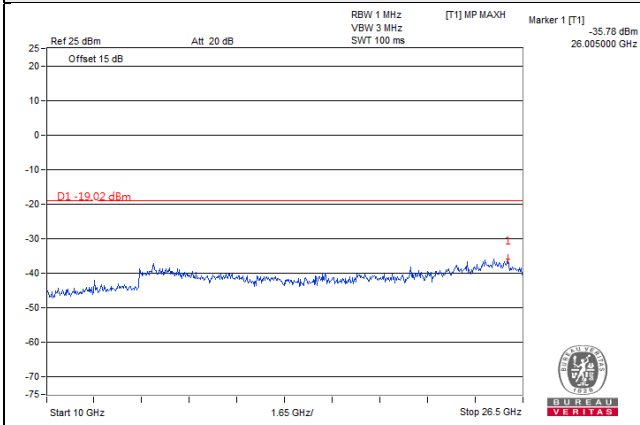

LTE Band 5, Channel Bandwidth 5MHz

Channel 2525 (881.5MHz)

Frequency Range : 9kHz~1GHz

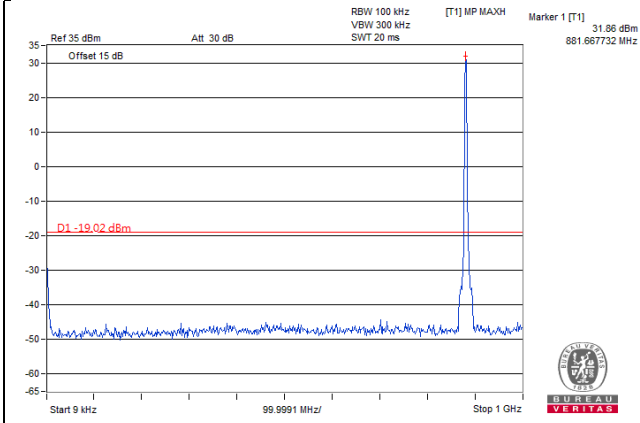

Frequency Range : 1GHz~10GHz

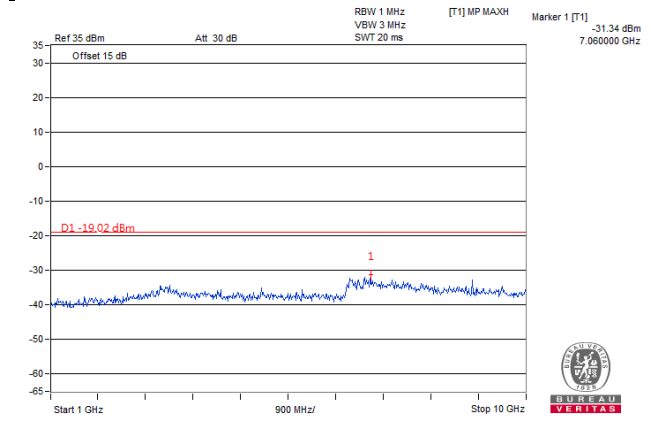

Frequency Range : 10GHz~26.5GHz

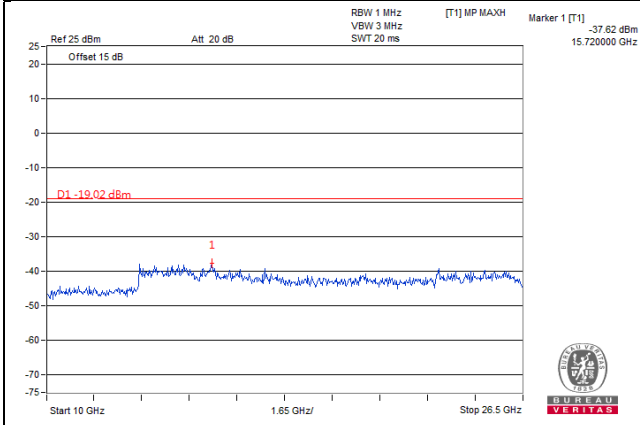

LTE Band 5, Channel Bandwidth 5MHz

Channel 2625 (891.5MHz)

Frequency Range : 9kHz~1GHz

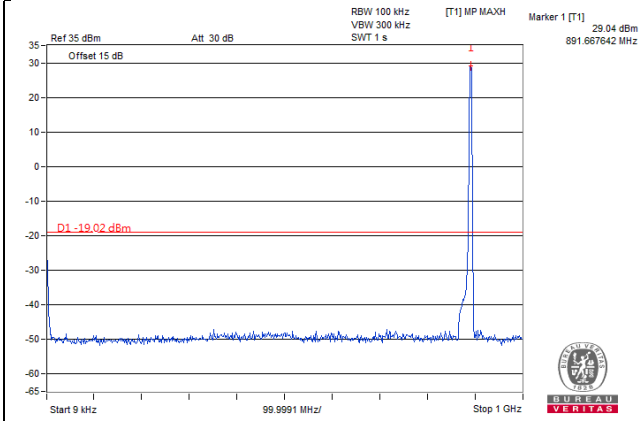

Frequency Range : 1GHz~10GHz

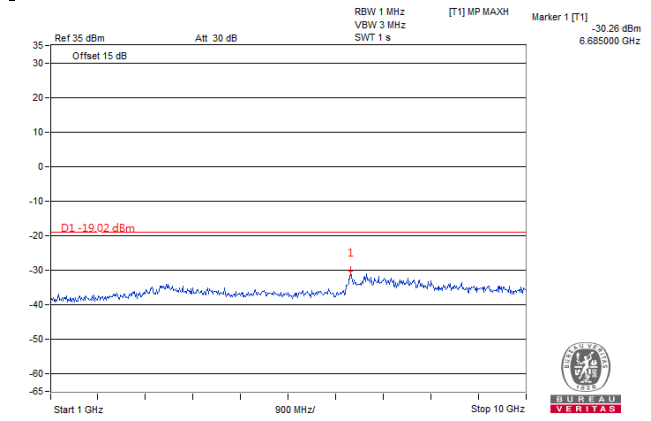

Frequency Range : 10GHz~26.5GHz

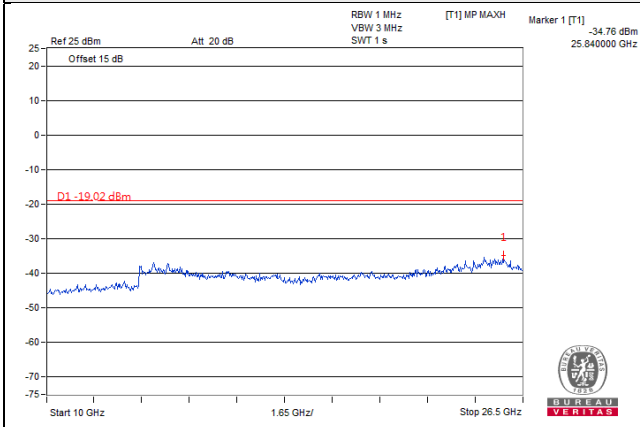



LTE Band 5, Channel Bandwidth 10MHz

Channel 2450 (874.0MHz)

Frequency Range : 9kHz~1GHz

Frequency Range : 1GHz~10GHz

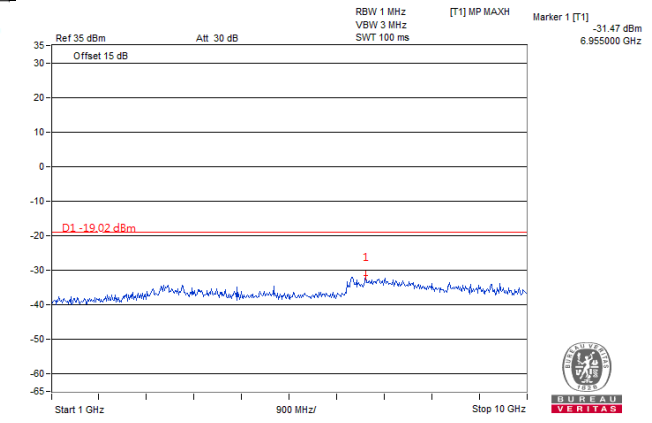
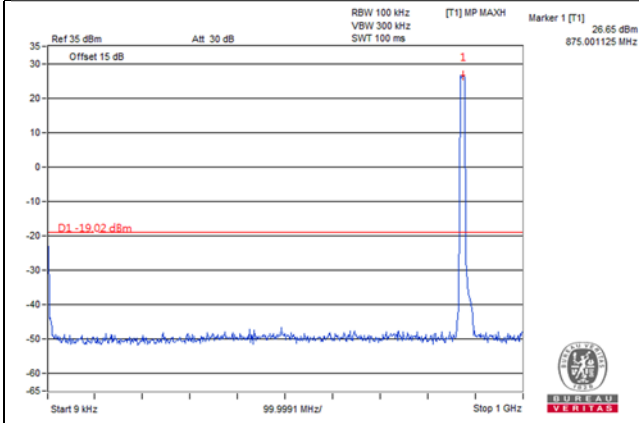

Frequency Range : 10GHz~26.5GHz

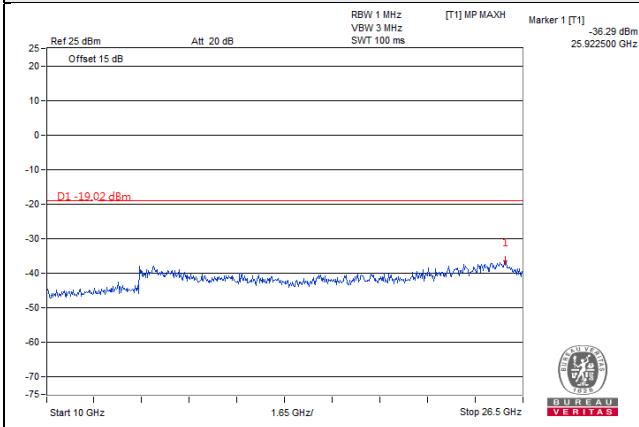

LTE Band 5, Channel Bandwidth 10MHz

Channel 2525 (881.5MHz)

Frequency Range : 9kHz~1GHz

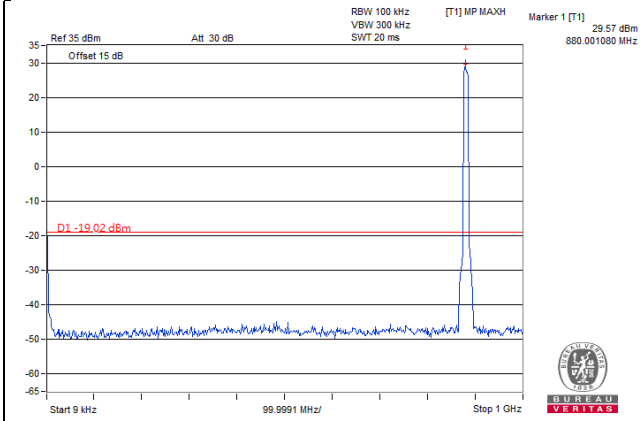

Frequency Range : 1GHz~10GHz

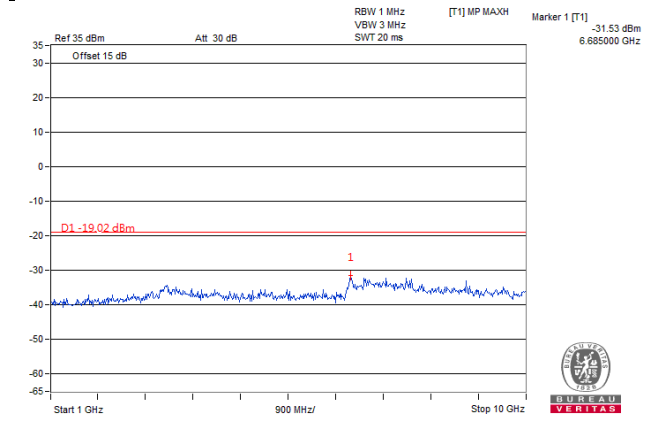

Frequency Range : 10GHz~26.5GHz

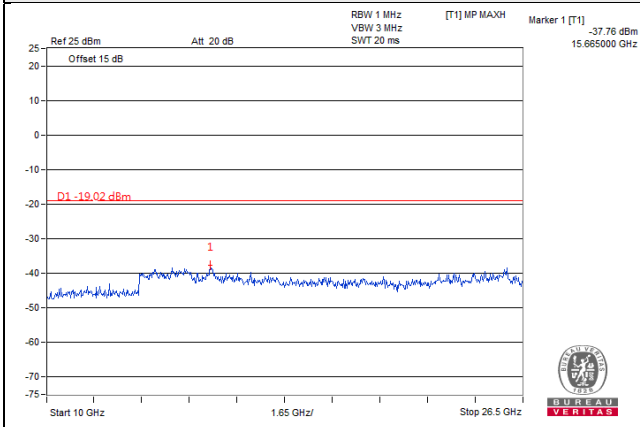

LTE Band 5, Channel Bandwidth 10MHz

Channel 2600 (889.0MHz)

Frequency Range : 9kHz~1GHz

Frequency Range : 1GHz~10GHz

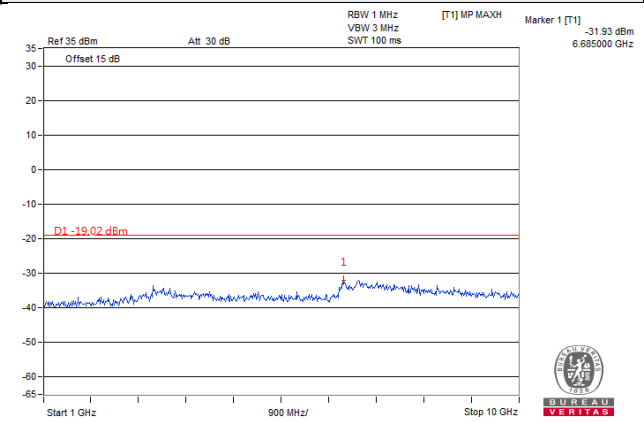
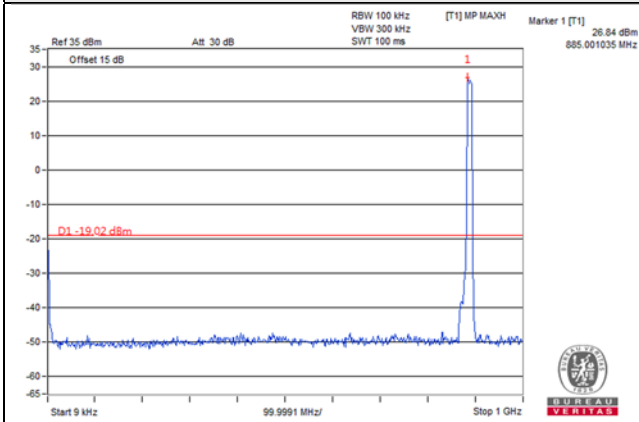

Frequency Range : 10GHz~26.5GHz

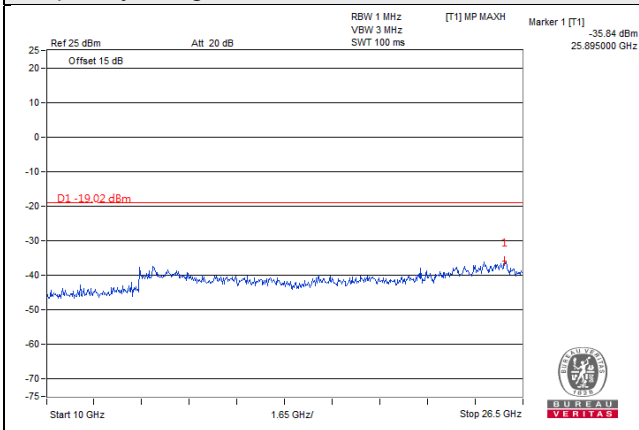

Single Mode (Chain 1)

LTE Band 5, Channel Bandwidth 1.4MHz

Channel 2407 (869.7MHz)

Frequency Range : 9kHz~1GHz      Frequency Range : 1GHz~10GHz

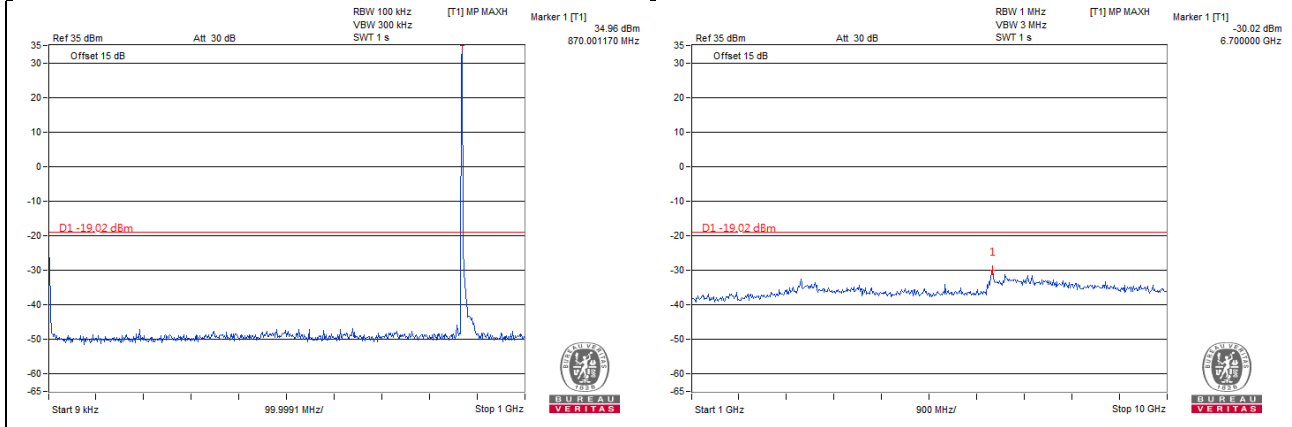

Frequency Range : 10GHz~26.5GHz

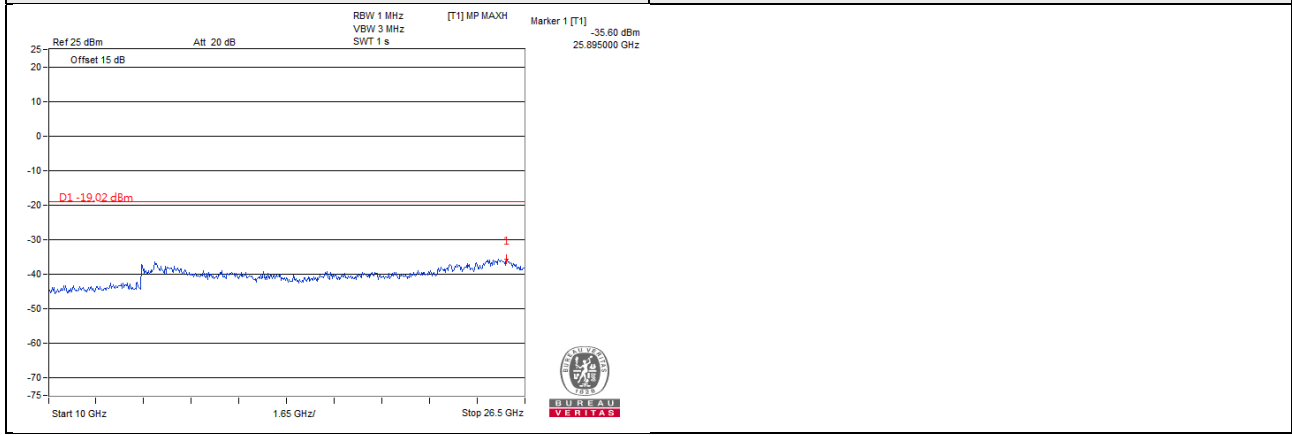

LTE Band 5, Channel Bandwidth 1.4MHz

Channel 2525 (881.5MHz)

Frequency Range : 9kHz~1GHz

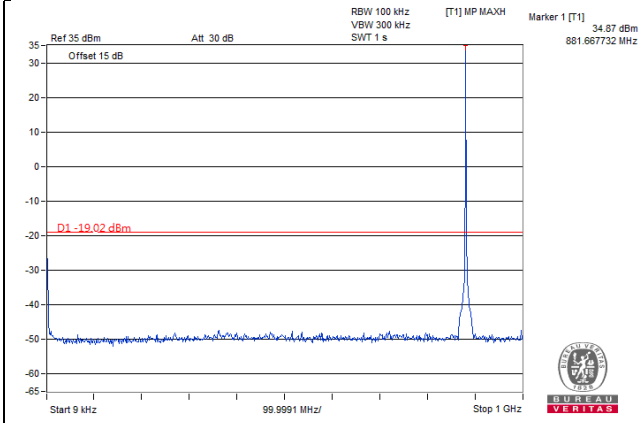

Frequency Range : 1GHz~10GHz

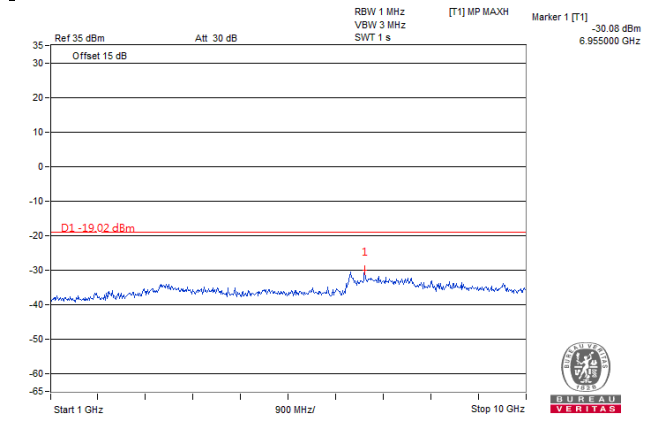

Frequency Range : 10GHz~26.5GHz

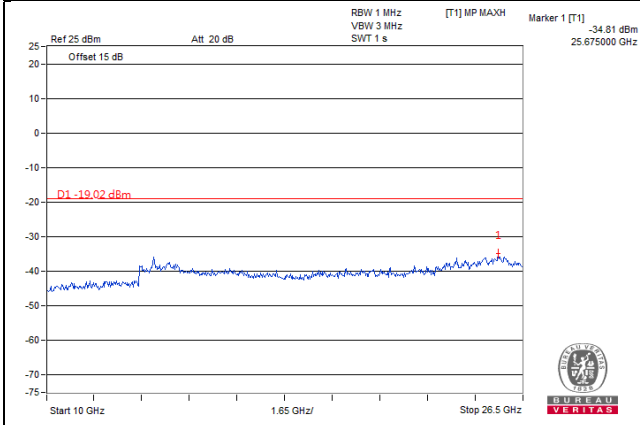

LTE Band 5, Channel Bandwidth 1.4MHz

Channel 2643 (893.3MHz)

Frequency Range : 9kHz~1GHz

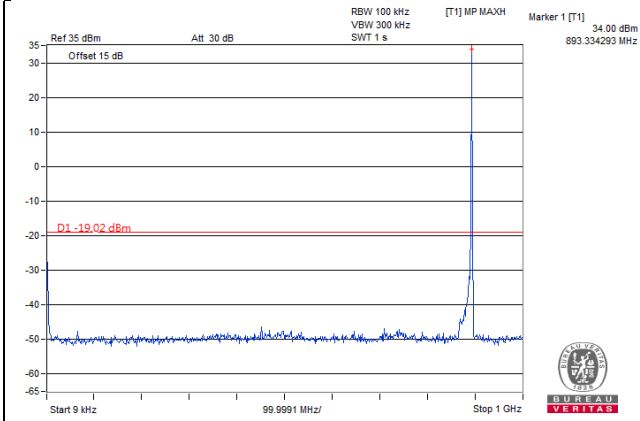

Frequency Range : 1GHz~10GHz

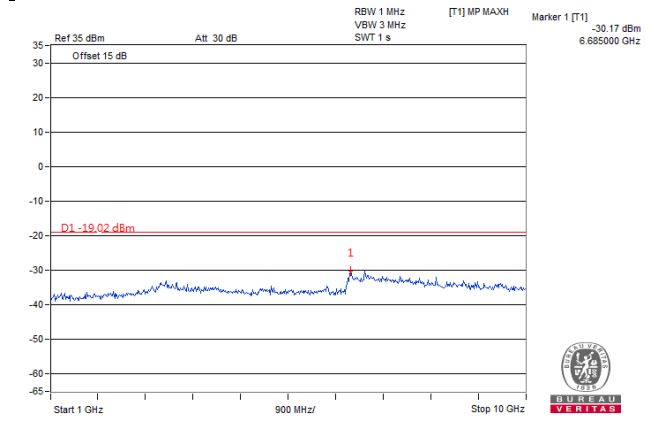

Frequency Range : 10GHz~26.5GHz

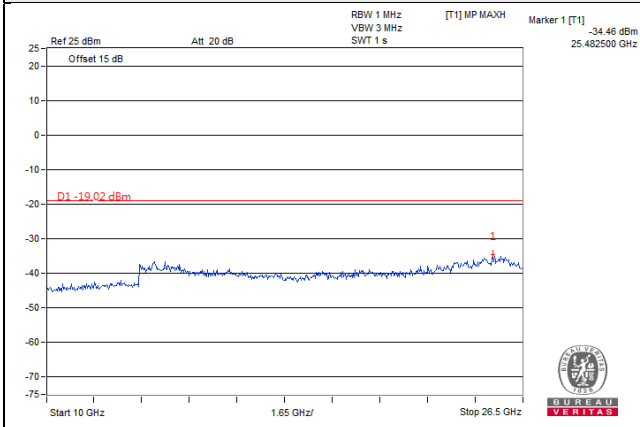

LTE Band 5, Channel Bandwidth 3MHz

Channel 2415 (870.5MHz)

Frequency Range : 9kHz~1GHz

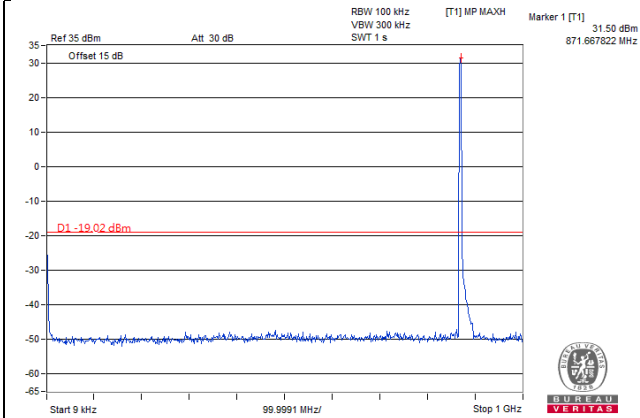

Frequency Range : 1GHz~10GHz

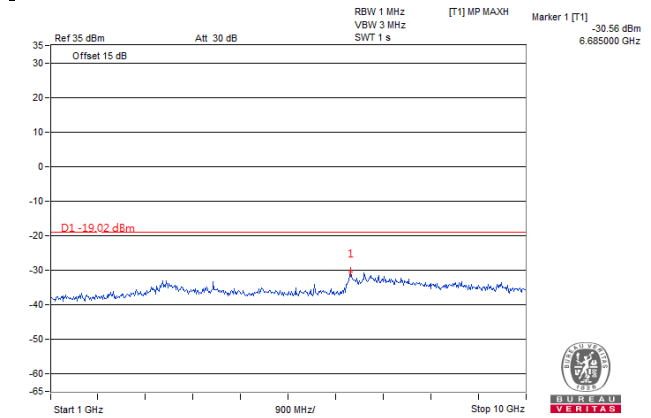

Frequency Range : 10GHz~26.5GHz

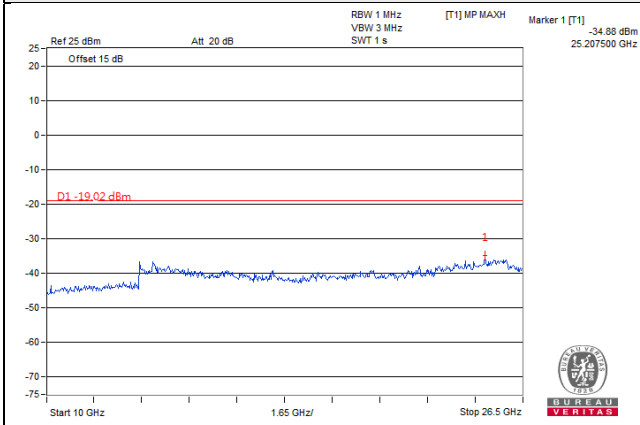

LTE Band 5, Channel Bandwidth 3MHz

Channel 2525 (881.5MHz)

Frequency Range : 9kHz~1GHz

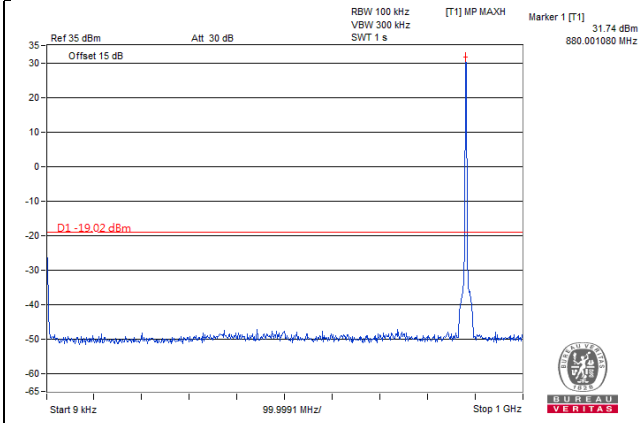

Frequency Range : 1GHz~10GHz

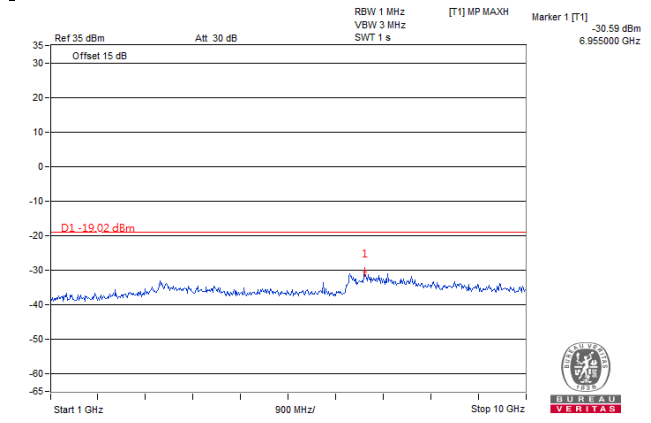

Frequency Range : 10GHz~26.5GHz

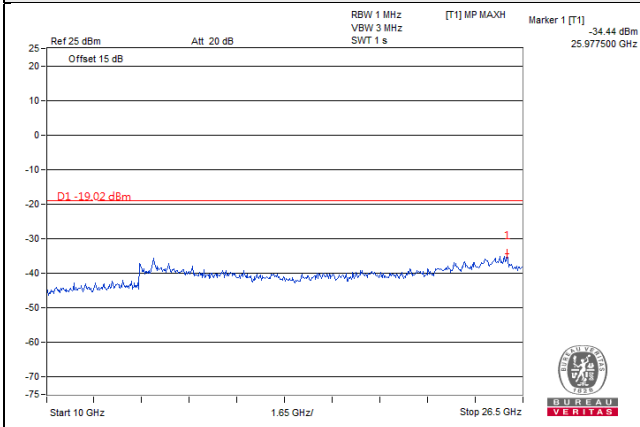



LTE Band 5, Channel Bandwidth 3MHz

Channel 2635 (892.5MHz)

Frequency Range : 9kHz~1GHz

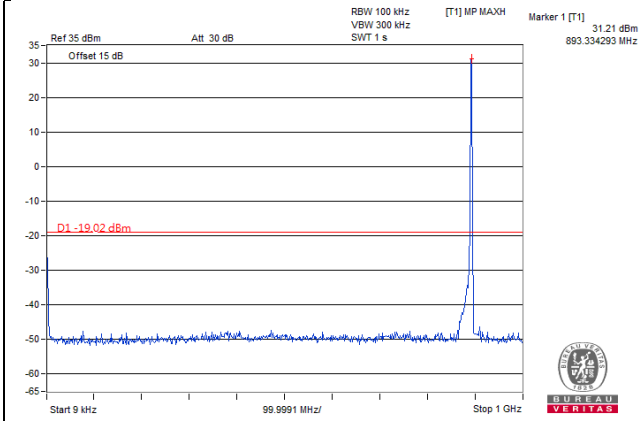

Frequency Range : 1GHz~10GHz

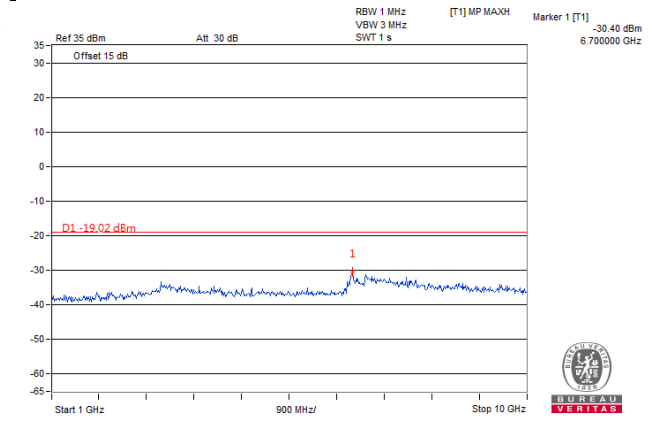

Frequency Range : 10GHz~26.5GHz

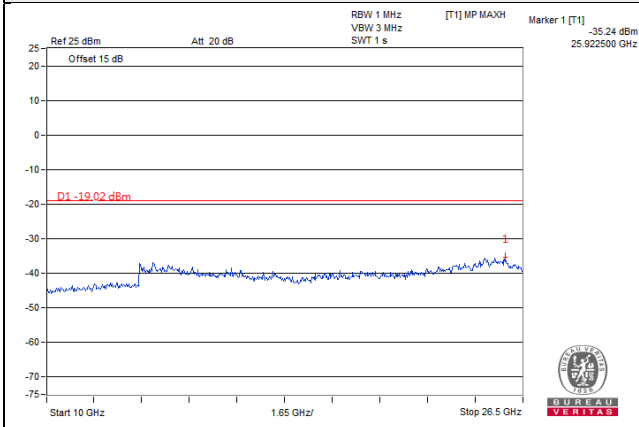

LTE Band 5, Channel Bandwidth 5MHz

Channel 2425 (871.5MHz)

Frequency Range : 9kHz~1GHz

Frequency Range : 1GHz~10GHz

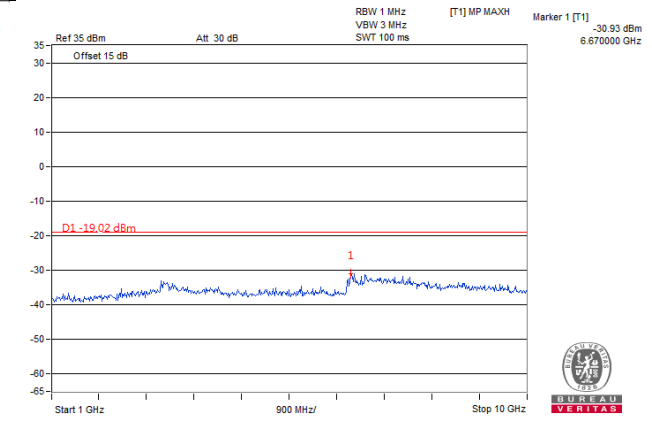
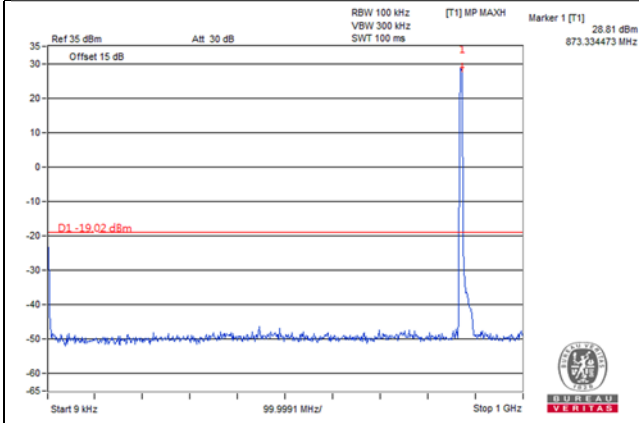

Frequency Range : 10GHz~26.5GHz

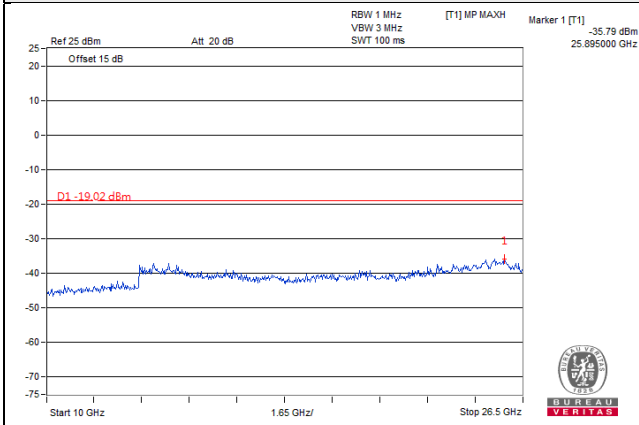

LTE Band 5, Channel Bandwidth 5MHz

Channel 2525 (881.5MHz)

Frequency Range : 9kHz~1GHz

Frequency Range : 1GHz~10GHz

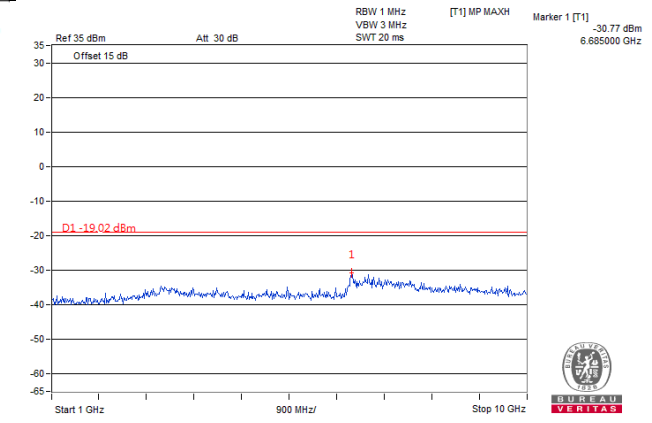
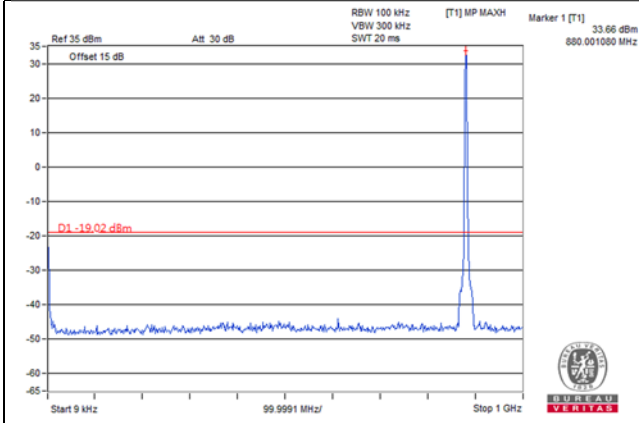

Frequency Range : 10GHz~26.5GHz

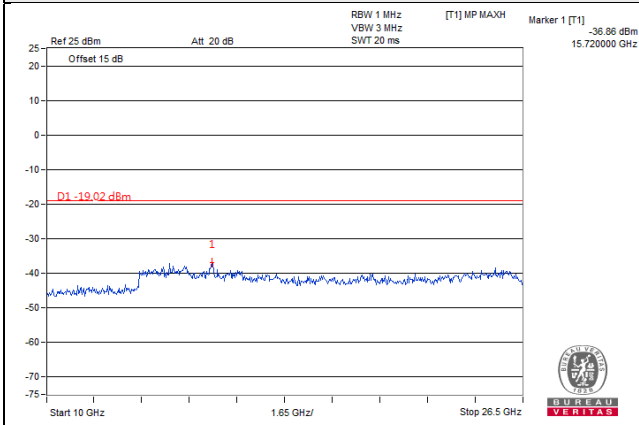

LTE Band 5, Channel Bandwidth 5MHz

Channel 2625 (891.5MHz)

Frequency Range : 9kHz~1GHz

Frequency Range : 1GHz~10GHz

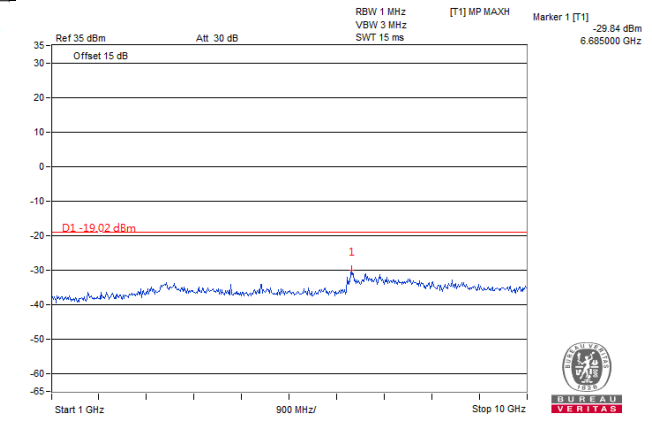
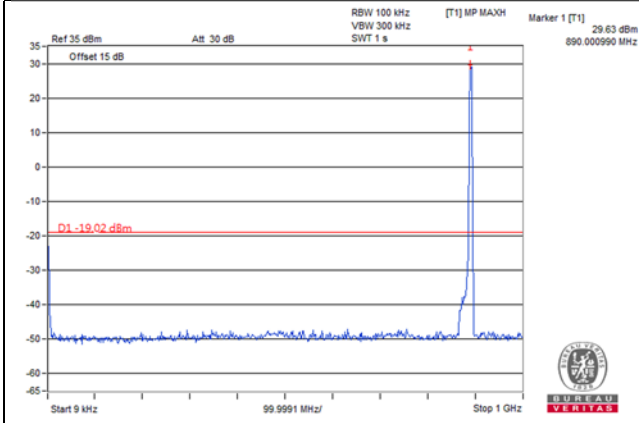

Frequency Range : 10GHz~26.5GHz

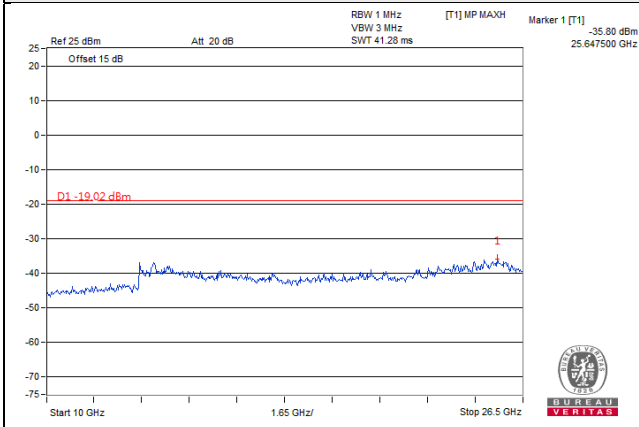

LTE Band 5, Channel Bandwidth 10MHz

Channel 2450 (874.0MHz)

Frequency Range : 9kHz~1GHz

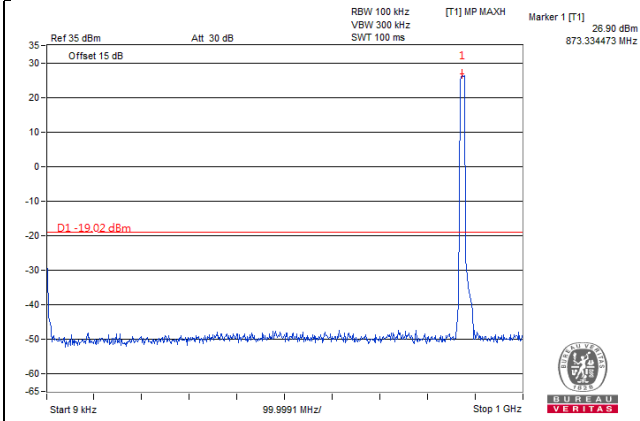

Frequency Range : 1GHz~10GHz

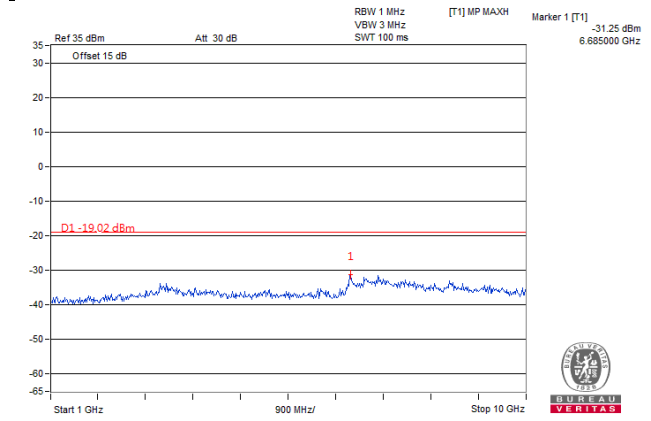

Frequency Range : 10GHz~26.5GHz

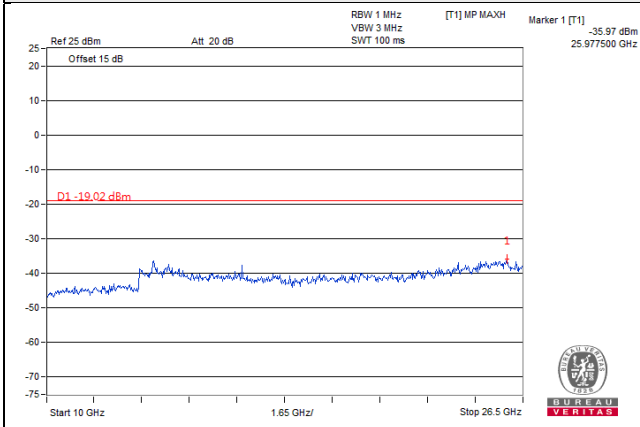

LTE Band 5, Channel Bandwidth 10MHz

Channel 2525 (881.5MHz)

Frequency Range : 9kHz~1GHz

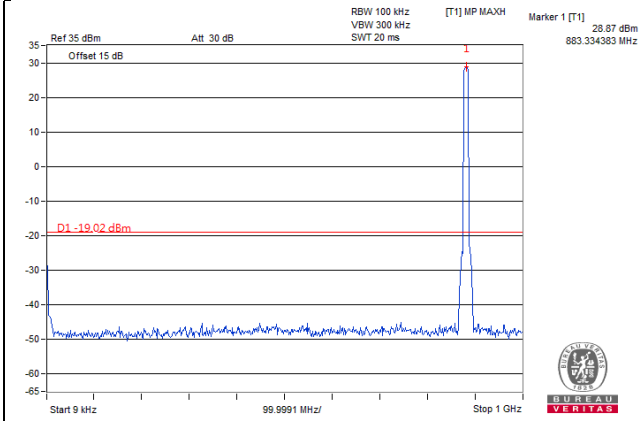

Frequency Range : 1GHz~10GHz

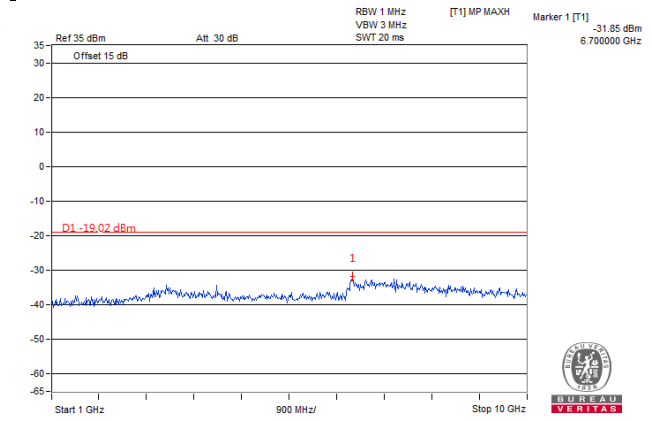

Frequency Range : 10GHz~26.5GHz

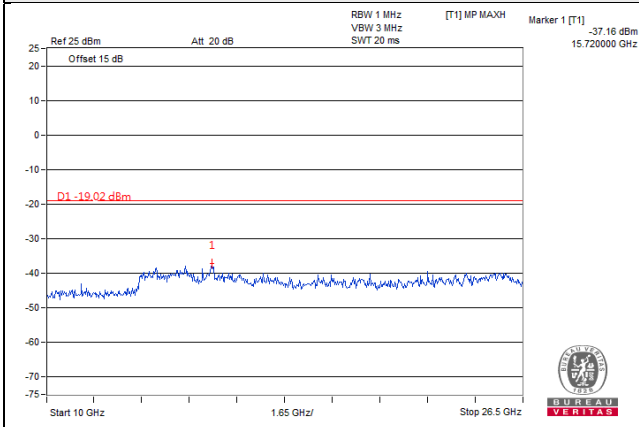

LTE Band 5, Channel Bandwidth 10MHz

Channel 2600 (889.0MHz)

Frequency Range : 9kHz~1GHz

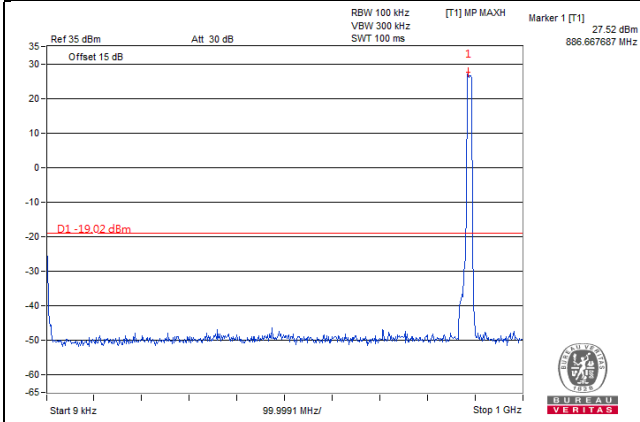

Frequency Range : 1GHz~10GHz

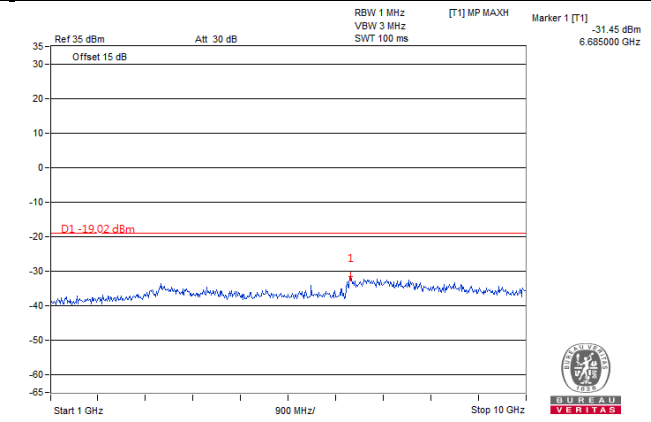

Frequency Range : 10GHz~26.5GHz

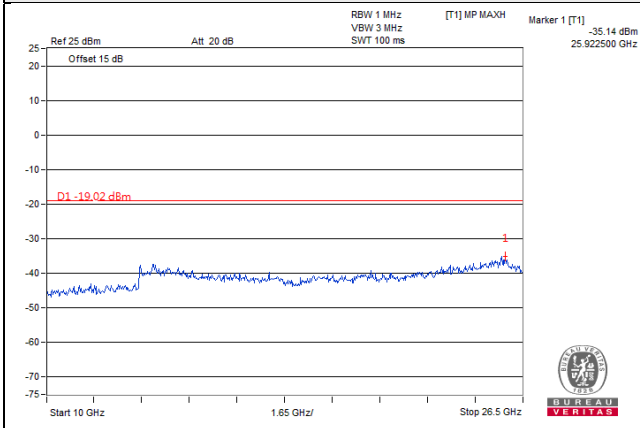

Single Mode (Chain 2)

LTE Band 5, Channel Bandwidth 1.4MHz

Channel 2407 (869.7MHz)

Frequency Range : 9kHz~1GHz      Frequency Range : 1GHz~10GHz

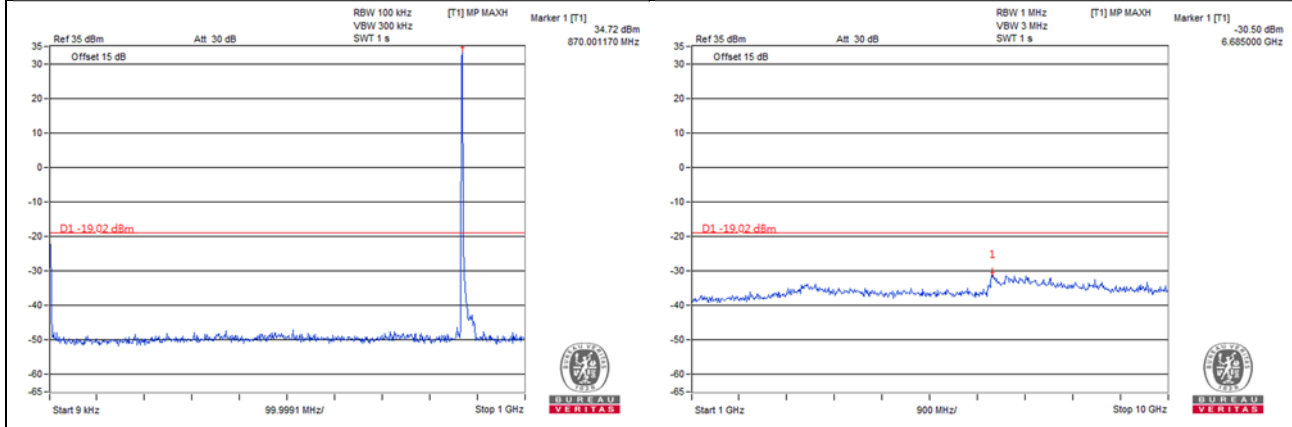

Frequency Range : 10GHz~26.5GHz

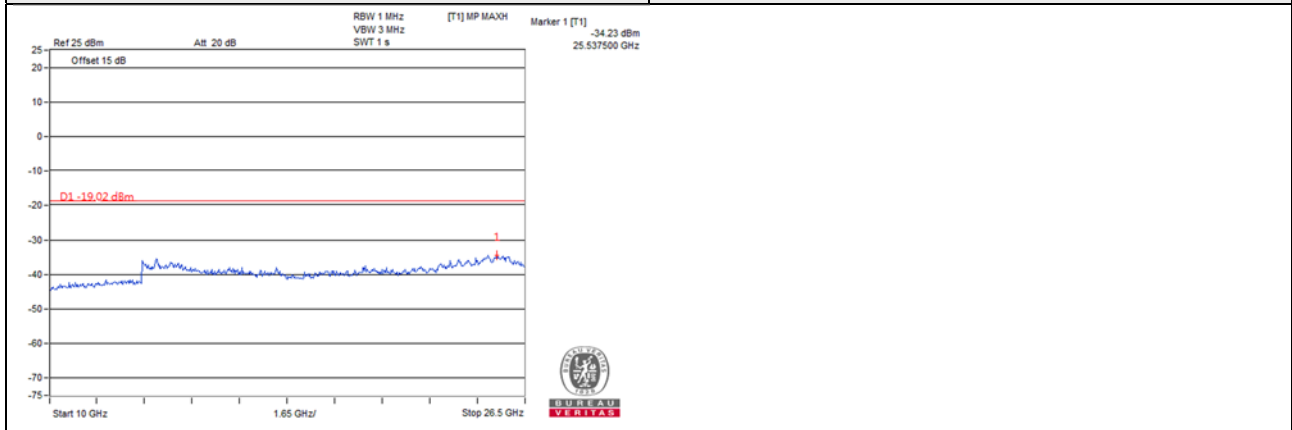



LTE Band 5, Channel Bandwidth 1.4MHz

Channel 2525 (881.5MHz)

Frequency Range : 9kHz~1GHz

Frequency Range : 1GHz~10GHz

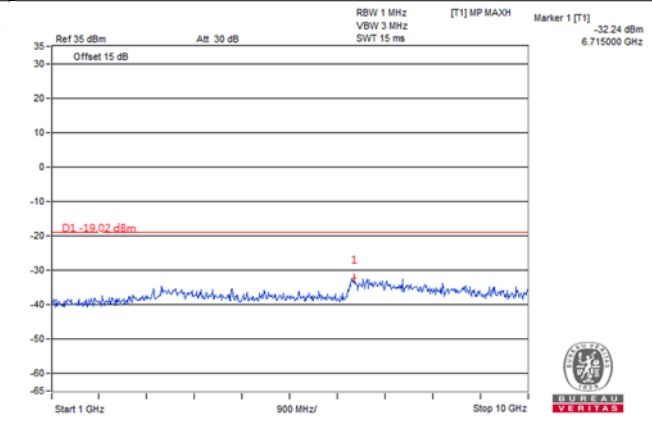
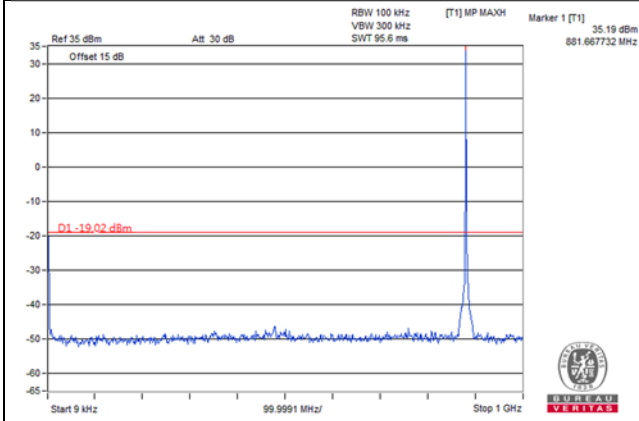

Frequency Range : 10GHz~26.5GHz

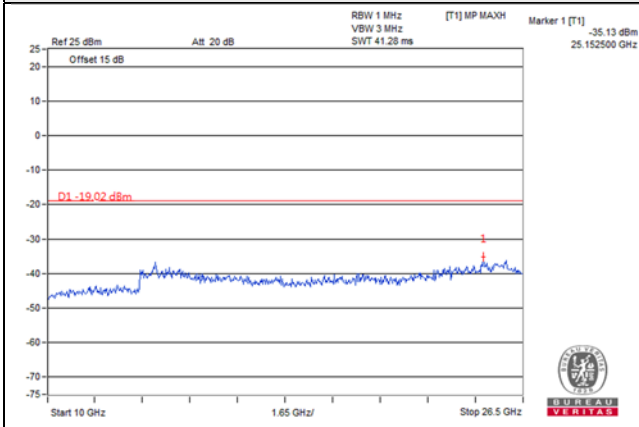

LTE Band 5, Channel Bandwidth 1.4MHz

Channel 2643 (893.3MHz)

Frequency Range : 9kHz~1GHz

Frequency Range : 1GHz~10GHz

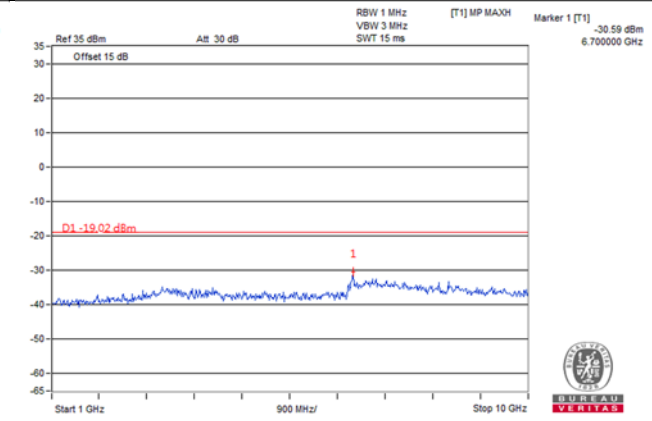
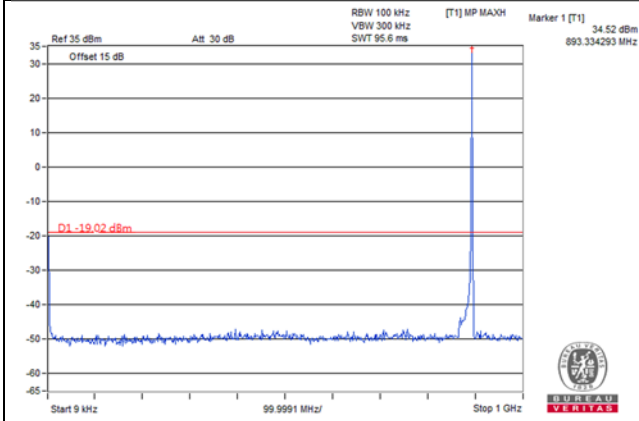

Frequency Range : 10GHz~26.5GHz

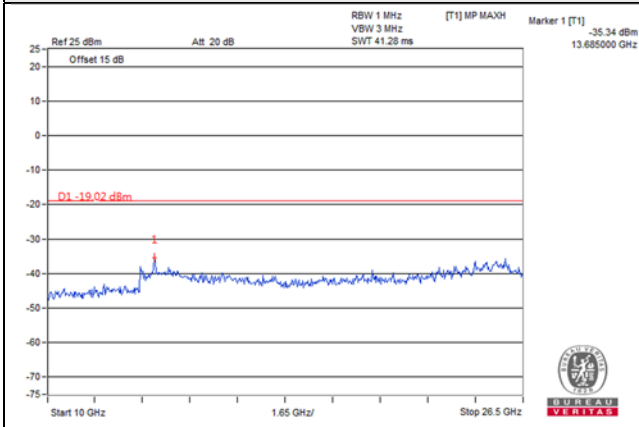

LTE Band 5, Channel Bandwidth 3MHz

Channel 2415 (870.5MHz)

Frequency Range : 9kHz~1GHz

Frequency Range : 1GHz~10GHz

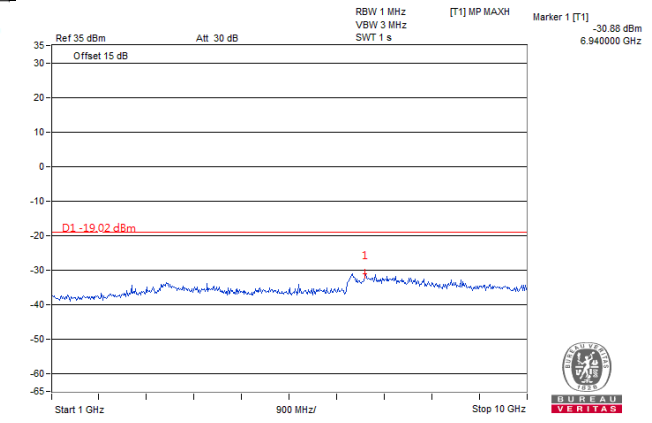
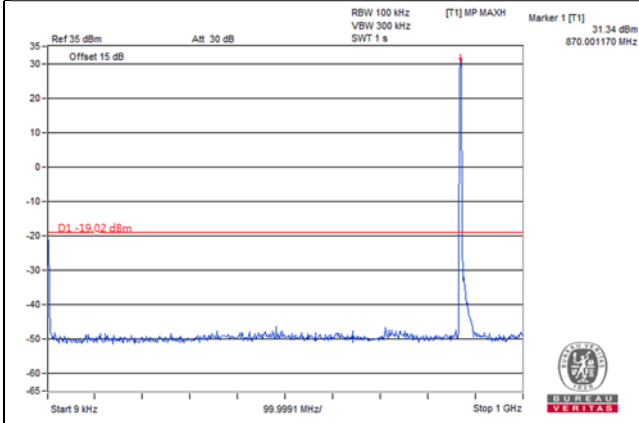

Frequency Range : 10GHz~26.5GHz

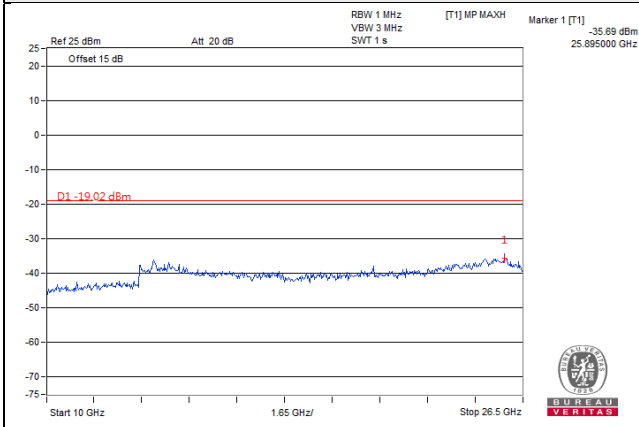

LTE Band 5, Channel Bandwidth 3MHz

Channel 2525 (881.5MHz)

Frequency Range : 9kHz~1GHz

Frequency Range : 1GHz~10GHz

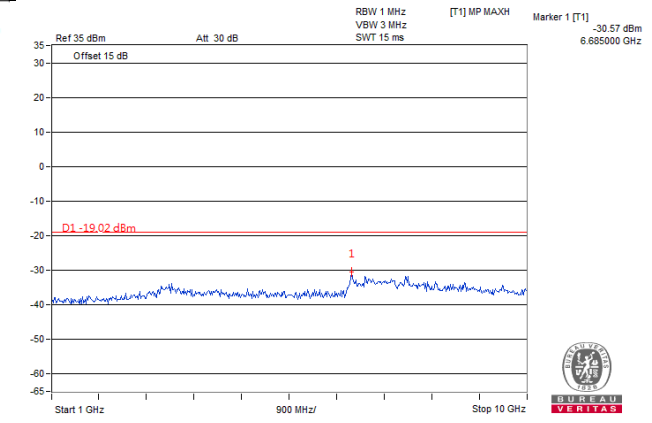
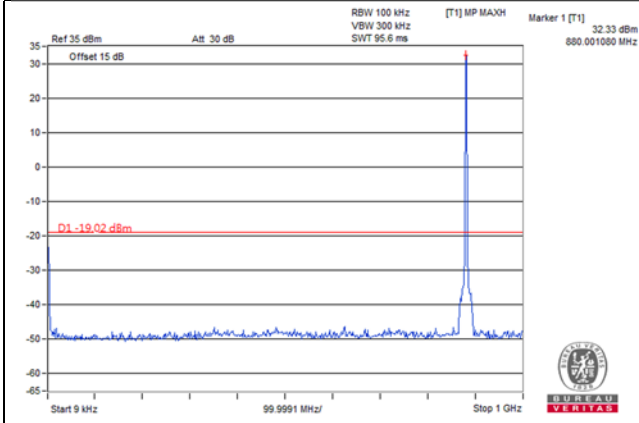

Frequency Range : 10GHz~26.5GHz

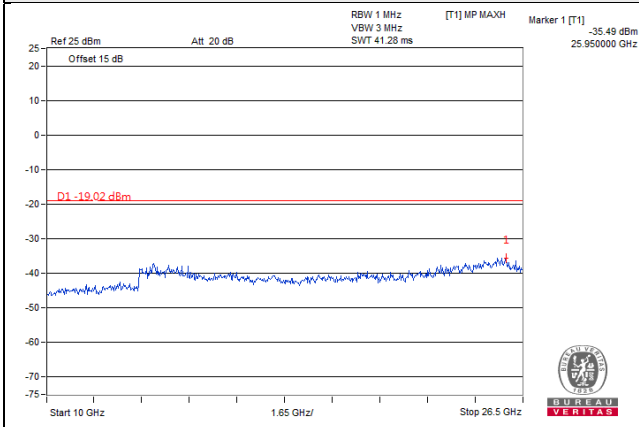

LTE Band 5, Channel Bandwidth 3MHz

Channel 2635 (892.5MHz)

Frequency Range : 9kHz~1GHz

Frequency Range : 1GHz~10GHz

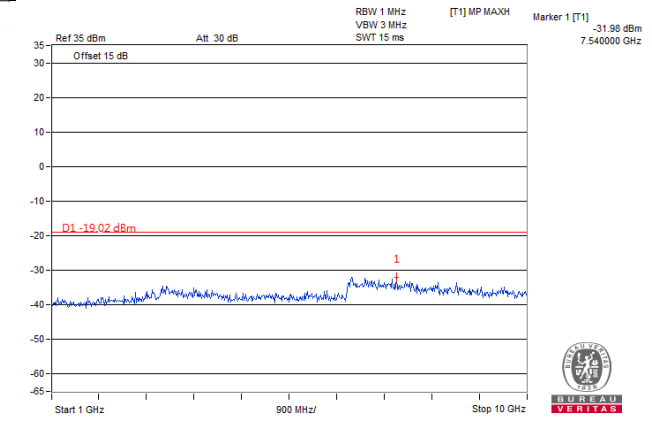
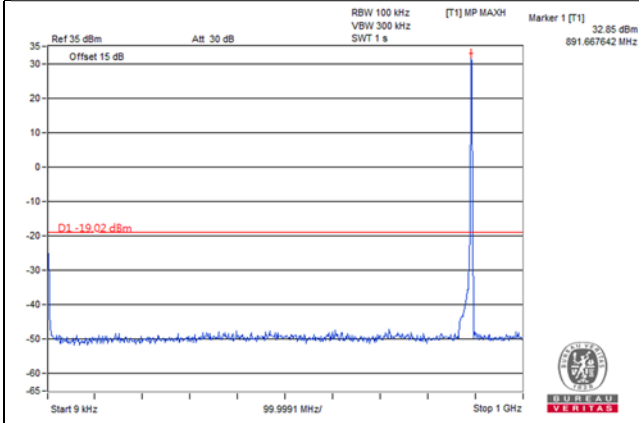

Frequency Range : 10GHz~26.5GHz

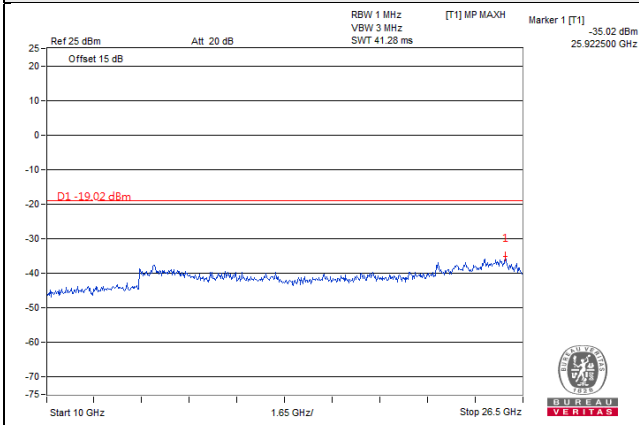

LTE Band 5, Channel Bandwidth 5MHz

Channel 2425 (871.5MHz)

Frequency Range : 9kHz~1GHz

Frequency Range : 1GHz~10GHz

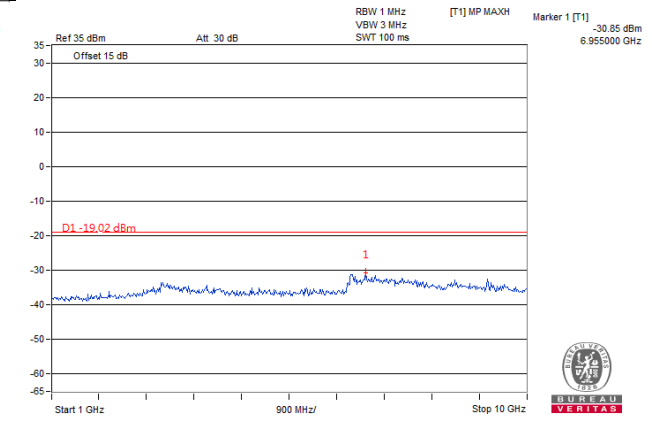
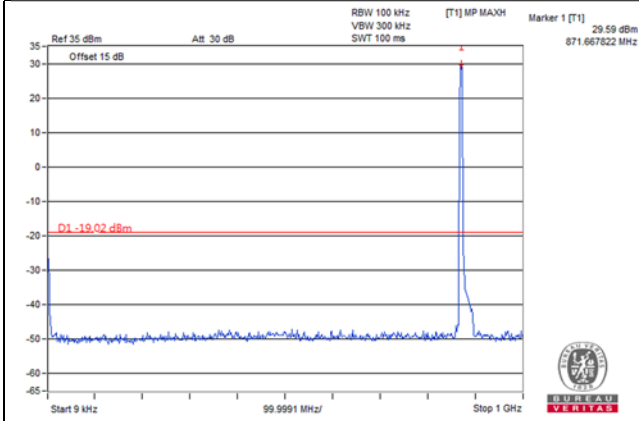

Frequency Range : 10GHz~26.5GHz

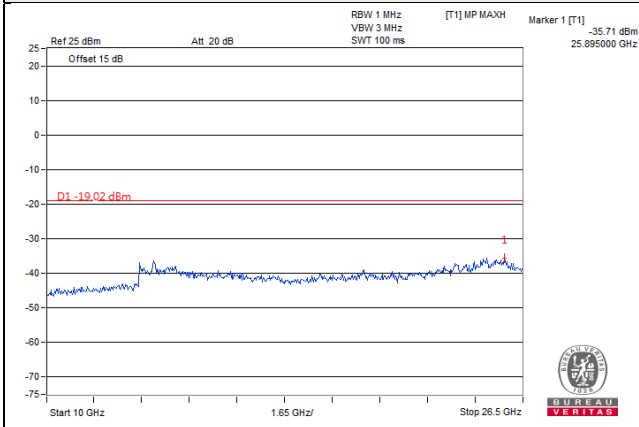

LTE Band 5, Channel Bandwidth 5MHz

Channel 2525 (881.5MHz)

Frequency Range : 9kHz~1GHz

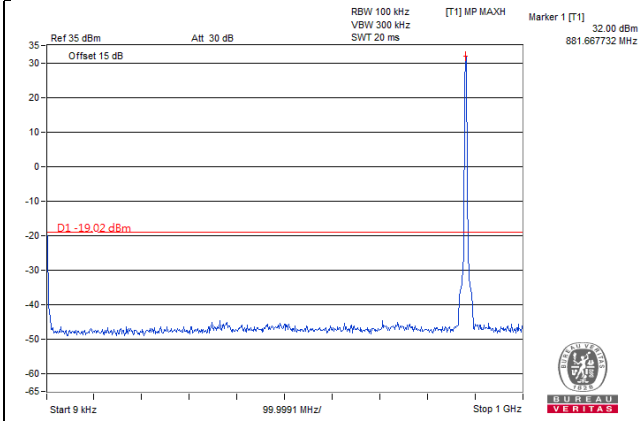

Frequency Range : 1GHz~10GHz

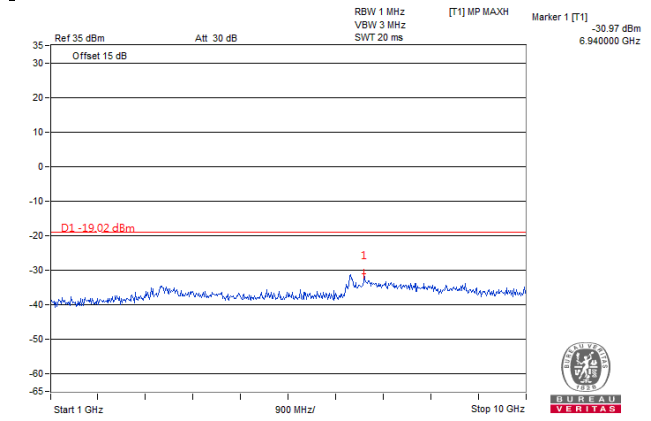

Frequency Range : 10GHz~26.5GHz

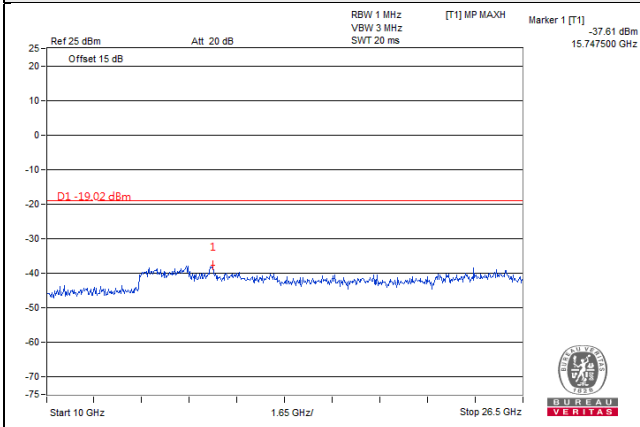

LTE Band 5, Channel Bandwidth 5MHz

Channel 2625 (891.5MHz)

Frequency Range : 9kHz~1GHz

Frequency Range : 1GHz~10GHz

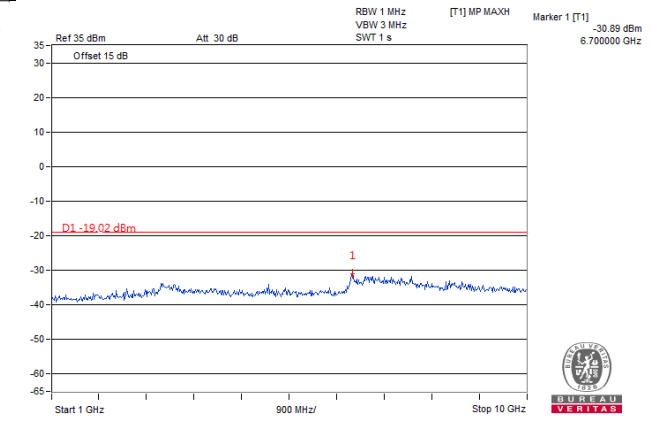
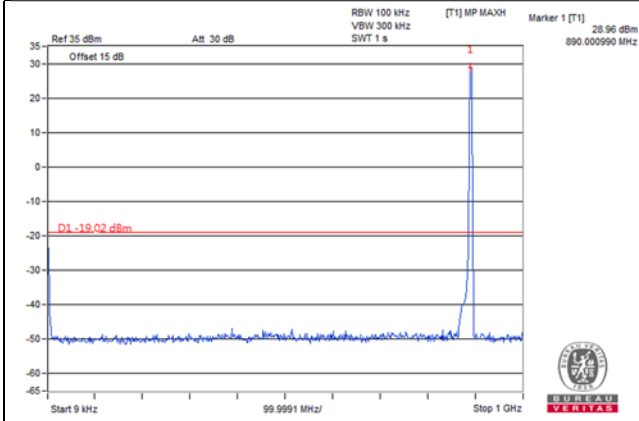

Frequency Range : 10GHz~26.5GHz

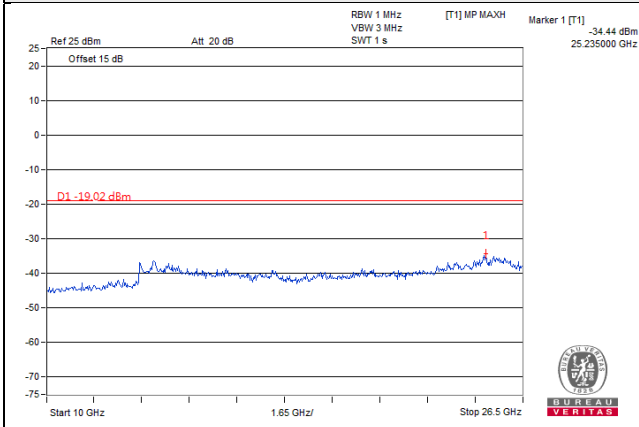



LTE Band 5, Channel Bandwidth 10MHz

Channel 2450 (874.0MHz)

Frequency Range : 9kHz~1GHz

Frequency Range : 1GHz~10GHz

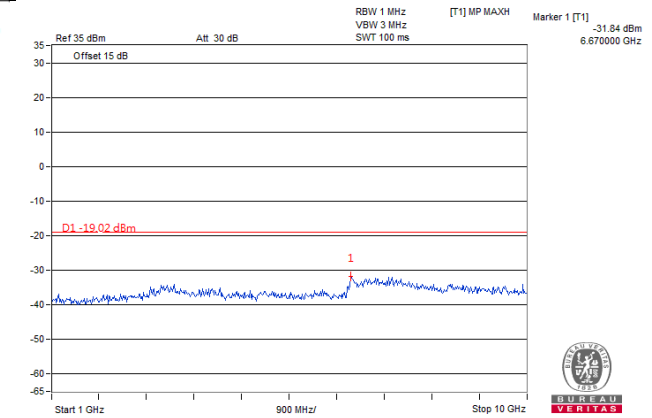
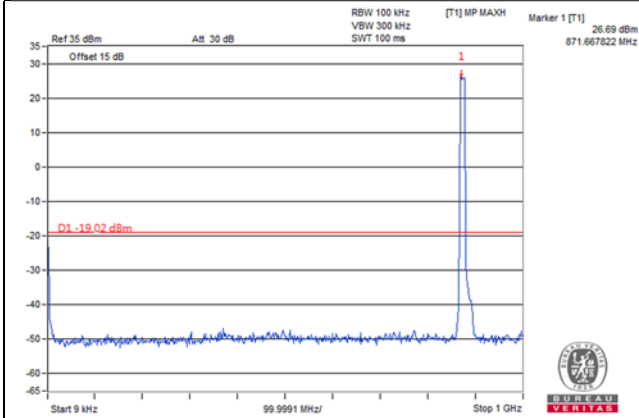

Frequency Range : 10GHz~26.5GHz

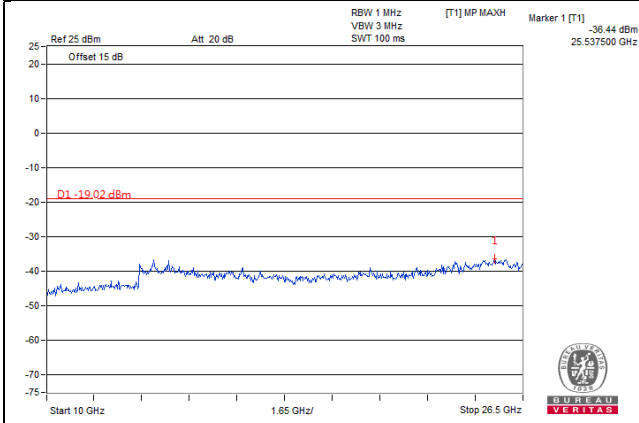

LTE Band 5, Channel Bandwidth 10MHz

Channel 2525 (881.5MHz)

Frequency Range : 9kHz~1GHz

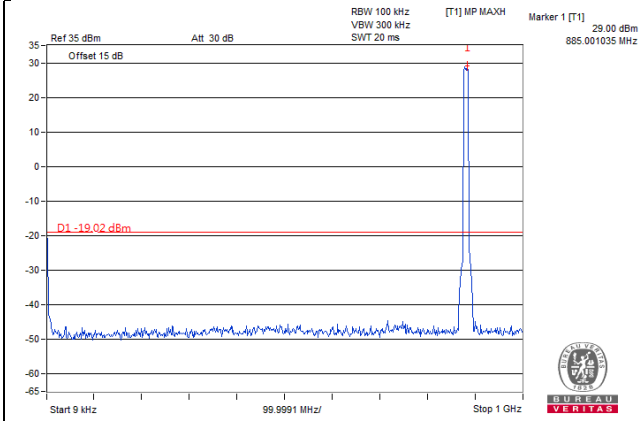

Frequency Range : 1GHz~10GHz

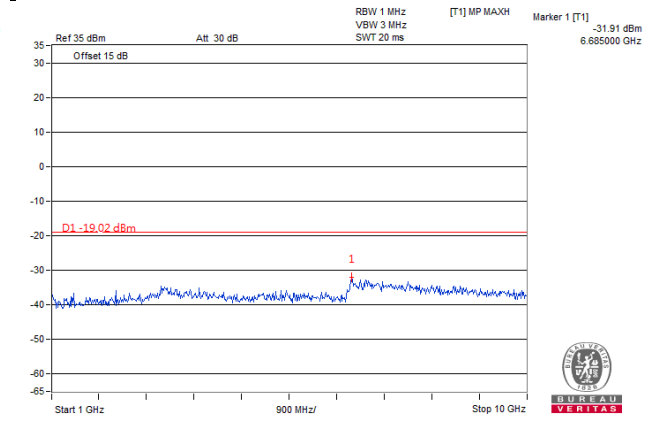

Frequency Range : 10GHz~26.5GHz

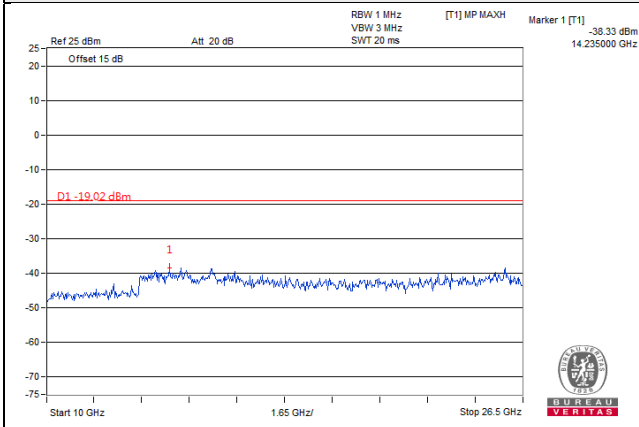

LTE Band 5, Channel Bandwidth 10MHz

Channel 2600 (889.0MHz)

Frequency Range : 9kHz~1GHz

Frequency Range : 1GHz~10GHz

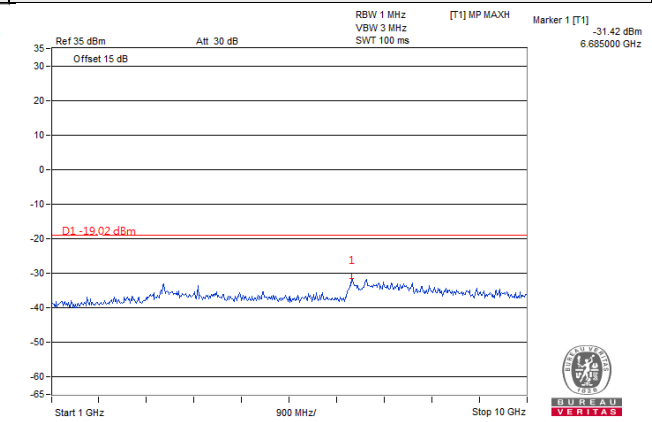
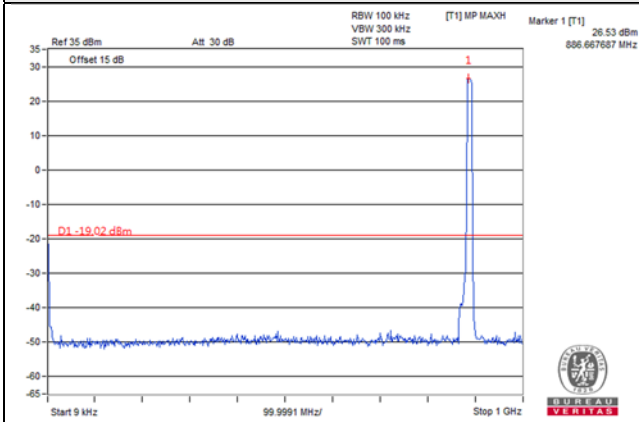

Frequency Range : 10GHz~26.5GHz

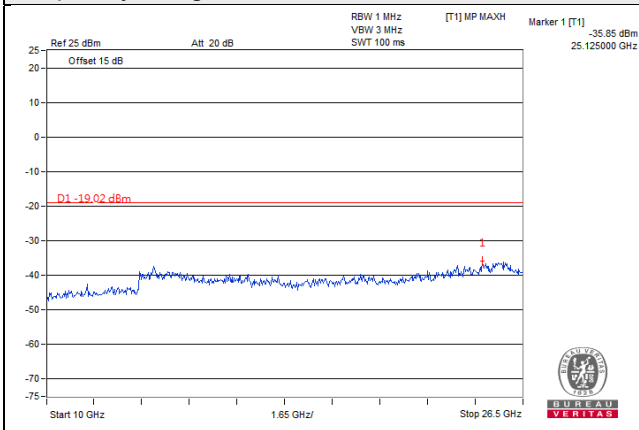

Single Mode (Chain 3)

LTE Band 5, Channel Bandwidth 1.4MHz

Channel 2407 (869.7MHz)

Frequency Range : 9kHz~1GHz      Frequency Range : 1GHz~10GHz

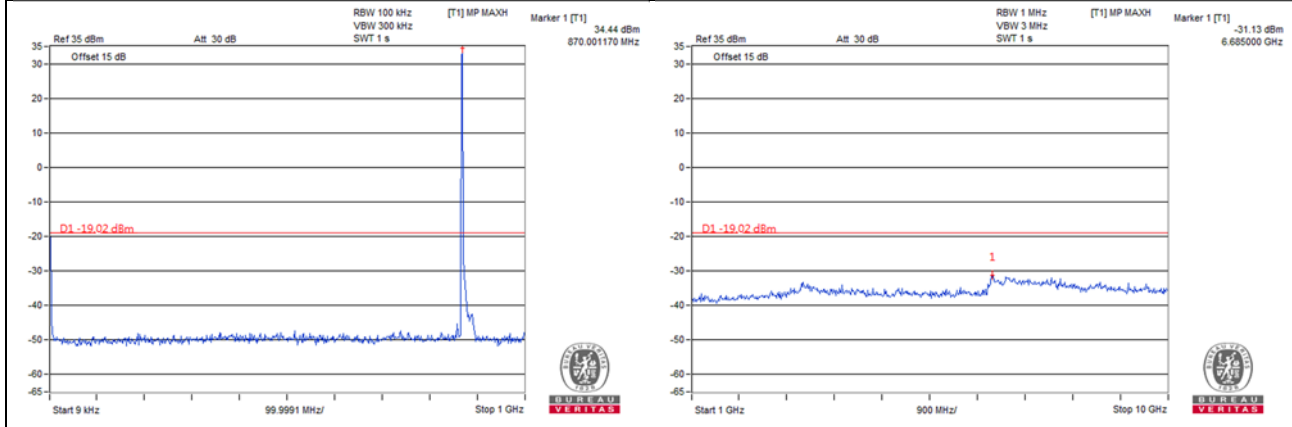

Frequency Range : 10GHz~26.5GHz

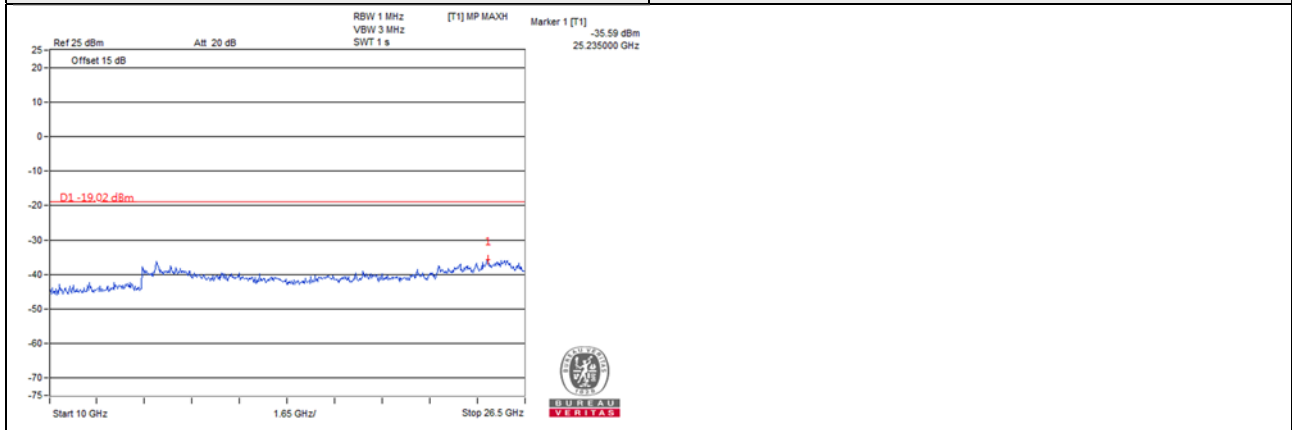

LTE Band 5, Channel Bandwidth 1.4MHz

Channel 2525 (881.5MHz)

Frequency Range : 9kHz~1GHz

Frequency Range : 1GHz~10GHz

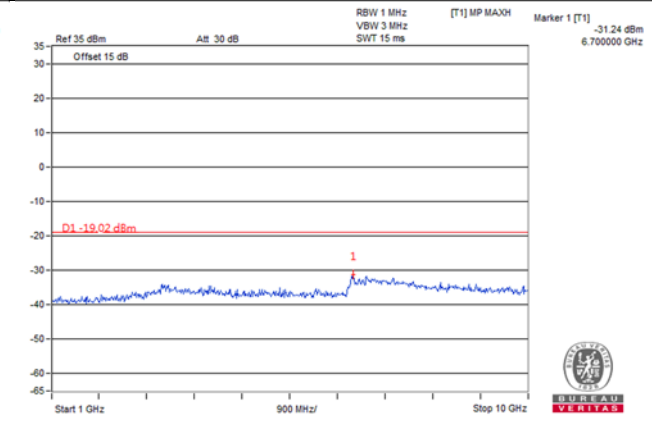
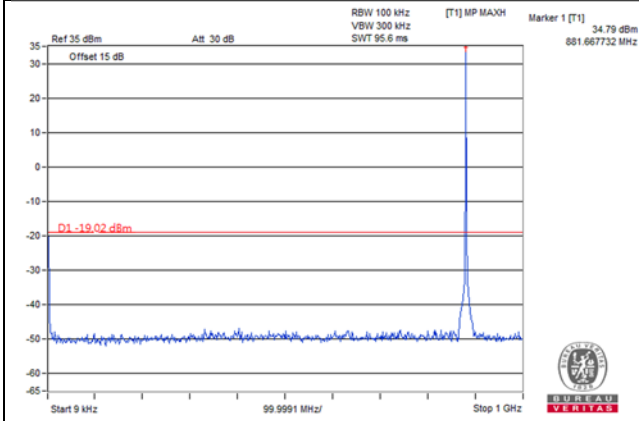

Frequency Range : 10GHz~26.5GHz

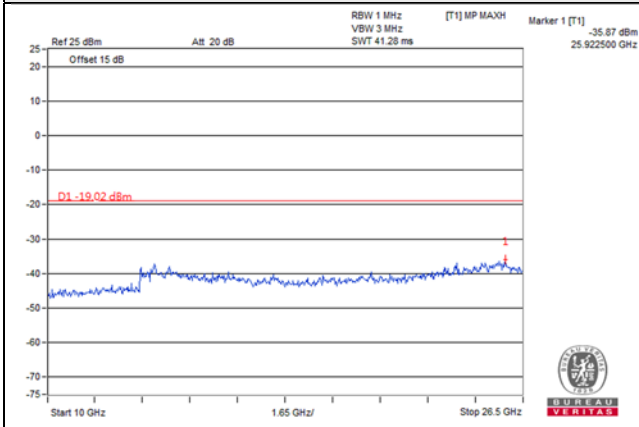

LTE Band 5, Channel Bandwidth 1.4MHz

Channel 2643 (893.3MHz)

Frequency Range : 9kHz~1GHz

Frequency Range : 1GHz~10GHz

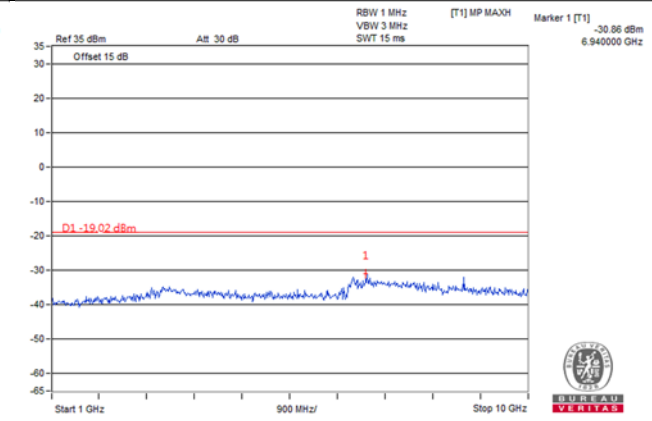
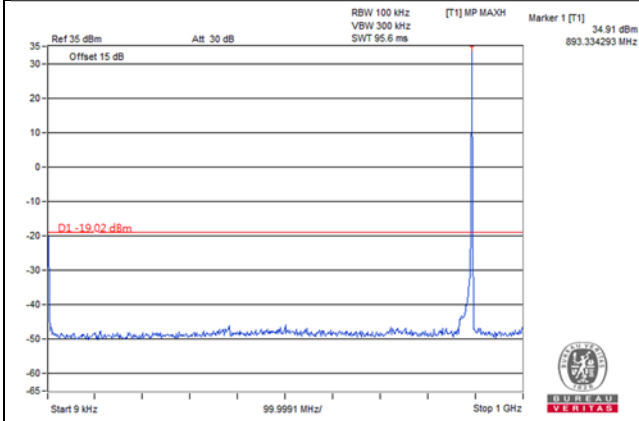

Frequency Range : 10GHz~26.5GHz

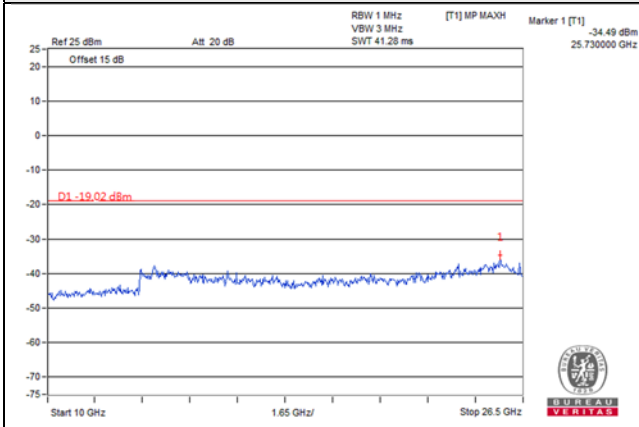

LTE Band 5, Channel Bandwidth 3MHz

Channel 2415 (870.5MHz)

Frequency Range : 9kHz~1GHz

Frequency Range : 1GHz~10GHz

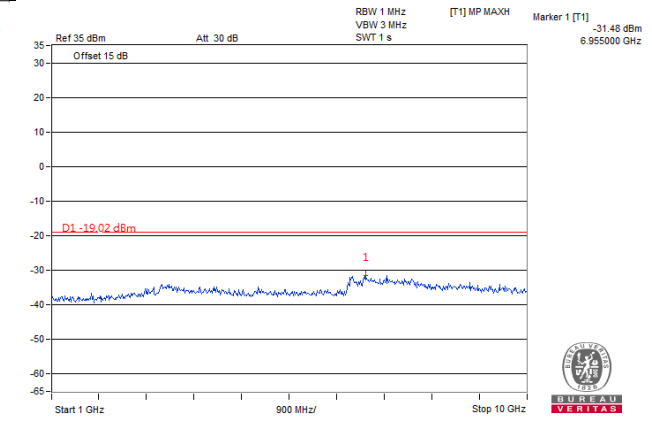
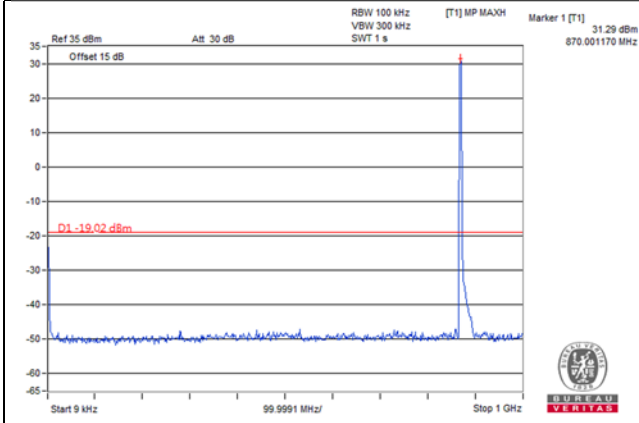

Frequency Range : 10GHz~26.5GHz

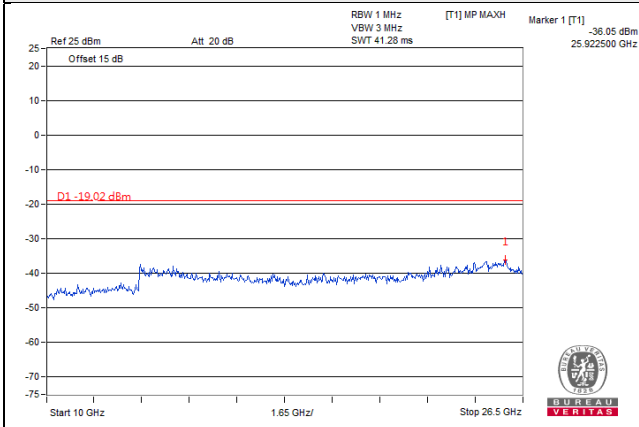

LTE Band 5, Channel Bandwidth 3MHz

Channel 2525 (881.5MHz)

Frequency Range : 9kHz~1GHz

Frequency Range : 1GHz~10GHz

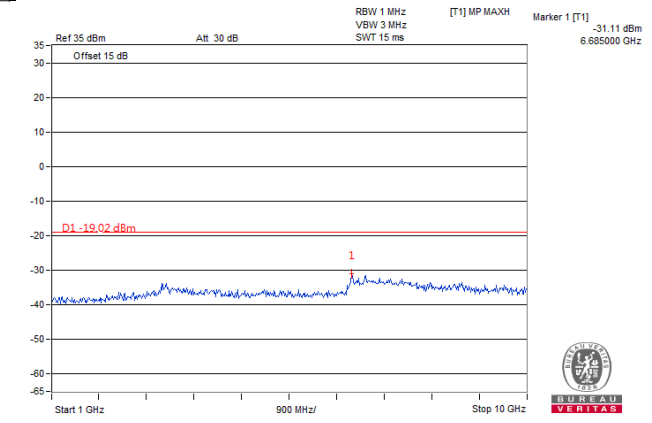
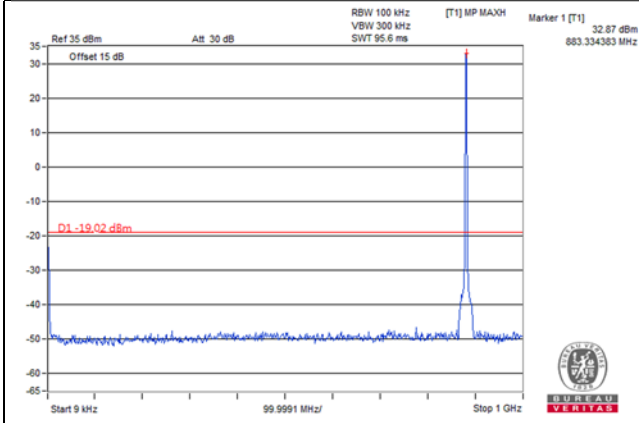

Frequency Range : 10GHz~26.5GHz

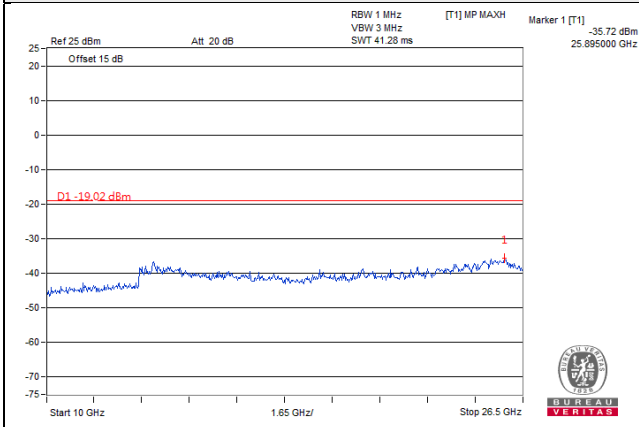



LTE Band 5, Channel Bandwidth 3MHz

Channel 2635 (892.5MHz)

Frequency Range : 9kHz~1GHz

Frequency Range : 1GHz~10GHz

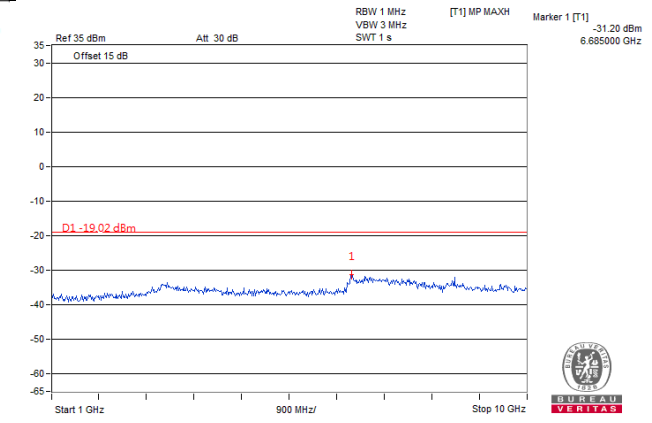
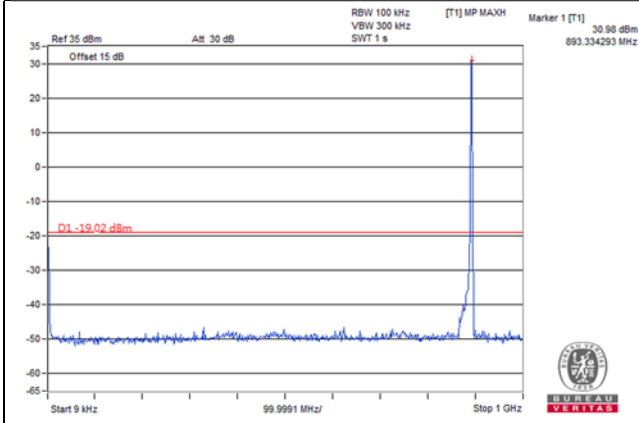

Frequency Range : 10GHz~26.5GHz

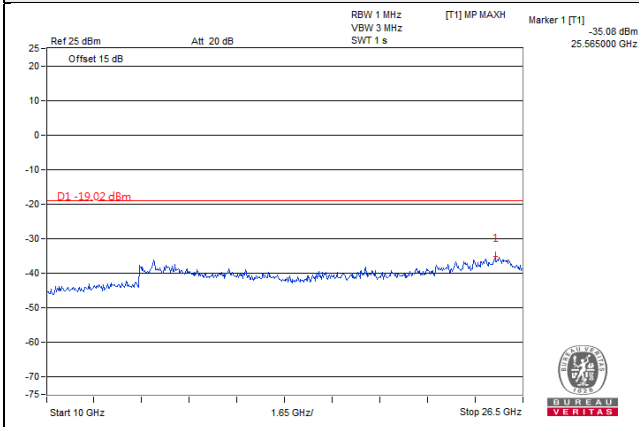

LTE Band 5, Channel Bandwidth 5MHz

Channel 2425 (871.5MHz)

Frequency Range : 9kHz~1GHz

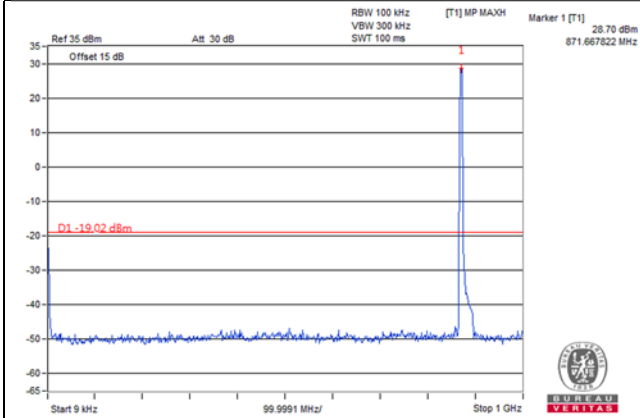

Frequency Range : 1GHz~10GHz

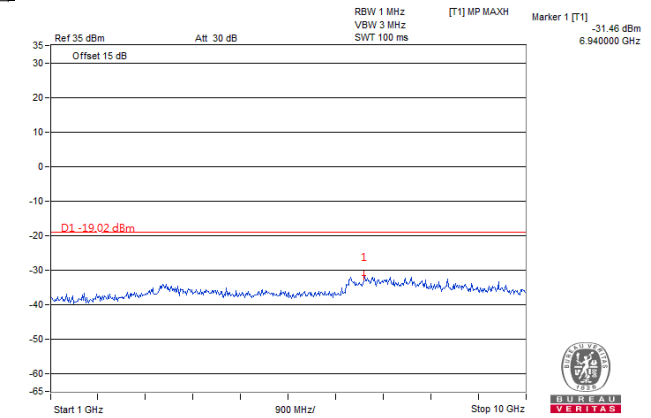

Frequency Range : 10GHz~26.5GHz

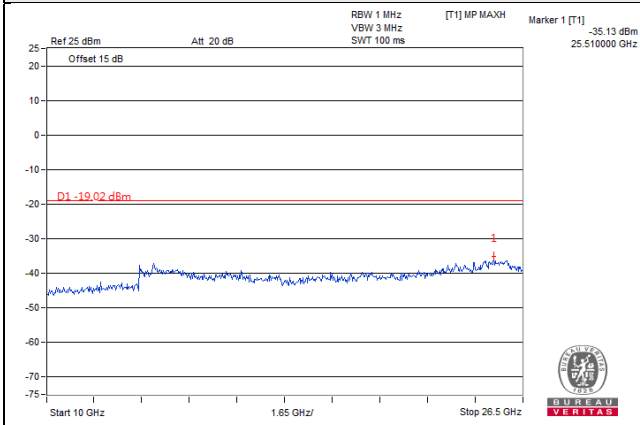

LTE Band 5, Channel Bandwidth 5MHz

Channel 2525 (881.5MHz)

Frequency Range : 9kHz~1GHz

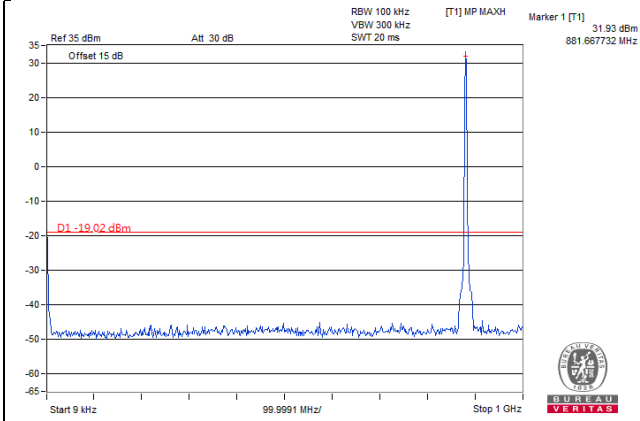

Frequency Range : 1GHz~10GHz

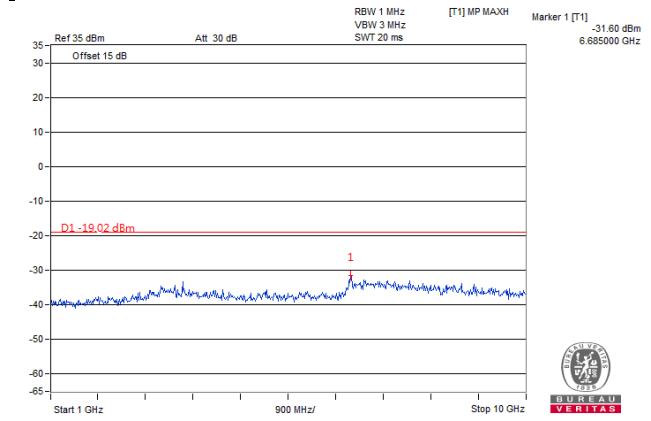

Frequency Range : 10GHz~26.5GHz

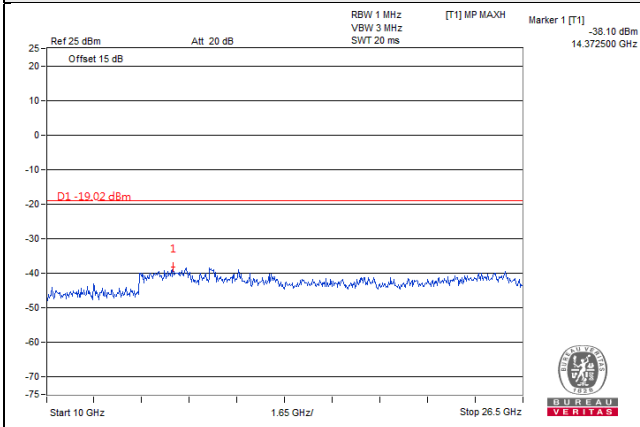

LTE Band 5, Channel Bandwidth 5MHz

Channel 2625 (891.5MHz)

Frequency Range : 9kHz~1GHz

Frequency Range : 1GHz~10GHz

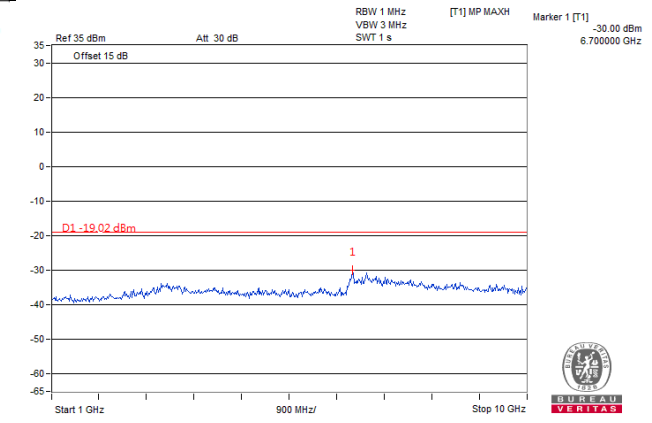
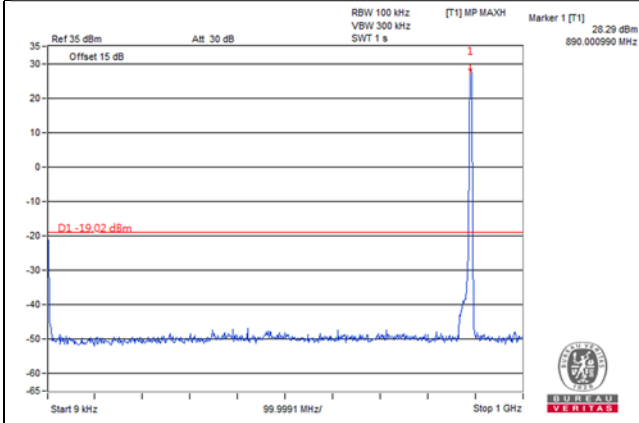

Frequency Range : 10GHz~26.5GHz

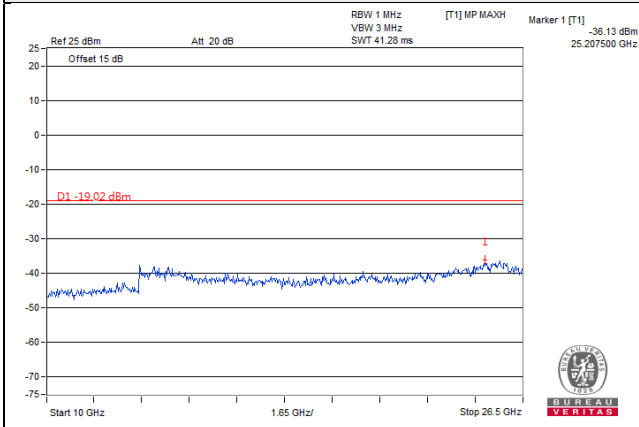

LTE Band 5, Channel Bandwidth 10MHz

Channel 2450 (874.0MHz)

Frequency Range : 9kHz~1GHz

Frequency Range : 1GHz~10GHz

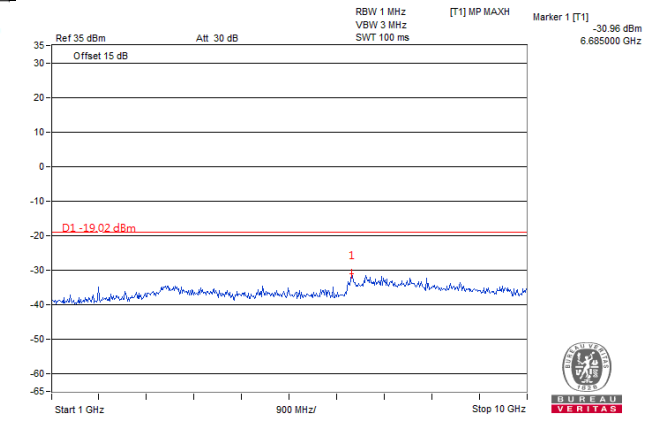
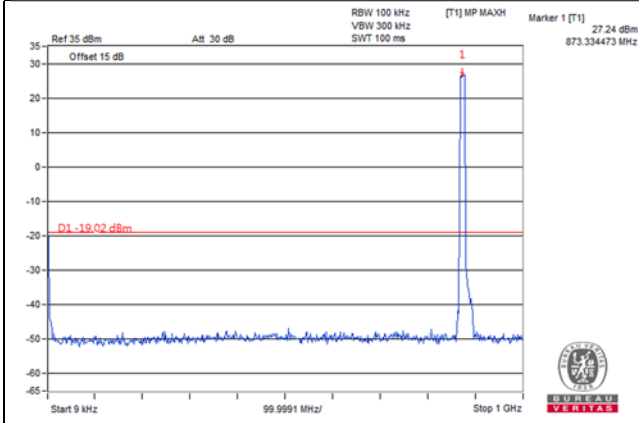

Frequency Range : 10GHz~26.5GHz

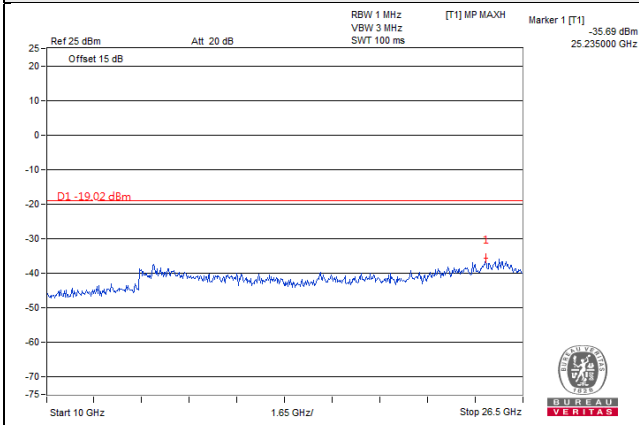

LTE Band 5, Channel Bandwidth 10MHz

Channel 2525 (881.5MHz)

Frequency Range : 9kHz~1GHz

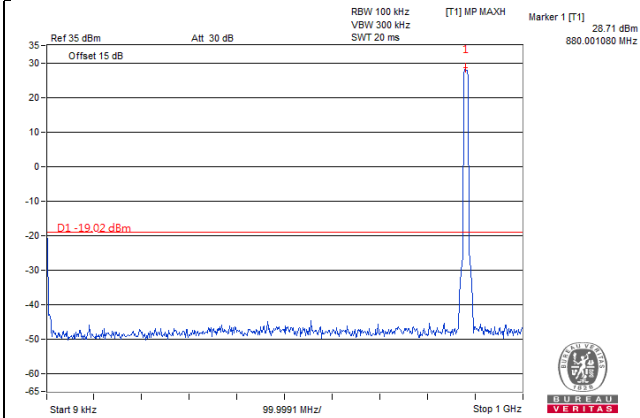

Frequency Range : 1GHz~10GHz

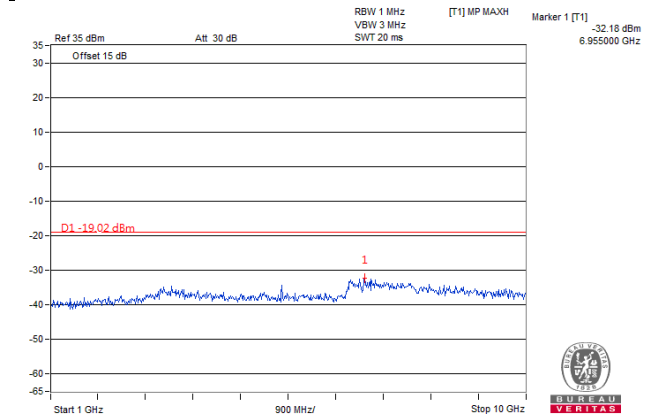

Frequency Range : 10GHz~26.5GHz

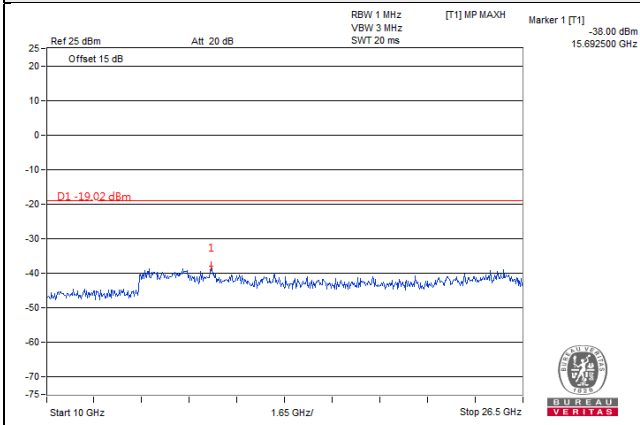

LTE Band 5, Channel Bandwidth 10MHz

Channel 2600 (889.0MHz)

Frequency Range : 9kHz~1GHz

Frequency Range : 1GHz~10GHz

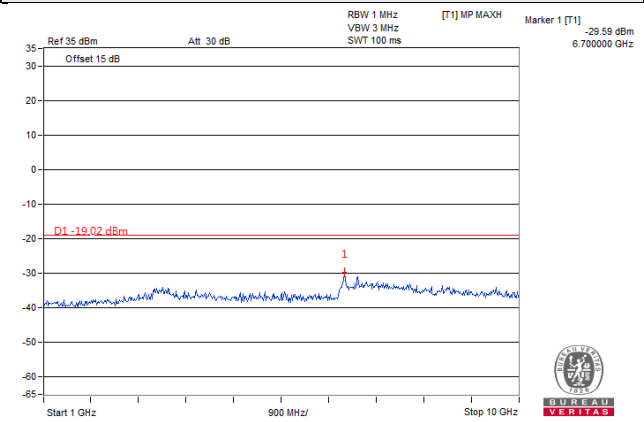
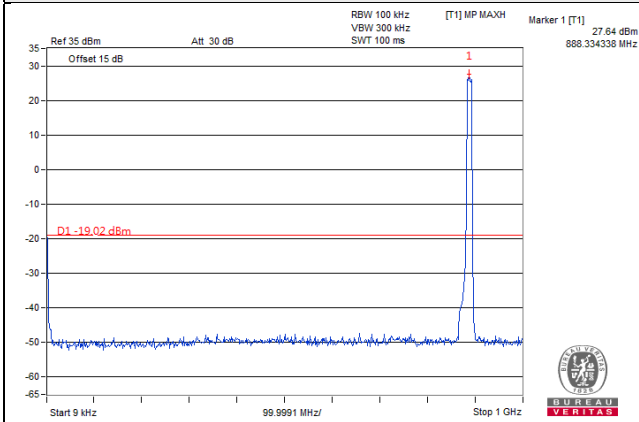

Frequency Range : 10GHz~26.5GHz

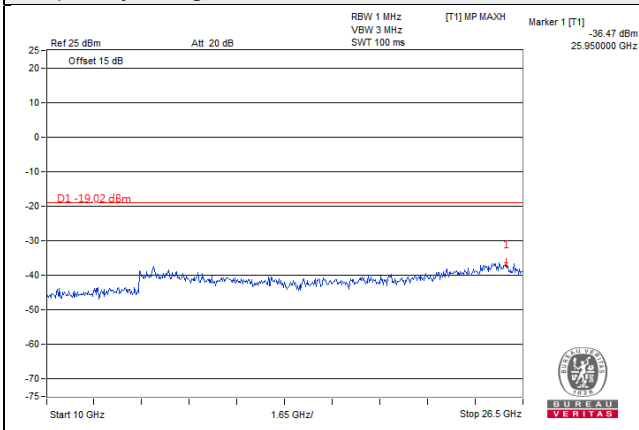

multi-carrier (Chain 0)

Channel Band width: 10MHz + 10MHz + 5MHz

Channel 2525 (881.5MHz)

Frequency Range : 9kHz~1GHz

Frequency Range : 1GHz~10GHz

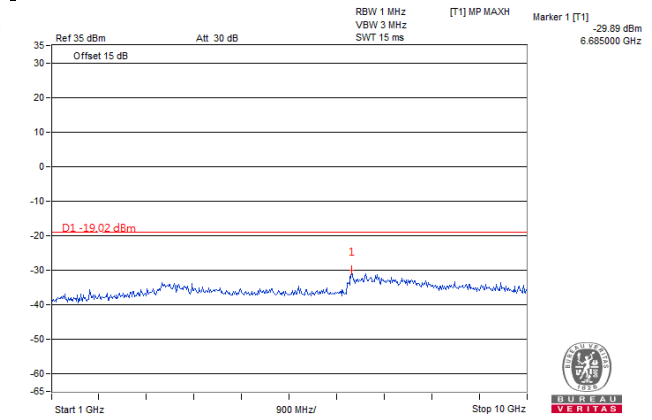
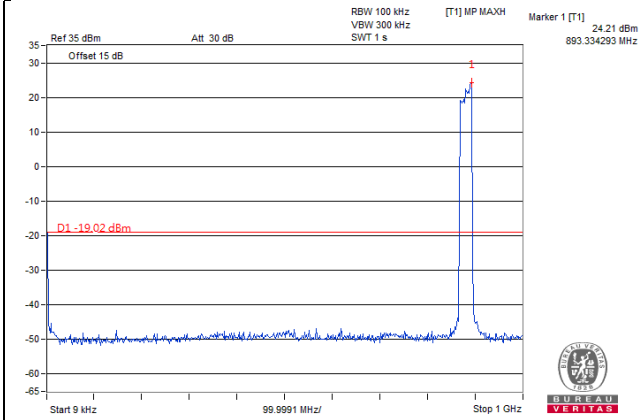

Frequency Range : 10GHz~26.5GHz

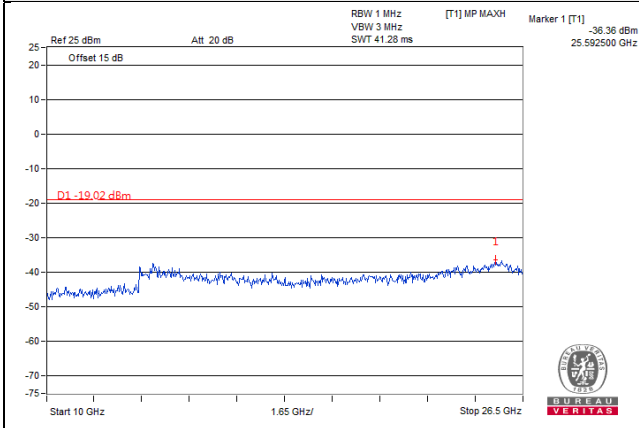



multi-carrier (Chain 1)

Channel Band width: 10MHz + 10MHz + 5MHz

Channel 2525 (881.5MHz)

Frequency Range : 9kHz~1GHz      Frequency Range : 1GHz~10GHz

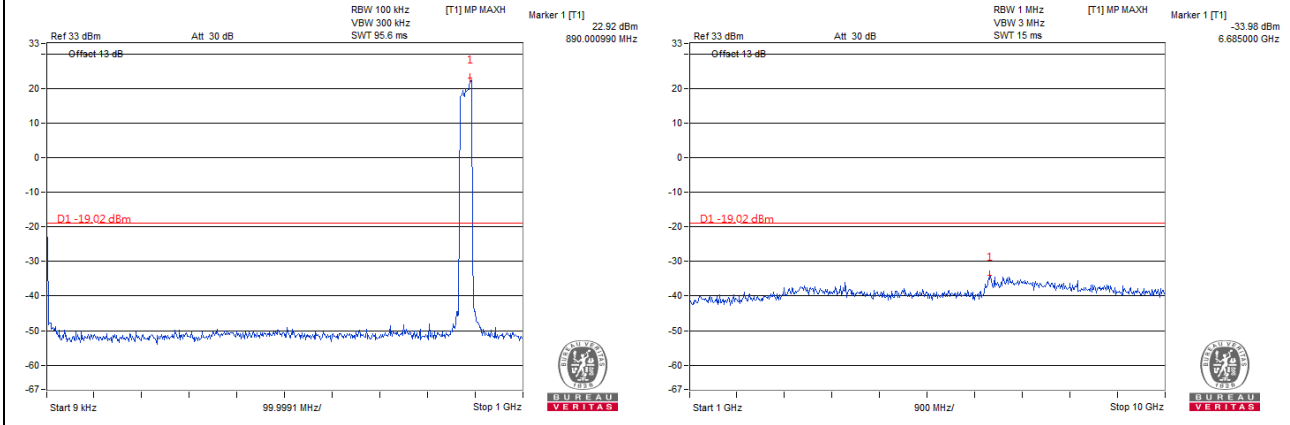

Frequency Range : 10GHz~26.5GHz

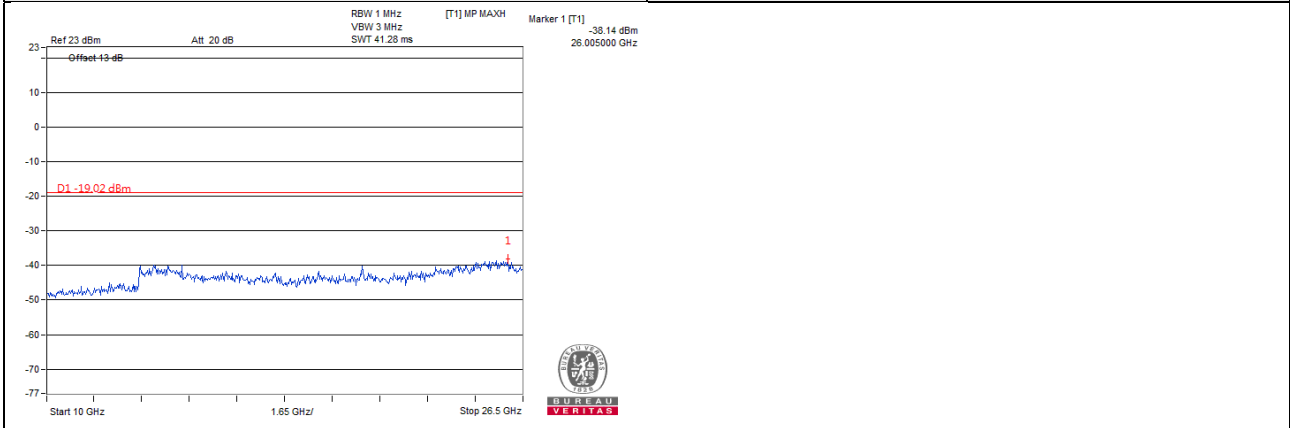

multi-carrier (Chain 2)

Channel Band width: 10MHz + 10MHz + 5MHz

Channel 2525 (881.5MHz)

Frequency Range : 9kHz~1GHz

Frequency Range : 1GHz~10GHz

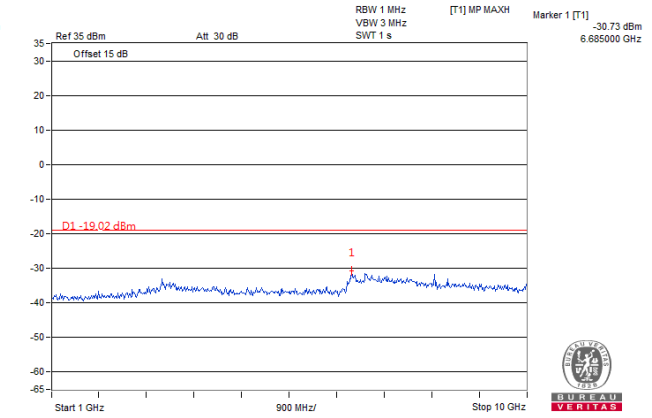
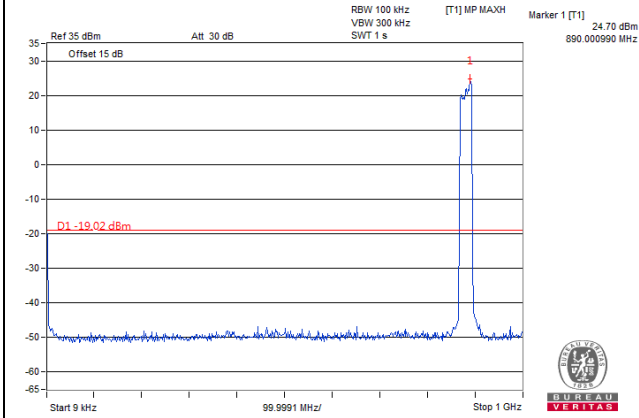

Frequency Range : 10GHz~26.5GHz

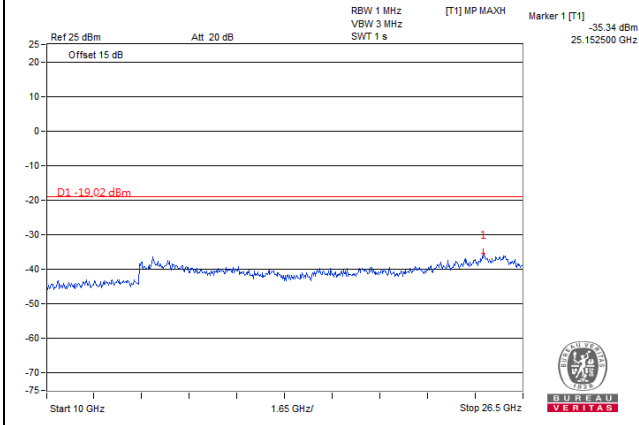

multi-carrier (Chain 3)

Channel Band width: 10MHz + 10MHz + 5MHz

Channel 2525 (881.5MHz)

Frequency Range : 9kHz~1GHz

Frequency Range : 1GHz~10GHz

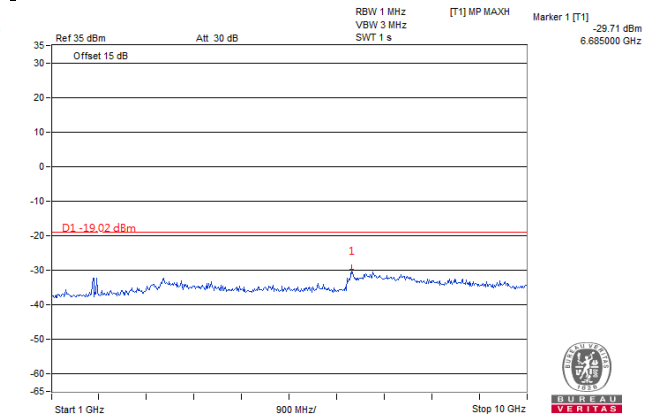
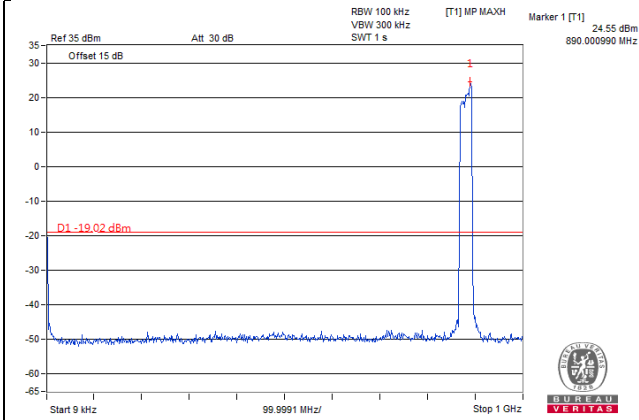

Frequency Range : 10GHz~26.5GHz

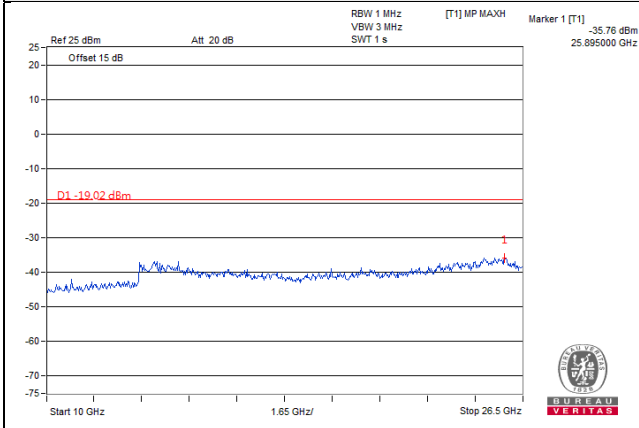

## 4.8 Radiated Emission Measurement

### 4.8.1 Limits of Radiated Emission Measurement

The power of any emission outside of the authorized operating frequency ranges must be attenuated below the transmitting power (P) by a factor of at least  $43 + 10 \log(P)$  dB.

### 4.8.2 Test Procedure

- a. Substitution method is used for E.I.R.P measurement. In the semi-anechoic chamber, EUT placed on the 0.8m height of Turn Table, rotated the table around 360 degrees to search the maximum radiation power and receiver antenna shall be rotated vertical and horizontal polarization and moved height from 1m to 4m to find the maximum polar radiated power. The "Read Value" is the spectrum reading the maximum power value.
- b. The substitution horn antenna is substituted for EUT at the same position and signals generator export the CW signal to the substitution antenna via a TX cable. Rotated the Turn Table and moved receiving antenna to find the maximum radiation power. Adjust output power level of S.G to get a Value of spectrum reading equal to "Read Value" of step a. Record the power level of S.G
- c.  $EIRP = \text{Output power level of S.G} - \text{TX cable loss} + \text{Antenna gain of substitution horn}$ .
- d. E.R.P power can be calculated form E.I.R.P power by subtracting the gain of dipole,  $E.R.P \text{ power} = E.I.R.P \text{ power} - 2.15\text{dBi}$ .

NOTE: The resolution bandwidth and video bandwidth of test receiver/spectrum analyzer is 1MHz/3MHz.

### 4.8.3 Deviation from Test Standard

No deviation.

#### 4.8.4 Test Setup

##### For Radiated Emission below or equal 1GHz

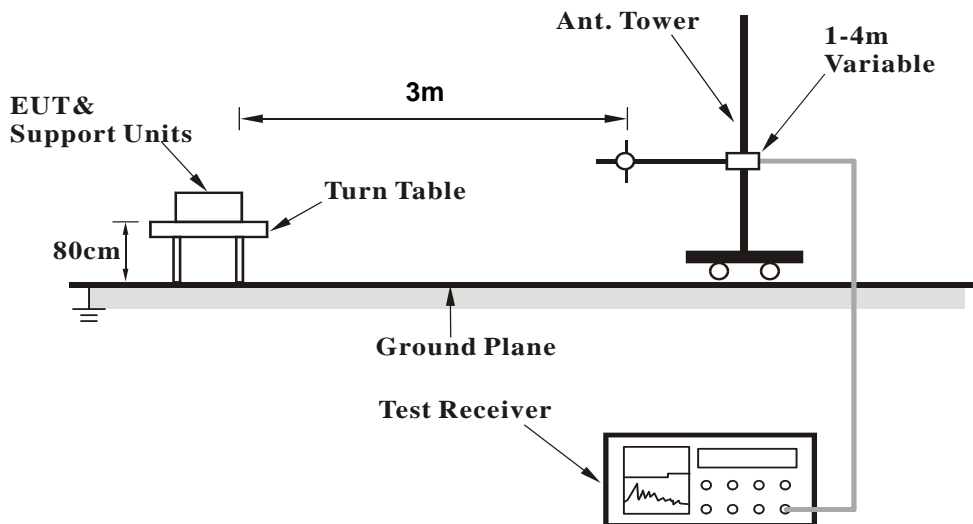

##### For Radiated Emission above 1GHz

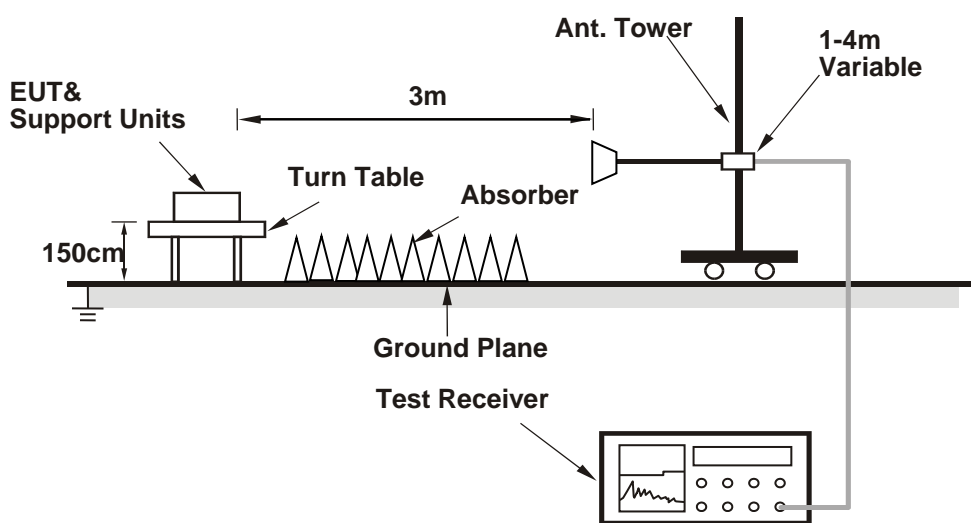

For the actual test configuration, please refer to the attached file (Test Setup Photo).

#### 4.8.5 Test Results

##### Single Mode

Below 1GHz

Channel Bandwidth: 1.4MHz

Mode	TX channel 2525 (881.5MHz)	Frequency Range	Below 1000 MHz
Environmental Conditions	25deg. C, 65%RH	Input Power	120Vac, 60Hz
Tested By	Greg Lin		

Antenna Polarity & Test Distance: Horizontal at 3 M							
No.	Freq. (MHz)	Reading (dBm)	S.G Power Value (dBm)	Correction Factor (dB)	ERP (dBm)	Limit (dBm)	Margin (dB)
1	31.94	-45.2	-25.7	-18.3	-44.0	-13.0	-31.0
2	55.22	-41.8	-41.1	-5.4	-46.5	-13.0	-33.5
3	96.93	-32.2	-42.1	-1.2	-43.3	-13.0	-30.3
4	154.16	-32.8	-36.3	-2.9	-39.2	-13.0	-26.2
5	355.92	-53.8	-62.9	4.0	-58.9	-13.0	-45.9
6	591.63	-55.8	-60.5	3.8	-56.7	-13.0	-43.7

Remarks: ERP (dBm)= S.G Value (dBm) + Correction Factor (dB).

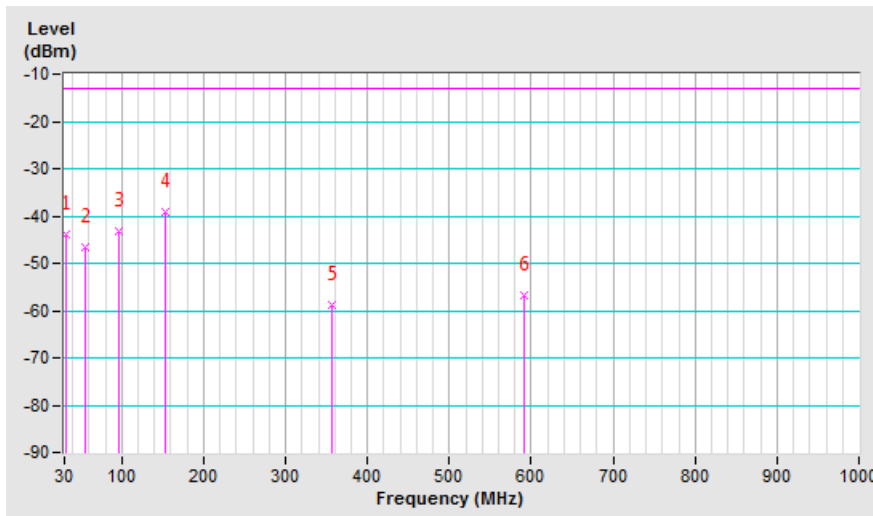

Mode	TX channel 2525 (881.5MHz)	Frequency Range	Below 1000 MHz
Environmental Conditions	25deg. C, 65%RH	Input Power	120Vac, 60Hz
Tested By	Greg Lin		

Antenna Polarity & Test Distance: Vertical at 3 M							
No.	Freq. (MHz)	Reading (dBm)	S.G Power Value (dBm)	Correction Factor (dB)	ERP (dBm)	Limit (dBm)	Margin (dB)
1	56.19	-30.3	-34.3	-5.1	-39.4	-13.0	-26.4
2	96.93	-28.1	-37.1	-1.2	-38.3	-13.0	-25.3
3	155.13	-36.5	-38.2	-2.9	-41.1	-13.0	-28.1
4	353.98	-52.8	-59.2	3.9	-55.3	-13.0	-42.3
5	421.88	-51.7	-57.6	3.4	-54.2	-13.0	-41.2
6	547.98	-54.2	-58.5	3.8	-54.7	-13.0	-41.7

Remarks: ERP (dBm)= S.G Value (dBm) + Correction Factor (dB).

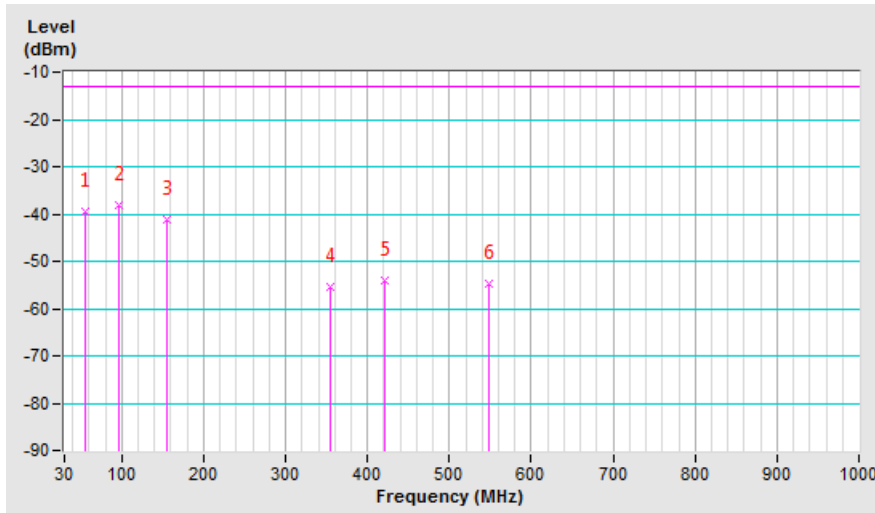

Channel Bandwidth: 3MHz

Mode	TX channel 2525 (881.5MHz)	Frequency Range	Below 1000 MHz
Environmental Conditions	25deg. C, 65%RH	Input Power	120Vac, 60Hz
Tested By	Greg Lin		

Antenna Polarity & Test Distance: Horizontal at 3 M							
No.	Freq. (MHz)	Reading (dBm)	S.G Power Value (dBm)	Correction Factor (dB)	ERP (dBm)	Limit (dBm)	Margin (dB)
1	30.97	-42.3	-22.0	-18.8	-40.8	-13.0	-27.8
2	95.96	-31.9	-41.9	-1.2	-43.1	-13.0	-30.1
3	155.13	-32.1	-35.8	-2.9	-38.7	-13.0	-25.7
4	351.07	-53.5	-62.9	3.9	-59.0	-13.0	-46.0
5	584.84	-60.4	-65.2	3.8	-61.4	-13.0	-48.4
6	833.16	-60.8	-59.9	3.8	-56.1	-13.0	-43.1

Remarks: ERP (dBm)= S.G Value (dBm) + Correction Factor (dB).

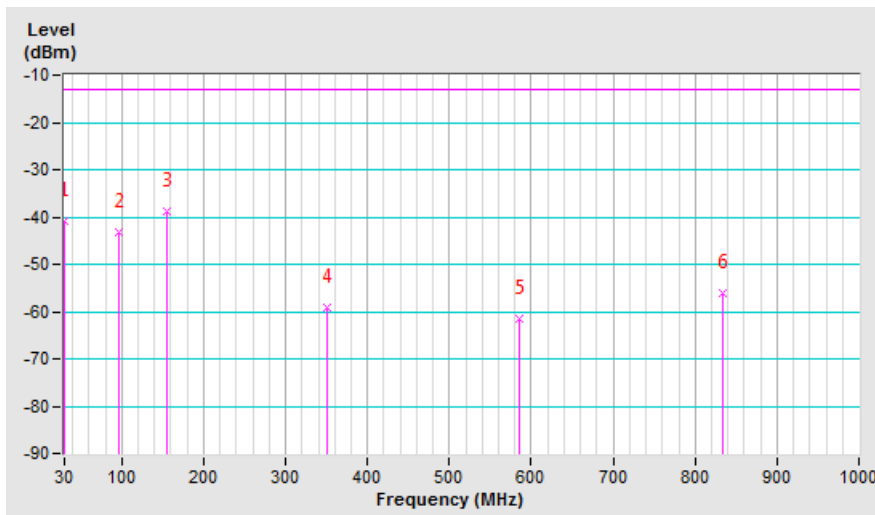



Mode	TX channel 2525 (881.5MHz)	Frequency Range	Below 1000 MHz
Environmental Conditions	25deg. C, 65%RH	Input Power	120Vac, 60Hz
Tested By	Greg Lin		

Antenna Polarity & Test Distance: Vertical at 3 M							
No.	Freq. (MHz)	Reading (dBm)	S.G Power Value (dBm)	Correction Factor (dB)	ERP (dBm)	Limit (dBm)	Margin (dB)
1	55.22	-30.2	-33.9	-5.4	-39.3	-13.0	-26.3
2	96.93	-28.6	-37.6	-1.2	-38.8	-13.0	-25.8
3	155.13	-36.5	-38.2	-2.9	-41.1	-13.0	-28.1
4	354.95	-50.6	-57.0	3.9	-53.1	-13.0	-40.1
5	424.79	-55.4	-61.4	3.5	-57.9	-13.0	-44.9
6	544.10	-54.5	-59.0	3.8	-55.2	-13.0	-42.2

Remarks: ERP (dBm)= S.G Value (dBm) + Correction Factor (dB).

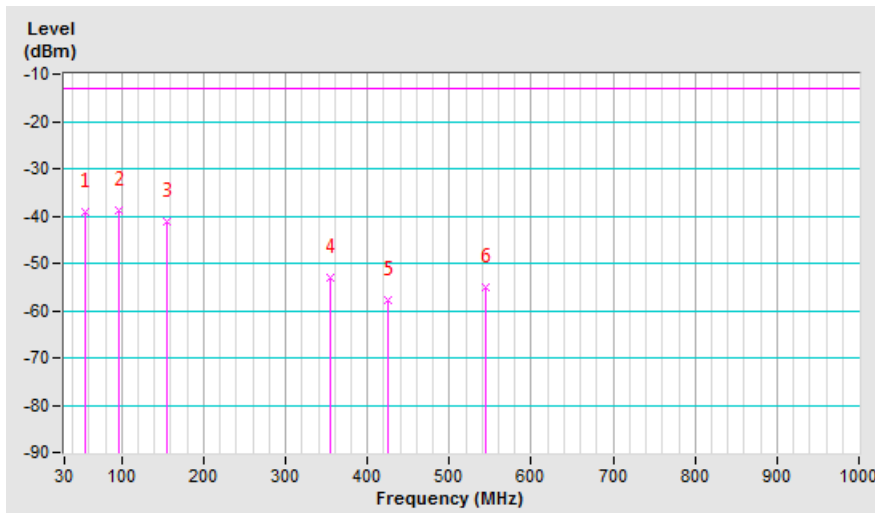

Channel Bandwidth: 5MHz

Mode	TX channel 2525 (881.5MHz)	Frequency Range	Below 1000 MHz
Environmental Conditions	25deg. C, 65%RH	Input Power	120Vac, 60Hz
Tested By	Greg Lin		

Antenna Polarity & Test Distance: Horizontal at 3 M							
No.	Freq. (MHz)	Reading (dBm)	S.G Power Value (dBm)	Correction Factor (dB)	ERP (dBm)	Limit (dBm)	Margin (dB)
1	30.00	-46.1	-24.9	-19.4	-44.3	-13.0	-31.3
2	54.25	-40.9	-39.3	-5.7	-45.0	-13.0	-32.0
3	97.90	-32.1	-41.6	-1.4	-43.0	-13.0	-30.0
4	154.16	-32.5	-36.1	-2.9	-39.0	-13.0	-26.0
5	352.04	-53.0	-62.3	3.9	-58.4	-13.0	-45.4
6	739.07	-60.8	-62.5	3.7	-58.8	-13.0	-45.8

Remarks: ERP (dBm)= S.G Value (dBm) + Correction Factor (dB).

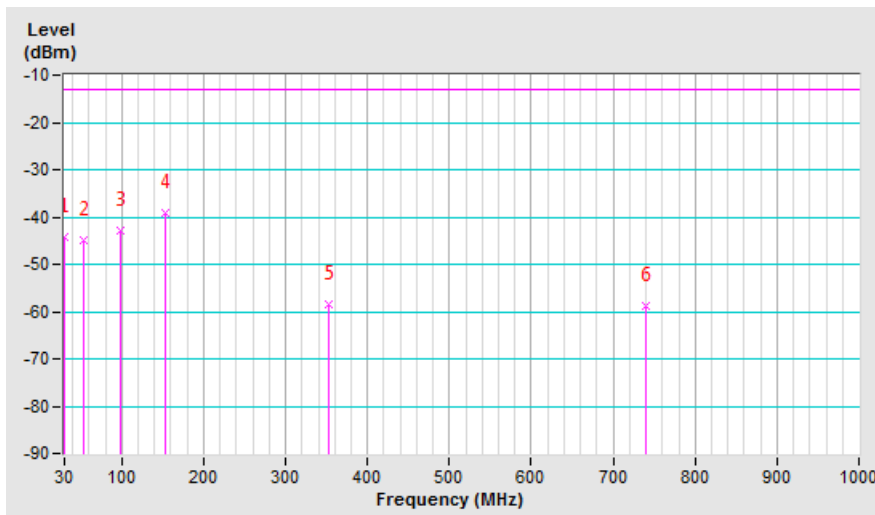

Mode	TX channel 2525 (881.5MHz)	Frequency Range	Below 1000 MHz
Environmental Conditions	25deg. C, 65%RH	Input Power	120Vac, 60Hz
Tested By	Greg Lin		

Antenna Polarity & Test Distance: Vertical at 3 M							
No.	Freq. (MHz)	Reading (dBm)	S.G Power Value (dBm)	Correction Factor (dB)	ERP (dBm)	Limit (dBm)	Margin (dB)
1	62.01	-30.1	-36.0	-3.0	-39.0	-13.0	-26.0
2	97.90	-27.8	-36.6	-1.4	-38.0	-13.0	-25.0
3	154.16	-35.8	-37.4	-2.9	-40.3	-13.0	-27.3
4	353.98	-51.7	-58.1	3.9	-54.2	-13.0	-41.2
5	426.73	-53.9	-59.9	3.5	-56.4	-13.0	-43.4
6	540.22	-52.8	-57.6	3.8	-53.8	-13.0	-40.8

Remarks: ERP (dBm)= S.G Value (dBm) + Correction Factor (dB).

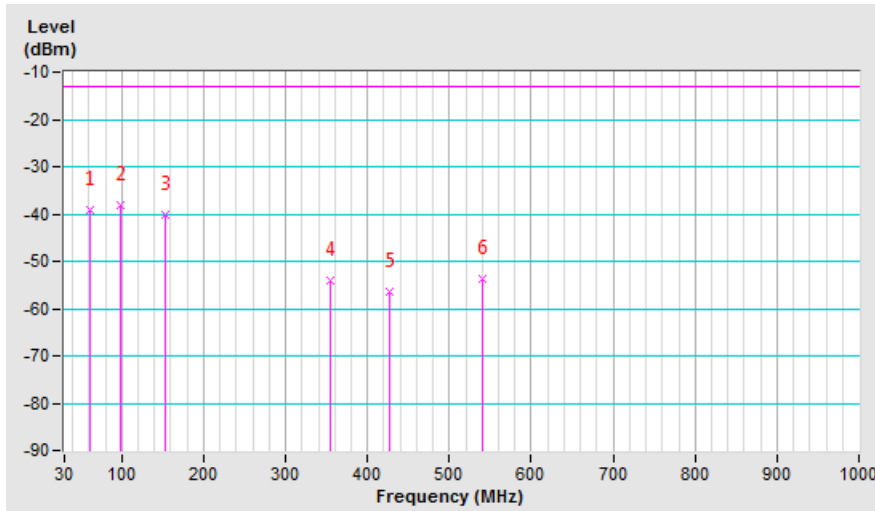

Channel Bandwidth: 10MHz

Mode	TX channel 2525 (881.5MHz)	Frequency Range	Below 1000 MHz
Environmental Conditions	25deg. C, 65%RH	Input Power	120Vac, 60Hz
Tested By	Greg Lin		

Antenna Polarity & Test Distance: Horizontal at 3 M							
No.	Freq. (MHz)	Reading (dBm)	S.G Power Value (dBm)	Correction Factor (dB)	ERP (dBm)	Limit (dBm)	Margin (dB)
1	30.97	-41.5	-21.2	-18.8	-40.0	-13.0	-27.0
2	96.93	-32.2	-42.0	-1.2	-43.2	-13.0	-30.2
3	156.10	-32.1	-36.1	-2.9	-39.0	-13.0	-26.0
4	352.04	-52.9	-62.2	3.9	-58.3	-13.0	-45.3
5	560.59	-59.7	-64.9	3.7	-61.2	-13.0	-48.2
6	797.27	-60.4	-60.8	3.9	-56.9	-13.0	-43.9

Remarks: ERP (dBm)= S.G Value (dBm) + Correction Factor (dB).

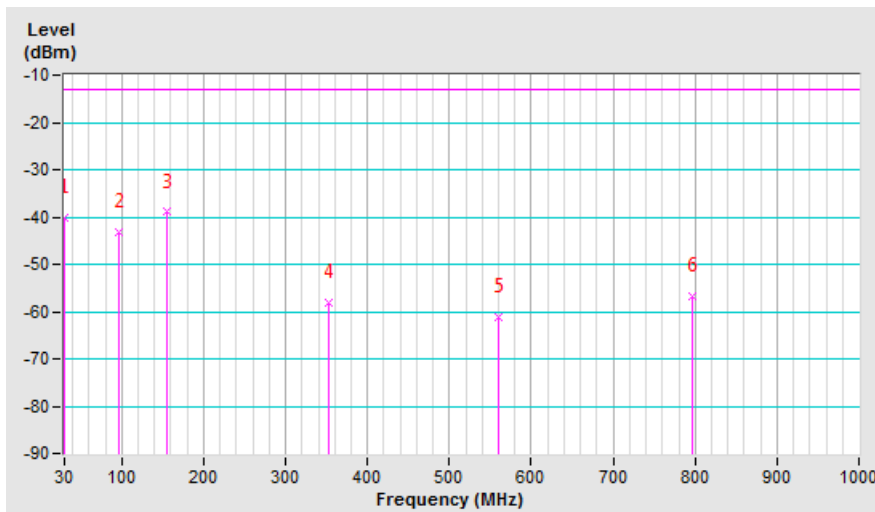

Mode	TX channel 2525 (881.5MHz)	Frequency Range	Below 1000 MHz
Environmental Conditions	25deg. C, 65%RH	Input Power	120Vac, 60Hz
Tested By	Greg Lin		

Antenna Polarity & Test Distance: Vertical at 3 M							
No.	Freq. (MHz)	Reading (dBm)	S.G Power Value (dBm)	Correction Factor (dB)	ERP (dBm)	Limit (dBm)	Margin (dB)
1	60.07	-28.8	-34.4	-3.4	-37.8	-13.0	-24.8
2	97.90	-27.6	-36.5	-1.4	-37.9	-13.0	-24.9
3	155.13	-35.6	-37.4	-2.9	-40.3	-13.0	-27.3
4	267.65	-54.1	-53.1	-1.6	-54.7	-13.0	-41.7
5	353.01	-52.0	-58.5	4.0	-54.5	-13.0	-41.5
6	544.10	-54.4	-58.9	3.8	-55.1	-13.0	-42.1

Remarks: ERP (dBm)= S.G Value (dBm) + Correction Factor (dB).

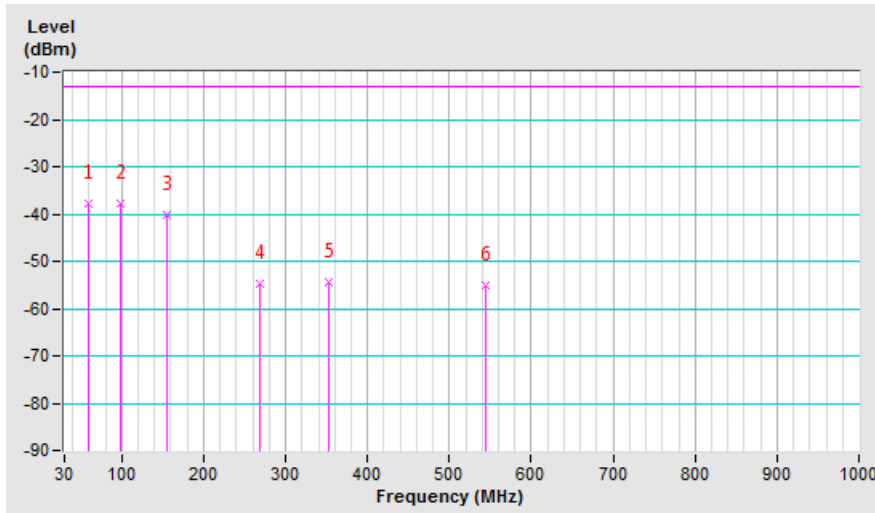

Above 1GHz

Channel Bandwidth: 1.4MHz

Mode	TX channel 2407 (869.7MHz)	Frequency Range	Above 1000MHz
Environmental Conditions	25deg. C, 65%RH	Input Power	120Vac, 60Hz
Tested By	Greg Lin		

Antenna Polarity & Test Distance: Horizontal at 3 M							
No.	Freq. (MHz)	Reading (dBm)	S.G Power Value (dBm)	Correction Factor (dB)	ERP (dBm)	Limit (dBm)	Margin (dB)
1	1739.40	-59.8	-52.9	0.5	-52.4	-13.0	-39.4
Antenna Polarity & Test Distance: Vertical at 3 M							
No.	Freq. (MHz)	Reading (dBm)	S.G Power Value (dBm)	Correction Factor (dB)	ERP (dBm)	Limit (dBm)	Margin (dB)
1	1739.40	-61.8	-55.3	0.5	-54.8	-13.0	-41.8

Remarks: ERP (dBm)= S.G Value (dBm) + Correction Factor (dB).

Mode	TX channel 2525 (881.5MHz)	Frequency Range	Above 1000MHz
Environmental Conditions	25deg. C, 65%RH	Input Power	120Vac, 60Hz
Tested By	Greg Lin		

Antenna Polarity & Test Distance: Horizontal at 3 M							
No.	Freq. (MHz)	Reading (dBm)	S.G Power Value (dBm)	Correction Factor (dB)	ERP (dBm)	Limit (dBm)	Margin (dB)
1	1763.00	-60.3	-53.9	0.5	-53.4	-13.0	-40.4
Antenna Polarity & Test Distance: Vertical at 3 M							
No.	Freq. (MHz)	Reading (dBm)	S.G Power Value (dBm)	Correction Factor (dB)	ERP (dBm)	Limit (dBm)	Margin (dB)
1	1763.00	-61.8	-55.9	0.5	-55.4	-13.0	-42.4

Remarks: ERP (dBm)= S.G Value (dBm) + Correction Factor (dB).

Mode	TX channel 2643 (893.3MHz)	Frequency Range	Above 1000MHz
Environmental Conditions	25deg. C, 65%RH	Input Power	120Vac, 60Hz
Tested By	Greg Lin		

Antenna Polarity & Test Distance: Horizontal at 3 M							
No.	Freq. (MHz)	Reading (dBm)	S.G Power Value (dBm)	Correction Factor (dB)	ERP (dBm)	Limit (dBm)	Margin (dB)
1	1786.60	-60.4	-54.2	0.3	-53.9	-13.0	-40.9
Antenna Polarity & Test Distance: Vertical at 3 M							
No.	Freq. (MHz)	Reading (dBm)	S.G Power Value (dBm)	Correction Factor (dB)	ERP (dBm)	Limit (dBm)	Margin (dB)
1	1786.60	-61.5	-56.2	0.3	-55.9	-13.0	-42.9

Remarks: ERP (dBm)= S.G Value (dBm) + Correction Factor (dB).

Channel Bandwidth: 3MHz

Mode	TX channel 2415 (870.5MHz)	Frequency Range	Above 1000MHz
Environmental Conditions	25deg. C, 65%RH	In30put Power	120Vac, 60Hz
Tested By	Greg Lin		

Antenna Polarity & Test Distance: Horizontal at 3 M							
No.	Freq. (MHz)	Reading (dBm)	S.G Power Value (dBm)	Correction Factor (dB)	ERP (dBm)	Limit (dBm)	Margin (dB)
1	1741.00	-60.7	-53.7	0.5	-53.2	-13.0	-40.2
Antenna Polarity & Test Distance: Vertical at 3 M							
No.	Freq. (MHz)	Reading (dBm)	S.G Power Value (dBm)	Correction Factor (dB)	ERP (dBm)	Limit (dBm)	Margin (dB)
1	1741.00	-61.2	-54.7	0.5	-54.2	-13.0	-41.2

Remarks: ERP (dBm)= S.G Value (dBm) + Correction Factor (dB).

Mode	TX channel 2525 (881.5MHz)	Frequency Range	Above 1000MHz
Environmental Conditions	25deg. C, 65%RH	In30put Power	120Vac, 60Hz
Tested By	Greg Lin		

Antenna Polarity & Test Distance: Horizontal at 3 M							
No.	Freq. (MHz)	Reading (dBm)	S.G Power Value (dBm)	Correction Factor (dB)	ERP (dBm)	Limit (dBm)	Margin (dB)
1	1763.00	-60.2	-53.7	0.5	-53.2	-13.0	-40.2
Antenna Polarity & Test Distance: Vertical at 3 M							
No.	Freq. (MHz)	Reading (dBm)	S.G Power Value (dBm)	Correction Factor (dB)	ERP (dBm)	Limit (dBm)	Margin (dB)
1	1763.00	-61.1	-55.3	0.5	-54.8	-13.0	-41.8

Remarks: ERP (dBm)= S.G Value (dBm) + Correction Factor (dB).



Mode	TX channel 2635 (892.5MHz)	Frequency Range	Above 1000MHz
Environmental Conditions	25deg. C, 65%RH	Input Power	120Vac, 60Hz
Tested By	Greg Lin		

Antenna Polarity & Test Distance: Horizontal at 3 M							
No.	Freq. (MHz)	Reading (dBm)	S.G Power Value (dBm)	Correction Factor (dB)	ERP (dBm)	Limit (dBm)	Margin (dB)
1	1785.00	-60.8	-54.6	0.4	-54.2	-13.0	-41.2
Antenna Polarity & Test Distance: Vertical at 3 M							
No.	Freq. (MHz)	Reading (dBm)	S.G Power Value (dBm)	Correction Factor (dB)	ERP (dBm)	Limit (dBm)	Margin (dB)
1	1785.00	-61.9	-56.5	0.4	-56.1	-13.0	-43.1

Remarks: ERP (dBm)= S.G Value (dBm) + Correction Factor (dB).

Channel Bandwidth: 5MHz

Mode	TX channel 2425 (871.5MHz)	Frequency Range	Above 1000MHz
Environmental Conditions	25deg. C, 65%RH	In30put Power	120Vac, 60Hz
Tested By	Greg Lin		

Antenna Polarity & Test Distance: Horizontal at 3 M							
No.	Freq. (MHz)	Reading (dBm)	S.G Power Value (dBm)	Correction Factor (dB)	ERP (dBm)	Limit (dBm)	Margin (dB)
1	1743.00	-61.4	-54.5	0.5	-54.0	-13.0	-41.0
Antenna Polarity & Test Distance: Vertical at 3 M							
No.	Freq. (MHz)	Reading (dBm)	S.G Power Value (dBm)	Correction Factor (dB)	ERP (dBm)	Limit (dBm)	Margin (dB)
1	1743.00	-62.2	-55.9	0.5	-55.4	-13.0	-42.4

Remarks: ERP (dBm)= S.G Value (dBm) + Correction Factor (dB).

Mode	TX channel 2525 (881.5MHz)	Frequency Range	Above 1000MHz
Environmental Conditions	25deg. C, 65%RH	In30put Power	120Vac, 60Hz
Tested By	Greg Lin		

Antenna Polarity & Test Distance: Horizontal at 3 M							
No.	Freq. (MHz)	Reading (dBm)	S.G Power Value (dBm)	Correction Factor (dB)	ERP (dBm)	Limit (dBm)	Margin (dB)
1	1763.00	-59.5	-53.0	0.5	-52.5	-13.0	-39.5
Antenna Polarity & Test Distance: Vertical at 3 M							
No.	Freq. (MHz)	Reading (dBm)	S.G Power Value (dBm)	Correction Factor (dB)	ERP (dBm)	Limit (dBm)	Margin (dB)
1	1763.00	-60.9	-55.0	0.5	-54.5	-13.0	-41.5

Remarks: ERP (dBm)= S.G Value (dBm) + Correction Factor (dB).

Mode	TX channel 2625 (891.5MHz)	Frequency Range	Above 1000MHz
Environmental Conditions	25deg. C, 65%RH	Input Power	120Vac, 60Hz
Tested By	Greg Lin		

Antenna Polarity & Test Distance: Horizontal at 3 M							
No.	Freq. (MHz)	Reading (dBm)	S.G Power Value (dBm)	Correction Factor (dB)	ERP (dBm)	Limit (dBm)	Margin (dB)
1	1783.00	-60.9	-54.8	0.4	-54.4	-13.0	-41.4
Antenna Polarity & Test Distance: Vertical at 3 M							
No.	Freq. (MHz)	Reading (dBm)	S.G Power Value (dBm)	Correction Factor (dB)	ERP (dBm)	Limit (dBm)	Margin (dB)
1	1783.00	-62.1	-56.8	0.4	-56.4	-13.0	-43.4

Remarks: ERP (dBm)= S.G Value (dBm) + Correction Factor (dB).

Channel Bandwidth: 10MHz

Mode	TX channel 2450 (874.0MHz)	Frequency Range	Above 1000MHz
Environmental Conditions	25deg. C, 65%RH	In30put Power	120Vac, 60Hz
Tested By	Greg Lin		

Antenna Polarity & Test Distance: Horizontal at 3 M							
No.	Freq. (MHz)	Reading (dBm)	S.G Power Value (dBm)	Correction Factor (dB)	ERP (dBm)	Limit (dBm)	Margin (dB)
1	1748.00	-60.5	-53.8	0.5	-53.3	-13.0	-40.3
Antenna Polarity & Test Distance: Vertical at 3 M							
No.	Freq. (MHz)	Reading (dBm)	S.G Power Value (dBm)	Correction Factor (dB)	ERP (dBm)	Limit (dBm)	Margin (dB)
1	1748.00	-61.6	-55.4	0.5	-54.9	-13.0	-41.9

Remarks: ERP (dBm)= S.G Value (dBm) + Correction Factor (dB).

Mode	TX channel 2525 (881.5MHz)	Frequency Range	Above 1000MHz
Environmental Conditions	25deg. C, 65%RH	In30put Power	120Vac, 60Hz
Tested By	Greg Lin		

Antenna Polarity & Test Distance: Horizontal at 3 M							
No.	Freq. (MHz)	Reading (dBm)	S.G Power Value (dBm)	Correction Factor (dB)	ERP (dBm)	Limit (dBm)	Margin (dB)
1	1763.00	-60.8	-54.3	0.5	-53.8	-13.0	-40.8
Antenna Polarity & Test Distance: Vertical at 3 M							
No.	Freq. (MHz)	Reading (dBm)	S.G Power Value (dBm)	Correction Factor (dB)	ERP (dBm)	Limit (dBm)	Margin (dB)
1	1763.00	-62.1	-56.3	0.5	-55.8	-13.0	-42.8

Remarks: ERP (dBm)= S.G Value (dBm) + Correction Factor (dB).

Mode	TX channel 2600 (889.0MHz)	Frequency Range	Above 1000MHz
Environmental Conditions	25deg. C, 65%RH	Input Power	120Vac, 60Hz
Tested By	Greg Lin		

Antenna Polarity & Test Distance: Horizontal at 3 M							
No.	Freq. (MHz)	Reading (dBm)	S.G Power Value (dBm)	Correction Factor (dB)	ERP (dBm)	Limit (dBm)	Margin (dB)
1	1778.00	-59.8	-53.5	0.4	-53.1	-13.0	-40.1
Antenna Polarity & Test Distance: Vertical at 3 M							
No.	Freq. (MHz)	Reading (dBm)	S.G Power Value (dBm)	Correction Factor (dB)	ERP (dBm)	Limit (dBm)	Margin (dB)
1	1778.00	-61.0	-55.4	0.4	-55.0	-13.0	-42.0

Remarks: ERP (dBm)= S.G Value (dBm) + Correction Factor (dB).

multi-carrier

Channel Bandwidth: 10MHz + 10MHz + 5MHz

Mode	TX channel 2525 (881.5MHz)	Frequency Range	Below 1000 MHz
Environmental Conditions	25deg. C, 65%RH	Input Power	120Vac, 60Hz
Tested By	Greg Lin		

Antenna Polarity & Test Distance: Horizontal at 3 M							
No.	Freq. (MHz)	Reading (dBm)	S.G Power Value (dBm)	Correction Factor (dB)	ERP (dBm)	Limit (dBm)	Margin (dB)
1	30.97	-42.5	-22.2	-18.8	-41.0	-13.0	-28.0
2	96.93	-34.0	-43.9	-1.2	-45.1	-13.0	-32.1
3	153.19	-32.1	-35.6	-2.9	-38.5	-13.0	-25.5
4	353.98	-53.0	-62.1	3.9	-58.2	-13.0	-45.2
5	556.71	-59.6	-64.9	3.7	-61.2	-13.0	-48.2
6	716.76	-50.5	-53.0	3.5	-49.5	-13.0	-36.5

Remarks: ERP (dBm)= S.G Value (dBm) + Correction Factor (dB).

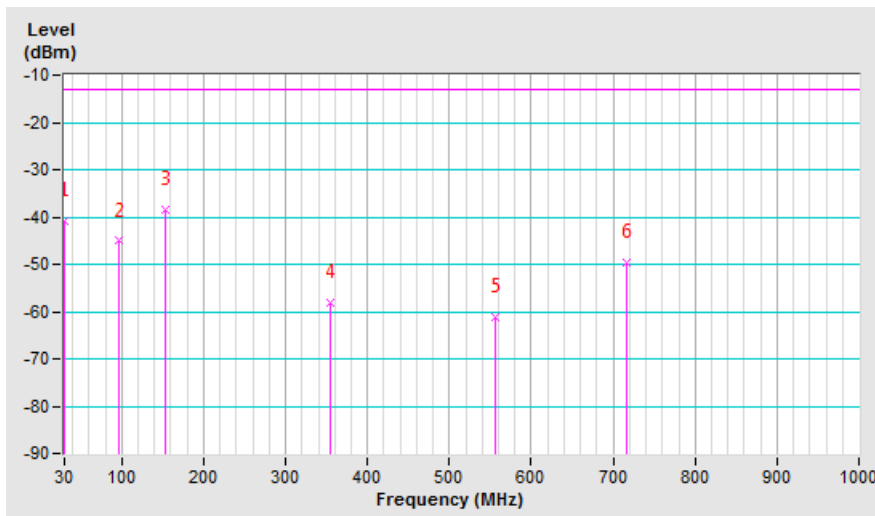

Mode	TX channel 2525 (881.5MHz)	Frequency Range	Below 1000 MHz
Environmental Conditions	25deg. C, 65%RH	Input Power	120Vac, 60Hz
Tested By	Greg Lin		

Antenna Polarity & Test Distance: Vertical at 3 M							
No.	Freq. (MHz)	Reading (dBm)	S.G Power Value (dBm)	Correction Factor (dB)	ERP (dBm)	Limit (dBm)	Margin (dB)
1	62.01	-29.3	-35.2	-3.0	-38.2	-13.0	-25.2
2	96.93	-28.1	-37.0	-1.2	-38.2	-13.0	-25.2
3	153.19	-37.5	-38.9	-2.9	-41.8	-13.0	-28.8
4	354.95	-52.7	-59.1	3.9	-55.2	-13.0	-42.2
5	547.01	-54.2	-58.6	3.9	-54.7	-13.0	-41.7
6	647.89	-52.2	-52.5	3.7	-48.8	-13.0	-35.8

Remarks: ERP (dBm)= S.G Value (dBm) + Correction Factor (dB).

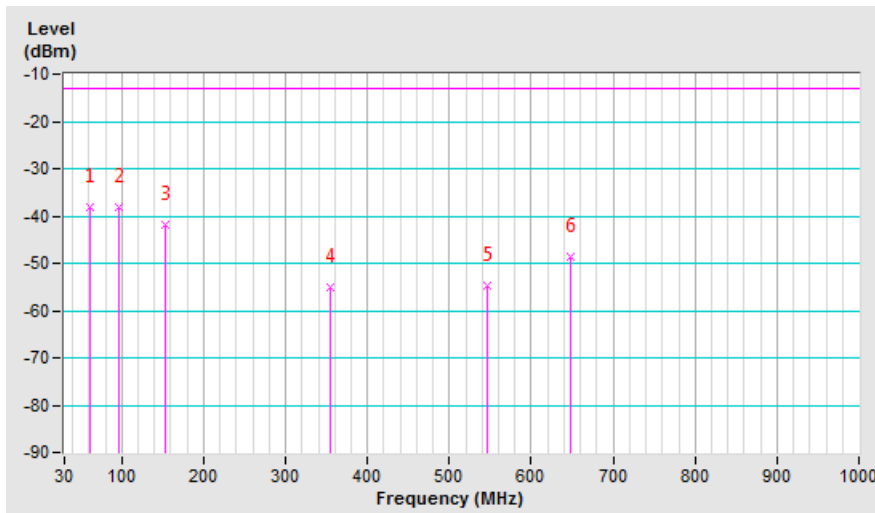

Above 1GHz

Channel Bandwidth: 10MHz + 10MHz + 5MHz

Mode	TX channel 2525 (881.5MHz)	Frequency Range	Above 1000MHz
Environmental Conditions	25deg. C, 65%RH	Input Power	120Vac, 60Hz
Tested By	Greg Lin		

Antenna Polarity & Test Distance: Horizontal at 3 M							
No.	Freq. (MHz)	Reading (dBm)	S.G Power Value (dBm)	Correction Factor (dB)	ERP (dBm)	Limit (dBm)	Margin (dB)
1	1763.00	-59.5	-53.0	0.5	-52.5	-13.0	-39.5
Antenna Polarity & Test Distance: Vertical at 3 M							
No.	Freq. (MHz)	Reading (dBm)	S.G Power Value (dBm)	Correction Factor (dB)	ERP (dBm)	Limit (dBm)	Margin (dB)
1	1763.00	-60.9	-55.0	0.5	-54.5	-13.0	-41.5

Remarks: ERP (dBm)= S.G Value (dBm) + Correction Factor (dB).



## 5 Pictures of Test Arrangements

Please refer to the attached file (Test Setup Photo).

## Appendix – Information on the Testing Laboratories

We, Bureau Veritas Consumer Products Services (H.K.) Ltd., Taoyuan Branch, were founded in 1988 to provide our best service in EMC, Radio, Telecom and Safety consultation. Our laboratories are FCC recognized accredited test firms and accredited and approved according to ISO/IEC 17025.

If you have any comments, please feel free to contact us at the following:

### Linko EMC/RF Lab

Tel: 886-2-26052180  
Fax: 886-2-26051924

### Hsin Chu EMC/RF/Telecom Lab

Tel: 886-3-6668565  
Fax: 886-3-6668323

### Hwa Ya EMC/RF/Safety Lab

Tel: 886-3-3183232  
Fax: 886-3-3270892

**Email:** [service.adt@tw.bureauveritas.com](mailto:service.adt@tw.bureauveritas.com)

**Web Site:** [www.bureauveritas-adt.com](http://www.bureauveritas-adt.com)

The address and road map of all our labs can be found in our web site also.

--- END ---