

Global Product Compliance Laboratory
600-700 Mountain Avenue
Room 5B-108
Murray Hill, New Jersey 07974-0636 USA



TESTING
NVLAP LAB CODE: 100275-0

FCC Certification Part 30 Test Report

Product Evaluated

AEWD AirScale MAA 2x2T2R 256AE n260 4W
AEWE AirScale MAA 2x2T2R 256AE n260 4W
AEWD + AEWE 39 GHz Radio Unit,
FCC ID: 2AD8UAEWDAEWE01

Customer

Nokia Solutions and Networks, OY
2000 Lucent Lane
Naperville, Illinois 60563 USA

Test Laboratory

Nokia Bell Labs
Nokia, Global Product Compliance Laboratory
600-700 Mountain Avenue, Rm 5B-108
Murray Hill, New Jersey 07974-0636 USA

Date: October 7, 2019

This report shall not be reproduced, in whole or in part without the approval of Nokia Global Product Compliance Laboratory. This report must not be used by the recipient to claim product endorsement by NVLAP or any other agency of the U.S. Government.

Revisions

Date	Revision	Sections	Change
8/29/2019	0		Initial Release
9/12/2019	1	3.2, 4.3	OOBE Emissions revision
10/7/2019	2	4.5 - 4.10	Radiated Emissions

Nokia Global Product Compliance Laboratory represents to the client that testing was done in accordance with standard procedures as applicable, and that reported test results are accurate within generally accepted commercial ranges of accuracy in accordance with the scope of our NVLAP Accreditation. Nokia Global Product Compliance reports only apply to the specific samples tested. This report is the property of the client. This report shall not be reproduced except in full without the written approval of the Nokia Global Product Compliance Laboratory.

Nokia Global Product Compliance Laboratory is accredited with the US Department of Commerce National Institute of Standards and Technology's National Voluntary Laboratory Accreditation Program (NVLAP) for satisfactory compliance with criteria established in Title 15, Part 7 Code of Federal Regulations for offering test services for selected test methods in Electromagnetic Compatibility; Voluntary Control Council for Interference (VCCI), Japan; Australian Communications and Media Authority (ACMA). The laboratory is ISO 9001:2008 Certified.

Nokia Global Product Compliance Laboratory represents to the client that the laboratory's accreditation or any of its calibration or test reports in no way constitutes or implies product certification, approval, or endorsement by NVLAP, NIST, or any agency of the federal government.

Prepared By: **W. Steve Majkowski NCE**

Approved By: **Ray Johnson**



10/7/2019



10/7/2019

Product Certification Filing Lead
 Nokia Bell Labs
 Nokia, Global Product Compliance Laboratory

Technical Manager
 Nokia Bell Labs
 Nokia, Global Product Compliance Laboratory

Table of Contents

1.	ATTESTATION OF TEST RESULTS	5
2.	SUMMARY OF THE TEST RESULTS	6
2.1	MEASUREMENT UNCERTAINTY.....	6
3.	GENERAL INFORMATION	7
3.1	PRODUCT DESCRIPTIONS.....	7
3.1.1	<i>NR-ARFCN Calculation</i>	7
3.1.2	<i>Tested Frequencies</i>	8
3.1.3	<i>Primary and Extension Module - Tested Panels</i>	8
3.2	EIRP/ PSD COMPLIANCE AND ANTENNA INFORMATION.....	9
3.3	ANTENNA FAR FIELD DETERMINATION DISTANCE.....	9
4.	REQUIRED MEASUREMENTS AND RESULTS	10
4.1	SECTION 2.1046 MEASUREMENT REQUIRED: RF POWER OUTPUT.....	11
4.1.1	<i>RF Power Output Measurement</i>	11
4.1.2	<i>RF Power Output Results</i>	12
4.1.3	<i>RF Power Output Data</i>	12
4.1.3.1	<i>RF Power Output Sample Data</i>	14
4.2	SECTION 2.1047 MEASUREMENT REQUIRED: MODULATION CHARACTERISTICS.....	17
4.2.1	<i>Modulation Characteristics Measurement</i>	17
4.2.2	<i>Modulation Measurements Results:</i>	17
4.3	SECTION 2.1049 MEASUREMENT REQUIRED: OCCUPIED BANDWIDTH AND EDGE OF BAND EMISSIONS.....	19
4.3.1	<i>Results Occupied Bandwidth (Signal Bandwidth)</i>	19
4.3.1.1	<i>Results - Occupied Bandwidth Carrier Aggregation</i>	21
4.3.1.2	<i>Results - Occupied Bandwidth Sample Data - 99% Signal Bandwidth</i>	22
4.3.2	<i>Occupied Bandwidth-Edge of Band Emissions and Out Of Band Emissions</i>	24
4.3.3	<i>Requirements 39 GHz Emissions Limits</i>	24
4.3.4	<i>Measurement Offset and MIMO</i>	24
4.3.5	<i>Mask Parameters</i>	25
4.3.6	<i>Measurement Path Correction</i>	25
4.3.6.1	<i>OOBE Sample calculation</i>	25
4.3.7	<i>Edge of Band Measurements</i>	26
4.3.7.1	<i>Results - Occupied Bandwidth Out Of Band Emissions /-Edge of Block Emissions</i> 26	
4.4	SECTION 2.1051 MEASUREMENT REQUIRED: SPURIOUS EMISSIONS AT THE ANTENNA TERMINALS.....	34
4.4.1	<i>Section 2.1051 Spurious Emissions at Antenna Terminals</i>	34
4.4.2	<i>Required Limit</i>	34
4.4.3	<i>Results</i>	34
4.5	SECTION 2.1053 MEASUREMENT REQUIRED: FIELD STRENGTH OF SPURIOUS RADIATION.....	35
4.5.1	<i>Spurious Radiation and Radiated Emissions Requirements Below 40 GHz</i>	35

4.6	RADIATED EMISSIONS MEASUREMENT PROCEDURE	37
4.7	NORMALIZED SITE ATTENUATION (NSA) MEASUREMENTS CISPR 16-1-4 ANSI C63.4	37
4.7.1	<i>Site VSWR CISPR 16-1-4</i>	37
4.7.2	<i>Special Test Considerations (General Notes)</i>	37
4.7.3	<i>Bandwidths And Detector Functions</i>	38
4.8	PRESCAN EMISSION MEASUREMENT	38
4.9	FINAL RADIATED EMISSIONS TEST PROCEDURE - SEMI ANECHOIC ROOM SHIELDED CHAMBER FINAL RADIATED EMISSIONS MEASUREMENTS	38
4.10	E-FIELD MEASUREMENTS BETWEEN 18 GHz – 40 GHz	39
4.10.1	<i>Low Pass filter for E-Field Measurements between 26.5 GHz – 37 GHz</i>	40
4.10.2	<i>Radiated Emissions Test Sample Calculation</i>	41
4.10.3	<i>Radiated Emissions Test Software</i>	41
4.10.4	<i>Radiated Spurious Emissions Measurements: 40 GHz - 200 GHz:</i>	41
4.10.4.1	<i>Bandwidth Limits and Corrections: Radiated Measurements 40 GHz - 200 GHz,</i> ...	42
4.10.4.2	<i>Resolution Bandwidth and # of Points:</i>	42
4.10.4.3	<i>Part 30 Limit:</i>	43
4.10.4.4	<i>Emissions Corrections.</i>	43
4.10.5	<i>Field Strength of Spurious Radiation Results 30 MHz – 37 GHz:</i>	45
4.10.6	<i>Field Strength of Spurious Radiation Results 40 GHz – 200 GHz:</i>	45
4.10.7	<i>Reportable Transmitter Measurements of Radiated Spurious Emissions 30 MHz – 36 GHz</i> 46	46
4.10.8	<i>Maximum Radiated Emissions -U Band 40GHz-60GHz - 4m</i>	49
4.10.9	<i>Maximum Radiated Emissions -E Band 60GHz-90GHz - 4.5m</i>	51
4.10.10	<i>Maximum Radiated Emissions -F Band 90GHz-140GHz - 3m</i>	52
4.10.11	<i>Maximum Radiated Emissions - G Band 140 - 170GHz - 3m</i>	53
4.10.12	<i>Maximum Radiated Emissions - G Band 170 - 200GHz - 3m</i>	54
4.11	SECTION 2.1055 MEASUREMENT REQUIRED: FREQUENCY STABILITY	55
4.11.1	<i>Frequency Stability Test</i>	55
4.11.2	<i>Frequency Stability – Results Summary</i>	55
4.11.3	<i>Frequency Stability Test Setups</i>	56
4.11.4	<i>Frequency Stability – Data</i>	57
4.11.4.1	<i>AC Powered Data</i>	57
4.11.4.2	<i>DC Powered Data</i>	64
4.12	LIST OF TEST EQUIPMENT	72
4.12.1	<i>Test Equipment Used For Radiated Emissions and Radio Measurements</i>	72
4.12.2	<i>Frequency Stability Test Equipment</i>	73
4.13	PHOTOGRAPHS OF THE TEST SETUPS	74
4.13.1	<i>Radiated Emissions and Radio Measurements Test Photos</i>	74
4.13.2	<i>Frequency Stability Test Set Up Photos</i>	81
4.14	FACILITIES AND ACCREDITATION	83
5.	APPENDIX A - CALIBRATION CERTIFICATES.	85

1. ATTESTATION OF TEST RESULTS

Company Name	Nokia Solutions and Networks, OY 2000 Lucent Lane Naperville, Illinois 60563
FCC ID	2AD8UAEWDAEWE01
Product Name	AEWD AirScale MAA 2*2T2R 256AE n260 4W AEWE AirScale MAA 2*2T2R 256AE n260 4W
Model Name	AEWD + AEWE
Part No	474612A.X21, 474691A.X21.
Serial Number(s)	AC/DC Models: YK191800017, YK192100004
Test Standard(s)	<ul style="list-style-type: none"> • 47 CFR FCC Parts 2 and Part 30 • KDB 971168 D01 Licensed DTS Guidance v03r01 April 9, 2018 • KDB 662911 D01 Multiple Transmitter Output v02r01 Oct 2013 • Procedures on TRP Compliance for Out of Band and Spurious Emissions, C63.26 mmWave JTG - Version # 1 July 14th 2018 • KDB 842590 D01 Upper Microwave Flexible Use Service v01 April 5, 2019
Reference(s)	<ul style="list-style-type: none"> • ANSI C63.26 (2015) • ANSI C63.4 (2014) • TR 14-1001, MMW Measurements with Harmonic Mixers (April-4-2014)
Frequency Band	(Tx: 37 – 40.0 GHz), NR Band n260
Technology	5G-New Radio, LTE-TDD: 98M0G7W,
Test Frequency Range	10MHz – 200GHz
Operation Mode(s)	2x 48dBm EIRP, 51 dBm EIRP Total. MIMO, 1 to 4 Carriers
Submission Type	Initial Filing
FCC Part 15 Part B	Compliance with Class B
Test Date	August 12- October 4, 2019
Test Laboratory	Nokia Global Product Compliance Laboratory 600-700 Mountain Avenue, Rm 5B-108 Murray Hill, New Jersey 07974-0636 USA NVLAP Lab Code: 100275-0 FCC Registration Number: 395774

This is to certify that the above product has been evaluated and found to be in compliance with the Rules and Regulations set forth in the above standard(s). The data and the descriptions about the test setup, procedures and configuration presented in this report are accurate. The results of testing in this report apply only to the product/system which was tested. Other similar equipment will not necessarily produce the same results due to production tolerance and measurement uncertainties.

Per the requirement of Section 2.911(d) Certification of Technical Test Data, I hereby certify that the technical test data are the results of tests either performed or supervised by me.

W. Steve Majkowski NCE
 Member of Technical Staff
 Nokia, Global Product Compliance Laboratory

2. SUMMARY OF THE TEST RESULTS

47 CFR FCC Sections	Description of Tests	Compliance Results
2.1046, 30.202 (a)	RF Power Output	Pass
2.1047,	Modulation Characteristics	Pass
2.1049, 30.203	(a) Occupied Bandwidth (b) Edge-of-Band Emissions	Pass
2.1051, 30.203	Spurious Emissions at Antenna Terminals - Radiated	Pass
2.1053, 30.203	Field Strength of Spurious Radiation	Pass
2.1055,	Measurement of Frequency Stability	Not Required

2.1 Measurement Uncertainty

The results of the calculations to estimate uncertainties for the several test methods and standards are shown in the Tables below. These are the worst-case values.

Worst-Case Estimated Measurement Uncertainties

Standard, Method or Procedure	Condition	Frequency MHz	Expanded Uncertainty (k=2)
a. Classical Emissions, (e.g., ANSI C63.4, CISPR 11, 14, 22, etc., using ESHS 30,	Conducted Emissions	0.009 - 30	±3.5 dB
	Radiated Emissions (AR-8 Semi-Anechoic Chamber)	30 MHz – 200MHz H	±5.4 dB
		30 MHz – 200 MHz V	±5.4 dB
		200 MHz – 1000 MHz H	±4.7 dB
		200 MHz – 1000 MHz V	±4.7 dB
	1 GHz- 18 GHz	±3.3 dB	

Antenna Port Test	Signal Bandwidth	Frequency Range	Expanded Uncertainty (k=2), Amplitude
Occupied Bandwidth, Edge of Band,	10 Hz 100 Hz 10 kHz to 1 MHz 1MHz to 100 MHz	9 kHz to 20 MHz 20 MHz to 1 GHz 1 GHz to 10 GHz 10 GHz to 40 GHz:	±2.2 dB
Conducted Spurious Emissions	30 kHz to 100 MHz	10 MHz to 40 GHz:	±2.8 dB
RF Power, Channel Power	10 Hz to 100 MHz	10 MHz to 40 GHz	±1.4 dB

3. GENERAL INFORMATION

3.1 Product Descriptions

The equipment under test (EUT) has the following specifications.

Table 3.1.1 Product Specifications

Specification Items	Description
Product Type	Compact Base Station LTE Module (2Tx, 2Rx), 2x2 MIMO
Radio Type	Intentional Transceiver
Power Type	115 VAC
Modulation	5G New Radio LTE-TDD with QPSK, 16QAM and 64QAM
Operating Frequency Range	TDD (Tx. /Rx: 37.0-40.0 GHz),
Channel Bandwidth	100 MHz,
Max Radiated Power (EIRP)	48 dBm EIRP per polarizations. 51 dBm EIRP Total for the two polarizations.
Antenna Gain	22 dBi
Operating Mode	2x2 MIMO (2 duplex Tx/Rx Ports)
Software Version	5GH49.06.R04
Hardware Version	474612A.X21, 474691A.X21.
Antenna(s)	Refer to Section 3.2

The EUT supports the following carrier configurations:

Table 3.1.2 EUT Supported Configurations

Carrier Bandwidth (MHz)	Carriers per Path	MIMO Modes	Signal Type	Modulation
100	1	2x	LTE-TDD	QPSK, 16QAM & 64QAM

3.1.1 NR-ARFCN Calculation

The computational relationship between the NR-ARFCN and the RF reference frequency (or carrier center frequency) F_{ref} in MHz for the downlink and uplink is defined by the following equation, where the values of F_{offset} and N_{offset} depend on the frequency range as given in the table below and N_{ref} is the NR-ARFCN.

$$F_{ref} = F_{offset} + \Delta F (N_{ref} - N_{offset}) \quad (1)$$

$$N_{ref} = N_{offset} + (F_{ref} - F_{offset}) / \Delta F \quad (2)$$

So for the Upper Microwave Flexible Use Services (UMFUS) band:

$$F_{ref} = 24250 + 0.06(NR-ARFCN-2016667) \text{ MHz}$$

For a NR-ARFCN =2229999 the F_{ref} is:

$$F_{ref} = 37.04992 \text{ GHz} = 24250 + 0.06(2229999-2016667)$$

Table 3.1.1 NR-ARFCN Calculation Parameters for UMFUS

Frequency Range	ΔF	F _{offset} [MHz]	N _{offset}	Range of N _{ref}
24250 – 100000 MHz	0.06 MHz	24250 MHz	2016667	2016667 – 3279167

3.1.2 Tested Frequencies

The as tested operating band consists of the following channels and spectrum:

New Radio - Absolute Radio Frequency Channel Number (NRARFCN)

Table 3.1.3 NRARFCN per 38.101-2, for n260 with 100 MHz Carriers

Channel Location in Band	NR-ARFCN	TDD Center Reference Frequency (MHz)	Width of Channel (MHz)
Left Side	2229999	37050.00	99.96
Left Side	2231665	37150.08	99.96
Left Side	2233331	37250.16	99.96
Left Side	2234997	37350.24	99.96
Middle	2251666	38350.020	99.96
Middle	2253332	38449.980	99.96
Middle	2254998	38549.940	99.96
Middle	2256664	38649.900	99.96
Right Side	2273334	39650.100	99.96
Right Side	2275000	39750.060	99.96
Right Side	2276666	39850.020	99.96
Right Side	2278332	39949.980	99.96

3.1.3 Primary and Extension Module - Tested Panels

The Primary AEWD 39 GHz Radio Unit has two identical transmit antenna panels that are mounted 90 degrees offset so as to provide 180 degrees of coverage. The Extension module AEWE has mounts two additional and identical panels facing the other direction so as to provide 360 degree coverage. Each transmit panels is identical and each contain a horizontal and a vertically polarized antenna array as detailed in the filing. The Individual Transmit panels are identified as P1 through P4 and are operated one at a time. There is therefore no additive power combining from multiple panels and only the Horizontal and Vertical antenna arrays of a single panel are active at any time. Table 4.1.3, Summary of Channel Power Measurements, identifies which panel was tested for the particular transmit configuration.

3.2 EIRP/ PSD Compliance and Antenna Information.

The product incorporates integrated antennas. Externally mounted antennas cannot be attached to the unit or mounted remotely. The units integrated antennas are electronically steerable with a gain of 23 dBi. There are two antenna assemblies inside the product. Each antenna transmit assembly is an 8x8 matrix (64 elements) of patch antennas. One assembly is vertically polarized and the second is horizontally polarized. The antennas RF drive level of 25 dBm and realized gain of 23 dBi results in a 48 dBm EIRP per assembly. The sum of the two 48 dBm EIRP beams results in a maximum EIRP of 51 dBm. Antenna Gain vs frequency is detailed in Exhibit 6 of the filing package.

3.3 Antenna Far Field Determination Distance

The Moongilan Test (1) was performed to determine the far field boundary location using calculations and low power measurements. For the antenna array we can calculate the Fraunhofer distance from

$$d_{ff} = 2D^2/\lambda$$

where d_{ff} = Far Field distance in meters,

D is the maximum size of the radiating array λ = wavelength of the operating signal in meters

The antenna patch are 5 cm x 5 cm and the patches are 10 cm apart .

At 39 GHZ the diagonal 5 cm x 5 cm array dimensions results in a Fraunhofer far field distance d_{ff} of 1.3 meters. The Vertical to Horizontal patches are enclosed by a 15 cm circle which results in a d_{ff} of 5.85 meters

Measurements for the Moongilan Test were performed at low power using a standard gain horn antenna In the horizontal polarization the determined boundary was 4 m.

To eliminate any inconsistency all Power, OBW and OOB measurements were made at 4.5 m.

(1) *The Moongilan Test is named in honor of the late Dheena Moongilan who discovered it and formulated its use into C63.26.*

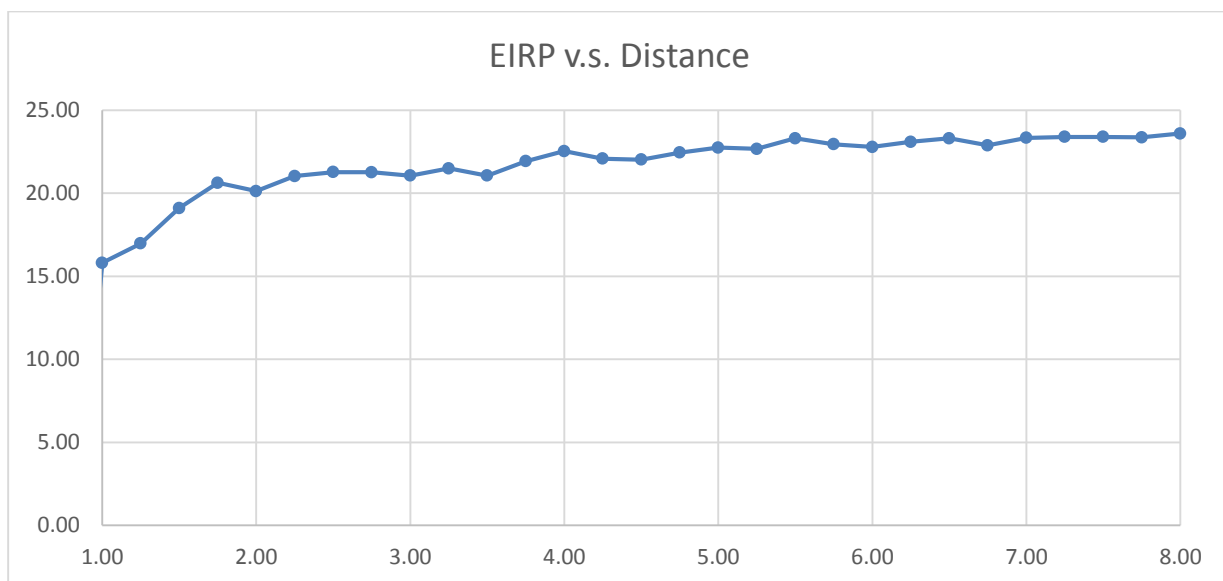

4. REQUIRED MEASUREMENTS AND RESULTS

Per 47CFR FCC Section 2.1033(c)(14), the following certification tests are required by Section 2.1046 through Section 2.1057. These tests are identified in Table 4.0a below.

Table 4.0a Required Certification Measurements

47 CFR FCC Sections	Description of Tests	Test Required for Class II
2.1046, 30.202 (a)	RF Power Output (a) Power Limits, EIRP, PSD	Yes
2.1047,	Modulation Characteristics	Yes
2.1049, 30.203	(a) Occupied Bandwidth (b) Out-of-Band Emissions	Yes
2.1051, 30.203	Spurious Emissions at Antenna Terminals	Yes
2.1053, 30.203, 30.204, 15.109(a) Class B	Field Strength of Spurious Radiation	Yes
2.1055,	Measurement of Frequency Stability	Yes

The measurements were conducted in accordance with the procedures set out in Section 2.1041 and as appropriate per the test Standards listed in Table 4.0b below. The comprehensive list of tests performed included measurements at Left, Center and Right side of the Part 30 Band. These tests are presented to demonstrate compliance with FCC requirements.

The procedures defined in ANSI C63.26-2015 and KDB 971168 D01 were developed for conducted measurements. The mmWave Joint Technical Group with FCC oversight has been working diligently on revisions to add mmWave measurements for Upper Microwave Flexible Use Service (UMFUS). The new KDB, 842590, is closely aligned with those efforts.

All of the measurements performed herein were performed as radiated measurements in semi-anechoic chambers maintained by Nokia Bell Lab’s Global Product Compliance Laboratory in Murray Hill, NJ. The 35-41 GHz “radio” measurements were performed in 10m chamber AR-8 while the other radiated emissions and spurious measurements up to 200 GHz were performed in 5m chamber AR-4. In order to perform the spurious measurements, the equipment settings required to enable the FSW internal noise reduction capability were used. This typically required the use of average detector, and multiple sweep averages. The individual test sections identify any changes in measurement process.

Table 4.0b Test Standards Used for Radiated Measurements of Radio Performance

Test Standard(s)	<ul style="list-style-type: none"> • 47 CFR FCC Parts 2 • KDB 971168 D01 Licensed DTS Guidance v03r01 April 9, 2018 • KDB 662911 D01 Multiple Transmitter Output v02r01 Oct 2013 • Procedures on TRP Compliance for Out of Band and Spurious Emissions, C63.26 mmWave JTG - Version # 1 July 14th 2018 • KDB 842590 D01 Upper Microwave Flexible Use Service v01 April 5, 2019
Reference(s)	<ul style="list-style-type: none"> • 47 CFR FCC Part 2 and Part 30 • ANSI C63.26 (2015) • ANSI C63.4 (2014) • TR 14-1001, MMW Measurements with Harmonic Mixers (April-4-2014)

4.1 Section 2.1046 MEASUREMENT REQUIRED: RF POWER OUTPUT

The product incorporates internal antennas that are integrated with the signal source. There is no antenna terminal connection on the product. Therefore, this test as implemented is not a measurement of the total conducted power at the antenna terminal but rather the total radiated power in terms of the maximum EIRP radiated by the product.

The FCC recognized that these products would use integrated antennas and likewise structured the requirements under Part 30. Under Part 30 the average power of the sum of all antenna elements is limited to an equivalent isotopically radiated power (EIRP) density of +75dBm/100 MHz.

The **Nokia AirScale 39 GHz Radio Unit (AEWB)**, FCC ID: 2AD8UAEWDAEWE01, is a 5G-NR LTE TDD radio head configured for one to four carrier operation. It is specified to provide a maximum power output of 48 dBm EIRP/63.1 W EIRP per transmit polarization for a sum total of 51 dBm EIRP /126W EIRP per unit. The product is designed for the 5G global market including operation per 47 CFR Part 30 rules for operation in the 5G New Radio Band n260 from 37 – 40 GHz.

4.1.1 RF Power Output Measurement

The product was configured for test as shown in Figure 4.1.1 below and allowed to warm up and stabilize per KDB 971168 D01 and ANSI C63.26.

Radiated Power measurements of the 5G New Radio transmit signal were conducted with an FSW Spectrum Analyzer per KDB 971168 D01 and KDB 842590 D01. These measurements were performed in 10m semi-anechoic chamber AR-8 with a 4.5 m measurement distance using a nominal 69.08 dB offset. An additional correction is necessary to ascertain the actual measured EIRP power. The calculation of path loss, cable loss and measurement antenna gain are listed in Table 4.1.1. below. The unit was configured to transmit a single beam at maximum power.

The Channel Power function of the FSW spectrum analyzer was used to measure the maximum average Horizontal and Vertical EIRP at the 4.5m boundary distance. The measurements were performed at the Left, Center and Right side of the 37-40 GHz frequency range for a nominally 100 MHz bandwidth carrier with various 5G-NR modulations. Channel power plots identify the individual carrier power and the total power.

Table 4.1.1 Corrections For Transmitter Power Measurements

Freq.	Free Space Path Loss, PL	Measurement Antenna Gain, G1	Measurement Cable Loss, L1	Total Offset Required PL -G1 + L1	FSW Measurement Offset	Required Final Correction
GHz	dB	dBi	dB	dB	dB	dB
35.0	76.39	23.25	15.11	68.25	69.08	-0.83
35.5	76.51	23.25	15.11	68.37	69.08	-0.71
36.0	76.63	23.25	15.11	68.49	69.08	-0.59
36.5	76.75	23.25	15.11	68.61	69.08	-0.47
37.0	76.87	23.25	15.11	68.73	69.08	-0.35
37.5	76.99	23.40	15.24	68.83	69.08	-0.25
38.0	77.10	23.45	15.37	69.02	69.08	-0.06
38.5	77.22	23.60	15.49	69.11	69.08	0.03
39.0	77.33	23.60	15.67	69.40	69.08	0.32
39.5	77.44	23.60	15.81	69.65	69.08	0.57
40.0	77.55	23.70	15.85	69.70	69.08	0.62
40.5	77.66	23.70	15.85	69.81	69.08	0.73
41.0	77.76	23.70	15.85	69.91	69.08	0.83

4.1.2 RF Power Output Results

The Power output measurement results verified the expected performance of 48 dBm EIRP per polarization which is 51 dBm total. The maximum measured level was 51.36 dBm. This level is well within the maximum Part 30.202a limit of 75 dBm EIRP. Measurements were performed for each modulation.

The measured performance was in full compliance with the Rules of the Commission. Sample data plots are detailed below.

4.1.3 RF Power Output Data

Table 4.1.3 below summarizes the Total Measured EIRP and identifies the tested configurations for the carrier configurations, modulation and which transmit panel was measured. The Sample data plots follow.

Table 4.1.3 - Summary of Channel Power Measurements

Location in Band	Freq., GHz	# of carriers	Transmit Panel Measured	Modulation	Horizontal Polarization Total Channel Power, EIRP	Vertical Polarization Total Channel Power, EIRP	Sum Total Channel Power EIRP
					dBm	dBm	dBm
Left	37.05000	1	2	16QAM	48.26	48.09	51.19
Center	38.49996	1	1	QPSK	48.0	48.21	51.12
Right	39.94998	1	3	64QAM	48.14	48.55	51.36
Left	37.05000, 37.14996,	2	4	64QAM	48.01	48.09	51.06
Right	39.75006, 39.85002, 39.94998,	3	3	16QAM	48.06	48.22	51.15
Left	37.05000, 37.14996, 37.24992, 37.34988,	4	2	16QAM	48.15	48.39	51.28
Center	38.35002, 38.44998, 38.54994, 38.64990,	4	2	QPSK	48.3	48.36	51.34
Right	39.65010 39.75006, 37.85002, 39.94998,	4	4	64QAM	48.01	48.25	51.14

The measured performance was in full compliance with the Rules of the Commission. The data plots are detailed below.

Figure 4.1.1 Test Set-Up for Measurement of Radio Transmitter Performance

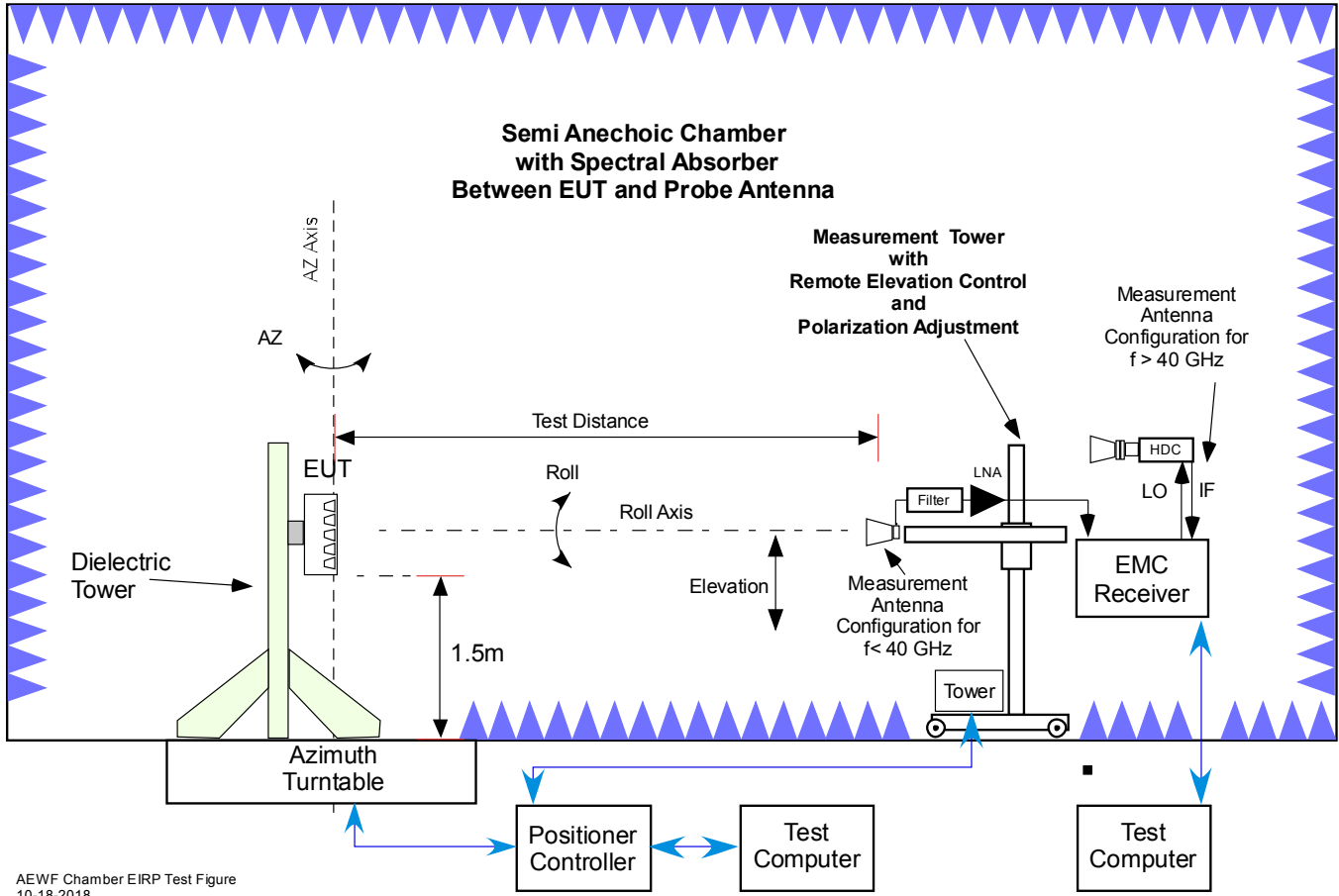

AEWF Chamber EIRP Test Figure
 10-18-2018

4.1.3.1 RF Power Output Sample Data

Channel Power Measurements, 4.5m, 1 Carrier

Left Side of Band – 37050.00 MHz

Horizontal –

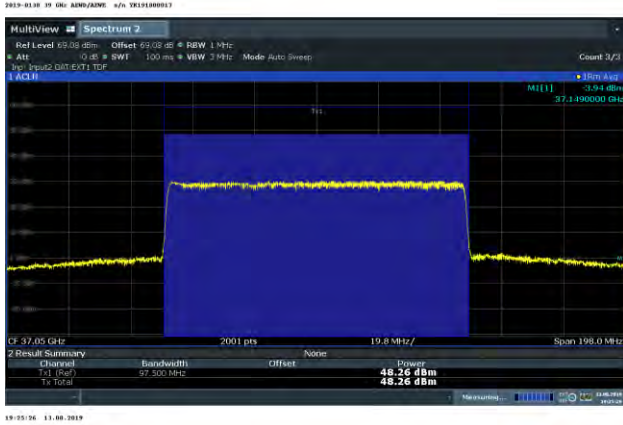

Vertical

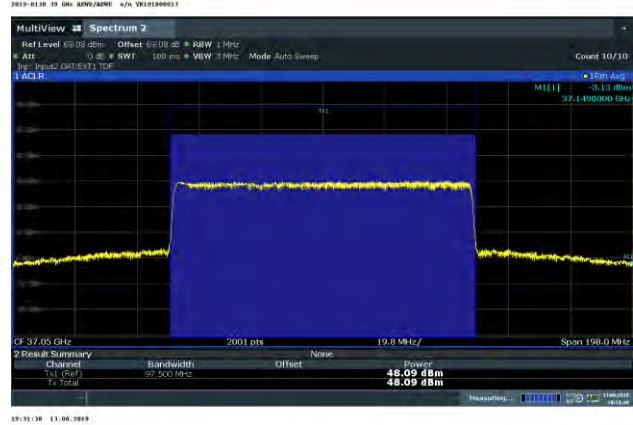

Center of Band - 38499.96 MHz

Horizontal

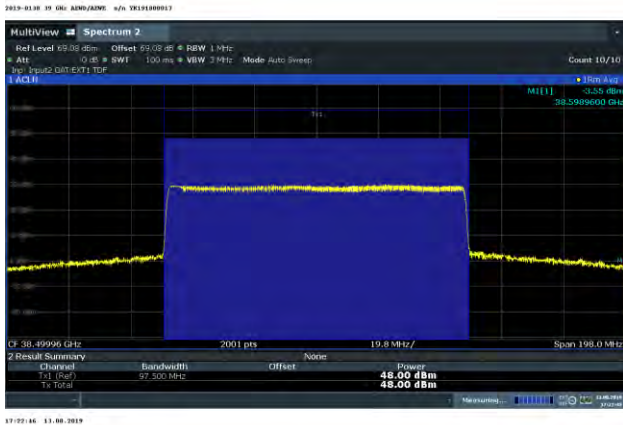

Vertical

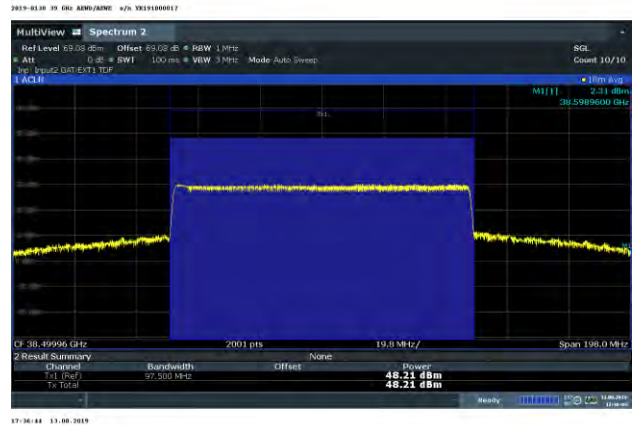

Right Side of Band - 39949.98 MHz

Horizontal

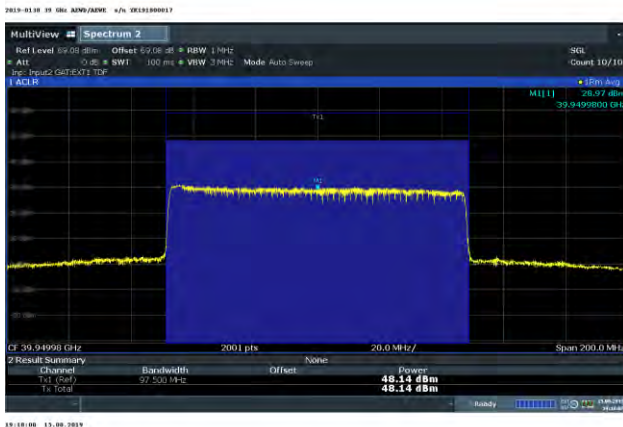

Vertical

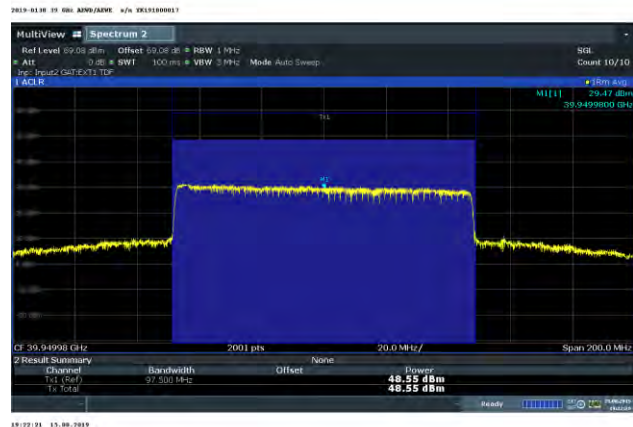

**Channel Power Measurements, 4.5m, 2 Carriers
 Left Side of Band. - 37050.00 + 37149.96 MHz
 Horizontal -**



Vertical-

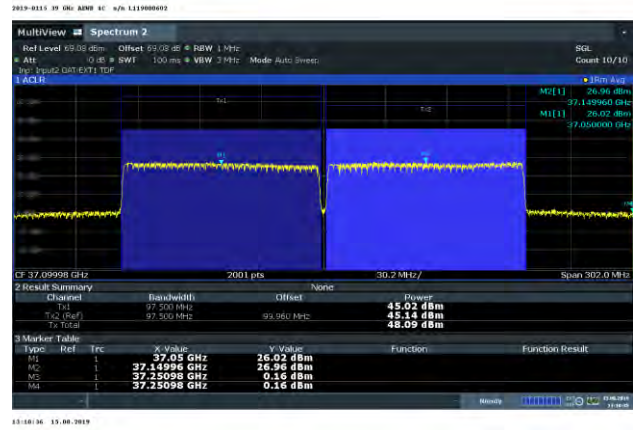

**Channel Power Measurements, 4.5m,
 3 Carriers on Right Side of Band - 39750.06 + 39850.02 + 39949.98 MHz
 Horizontal**

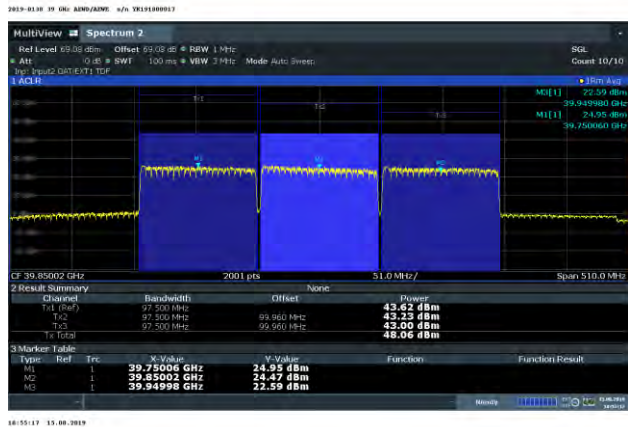

Vertical



**Channel Power Measurement at 4.5m, - 4 Carriers –
 Left Side of Band - 37050.00 + 37149.96 + 37249.92 + 37349.88 MHz
 Horizontal**

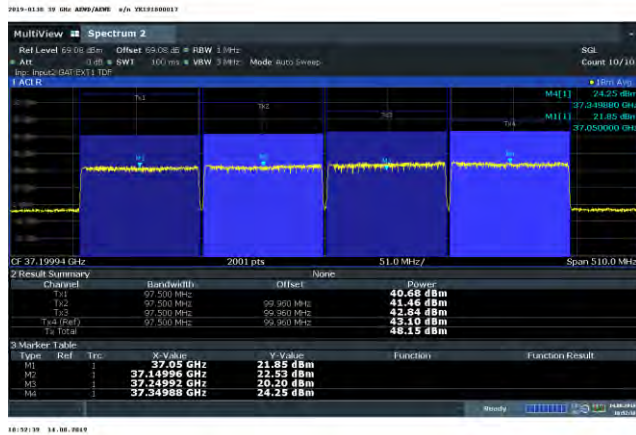

Vertical

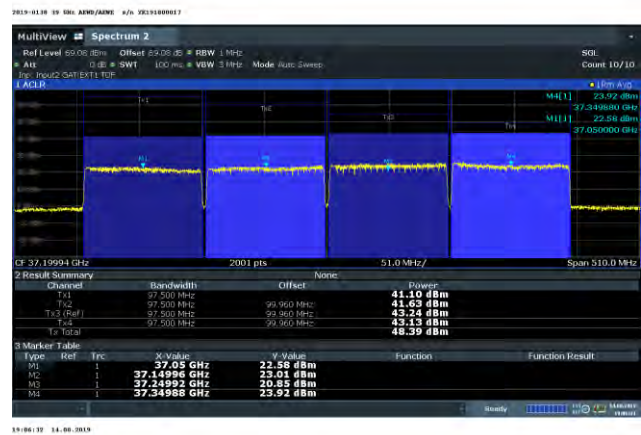

**Center of Band - 38350.02 + 38449.98 + 38549.94 + 38649.90 MHz
 Horizontal**

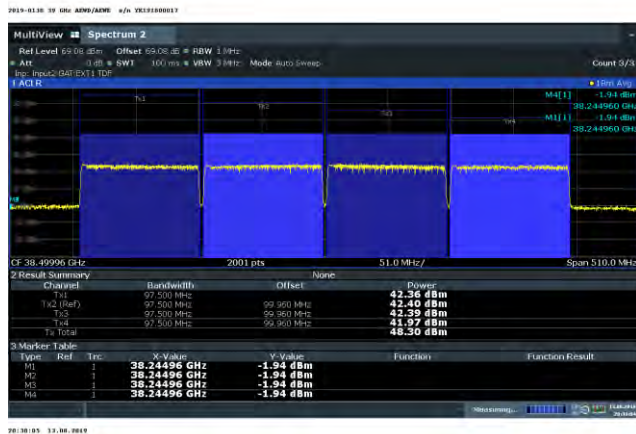

Vertical

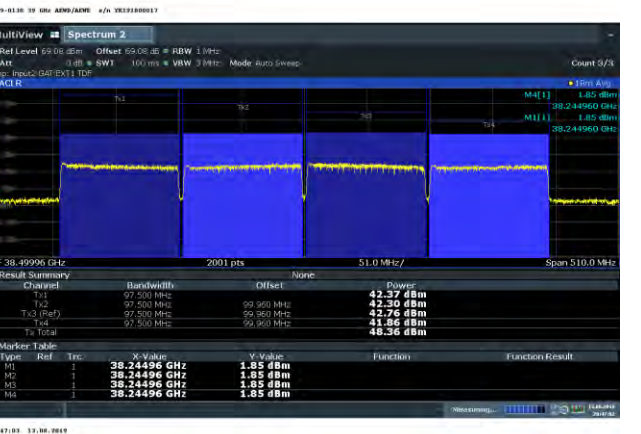

**Right Side of Band - 39650.10 + 39750.06 + 39850.02 + 39949.98 MHz
 Horizontal**



Vertical



4.2 Section 2.1047 MEASUREMENT REQUIRED: MODULATION CHARACTERISTICS

The 2AD8UAEWDAEWE01 supports the 5G New Radio Modulation Format based upon LTE TDD technologies. LTE utilizes Orthogonal Frequency Division Multiplexing (OFDM) which splits the carrier frequency bandwidth into many small subcarriers. Each individual subcarrier can be modulated with QPSK, 16QAM and 64QAM digital modulation formats.

In QPSK, there are 4 possible symbol states and each symbol carries 2 bits of information. In 16QAM, there are 16 possible symbol states and each 16-QAM symbol carries 4 bits of information. In 64QAM, there are 64 possible symbol states and each 64-QAM symbol carries 6 bits of information. The higher-order modulations, those where the constellations are more dense, are more sensitive to poor channel conditions than the lower-order modulation.

The modulation characteristics measurement of LTE carriers measures the difference between the ideal symbols and the measured symbols after the equalization. The 5G-New Radio format is still in revision in 3GPP and Release 16 is expected Q4 of 2018. Typical Constellations of each waveform type were recorded to assess that the subcarrier configurations were achieved.

There are no FCC Limits for Modulation and all of the formats above look spectrally the same from a channel edge and regrowth standpoint. It is expected that greater fidelity will be available after test equipment is configurable with the final format of Release 16. Future Class II changes are planned for this unit for additional Multi-carrier operation and Release 16 should be testable at that time.

4.2.1 Modulation Characteristics Measurement

The measurements were performed at a distance of 4.5 m from the unit utilizing the test configuration in Figure 4.4.1 utilizing a Rohde & Schwarz FSW - 85 with the 3GPP 5G-NR DL Measurement software options. Representative screen plots of the modulation measurement are attached below for all three of the subcarrier configurations and sample polarizations. Data was collected for each of the tested configurations.

4.2.2 Modulation Measurements Results:

The typical measured modulation characteristics of the EUT are shown below:

Figure 4.2 Modulation Results

Sample QPSK

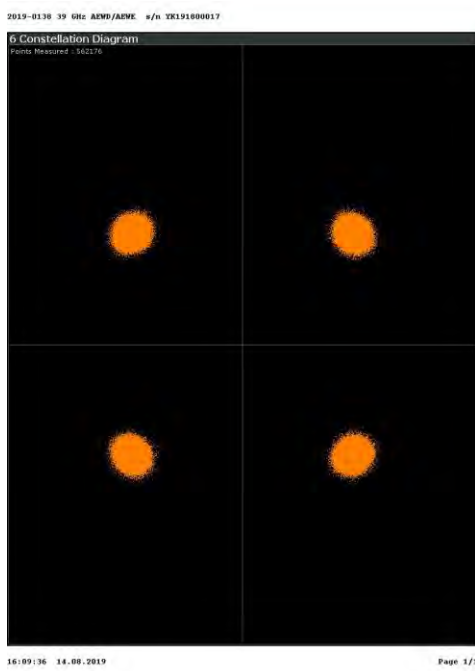

Sample 16QA64

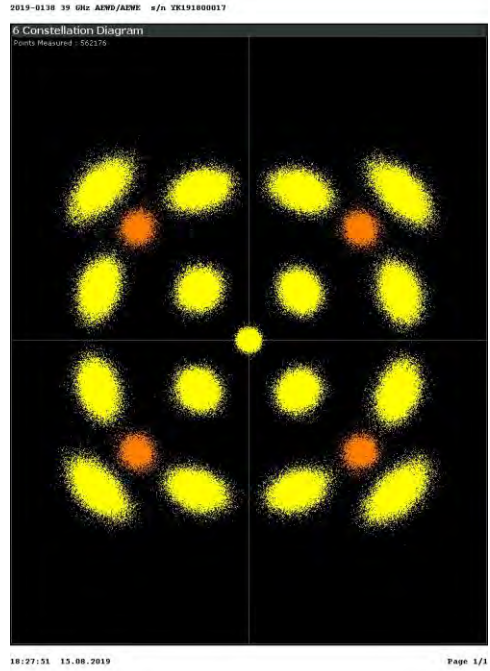

Sample 64QAM

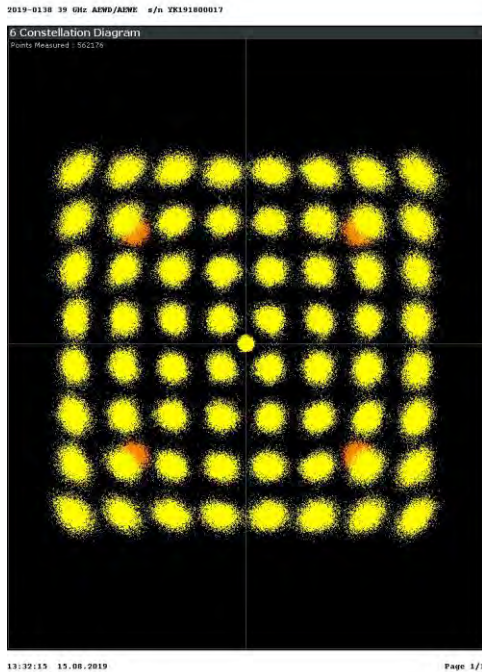

4.3 Section 2.1049 MEASUREMENT REQUIRED: OCCUPIED BANDWIDTH and EDGE of BAND EMISSIONS

This test measures the Occupied Bandwidth of the transmitting carrier and the Edge of-Block Emissions in the frequency spectrum immediately outside and adjacent to the transmitting carrier(s).

For this test the occupied bandwidth (OBW) is defined as the 99% power OBW or a relative OBW. The 99% OBW is the signal bandwidth such that, below its lower and above its upper frequency limits, the mean power radiated or conducted are each equal to 0.5 percent of the total mean power radiated or conducted by a given emission. The relative -26 dB OBW is defined as the width of the signal between two points, one below the carrier center frequency and one above the carrier center frequency, outside of which all emissions are attenuated by at least 26 dB below the transmitter power.

Per KDB 971168 D01 v03r01, the relative OBW must be measured and reported when it is specified in the applicable rule part; otherwise, the 99% OBW shall be measured and reported. The OBW shall be measured per Subclause 5.4.4 of ANSI C63.26-2015 and when modulated by an input signal such that its amplitude and symbol rate represent the maximum rated conditions under which the equipment is operated.97.5

The requirements defined in Subclause 5.4.4 of ANSI C63.26-2015 were developed for conducted measurements at the antenna terminal. Since these units do not have an antenna terminal all of the measurements performed herein were performed as radiated measurements. The use of max hold and a peak detector were not used as the FSW's internal OBW functionality was used to make the measurement. All measurements were performed with a 10 sweep average using an RMS detector. The signal bandwidth measurements were performed with a resolution bandwidths of 3 & 5 MHz for single carriers and 5 MHz and 10 MHz for multiple carriers.

4.3.1 Results Occupied Bandwidth (Signal Bandwidth)

The 99% occupied bandwidth was measured with a Rohde & Schwarz FSW spectrum analyzer using the occupied bandwidth functionality. The results for multiple configurations and modulations are tabulated in Table 4.3.1 below.

The maximum measured individual carrier bandwidth for a 5 MHz RBW was **97.89 MHz**. The measurement of 4 adjacent carriers resulted in a maximum 4 carrier bandwidth of **395.24 MHz**. The results document that the measured signals are within the parameters of the 98M0G7W emissions designator. Sample carrier measurements are documented in Figure 4.3.1 below.

Table 4.3.1 Occupied Bandwidth - Signal Bandwidth Measurements

Carrier Location in Band	Tx. Carriers Center Frequency, GHz	Number of Tx. Carriers	Modulation	Measured w/5 MHz RBW		Measured w/3 MHz RBW	
				Horizontal	Vertical	Horizontal	Vertical
				MHz	MHz	MHz	MHz
Left	37.0500	1	16QAM	96.81	97.03	95.14	95.30
Center	38.49996	1	QPSK	95.93	97.82		95.93
Right	39.94986	1	64QAM	97.26	97.89	95.50	95.97
Left	37.050, 37.14996	2	16QAM	195.46	195.78		
				Measured w/10 MHz RBW		Measured w/5 MHz RBW	
				Horizontal	Vertical	Horizontal	Vertical
Right	39.75006, 37.85002, 39.94998	3	16QAM	297.29	301.53		
Left	37.050, 37.14996, 37.24992, 37.34988	4	64QAM	394.09	394.83	393.24	391.73
Center	38.35002, 38.44998, 38.54994, 38.64990,	4	16QAM	394.47	395.24	391.98	392.51
Right	39.65010 39.75006, 37.85002, 39.94998	4	64QAM	394.58	393.74	391.13	391.56

4.3.1.1 Results - Occupied Bandwidth Carrier Aggregation

The April 12, 2016 TCBC viewgraph package identified that Carrier Aggregation data need be supplied. This requirement is not yet formalized in a KDB for LTE, 5G-NR or UMFUS. The 4 carrier bandwidth of the AEWB is defined as follows. The individual carriers, 98.0 MHz maximum, are spaced 99.96 MHz apart and do not overlap. The overall signal bandwidth for 4 adjacent carriers is depicted in Figure 4.3.1.1. The calculated assessment is that the 4 carrier aggregated bandwidth is 397.88 MHz which translates to an appropriate aggregated emissions designator of 398MG7W. The measurement of 4 adjacent carriers documented a maximum 4 carrier bandwidth of **395.24 MHz**

Figure 4.3.1.1 Carrier Aggregation

$$\text{Total Carrier Aggregation Bandwidth} = 3(99.96) + 98.0 \text{ MHz} = 397.88 \text{ MHz} = 398\text{MG7W}$$

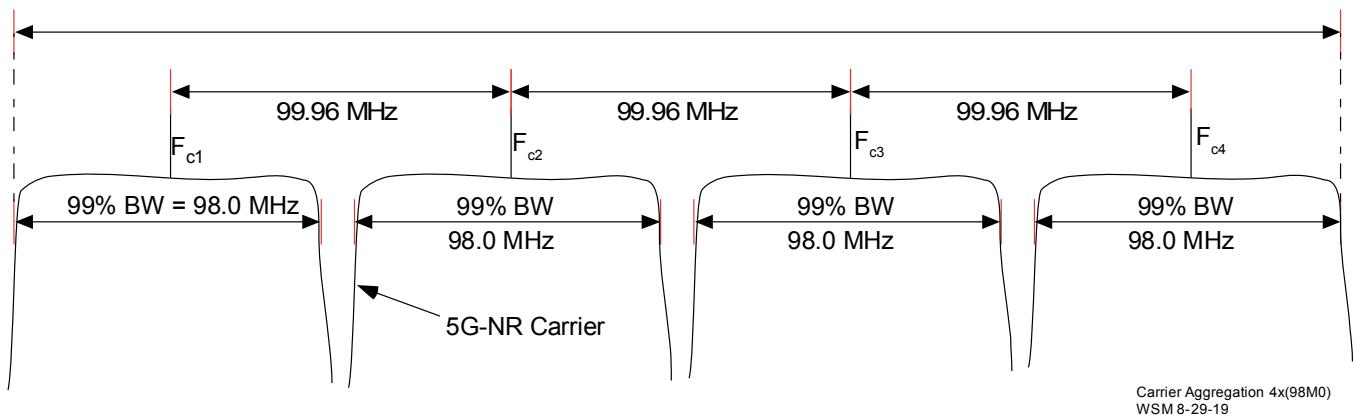

4.3.1.2 Results - Occupied Bandwidth Sample Data - 99% Signal Bandwidth

Single Carrier

99% Signal Bandwidth

5 MHz RBW 37.050 GHz

Horizontal - 16QAM

Vertical - 64QAM



99% Signal Bandwidth

38.49996 GHz

3 MHz RBW Vertical - QPSK

5 MHz RBW Vertical - QPSK



99% Signal Bandwidth

5 MHz RBW 39.94998 GHz

Horizontal - 64QAM

Vertical - 16QAM



Four Carrier
99% Signal Bandwidth - 10 MHz RBW - 4 Carrier - Left Side of Band
Horizontal - 64QAM
Vertical - 64QAM



99% Signal Bandwidth - 10 MHz RBW - 4 Carrier - Center Side of Band
Horizontal - 16QAM
Vertical - 16QAM



99% Signal Bandwidth - 10 MHz RBW - 4 Carrier - Right Side of Band
Horizontal - 64QAM
Vertical - 64QAM



4.3.2 Occupied Bandwidth-Edge of Band Emissions and Out Of Band Emissions

Classical Occupied Bandwidth – Edge of Block Emissions is an evaluation of the transmit carrier compliance with edge of band requirements and characterizes Out-Of-Band Emissions (OOBE). This measurement documents the product’s ability to maintain compliance with FCC Parts 2 and Part 30.203 limitations on emissions outside the band of operation. There are no internal blocks divisions for this band.

The 2AD8UAEWDAEWE01 39 GHz Radio Unit supports from one to four 5G-New Radio LTE TDD carriers. This evaluation addresses 2x2 MIMO operation with up to 4 carriers which are nominally 100 MHz each and are placed anywhere within the active 800 MHz operational bandwidth. In each test configuration the carriers were configured at the left, middle or right side of the Part 30 band as appropriate. All power measurements were performed prior to other measurements. Power was set to the total per polarization maximum of 48 dBm. The measurements are described below.

The occupied bandwidth of each of the signals identified in Table 4.3.6.1 was measured using a Rohde & Schwarz FSW Spectrum analyzer, a remote PC based instrumentation controller and the same calibrated RF attenuation path used for channel power. The measurement process meets the requirements of ANSI C63.26, KDB 842590 and ISO17025. The test setup was as shown in Figure 4.1.1. Measurements were performed at 4.5m for both vertical and horizontal polarizations.

Plots are provided using the triggered functionality of the test analyzer and demonstrate compliance with edge of band limits. Data is supplied for one, two, three and four carrier configurations for the Left, Center and Right side of the 39 GHz band in the Part 30 Upper Microwave Flexible Use Service spectrum.

4.3.3 Requirements 39 GHz Emissions Limits

The Limit in 47 CFR 30.203 for Emissions Limits is as follows:

- (a) The conductive power or the total radiated power of any emission outside a licensee's frequency block shall be -13 dBm/MHz or lower. However, in the bands immediately outside and adjacent to the licensee's frequency block, having a bandwidth equal to 10 percent of the channel bandwidth, the conductive power or the total radiated power of any emission shall be -5 dBm/MHz or lower.
- (b)(1) Compliance with this provision is based on the use of measurement instrumentation employing a resolution bandwidth of 1 megahertz or greater.
- (2) When measuring the emission limits, the nominal carrier frequency shall be adjusted as close to the licensee's frequency block edges as the design permits.
- (3) The measurements of emission power can be expressed in peak or average values.

In order to address the limit as imposed for the requirement in 47CFR 30.203 we evaluated emissions per the requirements in ANSI C63.26 and per KDB 842590 Upper Microwave Flexible Use Service v01. The average detector function was used with multiple sweep averaging for all measurements.

4.3.4 Measurement Offset and MIMO

As this was a radiated EIRP measurement no MIMO adjustment was used.

4.3.5 Mask Parameters

The mask parameters are in units as stated in Part 30 and are listed in Table 4.3.5. Mask parameters are as stated in Table 4.3.5. Mask Edge Offsets = ½ the measurement Resolution Bandwidth were not used.

Table 4.3.5 - Mask Parameters Out Of Band / Edge of Band Emissions

Frequency	Part 30 Limit
GHz	dBm
35.00	-13
36.00	-13
36.99	-13
36.99	-5
37.00	-5
37.00	57
40.00	57
40.00	-5
40.01	-5
40.01	-13
41.00	-13
42.00	-13

4.3.6 Measurement Path Correction

The measured power at the spectrum analyzer input was adjusted for calculated free space loss, cable loss, measurement antenna gain and the product antenna gain over its applicable frequency range as documented in Exhibit 6 of the filing and Table 4.3.6 below. This is appropriate for Out Of Band Emissions / Edge of Band emissions only for the frequency range that the transmit antenna has documentable and consistent gain. Since different products have different gain responses vs frequency, the products documentable antenna gain only applies for the operational frequency range for which the product is designed.

This adjustment was only used for the OOBE/EoB frequency range. Table 4.3.6 below lists the offset correction factors used for the measurement distance of 4.5m including the AEWB product gain. The measurements were made using a flat offset of 40 dB with a transducer correction identified below.

4.3.6.1 OOBE Sample calculation

Sample calculation: The sample calculation below is the formula and the correction for 39 GHz;

OOBE Correction Factor = Free Space Path Loss – Measurement Antenna Gain + Cable Loss – Product Gain.

The following sample calculation is the correction for 39 GHz;

$$\begin{aligned} \text{Sample calculation at 39 GHz: } \text{Correction} &= 77.33 \text{ dB} - 23.6 \text{ dBi} + 15.67 \text{ dB} - 29.60 \text{ dBi} = 39.797 \text{ dB} \\ &= \text{Offset Value (40.0 dB)} + \text{Transducer Factor (-0.203 dB)} \end{aligned}$$

All measurements were made using a flat offset of 40 dB and the transducer factor from the Table 4.3.6.

Table 4.3.6 Measurement Correction for Edge of Band / Out of Band Emissions

4.3.7 Edge of Band Measurements

The Occupied Bandwidth and Edge-of-Band emissions measurements were made as a radiated measurement at a distance of 4.5m. The measurements were performed with an FSW spectrum analyzer in compliance with the procedure and requirements of ANSI C63.26. The test set-up diagram in Figure 4.1.1 was used. Testing was performed for the nominal 100 MHz carrier configurations at the left side, center and right side of the Part 30 Band. All of the Edge of Band measurements were performed at the specified 1 MHz resolution bandwidths. Adjustment factors were as described in Section 4.3.6 above.

4.3.7.1 Results - Occupied Bandwidth Out Of Band Emissions /-Edge of Block Emissions

The Occupied Bandwidth and Edge-of-Band plots for operation at the left side, center and the right side of the band for the various multicarrier configurations are below. These include one, two, three and four carrier operation. The mask accurately depicts the limits for the Part 30 NAR Band to determine compliance with FCC requirements. From the out-of-band emissions plots attached below, it can be seen that all of the emissions are within the required emission mask and are compliant.

The results of the Occupied Bandwidth/ Edge-of-Band measurements document that the Out-Of-Band Emissions from 35 GHz to 42 GHz are compliant. The Plots and Table 4.3.7.1 demonstrate the full compliance with the Rules of the Commission for the UMFUS 39 GHz operating band.

Table 4.3.7.1 Results - Occupied Bandwidth-Edge of Block Emissions/ OOB

Carrier Location in Band	Transmit Carrier Center Frequency, GHz	Number of Transmit Carriers	Modulation	Occupied Bandwidth Edge of Block / OOB Compliance	
				Horizontal	Vertical
Left	37.0500	1	16QAM	Compliant	Compliant
Center	38.49996	1	QPSK	Compliant	Compliant
Right	39.94986	1	64QAM	Compliant	Compliant
Left	37.050, 37.14996	2	16QAM	Compliant	Compliant
Right	39.75006, 39.85002, 39.94998,	3	16QAM	Compliant	Compliant
Left	37.05000, 37.14996, 37.24992, 37.34988	4	64QAM	Compliant	Compliant
Center	38.35002, 38.44998, 38.54994, 38.64990,	4	16QAM	Compliant	Compliant
Right	39.65010, 39.75006, 37.85002, 39.94998,	4	64QAM	Compliant	Compliant

Figure 4.3.7.1 - Occupied Bandwidth - OOB/EoB Band Charts – Single Carrier

1 carrier Left Side of Band 64QAM
 OOB/EoB – H – 64QAM - 37.050GHz.

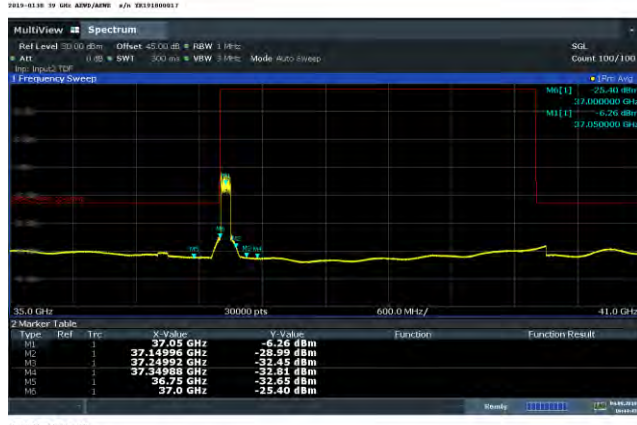

OOB/EoB – V - 64QAM - 37.050GHz



OOB/EoB – H – 64QAM - 37.050GHz.

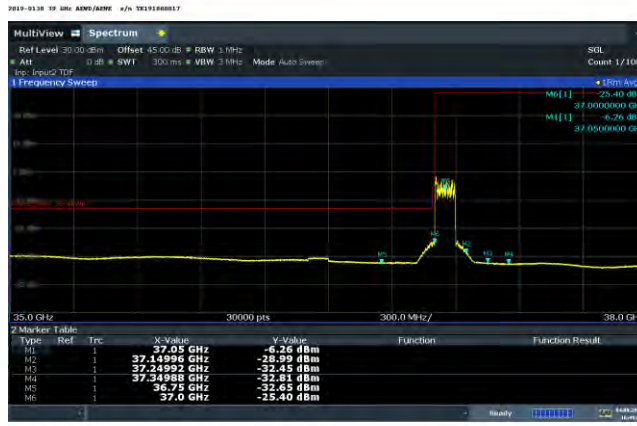

OOB/EoB – V - 64QAM - 37.050GHz

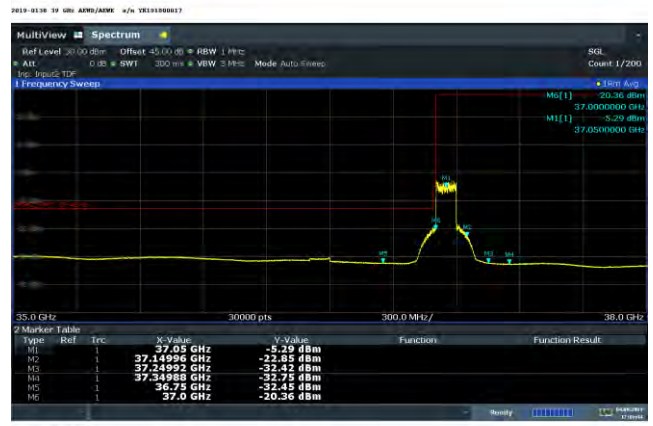

Middle of Band 64QAM
 OOB/EoB – H - 64QAM – 38.49996 GHz.



OOB/EoB – V - 64QAM - 38.49996 GHz

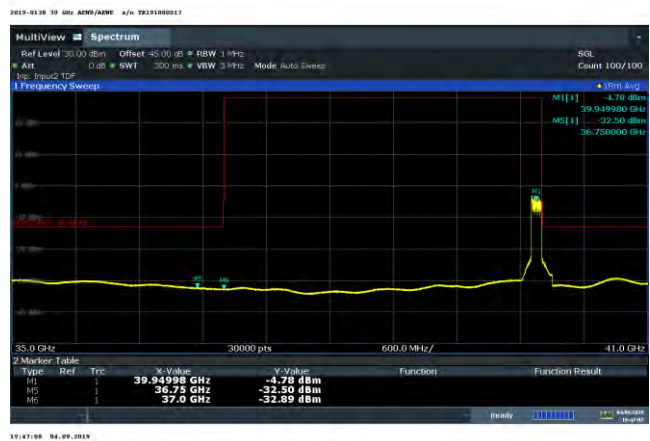

Figure 4.3.7.1 - Occupied Bandwidth - OOBE/EoB Band Charts – Single Carrier

Right Side of Band QPSK
 OOBE/EoB – H - QPSK – 39.94986 GHZ.



OOBE/EoB – V - QPSK - 39.94986 GHZ



OOBE/EoB – H - QPSK - 39.94986 GHz.



OOBE/EoB – V - QPSK - 39.94986 GHz

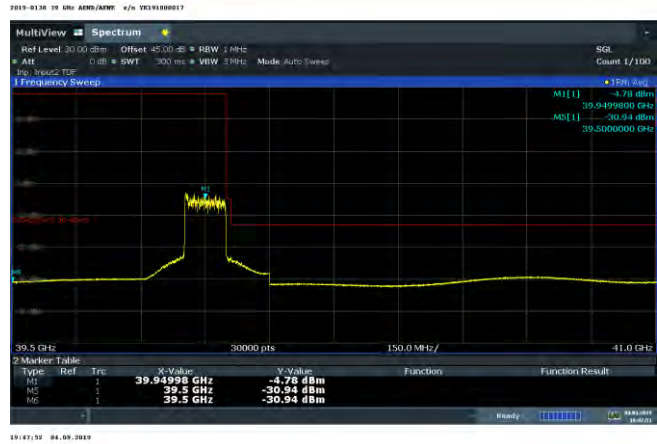

The Occupied Bandwidth and Edge-of-Band emissions measurements were made as a radiated measurement at a distance of 4.5 m

Figure 4.3.7.1 -Occupied Bandwidth - OOBE/EoB Band - Dual carrier

Left Side of Band - 64QAM - 37.050 GHz + 37.14996 GHz.
 OOBE/EoB – Horizontal Polarization

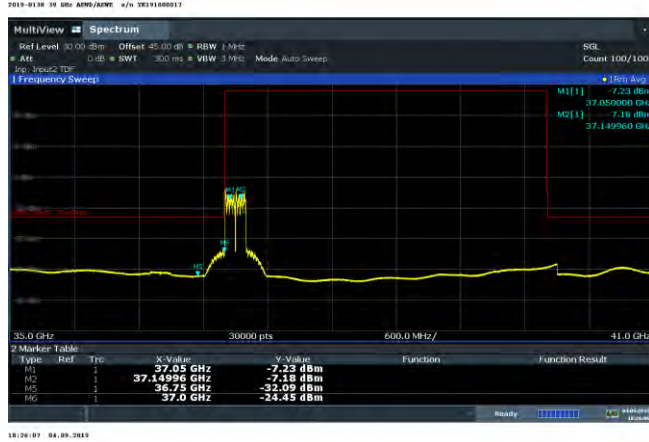

Vertical Polarization



OOBE/EoB – Horizontal Polarization



Vertical Polarization

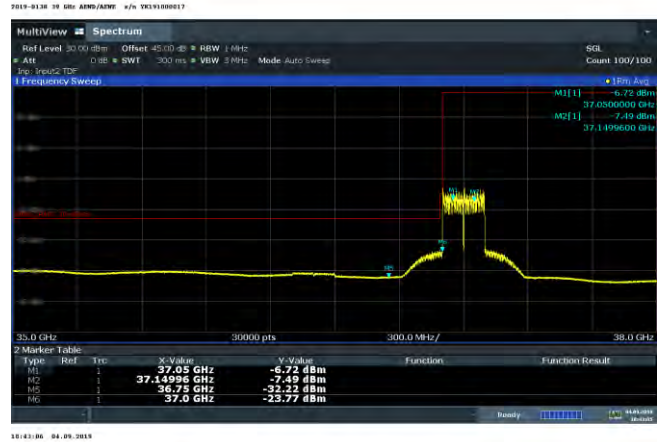
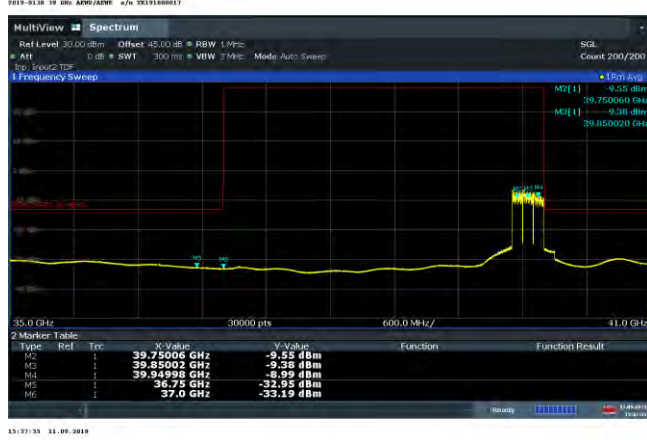

Figure 4.3.7.1 - Occupied Bandwidth - OOBE/EoB Band - Three carrier

Right Side of Band QPSK - 39.75006 GHz + 39.85002 GHz + 39.94998 GHz
 OBE/EoB – Horizontal Polarization



Vertical Polarization



OOBE/EoB – Horizontal Polarization

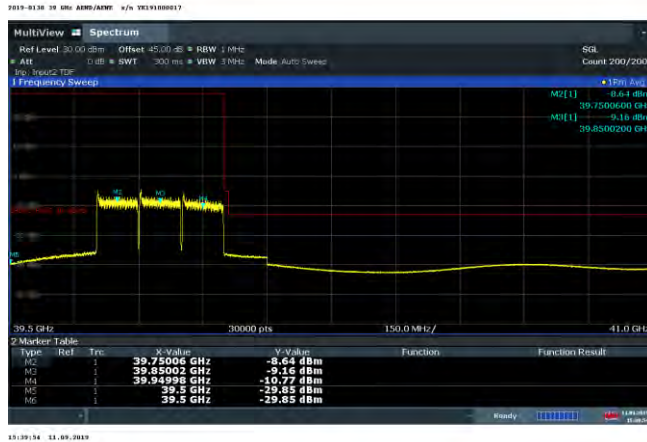

Vertical Polarization

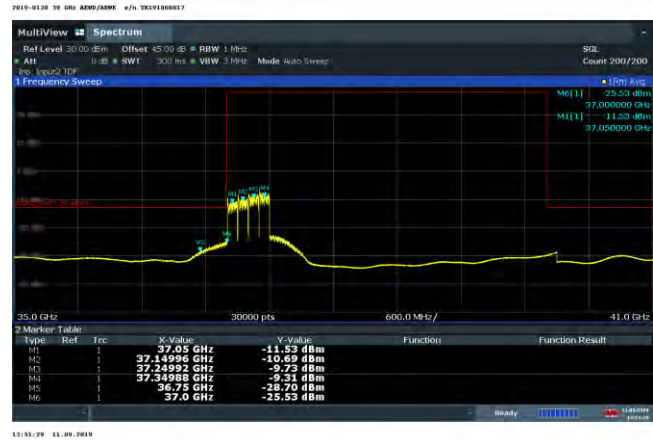

Figure 4.3.7.1 - Occupied Bandwidth - OOBE/EoB Band - Four carrier

Left Side of Band - 64QAM - 37.050 GHz + 37.14996 GHz. + 37.24992 GHz + 37.34988 GHz
 OOBE/EoB – Horizontal Polarization



Vertical Polarization



OOBE/EoB – Horizontal Polarization



Vertical Polarization



Center Channels - 64QAM - 38.35002 GHz + 38.44998 GHz + 38.549.94 GHz + 38.64990 GHz
 OOBE/EoB – Horizontal Polarization

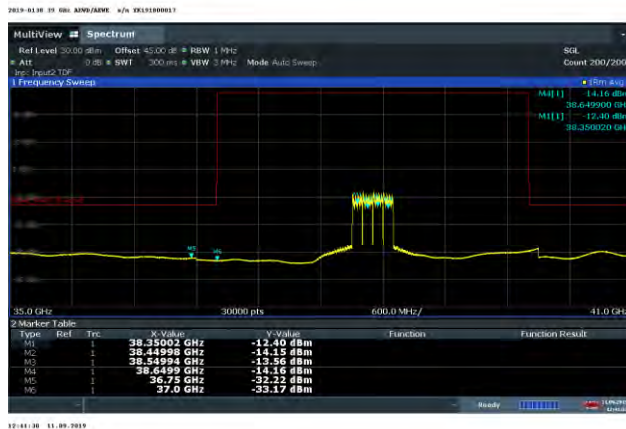

Vertical Polarization



Figure 4.3.7.1 - Occupied Bandwidth - OOBE/EoB Band - Four carrier

Right Side of Band QPSK – 39.65010 GHz + 39.75006 GHz + 39.85002 GHz + 39.94998 GHz
 OOBE/EoB – Horizontal Polarization

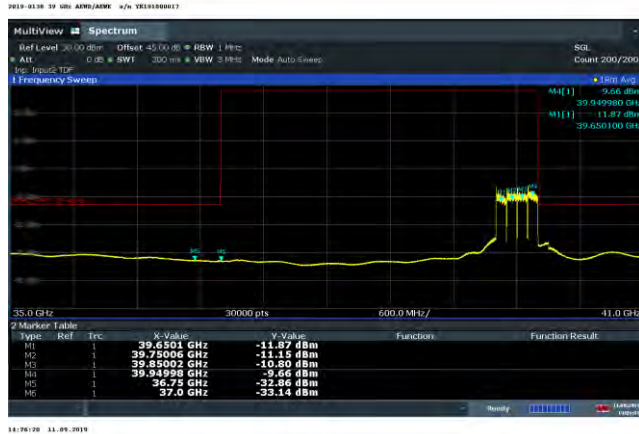

Vertical Polarization



OOBE/EoB – Horizontal Polarization

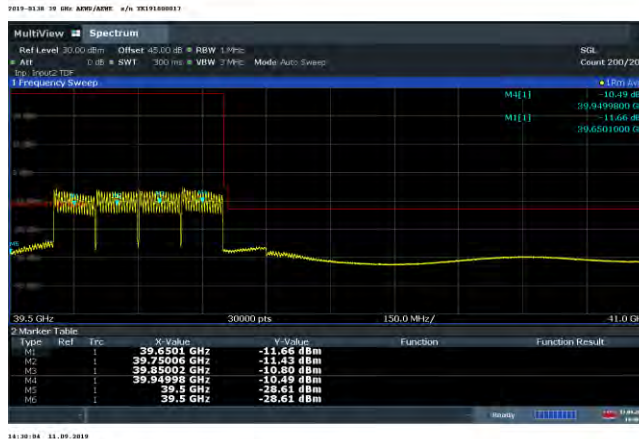

Vertical Polarization

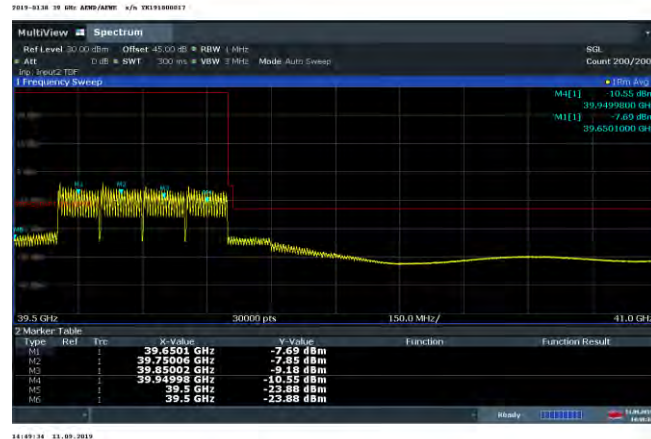

4.4 Section 2.1051 MEASUREMENT REQUIRED: SPURIOUS EMISSIONS AT THE ANTENNA TERMINALS

This test measures the emissions of spurious signals which may come from harmonic, parasitic, intermodulation and frequency conversion products and are outside the necessary bandwidth but excludes Edge-of-Band emissions.

4.4.1 Section 2.1051 Spurious Emissions at Antenna Terminals

Spurious Emissions were investigated per 47CFR Section 2.1057(a)(1) over the frequency range of 30 MHz to 200 GHz as specified in 2.1057(a)(3).

2.1057(a)(3) If the equipment operates at or above 30 GHz: to the fifth harmonic of the highest fundamental frequency or to 200 GHz, whichever is lower.

4.4.2 Required Limit

The required emission limitation specified in **47CFR 30.203 (a)** was applied to these tests. Based upon the criterion given in Section 30 of the Code and as developed in 4.3.3, the required emission limit for emissions outside a licensee's frequency block is:

47CFR 30.203 (a) (a) The conductive power or the total radiated power of any emission outside a licensee's frequency block shall be -13 dBm/MHz or lower. However, in the bands immediately outside and adjacent to the licensee's frequency block, having a bandwidth equal to 10 percent of the channel bandwidth, the conductive power or the total radiated power of any emission shall be -5 dBm/MHz or lower.

4.4.3 Results

Since there is no antenna terminal, all measurements were performed as radiated measurements and standard radiated emissions. The Edge of Band emissions, presented in Section 4.3.7.1, document the 35 - 37 GHz and 40 - 42 GHz OOB ranges. Those measurements are appropriate as the products antenna gain is documented over the same ranges. There were no emissions detected in these ranges.

The standard radiated emissions are documented in Section 4.5 "*Section 2.1053 Measurement Required: Field Strength of Spurious Radiation*". The test configuration is shown in Figure 4.4.1 documents the test set up used for the measurements.

The measurements were performed in compliance with ANSI C63.26, C63.26 mmWave JTG, KDB 842590 and our ISO17025 process. The measurement meets the ANSI C63.26 requirements in paragraphs 5.2.4.4.1 and 5.7 which requires that the number of points in the sweep be $> 2 \times \text{Span/RBW}$. The ESU-40 spectrum analyzer measurements examine the 30 MHz to 40 GHz range. The FSW based mmWave transmitter test system overlaps the transmit band for 37-40 GHz and extends the frequency range to examine the 40 GHz to 200 GHz range.

4.5 Section 2.1053 MEASUREMENT REQUIRED: FIELD STRENGTH OF SPURIOUS RADIATION

The field strength measurements of radiated spurious emissions were made in FCC registered five meter and ten meter semi-anechoic chambers AR-4 and AR-8, (FCC Registration Number: 395774) NVLAP Lab Code: 100275-0 and IC (Filing Number: 6933F-4 &-8) which is maintained by Nokia Bell Labs in Murray Hill, New Jersey.

The **2AD8UAEWDAEWE01** (EUT) was configured in the semi-anechoic chamber in a manner simulating a normal field installation. The product’s field installation hardware was used to mount the product to a wooden pole with the bottom of the product 1.5m above the turntable ground plane. The recommendations of ANSI C63.4–2014, C63.26-2015, KDB 842590 D01 and C63.26 mmWave JTG were followed for EUT testing setup and cabling. The EUT was configured to operate in a 5G-NR test model per the constraints identified in section 4.2. A photograph of this setup is in section 4.8 of this report and Exhibit 12 of the filing package.

The base station was configured into the full power forward beam transmit configuration to transmit two 48 dBm EIRP 100 MHz bandwidth 5G-NR carriers, one Vertical and one Horizontal polarization, with the total transmit power of 51 dBm EIRP. This configuration provides the highest power spectral density transmit signal for the product. The product utilizing the configurations below was evaluated over the 30 MHz to 200 GHz frequency range as required.

Table 4.5.1 EUT Configurations

Test Configuration NRARFCN	AEWB Tx Reference Frequencies MHz	Transmit Active Polarization	Nominal Signal Bandwidth, MHz	Modulation	Total Power, dBm EIRP	Radiated Emissions Pass / Fail
2229999 To 2278332	37.05000 To 39.94998	H & V	98 MHz & 398 MHz	QPSK, 16QAM & 64QAM	51	Pass

4.5.1 Spurious Radiation and Radiated Emissions Requirements Below 40 GHz.

This product meets Part 15B, and Part 30.203 requirements. FCC Part 15 Class B require emissions to be below 54.5 dBuV/m at 3m. Part 30.203 requires emissions to be below the value generated by a conducted emission of -13 dBm. This is a standard value for wireless products typically defined as

$$-43+10\text{Log}P=-13 \text{ dBm.}$$

The emissions at the Edge of Band were adjusted by the 29 dBi gain of the transmit antenna as the product is designed to operate globally over the 37 to 40 GHz frequency band. Emissions removed from the transmit band were evaluated identically to other wireless products.

Measurements were performed in compliance with Section 2.1053, FCC publication 442401, the requirements detailed above and clause 5.5 of ANSI C63.26. For this case the evaluation of acceptable radiated field strength is as follows.

The calculated emission levels were found by:

$$P_{\text{meas}} \text{ (dBm)} + \text{Cable Loss(dB)} + \text{Antenna Factor(dB)} + 107 \text{ (dB}\mu\text{V/dBm)} - \text{Amplifier Gain (dB)} = \text{Field Strength (dB}\mu\text{V/m)}$$

Title 47CFR section 30.203 and 2.1053 contains the requirements for the levels of spurious radiation as a function of the EIRP of the modulated carrier with 100 MHz of bandwidth. The reference level for the modulated carrier is calculated as the field produced by an isotropic radiator excited by the transmitter output power according to the following relation taken from Reference Data for Radio Engineers, page 27-7, 6th edition, IT&T Corp.

$$E = (120\pi P)^{1/2} = [(30 * P)^{1/2}] / R$$

$$20 \log (E * 10^6) - (43 + 10 \log P) = 82.23 \text{ dB } \mu\text{V/meter}$$

Where: E = Field Intensity in Volts/ meter R = Distance in meters = 3 m
 P = Transmitted Power, Watts

The field strength of radiated spurious emissions measured was determined by

$$E \text{ (dB}\mu\text{V/m)} = V_{\text{meas}} \text{ (dB}\mu\text{V)} + \text{Cable Loss (dB)} + \text{Antenna Factor (dBi/m)}.$$

Field strength measurements of radiated spurious emissions were made in the 5m semi-anechoic chamber, AR-4 as detailed above. The recommendations of ANSI C63.4 and ANSI C63.26 were followed for EUT testing setup, cabling, and measurement approach and procedures. All the measurement equipment used, including antennas, was calibrated in accordance with ISO 9001 process. The EUT setup diagram is given in the Figure 4.5. The minimum margins to the Part 30.203 limit is as measured in accordance with 2.1053. The test data follows.

Figure 4.5 Radiated Emissions Product Setup

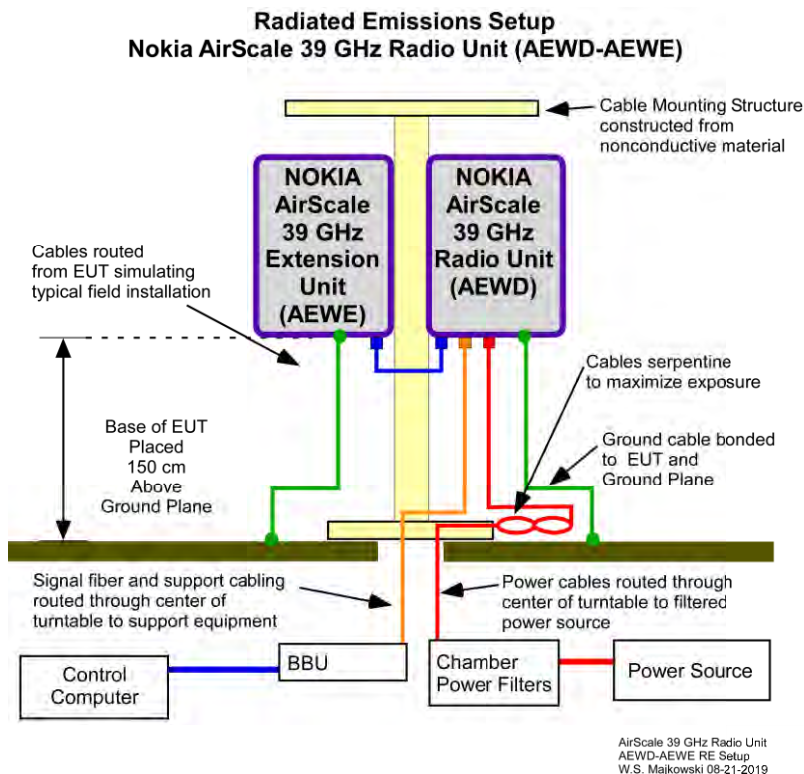

4.6 Radiated Emissions Measurement Procedure

For radiated emissions electromagnetic field, the emission level was measured in the specified frequency range and to the appropriated limits for radiated interference. EMC emissions measurements and test procedures were performed in accordance to the standards specified in the reference list.

Preliminary (prescan) measurements are typically performed inside a semi-anechoic room at a test distance of 3 meters unless otherwise noted. These results were used as guidance for the final emission measurement.

4.7 Normalized Site Attenuation (NSA) Measurements CISPR 16-1-4 ANSI C63.4

Our EMC Chamber NSA is measured in accordance with CISPR 16-1-4 and ANSI C63.4 requirements for semi anechoic chambers in the frequency range from 30 MHz to 1 GHz with broadband antennas in horizontal polarization at 1 m and 2 m height and in vertical polarization at 1 m and 1.5 m height. The volumetric test method is applied. Test distance: 3 m or 10 m, were performed based upon the EMC Chamber. The height scan of the receive antenna is carried out in the range of 1 to 4 m above ground plane.

4.7.1 Site VSWR CISPR 16-1-4

The Site VSWR measurement is done in the frequency range from 1 GHz to 18 GHz using broadband omni-directional antennas in horizontal and vertical polarization. The volumetric test method is applied from a 3 m test distance. The ground plane is overlaid with an absorber field (grid pattern) consisting of 30 cm foam absorbing material between the EUT and the receiving antenna..

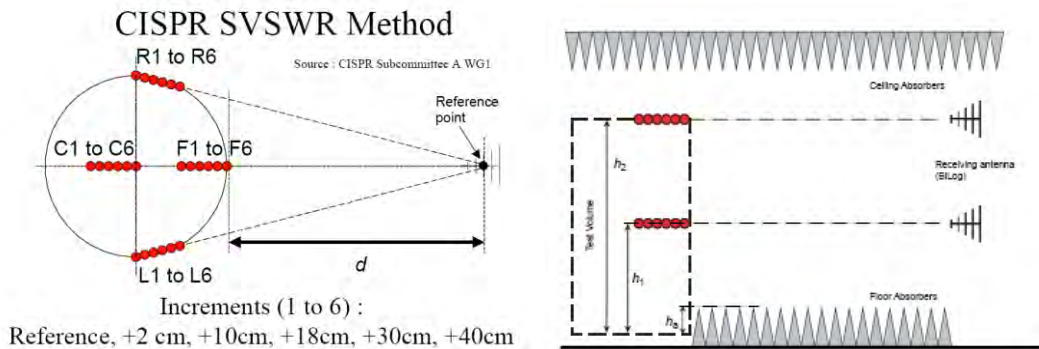

4.7.2 Special Test Considerations (General Notes)

1. The EUT was centered and located on the turntable and was raised 150cm above the ground-plane.
2. Decoupling ferrite clamps were installed on all I/O cables which interconnected with support equipment.

4.7.3 Bandwidths And Detector Functions

The bandwidth and detector functions identified below were used in the performance of the tests.

Parameter			
Frequency Range	FCC Part 15 30 to 1 GHz	FCC Part 15 1-40 GHz	FCC Parts 2 & 30 10MHz-40 GHz
Bandwidth (-6 dB)	120 kHz	1 MHz	1 MHz
Detector(s)	Peak, Quasi-Peak	Peak, Average	Peak, Average

4.8 Prescan Emission Measurement

A Windows™ based software program was used to capture the emission profiles from a spectrum analyzer. The program was used for prescan measurement, preliminary assessments and investigations. The instrument was set to the appropriate bandwidth using a peak detector with the dwell time set sufficiently on each frequency to capture the maximum emissions.

The emissions spectrum was swept through the frequency band while the analyzer was set for peak hold. The peak detection method is used to combine a worst-case measurement. During the azimuth/height prescan measurements the emission profile was monitored for a sufficient period of time to ensure that all possible signals have been recorded.

During spectrum analyzer sweep the azimuth/height prescans were performed by measuring the emissions at every 45° rotation of the EUT from a distance of 3 meters using a Bilog antenna. At each EUT position the receive antenna was placed at a fixed height from the ground plane that varied from 1 - 2 meters in 100 cm increments. The EUT angle of maximum emissions was recorded as the EUT was rotated. This procedure was performed for horizontal and vertical polarization of the antenna. Graphical and tabular results were produced to compare the results to the applicable limits.

For measurements which exceeded or were near the applicable limit the measurement at that frequency was re-measured by an azimuth/height maximization routine and using the appropriate detector with the EUT rotated through 360 degrees and the antenna height varied between 1- 2 meters. These results were then compared to the applicable limits.

4.9 Final Radiated Emissions Test Procedure - Semi Anechoic Room Shielded Chamber Final Radiated Emissions Measurements

The same software package was used to capture the emission profiles for a Spectrum Analyzer for final measurements. The program was used for a preview (prescan) measurement and then a formal test assessment. Preview mode allows the capture of the emission profiles, which range from a full sweep or a limited sweep of the test frequency range. Prior to the test the specifications limit, cable loss factors, filter loss factors, transducer /antenna factor, spectrum analyzer, sweep configuration, and the appropriate instrumentation was selected. The instrument was set to the appropriate bandwidth and detector function. The emissions spectrum was swept through the frequency band while the analyzer was set for peak hold. During the preview and formal assessment measurements the emission profile was monitored for a sufficient period of time to ensure that all possible signals have been recorded.

A personal computer was used for automation and control of the antenna, turntable, and test receiver/spectrum analyzer; and it is also used to record the final measurements. Final radiated emission

measurements were performed in the specified frequency range at a 3 m distance. Final measurement scans were made with the Bilog antenna below 1 GHz. In order to maximize emissions, measurements were made at 45 degree increments of the turntable below 1 GHz and a maximum of 22.5 degree above 1 GHz. Four antenna heights - 1, 2, 3, and 4 meters - for both vertical and horizontal antenna polarization were used for prescans below 1 GHz. The results were recorded and stored.

Emission levels of the top six frequencies within the emission limit were automatically sampled by the computer program while rotating the EUT through a complete 360 degree turntable rotation. The EUT was positioned by the program for the orientation that provided the highest level of emission. The program then automatically performed a search for a maximum emission level by moving the receiving antenna through the required elevation test range - 1 to 4 meters. The antenna was finally positioned at the polarization and height that produced the maximum emission. The frequency, EUT orientation, antenna height and polarization was recorded and stored in the computer along with the spectrum analyzer data for the amplitude of the radiated emission. The computer program adjusted the analyzer data for previously measured cable loss and antenna factors to provide the corrected radiated emission field strength level in dBuV/m which was compared directly with the radiated emission requirements.

4.10 E-Field Measurements between 18 GHz – 40 GHz

An automated software package was used to capture the emission profiles for a FSW Spectrum Analyzer for final measurements. Prior to the test the specifications limit, cable loss factors, filter loss factors, preamplifier gain, transducer /antenna factor, spectrum analyzer, sweep configuration, and the appropriate instrumentation are identified and selected. The instrument was set to the appropriate bandwidth and detector function.

For measurements above 18 GHz a Double Ridge Guide antenna or a Rectangular Horn antenna was positioned at a measurement distance of either 3 meters or 1 meter. The software program performed the preliminary measurements using full sweep measurements of the test frequency range at multiple heights and polarizations capturing the emission profiles. These preliminary emissions spectrum sweeps were performed with the analyzer set for peak hold. A formal test assessment of the maximum identified frequencies were then performed. During the preview and formal assessment measurements the emission profile was monitored for a sufficient period of time to ensure that all possible signals have been recorded.

A personal computer was used for automation and control of the antenna, turntable, and test receiver/spectrum analyzer; and it is also used to record the final measurements. Final radiated emission measurements were performed in the specified frequency range at the distance as recorded. Preliminary and Final measurement scans were made with the same antenna. In order to maximize emissions, preview measurements were made at a turntable azimuth and antenna height increments based upon the beam-width of the antenna. Measurements were made between 1 to 4 meters for both vertical and horizontal antenna polarization. The results were recorded and stored.

Emission levels of the top six frequencies within the emission limit were automatically sampled by the computer program while rotating the EUT through a complete 360 degree turntable rotation. The EUT was positioned by the program for the orientation that provided the highest level of emission. The program then automatically performed a search for a maximum emission level by moving the receiving antenna through the required elevation test range 1 to 4 meters. The antenna was finally positioned at the polarization and height that produced the maximum emission. The frequency, EUT orientation, antenna height and polarization was recorded and stored in the computer along with the spectrum analyzer data for the amplitude of the radiated emission. The computer program adjusted the analyzer data for previously

measured cable loss and antenna factors to provide the corrected radiated emission field strength level in dBuV/m which was compared directly with the radiated emission requirements.

4.10.1 Low Pass filter for E-Field Measurements between 26.5 GHz – 37 GHz

Radiated Emissions measurements from 35-37 GHz were performed using a 25 dB gain horn antenna, a low loss RF cable , a low pass filter and a Rohde & Schwarz FSW67 spectrum analyzer. The 39 GHz low pass filter, E1361, was used to attenuate the Transmit carrier when making measurements below 37 GHz. The factors were entered as part of the transducer factors in the software program. The filters 3dB corner is at 36.6 GHz while the loss at 37 GHz is just 3.3 dB. A plot of the response is in Figure 4.10.1 below.

Figure 4.10.1 Insertion Loss of 39 GHz low pass filter, E1361

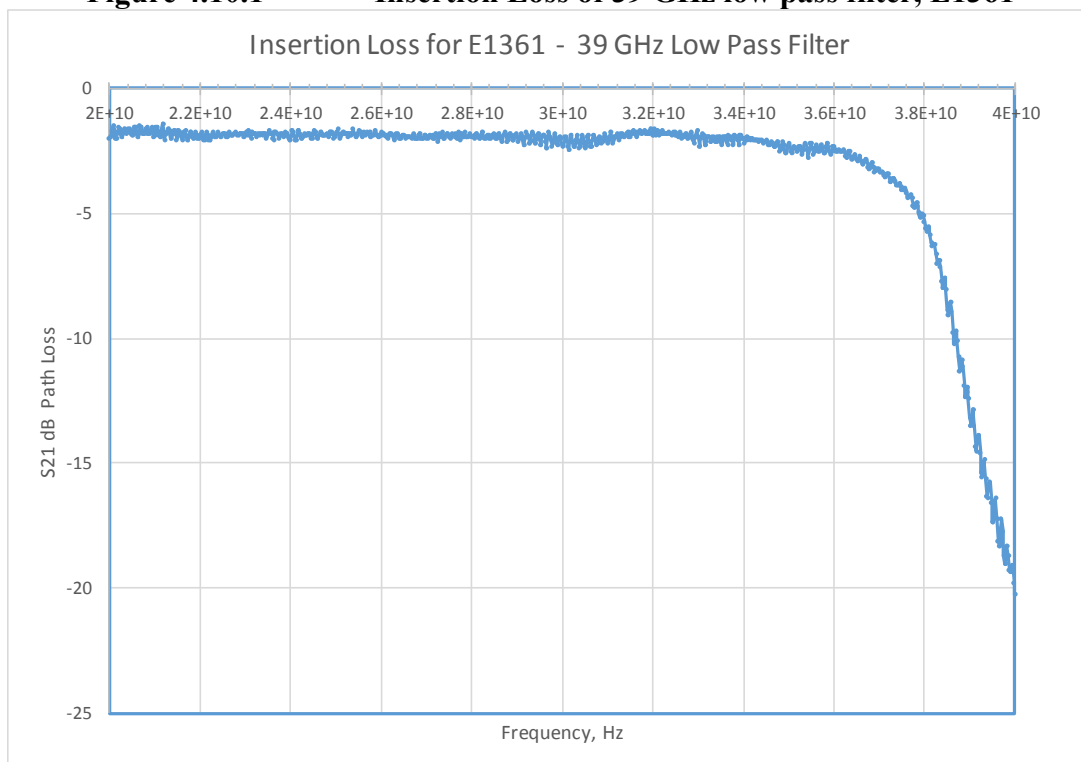

4.10.2 Radiated Emissions Test Sample Calculation

Vasona calculates one overall correction factor for each measurement; this factor is then ADDED to the receiver/analyzer trace to correct the results. This is achieved by taking each frequency within the transducer factor file (or files) and then adding the value of each other factor at this frequency.

The following formula is used at each frequency:-

$$A = A1 + A2 + A3 + A4$$

Where

A = Overall correction factor ADDED to the receiver/analyzer trace to provide the actual result. (This is different at each frequency. The frequencies used are dictated by the values contained in the Main Transducer Factor File or **Data Set**.)

A1, A2, A3, A4 = Value of each correction factor at the relevant frequency.

Field Strength Calculations

The field strength is calculated by adding the antenna factor and cable factor to the measured reading. The basic equation with a sample calculation is as follows:

$$\text{Level} = \text{Raw} + \text{Cable Loss} + \text{AF}$$

Level = Field Strength

RAW = Receiver or Spectrum Analyzer Reading

AF = Antenna Factor & Preamp Gain

Cable Loss = Cable Attenuation Factor

Assume a receiver reading of 30 dBuV is obtained. The Antenna Factor/Preamp Gain of 7.4 dB and a Cable Factor of 1.1 dB is added giving a Field Strength of 38.5 dBuV/m.

$$\text{FS} = 30 + 7.4 + 1.1 = 38.5 \text{ dBuV/m}$$

This calculated field strength level is compared with the limits from which the margin is calculated.

4.10.3 Radiated Emissions Test Software

The Radiated Emissions test Software for the Murray Hill location is Vasona by EMISoft V2.161 and V6.061.

4.10.4 Radiated Spurious Emissions Measurements: 40 GHz - 200 GHz:

The radiated spurious emissions spectrum was investigated per 47CFR Section 2.1057(a)(1) for spurious emissions over the frequency range of 40 GHz to 200 GHz. The procedure and methodology followed the recommendations of ANSI C63.4–2014, C63.26-2015 and C63.26 mmWave JTG.

A Rohde & Schwarz FSW 67 was employed with external three port Harmonic Down Converters (HDC). The waveguide RF input converters provided coverage for 40-60 GHz (U), 60-90 GHz (E), 90-140 GHz (F) and 140-220 GHz (G) bands. The HDC's were paired with 25 dB Standard Gain Horns. A 40 GHz waveguide high pass filter was utilized to limit the transmit carrier emissions from overloading the 40-60 GHz HDC.

Operation of the harmonic down converters utilizes a swept LO with a fixed IF frequency of 1.325 GHz. The IF cable loss for the 4.5m of cable was 1.03 dB and was corrected internally to the FSW along with the Conversion loss for the harmonic down converters. Additional external shielding of the HDC's was necessary to limit carrier energy from creating immunity issues with the measurements.

Cable loss compensation for the LO cable loss was necessary to enable scan heights from 1-3 meters. The experience of this test indicated that a 3m maximum test height with this product is adequate (0.5 m above the top of product). This allowed for a reduction of the test cables length and reduce IF images which occurred at multiples of the 1.325 GHz IF frequency. Measurements were performed at the following distances:

mmWave Band	Frequency Range, GHz	Measurement distance, meters
U	40-60	4
E	60-90	4
F	90-140	3
G	140-220	3

Operation was verified prior to testing by bore-sighting a mmWave signal generator or mmWave source module with an antenna identical to the measurement antenna at the test distance. The location of the maximum beams had previously been ascertained for both vertical and horizontal polarizations. The beam is extremely narrow and radiated power is down 19 dB at just ± 7 degrees off center. All of the emissions and harmonics were found to be centered on the beam as well.

Based upon previous experience a continuous max hold (average detector) sweep of the product in elevation and azimuth was employed for full coverage scanning of the product. For these measurements, in the 5m AR-4 Chamber, for each band the scan was started at the beam peak azimuth location, and nominal elevations 186 cm for Vertical and 189 cm for Horizontal. The peak was first located for the most prominent emissions in the span. The elevation was then swept down to 1m and back up back to 3m and returned to the beam peak. The product was then rotated continuously to 360 degrees back to 0 degrees and back to 335 degrees. This method locates any emission and provides the maximum emissions but required operation without the analyzer internal noise reduction function. Peaks were noted using the marker function which were later formally measured with the required 1 MHz resolution bandwidth. Measurements for all four bands were performed this way.

4.10.4.1 Bandwidth Limits and Corrections: Radiated Measurements 40 GHz - 200 GHz,

All corrections were made to the signal level as detailed below.

4.10.4.2 Resolution Bandwidth and # of Points:

For measurements above 40 GHz we performed final measurement scans with the required 1 MHz resolution bandwidth and preliminary scans with either a 10 MHz or 3 MHz resolution bandwidth.

Final measurements were performed so that the resolution bandwidth and span limitations of ANSI C63.26 were followed so that the number of measurement points $\geq 2(\text{Span}/\text{RBW})$.

Our FSW was upgraded from the original filing and now processes 100,000 data points across the screen which allows for 50 GHz spans with a 1 MHz RBW. Multiple spans were therefore used when necessary to evaluate the peak spurious emissions detected.

4.10.4.3 Part 30 Limit:

The -13 dBm emissions limit was not adjusted in any way.

4.10.4.4 Emissions Corrections.

The measured signal was corrected by the FSW for the harmonic downconverter (HDC) conversion loss. Additionally, a correction consisting of the free space radiated Path Loss, and the measurement antenna gain was applied as a fixed offset + a transducer factor. There was no adjustment applied for the product antenna gain as these measurements are outside the transmit frequency range.

$$\text{Emissions Correction} = \text{Path Loss} - \text{Antenna Gain}$$

$$\text{Where Free Space Path Loss} = ((4\pi d/\lambda))^2$$

Table 4.5.2.4 details the corrections for the three bands.

Table 4.5.2.4a Radiated Emissions Corrections for 40-60 GHz at 4m .

Frequency GHz	λ m	Measurement Distance, d m	Path Loss dB	Rx Antenna Gain dB	Total dB	Offset dB	Transducer Factor dB
40.0	0.007500	4	76.52	21.80	54.72	55.54	-0.82
42.5	0.007059	4	77.05	22.20	54.85	55.54	-0.69
45.0	0.006667	4	77.55	22.50	55.05	55.54	-0.49
47.5	0.006316	4	78.02	22.70	55.32	55.54	-0.22
50.0	0.006000	4	78.46	23.00	55.46	55.54	-0.08
52.5	0.005714	4	78.89	23.30	55.59	55.54	0.05
55.0	0.005455	4	79.29	23.40	55.89	55.54	0.35
57.5	0.005217	4	79.68	23.60	56.08	55.54	0.54
60.0	0.005000	4	80.05	23.70	56.35	55.54	0.81

Table 4.5.2.4b Radiated Emissions Corrections for 60-90 GHz at 4m.

Frequency	λ	Measurement Distance, d	Path Loss	Rx Antenna Gain	Total	Offset	Transducer Factor
GHz	m	m	dB	dB	dB	dB	dB
60.0	0.005000	4	80.05	21.80	58.25	59.01	-0.76
65.0	0.004615	4	80.74	22.30	58.44	59.01	-0.57
70.0	0.004286	4	81.38	22.70	58.68	59.01	-0.33
75.0	0.004000	4	81.98	23.00	58.98	59.01	-0.03
80.0	0.003750	4	82.54	23.40	59.14	59.01	0.13
85.0	0.003529	4	83.07	23.60	59.47	59.01	0.46
90.0	0.003333	4	83.57	23.80	59.77	59.01	0.76

Table 4.5.2.4c Radiated Emissions Corrections for 90-140GHz at 3m.

Frequency	λ	Measurement Distance, d	Path Loss	Rx Antenna Gain	Total	Offset	Transducer Factor
GHz	m	m	dB	dB	dB	dB	dB
90.0	0.003333	3	81.07	21.90	59.17	59.79	-0.62
95.0	0.003158	3	81.54	22.20	59.34	59.79	-0.45
100.0	0.003000	3	81.98	22.60	59.38	59.79	-0.41
105.0	0.002857	3	82.41	23.00	59.41	59.79	-0.38
110.0	0.002727	3	82.81	23.30	59.51	59.79	-0.28
115.0	0.002609	3	83.20	23.63	59.57	59.79	-0.22
120.0	0.002500	3	83.57	23.83	59.74	59.79	-0.05
125.0	0.002400	3	83.92	24.00	59.92	59.79	0.13
130.0	0.002308	3	84.26	24.20	60.06	59.79	0.27
135.0	0.002222	3	84.59	24.40	60.19	59.79	0.40
140.0	0.002143	3	84.91	24.50	60.41	59.79	0.62

Table 4.5.2.4d Radiated Emissions Corrections for 140-200GHz at 3m.

Frequency	λ	Measurement Distance, d	Path Loss	Rx Antenna Gain	Total	Offset	Tranducer Factor
GHz	m	m	dB	dB	dB	dB	dB
140.0	0.002143	3	84.91	23.40	61.51	62.07	-0.56
145.0	0.002069	3	85.21	23.65	61.56	62.07	-0.51
150.0	0.002000	3	85.51	23.90	61.61	62.07	-0.46
155.0	0.001935	3	85.79	24.15	61.64	62.07	-0.43
160.0	0.001875	3	86.07	24.30	61.77	62.07	-0.30
165.0	0.001818	3	86.33	24.55	61.78	62.07	-0.29
170.0	0.001765	3	86.59	24.70	61.89	62.07	-0.18
175.0	0.001714	3	86.84	24.95	61.89	62.07	-0.18
180.0	0.001667	3	87.09	25.10	61.99	62.07	-0.08
185.0	0.001622	3	87.33	25.25	62.08	62.07	0.01
190.0	0.001579	3	87.56	25.40	62.16	62.07	0.09
195.0	0.001538	3	87.78	25.55	62.23	62.07	0.16
200.0	0.001500	3	88.00	25.70	62.30	62.07	0.23

4.10.5 Field Strength of Spurious Radiation Results 30 MHz – 37 GHz:

This product meets Part 15 limits below 1 GHz and Part 30 Requirements across the 30 MHz-200 GHz range. For the Title 47CFR section 30.203 and 2.1053 test, the field strength of any spurious radiation, measured at 3m, is required to be less than 82.23 dB μ V/meter. Emissions equal to or less than 62.23 dB μ V/meter are not reportable. Measurements from 30 MHz to 26.5 GHz were performed at 3m and there were no reportable emissions. Measurements from 26.5 GHz to 37 GHz were performed at 1m with a limit of 91.77 dBuV/m/MHz.

There was one reportable emissions below 36 GHz. The minimum margin was 8.33 dB at 34447.4 MHz. Between 36 and 37 MHz there were no detectable emissions with a minimum margin to the noise floor of 6.29 dB. All other transmitter related emissions below 36 GHz were below the Part 30 Non Report 3m limit of 62.23 dB μ V/meter.

Emissions between 37 GHz and 40 GHz were evaluated as Out Of Band Emissions in Section 4.3.2.

Presented results include the standard measurements from 26.6 GHz to 37 GHz followed by the four mmWave bands.

4.10.6 Field Strength of Spurious Radiation Results 40 GHz – 200 GHz:

For the mmWave band the worst case emissions are presented. The scans are performed with the required 1 MHz resolution bandwidth and sufficient number of points per ANSI C63.26 with markers at the frequencies of interest. The limit in the measurement is the conducted -13 dBm limit which if applied to an Isotropic radiator (0 dBi) as specified in Part 2 and Part 30.203. This level would translates to a radiated limit of 82.23 dBuV/m/MHz. Measurement corrections to displayed emissions levels consisted of only the HDC conversion loss, the Free Space Path Loss and the gain of the measurement antenna as detailed in Table 4.5.2.4.

Over the out of band spectrum investigated from 40 GHz to 200 GHz, reportable spurious emissions were detected and determined to be compliant with the Part 30 limit. The minimum margin, measured in the vertical polarization to the noise floor was a margin of 4.05 dB at 128.86386 GHz.

This demonstrates that the **AirScale 39 GHz Radio Unit (AEWB) Band 30, FCC ID: 2AD8UAEWDAEWE01**, the subject of this application, complies with FCC Part 15 Class B, and FCC Sections 2.1053, 30.203 and 2.1057 of the Rules.

4.10.7 Reportable Transmitter Measurements of Radiated Spurious Emissions 30 MHz – 36 GHz

Radiated Emissions T1-3 26.5GHz-36GHz

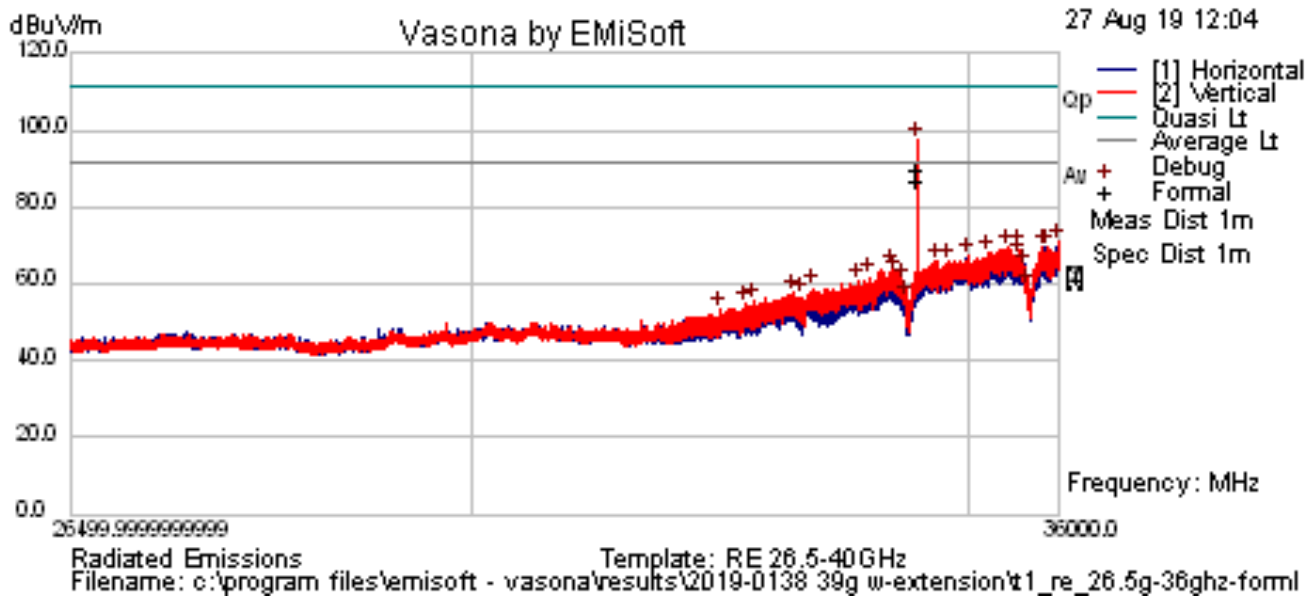

Results Title:	RE 26.5-40GHz
File Name:	c:\program files\emisoft - vasona\results\2019-0138 39g w-extension\t1_re_26.5g-36ghz-forml only 2.emi
Test Laboratory:	AR8 MH 25C, 27% RH 1016mB
Test Engineer:	MJS / JY
Test Software:	Vasona by EMISoft, version 2.161
Equipment:	Nokia Wireless Group
EUT Details:	AEWD SN-YK191800017 AEWE-SN-YK192100004 Powered by -48Vdc, 6 amps.
Configuration:	Powered by -48VDC. Tested to FCC Class B, RE 26.5GHz - 36GHz, ESU IH69, Ant-E526. LPF-E1361, Internal attenuation 0 dB, RBW-100kHz, VBW-3MHz, Formals RBW-1MHz, VBW-3MHz.
Date:	2019-08-27 12:04:10

FORMAL DATA

Freq. (MHz)	Raw (dBuV)	Cable (dB)	Factor (dB)	Level (dBuV/m)	Emission Type	Pol (H/V)	Ht (cm)	Az (deg)	Limit (dBuV/m)	Margin (dB)	Pass /Fail	Comments
34447.4	59.04	2.37	24.39	85.8	Quasi Max	V	168	333	111.77	-25.97	Pass	
34447.4	56.68	2.37	24.39	83.44	AvgMax	V	168	333	91.77	-8.33	Pass	

PREVIEW DATA

Freq. (MHz)	Raw (dBuV)	Cable (dB)	Factor (dB)	Level (dBuV/m)	Emission Type	Pol (H/V)	Ht (cm)	Az (deg)	Limit (dBuV/m)	Margin (dB)	Pass /Fail	Comments
34446.9	70.5	2.37	24.39	97.26	Preview	V	150	330	91.77	5.49	Fail	
35998.2	41.35	2.42	27.22	70.99	Preview	V	150	330	91.77	-20.78	Pass	
35823	40.31	2.42	26.77	69.5	Preview	H	175	330	91.77	-22.27	Pass	
35423.2	41.16	2.41	25.81	69.38	Preview	V	150	330	91.77	-22.39	Pass	
35876.4	39.93	2.42	26.91	69.26	Preview	V	150	330	91.77	-22.51	Pass	
35542.1	40.5	2.41	26.06	68.97	Preview	V	150	330	91.77	-22.8	Pass	
35198.3	40.08	2.4	25.41	67.9	Preview	V	150	330	91.77	-23.87	Pass	
34993.9	39.9	2.4	25.04	67.34	Preview	V	150	330	91.77	-24.43	Pass	

PREVIEW DATA

Freq. (MHz)	Raw (dBuV)	Cable (dB)	Factor (dB)	Level (dBuV/m)	Emission Type	Pol (H/V)	Ht (cm)	Az (deg)	Limit (dBuV/m)	Margin (dB)	Pass /Fail	Comments
35554.3	38.19	2.41	26.09	66.69	Preview	V	150	330	91.77	-25.08	Pass	
34788.2	38.39	2.39	24.77	65.55	Preview	V	150	330	91.77	-26.22	Pass	
34659	38.54	2.38	24.6	65.52	Preview	V	150	330	91.77	-26.25	Pass	
34194.3	37.66	2.36	24.39	64.41	Preview	V	150	330	91.77	-27.36	Pass	
35607	35.42	2.41	26.22	64.05	Preview	V	150	330	91.77	-27.72	Pass	
34203.9	36.16	2.36	24.39	62.9	Preview	V	150	330	91.77	-28.87	Pass	
33953.9	34.92	2.35	24.39	61.66	Preview	V	150	330	91.77	-30.11	Pass	
33829.9	33.88	2.34	24.38	60.6	Preview	V	150	330	91.77	-31.17	Pass	
34292	33.3	2.36	24.39	60.05	Preview	V	150	330	91.77	-31.72	Pass	
35648.5	30.23	2.41	26.33	58.97	Preview	V	150	330	91.77	-32.8	Pass	
33364.5	32.04	2.32	24.35	58.71	Preview	V	150	330	91.77	-33.06	Pass	
33151.8	30.97	2.3	24.35	57.62	Preview	V	150	330	91.77	-34.15	Pass	
33228.9	29.95	2.31	24.35	56.61	Preview	V	150	330	91.77	-35.16	Pass	
34329.3	29.08	2.37	24.39	55.84	Preview	V	150	330	91.77	-35.93	Pass	
32761.6	28.95	2.28	24.06	55.29	Preview	V	150	330	91.77	-36.48	Pass	
32664.6	28.28	2.28	23.94	54.5	Preview	V	150	330	91.77	-37.27	Pass	
32404.9	27.41	2.27	23.69	53.37	Preview	V	150	330	91.77	-38.4	Pass	

Note: Preview data was measured using a peak detector to identify frequencies of interest for formal measurement. Formal data consist of all frequencies in the preview list within 6 dB of specification limit or the top six frequencies. Failure in preview data does not necessarily constitute failure in formal data.

T15 Radiated Emissions 1m 35GHz-37GHz Part 30 Final

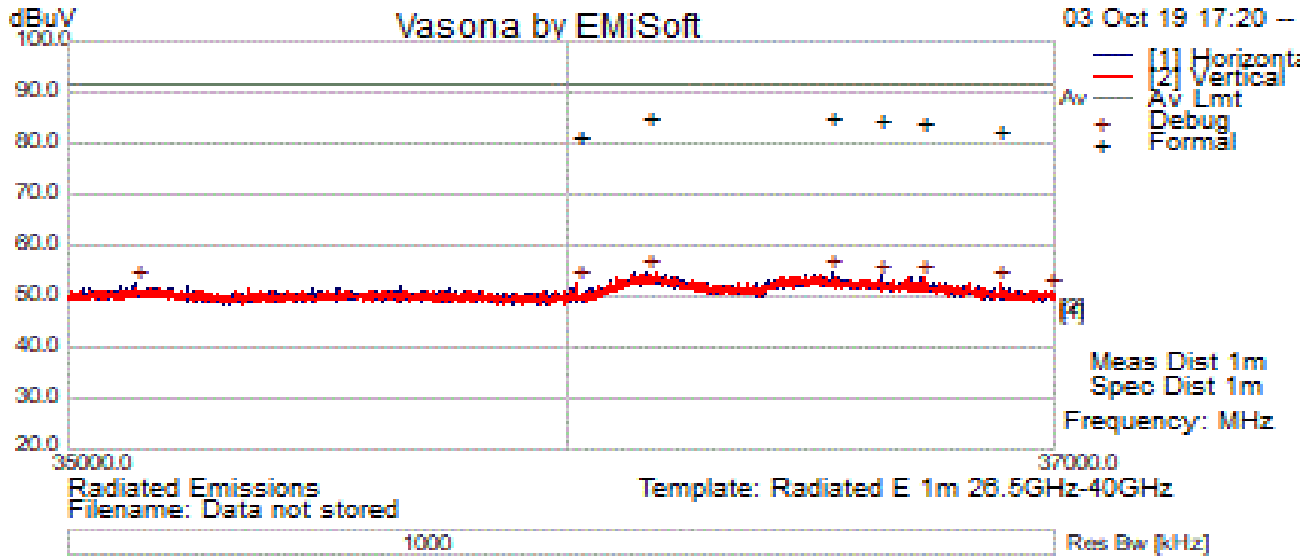

Test Information

Results Title	Radiated Emissions 1m 35GHz-37GHz
File Name	T15 RE35G-37G P30 final 1M.emi
Test Laboratory	Global Product Compliance Laboratory – AR-8
Test Engineer	MJS
Test Software	Vasona by EMISoft, version 6.061
Equipment	Nokia Wireless Group
EUT Details	2019-0138, AEWD-SNAH193300856 - IP474612A.101+ AEWE-SNAH193300846-IP-474691A.101 - AEWD and AEWE 39 GHz AirScale Radio Unit, w/IC 54.37dBm, total 57 dBm.
Configuration	Powered by -48Vdc, 9 Amps, freq- 39.94996GHz-Top of band, Antenna A-INFO E1373, Notch Filter= E1361, FSW = E1260, RE 35GHz-37Ghz @1-meter, FCC Part 30, 1 meter, 10 internal attenuation, 1M-RES BW / Default Video BW.
Date	2019-10-03 17:31:46

Formal Data

Freq. (MHz)	Raw (dBuV)	Cable (dB)	Factor (dB)	Level (dBuV/m)	Emission Type	Pol (H/V)	Ht (cm)	Az (deg)	Limit (dBuV/m)	Margin (dB)	Pass /Fail	Comments
36162.000	30.92	17.54	37.02	85.48	AvgMax	H	146	146	91.77	-6.29	Pass	Noise floor
36540.000	29.68	18.56	37.07	85.32	AvgMax	H	123	53	91.77	-6.45	Pass	
36640.000	28.88	18.77	37.08	84.73	AvgMax	H	138	326	91.77	-7.04	Pass	
36729.000	28.19	18.95	37.09	84.23	AvgMax	V	111	222	91.77	-7.54	Pass	
36884.000	26.95	18.80	37.11	82.85	AvgMax	V	155	283	91.77	-8.92	Pass	
36019.000	27.35	17.30	37.00	81.65	AvgMax	V	152	314	91.77	-10.12	Pass	

Preview Data

Freq. (MHz)	Raw (dBuV)	Cable (dB)	Factor (dB)	Level (dBuV/m)	Emission Type	Pol (H/V)	Ht (cm)	Az (deg)	Limit (dBuV/m)	Margin (dB)	Pass /Fail	Comments
36162.000	0.24	17.54	37.02	54.80	Debug	H	100	66	91.77	-36.97	Pass	
36540.000	-0.98	18.56	37.07	54.65	Debug	H	100	330	91.77	-37.12	Pass	
36640.000	-1.88	18.77	37.08	53.97	Debug	H	200	286	91.77	-37.80	Pass	
36729.000	-2.35	18.95	37.09	53.69	Debug	V	100	264	91.77	-38.08	Pass	
36884.000	-3.20	18.80	37.11	52.71	Debug	V	200	220	91.77	-39.06	Pass	
36019.000	-1.62	17.30	37.00	52.68	Debug	V	200	88	91.77	-39.09	Pass	
35134.000	-1.38	17.03	36.85	52.51	Debug	H	100	44	91.77	-39.26	Pass	
36992.000	-4.56	18.64	37.12	51.20	Debug	H	150	22	91.77	-40.57	Pass	

4.10.8 Maximum Radiated Emissions -U Band 40GHz-60GHz - 4m 1 Carrier Vertical Polarization - 1 MHz RBW - 335 Azimuth; 1.72m Elevation

2019-0130 39GHz AEWD-AEWE SNVK19100017 YK192100004

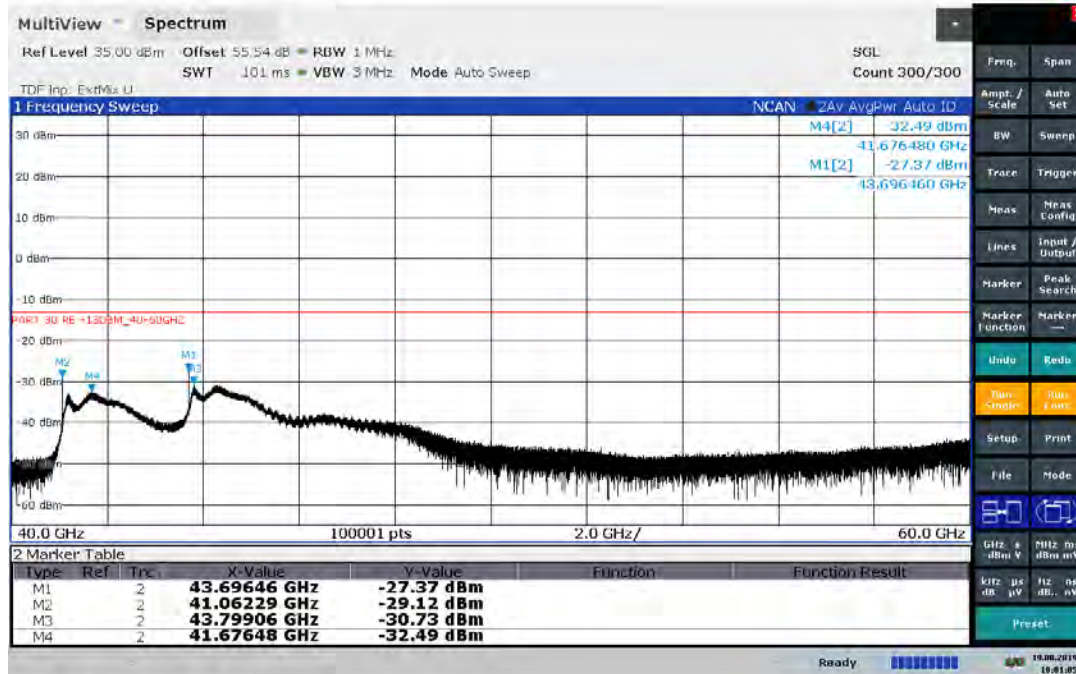

19:01:05 19.08.2019

Horizontal Polarization - 1 MHz RBW - 335 degree Azimuth; 1.72m Elevation

2019-0130 39GHz AEWD-AEWE SNVK19100017 YK192100004

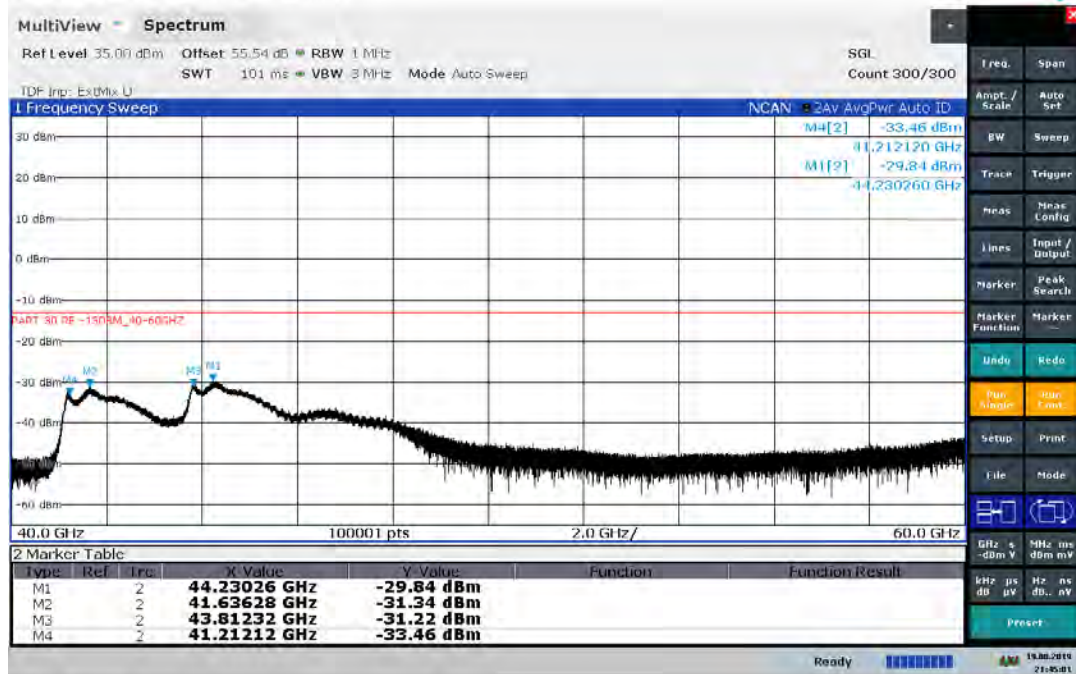

21:45:01 19.08.2019

4 Carrier –
U Band 40GHz-60GHz - 4m
Vertical Polarization - 1 MHz RBW - 335 Azimuth; 1.72m Elevation

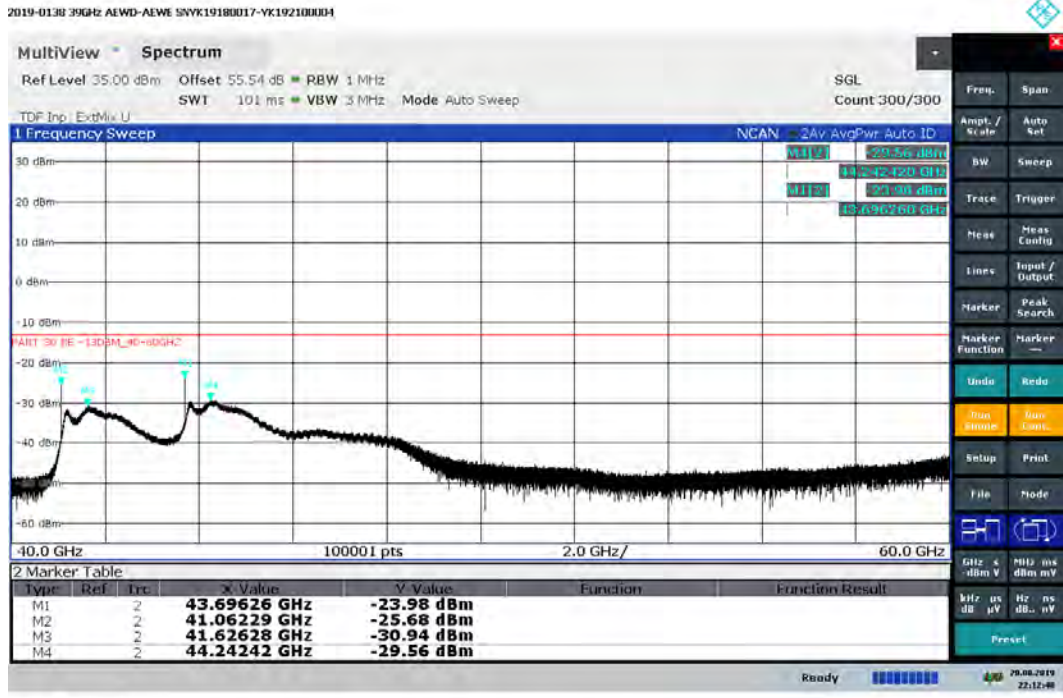

22:12:48 20.08.2019

Horizontal Polarization - 1 MHz RBW - 335 degree Azimuth; 1.72m Elevation

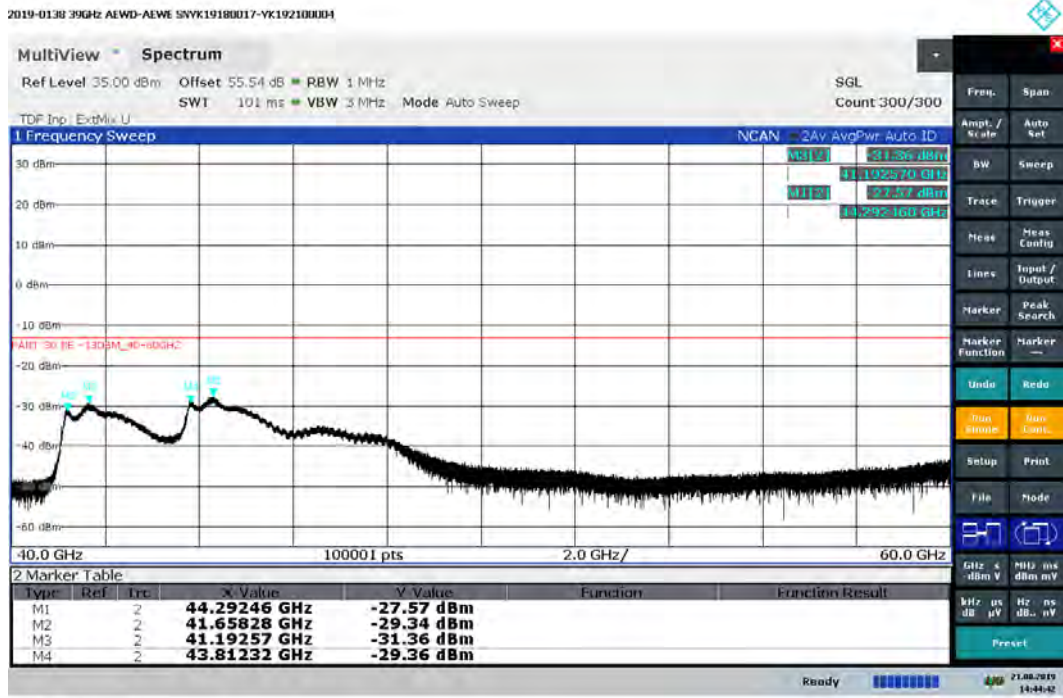

14:44:42 21.08.2019

4.10.9 Maximum Radiated Emissions -E Band 60GHz-90GHz - 4.5m

Vertical Polarization – 1 Carrier - 1 MHz RBW - 335 degree Azimuth; 1.72m Elevation

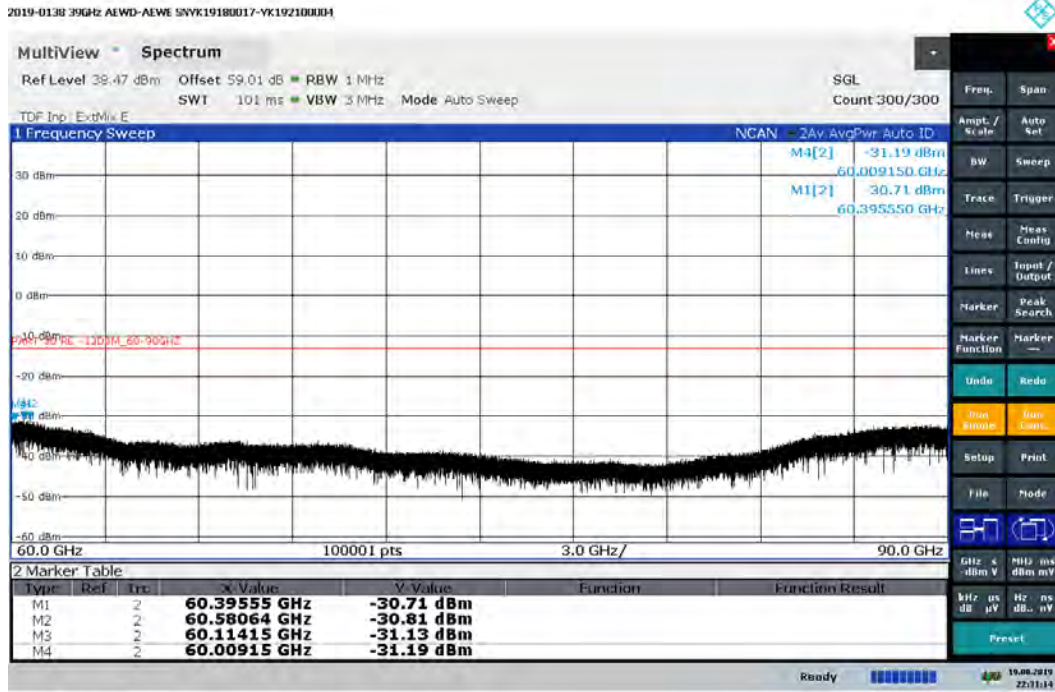

22:31:14 19.08.2019

Horizontal Polarization – 4 Carrier - 1 MHz RBW - 335 degree Azimuth; 1.72m Elevation

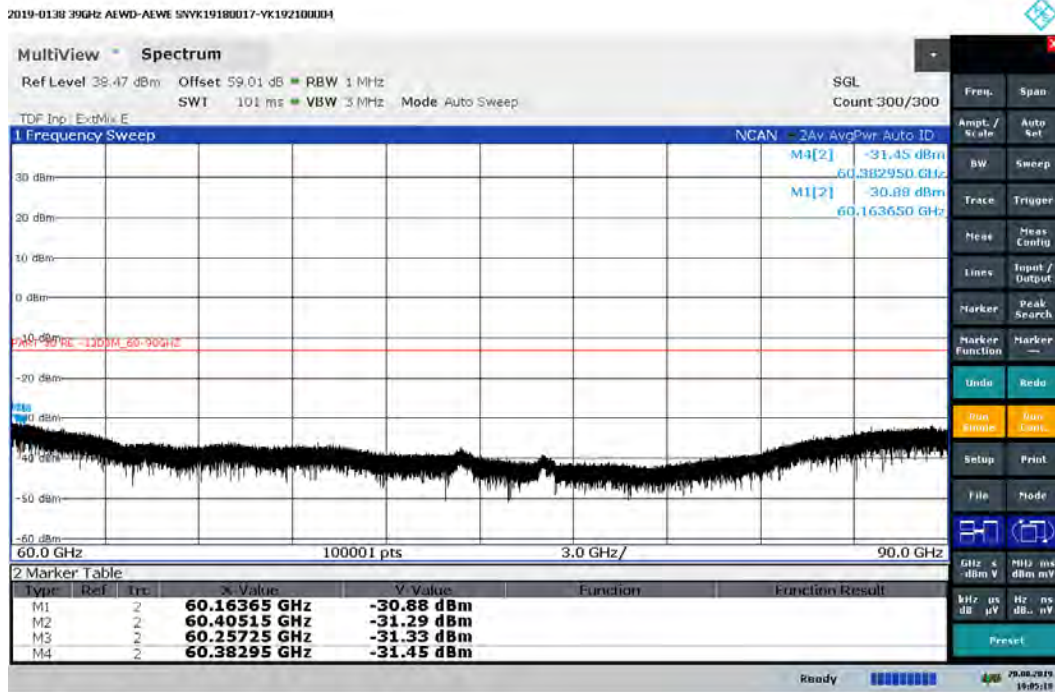

19:05:19 19.08.2019

4.10.10 Maximum Radiated Emissions -F Band 90GHz-140GHz - 3m

Vertical Polarization 1 MHz RBW - 335 degree Azimuth; 1.72m Elevation

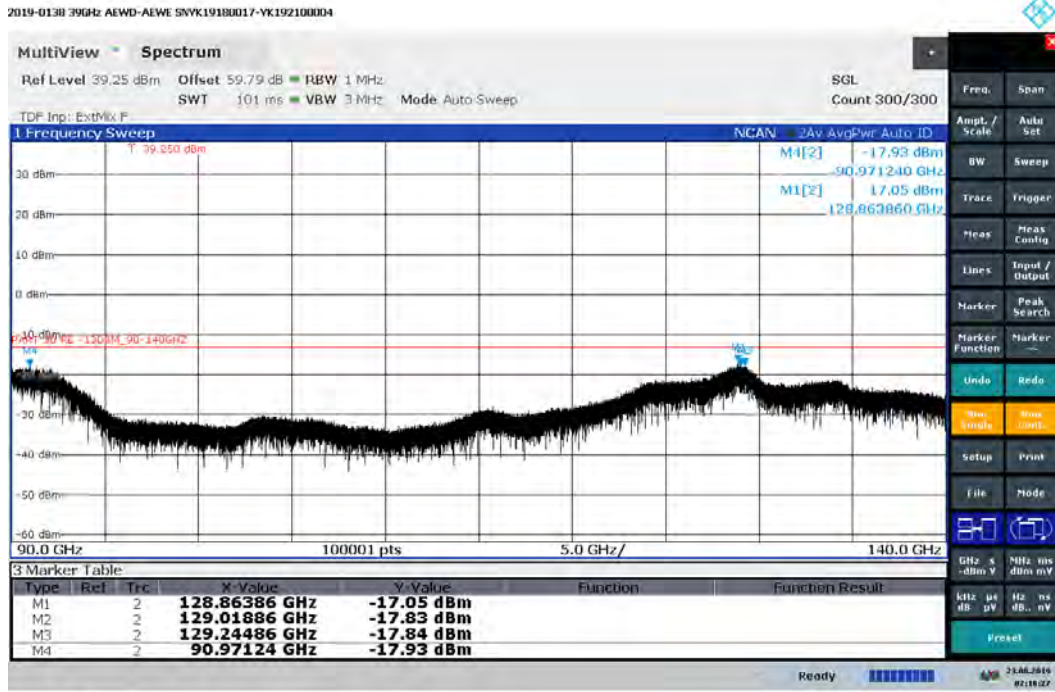

02:18:29 23.08.2019

Horizontal Polarization - 1 MHz RBW- 335 degree Azimuth; 1.72m Elevation

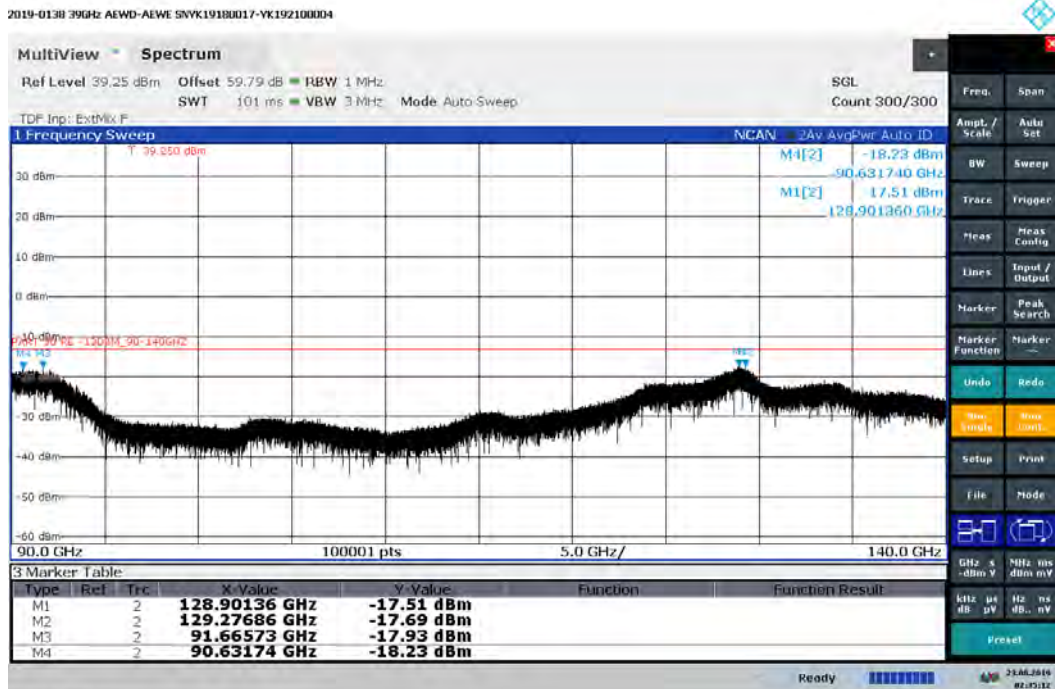

02:35:13 23.08.2019

4.10.11 Maximum Radiated Emissions - G Band 140 - 170GHz - 3m

Vertical Polarization - 1 MHz RBW - 335 degree Azimuth; 1.72m Elevation 3m

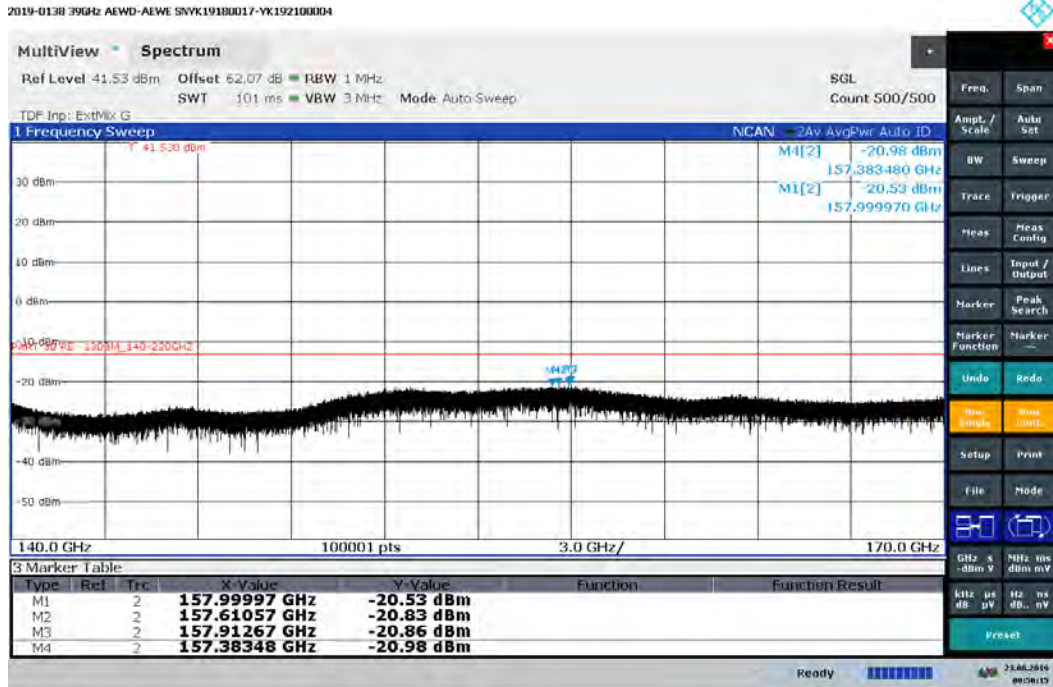

Horizontal Polarization - 1 MHz RBW- 335 degree Azimuth; 1.72m Elevation 3m

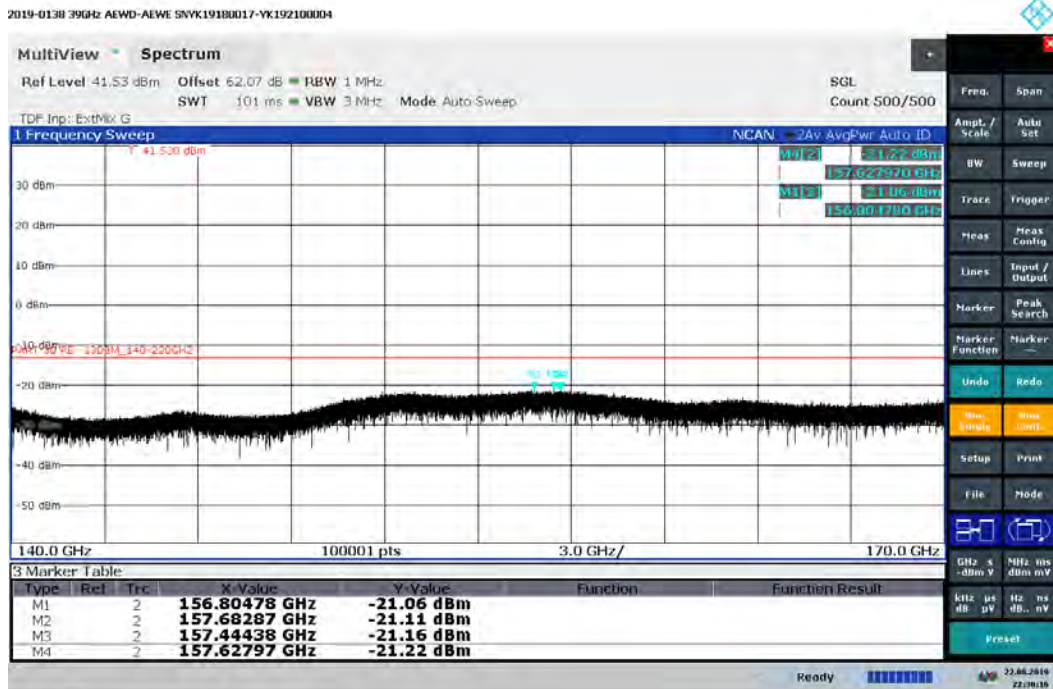

4.10.12 Maximum Radiated Emissions - G Band 170 - 200GHz - 3m

Vertical Polarization - 1 MHz RBW - 335 degree Azimuth; 1.72m Elevation

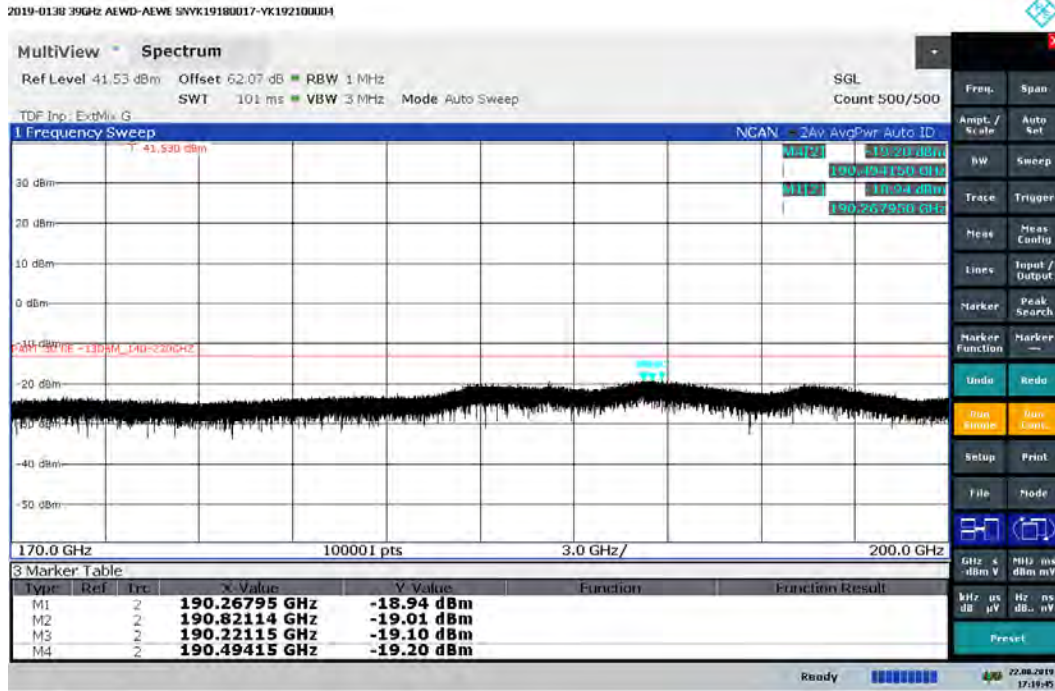

17:19:46 22.08.2019

Horizontal Polarization - 1 MHz RBW- 335 degree Azimuth; 1.72m Elevation - at 3m

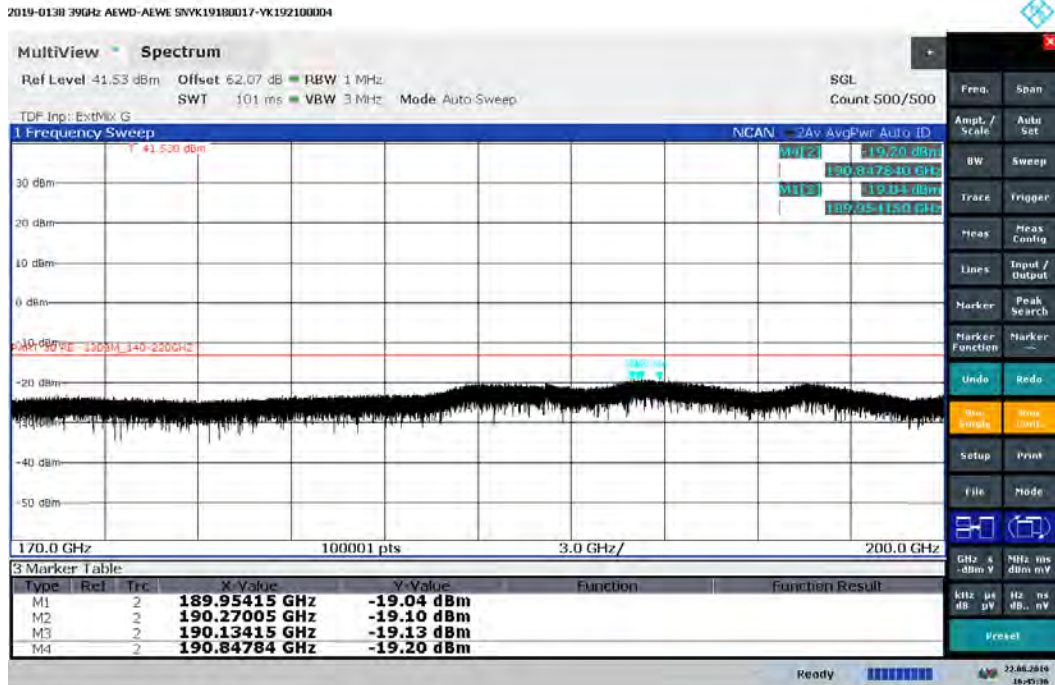

16:45:36 22.08.2019

4.11 Section 2.1055 MEASUREMENT REQUIRED: FREQUENCY STABILITY

This measurement evaluates the frequency difference between the actual transmit carrier frequency and the specified transmit frequency assignment. Only the portion of the transmitter system containing the frequency determining and stabilizing circuitry need be put in an environmental chamber and subjected to the temperature variation test per FCC Section 2.1055 and RSS-133. The unit which provides baseband signals, such as BBU (baseband unit), can be located outside the chamber if it is a separated unit.

4.11.1 Frequency Stability Test

Frequency Stability testing was completed on AEWB 39GHz Radio. The assigned frequency was 38.49996 GHz, which is in the middle. DC Powered testing of the product was performed from 08/08/2019 through 08/09/2019 of the band. AC Powered testing of the product was performed from 08/07/2019 through 08/08/2019. Both tests were performed in the T-14 Thermal chamber of the Global Product Compliance Laboratory (GPCL) test facility located in Building 4, Room 4-278, Murray Hill, NJ, and witnessed by Joe Bordonaro from GPCL.

Table 1: Unit Under Test

Series	Vendor	Serial Number	Model #
AEWD	Nokia	YK191800014	474612A.X21

Note: A fan was not installed on the radio during testing.

The temperatures to which the UUT were subjected ranged from a high temperature of +50°C system ambient to a low temperature of -30°C system ambient with measurements recorded at 10C increments.

Transmit frequency error measures the deviation between the actual transmit frequency and the assigned frequency. The transmit frequency error in this case was measured by capturing the transmitted signal using a receiving antenna and then cabling it to an MXA signal analyzer. The system level frequency stability testing resulted in compliance with established design criteria.

4.11.2 Frequency Stability – Results Summary

The worst case results of the Frequency Stability over temperature and voltage for the Product with DC Power was **360.60 Hz** which is **-0.0094 ppm**.

The worst case results of the the Frequency Stability over temperature and voltage for the Product with AC Power was **399.60 Hz** which is **0.0103 ppm**

This performance is within the +/- 0.05ppm desired performance required for LTE operation.

4.11.3 Frequency Stability Test Setups

Frequency Stability Test Setup For DC Power

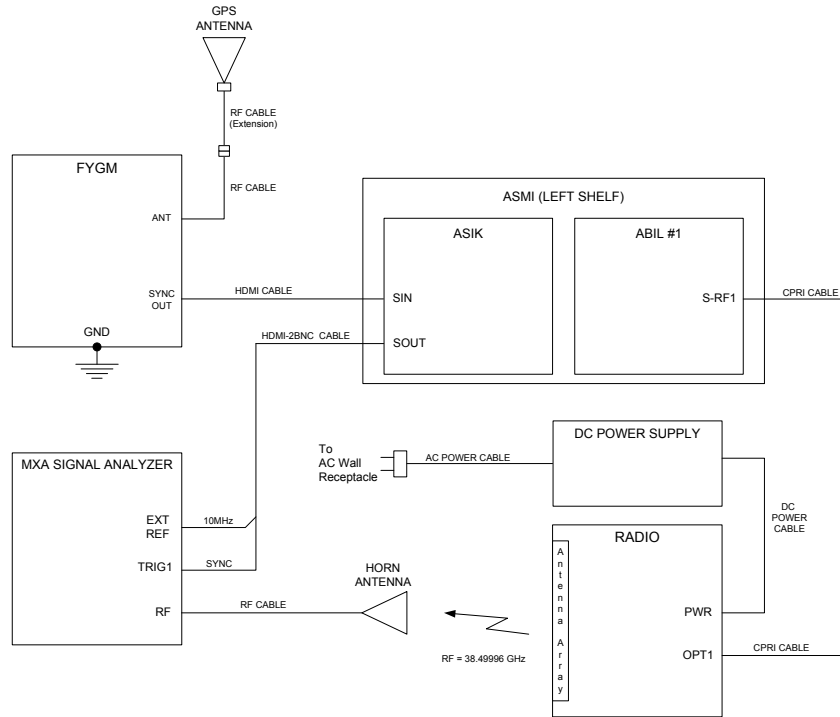

Frequency Stability Test Setup For AC Power

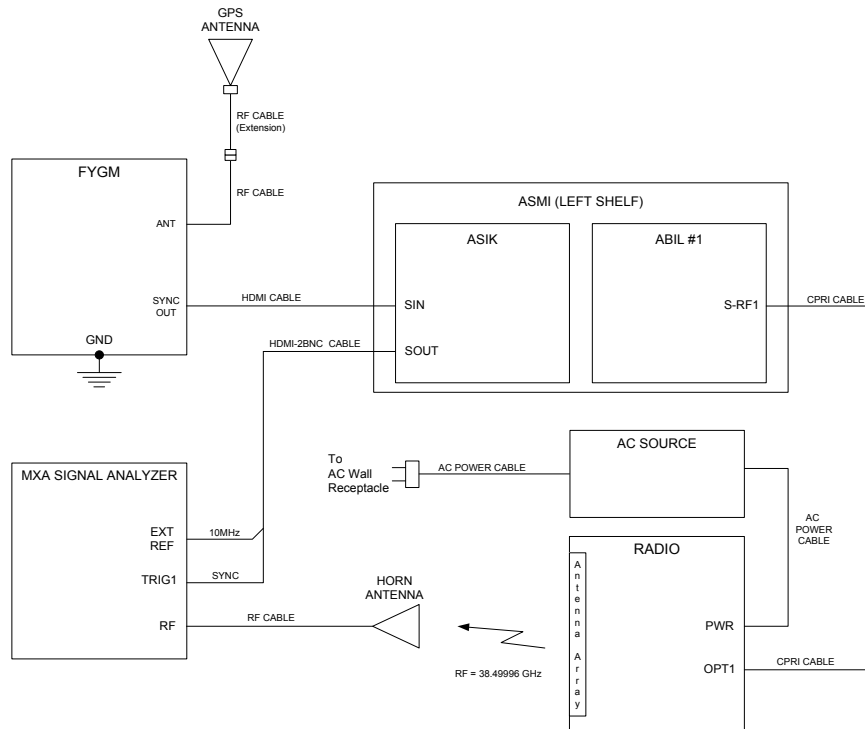

4.11.4 Frequency Stability – Data

4.11.4.1 AC Powered Data

Frequency Block Tested:– AEWD 39GHz Radio (CF = 38,4996MHz)

- (a)Set the power supply to nominal Voltage. (b) Record the frequency at ~25°C. (c)Raise EUT operating temperature to 50°C. (d)Record the frequency difference. (e) Repeat step (d) at each 10°C step down to -30°C. Result will be 10 readings and take temperature readings to establish thermal stability at each point.

Baseline Measurement at +25°C

Transmit Frequency Deviation at +25°C at 100% of Nominal Voltage, 120VAC	
Time, (minutes)	Transmit Carrier Deviation, (Hz)
0	220.89
0.5	298.03
1.0	230.50
1.5	214.31
2.0	288.00
2.5	235.05
3.0	302.37
FCC SPECIFICATION	38,499.96MHz (±0.05ppm), ±0.05ppm = ±1925Hz
FCC RESULT	Pass

Transmit Frequency Deviation at +50°C at 100% of Nominal Voltage, 120VAC	
Time, (minutes)	Transmit Carrier Deviation, (Hz)
0	227.65
0.5	302.94
1.0	249.27
1.5	304.22
2.0	247.42
2.5	214.67
3.0	241.11
FCC SPECIFICATION	38,499.96MHz (±0.05ppm), ±0.05ppm = ±1925Hz
FCC RESULT	Pass

Transmit Frequency Deviation at +40°C at 100% of Nominal Voltage, 120VAC	
Time, (minutes)	Transmit Carrier Deviation, (Hz)
0	348.75
0.5	294.02
1.0	321.05
1.5	292.50
2.0	334.74
2.5	246.64
3.0	227.97
FCC SPECIFICATION	38,499.96MHz (±0.05ppm), ±0.05ppm = ±1925Hz
FCC RESULT	Pass

Transmit Frequency Deviation at +30°C at 100% of Nominal Voltage, 120VAC	
Time, (minutes)	Transmit Carrier Deviation, (Hz)
0	225.75
0.5	159.09
1.0	183.98
1.5	249.30
2.0	157.15
2.5	191.30
3.0	216.82
FCC SPECIFICATION	38,499.96MHz (±0.05ppm) ±0.05ppm = ±1925Hz
FCC RESULT	Pass

Transmit Frequency Deviation at +20°C at 100% of Nominal Voltage, 120VAC	
Time, (minutes)	Transmit Carrier Deviation, (Hz)
0	152.43
0.5	198.84
1.0	208.37
1.5	135.81
2.0	243.65
2.5	200.17
3.0	157.11
FCC SPECIFICATION	38,499.96MHz (±0.05ppm) ±0.05ppm = ±1925Hz
FCC RESULT	Pass

Transmit Frequency Deviation at +10°C at 100% of Nominal Voltage, 120VAC	
Time, (minutes)	Transmit Carrier Deviation, (Hz)
0	221.07
0.5	177.03
1.0	213.92
1.5	196.73
2.0	168.45
2.5	219.45
3.0	255.90
FCC SPECIFICATION	38,499.96MHz (±0.05ppm) ±0.05ppm = ±1925Hz
FCC RESULT	Pass

Transmit Frequency Deviation at 0°C at 100% of Nominal Voltage, 120VAC	
Time, (minutes)	Transmit Carrier Deviation, (Hz)
0	209.61
0.5	276.55
1.0	328.05
1.5	240.32
2.0	275.99
2.5	208.04
3.0	263.71
FCC SPECIFICATION	38,499.96MHz (±0.05ppm) ±0.05ppm = ±1925Hz
FCC RESULT	Pass

Transmit Frequency Deviation at -10°C at 100% of Nominal Voltage, 120VAC	
Time, (minutes)	Transmit Carrier Deviation, (Hz)
0	199.63
0.5	223.44
1.0	189.06
1.5	237.20
2.0	185.05
2.5	240.64
3.0	259.92
FCC SPECIFICATION	38,499.96MHz (±0.05ppm) ±0.05ppm = ±1925Hz
FCC RESULT	Pass

Transmit Frequency Deviation at -20°C at 100% of Nominal Voltage, 120VAC	
Time, (minutes)	Transmit Carrier Deviation, (Hz)
0	276.97
0.5	333.92
1.0	215.85
1.5	298.44
2.0	126.74
2.5	289.92
3.0	249.79
FCC SPECIFICATION	38,499.96MHz (±0.05ppm) ±0.05ppm = ±1925Hz
FCC RESULT	Pass

Transmit Frequency Deviation at -30°C at 100% of Nominal Voltage, 120VAC	
Time, (minutes)	Transmit Carrier Deviation, (Hz)
0	209.30
0.5	273.57
1.0	182.46
1.5	250.80
2.0	104.80
2.5	-116.82
3.0	48.805
FCC SPECIFICATION	38,499.96MHz (±0.05ppm) ±0.05ppm = ±1925Hz
FCC RESULT	Pass

Upon return to +25°C.

2. At ambient, vary voltage to +15% and -15% of nominal VAC and record frequency difference. Result will be 12 readings for each voltage (nominal, ~+ 3%, ~+6%, ~+9%, ~+12%, +15%, and nominal, ~- 3%, ~-6%, ~-9%, ~-12%, -15%).

Transmit Frequency Deviation at +25°C at 100% of Nominal Voltage, 120VAC	
Time, (minutes)	Transmit Carrier Deviation, (Hz)
0	202.48
0.5	191.05
1.0	255.75
1.5	211.75
2.0	177.21
2.5	186.45
3.0	200.91
FCC SPECIFICATION	38,499.96MHz (±0.05ppm) ±0.05ppm = ±1925Hz
FCC RESULT	Pass

Transmit Frequency Deviation at +25°C at +15% of Nominal Voltage, 138.0VAC	
Time, (minutes)	Transmit Carrier Deviation, (Hz)
0	234.66
0.5	227.38
1.0	146.45
1.5	245.71
2.0	211.70
2.5	237.00
3.0	279.23
FCC SPECIFICATION	38,499.96MHz (±0.05ppm) ±0.05ppm = ±1925Hz
FCC RESULT	Pass

Transmit Frequency Deviation at +25°C at +12% of Nominal Voltage, 134.40VAC	
Time (minutes)	Transmit Carrier Deviation (Hz)
0	266.05
0.5	227.74
1.0	171.14
1.5	193.48
2.0	250.50
2.5	182.85
3.0	240.72
FCC SPECIFICATION	38,499.96MHz (±0.05ppm) ±0.05ppm = ±1925Hz
FCC RESULT	Pass

Transmit Frequency Deviation at +25°C at +9% of Nominal Voltage, 130.80VAC	
Time (minutes)	Transmit Carrier Deviation (Hz)
0	255.57
0.5	191.66
1.0	222.86
1.5	240.04
2.0	269.77
2.5	237.44
3.0	199.59
FCC SPECIFICATION	38,499.96MHz (±0.05ppm) ±0.05ppm = ±1925Hz
FCC RESULT	Pass

Transmit Frequency Deviation at +25°C at +6% of Nominal Voltage, 127.20VAC	
Time (minutes)	Transmit Carrier Deviation (Hz)
0	233.77
0.5	255.58
1.0	299.16
1.5	197.46
2.0	300.19
2.5	216.28
3.0	307.88
FCC SPECIFICATION	38,499.96MHz (±0.05ppm) ±0.05ppm = ±1925Hz
FCC RESULT	Pass

Transmit Frequency Deviation at +25°C at +3% of Nominal Voltage, 123.60VAC	
Time (minutes)	Transmit Carrier Deviation (Hz)
0	249.74
0.5	287.17
1.0	330.41
1.5	206.31
2.0	260.43
2.5	318.78
3.0	251.43
FCC SPECIFICATION	38,499.96MHz (±0.05ppm) ±0.05ppm = ±1925Hz
FCC RESULT	Pass

Transmit Frequency Deviation at +25°C at -3% of Nominal Voltage, 116.40VAC	
Time (minutes)	Transmit Carrier Deviation (Hz)
0	242.44
0.5	308.13
1.0	250.05
1.5	214.98
2.0	292.75
2.5	239.69
3.0	286.40
FCC SPECIFICATION	38,499.96MHz (±0.05ppm) ±0.05ppm = ±1925Hz
FCC RESULT	Pass

Transmit Frequency Deviation at +25°C at -6% of Nominal Voltage, 112.80VAC	
Time (minutes)	Transmit Carrier Deviation (Hz)
0	353.43
0.5	247.78
1.0	306.27
1.5	288.26
2.0	317.41
2.5	268.04
3.0	300.11
FCC SPECIFICATION	38,499.96MHz (±0.05ppm) ±0.05ppm = ±1925Hz
FCC RESULT	Pass

Transmit Frequency Deviation at +25°C at -9% of Nominal Voltage, 109.20VAC	
Time, (minutes)	Transmit Carrier Deviation, (Hz)
0	224.50
0.5	311.96
1.0	265.82
1.5	325.57
2.0	299.49
2.5	376.94
3.0	334.96
FCC SPECIFICATION	38,499.96MHz (±0.05ppm) ±0.05ppm = ±1925Hz
FCC RESULT	Pass

Transmit Frequency Deviation at +25°C at -12% of Nominal Voltage, 105.60VAC	
Time, (minutes)	Transmit Carrier Deviation, (Hz)
0	304.70
0.5	289.72
1.0	318.30
1.5	238.42
2.0	312.77
2.5	250.75
3.0	364.89
FCC SPECIFICATION	38,499.96MHz (±0.05ppm) ±0.05ppm = ±1925Hz
FCC RESULT	Pass

Transmit Frequency Deviation at +25°C at -15% of Nominal Voltage, 102.0VAC	
Time, (minutes)	Transmit Carrier Deviation, (Hz)
0	322.94
0.5	229.62
1.0	311.61
1.5	224.29
2.0	399.60
2.5	301.29
3.0	335.40
FCC SPECIFICATION	38,499.96MHz (±0.05ppm) ±0.05ppm = ±1925Hz
FCC RESULT	Pass

4.11.4.2 DC Powered Data

Frequency Block Tested: AEWD 39GHz RADIO (CF = 38,499.96MHz)

- (a) Set the power supply to nominal Voltage. (b) Record the frequency at ~25°C. (c) Raise EUT operating temperature to 50°C. (d) Record the frequency difference. (e) Repeat step (d) at each 10°C step down to -30°C. Result will be 10 readings and take temperature readings to establish thermal stability at each point.

Baseline Measurement at +25°C

Transmit Frequency Deviation at +25°C at 100% of Nominal Voltage, -48VDC	
Time, (minutes)	Transmit Carrier Deviation, (Hz)
0	334.42
0.5	224.03
1.0	264.92
1.5	326.90
2.0	230.14
2.5	248.99
3.0	263.97
FCC SPECIFICATION	38,499.96MHz (±0.05ppm), ±0.05ppm = ±1925Hz
FCC RESULT	PASS

Transmit Frequency Deviation at +50°C at 100% of Nominal Voltage, -48VDC	
Time, (minutes)	Transmit Carrier Deviation, (Hz)
0	303.23
0.5	254.27
1.0	266.38
1.5	332.10
2.0	232.15
2.5	283.50
3.0	260.62
FCC SPECIFICATION	38,499.96MHz (±0.05ppm), ±0.05ppm = ±1925Hz
FCC RESULT	PASS

Transmit Frequency Deviation at +40°C at 100% of Nominal Voltage, -48VDC	
Time, (minutes)	Transmit Carrier Deviation, (Hz)
0	268.03
0.5	231.43
1.0	264.88
1.5	299.51
2.0	328.16
2.5	251.67
3.0	273.97
FCC SPECIFICATION	38,499.96MHz (±0.05ppm), ±0.05ppm = ±1925Hz
FCC RESULT	PASS

Transmit Frequency Deviation at +30°C at 100% of Nominal Voltage, -48VDC	
Time, (minutes)	Transmit Carrier Deviation, (Hz)
0	191.46
0.5	228.37
1.0	168.80
1.5	233.77
2.0	190.16
2.5	157.80
3.0	255.24
FCC SPECIFICATION	38,499.96MHz (±0.05ppm) ±0.05ppm = ±1925Hz
FCC RESULT	PASS

Transmit Frequency Deviation at +20°C at 100% of Nominal Voltage, -48VDC	
Time, (minutes)	Transmit Carrier Deviation, (Hz)
0	210.39
0.5	251.54
1.0	164.48
1.5	201.09
2.0	271.23
2.5	200.29
3.0	287.42
FCC SPECIFICATION	38,499.96MHz (±0.05ppm) ±0.05ppm = ±1925Hz
FCC RESULT	PASS

Transmit Frequency Deviation at +10°C at 100% of Nominal Voltage, -48VDC	
Time, (minutes)	Transmit Carrier Deviation, (Hz)
0	191.04
0.5	277.31
1.0	311.41
1.5	267.68
2.0	188.45
2.5	300.21
3.0	138.84
FCC SPECIFICATION	38,499.96MHz (±0.05ppm) ±0.05ppm = ±1925Hz
FCC RESULT	PASS

Transmit Frequency Deviation at 0°C at 100% of Nominal Voltage, -48VDC	
Time, (minutes)	Transmit Carrier Deviation, (Hz)
0	256.60
0.5	202.75
1.0	285.21
1.5	220.85
2.0	316.14
2.5	255.71
3.0	209.48
FCC SPECIFICATION	38,499.96MHz (±0.05ppm) ±0.05ppm = ±1925Hz
FCC RESULT	PASS

Transmit Frequency Deviation at -10°C at 100% of Nominal Voltage, -48VDC	
Time, (minutes)	Transmit Carrier Deviation, (Hz)
0	230.31
0.5	289.69
1.0	232.82
1.5	195.11
2.0	274.29
2.5	211.64
3.0	267.24
FCC SPECIFICATION	38,499.96MHz (±0.05ppm) ±0.05ppm = ±1925Hz
FCC RESULT	PASS

Transmit Frequency Deviation at -20°C at 100% of Nominal Voltage, -48VDC	
Time, (minutes)	Transmit Carrier Deviation, (Hz)
0	299.85
0.5	236.12
1.0	270.17
1.5	222.02
2.0	287.42
2.5	301.18
3.0	237.28
FCC SPECIFICATION	38,499.96MHz (±0.05ppm) ±0.05ppm = ±1925Hz
FCC RESULT	PASS

Transmit Frequency Deviation at -30°C at 100% of Nominal Voltage, -48VDC	
Time, (minutes)	Transmit Carrier Deviation, (Hz)
0	319.59
0.5	285.65
1.0	347.22
1.5	231.50
2.0	213.08
2.5	185.64
3.0	229.31
FCC SPECIFICATION	38,499.96MHz (±0.05ppm), ±0.05ppm = ±1925Hz
FCC RESULT	PASS

Upon return to +25°C.

- At ambient, vary voltage to +15% and -15% of nominal VAC and record frequency difference. Result will be 12 readings for each voltage (nominal, ~+ 3%, ~+6%, ~+9%, ~+12%, +15%, and nominal, ~- 3%, ~-6%, ~-9%, ~-12%, -15%).

Transmit Frequency Deviation at +25°C at 100% of Nominal Voltage, -48VDC	
Time, (minutes)	Transmit Carrier Deviation, (Hz)
0	345.33
0.5	237.27
1.0	305.28
1.5	282.37
2.0	319.79
2.5	296.76
3.0	341.98
FCC SPECIFICATION	38,499.96MHz (±0.05ppm), ±0.05ppm = ±1925Hz
FCC RESULT	PASS

Transmit Frequency Deviation at +25°C at 103% of Nominal Voltage, -49.44VDC	
Time, (minutes)	Transmit Carrier Deviation, (Hz)
0	242.10
0.5	318.02
1.0	300.66
1.5	271.56
2.0	294.09
2.5	252.46
3.0	312.89
FCC SPECIFICATION	38,499.96MHz (±0.05ppm), ±0.05ppm = ±1925Hz
FCC RESULT	PASS

Transmit Frequency Deviation at +25°C at 106% of Nominal Voltage, -50.88VDC	
Time, (minutes)	Transmit Carrier Deviation, (Hz)
0	255.16
0.5	267.01
1.0	360.23
1.5	243.34
2.0	286.66
2.5	306.04
3.0	299.20
FCC SPECIFICATION	38,499.96MHz (±0.05ppm) ±0.05ppm = ±1925Hz
FCC RESULT	PASS

Transmit Frequency Deviation at +25°C at 109% of Nominal Voltage, -52.32VDC	
Time, (minutes)	Transmit Carrier Deviation, (Hz)
0	270.67
0.5	292.04
1.0	287.71
1.5	218.89
2.0	252.55
2.5	270.24
3.0	240.55
FCC SPECIFICATION	38,499.96MHz (±0.05ppm) ±0.05ppm = ±1925Hz
FCC RESULT	PASS

Transmit Frequency Deviation at +25°C at 112% of Nominal Voltage, -53.76VDC	
Time, (minutes)	Transmit Carrier Deviation, (Hz)
0	284.99
0.5	246.14
1.0	288.03
1.5	206.00
2.0	239.18
2.5	276.09
3.0	301.00
FCC SPECIFICATION	38,499.96MHz (±0.05ppm) ±0.05ppm = ±1925Hz
FCC RESULT	PASS

Transmit Frequency Deviation at +25°C at 115% of Nominal Voltage, -55.20VDC	
Time, (minutes)	Transmit Carrier Deviation, (Hz)
0	267.15
0.5	307.06
1.0	252.24
1.5	280.41
2.0	299.64
2.5	216.18
3.0	260.03
FCC SPECIFICATION	38,499.96MHz (±0.05ppm) ±0.05ppm = ±1925Hz
FCC RESULT	PASS

Transmit Frequency Deviation at +25°C at 100% of Nominal Voltage, -48.0VDC	
Time, (minutes)	Transmit Carrier Deviation, (Hz)
0	239.11
0.5	271.10
1.0	308.38
1.5	252.80
2.0	226.44
2.5	287.45
3.0	251.54
FCC SPECIFICATION	38,499.96MHz (±0.05ppm) ±0.05ppm = ±1925Hz
FCC RESULT	PASS

Transmit Frequency Deviation at +25°C at -3% of Nominal Voltage, -46.56VDC	
Time, (minutes)	Transmit Carrier Deviation, (Hz)
0	237.10
0.5	192.43
1.0	241.38
1.5	309.87
2.0	232.41
2.5	285.64
3.0	216.30
FCC SPECIFICATION	38,499.96MHz (±0.05ppm) ±0.05ppm = ±1925Hz
FCC RESULT	PASS

Transmit Frequency Deviation at +25°C at -6% of Nominal Voltage, -45.12VDC	
Time, (minutes)	Transmit Carrier Deviation, (Hz)
0	214.71
0.5	259.30
1.0	290.37
1.5	260.58
2.0	204.61
2.5	226.63
3.0	247.44
FCC SPECIFICATION	38,499.96MHz (±0.05ppm) ±0.05ppm = ±1925Hz
FCC RESULT	PASS

Transmit Frequency Deviation at +25°C at -9% of Nominal Voltage, -43.68VDC	
Time, (minutes)	Transmit Carrier Deviation, (Hz)
0	292.21
0.5	250.68
1.0	194.83
1.5	296.64
2.0	252.25
2.5	287.71
3.0	243.55
FCC SPECIFICATION	38,499.96MHz (±0.05ppm) ±0.05ppm = ±1925Hz
FCC RESULT	PASS

Transmit Frequency Deviation at +25°C at -12% of Nominal Voltage, -42.24VDC	
Time, (minutes)	Transmit Carrier Deviation, (Hz)
0	246.01
0.5	288.43
1.0	297.29
1.5	309.54
2.0	257.57
2.5	304.95
3.0	249.02
FCC SPECIFICATION	38,499.96MHz (±0.05ppm) ±0.05ppm = ±1925Hz
FCC RESULT	PASS

Transmit Frequency Deviation at +25°C at -15% of Nominal Voltage, -40.80VDC	
Time, (minutes)	Transmit Carrier Deviation, (Hz)
0	258.91
0.5	296.46
1.0	334.08
1.5	276.39
2.0	310.62
2.5	353.66
3.0	307.63
FCC SPECIFICATION	38,499.96MHz (±0.05ppm) ±0.05ppm = ±1925Hz
FCC RESULT	PASS

4.12 LIST OF TEST EQUIPMENT

4.12.1 Test Equipment Used For Radiated Emissions and Radio Measurements

The following equipment was used for the measurement of Radiated Emissions.

Table 4.7.1a Radiated Emissions and Radio Measurements

Asset ID	Manufacturer	Type	Description	Model	Serial	Cal Date	Cal Due	Cal Type
E1328	A-Info	Horn Antenna	26.5-40GHz WR28 dB	LB-28-25-C2-KF	J202023250	2018-10-16	2021-10-16	Requires Calibration
E1363	A-Info	Horn Antenna	26.5-40GHz WR28 dB	LB-28-25-C2-KF	J202062675	2018-10-16	2021-10-16	Requires Calibration
E1373	A-Info	Horn Antenna	26.5-40GHz WR28 dB	LB-28-25-C2-KF	J202062735	2018-12-05	2021-12-05	Requires Calibration
E1338r	KeySight Technologies	MXA Signal Analyzer	10 Hz-44 GHz	N9020B	MY57431033	2018-08-2	2018-08-22	Requires Calibration
E1264	KeySight Technologies	PSG Signal Generator	Analog Sig Gen 100kHz-67 GHz	E8257D	MY53402943	2017-08-28	2019-08-28	Requires Calibration
E1308	Rohde & Schwarz	Harmonic Mixer	Down Converter 90-140GHz	FS-Z140	101008	2017-04-06, Put in service 2018-07-01		Factory
E1311	Rohde & Schwarz	Harmonic Mixer	Down Converter 40-60GHz	FS-Z60	100977	2017-12-21, Put in service 2018-07-01		Factory
E1312	Rohde & Schwarz	Harmonic Mixer	Down Converter 60-90GHz	FS-Z90	101719	2017-08-09, in Put in service 2018-07-01		Factory
E1313	Rohde & Schwarz	Harmonic Mixer	Down Converter 140-220GHz	FS-Z220	100960	2017-08-09 in Put in service 2018-07-01		Factory
E1315	RS Microwave Company, Inc.	Microwave Filter		P/N 60733A	007	2018-01-17, Put in service 2018-07-01		Verification
E1H69	Rohde & Schwarz	Test Receiver	20 Hz-40 GHz	ESU40	100247	2018-05-22	2020-05-22	Requires Calibration
E1260	Rohde & Schwarz	Spectrum Analyzer	2 Hz - 67 GHz	FSW67	104007	2018-02-12	2020-02-12	Requires Calibration
E1384	Rohde & Schwarz	Spectrum Analyzer	2 Hz - 85 GHz	FSW85	101537	2018-12-17	2020-12-17	Requires Calibration
E1323	Mi-Wave Millimeter Wave Products, Inc.	Horn Antenna	G-band pyramidal horn antenna 25dB 140 - 220 GHz	261G-25/387		Put in service 2018-07-01		Factory
E1330	Sage Millimeter, Inc.	Horn Antenna	U-band pyramidal horn antenna - 40 to 60 GHz	SAR-2309-19-S2	14853-01	Put in service 2018-07-01		Factory
E1331	Sage Millimeter, Inc.	Horn Antenna	U-band pyramidal horn antenna - 40 to 60 GHz	SAR-2309-19VF-R2	14853-01	Put in service 2018-07-01		Factory
E1332	Sage Millimeter, Inc.	Horn Antenna	E-band pyramidal horn antenna - 60 to 90 GHz.	SAR-2309-12-S2	14853-01	Put in service 2018-07-01		Factory
E1335	Sage Millimeter, Inc.	Horn Antenna	F-band pyramidal horn antenna - 90 to 140 GHz	SAR-2309-08-S2	14853-02	Put in service 2018-07-01		Factory
E1340	Sage Millimeter, Inc.	Horn Antenna	Ka band pyramidal horn antenna - 26.5 to 40 GHz, 25 dB gain	SAR-2507-28-S2	15309-01	Put in service 2018-07-01		Factory

Table 4.7.1b Radiated Emissions and Radio Measurements

Asset ID	Manufacturer	Type	Description	Model	Serial	Cal Date	Cal Due	Cal Type
E812	Sonoma Instrument Co.	Amplifier	9kHz-1GHz Vasona File TRANS 261	310N	186744	2018-09-14	2020-09-14	Requires Calibration
E980	Trilithic	Low Pass Filter	PCS 0.01-2 GHz	10LC1790-3-AA	PCS-LPF-12	2018-12-01	2020-12-01	Verification
E889	Weinschel	Attenuator	6 dB DC-18GHz 5 Watt	2-6	BX3438	2018-05-23	2020-05-23	Requires Calibration
E766	A.H. Systems Inc.	Biological Antenna	25 - 2000 MHz	SAS-521-2	457	2019-02-13	2021-02-13	Requires Calibration
E526	A.H. Systems Inc.	Horn Antenna	Ridged Horn 26.5 GHz - 40 GHz	SAS-200/573	137	2017-10-04	2019-10-04	Requires Calibration
E433	EMCO	Horn Antenna	Double Ridged Horn 1-18 GHz	3115	9909-5914	2019-05-03	2021-05-03	Requires Calibration
E520	EMC Test Systems	Horn Antenna	Double Ridged Horn 18-40 GHz	3116	2537	2018-08-09	2020-08-09	Requires Calibration
E520	EMC Test Systems	Horn Antenna	Double Ridged Horn 18-40 GHz	3116	2537	2018-08-09	2020-08-09	Requires Calibration
E1150	Extech	Data Logger	Pressure Humidity Temp Data Logger	SD700	Q752767	2019-01-16	2021-01-16	Requires Calibration
E447	Hewlett Packard	Pre-Amplifier	Preamplifier 1-26.5 GHz	8449B	3008A01384	2018-04-10	2020-04-10	Requires Calibration
E1356	Hewlett Packard	Pre-Amplifier	Pre-Amplifier 1-26.5GHz	8449B	3008A01353	2018-09-10	2020-09-10	Requires Calibration
E1361	Marki Microwave	Low Pass Filter	D/C 1645	FLP-3660	N/A	2018-12-01	2020-12-01	Verification
EIH69	Rohde & Schwarz	Test Receiver	EMI 20Hz - 40GHz	ESU40	100247	2018-05-22	2020-05-22	Requires Calibration
E812	Sonoma Instrument Co.	Amplifier	9kHz-1GHz	310N	186744	2018-09-14	2020-09-14	Requires Calibration
E588	Sunol Sciences Corp	System Controller		SC99V	32802-1			Calibration Not Required
E1255	ETS Lindgren	Multi-Device Controller	Tower/Turntable Controller	2090	00078509			Calibration Not Required
E485	Kikusui	Power Supply	DC 55 Volts 120 Amps	PAD 55-120L	DL000416			Calibration Not Required

4.12.2 Frequency Stability Test Equipment

Table 4.7.2 - Instruments Used for Frequency Stability Measurement

Asset ID	Manufacturer	Type	Description	Model	Serial	Calibration Date	Calibration Due
TH536-T14	Envirotronics	Controller	Thermal Chamber Controller	SPPCM	SP001513	2019-03-14	2021-03-14
TH069	Extech	Data Logger	Barometric Pressure /Humidity /Temperature	SD700	Q690305	2019-06-20	2021-06-20
TH073	Fluke	Multimeter	Digital Multimeter	87V	25910080	2018-02-12	2020-02-12
E1338	KeySight Technologies	MXA Signal Analyzer	MXA Signal Analyzer, 10 Hz to 44 GHz	N9020B	MY57430927	2018-09-13	2020-06-13
TH-T14	Thermotron	Thermal Chamber		N/A	28431	2017-09-27	2019-09-27
TH090	Yokogawa	Data Logger	10 Channel Paperless Recorder	GP10	S5V108472	2019-05-20	2021-05-20
	Behlman	AC Power Source	Variable Voltage AC Supply	BL 1350	04824	N/A	
	TDK-Lambda	DC Source	Variable Voltage DC Supply	GEN60-85	13N1111	N/A	

4.13 PHOTOGRAPHS OF THE TEST SETUPS

Response: The photographs of the test setups for the AirScale 39 GHz Radio Unit (AEWB) Band 30, FCC ID: 2AD8UAEWDAAEWE01 are below.

4.13.1 Radiated Emissions and Radio Measurements Test Photos

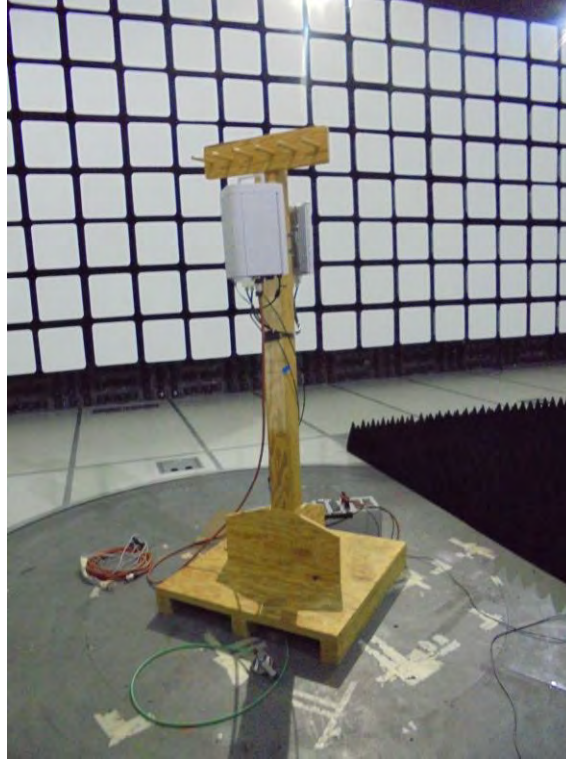

Product Set up AR-8

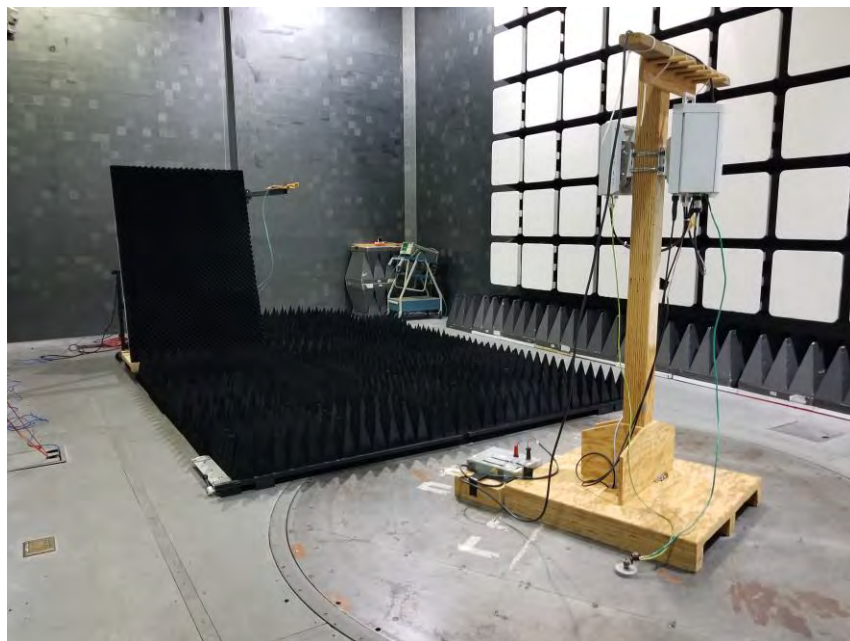

Product Set up AR-4

Base of Unit AEWD



Base of Unit AEWE



Radiated Emissions 30 MHz-1 GHz at 3m

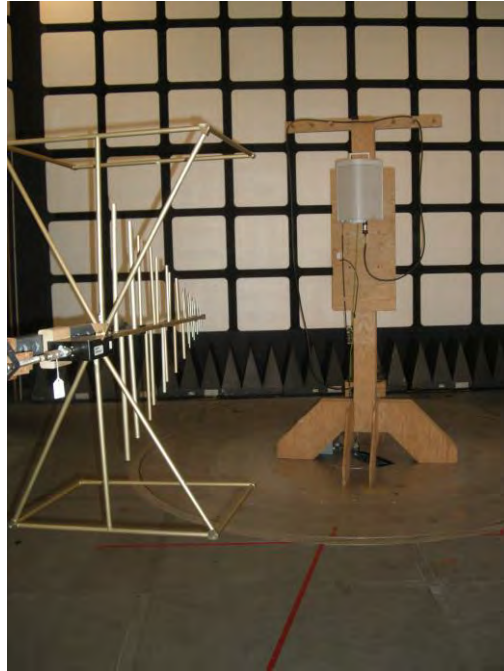

1 GHz – 18 GHz at 3m

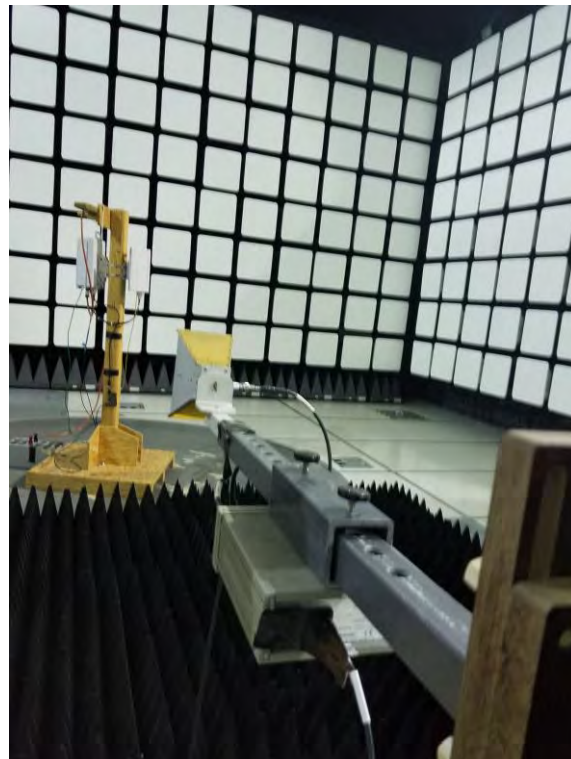

18 GHz – 26.5 GHz at 1m

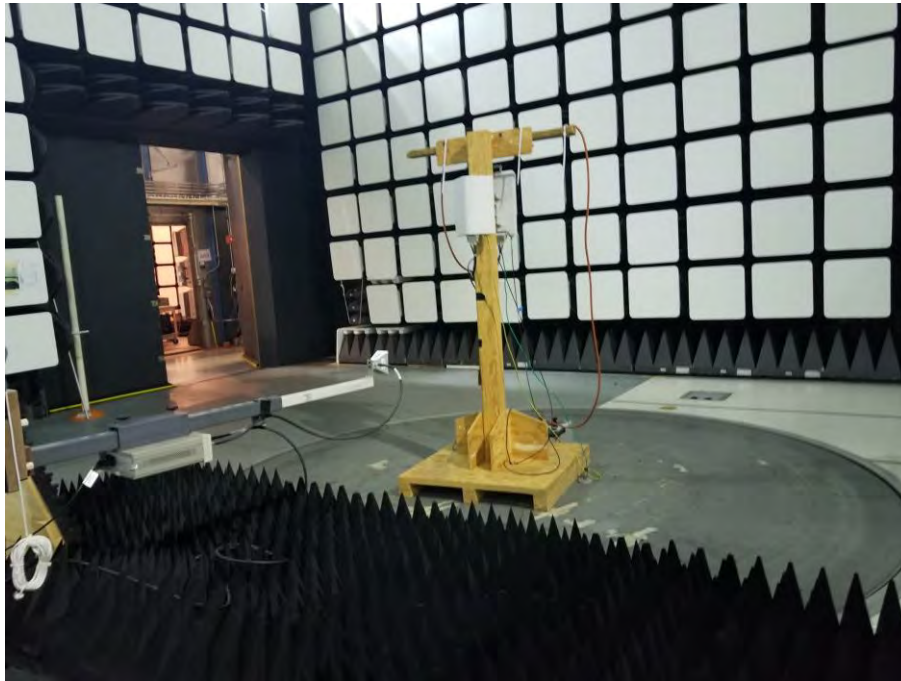

26.5 GHz – 36 GHz at 1m



40 GHz – 60 GHz GHz at 4m

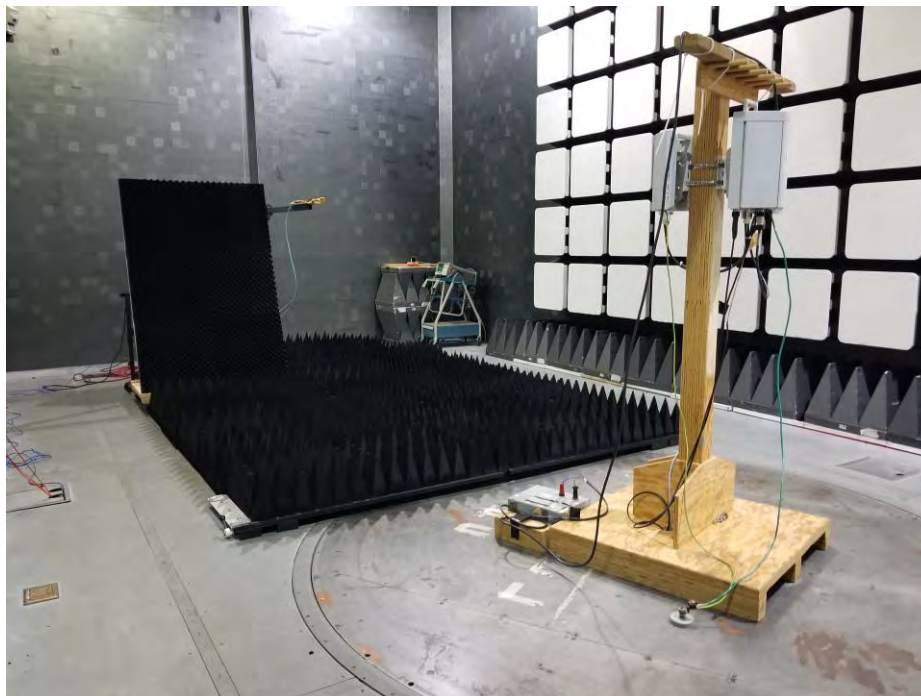

60 GHz – 90 GHz GHz at 4

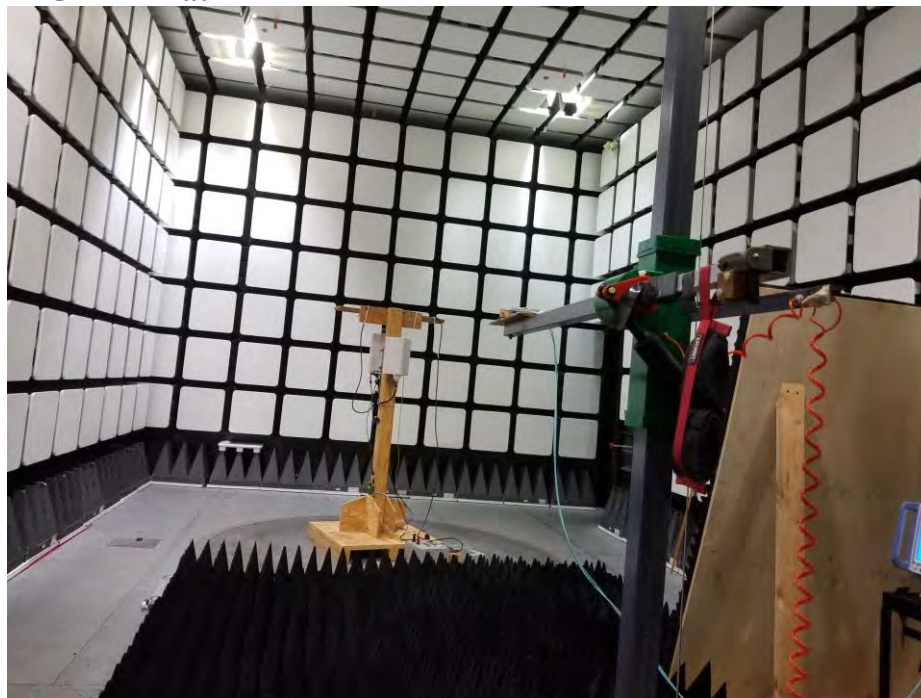

90 GHz – 140 GHz GHz at 3



140 GHz – 200 GHz GHz at 3



Radio Measurements 35-41 GHz at 4.5m

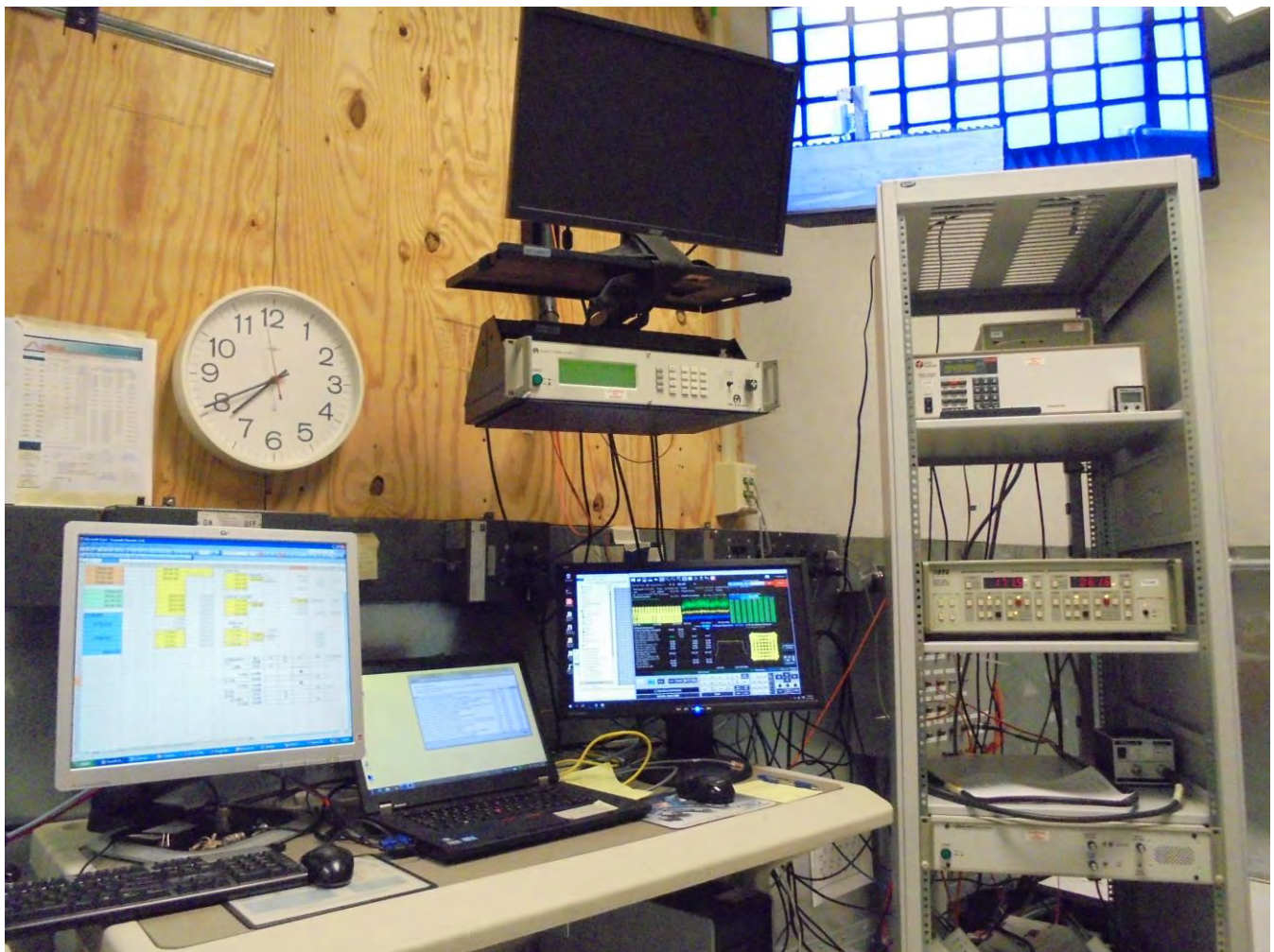

4.13.2 Frequency Stability Test Set Up Photos Unit Under Test



Unit Under Test in Chamber



Horn Antenna (inside of thermal chamber)



Test Measurement Equipment Setup

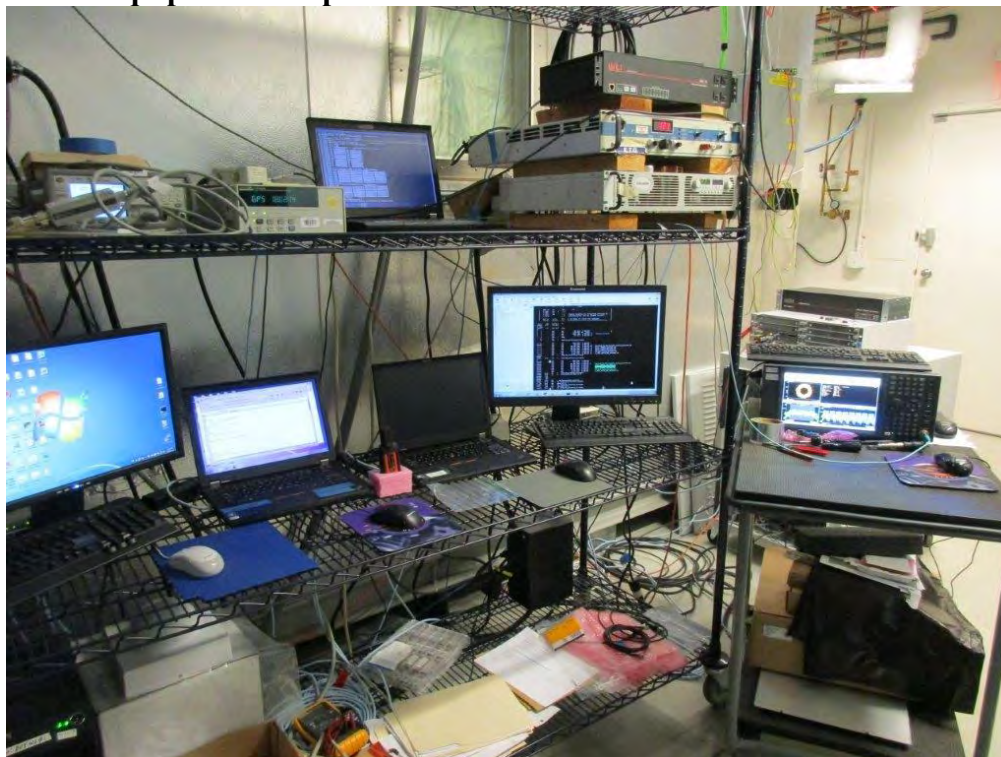

4.14 FACILITIES AND ACCREDITATION

Measurement facilities at Nokia, Global Product Compliance Laboratory (GPCL) a member of the Nokia family of companies, was used to collect the measurement data in the test report. The laboratory, which is part of Nokia Bell Labs, is located at 600-700 Mountain Avenue, Murray Hill, New Jersey 07974-0636 USA.

The field strength measurements of radiated spurious emissions were made in FCC registered five and ten meter semi-anechoic chambers, AR-4 & AR-8, (FCC Registration Number: 395774) NVLAP Lab Code: 100275-0 and IC (Filing Number: 6933F-4 & -8) which is maintained by Nokia Bell Labs in Murray Hill, New Jersey. The sites were constructed and are continuously in conformance with the requirements of ANSI C63.4 and CISPR Publication 22.

Nokia Global Product Compliance Laboratory FCC OET Accredited Test Firm Scope List is accessible at:

https://apps.fcc.gov/oetcf/eas/reports/ViewTestFirmAccredScopes.cfm?calledFromFrame=N&RequestTimeout=500®num_specified=N&test_firm_id=7007

and is as listed in the Table below.

OET Accredited Test Firm Scope List
Test Firm: Nokia, Global Product Compliance Lab

Scope	FCC Rule Parts	Maximum Assessed Frequency, MHz	Status	Expiration Date	Recognition Date
Unintentional Radiators	FCC Part15, Subpart B	40000	Approved	9/30/2018	7/6/2017
Intentional Radiators	FCC Part 15 Subpart C	40000	Approved	9/30/2018	6/5/2018
U-NII without DFS Intentional Radiators	FCC Part 15, Subpart E	40000	Approved	9/30/2018	6/5/2018
U-NII with DFS Intentional Radiators	FCC Part 15, Subpart E	40000	Approved	9/30/2018	6/5/2018
Commercial Mobile Services	Part 22 (cellular), Part 24, Part 25 (below 3 GHz), Part 27	40000	Approved	9/30/2018	6/5/2018
General Mobile Radio Services	Part 22 (non-cellular), Part 90 (below 3 GHz), Part 95 (below 3 GHz), Part 97 (below 3 GHz), Part 101 (below 3 GHz)	40000	Approved	9/30/2018	6/5/2018
Citizens Broadband Radio Services	Part 96	40000	Approved	9/30/2018	7/6/2017
Microwave and Millimeter Bands Radio Services	Part 25, Part30, Part 74, Part 90 (90M DSRC, Y, Z), Part 95 (M & L), Part 101	200000	Approved	9/30/2018	7/6/2017

Nokia Global Product Compliance Laboratory is accredited with the US Department of Commerce National Institute of Standards and Technology's National Voluntary Laboratory Accreditation Program (NVLAP) for satisfactory compliance with criteria established in Title 15, Part 7 Code of Federal Regulations for offering test services for selected test methods in Electromagnetic Compatibility; Voluntary Control Council for Interference (VCCI), Japan; Australian Communications and Media Authority (ACMA). The laboratory is ISO 9001:2008 Certified.

**United States Department of Commerce
National Institute of Standards and Technology**

NVLAP[®]

Certificate of Accreditation to ISO/IEC 17025:2005

NVLAP LAB CODE: 100275-0

Nokia, Global Product Compliance Lab
Murray Hill, NJ

*is accredited by the National Voluntary Laboratory Accreditation Program for specific services,
listed on the Scope of Accreditation, for:*

Electromagnetic Compatibility & Telecommunications

*This laboratory is accredited in accordance with the recognized International Standard ISO/IEC 17025:2005.
This accreditation demonstrates technical competence for a defined scope and the operation of a laboratory quality
management system (refer to joint ISO-ILAC-IAF Communique dated January 2009).*

2018-09-05 through 2019-09-30
Effective Dates



For the National Voluntary Laboratory Accreditation Program

5. APPENDIX A - CALIBRATION CERTIFICATES.

The attached Calibration certificates represent the Harmonic Downconverters used in this testing.

Calibration Method
Kalibrieranweisung

RPG-PAQA-TN-2014-002

Relative Humidity 20 % - 80 %
Relative Luftfeuchte

Ambient Temperature
Umgebungstemperatur

(23 ⁺⁷/₋₃) °C

Working standards used (having a significant effect on the accuracy) Verwendete Gebrauchsnormale (mit signifikantem Einfluss auf die Genauigkeit)				
Item Gegenstand	Type Typ	Serial Number Seriennummer	Calibration Certificate Number Kalibrierscheinnummer	Cal. Due Kalibr. bis
Vector Network Analyzer	R&S® ZVA67	101097	20-300432406	2020-07-21
Powersensor	R&S® NRP-Z55	140093	20-300426315	2018-05-17
Powersensor	R&S® NRP-Z57	101423	20-541799	2019-04-27

UGB1 A compliance statement may be possible where a confidence level of less than 95 % is acceptable.
Die Bestätigung der Konformität ist möglich, sofern ein Grad des Vertrauens von weniger als 95 % akzeptabel ist.

UGB2 A non-compliance statement may be possible where a confidence level of less than 95 % is acceptable.
Die Bestätigung der Nicht-Konformität ist möglich, sofern ein Grad des Vertrauens von weniger als 95 % akzeptabel ist.

Ref.: ILAC-G8:03/2009 'Guidelines on the Reporting of Compliance with Specification'.

Notes

Anmerkungen

If the new product is stored under the climate conditions as specified in the data sheet upon delivery, the product's accuracy is not significantly affected within 12 month after its calibration in our factory. In this case, the recommended calibration interval starts on the date when the product is actually put into operation.

Outgoing Results

The following abbreviations may be used in this document

{a}	No measurement uncertainty stated because the errors always add together. So it is sure that a measurement result evaluated as "PASS" is pass.
{b}	The measurement uncertainty depends on the measurement result. The stated measurement uncertainty is valid for the close area around the specification. Measurement results outside the close area have a higher measurement uncertainty but are within the specification.
{c}	Functional test, therefore no measurement uncertainty is stated.
{d}	Typical value, refer to performance test.
{e}	The measurement uncertainty is taken into account when setting the measuring system.
DL or DT	Data Limit for symmetrical tolerance limits
DLL	Datasheet Lower Limit
DUL	Datasheet Upper Limit
MU	Measurement Uncertainty
MLL or MLV	Measurement Uncertainty Lower Value
MUL or MUV	Measurement Uncertainty Upper Value
Nom.	Nominal Value
Dev.	Deviation
MErr.	Measurement Error
Act.	Actual Value
UGB	Uncertainty Guard Band: Measuring uncertainty violates the data (spec.) limit.
UGB1	Measurement results marked as UGB1 show conformity with a probability of >50 % and <95 %.
UGB2	Measurement results marked as UGB2 show non-conformity with a probability of >50 % and <95 %.
DU	Datasheet Uncertainty

Explanation of charts

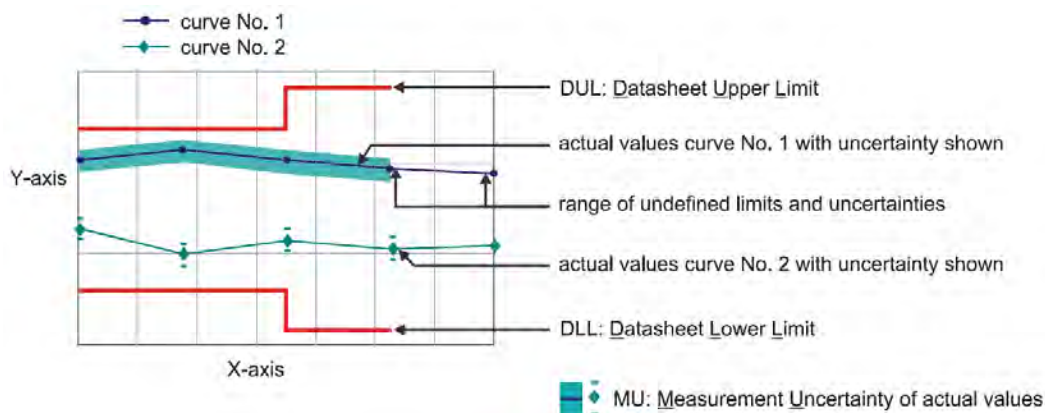

Software used for measurement

Item Type

Measurement Studio Professional Edition
MixerCertification

Version

2013
7_07

Remark

1.1 RF Input – VSWR

Measurement uncertainty: 0.05 (VSWR)

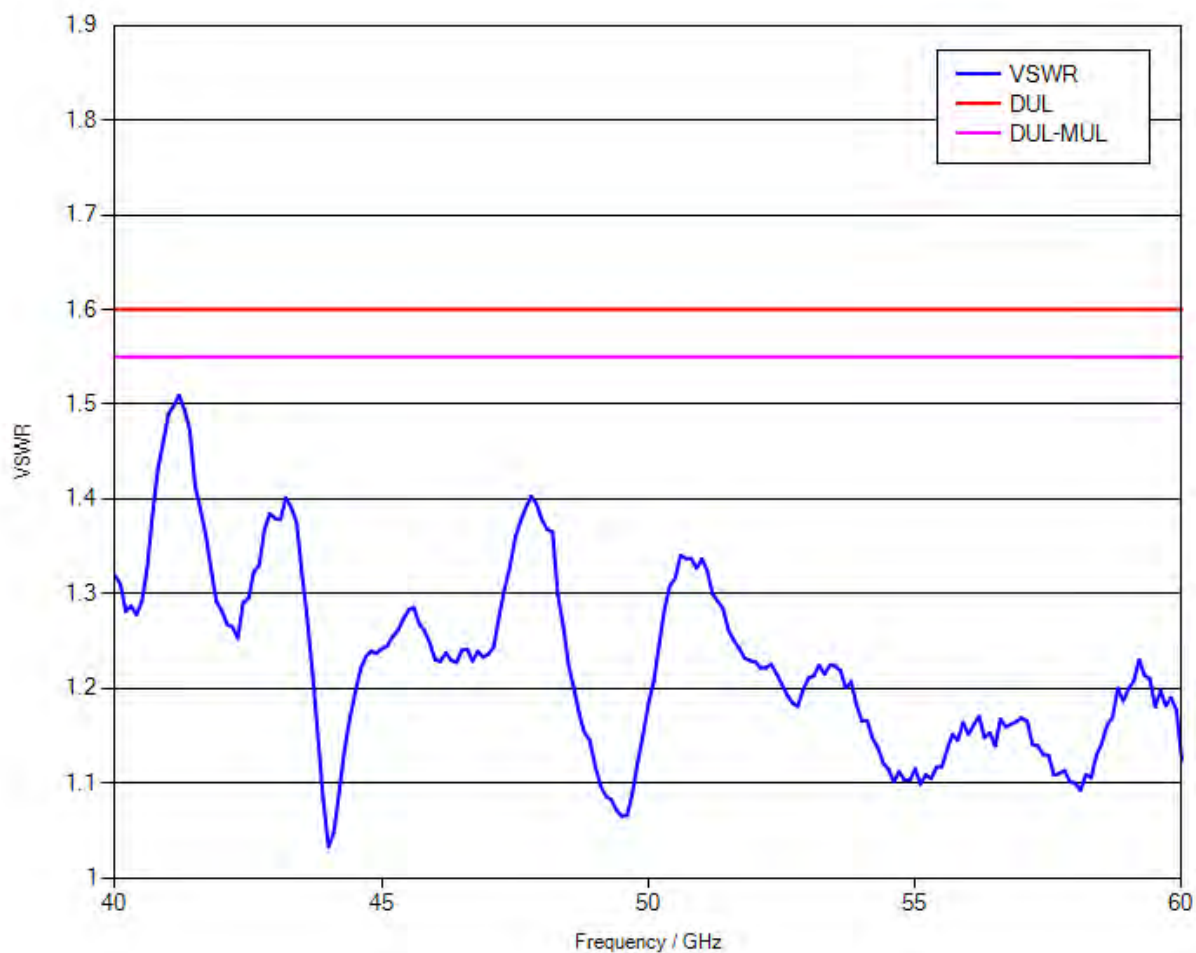

1.2 Conversion loss

LO level +13 dBm nominal
Bias 0 A

Measurement uncertainty: 1.5 dB

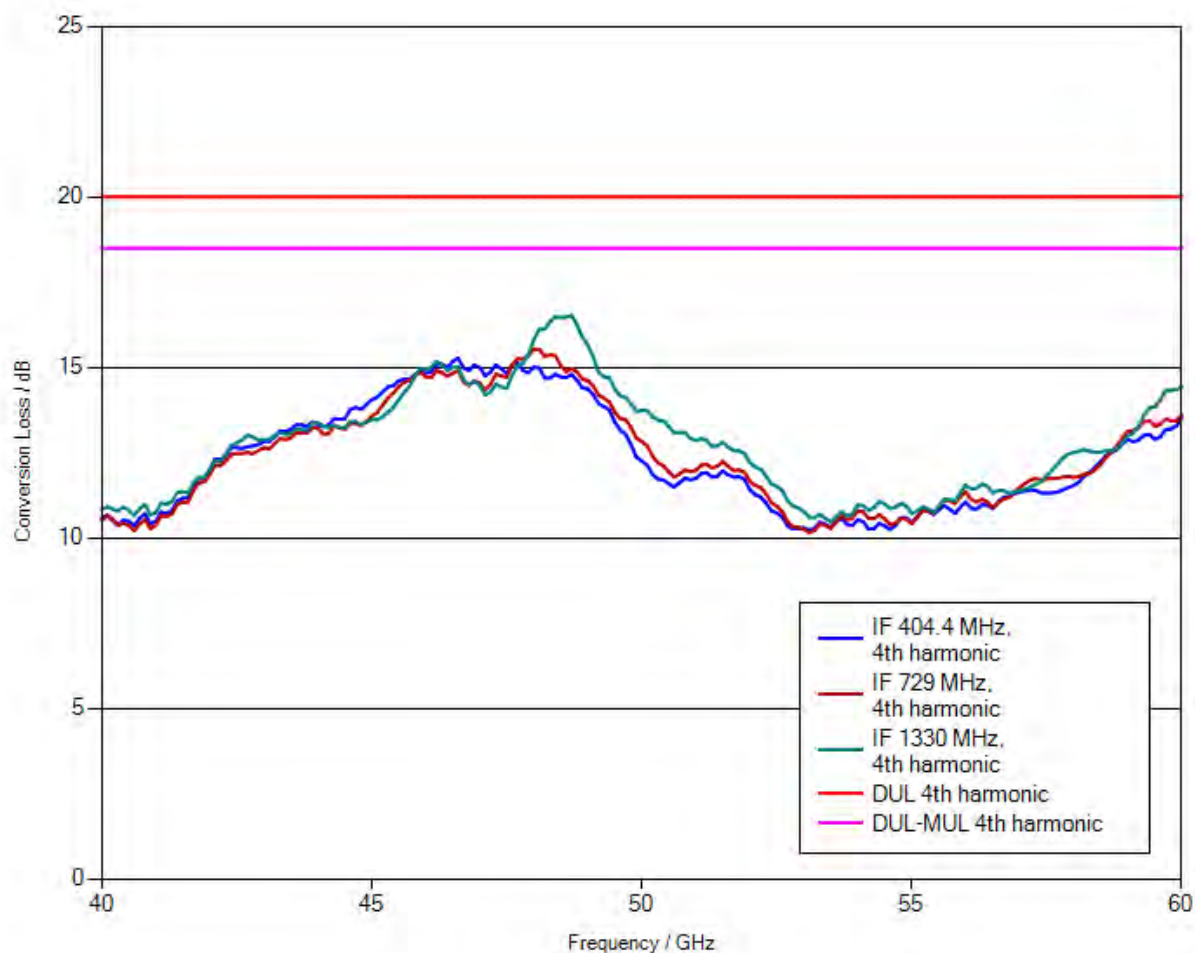

Note: Numeric calibration data can be found attached to the PDF file of the calibration certificate. Click the “paper clip” symbol to display the file.

The file has been renamed for safety reasons.

When downloading the file onto your PC, please delete the “.file” extension and unzip the data.

1.3 Frequency response within 1 GHz

	DUL	Actual (worst case)	Evaluation
IF = 404.4 MHz, 4th harmonic	4 dB	2.02 dB	PASS
IF = 729 MHz, 4th harmonic	4 dB	1.78 dB	PASS
IF = 1330 MHz, 4th harmonic	4 dB	2.35 dB	PASS

Calibration Method
Kalibrieranweisung

RPG-PAQA-TN-2014-002

Relative Humidity 20 % - 80 %
Relative Luftfeuchte

Ambient Temperature
Umgebungstemperatur

(23 ⁺⁷/₋₃) °C

Working standards used (having a significant effect on the accuracy) Verwendete Gebrauchsnormale (mit signifikantem Einfluss auf die Genauigkeit)				
Item Gegenstand	Type Typ	Serial Number Seriennummer	Calibration Certificate Number Kalibrierscheinnummer	Cal. Due Kalibr. bis
Vector Network Analyzer	R&S® ZVA67	101097	20-300432406	2020-07-21
Powersensor	R&S® NRP-Z55	140093	20-300426315	2018-05-17
Powersensor	R&S® NRP-Z58	101063	20-611482	2018-07-21
Calibration kit	WR12	E10001	RPG-PAQA-TN-2014-005	2019-02-01

UGB1 A compliance statement may be possible where a confidence level of less than 95 % is acceptable.
Die Bestätigung der Konformität ist möglich, sofern ein Grad des Vertrauens von weniger als 95 % akzeptabel ist.

UGB2 A non-compliance statement may be possible where a confidence level of less than 95 % is acceptable.
Die Bestätigung der Nicht-Konformität ist möglich, sofern ein Grad des Vertrauens von weniger als 95 % akzeptabel ist.

Ref.: ILAC-G8:03/2009 'Guidelines on the Reporting of Compliance with Specification'.

Notes

Anmerkungen

If the new product is stored under the climate conditions as specified in the data sheet upon delivery, the product's accuracy is not significantly affected within 12 month after its calibration in our factory. In this case, the recommended calibration interval starts on the date when the product is actually put into operation.

Outgoing Results

The following abbreviations may be used in this document

{a}	No measurement uncertainty stated because the errors always add together. So it is sure that a measurement result evaluated as "PASS" is pass.
{b}	The measurement uncertainty depends on the measurement result. The stated measurement uncertainty is valid for the close area around the specification. Measurement results outside the close area have a higher measurement uncertainty but are within the specification.
{c}	Functional test, therefore no measurement uncertainty is stated.
{d}	Typical value, refer to performance test.
{e}	The measurement uncertainty is taken into account when setting the measuring system.
DL or DT	Data Limit for symmetrical tolerance limits
DLL	Datasheet Lower Limit
DUL	Datasheet Upper Limit
MU	Measurement Uncertainty
MLL or MLV	Measurement Uncertainty Lower Value
MUL or MUV	Measurement Uncertainty Upper Value
Nom.	Nominal Value
Dev.	Deviation
MErr.	Measurement Error
Act.	Actual Value
UGB	Uncertainty Guard Band: Measuring uncertainty violates the data (spec.) limit.
UGB1	Measurement results marked as UGB1 show conformity with a probability of >50 %and <95 %.
UGB2	Measurement results marked as UGB2 show non-conformity with a probability of >50 %and <95 %.
DU	Datasheet Uncertainty

Explanation of charts

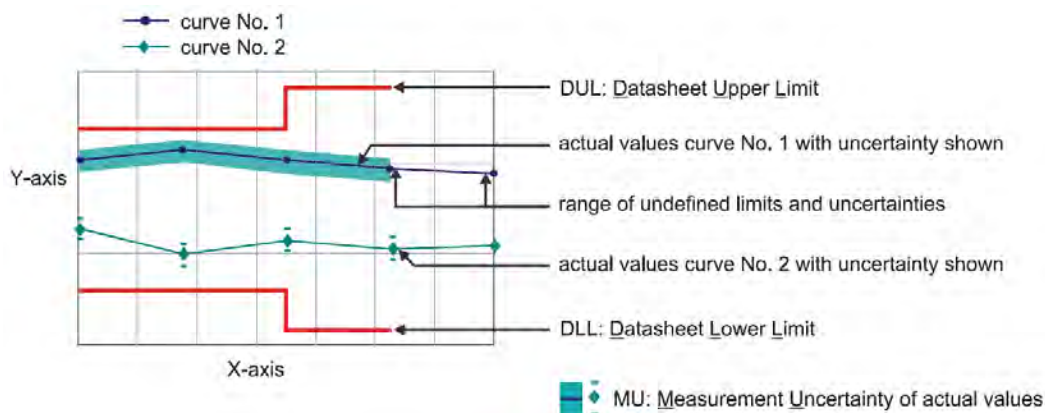

Software used for measurement

Item Type

Measurement Studio Professional Edition
MixerCertification

Version

2013
only

Remark

1.1 RF Input – VSWR

Measurement uncertainty: 0.05 (VSWR)

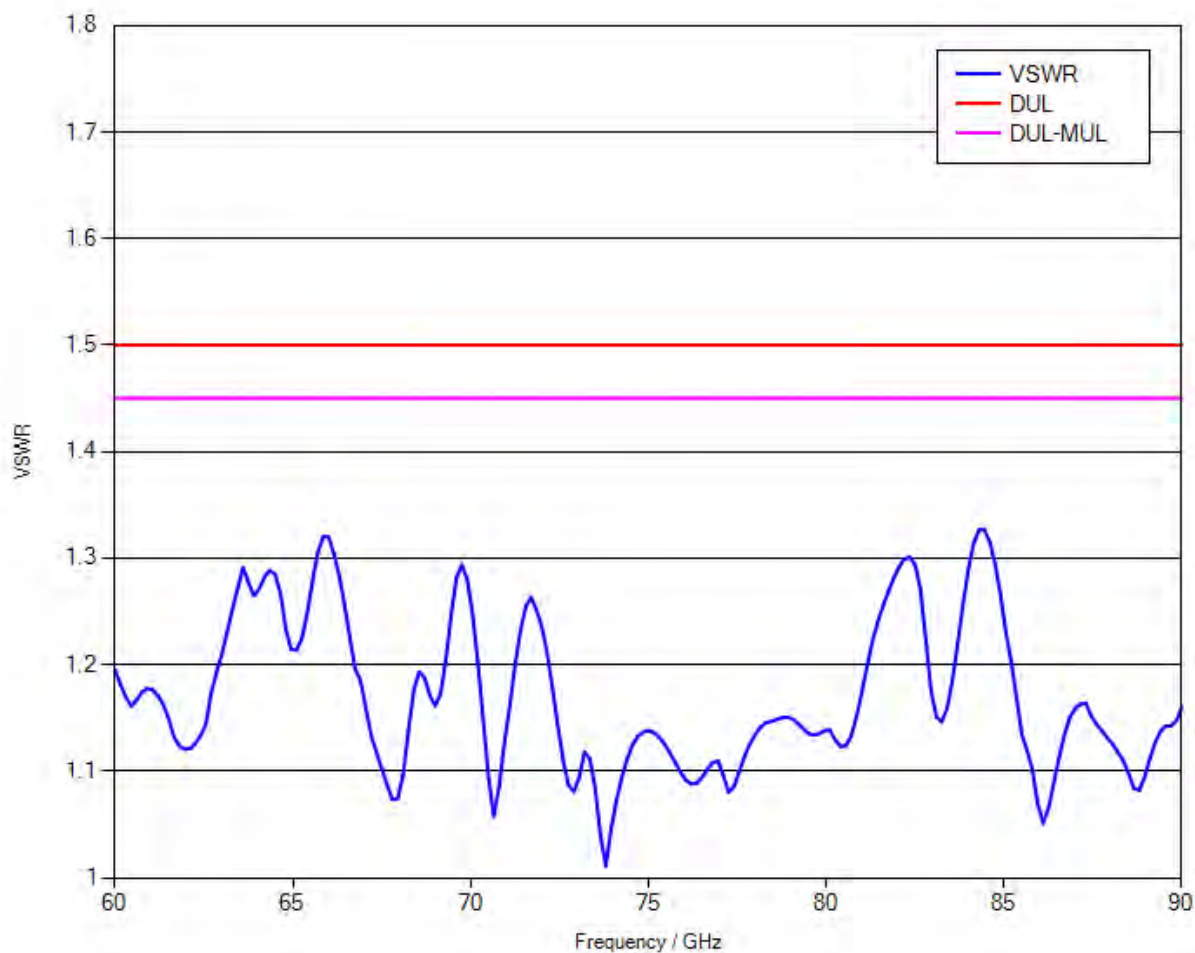

1.2 Conversion loss

LO level +14 dBm nominal
 Bias 0 A

Measurement uncertainty: 1.5 dB

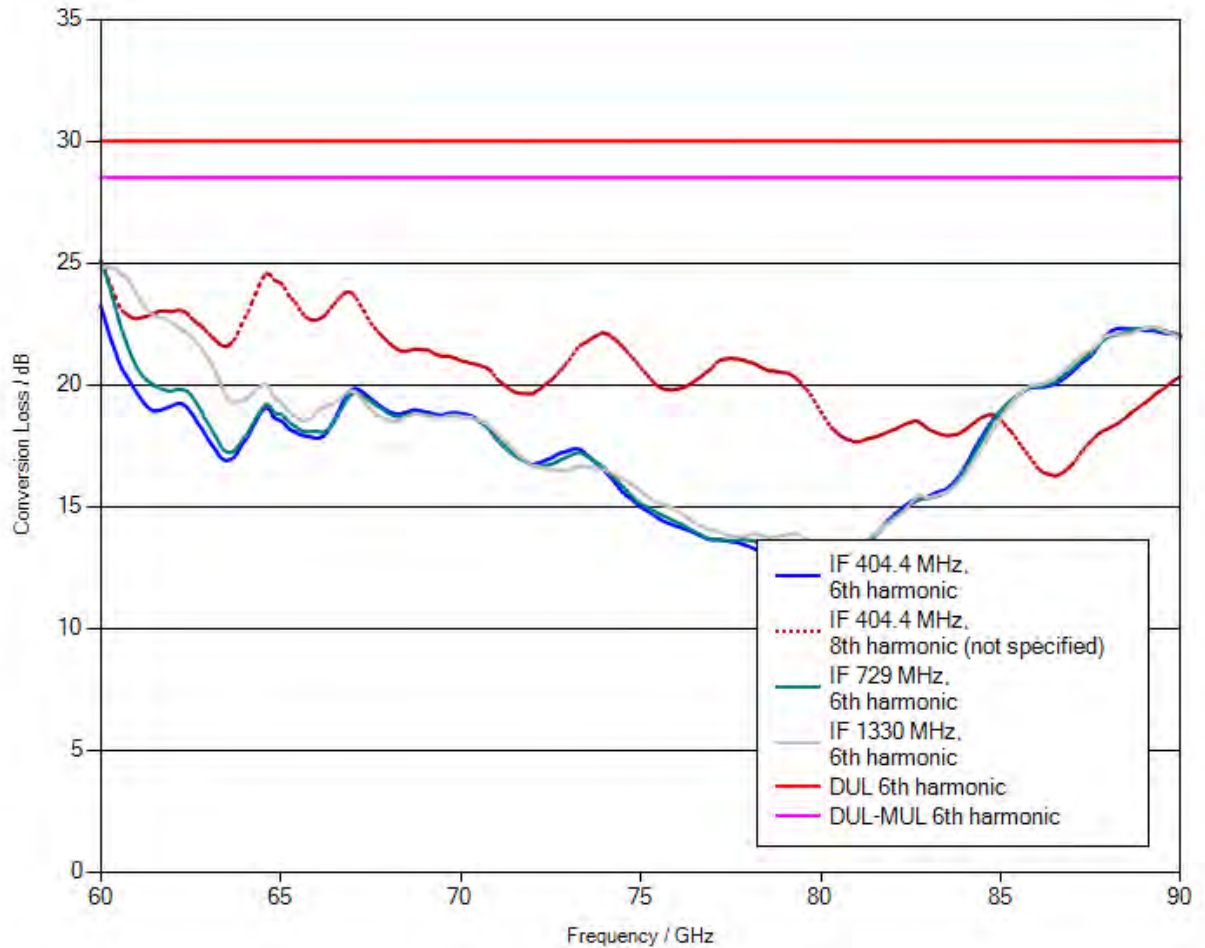

Note: Numeric calibration data can be found attached to the PDF file of the calibration certificate. Click the “paper clip” symbol to display the file.

The file has been renamed for safety reasons. When downloading the file onto your PC, please delete the “.file” extension and unzip the data.

1.3 Frequency response within 1 GHz

	DUL	Actual (worst case)	Evaluation
IF = 404.4 MHz, 6th harmonic	6 dB	3.33 dB	PASS
IF = 404.4 MHz, 8th harmonic	not specified	2.73 dB	not specified
IF = 729 MHz, 6th harmonic	6 dB	4.12 dB	PASS
IF = 1330 MHz, 6th harmonic	6 dB	2.32 dB	PASS



Calibration Certificate

Kalibrierschein

Certificate Number **24-0140-101008-01**

Zertifikatsnummer

Unit Data

Item Harmonic Mixer, 90 GHz to 140 GHz
Gegenstand

Manufacturer RPG
Hersteller

Type RPG FS-Z140
Typ

Material Number 3622.0708.02 **Serial Number** 101008
Materialnummer Seriennummer

Asset Number
Inventarnummer

This calibration certificate documents, that the named item is tested and measured against defined specifications. Measurement results are located usually in the corresponding interval with a probability of approx. 95% (coverage factor $k = 2$). Calibration is performed with test equipment and standards directly or indirectly traceable by means of approved calibration techniques to the PTB/DKD or other national/international standards, which realize the physical units of measurement according to the International System of Units (SI). In all cases where no standards are available, measurements are referenced to standards of the R&S laboratories. Principles and methods of calibration correspond with EN ISO/IEC 17025. This calibration certificate may not be reproduced other than in full. Calibration certificates without signatures are not valid. The user is obliged to have the object recalibrated at appropriate intervals.

Order Data

Customer
Auftraggeber

Order Number
Bestellnummer

Date of Receipt
Eingangsdatum

Dieser Kalibrierschein dokumentiert, dass der genannte Gegenstand nach festgelegten Vorgaben geprüft und gemessen wurde. Die Messwerte lagen im Regelfall mit einer Wahrscheinlichkeit von annähernd 95% im zugeordneten Werteintervall (Erweiterte Messunsicherheit mit $k = 2$). Die Kalibrierung erfolgte mit Messmitteln und Normalen, die direkt oder indirekt durch Ableitung mittels anerkannter Kalibriertechniken rückgeführt sind auf Normale der PTB/DKD oder anderer nationaler/internationaler Standards zur Darstellung der physikalischen Einheiten in Übereinstimmung mit dem Internationalen Einheitensystem (SI). Wenn keine Normale existieren, erfolgt die Rückführung auf Bezugsnormale der R&S-Laboratorien. Grundsätze und Verfahren der Kalibrierung beziehen sich auf EN ISO/IEC 17025. Dieser Kalibrierschein darf nur vollständig und unverändert weiterverbreitet werden. Kalibrierscheine ohne Unterschriften sind ungültig. Für die Einhaltung einer angemessenen Frist zur Wiederholung der Kalibrierung ist der Benutzer verantwortlich.

Performance

Place and Date of Calibration
Ort und Datum der Kalibrierung

Meckenheim, 2017-04-06

Scope of Calibration
Umfang der Kalibrierung

Standard Calibration

Statement of Compliance (Incoming)
Konformitätsaussage (Anlieferung)

New device

Statement of Compliance (Outgoing)
Konformitätsaussage (Auslieferung)

All measured values are within the data sheet specifications.

Extend of Calibration Documents
Umfang des Kalibrierdokuments

**2 pages Calibration Certificate
5 pages Outgoing Results**

Radiometer Physics GmbH; Meckenheim

Date of Issue
Ausstellungsdatum

2017-04-07

Head of Laboratory
Laborleitung

Ceru

Person Responsible
Bearbeiter

Heinze

Page (Seite) 1/2
Vers2010-05-05/
RPG2014-02-28

Calibration Method
Kalibrieranweisung

RPG-PAQA-TN-2014-002

Relative Humidity 20 % - 80 %
Relative Luftfeuchte

Ambient Temperature
Umgebungstemperatur

(23 ⁺⁷/₋₃) °C

Working standards used (having a significant effect on the accuracy) Verwendete Gebrauchsnormale (mit signifikantem Einfluss auf die Genauigkeit)				
Item Gegenstand	Type Typ	Serial Number Seriennummer	Calibration Certificate Number Kalibrierscheinnummer	Cal. Due Kalibr. bis
Vector Network Analyzer	R&S® ZVA67	101097	10-300319061	2017-08-06
Powersensor	R&S® NRP-Z55	140093	20-541556	2017-05-12

UGB1 A compliance statement may be possible where a confidence level of less than 95 % is acceptable.
Die Bestätigung der Konformität ist möglich, sofern ein Grad des Vertrauens von weniger als 95 % akzeptabel ist.

UGB2 A non-compliance statement may be possible where a confidence level of less than 95 % is acceptable.
Die Bestätigung der Nicht-Konformität ist möglich, sofern ein Grad des Vertrauens von weniger als 95 % akzeptabel ist.

Ref.: ILAC-G8:03/2009 'Guidelines on the Reporting of Compliance with Specification'.

Notes
Anmerkungen

Outgoing Results

The following abbreviations may be used in this document

- {a} No measurement uncertainty stated because the errors always add together.
So it is sure that a measurement result evaluated as "PASS" is pass.
- {b} The measurement uncertainty depends on the measurement result. The stated measurement uncertainty is valid for the close area around the specification. Measurement results outside the close area have a higher measurement uncertainty but are within the specification.
- {c} Functional test, therefore no measurement uncertainty is stated.
- {d} Typical value, refer to performance test.
- {e} The measurement uncertainty is taken into account when setting the measuring system.
- DL or DT Data Limit for symmetrical tolerance limits
- DLL Datasheet Lower Limit
- DUL Datasheet Upper Limit
- MU Measurement Uncertainty
- MLL or MLV Measurement Uncertainty Lower Value
- MUL or MUV Measurement Uncertainty Upper Value
- Nom. Nominal Value
- Dev. Deviation
- MErr. Measurement Error
- Act. Actual Value
- UGB Uncertainty Guard Band: Measuring uncertainty violates the data (spec.) limit.
- UGB1 Measurement results marked as UGB1 show conformity with a probability of >50 % and <95 %.
- UGB2 Measurement results marked as UGB2 show non-conformity with a probability of >50 % and <95 %.
- DU Datasheet Uncertainty

Explanation of charts

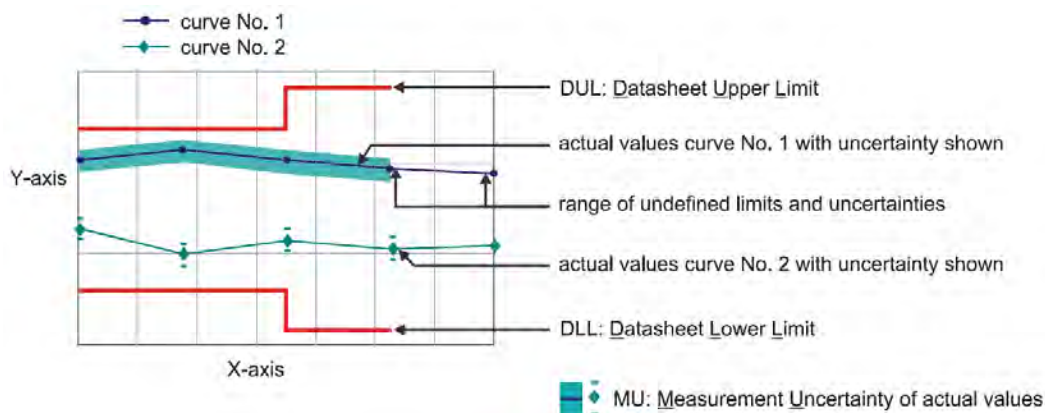

Software used for measurement**Item Type**Measurement Studio Professional Edition
MixerCertification**Version**2013
7_04**Remark**

1.1 RF Input – VSWR

Measurement uncertainty: 0.05 (VSWR)

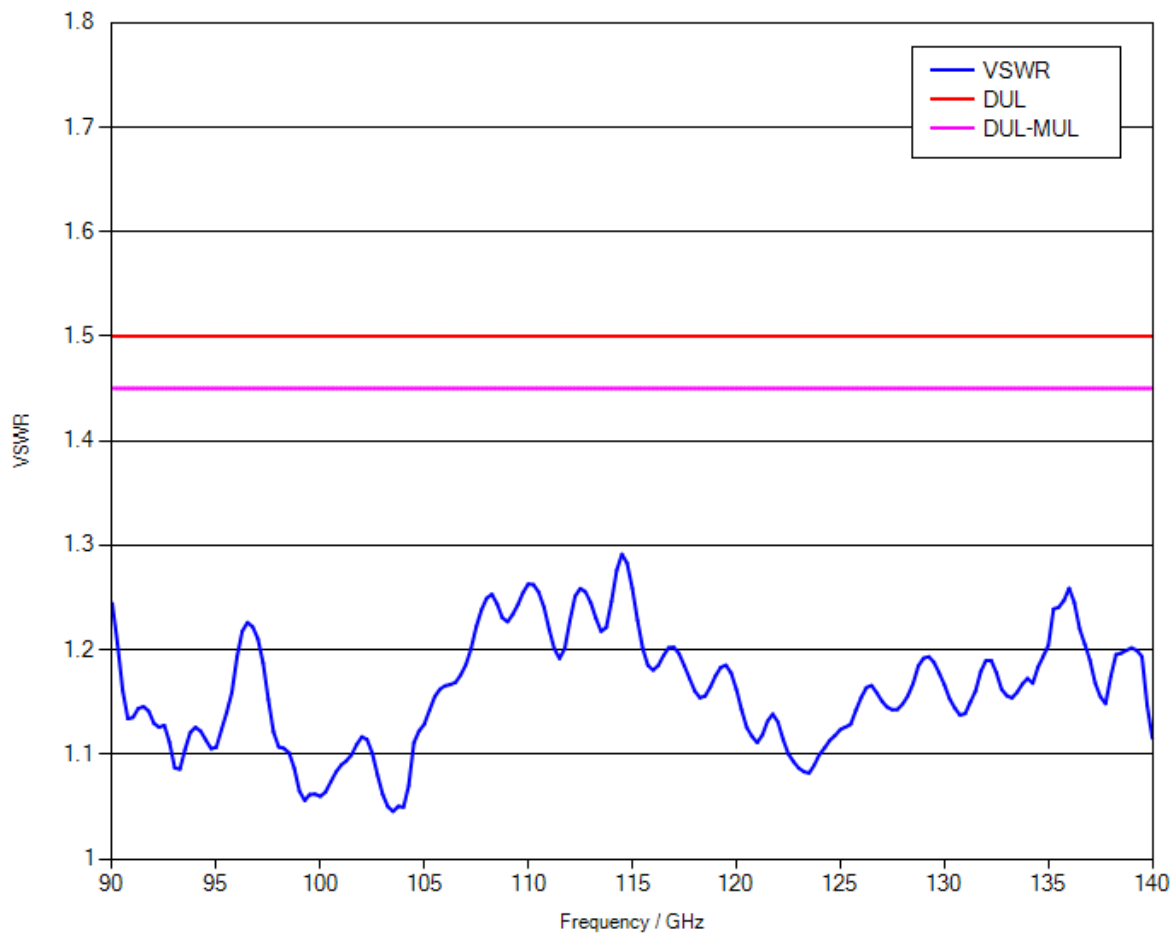

1.2 Conversion loss

LO level +14 dBm nominal
Bias 0 A

Measurement uncertainty: 3.5 dB

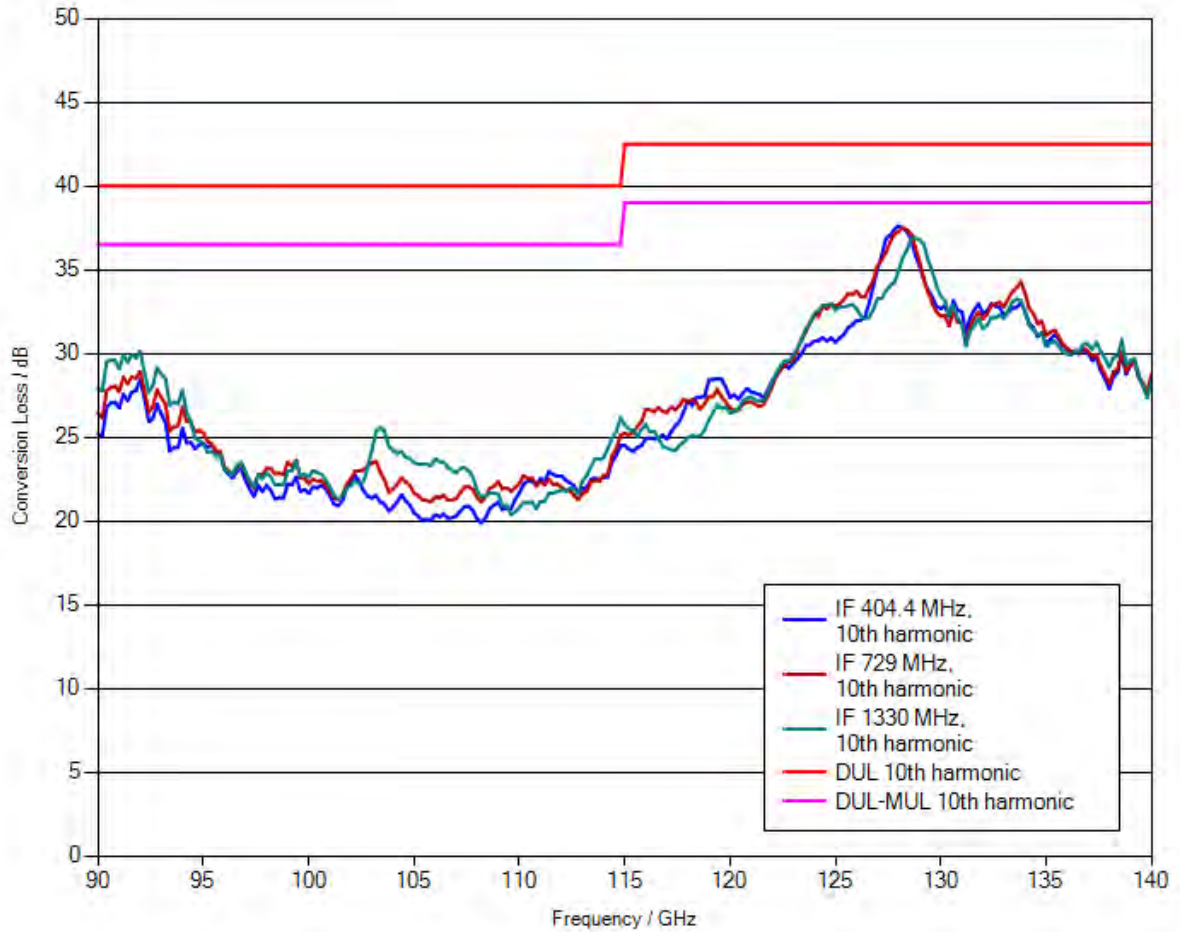

Note: Numeric calibration data can be found attached to the PDF file of the calibration certificate. Click the “paper clip” symbol to display the file.

The file has been renamed for safety reasons.

When downloading the file onto your PC, please delete the “.file” extension and unzip the data.

1.3 Frequency response within 1 GHz

	DUL	Actual (worst case)	Evaluation
IF = 404.4 MHz, 10th harmonic	6 dB	3.86 dB	PASS
IF = 729 MHz, 10th harmonic	6 dB	3.48 dB	PASS
IF = 1330 MHz, 10th harmonic	6 dB	3.19 dB	PASS



Calibration Certificate

Certificate Number 24-0220-100960-01

Kalibrierschein

Zertifikatsnummer

Unit Data

Item Harmonic Mixer, 140 GHz to 220 GHz
Gegenstand

Manufacturer RPG
Hersteller

Type RPG FS-Z220
Typ

Material Number 3593.3250.02 **Serial Number** 100960
Materialnummer Seriennummer

Asset Number
Inventarnummer

This calibration certificate documents, that the named item is tested and measured against defined specifications. Measurement results are located usually in the corresponding interval with a probability of approx. 95% (coverage factor $k = 2$). Calibration is performed with test equipment and standards directly or indirectly traceable by means of approved calibration techniques to the PTB/DKD or other national/international standards, which realize the physical units of measurement according to the International System of Units (SI). In all cases where no standards are available, measurements are referenced to standards of the R&S laboratories. Principles and methods of calibration correspond with EN ISO/IEC 17025. This calibration certificate may not be reproduced other than in full. Calibration certificates without signatures are not valid. The user is obliged to have the object recalibrated at appropriate intervals.

Order Data

Customer
Auftraggeber

Order Number
Bestellnummer

Date of Receipt
Eingangsdatum

Dieser Kalibrierschein dokumentiert, dass der genannte Gegenstand nach festgelegten Vorgaben geprüft und gemessen wurde. Die Messwerte lagen im Regelfall mit einer Wahrscheinlichkeit von annähernd 95% im zugeordneten Werteintervall (Erweiterte Messunsicherheit mit $k = 2$). Die Kalibrierung erfolgte mit Messmitteln und Normalen, die direkt oder indirekt durch Ableitung mittels anerkannter Kalibriertechniken rückgeführt sind auf Normale der PTB/DKD oder anderer nationaler/internationaler Standards zur Darstellung der physikalischen Einheiten in Übereinstimmung mit dem Internationalen Einheitensystem (SI). Wenn keine Normale existieren, erfolgt die Rückführung auf Bezugsnormale der R&S-Laboratorien. Grundsätze und Verfahren der Kalibrierung beziehen sich auf EN ISO/IEC 17025. Dieser Kalibrierschein darf nur vollständig und unverändert weiterverbreitet werden. Kalibrierscheine ohne Unterschriften sind ungültig. Für die Einhaltung einer angemessenen Frist zur Wiederholung der Kalibrierung ist der Benutzer verantwortlich.

Performance

Place and Date of Calibration
Ort und Datum der Kalibrierung

Meckenheim, 2018-01-17

Scope of Calibration
Umfang der Kalibrierung

Standard Calibration

Statement of Compliance (Incoming)
Konformitätsaussage (Anlieferung)

New device

Statement of Compliance (Outgoing)
Konformitätsaussage (Auslieferung)

All measured values are within the data sheet specifications.

Extend of Calibration Documents
Umfang des Kalibrierdokuments

**2 pages Calibration Certificate
5 pages Outgoing Results**

Radiometer Physics GmbH; Meckenheim

Date of Issue
Ausstellungsdatum

2018-01-19

Head of Laboratory
Laborleitung

Ceru

Person Responsible
Bearbeiter

Dick

Page (Seite) 1/2
Vers2010-05-05/
RPG2014-02-28

Calibration Method
Kalibrieranweisung

RPG-PAQA-TN-2014-002

Relative Humidity 20 % - 80 %
Relative Luftfeuchte

Ambient Temperature
Umgebungstemperatur

(23⁺⁷₋₃) °C

Working standards used (having a significant effect on the accuracy) Verwendete Gebrauchsnormale (mit signifikantem Einfluss auf die Genauigkeit)				
Item Gegenstand	Type Typ	Serial Number Seriennummer	Calibration Certificate Number Kalibrierscheinnummer	Cal. Due Kalibr. bis
Vector Network Analyzer	R&S® ZVA67	101097	20-300432406	2020-07-21
Powersensor	R&S® NRP-Z55	140093	20-300426315	2018-05-17

UGB1 A compliance statement may be possible where a confidence level of less than 95 % is acceptable.
Die Bestätigung der Konformität ist möglich, sofern ein Grad des Vertrauens von weniger als 95 % akzeptabel ist.

UGB2 A non-compliance statement may be possible where a confidence level of less than 95 % is acceptable.
Die Bestätigung der Nicht-Konformität ist möglich, sofern ein Grad des Vertrauens von weniger als 95 % akzeptabel ist.

Ref.: ILAC-G8:03/2009 'Guidelines on the Reporting of Compliance with Specification'.

Notes

Anmerkungen

If the new product is stored under the climate conditions as specified in the data sheet upon delivery, the product's accuracy is not significantly affected within 12 month after its calibration in our factory. In this case, the recommended calibration interval starts on the date when the product is actually put into operation.

Outgoing Results

The following abbreviations may be used in this document

{a}	No measurement uncertainty stated because the errors always add together. So it is sure that a measurement result evaluated as "PASS" is pass.
{b}	The measurement uncertainty depends on the measurement result. The stated measurement uncertainty is valid for the close area around the specification. Measurement results outside the close area have a higher measurement uncertainty but are within the specification.
{c}	Functional test, therefore no measurement uncertainty is stated.
{d}	Typical value, refer to performance test.
{e}	The measurement uncertainty is taken into account when setting the measuring system.
DL or DT	Data Limit for symmetrical tolerance limits
DLL	Datasheet Lower Limit
DUL	Datasheet Upper Limit
MU	Measurement Uncertainty
MLL or MLV	Measurement Uncertainty Lower Value
MUL or MUV	Measurement Uncertainty Upper Value
Nom.	Nominal Value
Dev.	Deviation
MErr.	Measurement Error
Act.	Actual Value
UGB	Uncertainty Guard Band: Measuring uncertainty violates the data (spec.) limit.
UGB1	Measurement results marked as UGB1 show conformity with a probability of >50 % and <95 %.
UGB2	Measurement results marked as UGB2 show non-conformity with a probability of >50 % and <95 %.
DU	Datasheet Uncertainty

Explanation of charts

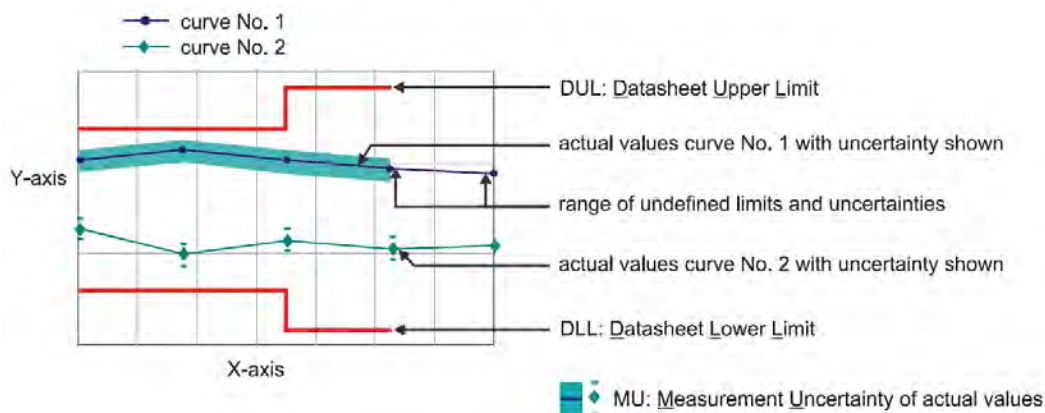

Software used for measurement

Item Type

Measurement Studio Professional Edition
MixerCertification

Version

2013
7_08

Remark

1.1 RF Input – VSWR

Measurement uncertainty: 0.05 (VSWR)

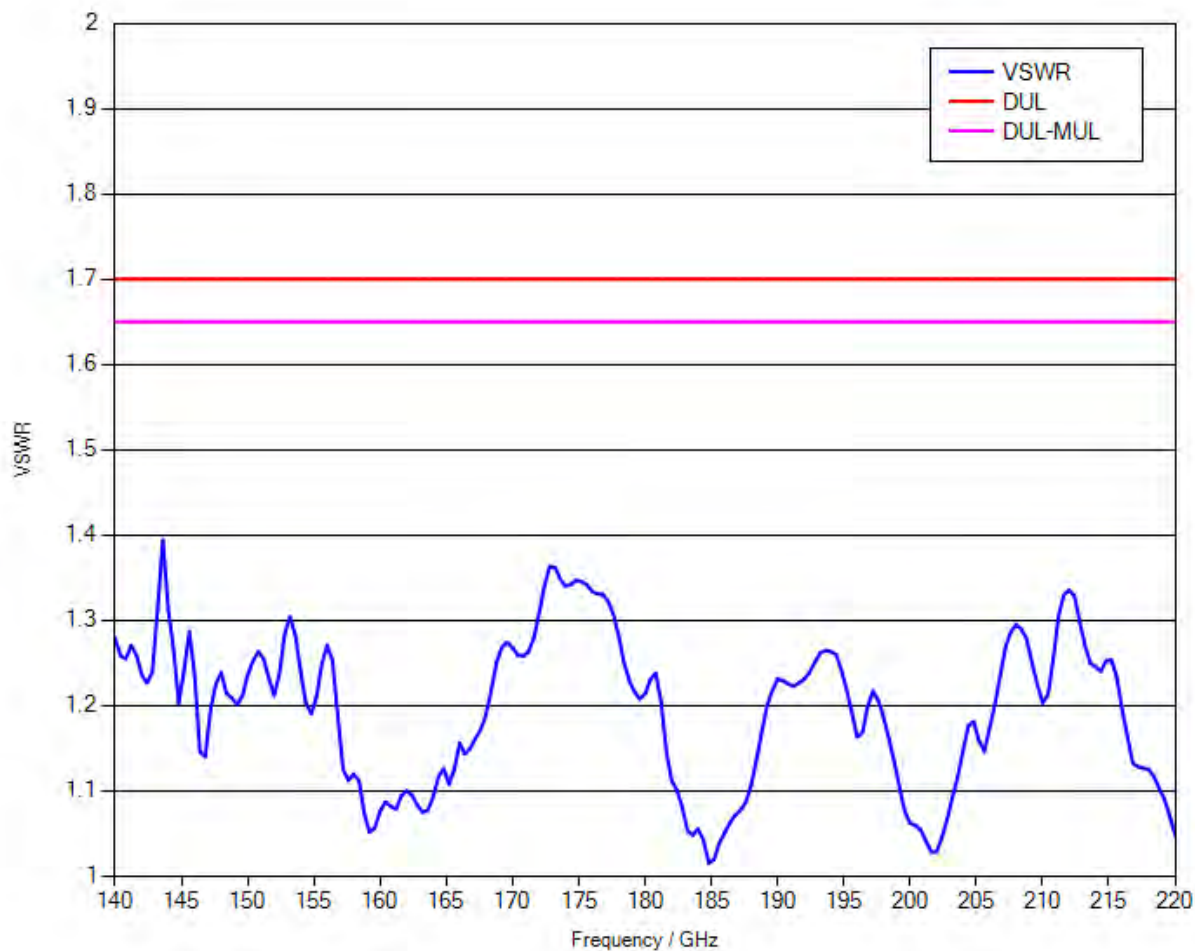

1.2 Conversion loss

LO level +13 dBm nominal
 Bias 0 A

Measurement uncertainty: 4 dB

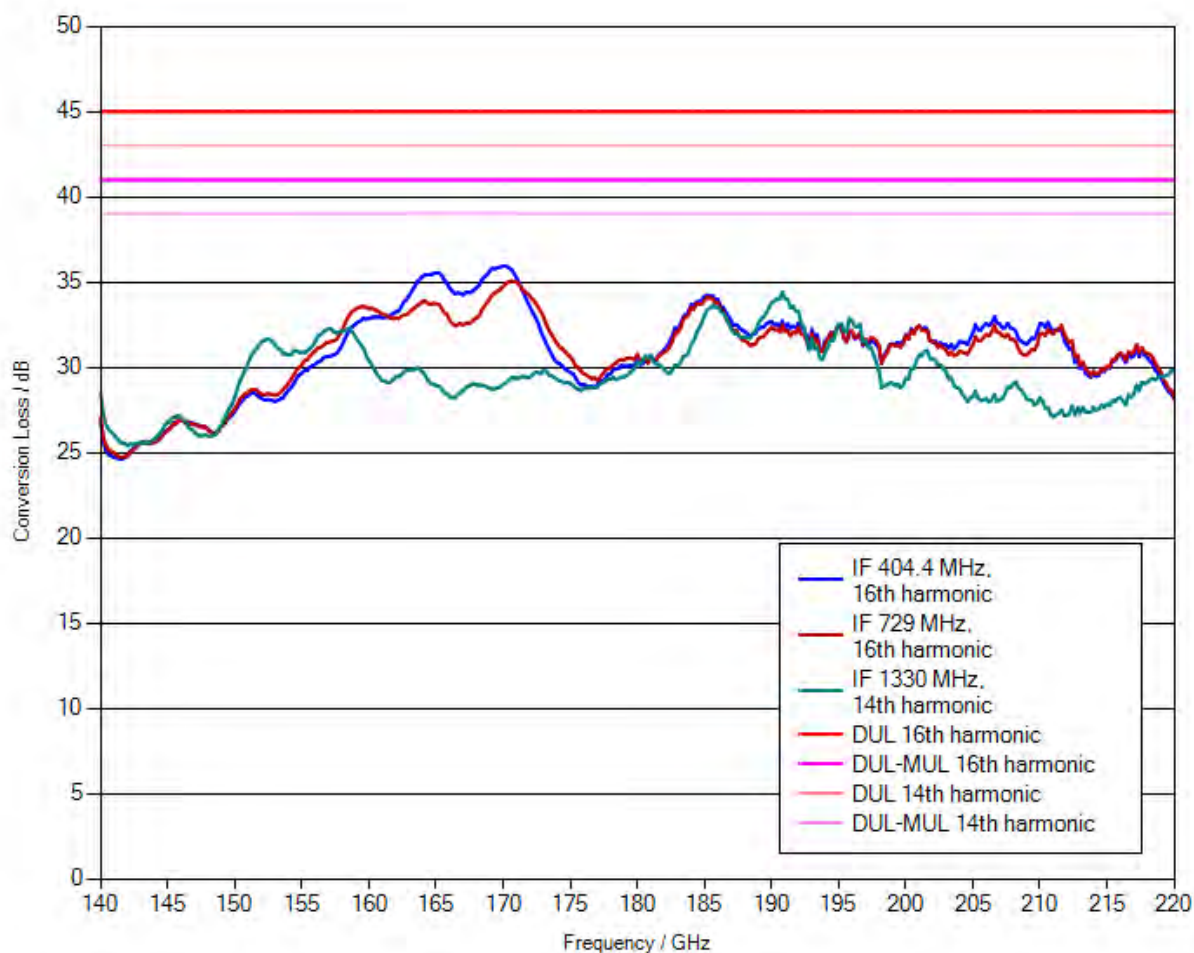

Note: Numeric calibration data can be found attached to the PDF file of the calibration certificate. Click the “paper clip” symbol to display the file.

The file has been renamed for safety reasons. When downloading the file onto your PC, please delete the “.file” extension and unzip the data.

1.3 Frequency response within 1 GHz

	DUL	Actual (worst case)	Evaluation
IF = 404.4 MHz, 16th harmonic	6 dB	2.1 dB	PASS
IF = 729 MHz, 16th harmonic	6 dB	2.05 dB	PASS
IF = 1330 MHz, 14th harmonic	6 dB	2.48 dB	PASS