

TEST REPORT

Test report no.: 1-2276/16-01-05-B

BNetzA-CAB-02/21-102

Testing laboratory

CTC advanced GmbH

Untertuerkheimer Strasse 6 – 10
66117 Saarbruecken / Germany
Phone: + 49 681 5 98 - 0
Fax: + 49 681 5 98 - 9075
Internet: <http://www.ctcadvanced.com>
e-mail: mail@ctcadvanced.com

Accredited Testing Laboratory:

The testing laboratory (area of testing) is accredited according to DIN EN ISO/IEC 17025 (2005) by the Deutsche Akkreditierungsstelle GmbH (DAkks). The accreditation is valid for the scope of testing procedures as stated in the accreditation certificate with the registration number: D-PL-12076-01-03

Applicant

FREDERIQUE CONSTANT SA

Ch. du Champ des Filles 32
1228 Plan-Les-Ouates, Genève / SWITZERLAND
Phone: +41 22 86 00 44 0
Fax: -/-
Contact: Philippe Fraboulet
e-mail: pfraboulet@frederique-constant.com
Phone: +41 22 55 62 09 3

Manufacturer

FREDERIQUE CONSTANT SA

Ch. du Champ des Filles 32
1228 Plan-Les-Ouates, Genève / SWITZERLAND

Test standard/s

47 CFR Part 15 Title 47 of the Code of Federal Regulations; Chapter I; Part 15 - Radio frequency devices

RSS - 247 Issue 2 Digital Transmission Systems (DTSs), Frequency Hopping Systems (FHSs) and Licence - Exempt Local Area Network (LE-LAN) Devices

RSS - Gen Issue 4 Spectrum Management and Telecommunications Radio Standards Specifications - General Requirements and Information for the Certification of Radio Apparatus

For further applied test standards please refer to section 3 of this test report.

Test Item

Kind of test item: Horological Smart Watch
Model name: FC-282X5B4/6
FCC ID: 2AD7G0003
IC: 12729A-0003
Frequency: DTS band 2400 MHz to 2483.5 MHz
Technology tested: Bluetooth®, LE
Antenna: Integrated antenna
Power supply: 3 V DC by CR3032 battery
Temperature range: -10°C to +55°C



This test report is electronically signed and valid without handwriting signature. For verification of the electronic signatures, the public keys can be requested at the testing laboratory.

Test report authorized:

Marco Bertolino
Lab Manager
Radio Communications & EMC

Test performed:

Mihail Dorongovskij
Lab Manager
Radio Communications & EMC

1 Table of contents

1	Table of contents.....	2
2	General information	3
2.1	Notes and disclaimer	3
2.2	Application details	3
3	Test standard/s and references.....	3
4	Test environment	5
5	Test item	5
5.1	General description.....	5
5.2	Additional information	5
6	Test laboratories sub-contracted	5
7	Description of the test setup	6
7.1	Shielded semi anechoic chamber	7
7.2	Shielded fully anechoic chamber	8
7.3	Radiated measurements > 18 GHz	9
7.4	Conducted measurements C.BER system	10
8	Sequence of testing	11
8.1	Sequence of testing radiated spurious 9 kHz to 30 MHz	11
8.2	Sequence of testing radiated spurious 30 MHz to 1 GHz	12
8.3	Sequence of testing radiated spurious 1 GHz to 18 GHz.....	13
8.4	Sequence of testing radiated spurious above 18 GHz	14
9	Measurement uncertainty.....	15
10	Summary of measurement results.....	16
11	Additional comments.....	17
12	Measurement results	18
12.1	System gain.....	18
12.2	Power spectral density	19
12.3	DTS bandwidth – 6 dB bandwidth.....	22
12.4	Occupied bandwidth – 99% emission bandwidth	25
12.5	Maximum output power	28
12.6	Detailed spurious emissions @ the band edge - conducted	31
12.7	Band edge compliance radiated	33
12.8	TX spurious emissions conducted	35
12.9	Spurious emissions radiated below 30 MHz	38
12.10	Spurious emissions radiated 30 MHz to 1 GHz	41
12.11	Spurious emissions radiated above 1 GHz	46
13	Observations	55
Annex A	Document history	55
Annex B	Further information.....	55
Annex C	Accreditation Certificate	56

2 General information

2.1 Notes and disclaimer

The test results of this test report relate exclusively to the test item specified in this test report. CTC advanced GmbH does not assume responsibility for any conclusions and generalizations drawn from the test results with regard to other specimens or samples of the type of the equipment represented by the test item.

The test report may only be reproduced or published in full. Reproduction or publication of extracts from the report requires the prior written approval of CTC advanced GmbH.

The testing service provided by CTC advanced GmbH has been rendered under the current "General Terms and Conditions for CTC advanced GmbH".

CTC advanced GmbH will not be liable for any loss or damage resulting from false, inaccurate, inappropriate or incomplete product information provided by the customer.

Under no circumstances does the CTC advanced GmbH test report include any endorsement or warranty regarding the functionality, quality or performance of any other product or service provided.

Under no circumstances does the CTC advanced GmbH test report include or imply any product or service warranties from CTC advanced GmbH, including, without limitation, any implied warranties of merchantability, fitness for purpose, or non-infringement, all of which are expressly disclaimed by CTC advanced GmbH.

All rights and remedies regarding vendor's products and services for which CTC advanced GmbH has prepared this test report shall be provided by the party offering such products or services and not by CTC advanced GmbH. In no case this test report can be considered as a Letter of Approval.

This test report is electronically signed and valid without handwritten signature. For verification of the electronic signatures, the public keys can be requested at the testing laboratory.

This test report replaces the test report with the number 1-2276/16-01-05-A and dated 2017-10-18.

2.2 Application details

Date of receipt of order:	2016-09-05
Date of receipt of test item:	2016-09-05
Start of test:	2016-09-08
End of test:	2016-11-21
Person(s) present during the test:	-/-

3 Test standard/s and references

Test standard	Date	Description
47 CFR Part 15	-/-	Title 47 of the Code of Federal Regulations; Chapter I; Part 15 - Radio frequency devices
RSS - 247 Issue 2	February 2017	Digital Transmission Systems (DTSs), Frequency Hopping Systems (FHSs) and Licence - Exempt Local Area Network (LE-LAN) Devices
RSS - Gen Issue 4	November 2014	Spectrum Management and Telecommunications Radio Standards Specifications - General Requirements and Information for the Certification of Radio Apparatus

Guidance	Version	Description
DTS: KDB 558074 D01	v03r05	Guidance for Performing Compliance Measurements on Digital Transmission Systems (DTS) Operating Under §15.247
ANSI C63.4-2014	-/-	American national standard for methods of measurement of radio-noise emissions from low-voltage electrical and electronic equipment in the range of 9 kHz to 40 GHz
ANSI C63.10-2013	-/-	American national standard of procedures for compliance testing of unlicensed wireless devices

4 Test environment

Temperature	:	T _{nom} T _{max} T _{min}	+22 °C during room temperature tests No tests under extreme conditions required. No tests under extreme conditions required.
Relative humidity content	:		55 %
Barometric pressure	:		1021 hpa
Power supply	:	V _{nom} V _{max} V _{min}	3.0 V DC by external power supply No tests under extreme conditions required. No tests under extreme conditions required.

5 Test item

5.1 General description

Kind of test item	:	Horological Smart Watch	
Type identification	:	FC-282X5B4/6	
HMN	:	-/-	
PMN	:	FC-282X5B4/6	
HVIN	:	FC-282X5B4/6	
FVIN	:	V30-7.08	
S/N serial number	:	Not available	
HW hardware status	:	Not available	
SW software status	:	7.0	
Frequency band	:	DTS band 2400 MHz to 2483.5 MHz (lowest channel 2402 MHz; highest channel 2480 MHz)	
Type of radio transmission	:	DSSS	
Use of frequency spectrum	:	DSSS	
Type of modulation	:	GFSK	
Number of channels	:	40	
Antenna	:	Integrated antenna	
Power supply	:	3 V DC by CR3032 battery	
Temperature range	:	-10°C to +55°C	

5.2 Additional information

The content of the following annexes is defined in the QA. It may be that not all of the listed annexes are necessary for this report, thus some values in between may be missing.

Test setup- and EUT-photos are included in test report:

- 1-2276/16-01-01_AnnexA
- 1-2276/16-01-01_AnnexB
- 1-2276/16-01-01_AnnexD

6 Test laboratories sub-contracted

None

7 Description of the test setup

Typically, the calibrations of the test apparatus are commissioned to and performed by an accredited calibration laboratory. The calibration intervals are determined in accordance with the DIN EN ISO/IEC 17025. In addition to the external calibrations, the laboratory executes comparison measurements with other calibrated test systems or effective verifications. Weekly chamber inspections and range calibrations are performed. Where possible, RF generating and signaling equipment as well as measuring receivers and analyzers are connected to an external high-precision 10 MHz reference (GPS-based or rubidium frequency standard).

In order to simplify the identification of the equipment used at some special tests, some items of test equipment and ancillaries can be provided with an identifier or number in the equipment list below (Lab/Item).

Agenda: Kind of Calibration

k	calibration / calibrated	EK	limited calibration
ne	not required (k, ev, izw, zw not required)	zw	cyclical maintenance (external cyclical maintenance)
ev	periodic self verification	izw	internal cyclical maintenance
Ve	long-term stability recognized	g	blocked for accredited testing
vkl!	Attention: extended calibration interval		
NK!	Attention: not calibrated	*)	next calibration ordered / currently in progress

7.1 Shielded semi anechoic chamber

The radiated measurements are performed in vertical and horizontal plane in the frequency range from 9 kHz to 1 GHz in semi-anechoic chambers. The EUT is positioned on a non-conductive support with a height of 0.80 m above a conductive ground plane that covers the whole chamber. The receiving antennas are confirmed with specifications ANSI C63. These antennas can be moved over the height range between 1.0 m and 4.0 m in order to search for maximum field strength emitted from EUT. The measurement distances between EUT and receiving antennas are indicated in the test setups for the various frequency ranges. For each measurement, the EUT is rotated in all three axes until the maximum field strength is received. The wanted and unwanted emissions are received by spectrum analyzers where the detector modes and resolution bandwidths over various frequency ranges are set according to requirement ANSI C63.

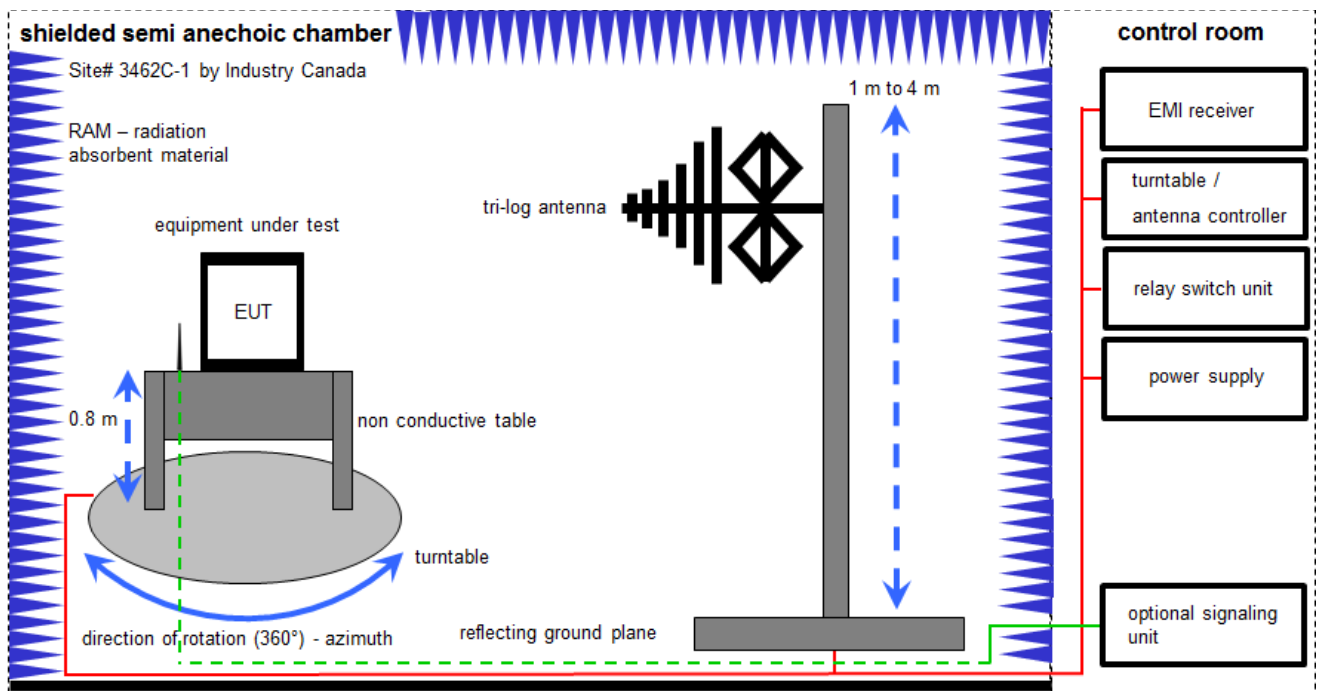

Measurement distance: tri-log antenna 10 meter

$$FS = UR + CL + AF$$

(FS-field strength; UR-voltage at the receiver; CL-loss of the cable; AF-antenna factor)

Example calculation:

$$FS [dB\mu V/m] = 12.35 [dB\mu V/m] + 1.90 [dB] + 16.80 [dB/m] = 31.05 [dB\mu V/m] (35.69 \mu V/m)$$

Equipment table:

No.	Lab / Item	Equipment	Type	Manufacturer	Serial No.	INV. No	Kind of Calibration	Last Calibration	Next Calibration
1	A	Switch-Unit	3488A	HP	2719A14505	300000368	ev	-/-	-/-
2	A	DC power supply, 60Vdc, 50A, 1200 W	6032A	HP	2920A04466	300000580	ne	-/-	-/-
3	A	EMI Test Receiver	ESCI 3	R&S	100083	300003312	k	08.03.2016	08.03.2017
4	A	Antenna Tower	Model 2175	ETS-Lindgren	64762	300003745	izw	-/-	-/-
5	A	Positioning Controller	Model 2090	ETS-Lindgren	64672	300003746	izw	-/-	-/-
6	A	TRILOG Broadband Test-Antenna 30 MHz - 3 GHz	VULB9163	Schwarzbeck	295	300003787	k	25.04.2016	25.04.2018

7.2 Shielded fully anechoic chamber

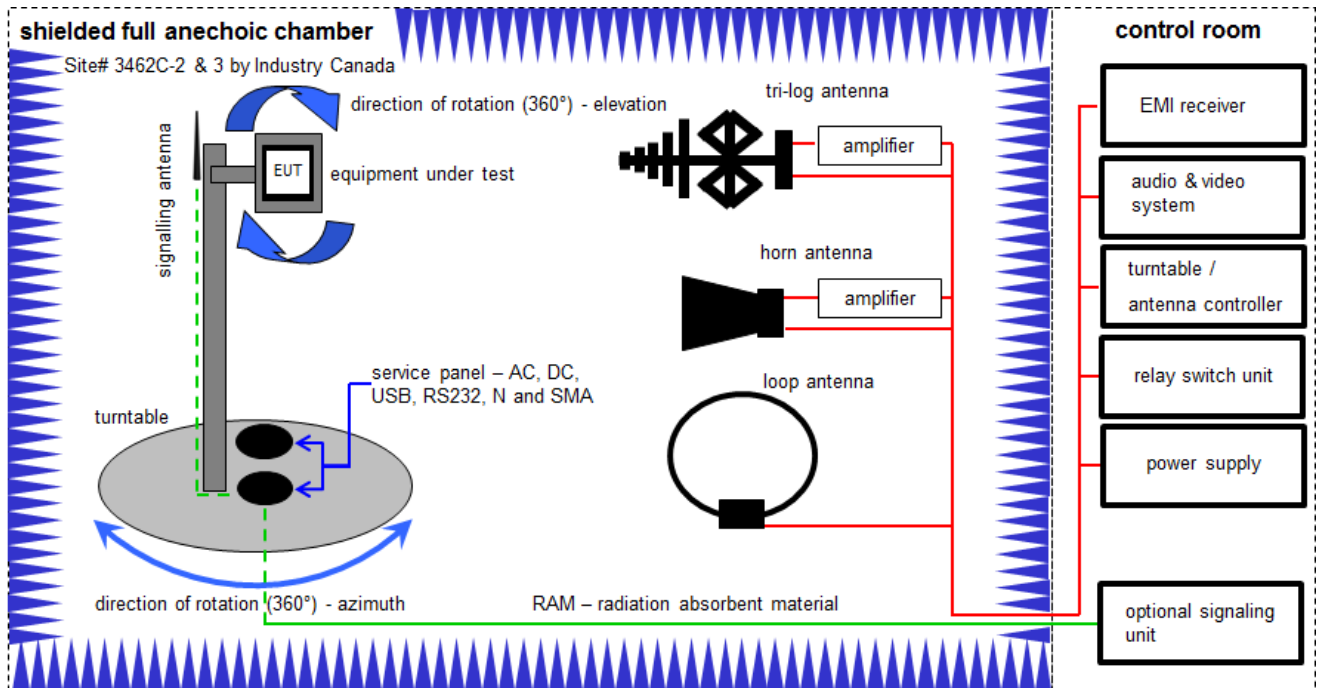

Measurement distance: tri-log antenna and horn antenna 3 meter; loop antenna 3 meter

$$FS = UR + CA + AF$$

(FS-field strength; UR-voltage at the receiver; CA-loss of the signal path; AF-antenna factor)

Example calculation:

$$FS [dB\mu V/m] = 40.0 [dB\mu V/m] + (-35.8) [dB] + 32.9 [dB/m] = 37.1 [dB\mu V/m] (71.61 \mu V/m)$$

Equipment table:

No.	Lab / Item	Equipment	Type	Manufacturer	Serial No.	INV. No	Kind of Calibration	Last Calibration	Next Calibration
1	A	Double-Ridged Waveguide Horn Antenna 1-18.0GHz	3115	EMCO	9709-5290	300000212	k	13.08.2015	13.08.2017
2	A, B, C	EMI Test Receiver 20Hz- 26,5GHz	ESU26	R&S	100037	300003555	k	02.02.2016	02.02.2017
3	A	Highpass Filter	WHKX7.0/18G-8SS	Wainwright	18	300003789	ne	-/-	-/-
4	A	Band Reject Filter	WRCG2400/2483-2375/2505-50/10SS	Wainwright	26	300003792	ne	-/-	-/-
5	A, B	TRILOG Broadband Test-Antenna 30 MHz - 3 GHz	VULB9163	Schwarzbeck	318	300003696	k	22.04.2014	22.04.2017
6	A	Broadband Amplifier 0.5-18 GHz	CBLU5184540	CERNEX	22050	300004482	ev	-/-	-/-
7	A, B, C	4U RF Switch Platform	L4491A	Agilent Technologies	MY50000032	300004510	ne	-/-	-/-
8	C	Active Loop Antenna 10 kHz to 30 MHz	6502	EMCO/2	8905-2342	300000256	k	24.06.2015	24.06.2017
9	D	Std. Gain Horn Antenna 12.4 to 18.0 GHz	639	Narda	8402	300000787	k	14.08.2015	14.08.2017
10	D	Signal Analyzer 40 GHz	FSV40	R&S	101042	300004517	k	21.01.2016	21.01.2017
11	D	Amplifier 2-40 GHz	JS32-02004000-57-5P	MITEQ	1777200	300004541	ev	-/-	-/-
12	D	RF-Cable	ST18/SMAm/SMAm/60	Huber & Suhner	Batch no. 606844	400001181	ev	-/-	-/-
13	D	RF-Cable	ST18/SMAm/SMAm/48	Huber & Suhner	Batch no. 600918	400001182	ev	-/-	-/-
14	D	DC-Blocker 0.1-40 GHz	8141A	Inmet	Batch no. 606844	400001185	ev	-/-	-/-

7.3 Radiated measurements > 18 GHz

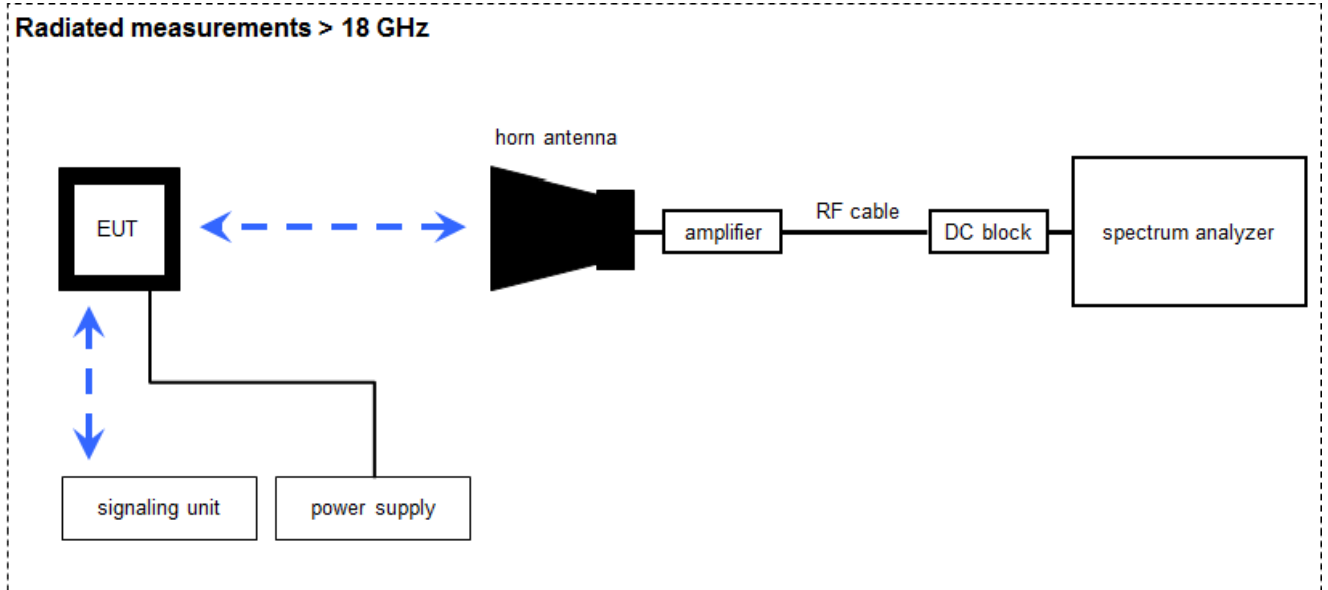

Measurement distance: horn antenna 50 cm

$$FS = U_R + CA + AF$$

(FS-field strength; U_R -voltage at the receiver; CA-loss signal path & distance correction; AF-antenna factor)

Example calculation:

$$FS \text{ [dB}\mu\text{V/m]} = 40.0 \text{ [dB}\mu\text{V/m]} + (-60.1) \text{ [dB]} + 36.74 \text{ [dB/m]} = 16.64 \text{ [dB}\mu\text{V/m]} \text{ (6.79 } \mu\text{V/m)}$$

Equipment table:

No.	Lab / Item	Equipment	Type	Manufacturer	Serial No.	INV. No	Kind of Calibration	Last Calibration	Next Calibration
1	A	Std. Gain Horn Antenna 18.0 to 26.5 GHz	638	Narda	-/-	300000486	k	10.09.2015	10.09.2017
2	A	Signal Analyzer 40 GHz	FSV40	R&S	101042	300004517	k	21.01.2016	21.01.2017
3	A	Amplifier 2-40 GHz	JS32-02004000-57-5P	MITEQ	1777200	300004541	ev	-/-	-/-
4	A	DC Power Supply 0 - 32V	1108-32	Heiden Elektronik	001802	300001383	Ve	29.01.2014	29.01.2017
5	A	RF-Cable	ST18/SMAm/SMAm/60	Huber & Suhner	Batch no. 606844	400001181	ev	-/-	-/-
6	A	RF-Cable	ST18/SMAm/SMAm/48	Huber & Suhner	Batch no. 600918	400001182	ev	-/-	-/-

7.4 Conducted measurements C.BER system

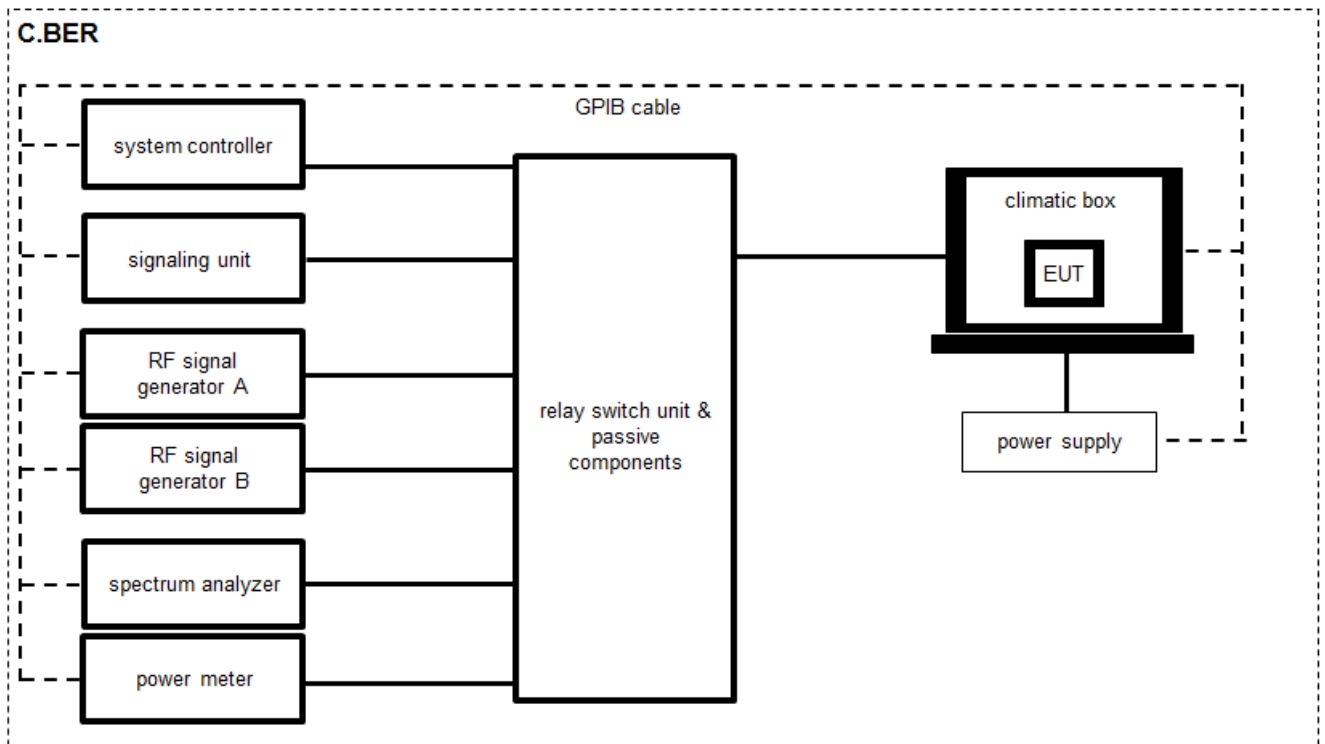

OP = AV + CA
(OP-output power; AV-analyzer value; CA-loss signal path)

Example calculation:

OP [dBm] = 6.0 [dBm] + 11.7 [dB] = 17.7 [dBm] (58.88 mW)

Equipment table:

No.	Lab / Item	Equipment	Type	Manufacturer	Serial No.	INV. No	Kind of Calibration	Last Calibration	Next Calibration
1	A	Switch / Control Unit	3488A	HP		300000929	ne	-/-	-/-
2	A	Power Supply 0-20V, 0-5A	6632B	Agilent Technologies	GB42110541	400000562	v IKI!	26.01.2016	26.01.2019
3	A	Signal Analyzer 30GHz	FSV30	R&S	103170	300004855	k	25.01.2016	25.01.2017
4	A	DC-Blocker	8143	Inmet Corp.	none	300002842	ne	-/-	-/-
5	A	Powersplitter	6005-3	Inmet Corp.	none	300002841	ev	-/-	-/-
6	A	Temperature Test Chamber	VT 4002	Heraeus Voetsch	58566046820010	300003019	ev	03.09.2015	03.09.2017
7	A	RF-Cable	ST18/SMAm/SMAm/72	Huber & Suhner	Batch no. 605505	400001187	ev	-/-	-/-
8	A	RF-Cable	Sucoflex 104	Huber & Suhner	147636/4	400001188	ev	-/-	-/-

8 Sequence of testing

8.1 Sequence of testing radiated spurious 9 kHz to 30 MHz

Setup

- The equipment is set up to simulate normal operation mode as described in the user manual or defined by the manufacturer.
- If the EUT is a tabletop system, a 2-axis positioner with 1.5 m height is used.
- If the EUT is a floor standing device, it is placed directly on the turn table.
- Auxiliary equipment and cables are positioned to simulate normal operation conditions as described in ANSI C 63.4.
- The AC power port of the EUT (if available) is connected to a power outlet below the turntable.
- Measurement distance is 3 m (see ANSI C 63.4) – see test details.
- EUT is set into operation.

Premeasurement

- The turntable rotates from 0° to 315° using 45° steps.
- The antenna height is 1.5 m.
- At each turntable position the analyzer sweeps with positive-peak detector to find the maximum of all emissions.

Final measurement

- Identified emissions during the premeasurement are maximized by the software by rotating the turntable from 0° to 360°. In case of the 2-axis positioner is used the elevation axis is also rotated from 0° to 360°.
- The final measurement is done in the position (turntable and elevation) causing the highest emissions with quasi-peak (as described in ANSI C 63.4).
- Final levels, frequency, measuring time, bandwidth, turntable position, correction factor, margin to the limit and limit will be recorded. A plot with the graph of the premeasurement and the limit is stored.

8.2 Sequence of testing radiated spurious 30 MHz to 1 GHz

Setup

- The equipment is set up to simulate normal operation mode as described in the user manual or defined by the manufacturer.
- If the EUT is a tabletop system, a table with 0.8 m height is used, which is placed on the ground plane.
- If the EUT is a floor standing device, it is placed on the ground plane with insulation between both.
- Auxiliary equipment and cables are positioned to simulate normal operation conditions as described in ANSI C 63.4.
- The AC power port of the EUT (if available) is connected to a power outlet below the turntable.
- Measurement distance is 10 m or 3 m (see ANSI C 63.4) – see test details.
- EUT is set into operation.

Premeasurement

- The turntable rotates from 0° to 315° using 45° steps.
- The antenna is polarized vertical and horizontal.
- The antenna height changes from 1 m to 3 m.
- At each turntable position, antenna polarization and height the analyzer sweeps three times in peak to find the maximum of all emissions.

Final measurement

- The final measurement is performed for at least six highest peaks according to the requirements of the ANSI C63.4.
- Based on antenna and turntable positions at which the peak values are measured the software maximize the peaks by changing turntable position $\pm 45^\circ$ and antenna height between 1 and 4 m.
- The final measurement is done with quasi-peak detector (as described in ANSI C 63.4).
- Final levels, frequency, measuring time, bandwidth, antenna height, antenna polarization, turntable angle, correction factor, margin to the limit and limit are recorded. A plot with the graph of the premeasurement with marked maximum final results and the limit is stored.

8.3 Sequence of testing radiated spurious 1 GHz to 18 GHz

Setup

- The equipment is set up to simulate normal operation mode as described in the user manual or defined by the manufacturer.
- If the EUT is a tabletop system, a 2-axis positioner with 1.5 m height is used.
- If the EUT is a floor standing device, it is placed directly on the turn table.
- Auxiliary equipment and cables are positioned to simulate normal operation conditions as described in ANSI C 63.4.
- The AC power port of the EUT (if available) is connected to a power outlet below the turntable.
- Measurement distance is 3 m (see ANSI C 63.4) – see test details.
- EUT is set into operation.

Premeasurement

- The turntable rotates from 0° to 315° using 45° steps.
- The antenna is polarized vertical and horizontal.
- The antenna height is 1.5 m.
- At each turntable position and antenna polarization the analyzer sweeps with positive peak detector to find the maximum of all emissions.

Final measurement

- The final measurement is performed for at least six highest peaks according to the requirements of the ANSI C63.4.
- Based on antenna and turntable positions at which the peak values are measured the software maximizes the peaks by rotating the turntable from 0° to 360°. This measurement is repeated for different EUT-table positions (0° to 150° in 30°-steps) and for both antenna polarizations.
- The final measurement is done in the position (turntable, EUT-table and antenna polarization) causing the highest emissions with Peak and RMS detector (as described in ANSI C 63.4).
- Final levels, frequency, measuring time, bandwidth, turntable position, EUT-table position, antenna polarization, correction factor, margin to the limit and limit are recorded. A plot with the graph of the premeasurement with marked maximum final results and the limit is stored.

8.4 Sequence of testing radiated spurious above 18 GHz

Setup

- The equipment is set up to simulate normal operation mode as described in the user manual or defined by the manufacturer.
- Auxiliary equipment and cables are positioned to simulate normal operation conditions as described in ANSI C 63.4.
- The AC power port of the EUT (if available) is connected to a power outlet.
- The measurement distance is as appropriate (e.g. 0.5 m).
- The EUT is set into operation.

Premeasurement

- The test antenna is handheld and moved carefully over the EUT to cover the EUT's whole sphere and different polarizations of the antenna.

Final measurement

- The final measurement is performed at the position and antenna orientation causing the highest emissions with Peak and RMS detector (as described in ANSI C 63.4).
- Final levels, frequency, measuring time, bandwidth, correction factor, margin to the limit and limit are recorded. A plot with the graph of the premeasurement and the limit is stored.

9 Measurement uncertainty

Measurement uncertainty	
Test case	Uncertainty
Antenna gain	± 3 dB
Spectrum bandwidth	± 21.5 kHz absolute; ± 15.0 kHz relative
Maximum output power	± 1 dB
Detailed conducted spurious emissions @ the band edge	± 1 dB
Band edge compliance radiated	± 3 dB
Spurious emissions conducted	± 3 dB
Spurious emissions radiated below 30 MHz	± 3 dB
Spurious emissions radiated 30 MHz to 1 GHz	± 3 dB
Spurious emissions radiated 1 GHz to 12.75 GHz	± 3.7 dB
Spurious emissions radiated above 12.75 GHz	± 4.5 dB
Spurious emissions conducted below 30 MHz (AC conducted)	± 2.6 dB

10 Summary of measurement results

<input checked="" type="checkbox"/>	No deviations from the technical specifications were ascertained
<input type="checkbox"/>	There were deviations from the technical specifications ascertained
<input type="checkbox"/>	This test report is only a partial test report. The content and verdict of the performed test cases are listed below.

TC Identifier	Description	Verdict	Date	Remark
RF-Testing	CFR Part 15 RSS - 247, Issue 2	See table!	2018-04-17	-/-

Test specification clause	Test case	Guideline	Temperature conditions	Power source voltages	Mode	C	NC	NA	NP	Remark
§15.247(b)(4) RSS - 247 / 5.4 (4)	System gain	-/-	Nominal	Nominal	GFSK	<input checked="" type="checkbox"/>	<input type="checkbox"/>	<input type="checkbox"/>	<input type="checkbox"/>	-/-
§15.247(e) RSS - 247 / 5.2 (2)	Power spectral density	KDB 558074 DTS clause: 10.6	Nominal	Nominal	GFSK	<input checked="" type="checkbox"/>	<input type="checkbox"/>	<input type="checkbox"/>	<input type="checkbox"/>	-/-
§15.247(a)(2) RSS - 247 / 5.2 (1)	DTS bandwidth – 6 dB bandwidth	KDB 558074 DTS clause: 8.1	Nominal	Nominal	GFSK	<input checked="" type="checkbox"/>	<input type="checkbox"/>	<input type="checkbox"/>	<input type="checkbox"/>	-/-
RSS Gen clause 4.6.1	Occupied bandwidth	-/-	Nominal	Nominal	GFSK	<input checked="" type="checkbox"/>	<input type="checkbox"/>	<input type="checkbox"/>	<input type="checkbox"/>	-/-
§15.247(b)(3) RSS - 247 / 5.4 (4)	Maximum output power	KDB 558074 DTS clause: 9.1.1	Nominal	Nominal	GFSK	<input checked="" type="checkbox"/>	<input type="checkbox"/>	<input type="checkbox"/>	<input type="checkbox"/>	-/-
§15.247(d) RSS - 247 / 5.5	Detailed spurious emissions @ the band edge - conducted	-/-	Nominal	Nominal	GFSK	<input checked="" type="checkbox"/>	<input type="checkbox"/>	<input type="checkbox"/>	<input type="checkbox"/>	-/-
§15.205 RSS - 247 / 5.5 RSS - Gen	Band edge compliance radiated	KDB 558074 DTS clause: 12	Nominal	Nominal	GFSK	<input checked="" type="checkbox"/>	<input type="checkbox"/>	<input type="checkbox"/>	<input type="checkbox"/>	-/-
§15.247(d) RSS - 247 / 5.5	TX spurious emissions conducted	KDB 558074 DTS clause: 11.1 & 11.2 11.3	Nominal	Nominal	GFSK	<input checked="" type="checkbox"/>	<input type="checkbox"/>	<input type="checkbox"/>	<input type="checkbox"/>	-/-
§15.209(a) RSS - Gen	Spurious emissions radiated below 30 MHz	-/-	Nominal	Nominal	GFSK	<input checked="" type="checkbox"/>	<input type="checkbox"/>	<input type="checkbox"/>	<input type="checkbox"/>	-/-
§15.247(d) RSS - 247 / 5.5 §15.109 RSS - Gen	Spurious emissions radiated 30 MHz to 1 GHz	-/-	Nominal	Nominal	-/-	<input checked="" type="checkbox"/>	<input type="checkbox"/>	<input type="checkbox"/>	<input type="checkbox"/>	-/-
§15.247(d) RSS - 247 / 5.5 §15.109 RSS - Gen	Spurious emissions radiated above 1 GHz	-/-	Nominal	Nominal	GFSK	<input checked="" type="checkbox"/>	<input type="checkbox"/>	<input type="checkbox"/>	<input type="checkbox"/>	-/-
§15.107(a) §15.207	Conducted emissions below 30 MHz (AC conducted)	-/-	Nominal	Nominal	GFSK	<input type="checkbox"/>	<input type="checkbox"/>	<input checked="" type="checkbox"/>	<input type="checkbox"/>	Only battery powered

Note: C = Compliant; NC = Not compliant; NA = Not applicable; NP = Not performed

11 Additional comments

The Bluetooth® word mark and logos are owned by the Bluetooth SIG Inc. and any use of such marks by CTC advanced GmbH is under license.

Reference documents: None

Special test descriptions: None

Configuration descriptions: TX tests: were performed with LE packets (37 byte payload) and static PRBS pattern.
RX/Standby tests: BT enabled, TX Idle
Tested frequencies: lowest: 2402 MHz
middle: 2440 MHz
- highest: 2480 MHz

Test mode:

Bluetooth LE Test mode enabled
(EUT is controlled over CBT)

Special software is used.
EUT is transmitting pseudo random data by itself

Antennas and transmit operating modes:

Operating mode 1 (single antenna)

- *Equipment with 1 antenna,*
- *Equipment with 2 diversity antennas operating in switched diversity mode by which at any moment in time only 1 antenna is used,*
- *Smart antenna system with 2 or more transmit/receive chains, but operating in a mode where only 1 transmit/receive chain is used)*

Operating mode 2 (multiple antennas, no beamforming)

- *Equipment operating in this mode contains a smart antenna system using two or more transmit/receive chains simultaneously but without beamforming.*

Operating mode 3 (multiple antennas, with beamforming)

- *Equipment operating in this mode contains a smart antenna system using two or more transmit/receive chains simultaneously with beamforming. In addition to the antenna assembly gain (G), the beamforming gain (Y) may have to be taken into account when performing the measurements.*

12 Measurement results

12.1 System gain

Measurement:

The antenna gain of the complete system is calculated by the difference of radiated power in EIRP and the conducted power of the module. For normal Bluetooth® devices, the GFSK modulation is used.

Measurement parameters	
Detector	Peak
Sweep time	Auto
Resolution bandwidth	3 MHz
Video bandwidth	3 MHz
Span	5 MHz
Trace mode	Max hold
Test setup	See sub clause 7.2 B (radiated) See sub clause 7.4 A (conducted)
Measurement uncertainty	See sub clause 9

Limits:

FCC	IC
6 dBi / > 6 dBi output power and power density reduction required	

Results:

T _{nom}	V _{nom}	2402 MHz	2440 MHz	2480 MHz
Conducted power [dBm] Measured with GFSK modulation		-2.0	-1.9	-2.4
Radiated power [dBm] Measured with GFSK modulation		-9.8	-11.1	-11.5
Gain [dBi] Calculated		-7.8	-9.2	-9.1

12.2 Power spectral density

Description:

Measurement of the power spectral density of a digital modulated system.

Measurement parameters	
Detector	Peak
Sweep time	Auto
Resolution bandwidth	3 kHz
Video bandwidth	10 kHz
Span	≥ EBW
Trace mode	Max hold
Test setup	See sub clause 7.4 A
Measurement uncertainty	See sub clause 9

Limits:

FCC	IC
Power spectral density	
For digitally modulated systems the transmitter power spectral density conducted from the transmitter to the antenna shall not be greater than 8 dBm in any 3 kHz band during any time interval of continuous transmission or over 1.0 second if the transmission exceeds 1.0-second duration.	

Results:

	Frequency		
	2402 MHz	2440 MHz	2480 MHz
Power spectral density [dBm / 3kHz]	-13.9	-13.3	-14.0

Plots:

Plot 1: lowest channel

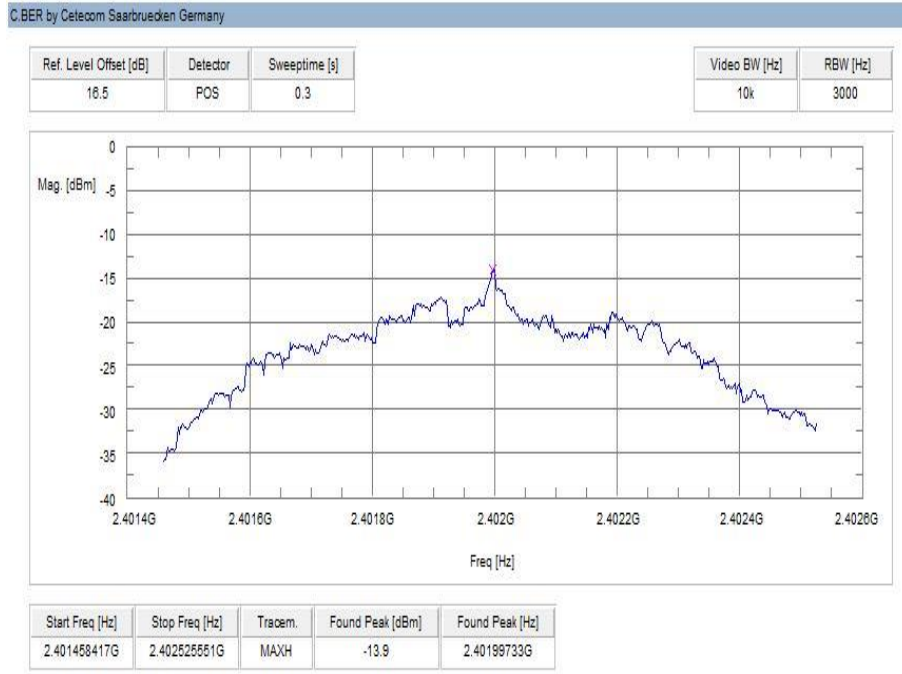

Plot 2: mid channel

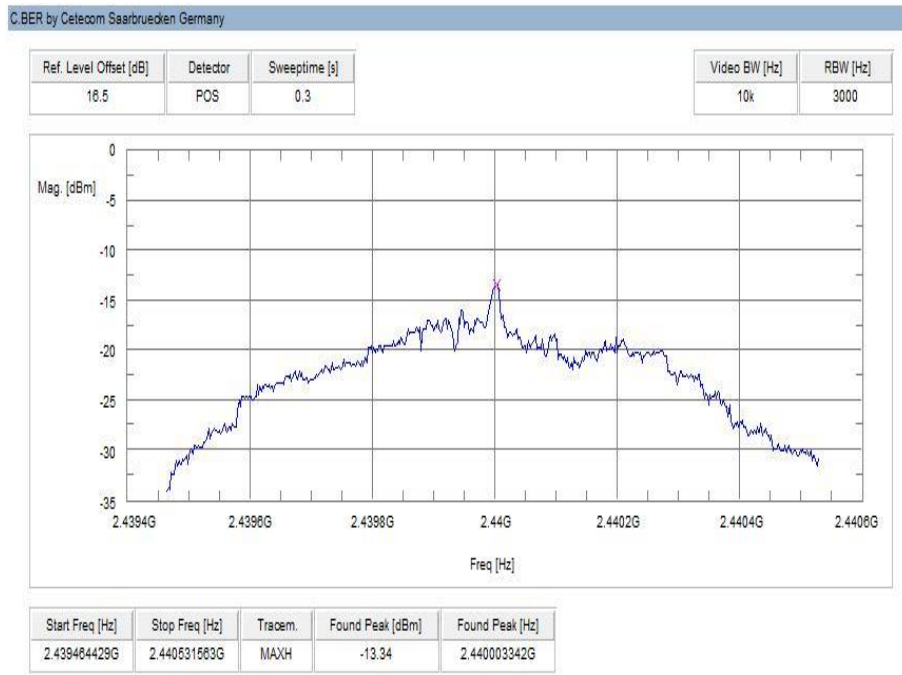

Plot 3: highest channel

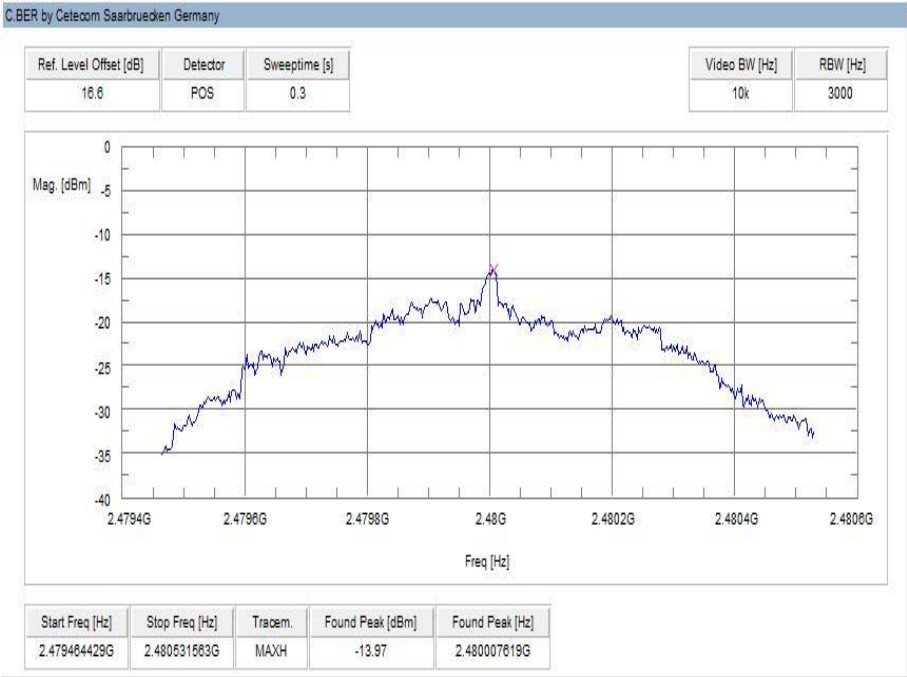

12.3 DTS bandwidth – 6 dB bandwidth

Description:

Measurement of the 6 dB bandwidth of the modulated signal.

Measurement parameters	
According to DTS clause: 8.1	
Detector	Peak
Sweep time	Auto
Resolution bandwidth	100 kHz
Video bandwidth	300 kHz
Span	5 MHz
Measurement procedure	Using 3 marker (max + 2x-6dB)
Trace mode	Max hold (allow trace to stabilize)
Test setup	See sub clause 7.4 A
Measurement uncertainty	See sub clause 9

Limits:

FCC	IC
DTS bandwidth – 6 dB bandwidth	
Systems using digital modulation techniques may operate in the 2400–2483.5 MHz band. The minimum 6 dB bandwidth shall be at least 500 kHz.	

Results:

	Frequency		
	2402 MHz	2440 MHz	2480 MHz
6 dB bandwidth [kHz]	711	711	711

Plots:

Plot 1: lowest channel

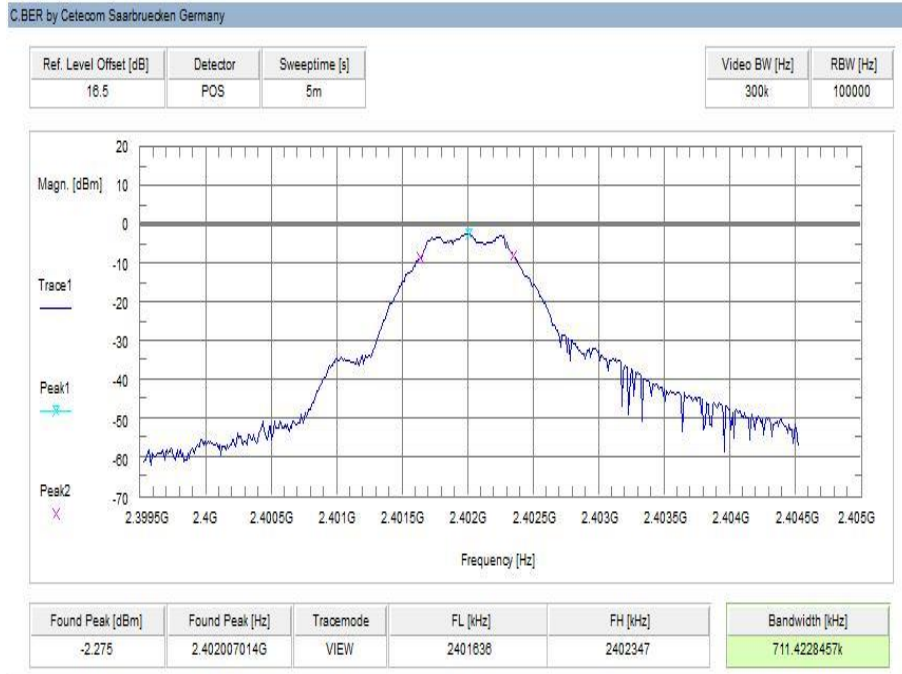

Plot 2: mid channel

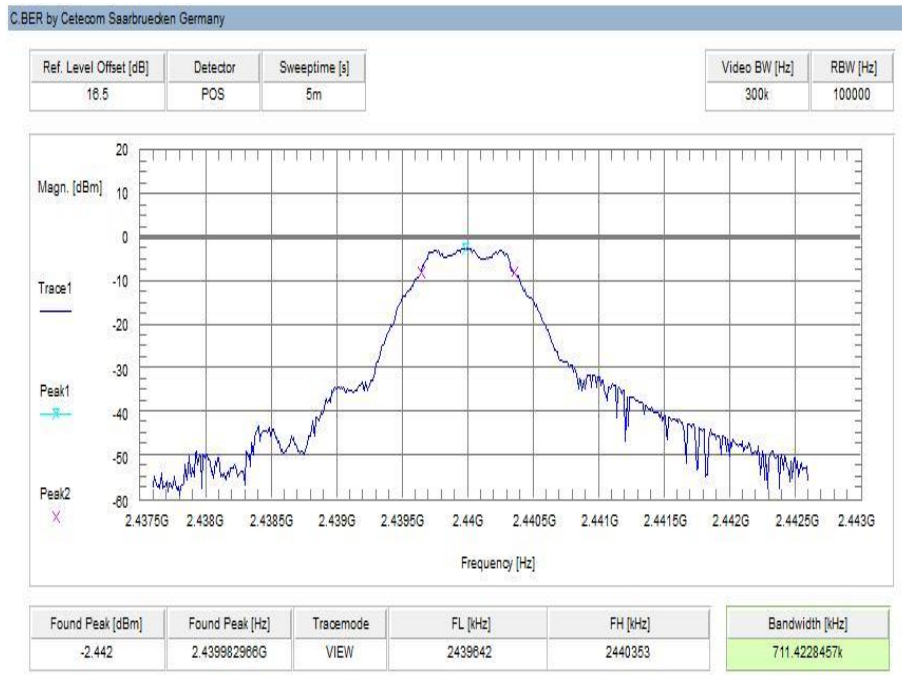

Plot 3: highest channel

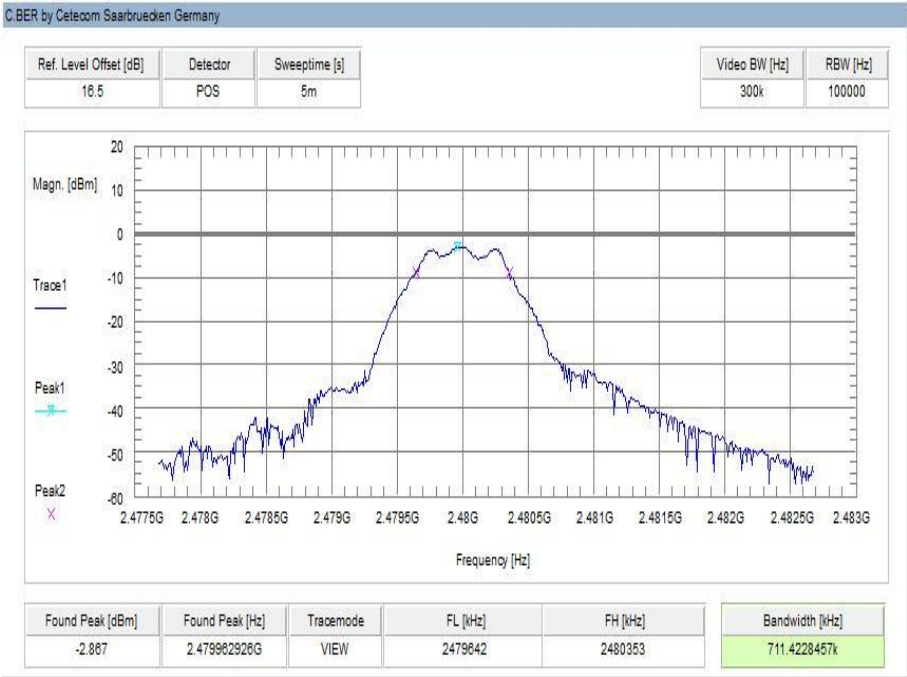

12.4 Occupied bandwidth – 99% emission bandwidth

Description:

Measurement of the 99% bandwidth of the modulated signal acc. RSS-GEN.

Measurement parameters	
Detector	Peak
Sweep time	Auto
Resolution bandwidth	30 kHz
Video bandwidth	100 kHz
Span	5 MHz
Measurement procedure	Measurement of the 99% bandwidth using the integration function of the analyzer
Trace mode	Max hold (allow trace to stabilize)
Test setup	See sub clause 7.4 A
Measurement uncertainty	See sub clause 9

Usage:

-/-	IC
Occupied bandwidth – 99% emission bandwidth	
OBW is necessary for emission designator	

Results:

	Frequency		
	2402 MHz	2440 MHz	2480 MHz
99% bandwidth [kHz]	1022	1032	1022

Plots:

Plot 1: lowest channel

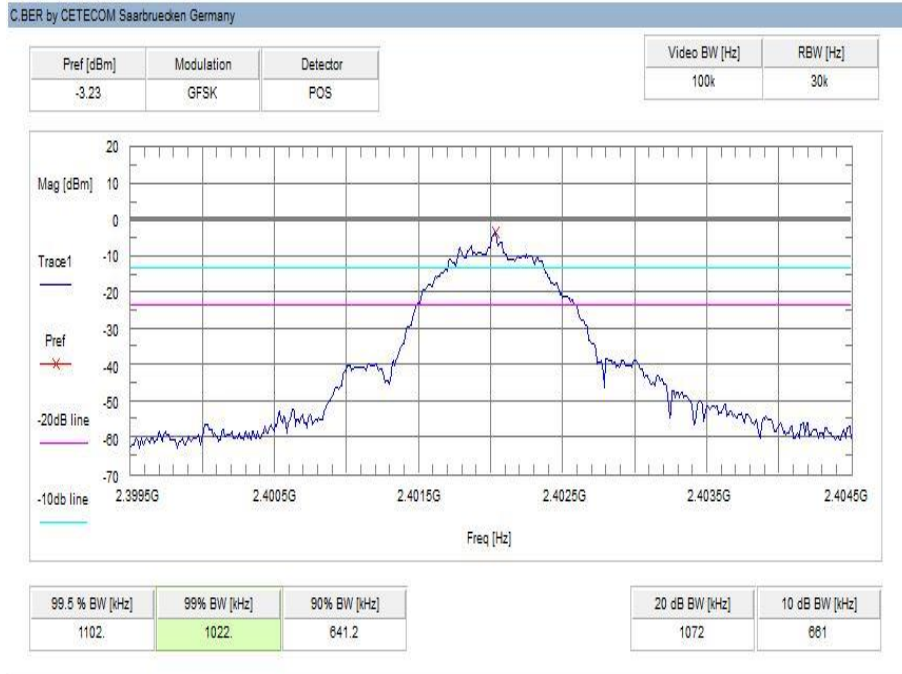

Plot 2: mid channel

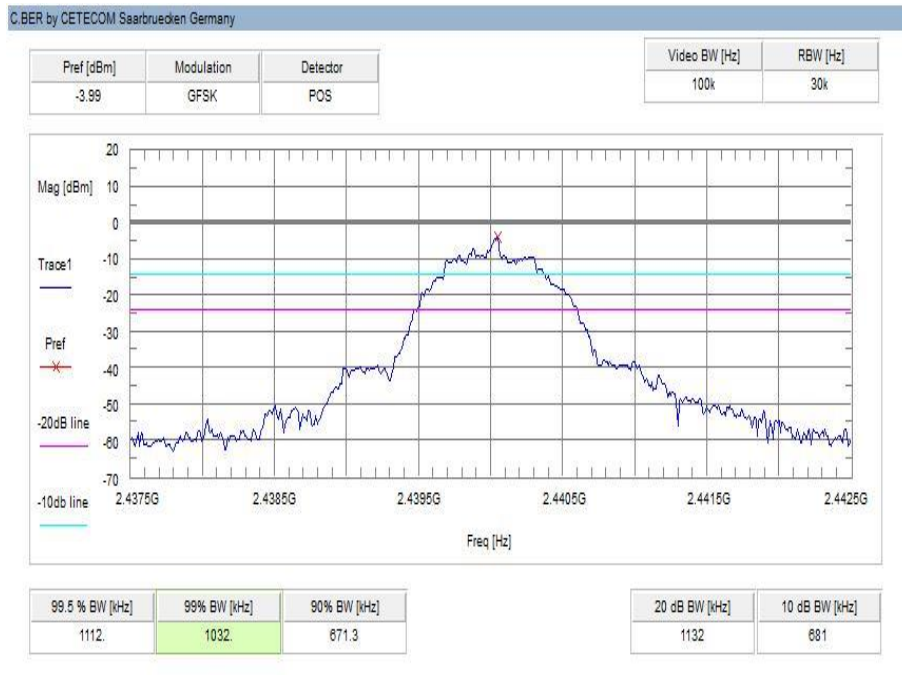

Plot 3: highest channel

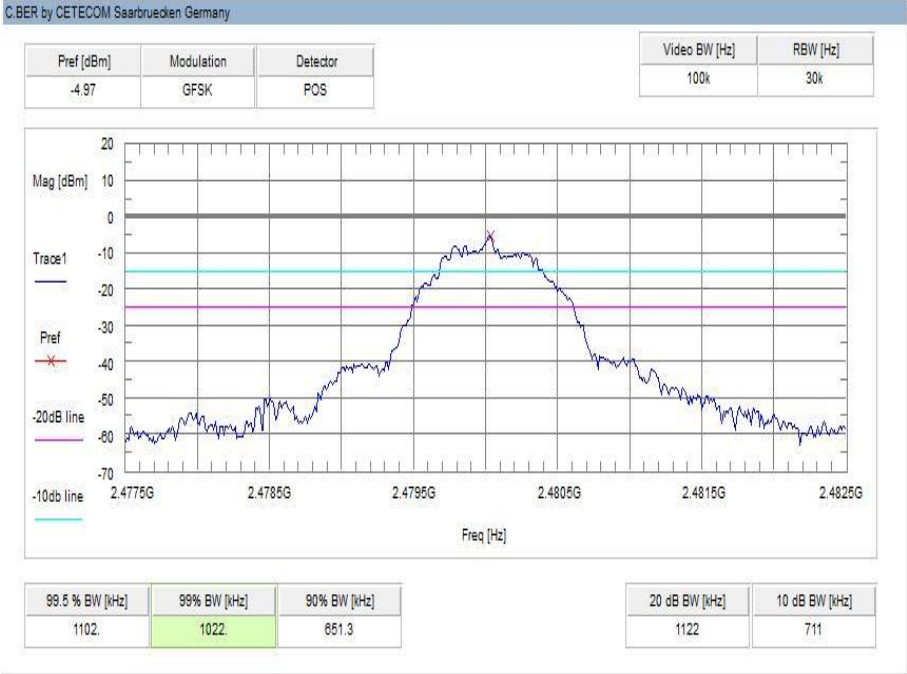

12.5 Maximum output power

Description:

Measurement of the maximum output power conducted and radiated. EUT in single channel mode.

Measurement parameters	
Detector	Peak
Sweep time	Auto
Resolution bandwidth	3 MHz
Video bandwidth	10 MHz
Span	10 MHz
Trace mode	Max hold
Test setup	See sub clause 7.4 A
Measurement uncertainty	See sub clause 9

Limits:

FCC	IC
Maximum output power	
[Conducted: 0.125 W – antenna gain max. 6 dBi] Systems using more than 75 hopping channels: Conducted: 1.0 W – antenna gain max. 6 dBi	

Results:

	Frequency		
	2402 MHz	2440 MHz	2480 MHz
Maximum output power conducted [dBm]	-2.0	-1.9	-2.4

Plots:

Plot 1: lowest channel

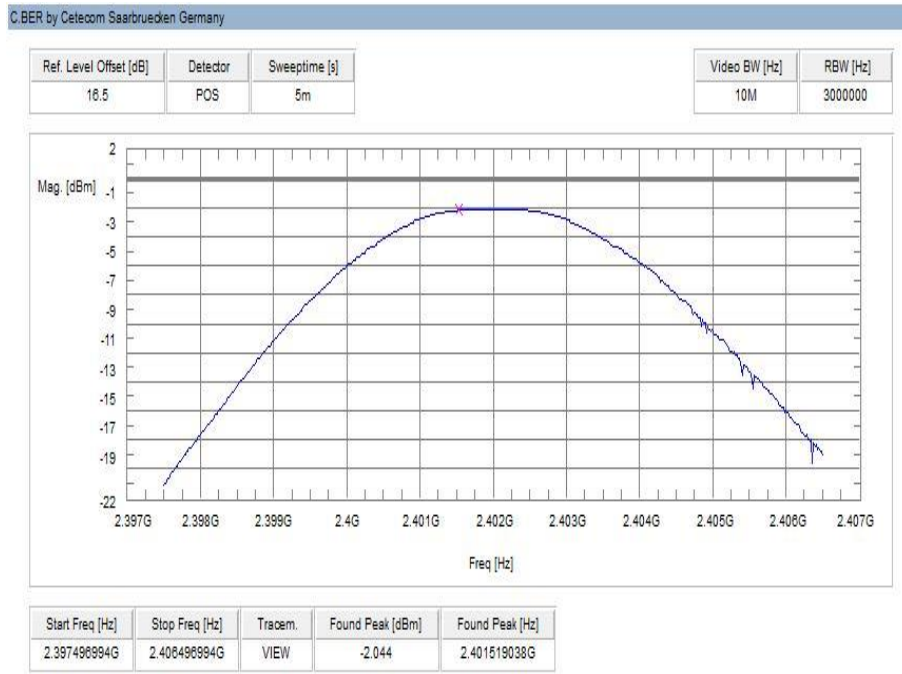

Plot 2: mid channel

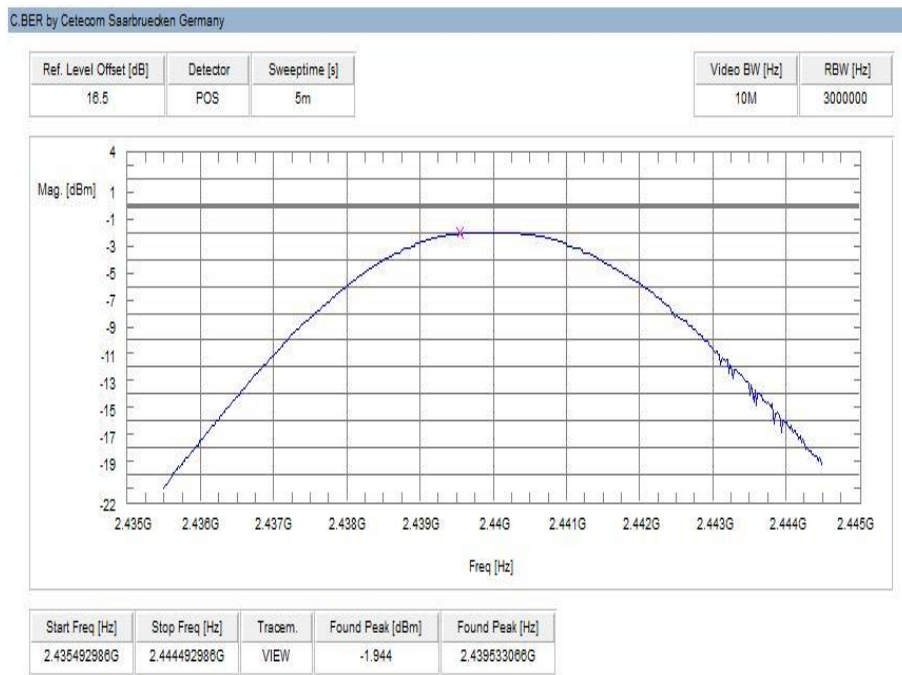

Plot 3: highest channel

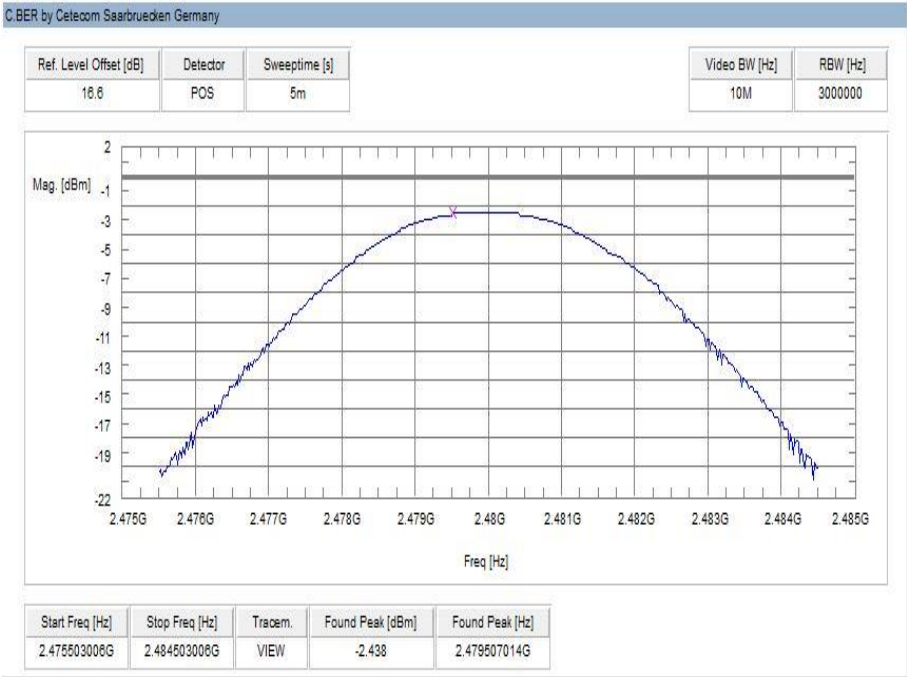

12.6 Detailed spurious emissions @ the band edge - conducted

Description:

Measurement of the conducted band edge compliance. EUT is measured at the lower and upper band edge in single channel.

Measurement parameters	
Detector	Peak
Sweep time	Auto
Resolution bandwidth	100 kHz
Video bandwidth	300 kHz / 500 kHz
Span	Lower Band Edge: 2395 – 2405 MHz higher Band Edge: 2478 – 2489 MHz
Trace mode	Max hold
Test setup	See sub clause 7.4 A
Measurement uncertainty	See sub clause 9

Limits:

FCC	IC
In any 100 kHz bandwidth outside the frequency band in which the spread spectrum or digitally modulated intentional radiator is operating, the radio frequency power that is produced by the intentional radiator shall be at least 20 dB below that in the 100 kHz bandwidth within the band that contains the highest level of the desired power, based on either an RF conducted or a radiated measurement. Attenuation below the general limits specified in Section 15.209(a) is not required.	

Result:

Scenario	Spurious band edge conducted [dB]
Modulation	GFSK
Lower band edge – hopping off	> 20 dB
Upper band edge – hopping off	> 20 dB

Plots:

Plot 1: Lower band edge

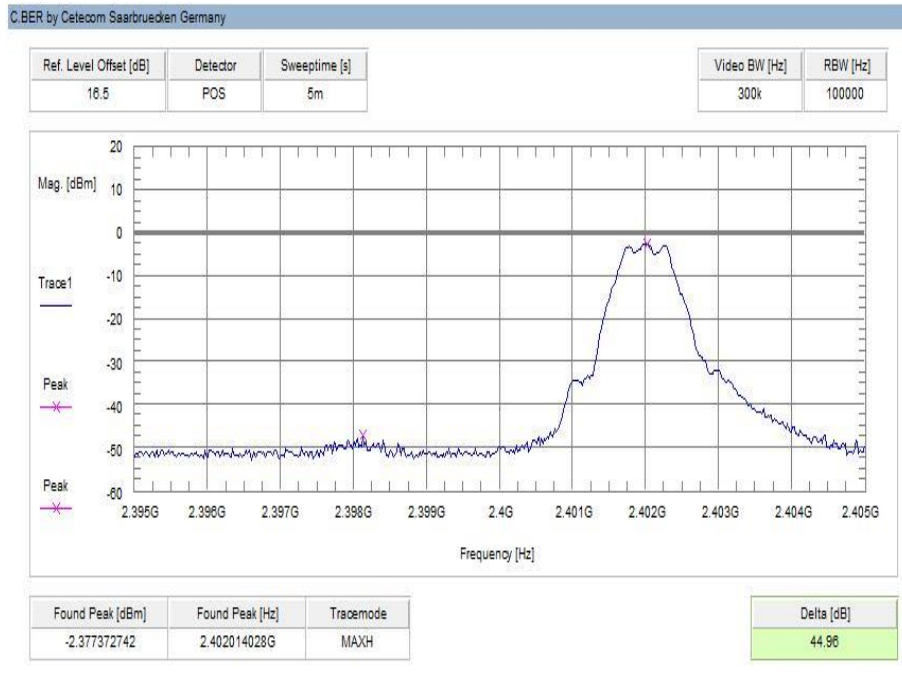

Plot 2: Upper band edge

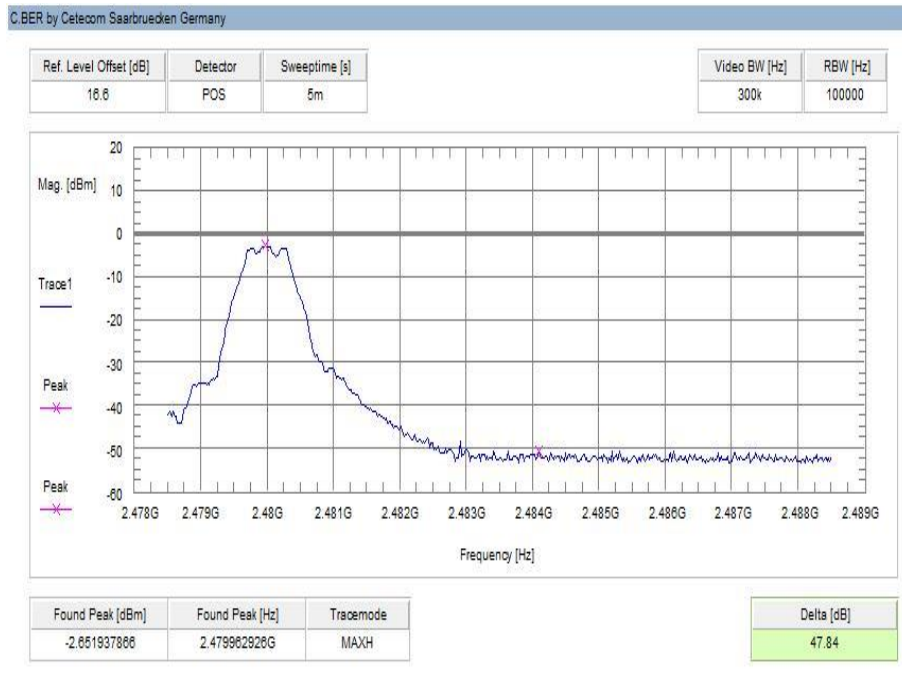

12.7 Band edge compliance radiated

Description:

Measurement of the radiated band edge compliance. The EUT is turned in the position that results in the maximum level at the band edge. Then a sweep over the corresponding restricted band is performed. The EUT is set to single channel mode and the transmit frequency 2402 MHz for the lower restricted band and 2480 MHz for the upper restricted band. Measurement distance is 3m.

Measurement parameters	
Detector	Peak / RMS
Sweep time	Auto
Resolution bandwidth	1 MHz
Video bandwidth	3 MHz
Span	Lower Band: 2300 – 2400 MHz higher Band: 2480 – 2500 MHz
Trace mode	Max hold
Test setup	See sub clause 7.2 B
Measurement uncertainty	See sub clause 9

Limits:

FCC	IC
Band edge compliance radiated	
<p>In any 100 kHz bandwidth outside the frequency band in which the spread spectrum or digitally modulated intentional radiator is operating, the radio frequency power that is produced by the intentional radiator shall be at least 20 dB below that in the 100 kHz bandwidth within the band that contains the highest level of the desired power, based on either an RF conducted or a radiated measurement. Attenuation below the general limits specified in Section 15.209(a) is not required. In addition, radiated emissions which fall in the restricted bands, as defined in Section 15.205(a), must also comply with the radiated emission limits specified in Section 15.209(a) (see Section 5.205(c)).</p>	
54 dBµV/m AVG 74 dBµV/m Peak	

Result:

Scenario	Band edge compliance radiated [dBµV/m]
Modulation	GFSK
Lower restricted band	< 54 AVG / < 74 PP
Upper restricted band	< 54 AVG / < 74 PP

Plots:

Plot 1: Lower restricted band

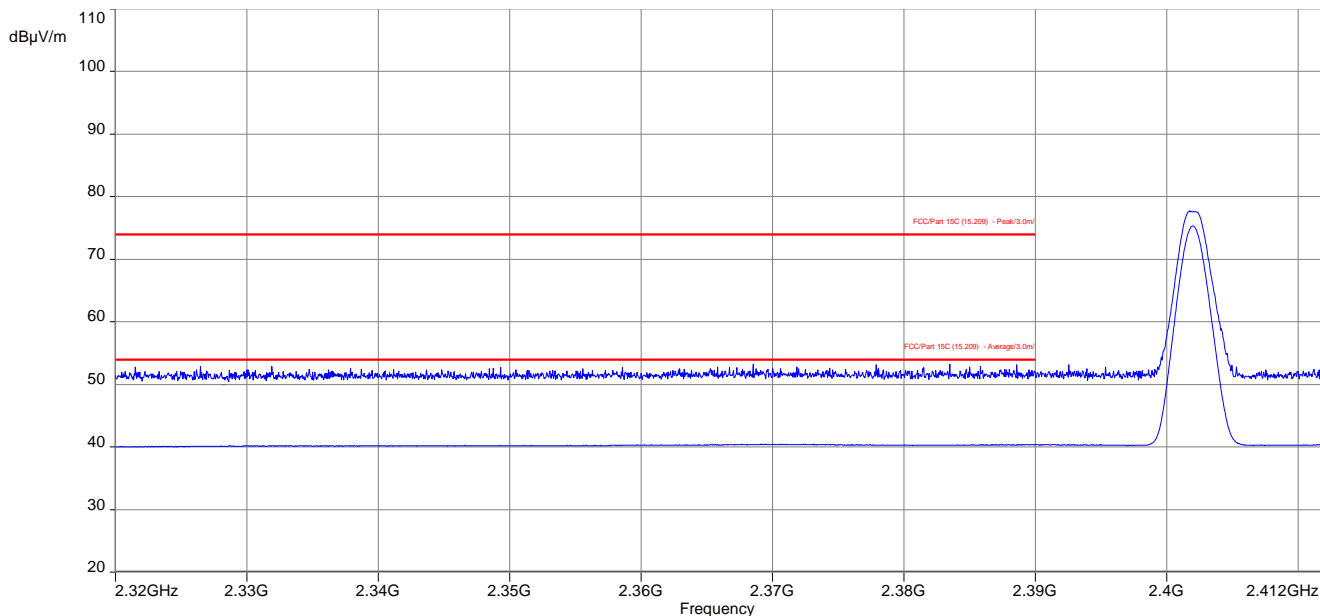

Plot 2: Upper restricted band

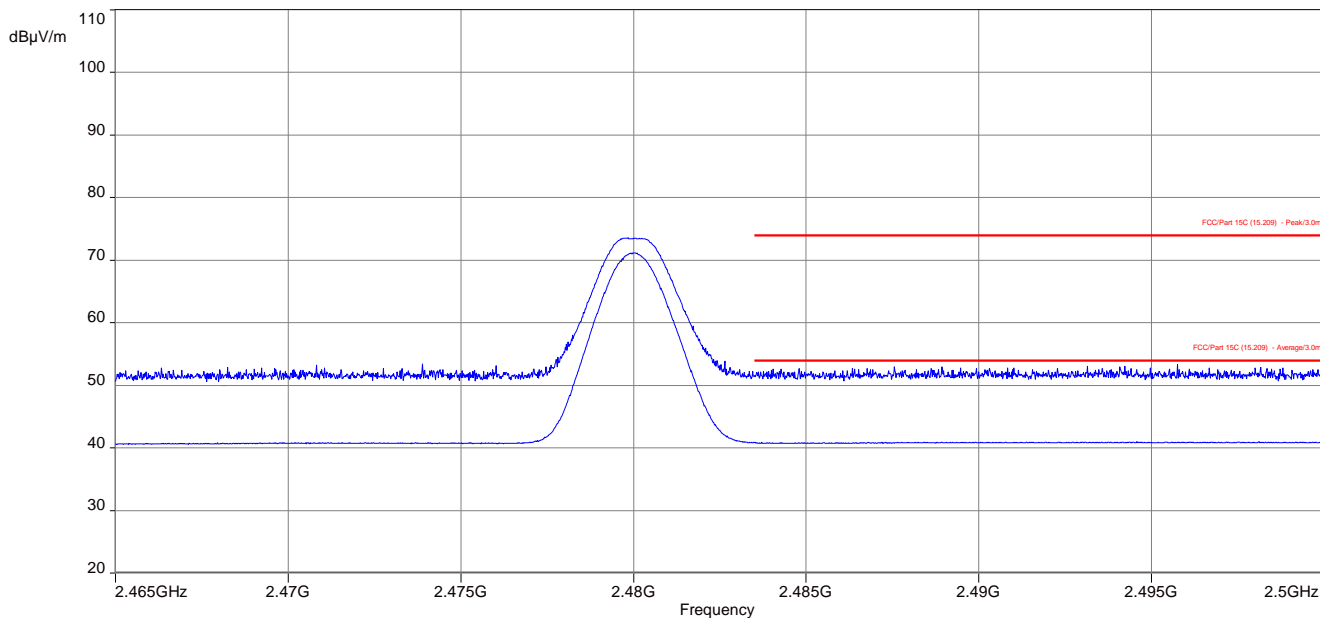

12.8 TX spurious emissions conducted

Description:

Measurement of the conducted spurious emissions in transmit mode. The EUT is set to single channel mode and the transmit frequencies are 2402 MHz, 2440 MHz and 2480 MHz.

Measurement parameters	
Detector	Peak
Sweep time	Auto
Resolution bandwidth	100 kHz
Video bandwidth	300 kHz or 500 kHz
Span	9 kHz to 25 GHz
Trace mode	Max hold
Test setup	See sub clause 7.4 A
Measurement uncertainty	See sub clause 9

Limits:

FCC	IC
TX spurious emissions conducted	
<p>In any 100 kHz bandwidth outside the frequency band in which the spread spectrum or digitally modulated intentional radiator is operating, the radio frequency power that is produced by the intentional radiator shall be at least 20 dB below that in the 100 kHz bandwidth within the band that contains the highest level of the desired power, based on either an RF conducted or a radiated measurement. Attenuation below the general limits specified in Section 15.209(a) is not required</p>	

Results:

TX spurious emissions conducted					
f [MHz]		amplitude of emission [dBm]	limit max. allowed emission power	actual attenuation below frequency of operation [dB]	results
2402		-2.5	30 dBm		Operating frequency
All detected emissions are compliant with the -20 dBc limit!			-20 dBc		compliant
2440		-2.4	30 dBm		Operating frequency
All detected emissions are compliant with the -20 dBc limit!			-20 dBc		compliant
2480		-2.8	30 dBm		Operating frequency
All detected emissions are compliant with the -20 dBc limit!			-20 dBc		compliant

Plots:

Plot 1: lowest channel

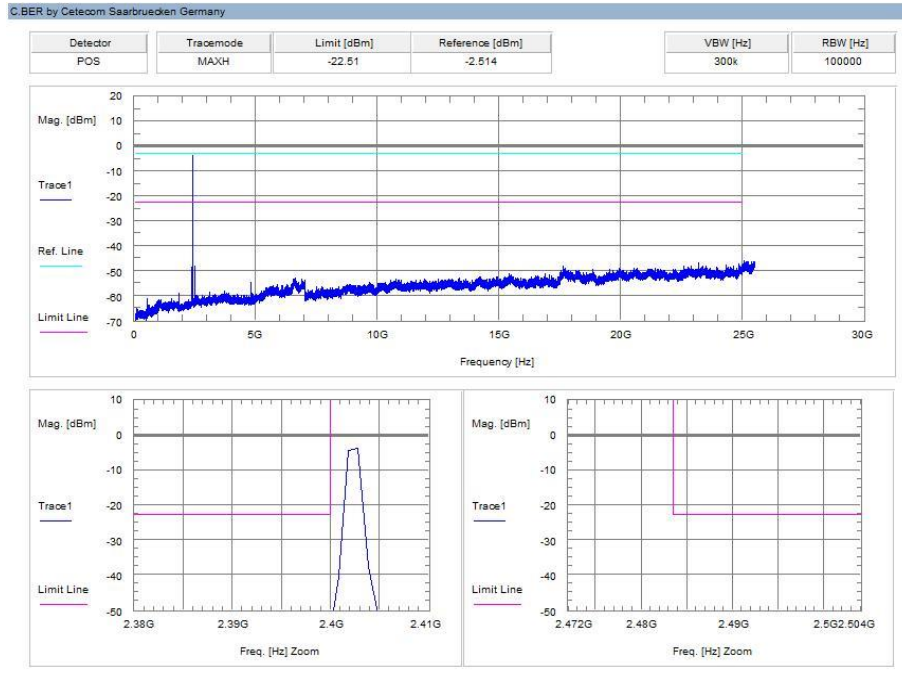

Plot 2: mid channel

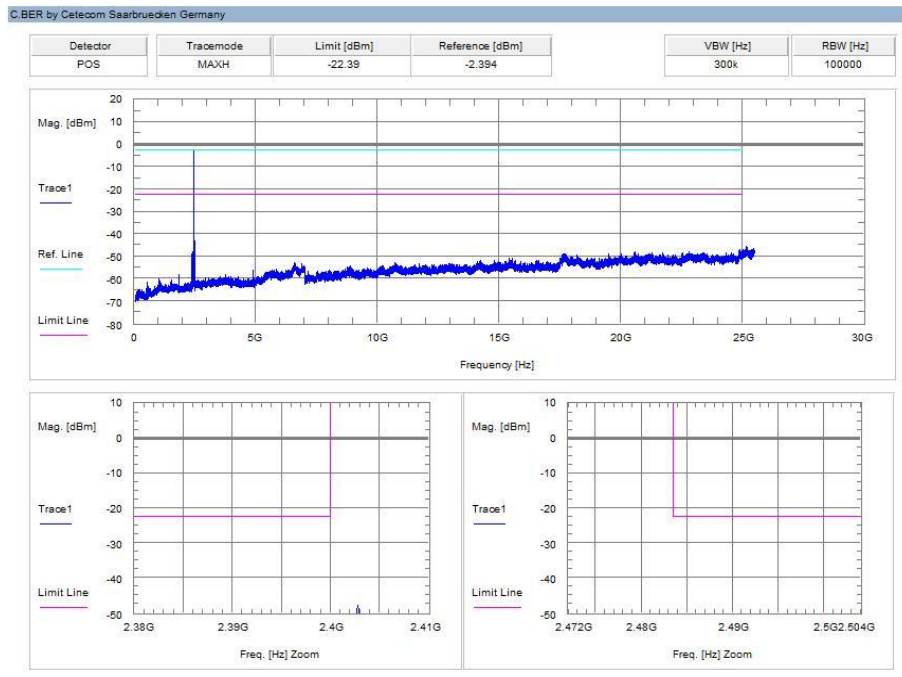

Plot 3: highest channel

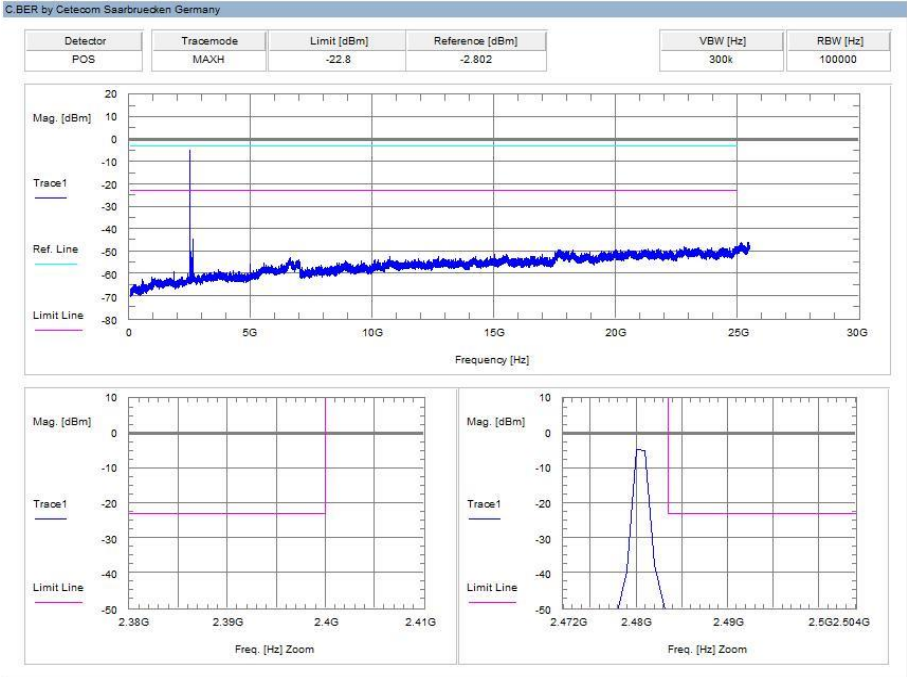

12.9 Spurious emissions radiated below 30 MHz

Description:

Measurement of the radiated spurious emissions in transmit mode below 30 MHz. The EUT is set to single channel mode and the transmit frequencies are 2402 MHz, 2440 MHz and 2480 MHz. The measurement is performed in the mode with the highest output power. The limits are recalculated to a measurement distance of 3 m according to the ANSI C63.10.

Measurement parameters	
Detector	Peak / Quasi peak
Sweep time	Auto
Resolution bandwidth	F < 150 kHz: 200 Hz F > 150 kHz: 9 kHz
Video bandwidth	F < 150 kHz: 1 kHz F > 150 kHz: 30 kHz
Span	9 kHz to 30 MHz
Trace mode	Max hold
Test setup	See sub clause 7.2 C
Measurement uncertainty	See sub clause 9

Limits:

FCC		IC
TX spurious emissions radiated below 30 MHz		
Frequency (MHz)	Field strength (dB μ V/m)	Measurement distance
0.009 – 0.490	2400/F(kHz)	300
0.490 – 1.705	24000/F(kHz)	30
1.705 – 30.0	30	30

Results:

TX spurious emissions radiated below 30 MHz [dB μ V/m]		
F [MHz]	Detector	Level [dB μ V/m]
All detected emissions are more than 20 dB below the limit.		

Plots:

Plot 1: 9 kHz to 30 MHz, 2402 MHz, transmit mode

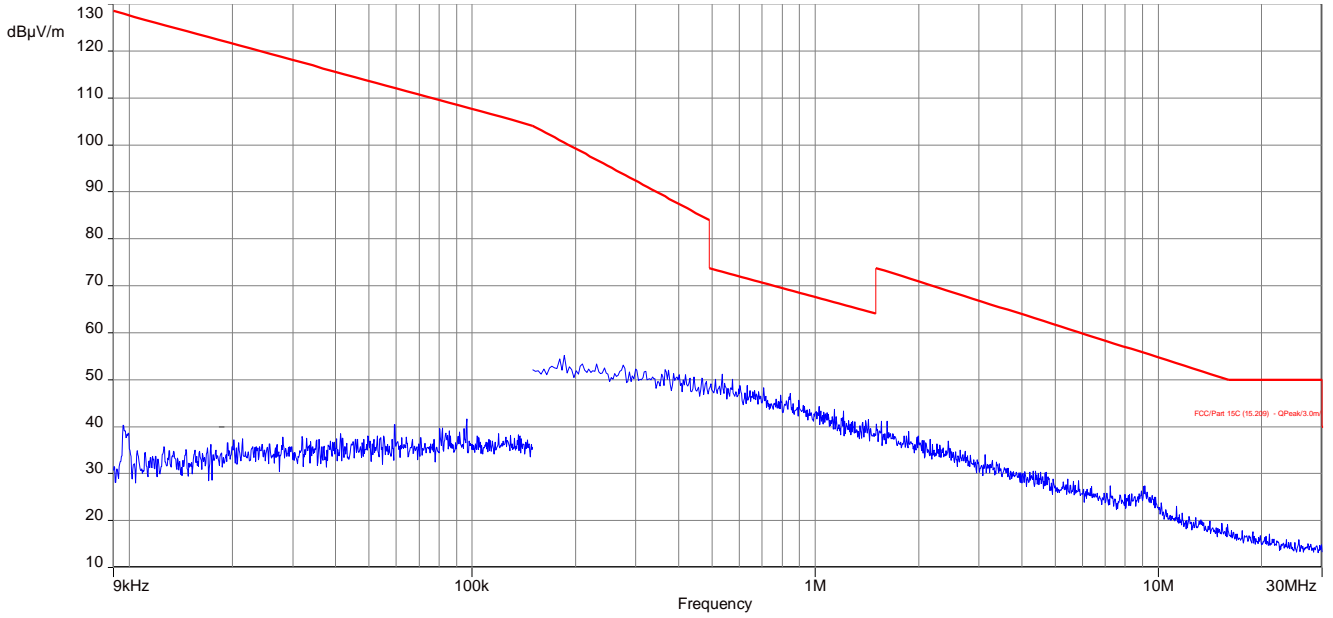

Plot 2: 9 kHz to 30 MHz, 2440 MHz, transmit mode

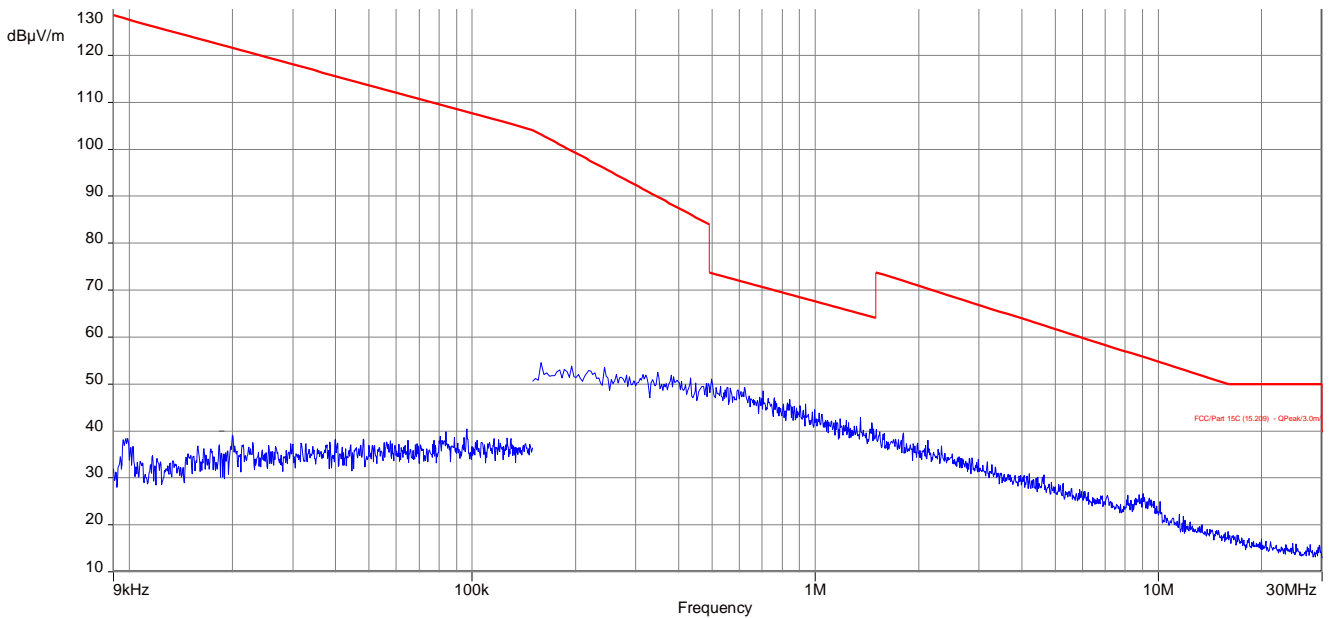

Plot 3: 9 kHz to 30 MHz, 2480 MHz, transmit mode

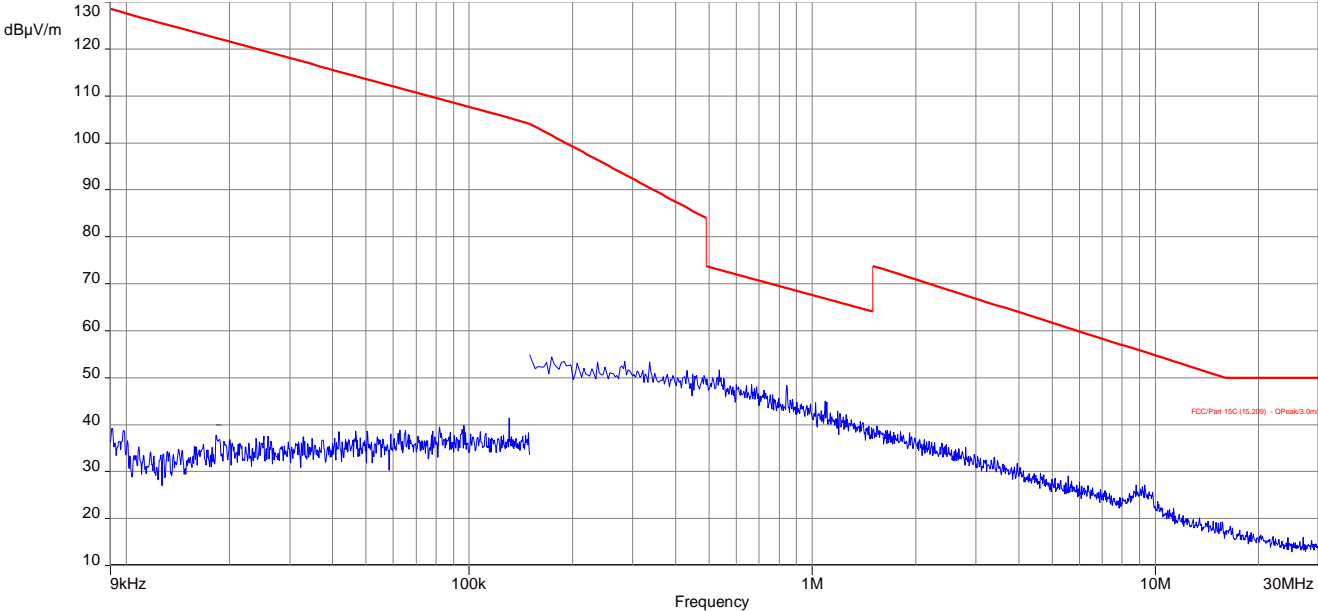

12.10 Spurious emissions radiated 30 MHz to 1 GHz

Description:

Measurement of the radiated spurious emissions in transmit mode. The EUT is set to single channel mode and the transmit frequencies are 2402 MHz, 2440 MHz and 2480 MHz. The measurement is performed in the mode with the highest output power.

Measurement parameters	
Detector	Peak / Quasi Peak
Sweep time	Auto
Resolution bandwidth	3 x VBW
Video bandwidth	120 kHz
Span	30 MHz to 1 GHz
Trace mode	Max hold
Measured modulation	GFSK
Test setup	See sub clause 7.1 A
Measurement uncertainty	See sub clause 9

The modulation with the highest output power was used to perform the transmitter spurious emissions. If spurious were detected a re-measurement was performed on the detected frequency with each modulation.

Limits:

FCC		IC	
TX spurious emissions radiated			
In any 100 kHz bandwidth outside the frequency band in which the spread spectrum or digitally modulated intentional radiator is operating, the radio frequency power that is produced by the intentional radiator shall be at least 20 dB below that in the 100 kHz bandwidth within the band that contains the highest level of the desired power, based on either an RF conducted or a radiated measurement. Attenuation below the general limits specified in Section 15.209(a) is not required. In addition, radiated emissions which fall in the restricted bands, as defined in §15.205(a), must also comply with the radiated emission limits specified in §15.209(a) (see §15.205(c)).			
§15.209			
Frequency (MHz)	Field strength (dBµV/m)	Measurement distance	
30 - 88	30.0	10	
88 – 216	33.5	10	
216 – 960	36.0	10	
Above 960	54.0	3	

Plots: Transmit mode

Plot 1: 30 MHz to 1 GHz, TX mode, 2402 MHz, vertical & horizontal polarization

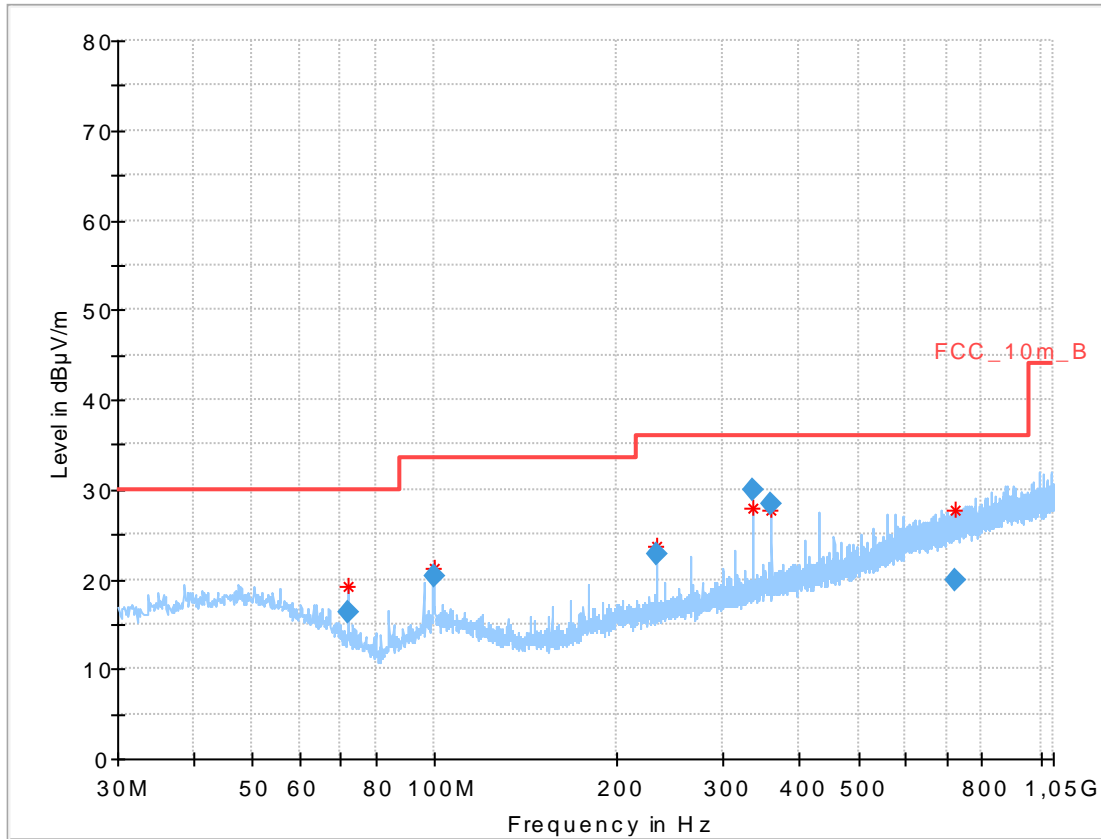

Final results:

Frequency (MHz)	QuasiPeak (dBµV/m)	Limit (dBµV/m)	Margin (dB)	Meas. Time (ms)	Bandwidth (kHz)	Height (cm)	Pol	Azimuth (deg)	Corr. (dB)
71.997900	16.27	30.00	13.73	1000.0	120.000	101.0	V	345.0	9.4
99.619200	20.39	33.50	13.11	1000.0	120.000	101.0	V	352.0	12.0
232.365000	22.78	36.00	13.22	1000.0	120.000	177.0	H	63.0	12.9
336.091800	29.97	36.00	6.03	1000.0	120.000	185.0	H	333.0	15.6
360.099150	28.31	36.00	7.69	1000.0	120.000	185.0	H	333.0	16.2
723.051600	19.82	36.00	16.18	1000.0	120.000	185.0	V	245.0	22.1

Plot 2: 30 MHz to 1 GHz, TX mode, 2440 MHz, vertical & horizontal polarization

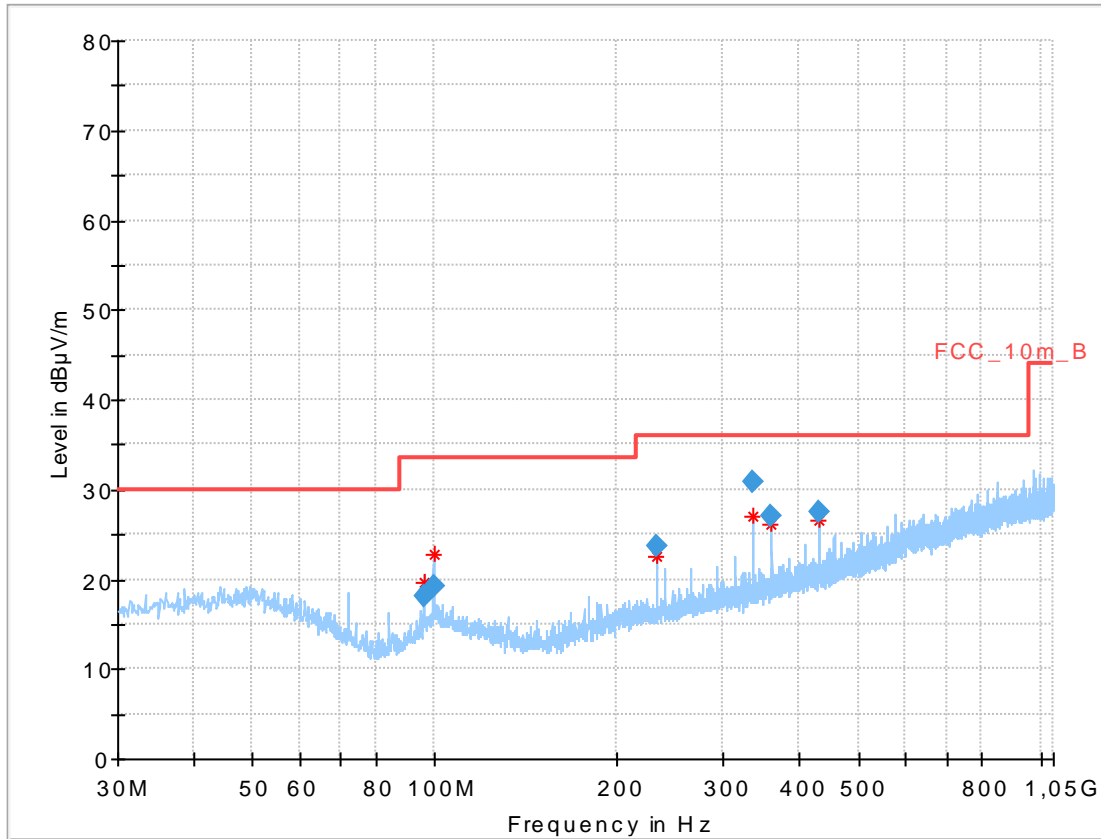

Final results:

Frequency (MHz)	QuasiPeak (dBµV/m)	Limit (dBµV/m)	Margin (dB)	Meas. Time (ms)	Bandwidth (kHz)	Height (cm)	Pol	Azimuth (deg)	Corr. (dB)
96.019050	18.21	33.50	15.29	1000.0	120.000	101.0	V	255.0	11.1
99.734250	19.22	33.50	14.28	1000.0	120.000	101.0	V	345.0	12.0
232.783950	23.79	36.00	12.21	1000.0	120.000	185.0	H	86.0	12.9
336.094650	30.91	36.00	5.09	1000.0	120.000	178.0	H	329.0	15.6
360.101700	26.98	36.00	9.02	1000.0	120.000	181.0	H	329.0	16.2
432.141450	27.56	36.00	8.44	1000.0	120.000	185.0	H	24.0	17.4

Plot 3: 30 MHz to 1 GHz, TX mode, 2480 MHz, vertical & horizontal polarization

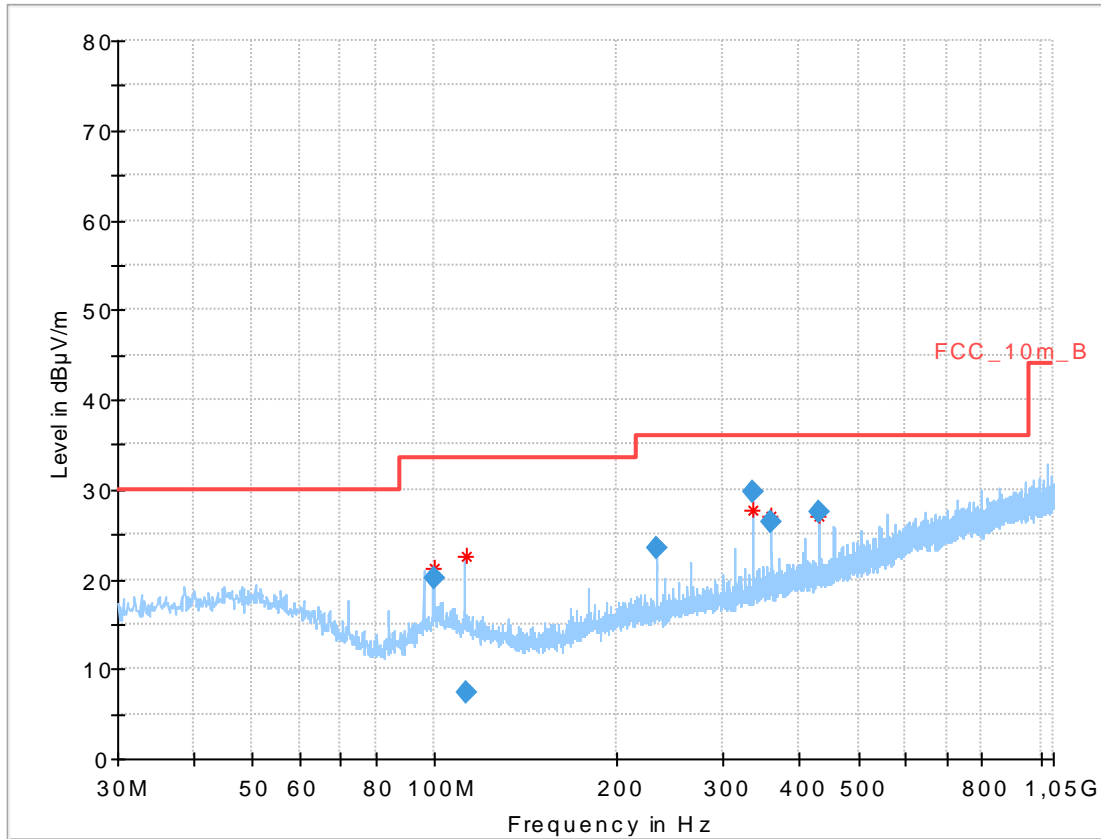

Final results:

Frequency (MHz)	QuasiPeak (dBµV/m)	Limit (dBµV/m)	Margin (dB)	Meas. Time (ms)	Bandwidth (kHz)	Height (cm)	Pol	Azimuth (deg)	Corr. (dB)
99.767100	20.05	33.50	13.45	1000.0	120.000	101.0	V	12.0	12.1
112.542000	7.45	33.50	26.05	1000.0	120.000	101.0	H	37.0	10.9
232.809300	23.50	36.00	12.50	1000.0	120.000	185.0	H	91.0	12.9
336.100200	29.67	36.00	6.33	1000.0	120.000	185.0	H	311.0	15.6
360.119850	26.31	36.00	9.69	1000.0	120.000	185.0	H	334.0	16.2
432.125700	27.48	36.00	8.52	1000.0	120.000	178.0	H	12.0	17.4

Plots: Receiver mode

Plot 1: 30 MHz to 1 GHz, RX / idle – mode, vertical & horizontal polarization

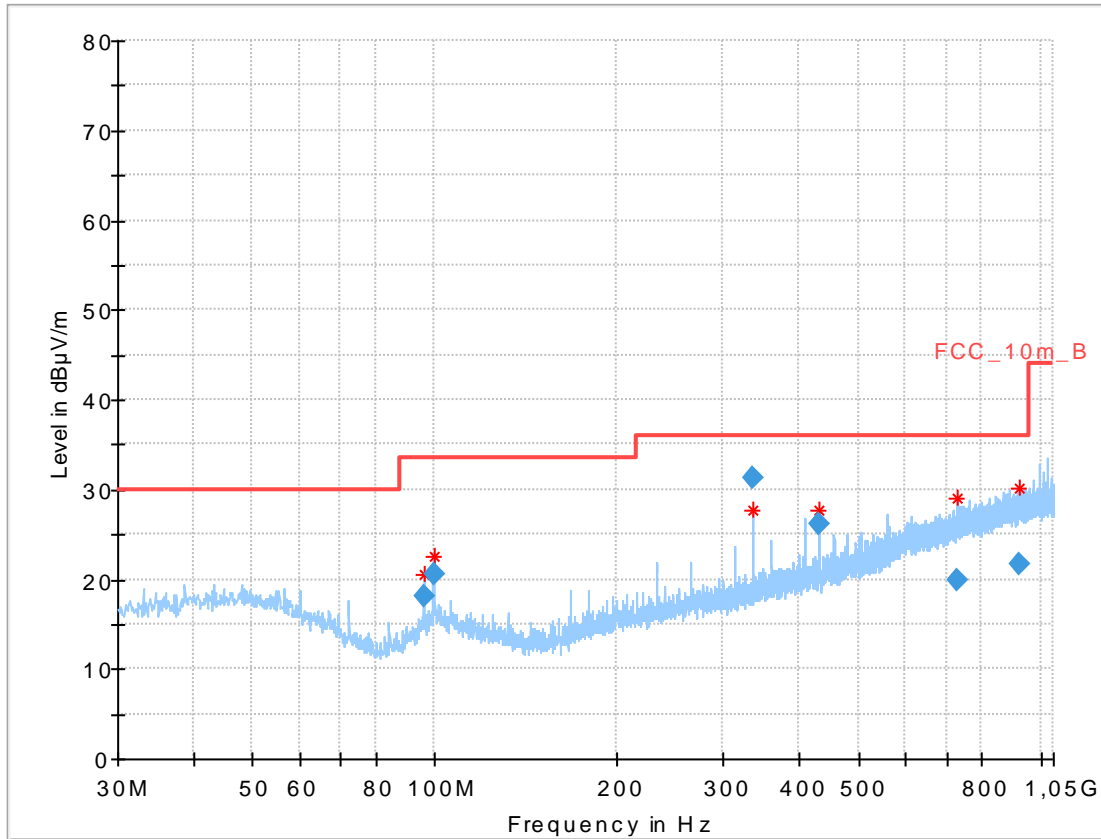

Final results:

Frequency (MHz)	QuasiPeak (dBµV/m)	Limit (dBµV/m)	Margin (dB)	Meas. Time (ms)	Bandwidth (kHz)	Height (cm)	Pol	Azimuth (deg)	Corr. (dB)
96.043650	18.02	33.50	15.48	1000.0	120.000	101.0	V	329.0	11.1
99.758700	20.48	33.50	13.02	1000.0	120.000	101.0	V	4.0	12.1
336.106950	31.23	36.00	4.77	1000.0	120.000	185.0	H	329.0	15.6
432.134400	26.12	36.00	9.88	1000.0	120.000	178.0	H	263.0	17.4
726.491250	19.79	36.00	16.21	1000.0	120.000	185.0	V	244.0	22.2
919.790850	21.69	36.00	14.31	1000.0	120.000	185.0	H	346.0	24.3

12.11 Spurious emissions radiated above 1 GHz

Description:

Measurement of the radiated spurious emissions in transmit mode. The EUT is set to single channel mode and the transmit frequencies are 2402 MHz, 2440 MHz and 2480 MHz. The measurement is performed in the mode with the highest output power.

Measurement parameters	
Detector	Peak / RMS
Sweep time	Auto
Resolution bandwidth	1 MHz
Video bandwidth	3 x RBW
Span	1 GHz to 26 GHz
Trace mode	Max hold
Measured modulation	GFSK
Test setup	See sub clause 7.2 A (1 GHz – 12.75 GHz) See sub clause 7.2 D (12.75 GHz - 18 GHz) See sub clause 7.3 A (18 GHz - 26 GHz)
Measurement uncertainty	See sub clause 9

The modulation with the highest output power was used to perform the transmitter spurious emissions. If spurious were detected a re-measurement was performed on the detected frequency with each modulation.

Limits:

FCC		IC	
TX spurious emissions radiated			
In any 100 kHz bandwidth outside the frequency band in which the spread spectrum or digitally modulated intentional radiator is operating, the radio frequency power that is produced by the intentional radiator shall be at least 20 dB below that in the 100 kHz bandwidth within the band that contains the highest level of the desired power, based on either an RF conducted or a radiated measurement. Attenuation below the general limits specified in Section 15.209(a) is not required. In addition, radiated emissions which fall in the restricted bands, as defined in §15.205(a), must also comply with the radiated emission limits specified in §15.209(a) (see §15.205(c)).			
§15.209			
Frequency (MHz)	Field strength (dBµV/m)	Measurement distance	
Above 960	54.0 (Average)	3	
Above 960	74.0 (Peak)	3	

Results: Transmitter mode

TX spurious emissions radiated [dBµV/m]								
2402 MHz			2440 MHz			2480 MHz		
F [MHz]	Detector	Level [dBµV/m]	F [MHz]	Detector	Level [dBµV/m]	F [MHz]	Detector	Level [dBµV/m]
All detected emissions are more than 20 dB below the limit.			All detected emissions are more than 20 dB below the limit.			All detected emissions are more than 20 dB below the limit.		
	Peak			Peak			Peak	
	AVG			AVG			AVG	
	Peak			Peak			Peak	
	AVG			AVG			AVG	

Results: Receiver mode

RX spurious emissions radiated [dBµV/m]		
F [MHz]	Detector	Level [dBµV/m]
All detected emissions are more than 20 dB below the limit.		
	Peak	
	AVG	

Plots: Transmitter mode

Plot 1: 1 GHz to 12.75 GHz, TX mode, 2402 MHz, vertical & horizontal polarization

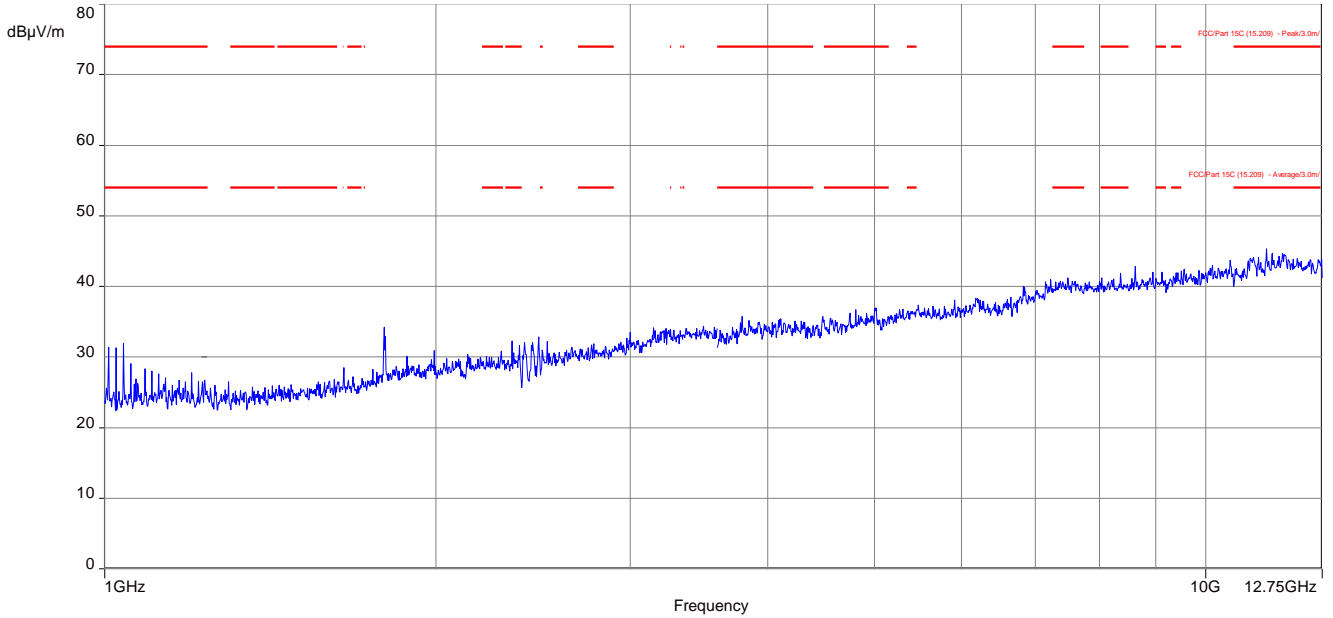

The carrier signal is notched with a 2.4 GHz band rejection filter.

Plot 2: 12.75 GHz to 18 GHz, TX mode, 2402 MHz, vertical & horizontal polarization

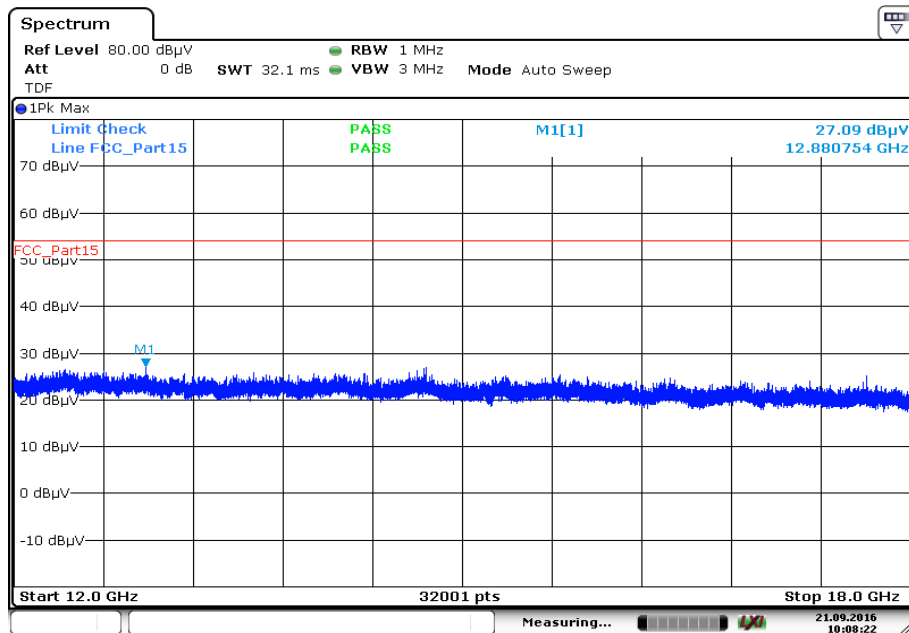

Date: 21.SEP.2016 10:08:22

Plot 3: 18 GHz to 26 GHz, TX mode, 2402 MHz, vertical & horizontal polarization

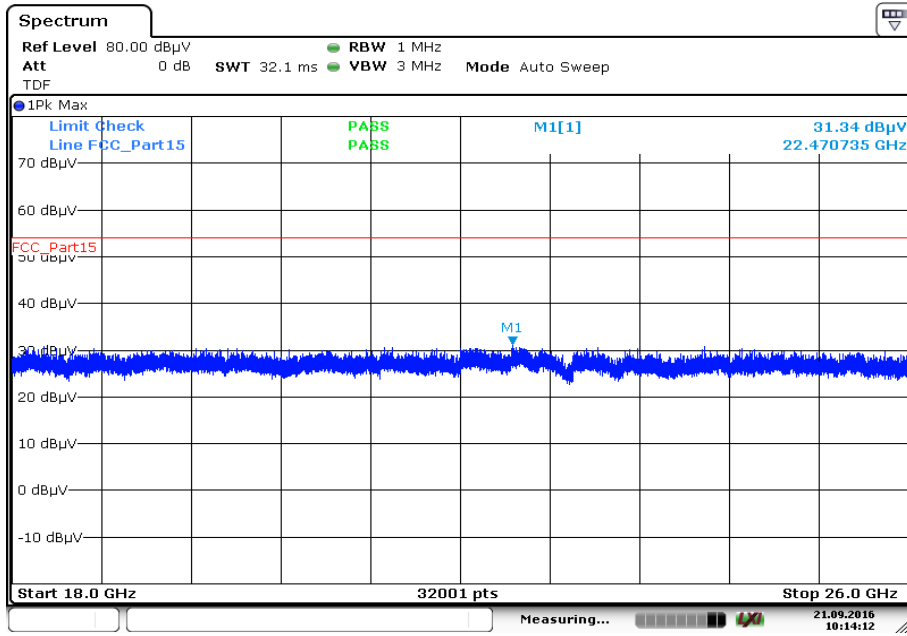

Date: 21.SEP.2016 10:14:12

Plot 4: 1 GHz to 12.75 GHz, TX mode, 2440 MHz, vertical & horizontal polarization

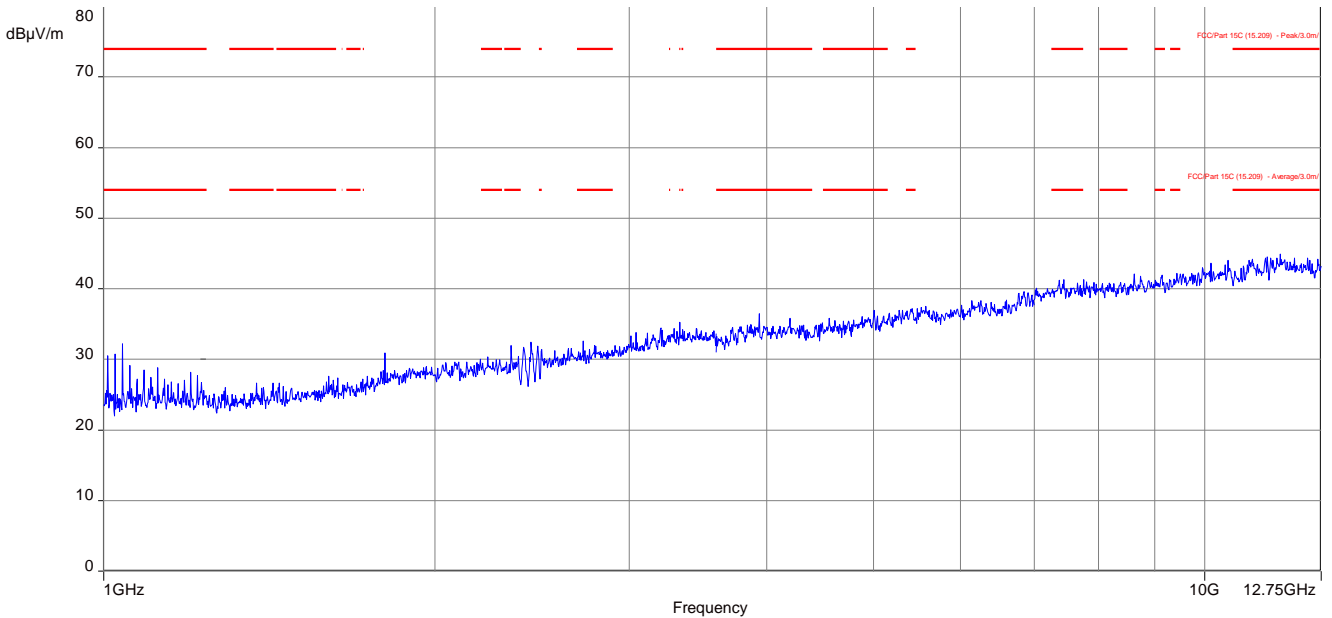

The carrier signal is notched with a 2.4 GHz band rejection filter.

Plot 5: 12.75 GHz to 18 GHz, TX mode, 2440 MHz, vertical & horizontal polarization

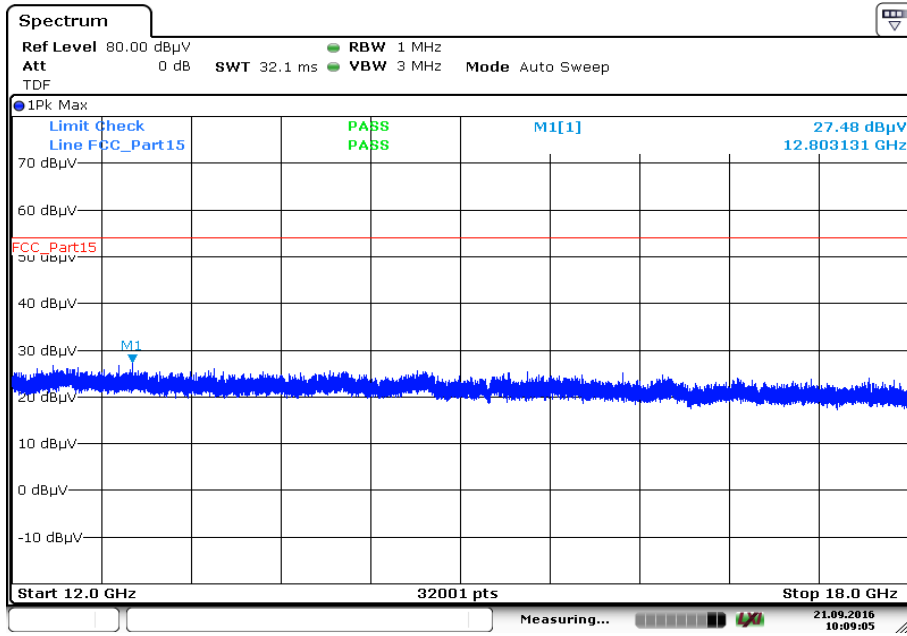

Date: 21.SEP.2016 10:09:05

Plot 6: 18 GHz to 26 GHz, TX mode, 2440 MHz, vertical & horizontal polarization

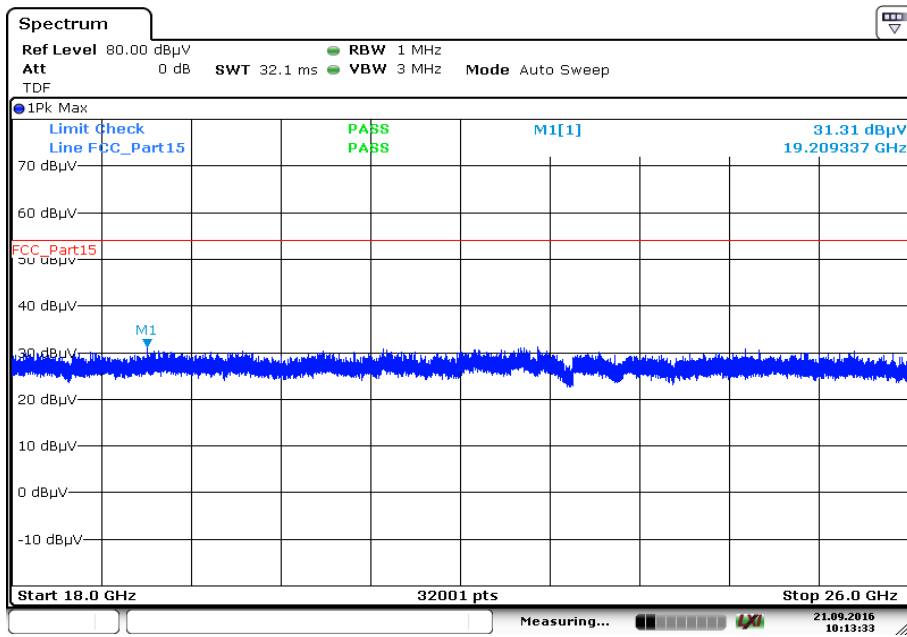

Date: 21.SEP.2016 10:13:33

Plot 7: 1 GHz to 12.75 GHz, TX mode, 2480 MHz, vertical & horizontal polarization

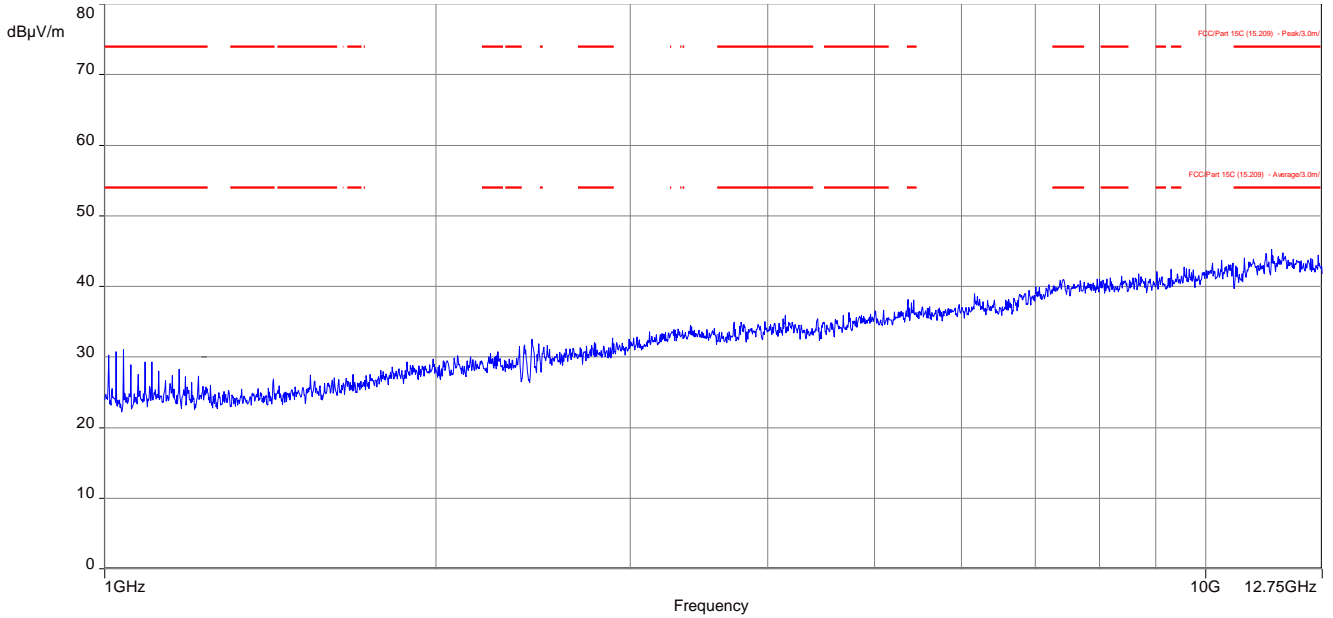

The carrier signal is notched with a 2.4 GHz band rejection filter.

Plot 8: 12.75 GHz to 18 GHz, TX mode, 2480 MHz, vertical & horizontal polarization

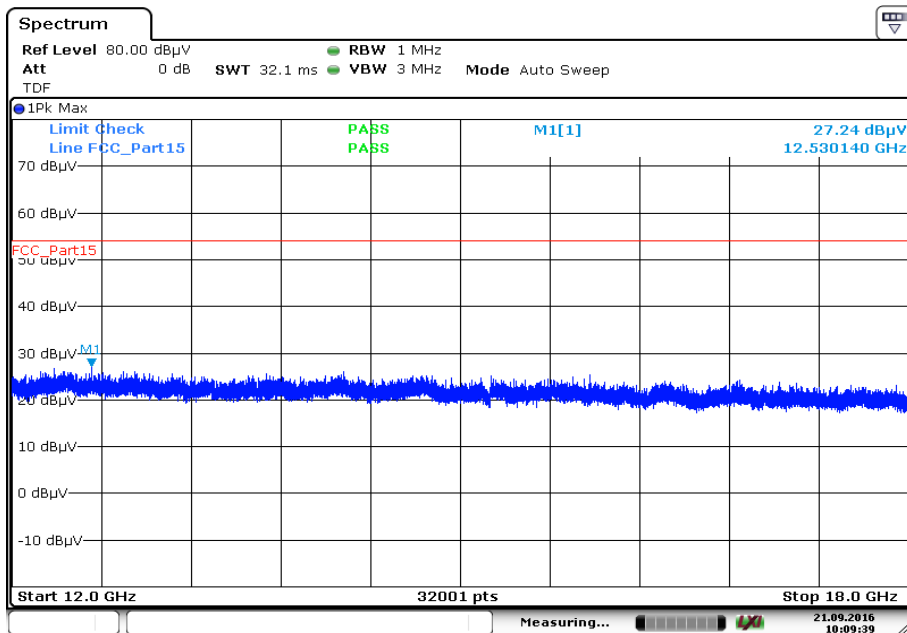

Date: 21.SEP.2016 10:09:39

Plot 9: 18 GHz to 26 GHz, TX mode, 2480 MHz, vertical & horizontal polarization

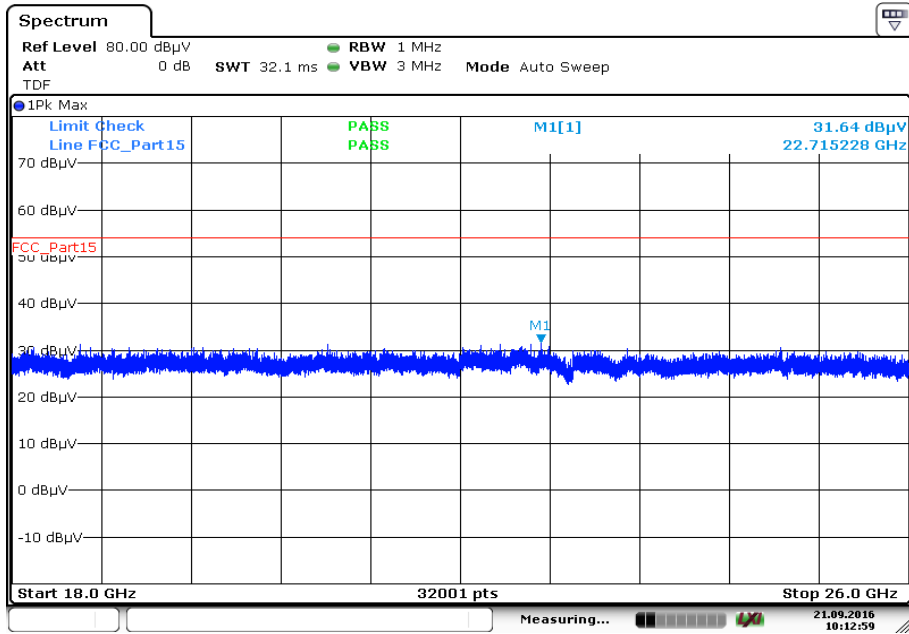

Date: 21.SEP.2016 10:12:59

Plots: Receiver mode

Plot 1: 1 GHz to 12.75 GHz, RX / idle – mode, vertical & horizontal polarization

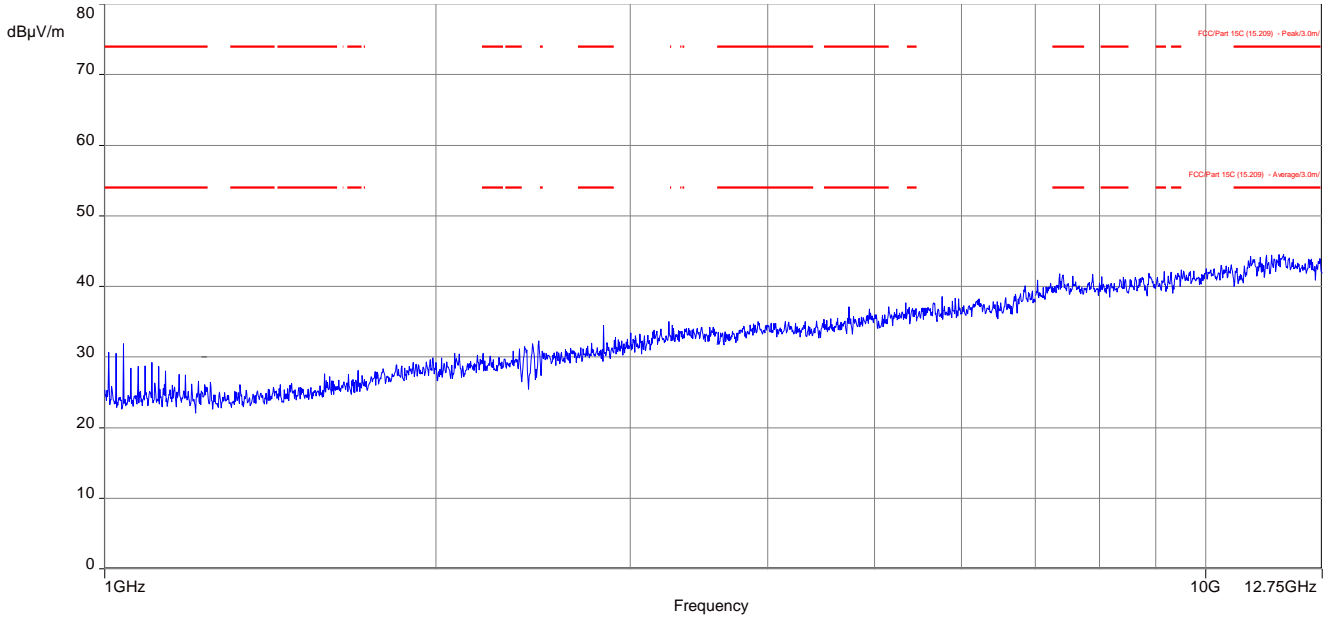

Plot 2: 12.75 GHz to 18 GHz, RX / idle – mode, vertical & horizontal polarization

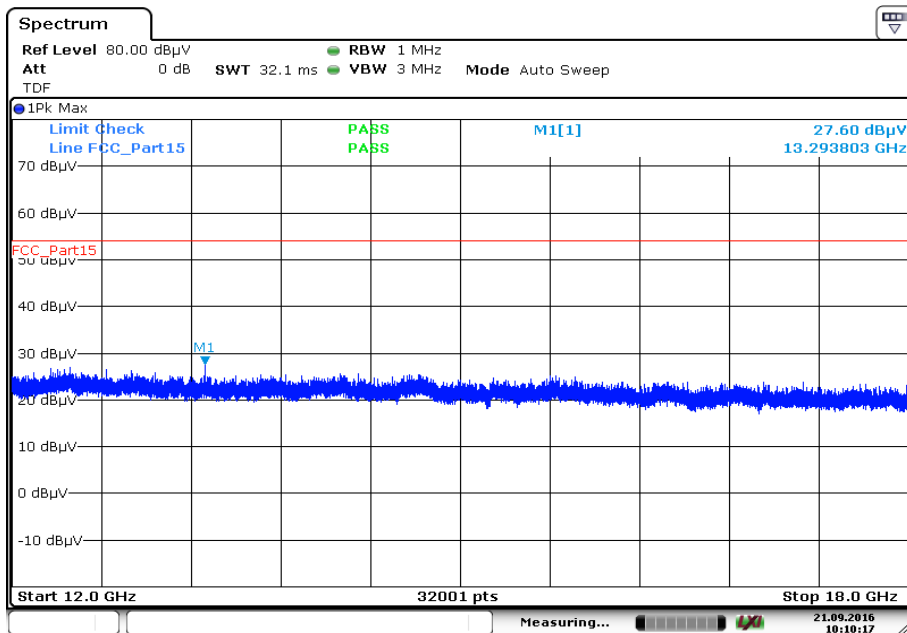

Date: 21.SEP.2016 10:10:17

Plot 3: 18 GHz to 26 GHz, RX / idle – mode, vertical & horizontal polarization

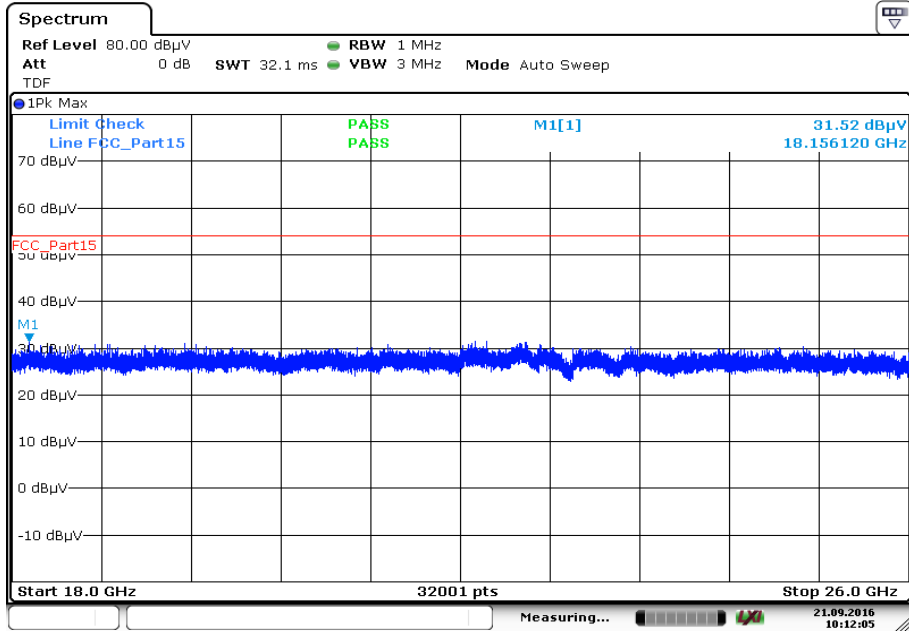

Date: 21.SEP.2016 10:12:05

13 Observations

No observations except those reported with the single test cases have been made.

Annex A Document history

Version	Applied changes	Date of release
	Initial release	2016-11-22
A	FVIN removed, editorial changes	2017-10-18
B	FVIN added	2018-04-17

Annex B Further information

Glossary

AVG	-	Average
DUT	-	Device under test
EMC	-	Electromagnetic Compatibility
EN	-	European Standard
EUT	-	Equipment under test
ETSI	-	European Telecommunications Standard Institute
FCC	-	Federal Communication Commission
FCC ID	-	Company Identifier at FCC
HW	-	Hardware
IC	-	Industry Canada
Inv. No.	-	Inventory number
N/A	-	Not applicable
PP	-	Positive peak
QP	-	Quasi peak
S/N	-	Serial number
SW	-	Software
PMN	-	Product marketing name
HMN	-	Host marketing name
HVIN	-	Hardware version identification number
FVIN	-	Firmware version identification number

Annex C Accreditation Certificate

first page	last page			
 <p>Deutsche Akkreditierungsstelle GmbH</p> <p>Entrusted according to Section 8 subsection 1 AkkStelleG in connection with Section 1 subsection 1 AkkStelleGBV Signatory to the Multilateral Agreements of EA, ILAC and IAF for Mutual Recognition</p>  <p>Accreditation</p> <p>The Deutsche Akkreditierungsstelle GmbH attests that the testing laboratory CTC advanced GmbH Untertürkheimer Straße 6-10, 66117 Saarbrücken</p> <p>is competent under the terms of DIN EN ISO/IEC 17025:2005 to carry out tests in the following fields: Telecommunication</p> <p>The accreditation certificate shall only apply in connection with the notice of accreditation of 02.06.2017 with the accreditation number D-PL-12076-01 and is valid until 21.04.2021. It comprises the cover sheet, the reverse side of the cover sheet and the following annex with a total of 43 pages.</p> <p>Registration number of the certificate: D-PL-12076-01-03</p> <p>Frankfurt, 02.06.2017</p>  <p>Dipl.-Ing. (FH) Ralf Peter Heß Head of Division</p> <p><small>See notes overleaf.</small></p>	<p>Deutsche Akkreditierungsstelle GmbH</p> <table border="0"> <tr> <td>Office Berlin Spittelmarkt 10 10117 Berlin</td> <td>Office Frankfurt am Main Europa-Allee 52 60327 Frankfurt am Main</td> <td>Office Braunschweig Bundesallee 100 38116 Braunschweig</td> </tr> </table> <p>The publication of extracts of the accreditation certificate is subject to the prior written approval by Deutsche Akkreditierungsstelle GmbH (DAkkS). Exempted is the unchanged form of separate disseminations of the cover sheet by the conformity assessment body mentioned overleaf.</p> <p>No impression shall be made that the accreditation also extends to fields beyond the scope of accreditation attested by DAkkS.</p> <p>The accreditation was granted pursuant to the Act on the Accreditation Body (AkkStelleG) of 31 July 2009 (Federal Law Gazette I p. 2625) and the Regulation (EC) No 765/2008 of the European Parliament and of the Council of 9 July 2008 setting out the requirements for accreditation and market surveillance relating to the marketing of products (Official Journal of the European Union L 218 of 9 July 2008, p. 30). DAkkS is a signatory to the Multilateral Agreements for Mutual Recognition of the European co-operation for Accreditation (EA), International Accreditation Forum (IAF) and International Laboratory Accreditation Cooperation (ILAC). The signatories to these agreements recognise each other's accreditations.</p> <p>The up-to-date state of membership can be retrieved from the following websites: EA: www.european-accreditation.org ILAC: www.ilac.org IAF: www.iaf.nu</p>	Office Berlin Spittelmarkt 10 10117 Berlin	Office Frankfurt am Main Europa-Allee 52 60327 Frankfurt am Main	Office Braunschweig Bundesallee 100 38116 Braunschweig
Office Berlin Spittelmarkt 10 10117 Berlin	Office Frankfurt am Main Europa-Allee 52 60327 Frankfurt am Main	Office Braunschweig Bundesallee 100 38116 Braunschweig		

Note: The current certificate annex is published on the website (link see below) of the Accreditation Body DAkkS or may be received by CTC advanced GmbH on request

<http://www.dakks.de/as/ast/d/D-PL-12076-01-03.pdf>