



**AGES
14+**

USER MANUAL

CX-10DS(WIFI)



**PLEASE CAREFULLY READ THE
USER MANUAL BEFORE FLYING**

CONTENTS

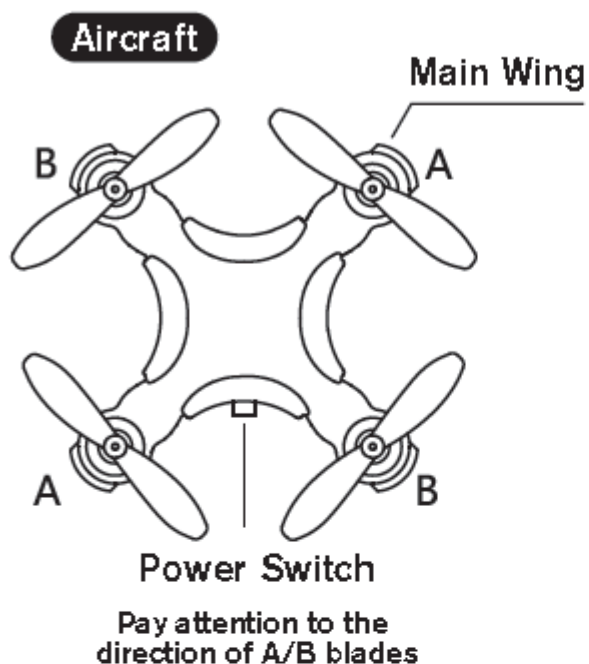

USB Charging Line



Blade



Manual



CHARGING AIRCRAFT BATTERY

① Connect the charging cable to the aircraft, and then plug the USB side to the computer or any other USB charger. While charging the USB indicator will be ON. The USB indicator is OFF when fully charged. The USB charging cable can be connected to Apple chargers and other smart phone chargers. It also can be charged using portable batteries and car phone charges. Only standard +5+0.5V USB chargers are supported.

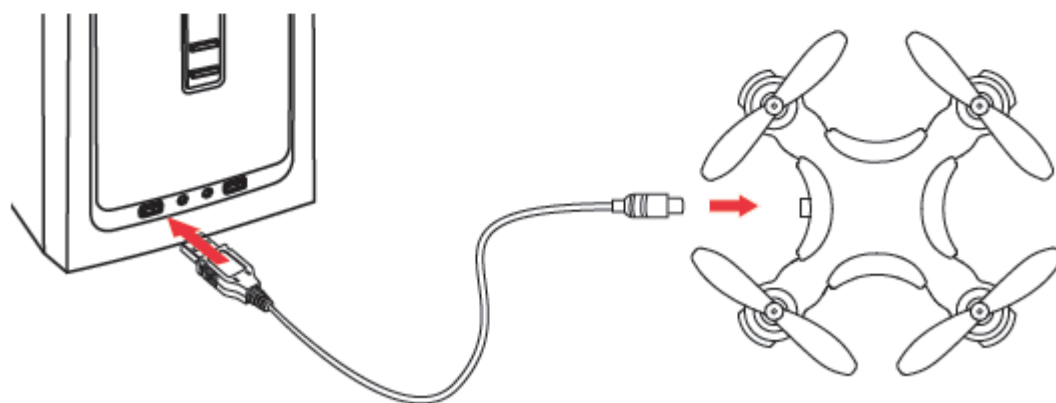

1

② Battery charging time is 40 minutes. The time of flight is approximately 5min, depending on a factor such as wind strength. When the aircraft begins to lose power, please recharge the battery.

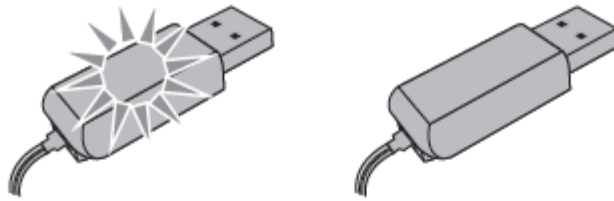

Safety Guide For Lithium Battery

1. Do not leave the charger/battery unattended while in use.
2. Only use the included USB charging wire while charging the battery.
3. It is highly forbidden to decompose and disassemble the battery.
4. Do not keep or use the battery in high-temperature areas or near heat sources or flammable products.
5. It is highly forbidden to cover the battery or the charger. Insure that the battery is charged in well ventilated and fire-resistant location.
6. If the battery begins to smell or “puff” during charge, please unplug the battery from the charger and move the battery to a safe outdoor place to avoid combustion or explosion (please, dispose the battery in appropriate way).
7. Storing or transporting batteries together with metal objects is strictly heated.
8. It is forbidden to throw batteries into the fire or cause them to be heated.
9. It is forbidden to contact metal objects to the plus and minus ends of the battery.
10. It is highly forbidden to reverse/change plus and minus polarities of the battery.
11. If by any accident battery's electrolyte (battery's fluid) gets into your eyes, do not rub your eyes instead rinse your eyes with clear water.
12. Store the battery in a cool and dry environment.

DOWNLOAD SOFTWARE

1. IOS Phone Software Download Instructions

(1) Download and Install the Software

Please download and install the software CX-10DS from APP Store, or scan the QR code (Figure 1).

2.WIFI Connection Instruction

- (1) Turn the aircraft on and the indicators will begin to flash rapidly.
- (2) Turn on WIFI and connect CX-10DS. When the “√” appears indicating successful connection then exit the setting.
- (3) Open the software CX-10DS on your iPhone or iPad, then click the icon to enter the control interface. (When flying keep away from other WIFI signals as far as possible.)

ANDROID PHONE SOFTWARE DOWNLOAD INSTRUCTIONS

1.Download and Install the Software

Overseas User: Please download and install the software CX-10DS through the Google Play Store, or scan the QR code Down, to download and install (Figure 2).

China User: Please download the software CX-10DS through alternative way, or scan the QR code down, to download and install (Figure 3).

2.WIFI Connection Instruction

- (1) Turn the aircraft on and the indicators will begin to flash rapidly.
- (2) Turn on WIFI and connect CX-10DS. When the “√” appears indicating successful connection then exit the setting.
- (3) Open the software CX-10DS on your phone, then click the icon to enter the control interface.
- (4) Please refer to iPhone instruction for details.



Figure 1



Figure 2



Figure 3

Warning

1. Turn off WIFI and reconnect it if there is no WIFI signal found in search menu.
2. Please completely exit the software when you need to change the battery. Choose the corresponding network for connection. Turn on the software again after successful connection.
3. WIFI range may reach 25 meters and please do not exceed the flying range to keep normal flying.
4. Please keep away from people and animals and do not fly in places with inflammable, fragile and dangerous obstacles, it may cause unintended damages.
5. While flying do not put the throttle stick down immediately, otherwise the aircraft may fall down, causing damages to some of its parts.

Intruction For Software Controls



Startup
Interface

Click the icon to enter setting

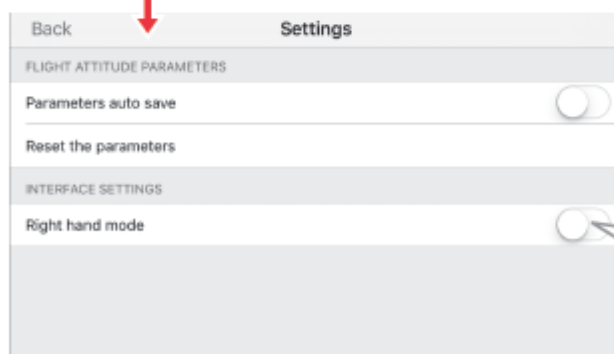

Left handed throttle
mode is by defaulted.
Turn on right handed
throttle.

Click the play icon at the right bottom corner on the interface to enter the controlling interface.

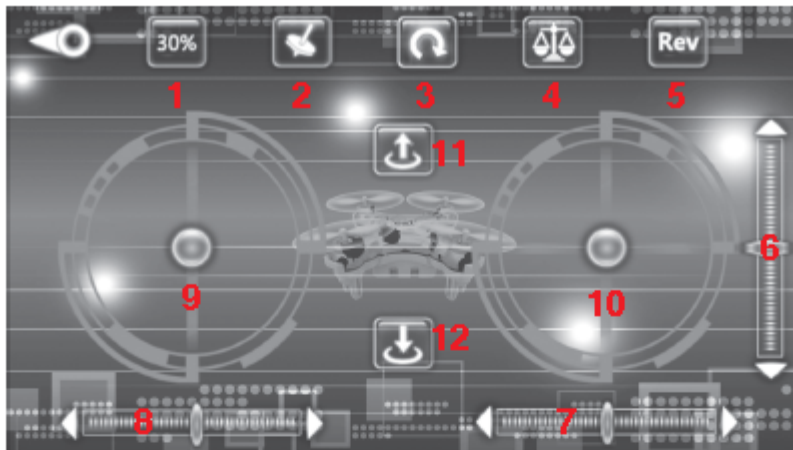

1: Speed: 30%/60%/100%
 2: Gravity sensing mode
 3: One touch flips & rolls
 4: One touch balance
 5: Rotate the monitor

6: Elevator trim
 7: Aileron trim
 8: Yaw trim
 9: Throttle/
 Left rotation/
 Right rotation

10: Left/right
 (aileron)
 Forward/backward
 (elevator)
 11: One touch take-off
 12: One touch landing

One touch take-off

Place aircraft on a flat level surface and click the one touch take off icon. After taking off it can hover and keep height at approx. 1.5m above the ground.



One touch landing

After clicking one touch landing icon, the aircraft will gradually lose height and automatically land.

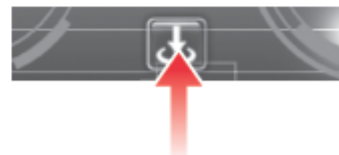

One touch flips & rolls

While hovering click the one touch flips & rolls icon, the aircraft will flip or roll.



One touch balance calibration

If you encounter any unstable flying, place the aircraft on the flat level surface and click the one touch balance calibration icon. The LED indicators on the aircraft will flash constantly, indicating the successful calibration.



Fly Modes Settings

You can fly in 3 different modes and it is defaulted at beginners mode.

Beginners mode 30%
Intermediate mode 60%
Advanced mode 100%

To change modes click the sensitivity icon. The higher the sensitivity, the quicker the aircraft will respond.

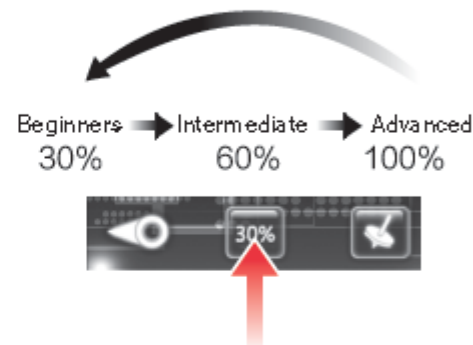

OPERATIONS

1. Manual Flying Control

(1) Ascend/descend control: when the throttle stick is moved up, the rotors will rotate fast and the aircraft will ascend; when the throttle stick is lowered, rotors will rotate slowly and the aircraft will descend.

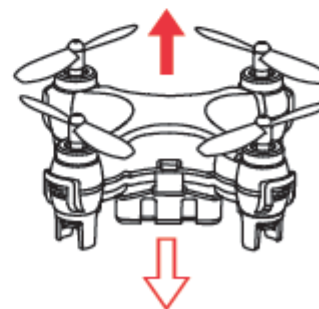
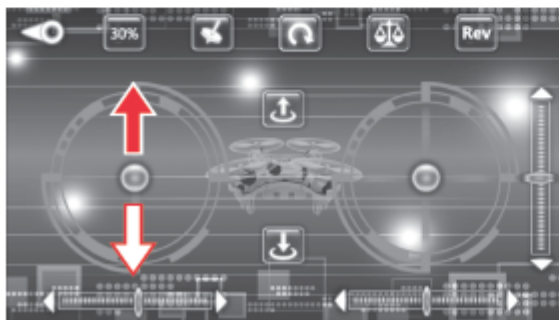

(2) Forward/backward control: when the elevator/directional stick is moved up, the aircraft will fly forward; when it is moved down the aircraft will fly backward.

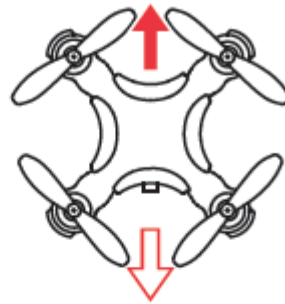
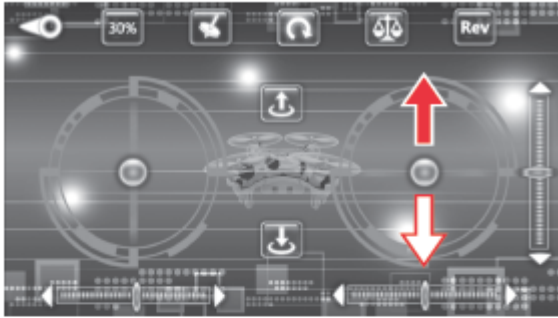

(3) Left/right side control: when the aileron/directional stick is moved left, the aircraft will fly to the left side; when the aileron/directional stick is moved right, the aircraft will fly to the right side.

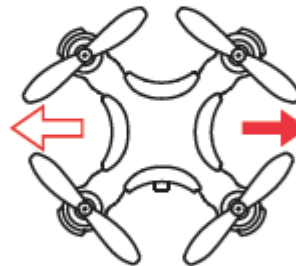
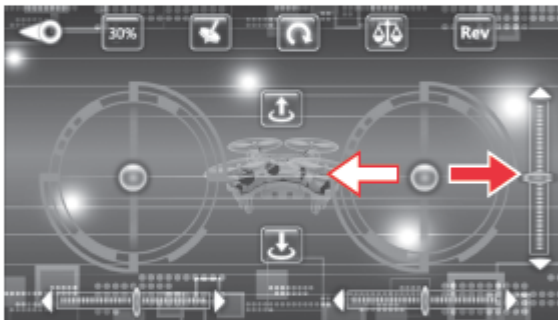

(4) Rotational/yaw control: when the throttle stick is moved left the aircraft will rotate to the left; when it is moved to the right, the aircraft will rotate to the right.

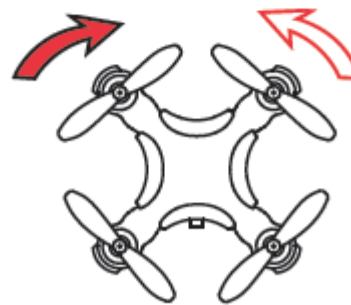
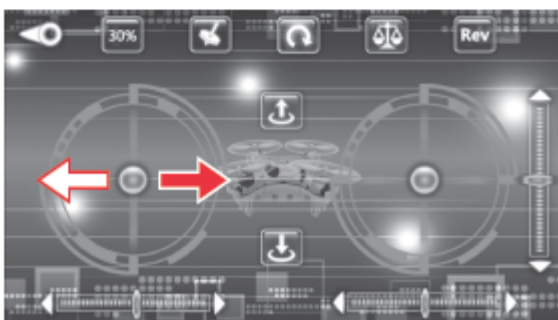

Trim Settings

- (1) Forward/backward trim: if the aircraft drifts forwards or backwards, while trying to hover adjust the trim setting until it gets stable hovering.
- (2) Left/right side fly trim: if the aircraft drifts to the left or to the right, while trying to hover adjust the trim setting until it gets stable hovering.
- (3) Rotational trim: if the aircraft rotates to the left or to the right, while trying to hover adjust the trim setting until it gets stable hovering.

2.Gravity Sensor Control

The gravity sensor control is defaulted to OFF status. It will turn yellow after clicking the icon, indicating ON status.



When the gravity sensor is on, you still need to move the throttle stick to control the height and rotational direction. You can use the phone to control the aircraft left/right, forward/backward.

- (1) Left/right side control: when the phone slopes to the left the aircraft will fly to the left; when the phone slopes to the right the aircraft will fly to the right.

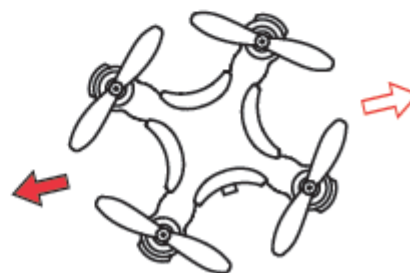

(2) Forwards/backwards control: when the phone slopes forward, the aircraft will fly forwards; when it slopes backward, the aircraft will fly to backwards.

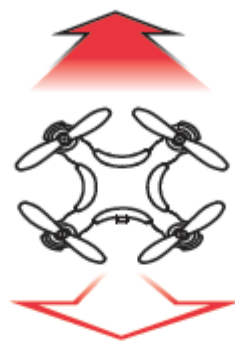

Troubleshooting

If the aircraft can't take off	<ol style="list-style-type: none">1.Ensure the battery is charged.2.If WIFI connection between aircraft and phone is not successful please reconnect both devices.
If the aircraft drifts	<ol style="list-style-type: none">1.Check propellers on the aircraft, if needed replace damaged propellers.2.Check if A&B propellers are in the right place, if needed reinstall the propellers.3.Place it on flat level surface and click the one touch balance calibration.

FCC Warning:

Changes or modifications not expressly approved by the party responsible for compliance could void the user's authority to operate the equipment.

This device complies with Part 15 of the FCC Rules. Operation is subject to the following two conditions: (1) this device may not cause harmful interference, and (2) this device must accept any interference received, including interference that may cause undesired operation.

This equipment has been tested and found to comply with the limits for a Class B digital device, pursuant to Part 15 of the FCC Rules. These limits are designed to provide reasonable protection against harmful interference in a residential installation. This equipment generates, uses and can radiate radio frequency energy and, if not installed and used in accordance with the instructions, may cause harmful interference to radio communications. However, there is no guarantee that interference will not occur in a particular installation.

If this equipment does cause harmful interference to radio or television reception, which can be determined by turning the equipment off and on, the user is encouraged to try to correct the interference by one or more of the following measures:

- Reorient or relocate the receiving antenna.
- Increase the separation between the equipment and receiver.
- Connect the equipment into an outlet on a circuit different from that to which the receiver is connected.
- Consult the dealer or an experienced radio/TV technician for help.

This equipment complies with FCC radiation exposure limits set forth for an uncontrolled environment. This equipment should be installed and operated with a minimum distance of 20cm between the radiator & your body. This transmitter must not be co-located or operating in conjunction with any other antenna or transmitter.

CE Warning:

Hereby, Guangdong Cheerson Hobby Technology CO., LTD, declares that this UFO is in compliance with the essential requirements and other relevant provisions of Directive 2014/53/EU.

The full test of the EU declaration of conformity is available at the following internet address:
<http://www.cheersonhobby.com/>

Product is selling the whole Europe.

Other information:

Model: CX-10DS

FCC ID: 2AD6LGC032410042

Working frequency range : 2412-2462MHz

Maximum transmitted power: 19.34dBm

Manufacturer's Name: Guangdong Cheerson Hobby Technology CO., LTD

Manufacturer's Address: Fengxin No. 2 Road & Laimei Road, Fengxin Industrial Zone, Chenghai, Shantou, Guangdong province, China

Contact person: JIA HUA CHEN

Tel: +86-0754-85872540