

# **RONGTA** User Manual

---

## **RP421A LABEL PRINTER**

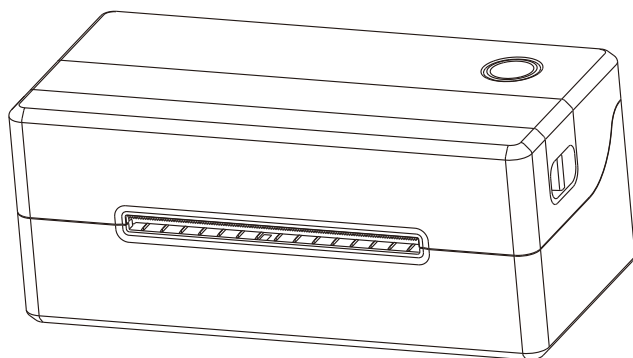

# Contents

---

---

|   |    |
|---|----|
| I. Product Introduction .....                           | 2  |
| 1.1 Main Features.....                                  | 2  |
| II. Safety Instructions.....                            | 3  |
| 2.1 Safety warning.....                                 | 3  |
| 2.2 Instructions .....                                  | 3  |
| 2.3 Other Precautions.....                              | 4  |
| III. Appearance and Components.....                     | 5  |
| IV. Technical Parameters.....                           | 6  |
| 4.1 Printing Parameters.....                            | 6  |
| V. Installation and Operation of Printer .....          | 7  |
| 5.1 Printer Unpacking .....                             | 7  |
| 5.2 Connecting the Printer .....                        | 8  |
| 5.3 Folded Paper Loading .....                          | 9  |
| 5.4 Handling of Paper Jam .....                         | 9  |
| 5.5 Bluetooth Pairing and Printing.....                 | 10 |
| 5.6 Use Bluetooth Interface for Printing.....           | 10 |
| VI. The Switch, Key and Indicator Light of Printer..... | 11 |
| 6.1 Precautions for Power Switch/Use .....              | 11 |
| 6.2 Keys and Indicators.....                            | 11 |
| VII. Printer Test.....                                  | 12 |
| 7.1 Print Self-Test Page.....                           | 12 |
| 7.2 Print with the Windows Driver.....                  | 12 |
| 7.3 Label Learning.....                                 | 13 |
| VIII. USB Interface .....                               | 14 |
| IX. Cleaning the Printer .....                          | 15 |
| 9.1 Cleaning the Printer Head.....                      | 15 |
| 9.2 Cleaning the Sensor .....                           | 15 |
| 9.3 Cleaning the Printing Rubber Roller .....           | 16 |
| X. Troubleshooting.....                                 | 17 |

# I. Product Introduction

---

---

Thank you for purchasing the label printer produced by our company.

This label printer provides you with safe, reliable and efficient printing quality at a reasonable economic price. At the same time, Printer is widely used in supermarkets, Catering industry, clothing industry, warehousing industry, etc. due to its super functions and easy operation.

## 1.1 Main Features

- High printing quality
- Low noise
- The attractive appearance
- Reasonable structure, simple use and maintenance
- Intelligent detection and positioning
- Auto feed and retreat paper
- Simple operation
- Label off intelligent handling function
- Fast printing, saving time
- Superior heat dissipation, can handle heavy printing workload



## II. Safety Instructions

---

---

**Before operating and using the printer, please carefully read the following items and strictly observe the use rules.**

### 2.1 Safety warning

-  The print head will become very hot during printing, please do not touch the printhead and peripheral parts during printing and printing just finished.
-  Please do not touch the printhead and connectors, in case that static damages the printer head.

### 2.2 Instructions

 **Warnings: Violating following instructions may cause serious injury or death.**

- 1) Do not plug several products in one porous power outlet.
  - This may cause over-heat and a fire
  - If the plug is wet or dirty, dry or wipe it before using.
  - If the plug does not fit perfectly to outlet, do not plug in.
  - Be sure to use only standardized porous power outlet
- 2) You must use the supplied adapter.
  - It is dangerous to use other adapters.
- 3) Do not pull the cable by pulling.
  - This may damage the cable or cause a fire.
- 4) Do not plug in or unplug with your wet hands.
  - You may be electrocuted.
- 5) Do not bend the cable by force or leave it under any heavy object.
  - A damaged cable may cause a fire.

 **Note: Violating following instructions may cause slight damage of the appliance.**

- 1) If you observe a strange smoke, odour or noise from the printer, unplug it before taking following measures.
  - Switch off the printer and unplug the set from the mains.
  - After the disappearance of the smoke, call your dealer to repair it.
- 2) Install the printer on the stable surface.
  - If the printer falls down, it may be broken and you may hurt yourself.
- 3) Use the approved accessories only and do not try to disassemble, repair or remodel it by yourself.
  - Call your dealer when you need these services.
  - Do not touch the blade of auto cutter.

- 4) Do not let water or other foreign objects drop into the printer.
  - If this happened, switch off and unplug the printer before calling your dealer.
- 5) Do not use the printer when it is out of order. This can cause a fire or an electrocution.
  - Switch off and unplug the printer before calling your dealer.
- 6) Other considerations:
  - Place the printer on a solid and even base so that it cannot fall.
  - Leave enough space around printer for operation and maintenance.
  - Keep all liquids away from the printer.
  - Do not expose the printer to high temperatures, direct sunlight or dust.
  - Ensure the printer is connected to a socket with the correct mains voltage.
  - Switch off the printer POWER supply when it's not in use for a long time.
  - To ensure the printing quality and reliability, suggest use the same quality or recommend paper supplier.
  - Pls. switch off the POWER supply when connect/disconnect all the ports or it will cause damage to the printer control circuit.
  - Never carry out maintenance or repair work yourself. Always contact a qualified service Technician.
  - Keep this User Manual in a place which is easily accessible at all times.

## 2.3 Other Precautions

The copyright for this user manual and various other manuals is property of our company. Any copying or conversion into electronic form and saving of this material without the express written permission is strictly prohibited. Use of the information contained in this manual is not subject to any patent liability. This manual has been prepared with utmost care and attention to detail but may contain certain errors and/or omissions. Our company is not legally liable for any damages resulting from the use of the information in this manual. Our company and its affiliates are not legally liable (United States excluded) for any damages, loss, costs, and/or expenses that result from the breakdown, malfunction, and/or misuse of the product due to violation or neglect of the operation and maintenance information and instructions provided by our company, as well as from the unauthorized alteration, repair, and/or modification of the product by the user and/or third party. We are not legally liable for any damages and/or issues resulting from the use of options and/or parts that are not authentic or authorized products.

# III. Appearance and Components

---

## Front View

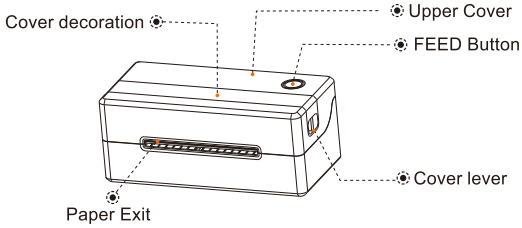

## Rear View

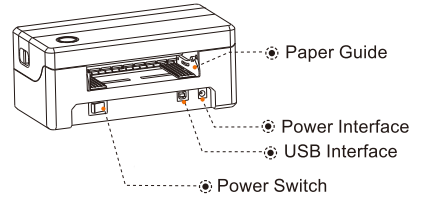

## Inside View

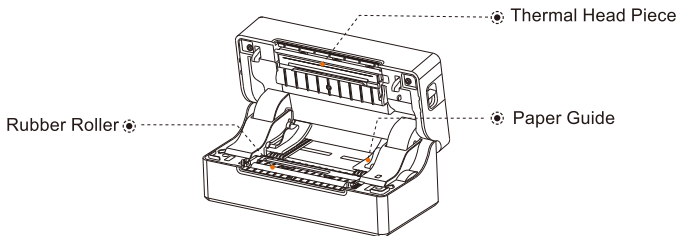

## Application Field

- Cashier system of supermarkets
- Cashier system of Catering industry,
- Cashier system of clothing industry
- Cashier system of warehousing industry

# IV. Technical Parameters

## 4.1 Printing Parameters

|                                   |   |
|-----------------------------------|---|
| Model                             | RP421A  |
| Printing method                   | Thermal line printer  |
| Paper loading method              | Easy paper loading/auto paper feeding   |
| Printing speed                    | 127mm/s, (150mm/s optional)   |
| Printing paper width              | 104mm   |
| Effective resolution              | 203dpi (300dpi optional)  |
| Paper type                        | Continuous paper, label paper, black label paper, and folded paper  |
| Thickness of printing paper       | 0.06-0.18mm   |
| Effective printing width          | Min 38mm Max 112mm  |
| Character size                    | ASCII Font A: 12x24 ASCII Font B: 9x17 Chinese character 24x24  |
| Interface type                    | USB   |
| <b>Print character</b>            |   |
| Type of bar code                  | One-dimensional code: Code 39, 39C, I25, Code 93, ITF25, EAN128, Code 128, Codabar, EAN-8, EAN8+2, EAN8+5, EAN-13, EAN13+2, EAN13+5, UPC-A, UPCA+2, UPCA+5, UPC-E, UPCE+2, UPCE+5 MSIC, ITF14, EAN14, CODE11, POST<br>QR code: PDF417(optional) |
| Extended character table          | CP437, CP850, CP852, CP860, CP863, CP865, CP866<br>WPC1250, WPC1251, WPC1252, WPC1253, WPC1254  |
| <b>Power supply</b>               |   |
| Power adapter                     | DC 24V  2.5A   |
| <b>Environmental requirements</b> |   |
| Working environment               | Operating temperature: 0~45°C, Operating humidity: 20~90%   |
| Storage environment               | Storage temperature:-10 ~ 60°C, Storage humidity: 10~90%  |
| <b>Environmental conditions</b>   |   |
| Drive                             | WINXP/WIN7/WIN8/WIN10/Mac/Linux   |
| Print command                     | TSPL/CPCL(optional)/ZPL(optional)   |
| Character printing                | It supports double width and double height printing of AN K characters, custom characters and Chinese characters; adjusts dot patterns of character spacing for printing;   |

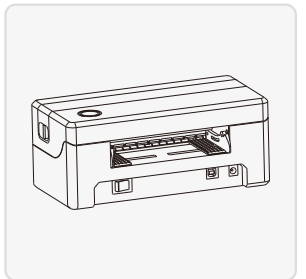
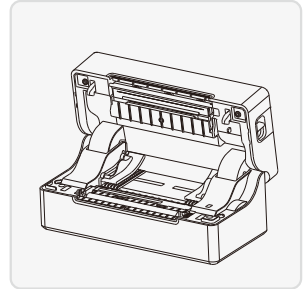
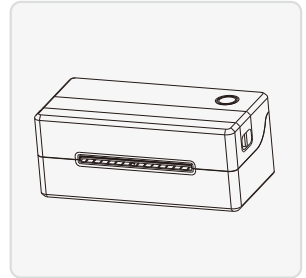

 The pictures are for reference only, please subject to practicality

 Remark: The interface is optional or customized, and the specific interface is subject to the actual object.

## V. Installation and Operation of Printer

### 5.1 Printer Unpacking

#### Check the parts:

Before use, make sure the accessories are included in the package(the following picture is an example). If any thing is missing, contact the supplier or manufacturer. The specific accessories may not be included depending on the printer model.

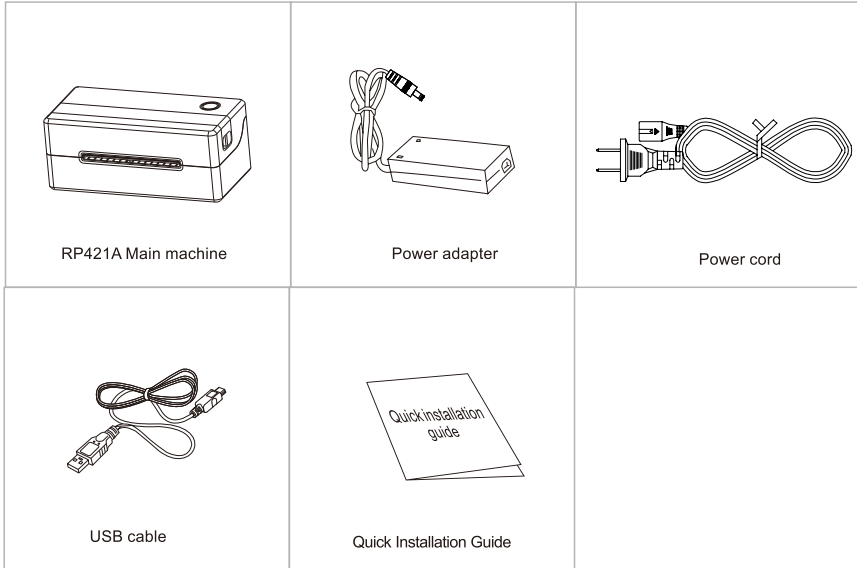

☺ The pictures are for reference only, please subject to practicality.



## 5.2 Connecting the Printer

### ❑ Connect the power line

- (1) Confirm that the power switch is in off (0) state.
- (2) Connect the power adapter to the printer.
- (3) Connect the power line to the power adapter.
- (4) Connect the other end of the power line to a nearby socket.

**Use the special power adapter for the printer.  
The connection diagram is as follows:**

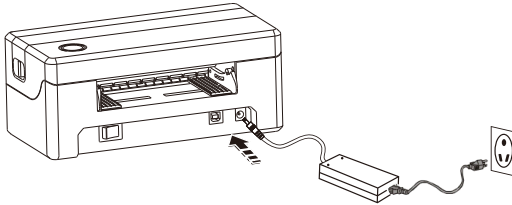

### ❑ Connect the USB cable

- (1) Connect the USB cable to the printer.
- (2) Connect the USB cable to the PC host.
- (3) Turn the power switch to on (I) state.

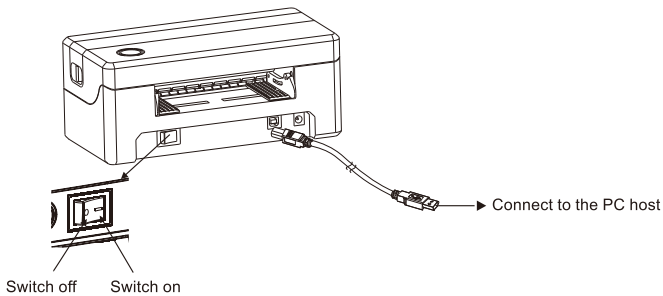

### 5.3 Folded Paper Loading

- (1) Facing the back of the machine, hold the paper guide with both hands, and adjust the distance between the left and right guides according to the folded paper size.
- (2) Insert the folded paper into the paper guide
- (3) Confirm that the printer has detected paper feeding, automatically feeds paper and delivers paper normally

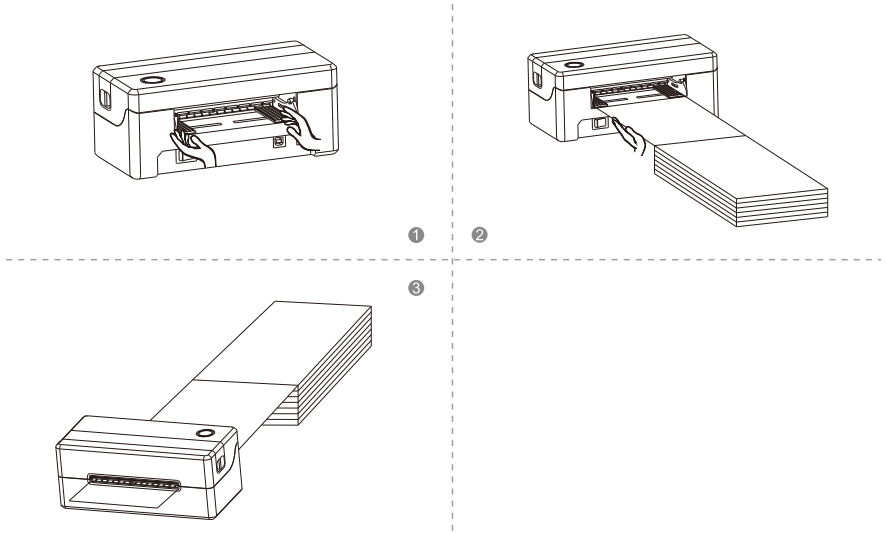

### 5.4 Handling of Paper Jam

- (1) Move the top cover lever forward with both hands and lift the top cover.
- (2) Remove the jammed paper from the feeding channel, and check whether the print head has adhesive or carbon deposition. If yes, clean it with an alcohol cloth, remove the wrinkled paper and replace it with new paper.

