



FCC PART 15.247 TEST REPORT

For

XIAMEN RONGTA TECHNOLOGY CO.,LTD.

3F-1/E Building, No.195 Gaoqishe, Gaodian Village, Dianqian Street Office,
Huli District, Xiamen City, China

FCC ID: 2AD6G-IMACHINE-A1

Report Type: Original Report	Product Name: ALL IN ONE
Report Number:	RXM180419050-00C
Report Date:	2018-05-22
Reviewed By:	Jerry Zhang EMC Manager <i>Jerry Zhang</i>
Test Laboratory:	Bay Area Compliance Laboratories Corp. (Dongguan) No.69 Pulongcun, Puxinhu Industry Area, Tangxia, Dongguan, Guangdong, China Tel: +86-769-86858888 Fax: +86-769-86858891 www.baclcorp.com.cn

Note: This test report is prepared for the customer shown above and for the device described herein. It may not be duplicated or used in part without prior written consent from Bay Area Compliance Laboratories Corp. (Dongguan). This report must not be used by the customer to claim product certification, approval, or endorsement by A2LA* or any agency of the Federal Government. * This report may contain data that are not covered by the A2LA accreditation and are marked with an asterisk “*”

TABLE OF CONTENTS

GENERAL INFORMATION.....	4
PRODUCT DESCRIPTION FOR EQUIPMENT UNDER TEST (EUT).....	4
OBJECTIVE	4
RELATED SUBMITTAL(S)/GRANT(S).....	4
TEST METHODOLOGY	4
MEASUREMENT UNCERTAINTY	5
TEST FACILITY	5
SYSTEM TEST CONFIGURATION.....	6
DESCRIPTION OF TEST CONFIGURATION	6
EUT EXERCISE SOFTWARE	6
EQUIPMENT MODIFICATIONS	9
LOCAL SUPPORT EQUIPMENT LIST AND DETAILS	9
SUPPORT CABLE LIST AND DETAILS	10
CONFIGURATION OF TEST SETUP	10
SUMMARY OF TEST RESULTS	11
FCC §15.247 (i) , §1.1310 , §2.1091- MAXIMUM PERMISSIBLE EXPOSURE (MPE).....	12
APPLICABLE STANDARD	12
FCC §15.203 - ANTENNA REQUIREMENT.....	13
APPLICABLE STANDARD	13
ANTENNA CONNECTOR CONSTRUCTION	13
FCC §15.207 (a)– AC LINE CONDUCTED EMISSIONS	14
APPLICABLE STANDARD	14
EUT SETUP	14
EMI TEST RECEIVER SETUP.....	14
TEST PROCEDURE	15
CORRECTED AMPLITUDE & MARGIN CALCULATION	15
TEST EQUIPMENT LIST AND DETAILS.....	15
TEST DATA	16
FCC §15.209, §15.205 & §15.247(d) - SPURIOUS EMISSIONS.....	18
APPLICABLE STANDARD	18
EUT SETUP.....	18
EMI TEST RECEIVER & SPECTRUM ANALYZER SETUP	19
TEST PROCEDURE	19
CORRECTED AMPLITUDE & MARGIN CALCULATION	19
TEST EQUIPMENT LIST AND DETAILS.....	20
TEST DATA	20
FCC §15.247(a) (2)–6 dB EMISSION BANDWIDTH.....	29
APPLICABLE STANDARD	29
TEST PROCEDURE	29
TEST EQUIPMENT LIST AND DETAILS.....	29
TEST DATA	29
FCC §15.247(b) (3) - MAXIMUM PEAK CONDUCTED OUTPUT POWER.....	37
APPLICABLE STANDARD	37
TEST PROCEDURE	37
TEST EQUIPMENT LIST AND DETAILS.....	37

TEST DATA38

FCC §15.247(d)- 100 kHz BANDWIDTH OF FREQUENCY BAND EDGE.....39

 APPLICABLE STANDARD39

 TEST PROCEDURE39

 TEST EQUIPMENT LIST AND DETAILS.....39

 TEST DATA40

FCC §15.247(e) - POWER SPECTRAL DENSITY45

 APPLICABLE STANDARD45

 TEST PROCEDURE45

 TEST EQUIPMENT LIST AND DETAILS.....45

 TEST DATA45

GENERAL INFORMATION

Product Description for Equipment under Test (EUT)

EUT Name:	ALL IN ONE
EUT Model:	iMachine A1
Multiple Model:	iMachine B1, iMachine C1, iMachine D1, iMachine E1, iMachine F1, iMachine G1, iMachine H1, iMachine I1, iMachine J1
FCC ID:	2AD6G-IMACHINE-A1
Rated Input Voltage:	DC 24V from adapter
Adapter Information	Model: DJ-240250-SA
	Input: AC 100-240V~ 50/60Hz 1.5A MAX
	Output: DC 24V , 2.5A MAX
External Dimension:	Length (353.2 mm)*Width (207.1 mm)*High (402.7 mm)
Serial Number:	180419050
EUT Received Date:	2018.04.19

Note: The series product, models iMachine A1, iMachine B1, iMachine C1, iMachine D1, iMachine E1, iMachine F1, iMachine G1, iMachine H1, iMachine I1, iMachine J1 are electrically identical, we selected iMachine A1 for full test , and please refer to the declaration letter for details.

Objective

This report is prepared on behalf of **XIAMEN RONGTA TECHNOLOGY CO.,LTD.** in accordance with Part 2, Subpart J, Part 15, Subparts A and C of the Federal Communications Commission's rules.

The tests were performed in order to determine the compliance of the EUT with FCC Rules Part 15-Subpart C, section 15.203, 15.205, 15.207, 15.209 and 15.247 rules.

Related Submittal(s)/Grant(s)

FCC Part 15C DSS submissions with FCC ID: 2AD6G-IMACHINE-A1.

FCC Part 15B JBC submissions with FCC ID: 2AD6G-IMACHINE-A1.

Test Methodology

All measurements contained in this report were conducted with ANSI C63.10-2013, American National Standard of Procedures for Compliance Testing of Unlicensed Wireless Devices and KDB 558074 D01 DTS Meas Guidance v04.

All emissions measurement was performed and Bay Area Compliance Laboratories Corp. (Dongguan).

Measurement Uncertainty

Parameter	Measurement Uncertainty
Occupied Channel Bandwidth	±5 %
RF output power, conducted	±0.61dB
Power Spectral Density, conducted	±0.61 dB
Unwanted Emissions, radiated	30M~200MHz: 4.55 dB,200M~1GHz: 5.92 dB,1G~6GHz: 4.98 dB, 6G~18GHz: 5.89 dB,18G~26.5G:5.47 dB,26.5G~40G:5.63 dB
Unwanted Emissions, conducted	±1.5 dB
Temperature	±1°C
Humidity	±5%
DC and low frequency voltages	±0.4%
Duty Cycle	1%
AC Power Lines Conducted Emission	3.12 dB (150 kHz to 30 MHz)

Test Facility

The Test site used by Bay Area Compliance Laboratories Corp. (Dongguan) to collect test data is located on the No.69 Pulongcun, Puxinhu Industry Area, Tangxia, Dongguan, Guangdong, China.

The test site has been approved by the FCC under the KDB 974614 D01 and is listed in the FCC Public Access Link (PAL) database, FCC Registration No. : 897218,the FCC Designation No. : CN1220.

The test site has been registered with ISED Canada under ISED Canada Registration Number 3062D.

SYSTEM TEST CONFIGURATION

Description of Test Configuration

The system was configured for testing in Engineering Mode, which was provided by the manufacturer.

For 2.4GHz band, total 11 channels are provided:

Channel	Frequency (MHz)	Channel	Frequency (MHz)
1	2412	7	2442
2	2417	8	2447
3	2422	9	2452
4	2427	10	2457
5	2432	11	2462
6	2437	/	/

For 802.11b, 802.11g, and 802.11n ht20 modes were test with channel 1,6,11.

For 802.11n ht40 mode was test with channel 3,6,9.

The worst-case data rates are determined to be as follows for each mode based upon investigations by measuring the average power and PSD across all data rates bandwidths, and modulations.

EUT Exercise Software

The software “MPTool” was used for testing, which was provided by manufacturer. The maximum power was configured as below table, that provided by the manufacturer:

Test Mode	Test Software Version	MPTool		
		2412MHz	2437MHz	2462MHz
802.11b	Test Frequency	2412MHz	2437MHz	2462MHz
	Data Rate	1Mbps	1Mbps	1Mbps
	Power Level Setting	57	57	58
802.11g	Test Frequency	2412MHz	2437MHz	2462MHz
	Data Rate	6Mbps	6Mbps	6Mbps
	Power Level Setting	59	58	58
802.11n ht20	Test Frequency	2412MHz	2437MHz	2462MHz
	Data Rate	MCS0	MCS0	MCS0
	Power Level Setting	58	58	58
802.11n ht40	Test Frequency	2422MHz	2437MHz	2452MHz
	Data Rate	MCS0	MCS0	MCS0
	Power Level Setting	59	59	59

The maximum duty cycle as following table:

Test mode	T _{on} (ms)	T _{on+off} (ms)	Duty Cycle (%)
802.11b	100	100	100
802.11g	100	100	100
802.11n ht20	100	100	100
802.11n ht40	100	100	100

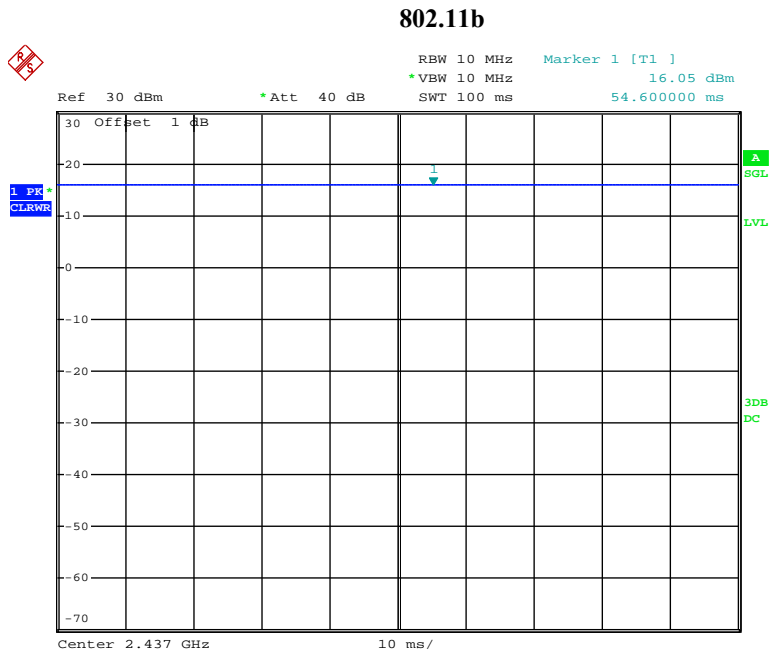

Date: 5.MAY.2018 12:00:25

802.11g

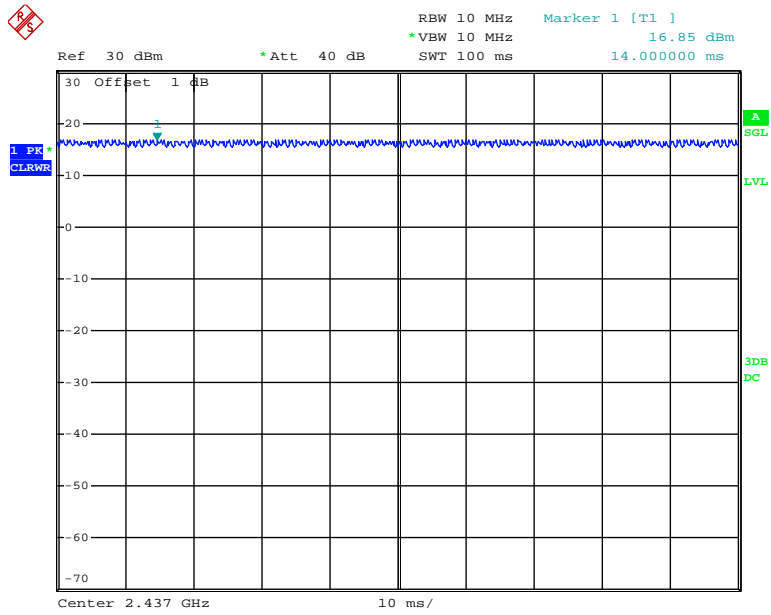

Date: 5.MAY.2018 12:01:17

802.11n ht20

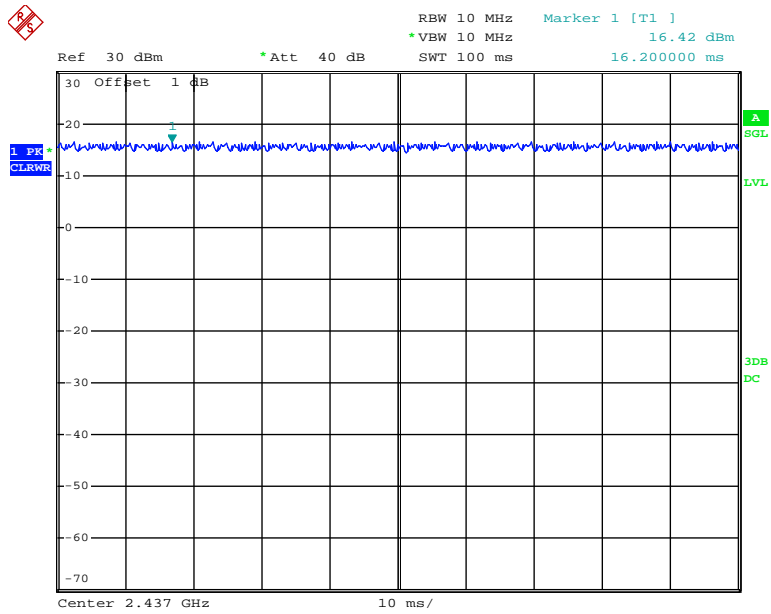

Date: 5.MAY.2018 12:01:42

802.11n ht40

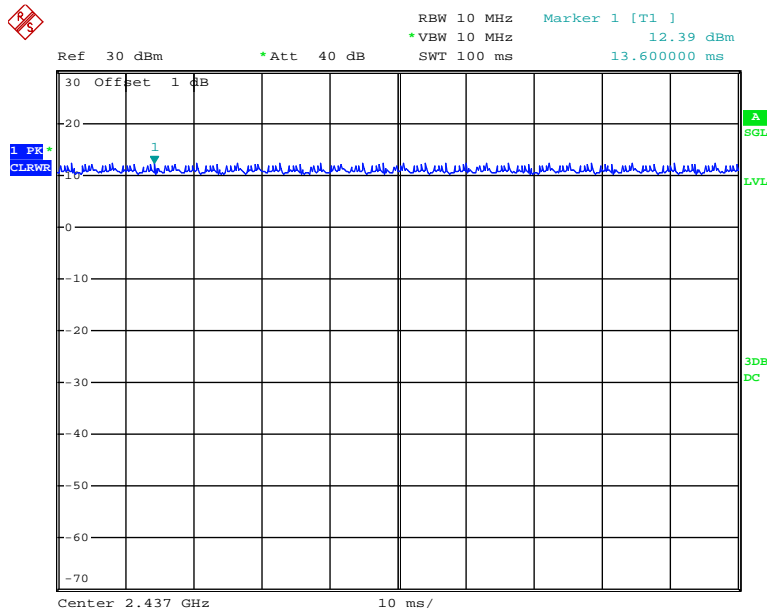

Date: 5.MAY.2018 12:02:07

Equipment Modifications

No modification was made to the EUT.

Local Support Equipment List and Details

Manufacturer	Description	Model	Serial Number
HUAWEI	Earphone	/	/
TOSHIBA	USB HDD	v63700-A	62J5P3USTN69
Sandisk	U-DISK	4GB	001
Sandisk	U-DISK	4GB	002
Sandisk	U-DISK	4GB	003
Sandisk	U-DISK	4GB	004
Tenda	Router	D301	E3941017710003629
MAKEN	Cash Drawer	MT-350T	/
YD	PIN Pad	YD511DA-RJ	/
Sandisk	TF Card	4GB	008

Support Cable List and Details

Cable Description	Shielding Type	Ferrite Core	Length (m)	From Port	To
USB Cable	No	No	0.45	USB HDD	EUT
RJ45 Cable	No	No	5.00	Router	EUT
RJ11 Cable	No	No	5.00	Cash Drawer	EUT
RS232 Cable	No	No	5.00	PIN Pad	EUT
Earphone	No	No	1.2	EUT	Earphone
DC Cable	No	No	1.2	Adapter	EUT

Configuration of Test Setup

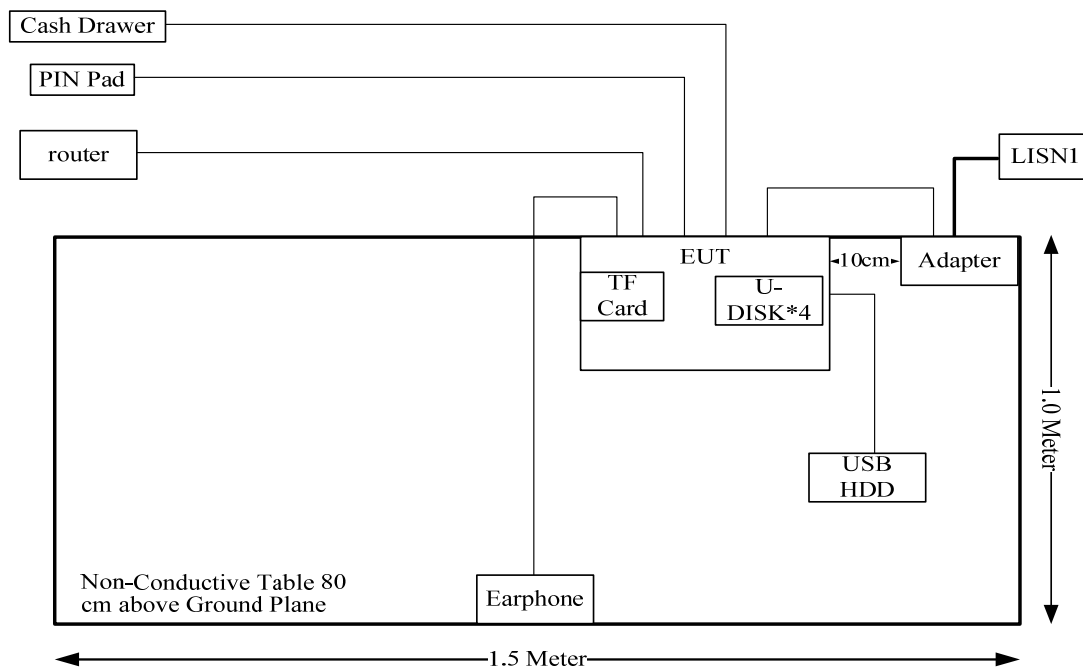

SUMMARY OF TEST RESULTS

FCC Rules	Description of Test	Result
FCC §15.247 (i) & §1.1310 & §2.1091	Maximum Permissible Exposure (MPE)	Compliance
§15.203	Antenna Requirement	Compliance
§15.207 (a)	AC Line Conducted Emissions	Compliance
§15.205, §15.209, §15.247(d)	Spurious Emissions	Compliance
§15.247 (a)(2)	6 dB Bandwidth	Compliance
§15.247(b)(3)	Maximum Conducted Output Power	Compliance
§15.247(d)	100 kHz Bandwidth of Frequency Band Edge	Compliance
§15.247(e)	Power Spectral Density	Compliance

FCC §15.247 (i) , §1.1310 , §2.1091- MAXIMUM PERMISSIBLE EXPOSURE (MPE)

Applicable Standard

According to subpart 15.247(i) and subpart §1.1310, systems operating under the provisions of this section shall be operated in a manner that ensures that the public is not exposed to radio frequency energy level in excess of the Commission’s guidelines.

Limits for Maximum Permissible Exposure (MPE) (§1.1310, §2.1091)

(B) Limits for General Population/Uncontrolled Exposure				
Frequency Range (MHz)	Electric Field Strength (V/m)	Magnetic Field Strength (A/m)	Power Density (mW/cm ²)	Averaging Time (minutes)
0.3–1.34	614	1.63	*(100)	30
1.34–30	824/f	2.19/f	*(180/f ²)	30
30–300	27.5	0.073	0.2	30
300–1500	/	/	f/1500	30
1500–100,000	/	/	1.0	30

f = frequency in MHz; * = Plane-wave equivalent power density;

According to §1.1310 and §2.1091 RF exposure is calculated.

Calculation Formula:

Prediction of power density at the distance of the applicable MPE limit:

$S = PG/4\pi R^2$ = power density (in appropriate units, e.g. mW/cm²);

P = power input to the antenna (in appropriate units, e.g., mW);

G = power gain of the antenna in the direction of interest relative to an isotropic radiator, the power gain factor, is normally numeric gain;

R = distance to the center of radiation of the antenna (appropriate units, e.g., cm);

Calculated Data:

Frequency Range (MHz)	Antenna Gain		Maximum Power Including Tolerance		Evaluation Distance (cm)	Power Density (mW/cm ²)	MPE Limit (mW/cm ²)
	(dBi)	(numeric)	(dBm)	(mW)			
2412-2462	3	2.00	21	125.89	20.00	0.05	1.0

Note:

The Maximum Power Including Tolerance was declared by manufacturer.

The 2.4GHz WIFI can't transmit simultaneously with Bluetooth.

Result: Compliance, The device meets FCC MPE at 20 cm distance

FCC §15.203 - ANTENNA REQUIREMENT

Applicable Standard

According to § 15.203, an intentional radiator shall be designed to ensure that no antenna other than that furnished by the responsible party shall be used with the device. The use of a permanently attached antenna or of an antenna that uses a unique coupling to the intentional radiator shall be considered sufficient to comply with the provisions of this section. The manufacturer may design the unit so that a broken antenna can be replaced by the user, but the user of a standard antenna jack or electrical connector is prohibited. The structure and application of the EUT were analyzed to determine compliance with section §15.203 of the rules. §15.203 state that the subject device must meet the following criteria:

- a. Antenna must be permanently attached to the unit.
- b. Antenna must use a unique type of connector to attach to the EUT.
- c. Unit must be professionally installed, and installer shall be responsible for verifying that the correct antenna is employed with the unit.

Antenna Connector Construction

The EUT has one internal antenna arrangement for WiFi, and the antenna gain is 3 dBi, fulfill the requirement of this section. Please refer to the EUT photos.

Result: Compliance.

FCC §15.207 (a)– AC LINE CONDUCTED EMISSIONS

Applicable Standard

FCC§15.207(a)

EUT Setup

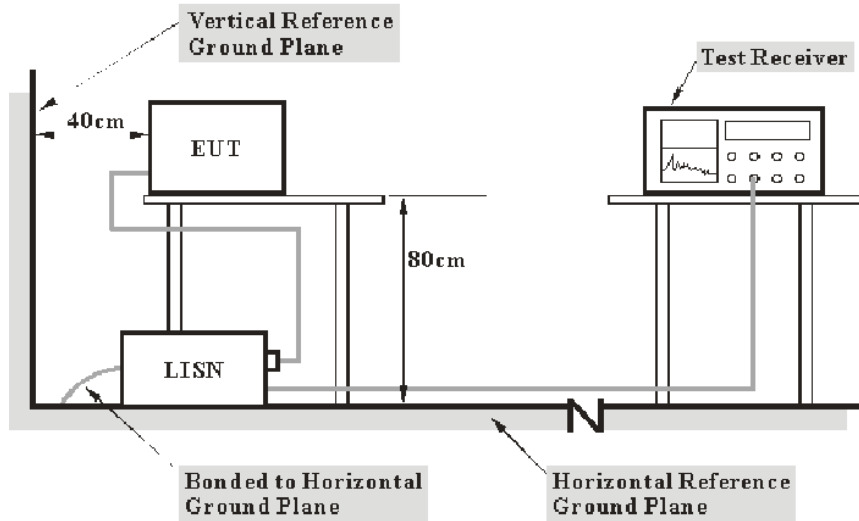

- Note: 1. Support units were connected to second LISN.
 2. Both of LISNs (AMN) 80 cm from EUT and at the least 80 cm from other units and other metal planes support units.

The setup of EUT is according with per ANSI C63.10-2013 measurement procedure. The specification used was with the FCC Part 15.207.

The spacing between the peripherals was 10 cm.

The adapter was connected to the main LISN with a 120 V/60 Hz AC power source.

EMI Test Receiver Setup

The EMI test receiver was set to investigate the spectrum from 150 kHz to 30 MHz.

During the conducted emission test, the EMI test receiver was set with the following configurations:

Frequency Range	IF B/W
150 kHz – 30 MHz	9 kHz

Test Procedure

During the conducted emission test, the adapter was connected to the first LISN.

Maximizing procedure was performed on the six (6) highest emissions of the EUT.

All data was recorded in the Quasi-peak and average detection mode.

Corrected Amplitude & Margin Calculation

The basic equation is as follows:

$$V_C = V_R + A_C + VDF$$

$$C_f = A_C + VDF$$

Herein,

V_C (cord. Reading): corrected voltage amplitude

V_R : reading voltage amplitude

A_C : attenuation caused by cable loss

VDF: voltage division factor of AMN

C_f : Correction Factor

The “**Margin**” column of the following data tables indicates the degree of compliance within the applicable limit. For example, a margin of 7dB means the emission is 7dB below the limit. The equation for margin calculation is as follows:

$$\text{Margin} = \text{Limit} - \text{Corrected Amplitude}$$

Test Equipment List and Details

Manufacturer	Description	Model	Serial Number	Calibration Date	Calibration Due Date
R&S	EMI Test Receiver	ESCS 30	830245/006	2017-12-11	2018-12-11
R&S	Two-line V-network	ENV 216	101614	2017-12-08	2018-12-08
Unknown	Coaxial Cable	C-NJNJ-50	C-0200-01	2017-09-05	2018-09-05
R&S	Test Software	EMC32	Version8.53.0	N/A	N/A

* **Statement of Traceability:** Bay Area Compliance Laboratories Corp. (Dongguan) attests that all calibrations have been performed, traceable to National Primary Standards and International System of Units (SI).

Test Data

Environmental Conditions

Temperature:	26.6 °C
Relative Humidity:	57 %
ATM Pressure:	100.5kPa

The testing was performed by Sider Huang on 2018-05-16.

Test Mode: Transmitting (802.11b Mode High channel was the worst)

AC120 V, 60 Hz, Line:

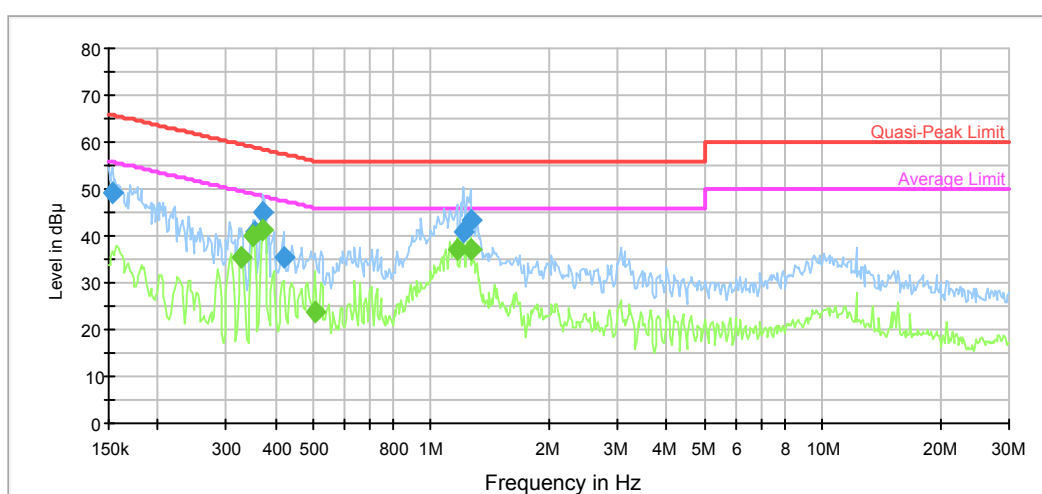

Frequency (MHz)	QuasiPeak (dBμV)	Bandwidth (kHz)	Line	Corr. (dB)	Margin (dB)	Limit (dBμV)	Comment
0.153629	49.2	9.000	L1	11.1	16.6	65.8	Compliance
0.354674	41.0	9.000	L1	10.0	17.9	58.9	Compliance
0.372042	45.2	9.000	L1	10.0	13.3	58.5	Compliance
0.419276	35.4	9.000	L1	10.0	22.0	57.5	Compliance
1.209904	40.9	9.000	L1	9.8	15.1	56.0	Compliance
1.259081	43.2	9.000	L1	9.8	12.8	56.0	Compliance

Frequency (MHz)	Average (dBμV)	Bandwidth (kHz)	Line	Corr. (dB)	Margin (dB)	Limit (dBμV)	Comment
0.327509	35.6	9.000	L1	10.1	13.9	49.5	Compliance
0.351859	39.9	9.000	L1	10.0	9.0	48.9	Compliance
0.372042	41.3	9.000	L1	10.0	7.2	48.5	Compliance
0.503608	23.8	9.000	L1	9.9	22.2	46.0	Compliance
1.162648	36.9	9.000	L1	9.8	9.1	46.0	Compliance
1.259081	37.2	9.000	L1	9.8	8.8	46.0	Compliance

AC120 V, 60 Hz, Neutral:

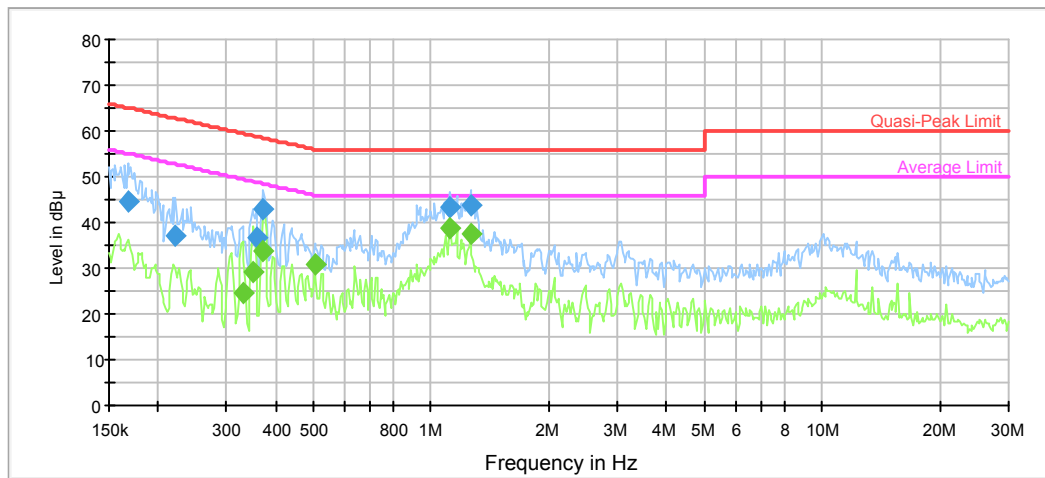

Frequency (MHz)	QuasiPeak (dB μ V)	Bandwidth (kHz)	Line	Corr. (dB)	Margin (dB)	Limit (dB μ V)	Comment
0.167702	44.7	9.000	N	10.9	20.4	65.1	Compliance
0.221645	37.2	9.000	N	10.5	25.6	62.8	Compliance
0.357511	36.8	9.000	N	10.0	22.0	58.8	Compliance
0.372042	43.0	9.000	N	10.0	15.5	58.5	Compliance
1.117238	43.4	9.000	N	9.8	12.6	56.0	Compliance
1.259081	43.8	9.000	N	9.8	12.2	56.0	Compliance

Frequency (MHz)	Average (dB μ V)	Bandwidth (kHz)	Line	Corr. (dB)	Margin (dB)	Limit (dB μ V)	Comment
0.330129	24.5	9.000	N	10.1	24.9	49.4	Compliance
0.351859	29.2	9.000	N	10.0	19.7	48.9	Compliance
0.372042	33.7	9.000	N	10.0	14.8	48.5	Compliance
0.503608	30.8	9.000	N	9.9	15.2	46.0	Compliance
1.117238	38.9	9.000	N	9.8	7.1	46.0	Compliance
1.259081	37.6	9.000	N	9.8	8.4	46.0	Compliance

FCC §15.209, §15.205 & §15.247(d) - SPURIOUS EMISSIONS

Applicable Standard

FCC §15.247 (d); §15.209; §15.205;

EUT Setup

Below 1GHz:

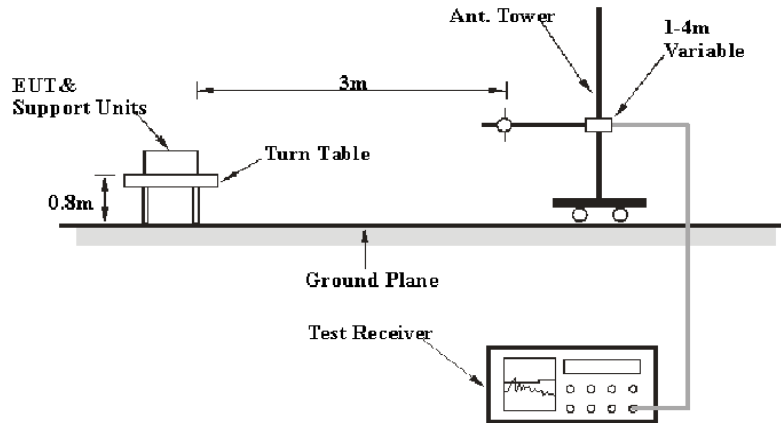

Above 1GHz:

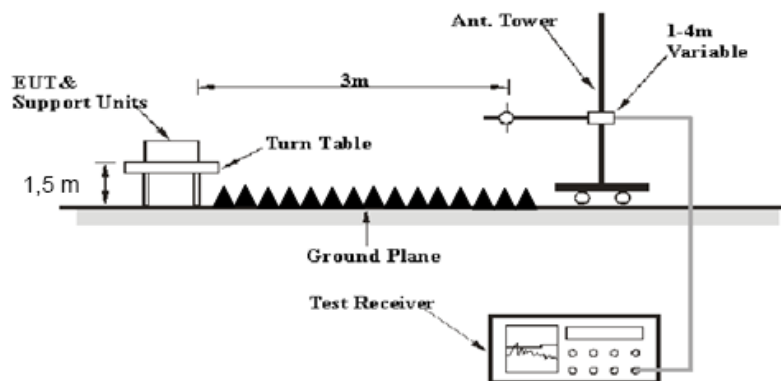

The radiated emission Below 1GHz tests were performed in the 3 meters chamber test site A, above 1GHz tests were performed in the 3 meters chamber test site B, using the setup accordance with the ANSI C63.10-2013. The specification used was the FCC 15.209, and FCC 15.247 limits.

The spacing between the peripherals was 10 cm.

EMI Test Receiver & Spectrum Analyzer Setup

The system was investigated from 30 MHz to 25 GHz.

During the radiated emission test, the EMI test receiver & Spectrum Analyzer Setup were set with the following configurations:

30MHz-1000MHz:

Measurement	RBW	Video B/W	IF B/W
QP	120 kHz	300 kHz	120kHz

1GHz- 25GHz:

Measurement	Duty cycle	RBW	Video B/W
PK	Any	1MHz	3 MHz
AV	>98%	1MHz	10 Hz
	<98%	1MHz	1/T

Note: T is minimum transmission duration

Test Procedure

Maximizing procedure was performed on the highest emissions to ensure that the EUT complied with all installation combinations.

Data was recorded in Quasi-peak detection mode for frequency range of 30 MHz-1 GHz, peak and Average detection modes for frequencies above 1 GHz.

Corrected Amplitude & Margin Calculation

The Corrected Amplitude is calculated by adding the Antenna Factor and Cable Loss, and subtracting the Amplifier Gain from the Meter Reading. The basic equation is as follows:

$$\text{Corrected Amplitude} = \text{Meter Reading} + \text{Antenna Factor} + \text{Cable Loss} - \text{Amplifier Gain}$$

The “**Margin**” column of the following data tables indicates the degree of compliance with the applicable limit. For example, a margin of 7dB means the emission is 7dB below the limit. The equation for margin calculation is as follows:

$$\text{Margin} = \text{Limit} - \text{Corrected Amplitude}$$

Test Equipment List and Details

Manufacturer	Description	Model	Serial Number	Calibration Date	Calibration Due Date
R&S	EMI Test Receiver	ESCI	100224	2017-12-11	2018-12-11
Sunol Sciences	Antenna	JB3	A060611-1	2017-11-10	2020-11-10
HP	Amplifier	8447D	2727A05902	2017-09-05	2018-09-05
Agilent	Spectrum Analyzer	E4440A	SG43360054	2018-01-04	2019-01-04
ETS-Lindgren	Horn Antenna	3115	000 527 35	2016-01-05	2019-01-04
MITEQ	Amplifier	AFS42-00101800-25-S-42	2001271	2017-09-05	2018-09-05
Quinstar	Amplifier	QLW-18405536-JO	15964001001	2017-06-27	2018-06-27
Ducommun Technologies	Horn Antenna	ARH-4223-02	1007726-01 1304	2016-11-18	2019-11-18
E-Microwave	Band-stop Filters	OBSF-2400-2483.5-S	OE01601525	2017-06-16	2018-06-16
Micro-tronics	High Pass Filter	HPM50111	S/N-G217	2017-06-16	2018-06-16
Unknown	Coaxial Cable	C-NJNJ-50	C-0400-01	2017-09-05	2018-09-05
Unknown	Coaxial Cable	C-NJNJ-50	C-0075-01	2017-09-05	2018-09-05
Unknown	Coaxial Cable	C-NJNJ-50	C-1000-01	2017-09-05	2018-09-05
Unknown	Coaxial Cable	C-SJSJ-50	C-0800-01	2017-09-05	2018-09-05
Unknown	Coaxial Cable	C-2.4J2.4J-50	C-0700-02	2017-06-27	2018-06-27
Farad	Test Software	EZ-EMC	V1.1.4.2	N/A	N/A

* **Statement of Traceability:** Bay Area Compliance Laboratories Corp. (Dongguan) attests that all calibrations have been performed, traceable to National Primary Standards and International System of Units (SI).

Test Data**Environmental Conditions**

Temperature:	24.6~24.9 °C
Relative Humidity:	43~52 %
ATM Pressure:	100.8~101 kPa

* The testing was performed by Sunny Cen&Steven Zuo on 2018-05-02 and 2018-05-16.

Test Result: Compliance, please Refer to the following data

Test Mode: Transmitting

1) 30MHz-1GHz (802.11b Mode High channel was the worst):

Horizontal:

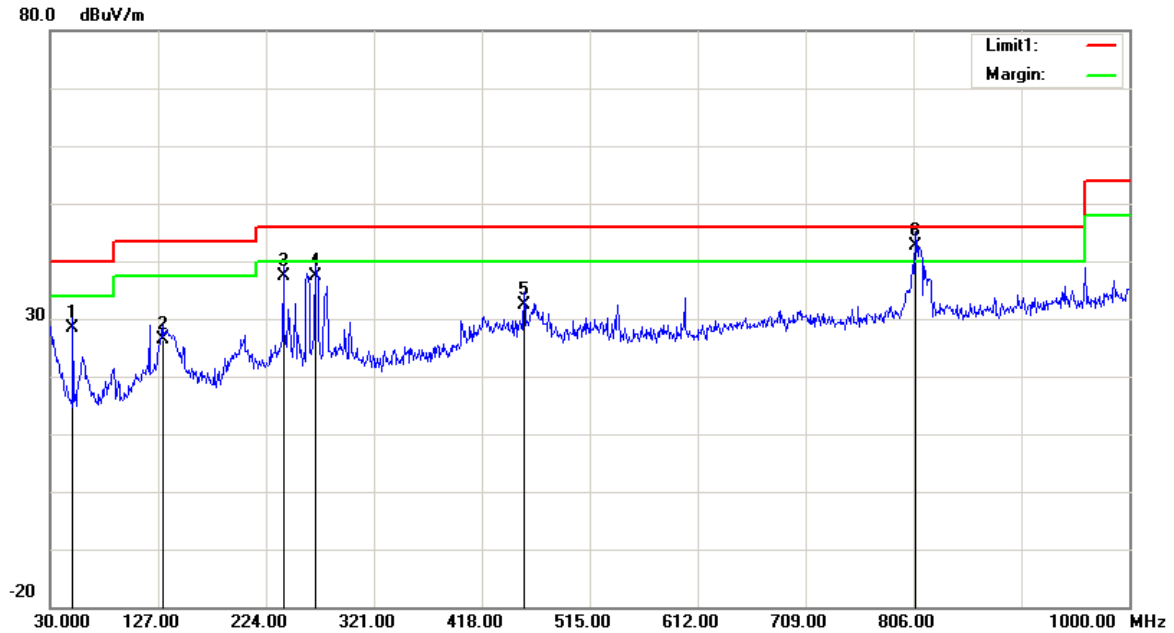

Frequency (MHz)	Receiver Reading (dBuV)	Detector	Correction Factor (dB/m)	Cord. Amp. (dBuV/m)	Limit (dBuV/m)	Margin (dB)
50.3700	39.74	QP	-11.34	28.40	40.00	11.60
130.8800	31.36	QP	-4.96	26.40	43.50	17.10
239.5200	43.60	QP	-6.10	37.50	46.00	8.50
268.6200	41.78	QP	-4.38	37.40	46.00	8.60
455.8300	33.57	QP	-1.07	32.50	46.00	13.50
807.9400	37.73	QP	4.87	42.60	46.00	3.40

Vertical:

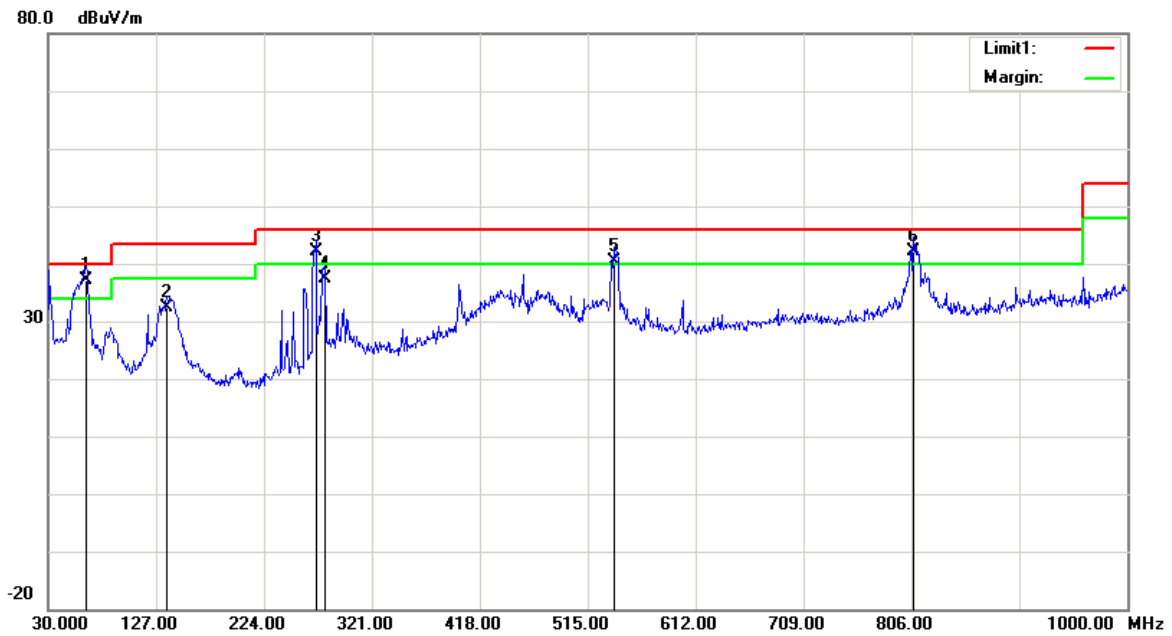

Frequency (MHz)	Receiver Reading (dBuV)	Detector	Correction Factor (dB/m)	Cord. Amp. (dBuV/m)	Limit (dBuV/m)	Margin (dB)
63.9500	49.09	QP	-11.89	37.20	40.00	2.80
136.7000	37.79	QP	-5.39	32.40	43.50	11.10
270.5600	46.48	QP	-4.28	42.20	46.00	3.80
279.2900	41.64	QP	-4.14	37.50	46.00	8.50
538.2800	40.24	QP	0.26	40.50	46.00	5.50
807.9400	37.23	QP	4.87	42.10	46.00	3.90

2) 1-25GHz:

802.11b Mode:

Frequency (MHz)	Receiver		Rx Antenna		Cable loss (dB)	Amplifier Gain (dB)	Corrected Amplitude (dBμV/m)	Limit (dBμV/m)	Margin (dB)
	Reading (dBμV)	Detector	Polar (H/V)	Factor (dB/m)					
Low Channel: 2412 MHz									
2412.00	73.91	PK	H	28.12	1.81	0.00	103.84	N/A	N/A
2412.00	69.69	AV	H	28.12	1.81	0.00	99.62	N/A	N/A
2412.00	80.23	PK	V	28.12	1.81	0.00	110.16	N/A	N/A
2412.00	76.37	AV	V	28.12	1.81	0.00	106.30	N/A	N/A
2390.00	31.89	PK	V	28.08	1.80	0.00	61.77	74.00	12.23
2390.00	21.76	AV	V	28.08	1.80	0.00	51.64	54.00	2.36
4824.00	47.69	PK	V	32.95	3.19	37.20	46.63	74.00	27.37
4824.00	36.58	AV	V	32.95	3.19	37.20	35.52	54.00	18.48
7236.00	46.45	PK	V	35.81	4.77	37.27	49.76	74.00	24.24
7236.00	35.27	AV	V	35.81	4.77	37.27	38.58	54.00	15.42
Middle Channel: 2437 MHz									
2437.00	73.56	PK	H	28.17	1.82	0.00	103.55	N/A	N/A
2437.00	69.42	AV	H	28.17	1.82	0.00	99.41	N/A	N/A
2437.00	80.12	PK	V	28.17	1.82	0.00	110.11	N/A	N/A
2437.00	76.18	AV	V	28.17	1.82	0.00	106.17	N/A	N/A
4874.00	47.38	PK	V	33.05	3.26	37.21	46.48	74.00	27.52
4874.00	36.52	AV	V	33.05	3.26	37.21	35.62	54.00	18.38
7311.00	46.29	PK	V	36.01	4.64	37.36	49.58	74.00	24.42
7311.00	35.33	AV	V	36.01	4.64	37.36	38.62	54.00	15.38
High Channel: 2462 MHz									
2462.00	71.99	PK	H	28.22	1.83	0.00	102.04	N/A	N/A
2462.00	68.22	AV	H	28.22	1.83	0.00	98.27	N/A	N/A
2462.00	80.76	PK	V	28.22	1.83	0.00	110.81	N/A	N/A
2462.00	76.35	AV	V	28.22	1.83	0.00	106.40	N/A	N/A
2483.50	33.46	PK	V	28.27	1.84	0.00	63.57	74.00	10.43
2483.50	21.59	AV	V	28.27	1.84	0.00	51.70	54.00	2.30
4924.00	47.53	PK	V	33.15	3.27	37.22	46.73	74.00	27.27
4924.00	36.48	AV	V	33.15	3.27	37.22	35.68	54.00	18.32
7386.00	46.72	PK	V	36.20	4.51	37.46	49.97	74.00	24.03
7386.00	36.43	AV	V	36.20	4.51	37.46	39.68	54.00	14.32

802.11g Mode:

Frequency (MHz)	Receiver		Rx Antenna		Cable loss (dB)	Amplifier Gain (dB)	Corrected Amplitude (dBµV/m)	Limit (dBµV/m)	Margin (dB)
	Reading (dBµV)	Detector	Polar (H/V)	Factor (dB/m)					
Low Channel: 2412 MHz									
2412.00	69.59	PK	H	28.12	1.81	0.00	99.52	N/A	N/A
2412.00	59.37	AV	H	28.12	1.81	0.00	89.30	N/A	N/A
2412.00	77.62	PK	V	28.12	1.81	0.00	107.55	N/A	N/A
2412.00	68.21	AV	V	28.12	1.81	0.00	98.14	N/A	N/A
2390.00	38.94	PK	V	28.08	1.80	0.00	68.82	74.00	5.18
2390.00	22.06	AV	V	28.08	1.80	0.00	51.94	54.00	2.06
4824.00	46.93	PK	V	32.95	3.19	37.20	45.87	74.00	28.13
4824.00	35.84	AV	V	32.95	3.19	37.20	34.78	54.00	19.22
7236.00	46.28	PK	V	35.81	4.77	37.27	49.59	74.00	24.41
7236.00	35.35	AV	V	35.81	4.77	37.27	38.66	54.00	15.34
Middle Channel: 2437 MHz									
2437.00	70.83	PK	H	28.17	1.82	0.00	100.82	N/A	N/A
2437.00	60.75	AV	H	28.17	1.82	0.00	90.74	N/A	N/A
2437.00	78.93	PK	V	28.17	1.82	0.00	108.92	N/A	N/A
2437.00	68.52	AV	V	28.17	1.82	0.00	98.51	N/A	N/A
4874.00	47.63	PK	V	33.05	3.26	37.21	46.73	74.00	27.27
4874.00	36.84	AV	V	33.05	3.26	37.21	35.94	54.00	18.06
7311.00	46.57	PK	V	36.01	4.64	37.36	49.86	74.00	24.14
7311.00	35.29	AV	V	36.01	4.64	37.36	38.58	54.00	15.42
High Channel: 2462 MHz									
2462.00	69.76	PK	H	28.22	1.83	0.00	99.81	N/A	N/A
2462.00	59.64	AV	H	28.22	1.83	0.00	89.69	N/A	N/A
2462.00	77.78	PK	V	28.22	1.83	0.00	107.83	N/A	N/A
2462.00	68.59	AV	V	28.22	1.83	0.00	98.64	N/A	N/A
2483.50	38.62	PK	V	28.27	1.84	0.00	68.73	74.00	5.27
2483.50	21.56	AV	V	28.27	1.84	0.00	51.67	54.00	2.33
4924.00	47.63	PK	V	33.15	3.27	37.22	46.83	74.00	27.17
4924.00	36.29	AV	V	33.15	3.27	37.22	35.49	54.00	18.51
7386.00	46.74	PK	V	36.20	4.51	37.46	49.99	74.00	24.01
7386.00	35.58	AV	V	36.20	4.51	37.46	38.83	54.00	15.17

802.11n ht20 Mode:

Frequency (MHz)	Receiver		Rx Antenna		Cable loss (dB)	Amplifier Gain (dB)	Corrected Amplitude (dBµV/m)	Limit (dBµV/m)	Margin (dB)
	Reading (dBµV)	Detector	Polar (H/V)	Factor (dB/m)					
Low Channel: 2412 MHz									
2412.00	68.76	PK	H	28.12	1.81	0.00	98.69	N/A	N/A
2412.00	58.54	AV	H	28.12	1.81	0.00	88.47	N/A	N/A
2412.00	77.15	PK	V	28.12	1.81	0.00	107.08	N/A	N/A
2412.00	67.62	AV	V	28.12	1.81	0.00	97.55	N/A	N/A
2390.00	40.43	PK	V	28.08	1.80	0.00	70.31	74.00	3.69
2390.00	21.85	AV	V	28.08	1.80	0.00	51.73	54.00	2.27
4824.00	47.52	PK	V	32.95	3.19	37.20	46.46	74.00	27.54
4824.00	36.48	AV	V	32.95	3.19	37.20	35.42	54.00	18.58
7236.00	46.53	PK	V	35.81	4.77	37.27	49.84	74.00	24.16
7236.00	35.27	AV	V	35.81	4.77	37.27	38.58	54.00	15.42
Middle Channel: 2437 MHz									
2437.00	70.53	PK	H	28.17	1.82	0.00	100.52	N/A	N/A
2437.00	60.49	AV	H	28.17	1.82	0.00	90.48	N/A	N/A
2437.00	78.22	PK	V	28.17	1.82	0.00	108.21	N/A	N/A
2437.00	68.57	AV	V	28.17	1.82	0.00	98.56	N/A	N/A
4874.00	47.52	PK	V	33.05	3.26	37.21	46.62	74.00	27.38
4874.00	36.38	AV	V	33.05	3.26	37.21	35.48	54.00	18.52
7311.00	45.89	PK	V	36.01	4.64	37.36	49.18	74.00	24.82
7311.00	35.12	AV	V	36.01	4.64	37.36	38.41	54.00	15.59
High Channel: 2462 MHz									
2462.00	69.27	PK	H	28.22	1.83	0.00	99.32	N/A	N/A
2462.00	59.46	AV	H	28.22	1.83	0.00	89.51	N/A	N/A
2462.00	77.58	PK	V	28.22	1.83	0.00	107.63	N/A	N/A
2462.00	68.23	AV	V	28.22	1.83	0.00	98.28	N/A	N/A
2483.50	40.65	PK	V	28.27	1.84	0.00	70.76	74.00	3.24
2483.50	21.87	AV	V	28.27	1.84	0.00	51.98	54.00	2.02
4924.00	47.58	PK	V	33.15	3.27	37.22	46.78	74.00	27.22
4924.00	36.45	AV	V	33.15	3.27	37.22	35.65	54.00	18.35
7386.00	45.49	PK	V	36.20	4.51	37.46	48.74	74.00	25.26
7386.00	34.26	AV	V	36.20	4.51	37.46	37.51	54.00	16.49

802.11n ht40 Mode:

Frequency (MHz)	Receiver		Rx Antenna		Cable loss (dB)	Amplifier Gain (dB)	Corrected Amplitude (dBµV/m)	Limit (dBµV/m)	Margin (dB)
	Reading (dBµV)	Detector	Polar (H/V)	Factor (dB/m)					
Low Channel: 2422 MHz									
2422.00	63.68	PK	H	28.14	1.81	0.00	93.63	N/A	N/A
2422.00	53.79	AV	H	28.14	1.81	0.00	83.74	N/A	N/A
2422.00	71.83	PK	V	28.14	1.81	0.00	101.78	N/A	N/A
2422.00	61.95	AV	V	28.14	1.81	0.00	91.90	N/A	N/A
2390.00	36.87	PK	V	28.08	1.80	0.00	66.75	74.00	7.25
2390.00	21.96	AV	V	28.08	1.80	0.00	51.84	54.00	2.16
4844.00	47.59	PK	V	32.99	3.22	37.20	46.60	74.00	27.40
4844.00	35.87	AV	V	32.99	3.22	37.20	34.88	54.00	19.12
7266.00	46.52	PK	V	35.89	4.72	37.31	49.82	74.00	24.18
7266.00	35.13	AV	V	35.89	4.72	37.31	38.43	54.00	15.57
Middle Channel: 2437 MHz									
2437.00	64.85	PK	H	28.17	1.82	0.00	94.84	N/A	N/A
2437.00	54.39	AV	H	28.17	1.82	0.00	84.38	N/A	N/A
2437.00	73.21	PK	V	28.17	1.82	0.00	103.20	N/A	N/A
2437.00	63.58	AV	V	28.17	1.82	0.00	93.57	N/A	N/A
4874.00	47.63	PK	V	33.05	3.26	37.21	46.73	74.00	27.27
4874.00	36.52	AV	V	33.05	3.26	37.21	35.62	54.00	18.38
7311.00	46.37	PK	V	36.01	4.64	37.36	49.66	74.00	24.34
7311.00	35.29	AV	V	36.01	4.64	37.36	38.58	54.00	15.42
High Channel: 2452 MHz									
2452.00	63.96	PK	H	28.20	1.83	0.00	93.99	N/A	N/A
2452.00	54.21	AV	H	28.20	1.83	0.00	84.24	N/A	N/A
2452.00	72.32	PK	V	28.20	1.83	0.00	102.35	N/A	N/A
2452.00	62.94	AV	V	28.20	1.83	0.00	92.97	N/A	N/A
2483.50	35.86	PK	V	28.27	1.84	0.00	65.97	74.00	8.03
2483.50	18.65	AV	V	28.27	1.84	0.00	48.76	54.00	5.24
4904.00	46.59	PK	V	33.11	3.30	37.21	45.79	74.00	28.21
4904.00	35.27	AV	V	33.11	3.30	37.21	34.47	54.00	19.53
7356.00	45.84	PK	V	36.13	4.56	37.42	49.11	74.00	24.89
7356.00	34.26	AV	V	36.13	4.56	37.42	37.53	54.00	16.47

Worst plots(802.11b Mode high channel) Horizontal

Fundamental
Test with Band
Rejection Filter

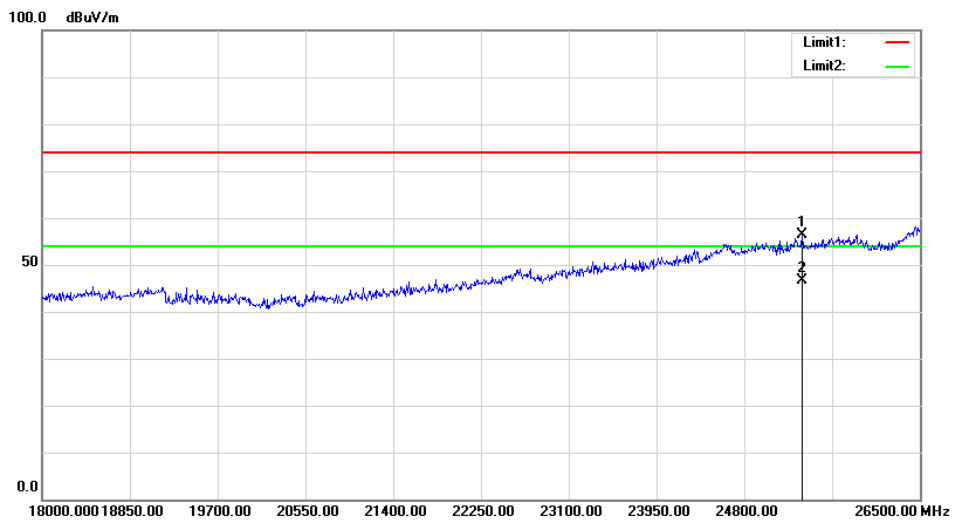
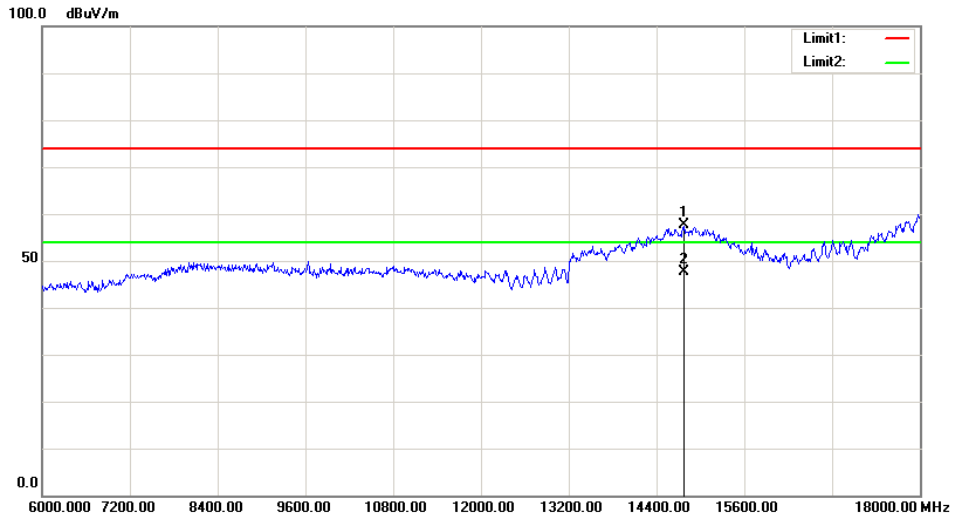
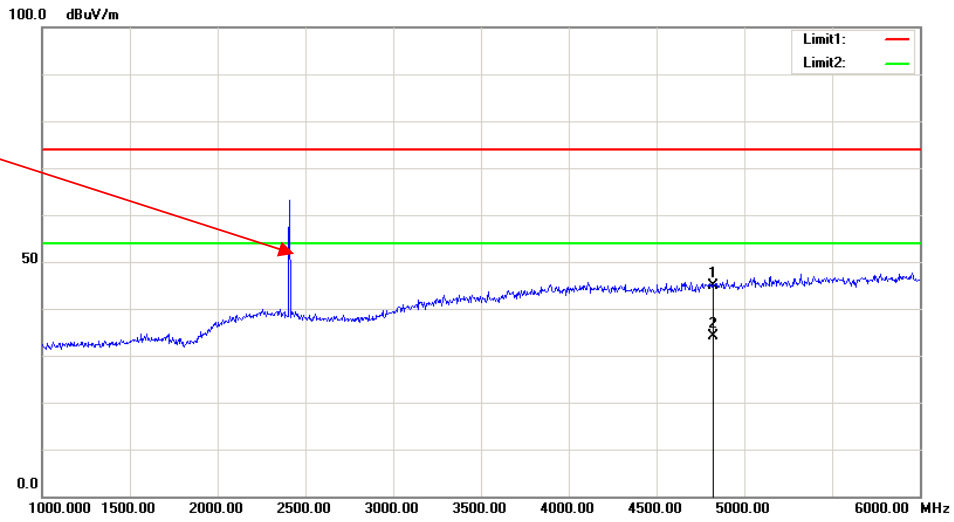

Vertical

Fundamental Test with Band Rejection Filter

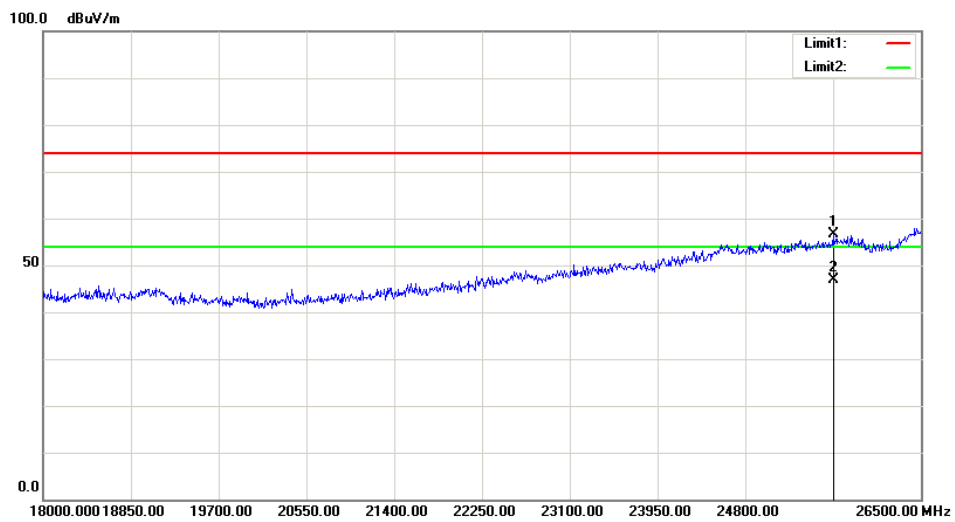
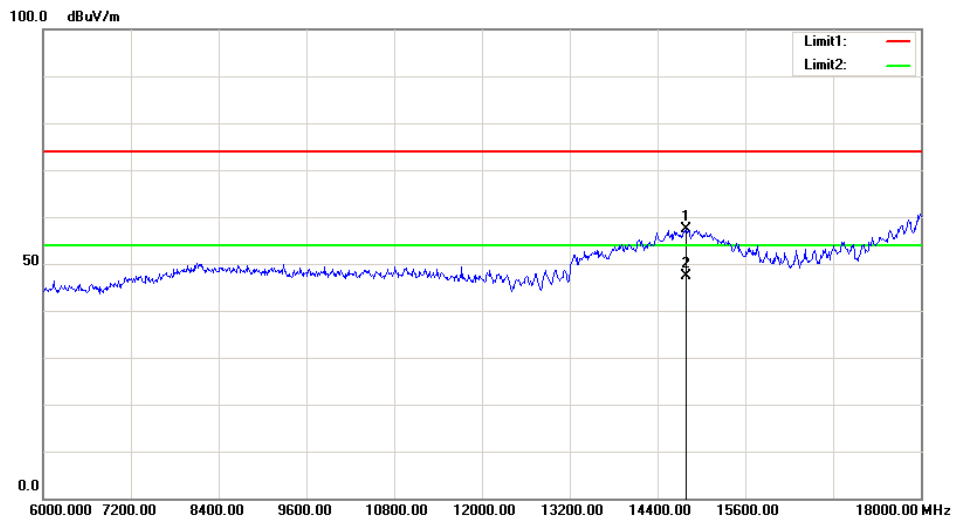
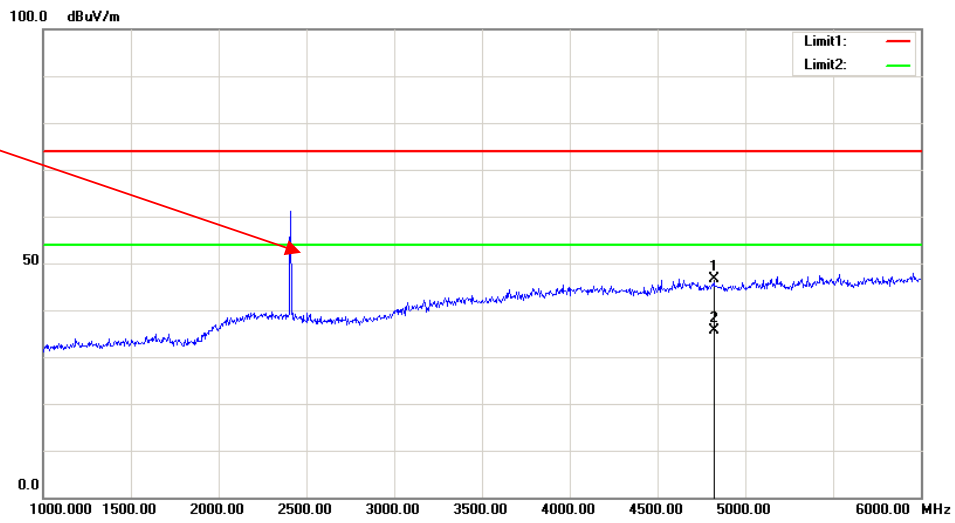

FCC §15.247(a) (2)–6 dB EMISSION BANDWIDTH

Applicable Standard

According to FCC §15.247(a) (2)

Systems using digital modulation techniques may operate in the 902–928 MHz, 2400–2483.5 MHz, and 5725–5850 MHz bands. The minimum 6 dB bandwidth shall be at least 500 kHz.

Test Procedure

- a) Set RBW = 100 kHz.
- b) Set the video bandwidth (VBW) $\geq 3 \times$ RBW.
- c) Detector = Peak.
- d) Trace mode = max hold.
- e) Sweep = auto couple.
- f) Allow the trace to stabilize.
- g) Measure the maximum width of the emission that is constrained by the frequencies associated with the two outermost amplitude points (upper and lower frequencies) that are attenuated by 6 dB relative to the maximum level measured in the fundamental emission.

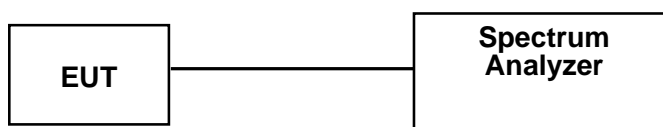

Test Equipment List and Details

Manufacturer	Description	Model	Serial Number	Calibration Date	Calibration Due Date
R&S	Spectrum Analyzer	FSU 26	200256	2018-01-04	2019-01-04
Unknown	Coaxial Cable	C-SJ00-0010	C0010/01	Each Time	/

* **Statement of Traceability:** Bay Area Compliance Laboratories Corp. (Dongguan) attests that all calibrations have been performed, traceable to National Primary Standards and International System of Units (SI).

Test Data

Environmental Conditions

Temperature:	24.2~26.9 °C
Relative Humidity:	51~64 %
ATM Pressure:	100.9~101 kPa

* The testing was performed by Andy Huang on 2018-04-28 and 2018-05-05.

Test Mode: Transmitting

Test Result: Compliant. Please refer to the following table and plots.

Test mode	Channel	Frequency (MHz)	6 dB Bandwidth (MHz)	Limit (MHz)
802.11b	Low	2412	9.86	≥0.5
	Middle	2437	9.70	≥0.5
	High	2462	9.70	≥0.5
802.11g	Low	2412	16.64	≥0.5
	Middle	2437	16.64	≥0.5
	High	2462	16.64	≥0.5
802.11n ht20	Low	2412	17.92	≥0.5
	Middle	2437	17.92	≥0.5
	High	2462	17.92	≥0.5
802.11n ht40	Low	2422	36.64	≥0.5
	Middle	2437	36.64	≥0.5
	High	2452	36.64	≥0.5

802.11b Low Channel

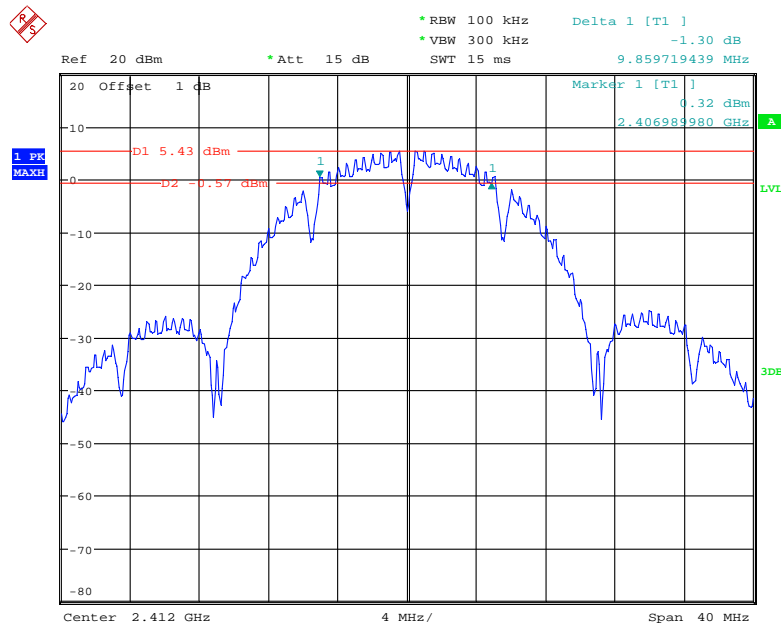

Date: 28.APR.2018 20:31:25

802.11b Middle Channel

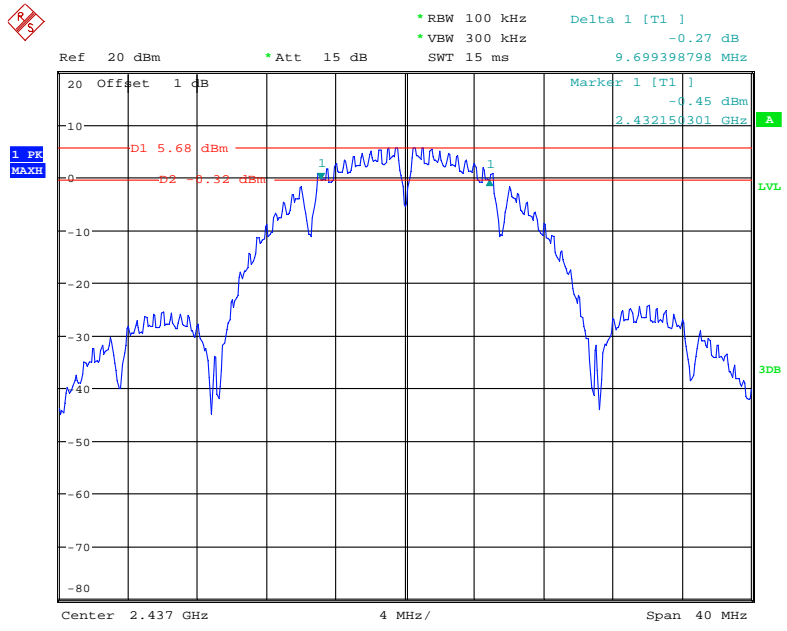

Date: 28.APR.2018 20:41:47

802.11b High Channel

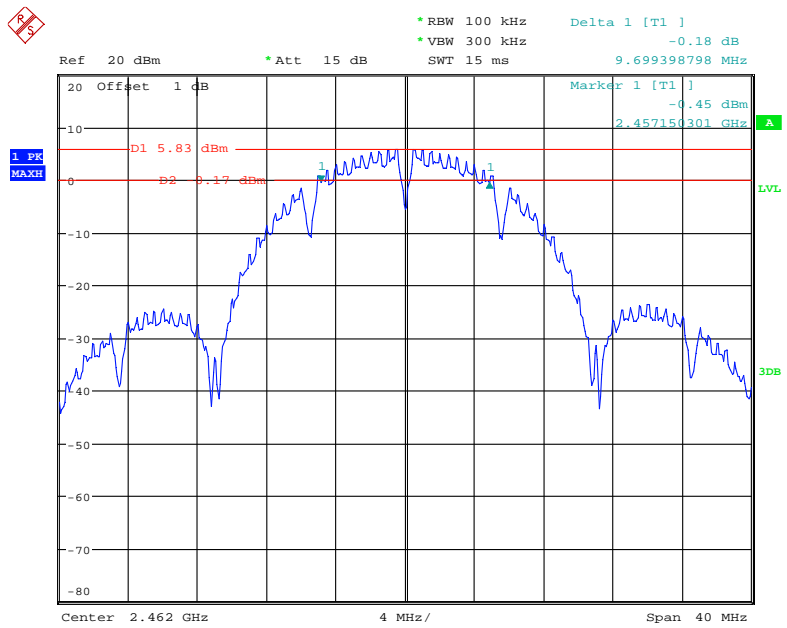

Date: 28.APR.2018 20:43:36

802.11g Low Channel

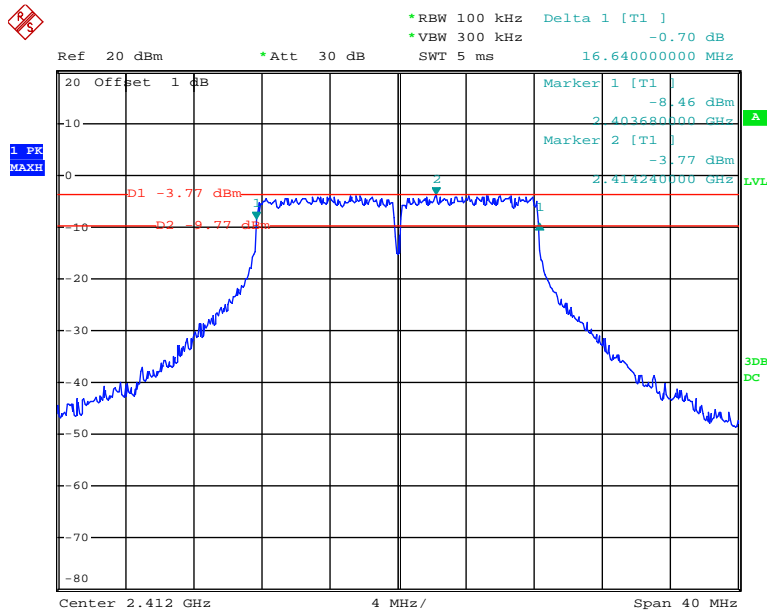

Date: 5.MAY.2018 11:43:11

802.11g Middle Channel

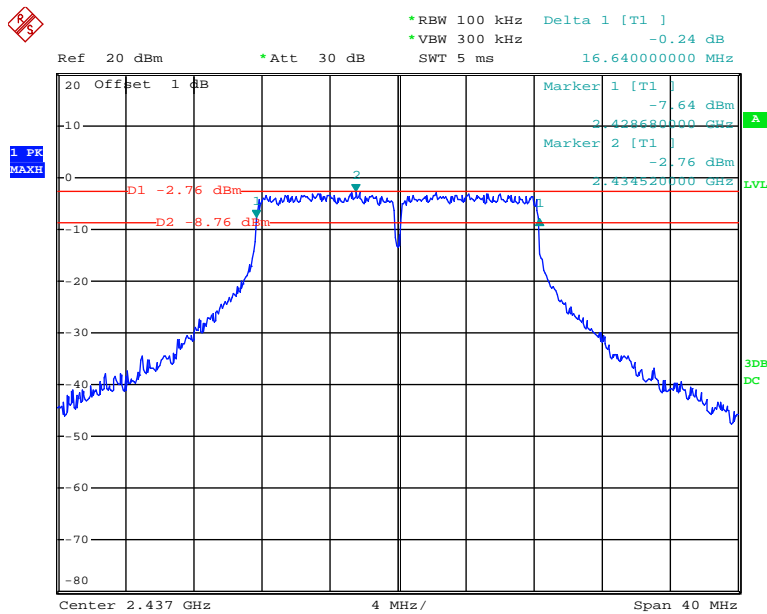

Date: 5.MAY.2018 11:44:38

802.11g High Channel

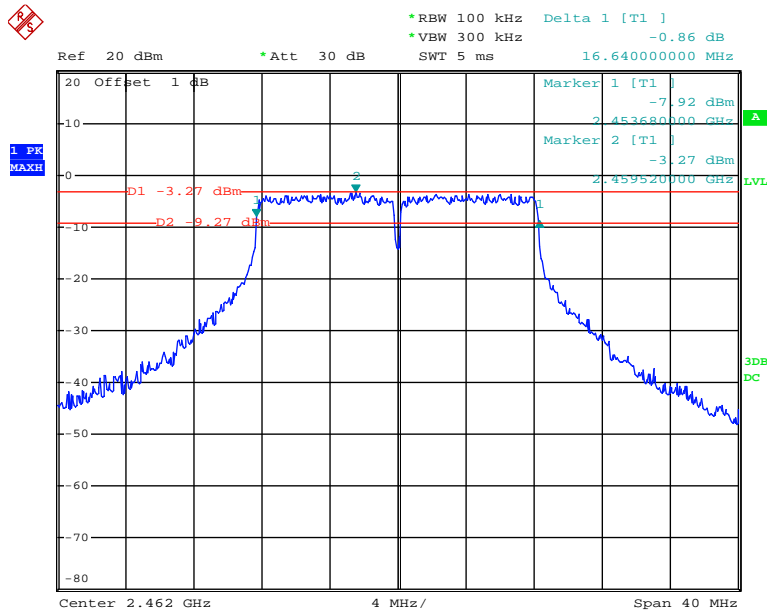

Date: 5.MAY.2018 11:45:47

802.11n ht20 Low Channel

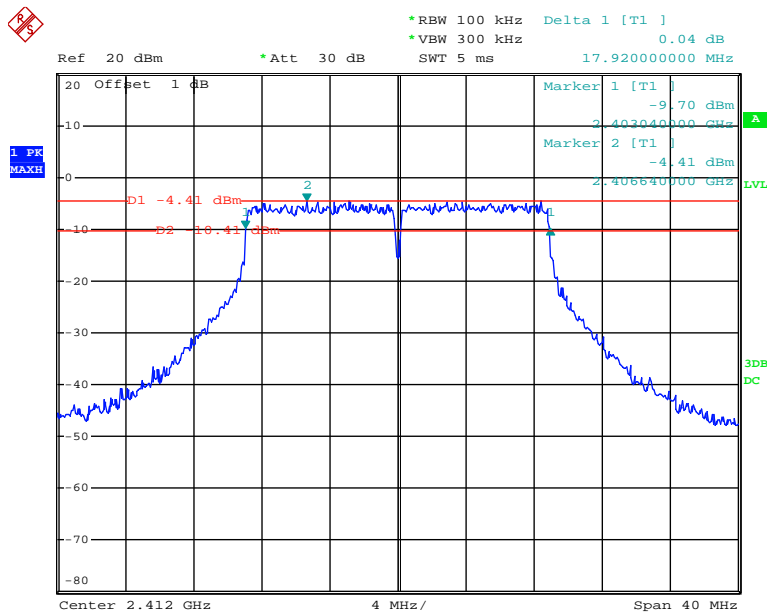

Date: 5.MAY.2018 11:50:16

802.11n ht20 Middle Channel

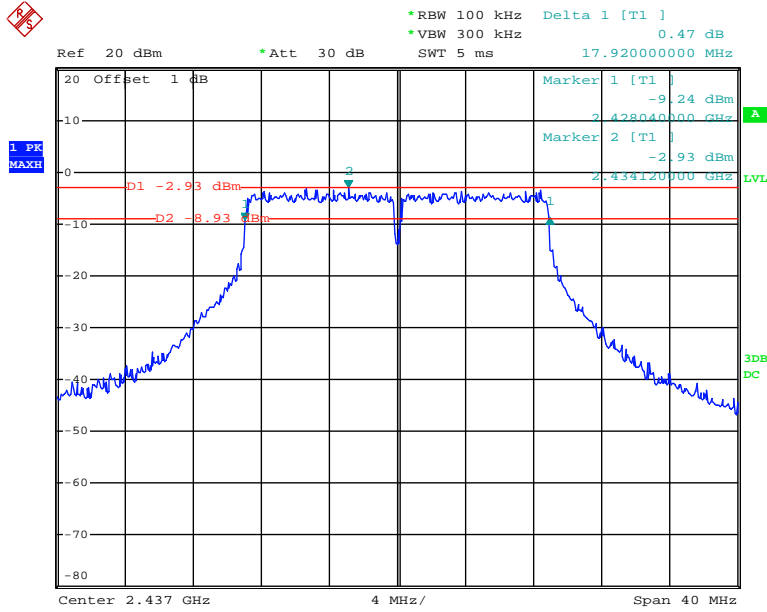

Date: 5.MAY.2018 11:49:04

802.11n ht20 High Channel

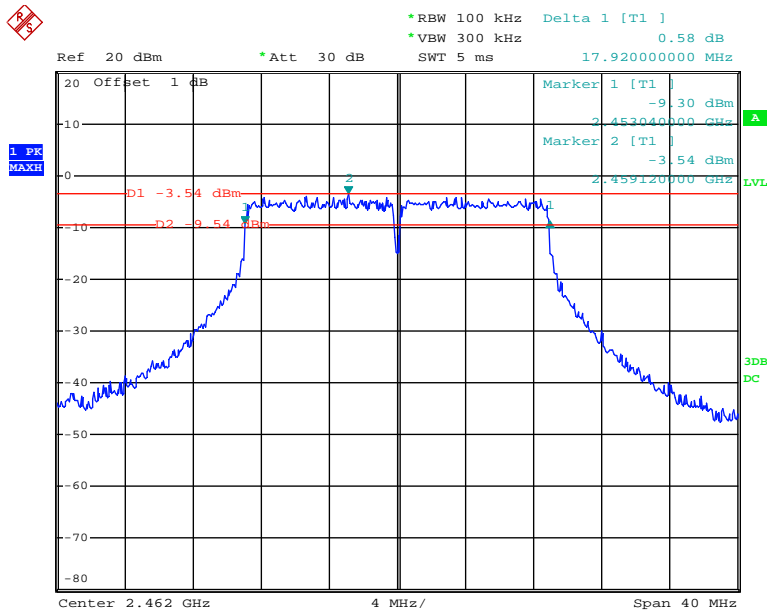

Date: 5.MAY.2018 11:47:34

802.11n ht40 Low Channel

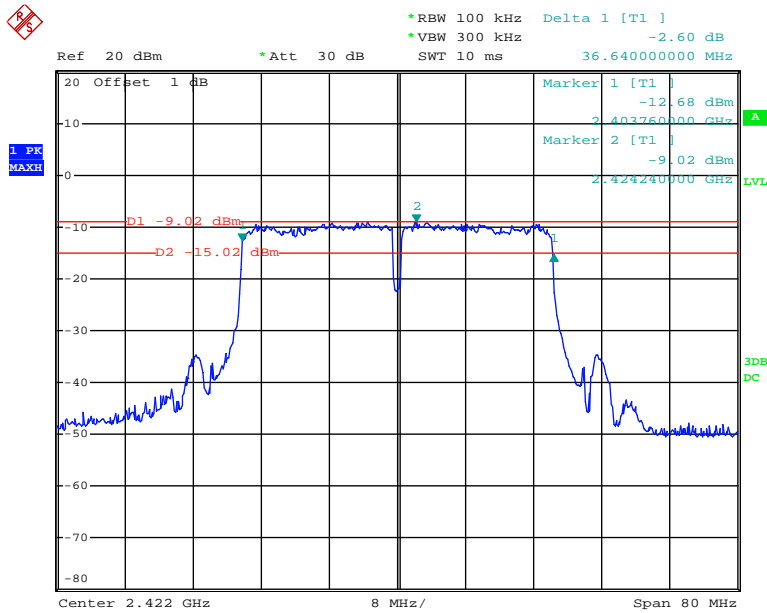

Date: 5.MAY.2018 11:51:38

802.11n ht40 Middle Channel

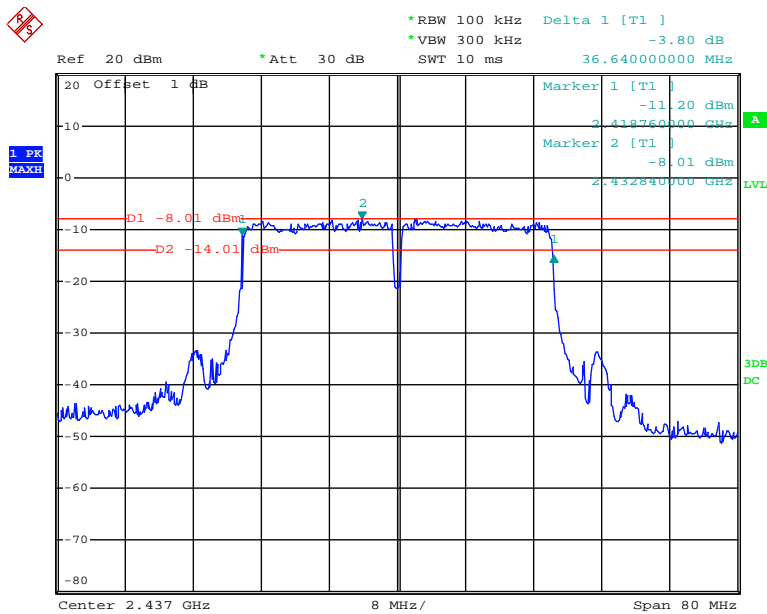

Date: 5.MAY.2018 11:53:53

802.11n ht40 High Channel

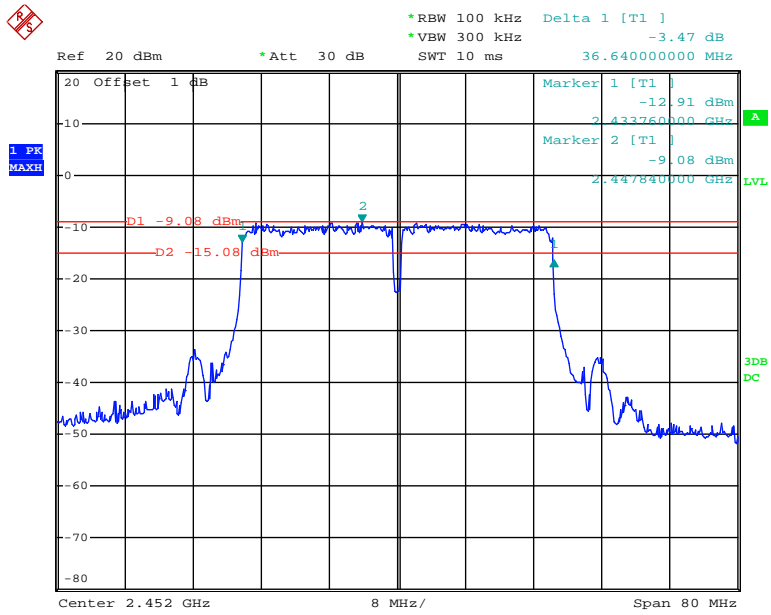

Date: 5.MAY.2018 11:55:58

FCC §15.247(b) (3) - MAXIMUM PEAK CONDUCTED OUTPUT POWER

Applicable Standard

According to FCC §15.247(b) (3), for systems using digital modulation in the 902-928 MHz, 2400-2483.5 MHz, and 5725-5850 MHz bands: 1 Watt. As an alternative to a peak power measurement, compliance with the one Watt limit can be based on a measurement of the maximum conducted output power. Maximum Conducted Output Power is defined as the total transmit power delivered to all antennas and antenna elements averaged across all symbols in the signaling alphabet when the transmitter is operating at its maximum power control level. Power must be summed across all antennas and antenna elements. The average must not include any time intervals during which the transmitter is off or is transmitting at a reduced power level. If multiple modes of operation are possible (e.g., alternative modulation methods), the maximum conducted output power is the highest total transmit power occurring in any mode.

Test Procedure

1. Place the EUT on a bench and set it in transmitting mode.
2. Remove the antenna from the EUT and then connect a low loss RF cable from the antenna port to test equipment.
3. Add a correction factor to the display.
4. Set the power Meter to test Peak output power, record the result as peak power.
5. Set the power meter to test average output power, record the result as average power.

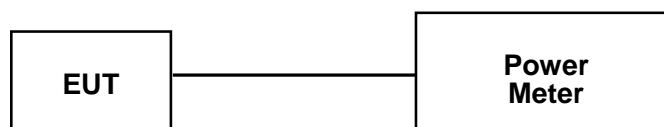

Test Equipment List and Details

Manufacturer	Description	Model	Serial Number	Calibration Date	Calibration Due Date
Agilent	USB Wideband Power Sensor	U2022XA	MY5417006	2017-12-11	2018-12-11
Unknown	Coaxial Cable	C-SJ00-0010	C0010/01	Each Time	/

* **Statement of Traceability:** Bay Area Compliance Laboratories Corp. (Dongguan) attests that all calibrations have been performed, traceable to National Primary Standards and International System of Units (SI).

Test Data

Environmental Conditions

Temperature:	26.9 °C
Relative Humidity:	51 %
ATM Pressure:	100.9 kPa

* The testing was performed by Andy Huang on 2018-04-28.

Test Mode: Transmitting

Test Result: Compliant. Please refer to the following table.

Test mode	Channel	Frequency (MHz)	Max Peak Conducted Output Power (dBm)	Limit (dBm)
802.11b	Low	2412	17.03	30
	Middle	2437	17.16	30
	High	2462	17.21	30
802.11g	Low	2412	19.99	30
	Middle	2437	20.52	30
	High	2462	20.47	30
802.11n ht20	Low	2412	18.57	30
	Middle	2437	19.88	30
	High	2462	19.63	30
802.11n ht40	Low	2422	17.40	30
	Middle	2437	17.76	30
	High	2452	17.80	30

FCC §15.247(d)– 100 kHz BANDWIDTH OF FREQUENCY BAND EDGE

Applicable Standard

According to FCC§15.247(d):In any 100 kHz bandwidth outside the frequency band in which the spread spectrum or digitally modulated intentional radiator is operating, the radio frequency power that is produced by the intentional radiator shall be at least 20 dB below that in the 100 kHz bandwidth within the band that contains the highest level of the desired power, based on either an RF conducted or a radiated measurement, provided the transmitter demonstrates compliance with the peak conducted power limits. If the transmitter complies with the conducted power limits based on the use of RMS averaging over a time interval, as permitted under paragraph (b)(3) of this section, the attenuation required under this paragraph shall be 30 dB instead of 20 dB. Attenuation below the general limits specified in §15.209(a) is not required. In addition, radiated emissions which fall in the restricted bands, as defined in §15.205(a), must also comply with the radiated emission limits specified in §15.209(a) (see §15.205(c)).

Test Procedure

1. Check the calibration of the measuring instrument using either an internal calibrator or a known signal from an external generator.
2. Position the EUT without connection to measurement instrument. Turn on the EUT and connect its antenna terminal to measurement instrument via a low loss cable. Then set it to any one measured frequency within its operating range, and make sure the instrument is operated in its linear range.
3. Set RBW to 100 kHz and VBW of spectrum analyzer to 300 kHz with a convenient frequency span including 100 kHz bandwidth from band edge.
4. Measure the highest amplitude appearing on spectral display and set it as a reference level. Plot the graph with marking the highest point and edge frequency.
5. Repeat above procedures until all measured frequencies were complete.

Test Equipment List and Details

Manufacturer	Description	Model	Serial Number	Calibration Date	Calibration Due Date
R&S	Spectrum Analyzer	FSU 26	200256	2018-01-04	2019-01-04
Unknown	Coaxial Cable	C-SJ00-0010	C0010/01	Each Time	/

* **Statement of Traceability:** Bay Area Compliance Laboratories Corp. (Dongguan) attests that all calibrations have been performed, traceable to National Primary Standards and International System of Units (SI).

Test Data

Environmental Conditions

Temperature:	24.2~26.9 °C
Relative Humidity:	51~64 %
ATM Pressure:	100.9~101 kPa

* The testing was performed by Andy Huang on 2018-04-28 and 2018-05-05.

Test mode: Transmitting

Test Result: Compliant. Please refer to following plots.

802.11b: Band Edge, Left Side

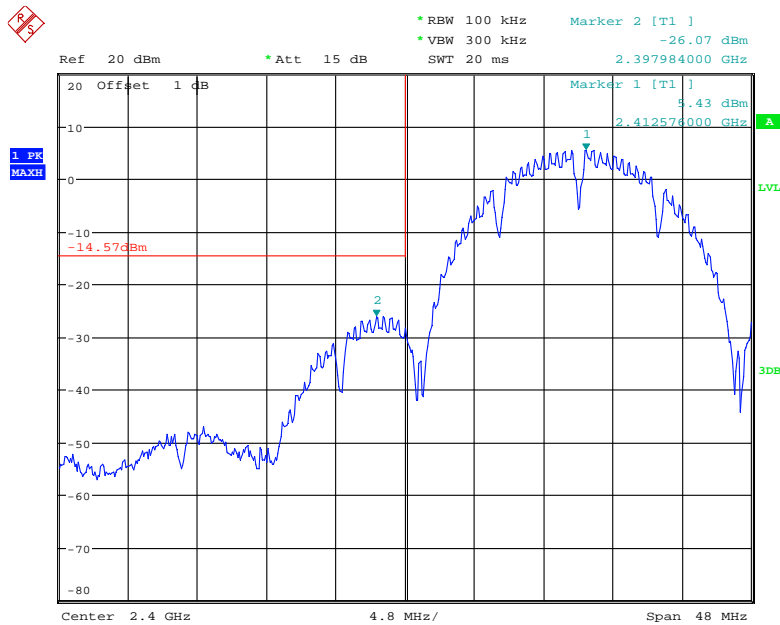

Date: 28.APR.2018 20:32:11

802.11b: Band Edge, Right Side

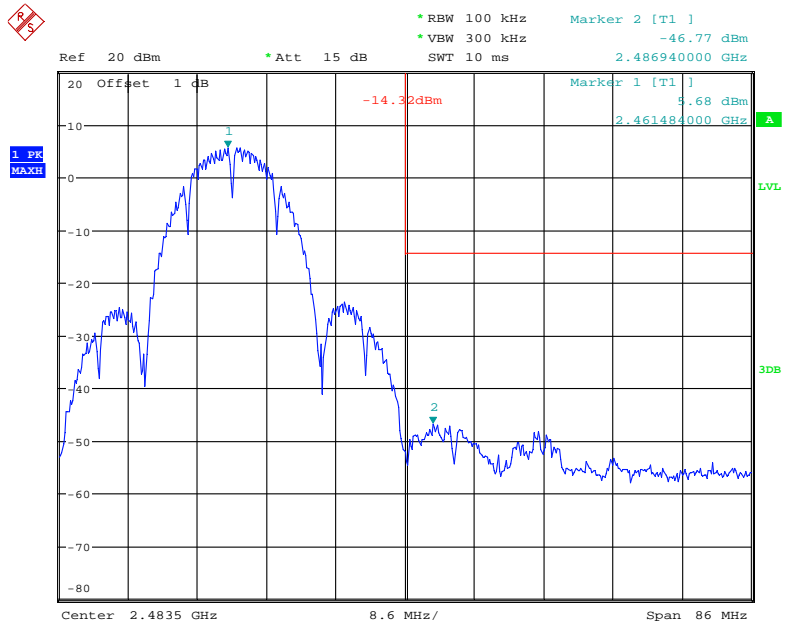

Date: 28.APR.2018 20:44:18

802.11g: Band Edge, Left Side

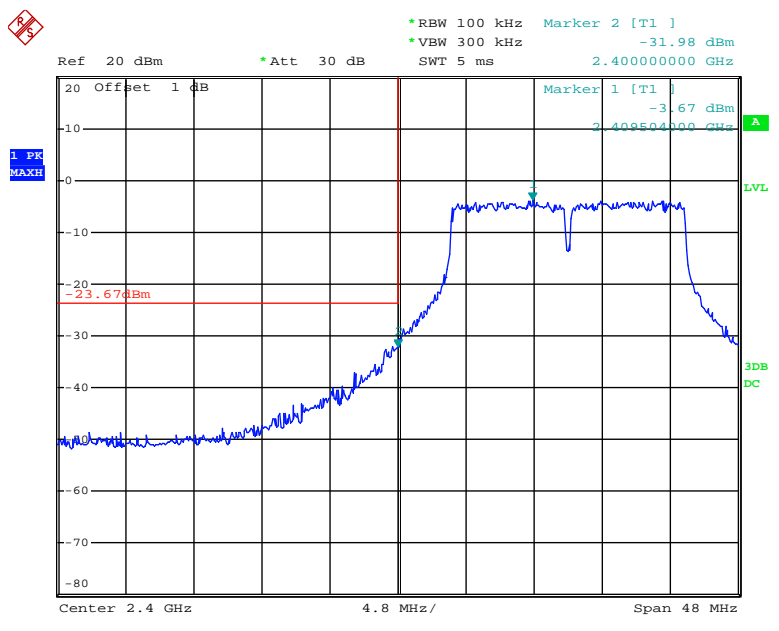

Date: 5.MAY.2018 11:43:57

802.11g: Band Edge, Right Side

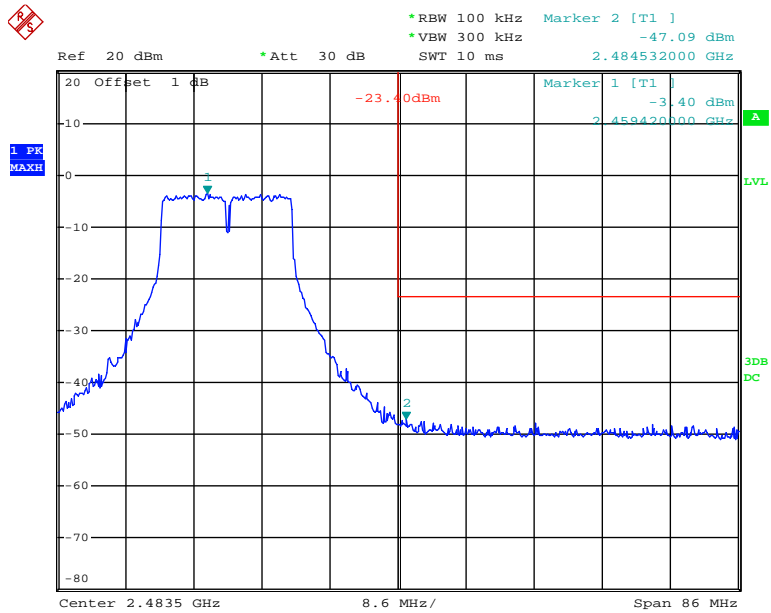

Date: 5.MAY.2018 11:46:53

802.11n ht20 Band Edge, Left Side

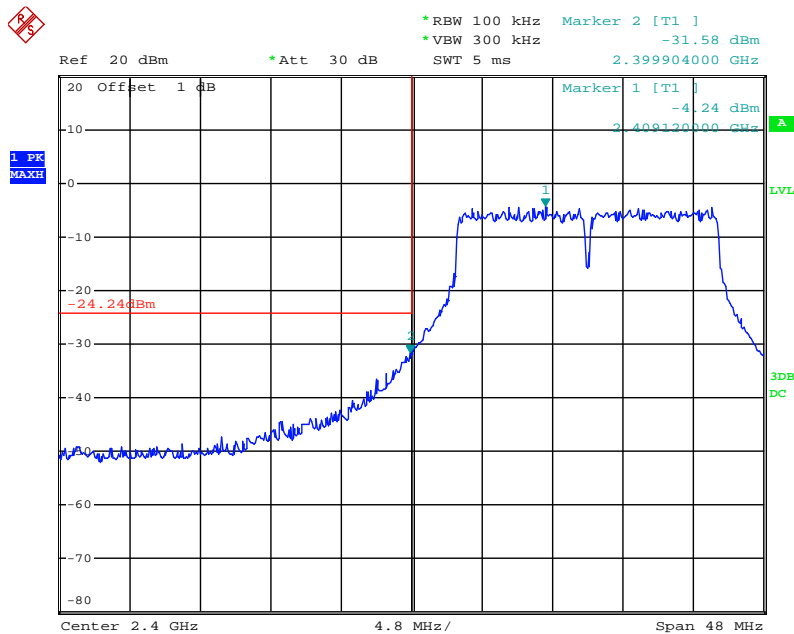

Date: 5.MAY.2018 11:51:03

802.11n ht20 Band Edge, Right Side

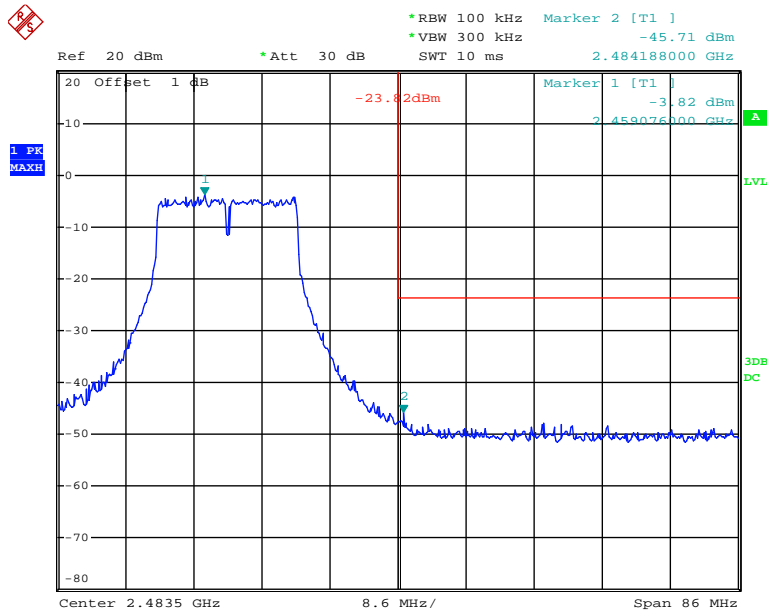

Date: 5.MAY.2018 11:48:20

802.11n ht40 Band Edge, Left Side

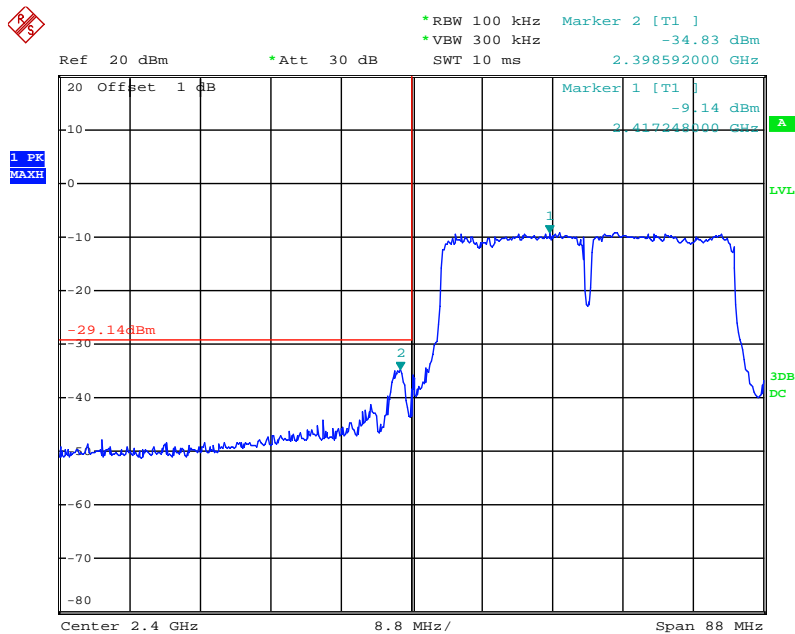

Date: 5.MAY.2018 11:52:48

802.11n ht40 Band Edge, Right Side

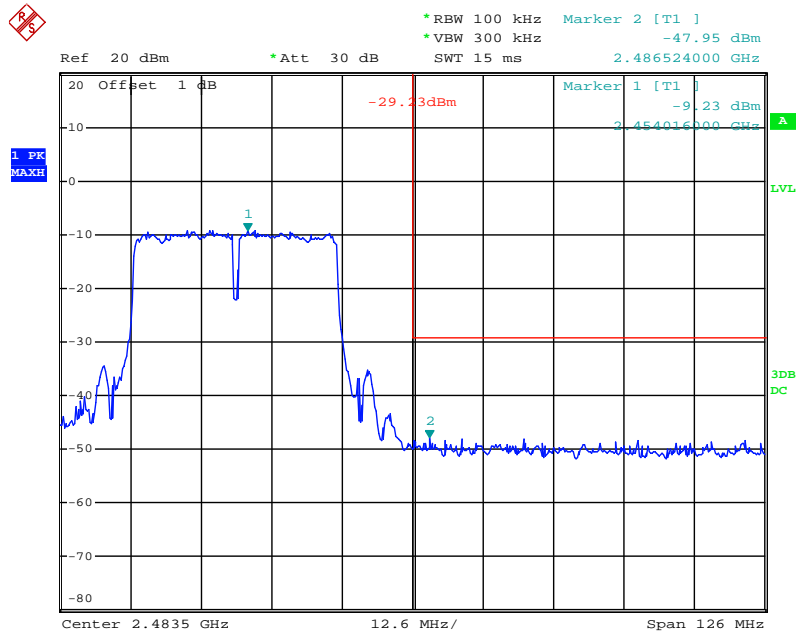

Date: 5.MAY.2018 11:57:12

FCC §15.247(e) - POWER SPECTRAL DENSITY

Applicable Standard

For digitally modulated systems, the power spectral density conducted from the intentional radiator to the antenna shall not be greater than 8 dBm in any 3 kHz band during any time interval of continuous transmission. This power spectral density shall be determined in accordance with the provisions of paragraph (b) of this section. The same method of determining the conducted output power shall be used to determine the power spectral density.

Test Procedure

1. Check the calibration of the measuring instrument using either an internal calibrator or a known signal from an external generator.
2. Position the EUT was set without connection to measurement instrument. Turn on the EUT and connect its antenna terminal to measurement instrument via a low loss cable. Then set it to any one measured frequency within its operating range, and make sure the instrument is operated in its linear range.
3. Set the RBW = 3 kHz, VBW = 10 kHz, Set the span to 1.5 times the DTS bandwidth.
4. Use the peak marker function to determine the maximum amplitude level.

Test Equipment List and Details

Manufacturer	Description	Model	Serial Number	Calibration Date	Calibration Due Date
R&S	Spectrum Analyzer	FSU 26	200256	2018-01-04	2019-01-04
Unknown	Coaxial Cable	C-SJ00-0010	C0010/01	Each Time	/

* **Statement of Traceability:** Bay Area Compliance Laboratories Corp. (Dongguan) attests that all calibrations have been performed, traceable to National Primary Standards and International System of Units (SI).

Test Data

Environmental Conditions

Temperature:	24.2~26.9 °C
Relative Humidity:	51~64 %
ATM Pressure:	100.9~101 kPa

* The testing was performed by Andy Huang on 2018-04-28 and 2018-05-05.

Test Result: Compliance

Test Mode: Transmitting

Test Result: Compliant. Please refer to the following table and plots

Test mode	Channel	Frequency (MHz)	PSD (dBm/3kHz)	Limit (dBm/3kHz)
802.11b	Low	2412	-14.62	≤8
	Middle	2437	-14.43	≤8
	High	2462	-14.25	≤8
802.11g	Low	2412	-18.17	≤8
	Middle	2437	-17.30	≤8
	High	2462	-17.58	≤8
802.11n ht20	Low	2412	-18.46	≤8
	Middle	2437	-17.11	≤8
	High	2462	-18.08	≤8
802.11n ht40	Low	2422	-21.75	≤8
	Middle	2437	-20.61	≤8
	High	2452	-20.47	≤8

Power Spectral Density, 802.11b Low Channel

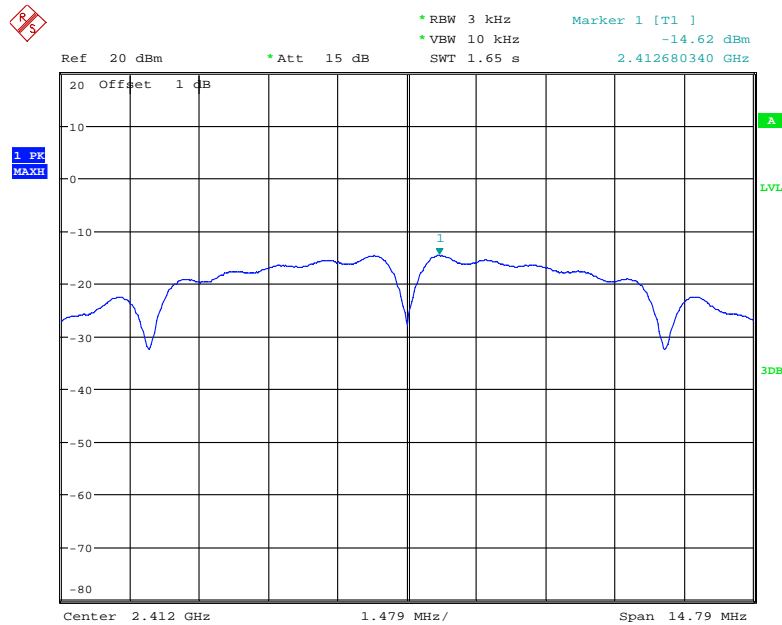

Date: 28.APR.2018 20:31:50

Power Spectral Density, 802.11b Middle Channel

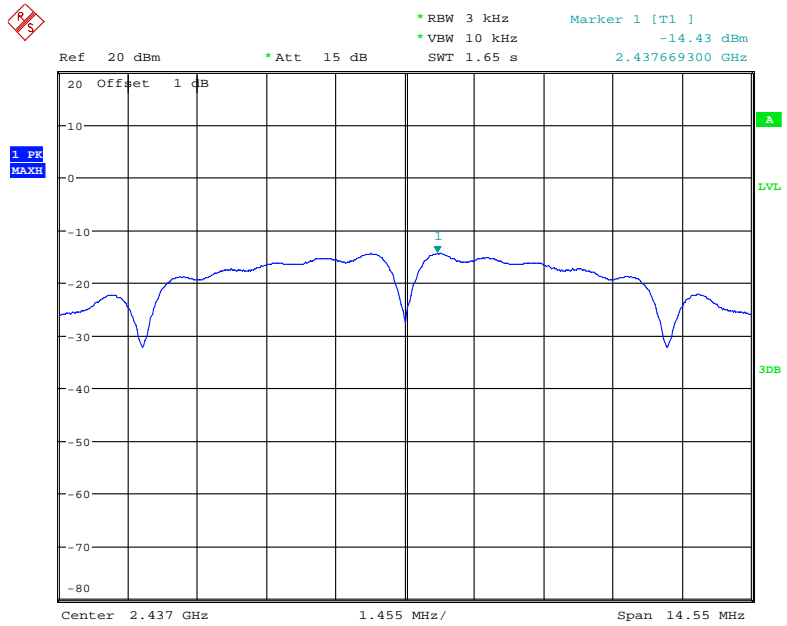

Date: 28.APR.2018 20:42:12

Power Spectral Density, 802.11b High Channel

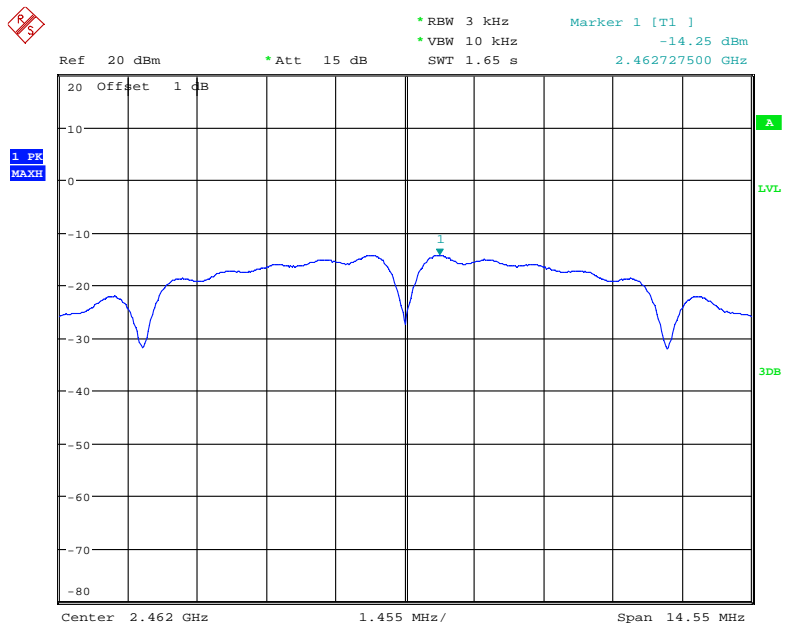

Date: 28.APR.2018 20:44:01

Power Spectral Density, 802.11g Low Channel

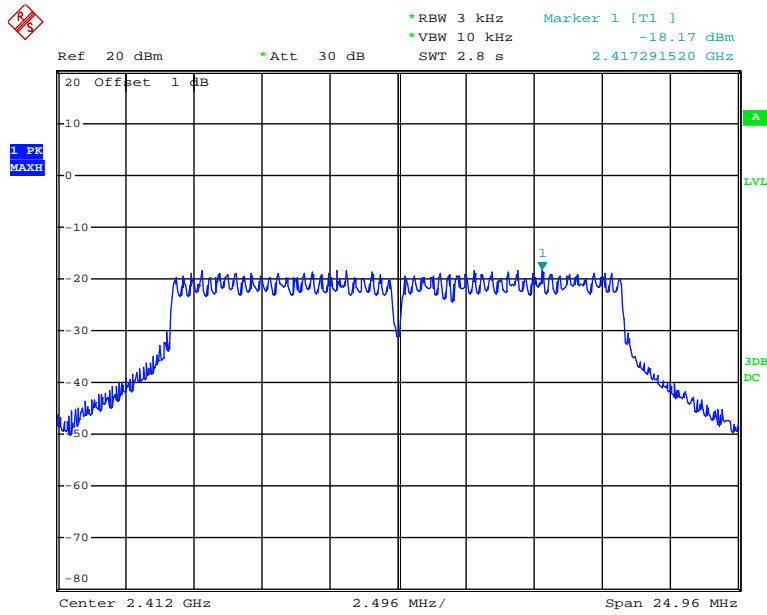

Date: 5.MAY.2018 11:43:39

Power Spectral Density, 802.11g Middle Channel

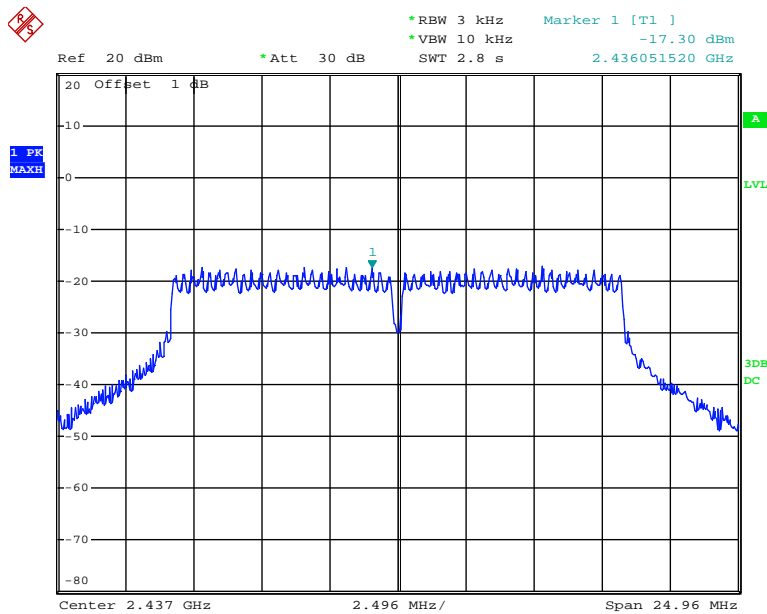

Date: 5.MAY.2018 11:45:10

Power Spectral Density, 802.11g High Channel

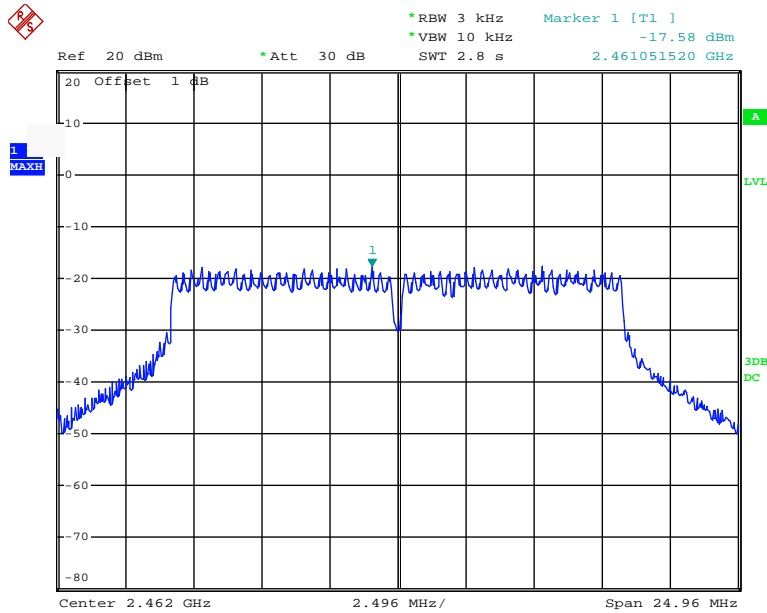

Date: 5.MAY.2018 11:46:22

Power Spectral Density, 802.11n ht20 Low Channel

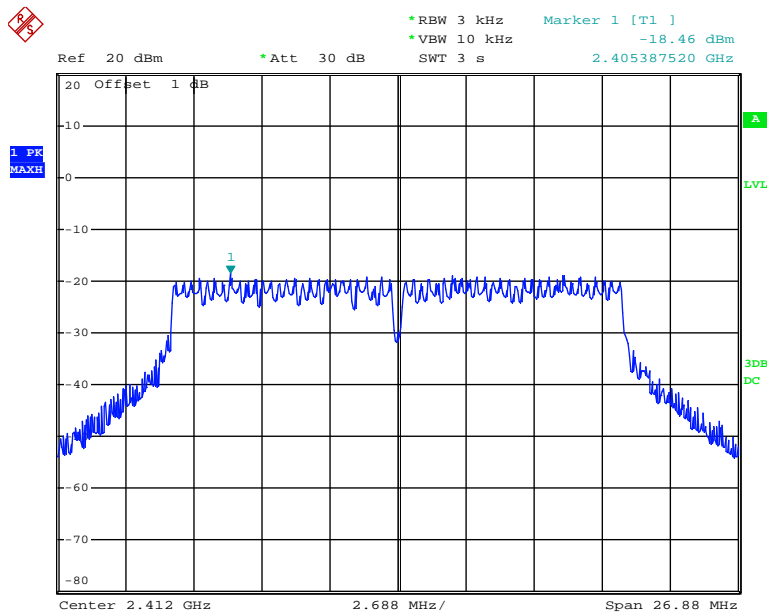

Date: 5.MAY.2018 11:50:45

Power Spectral Density, 802.11n ht20 Middle Channel

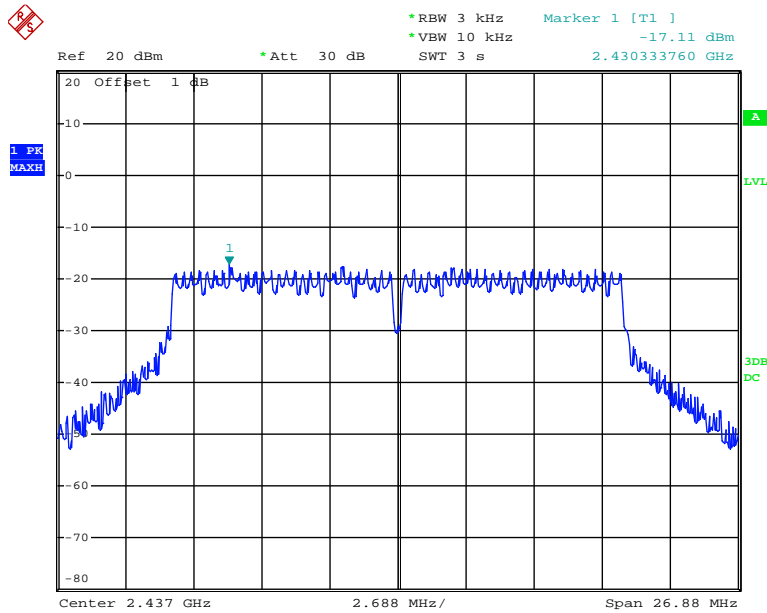

Date: 5.MAY.2018 11:49:38

Power Spectral Density, 802.11n ht20 High Channel

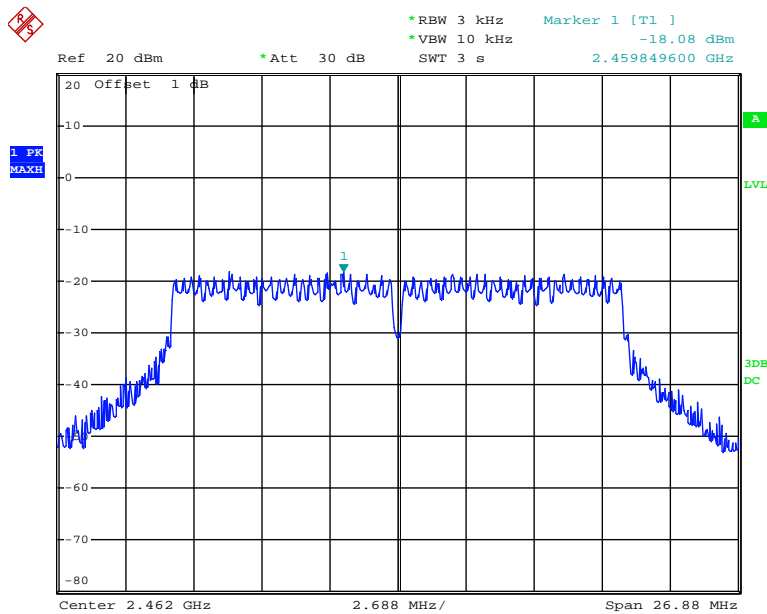

Date: 5.MAY.2018 11:48:01

Power Spectral Density, 802.11n ht40 Low Channel

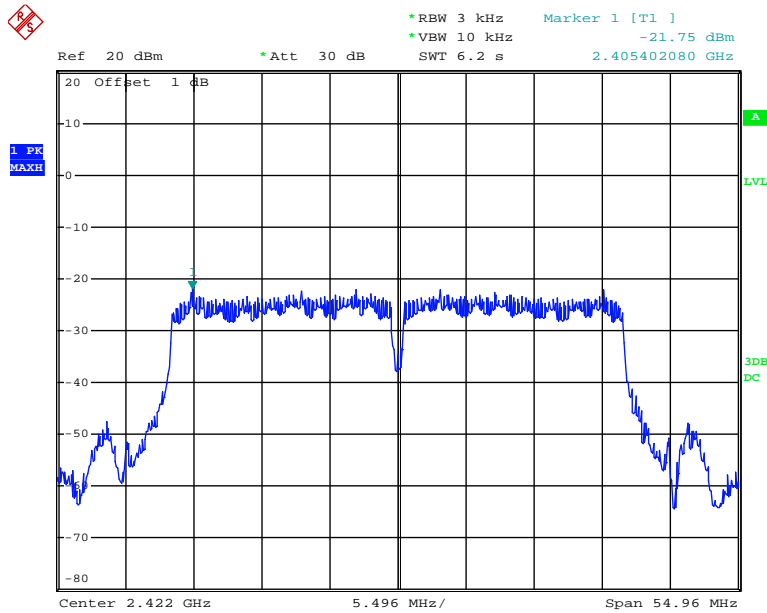

Date: 5.MAY.2018 11:52:22

Power Spectral Density, 802.11n ht40 Middle Channel

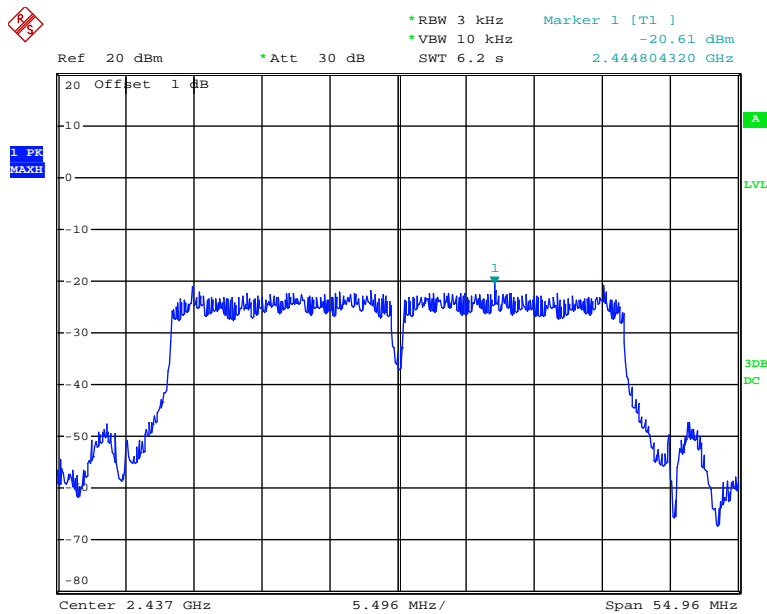

Date: 5.MAY.2018 11:55:14

Power Spectral Density, 802.11n ht40 High Channel

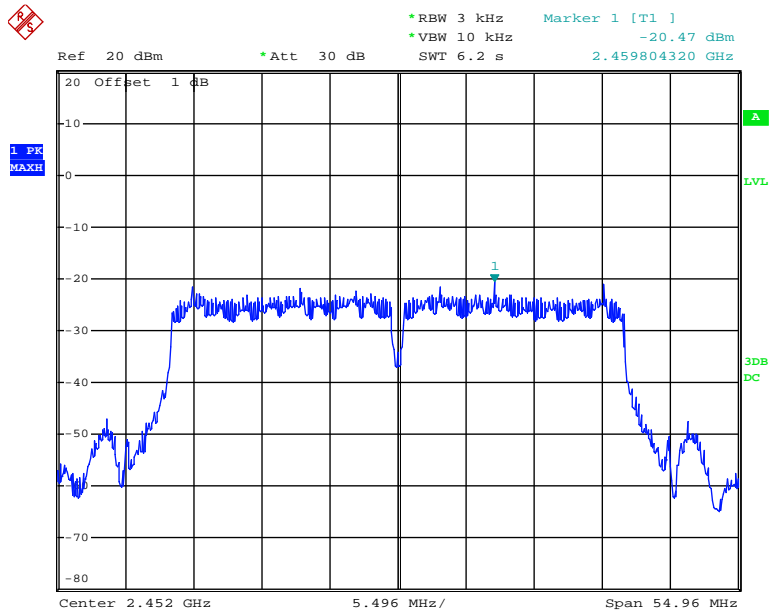

Date: 5.MAY.2018 11:56:54

***** END OF REPORT *****