



FCC RADIO TEST REPORT

FCC ID: 2AD66-RF2401PRO

Product : 2.4G RF module with nRF2401+

Trade Name : G-NiceRF

Model Name : RF2401Pro

Serial Model : N/A

Report No. : NTEK-2016NT07277878F

Prepared for

NiceRF Wireless Technology LTD.

4th floor of DuoTai Building, Anle Industrial Zone, Area 43, Baoan Dist,
Shenzhen, China

Prepared by

Shenzhen NTEK Testing Technology Co., Ltd.

1/F, Building E, Fenda Science Park, Sanwei Community, Xixiang Street
Bao'an District, Shenzhen P.R. China

Tel.: +86-0755-61156588 Fax.: +86-0755-61156599

Website: www.ntek.org.cn

TEST RESULT CERTIFICATION

Applicant's name : NiceRF Wireless Technology LTD.
Address : 4th floor of DuoTai Building, Anle Industrial Zone, Area 43, Baoan Dist, Shenzhen, China
Manufacture's Name..... : NiceRF Wireless Technology LTD.
Address : 4th floor of DuoTai Building, Anle Industrial Zone, Area 43, Baoan Dist, Shenzhen, China

Product description

Product name : 2.4G RF module with nRF2401+
Model and/or type reference : RF2401Pro
Serial Model : N/A
Rating(s) : DC 3.3V

Standards : FCC Part15.249 01 Oct. 2015

Test procedure ANSI C63.10-2013

This device described above has been tested by NTEK, and the test results show that the equipment under test (EUT) is in compliance with the FCC requirements. And it is applicable only to the tested sample identified in the report.

This report shall not be reproduced except in full, without the written approval of NTEK, this document may be altered or revised by NTEK, personnel only, and shall be noted in the revision of the document.

Date of Test :
Date (s) of performance of tests : 27Jul. 2016 ~15 Aug. 2016
Date of Issue..... : 15 Aug. 2016
Test Result..... : **Pass**

Testing Engineer : Eileen Liu.
(Eileen Liu)

Technical Manager : Jason chen
(Jason Chen)

Authorized Signatory : Sam. chen
(Sam Chen)

Table of Contents	Page
1 . SUMMARY OF TEST RESULTS	4
1.1 TEST FACILITY	5
1.2 MEASUREMENT UNCERTAINTY	5
2 . GENERAL INFORMATION	6
2.1 GENERAL DESCRIPTION OF EUT	6
2.2 DESCRIPTION OF TEST MODES	8
2.3 BLOCK DIGRAM SHOWING THE CONFIGURATION OF SYSTEM TESTED	9
2.4 DESCRIPTION OF SUPPORT UNITS(CONDUCTED MODE)	10
3 . ANTENNA REQUIREMENT	12
3.1 STANDARD REQUIREMENT	12
3.2 EUT ANTENNA	12
3.3 CONDUCTED EMISSION MEASUREMENT	13
3.3.1 POWER LINE CONDUCTED EMISSION LIMITS	13
3.3.2 TEST PROCEDURE	14
3.3.3 DEVIATION FROM TEST STANDARD	14
3.3.4 TEST SETUP	14
3.2.5 TEST RESULT	15
3.4 RADIATED EMISSION MEASUREMENT	16
3.4.1 RADIATED EMISSION LIMITS	16
3.4.2 TEST PROCEDURE	17
3.4.3 DEVIATION FROM TEST STANDARD	17
3.4.4 TEST SETUP	18
3.4.5 TEST RESULTS (BLOW 30MHZ)	20
3.4.6 TEST RESULTS (BETWEEN 30 – 1000 MHZ)	21
3.4.7 TEST RESULTS (ABOVE 1000 MHZ)	23
3.4.8 TEST RESULTS (RESTRICTED BANDS REQUIREMENTS)	35
4 . BANDWIDTH TEST	47
4.1 TEST PROCEDURE	47
4.2 DEVIATION FROM STANDARD	47
4.3 TEST SETUP	47
4.4 TEST RESULTS	48
5 . EUT TEST PHOTO	54
APPENDIX-PHOTOGRAPHS OF EUT CONSTRUCTIONAL DETAILS	

1. SUMMARY OF TEST RESULTS

Test procedures according to the technical standards:

FCC Part15, Subpart C (15.249)			
Standard Section	Test Item	Judgment	Remark
15.207	Conducted Emission	N/A	
15.203	Antenna Requirement	Pass	
15.249	Radiated Spurious Emission	Pass	
15.205	Band Edge Emission	Pass	
15.249	Occupied Bandwidth	Pass	

1.1 TEST FACILITY

Shenzhen NTEK Testing Technology Co., Ltd
 Add. : 1/F, Building E, Fenda Science Park, Sanwei Community, Xixiang Street, Bao'an District, Shenzhen P.R. China.
 FCC FRN Registration No.:238937; IC Registration No.:9270A-1
 CNAS Registration No.:L5516

1.2 MEASUREMENT UNCERTAINTY

The reported uncertainty of measurement $y \pm U$, where expanded uncertainty U is based on a standard uncertainty multiplied by a coverage factor of $k=2$, providing a level of confidence of approximately **95 %**.

No.	Item	Uncertainty
1	Conducted Emission Test	$\pm 1.38\text{dB}$
2	RF power,conducted	$\pm 0.16\text{dB}$
3	Spurious emissions,conducted	$\pm 0.21\text{dB}$
4	All emissions,radiated(<1G)	$\pm 4.68\text{dB}$
5	All emissions,radiated(>1G)	$\pm 4.89\text{dB}$
6	Temperature	$\pm 0.5^\circ\text{C}$
7	Humidity	$\pm 2\%$

2. GENERAL INFORMATION

2.1 GENERAL DESCRIPTION OF EUT

Equipment	2.4G RF module with nRF2401+	
Trade Name	G-NiceRF	
Model Name	RF2401Pro	
Serial Model	N/A	
Model Difference	N/A	
Product Description	The EUT is a 2.4G RF module with nRF2401+	
	Operation Frequency:	2402 MHz -2482MHz
	Modulation Type:	GFSK
	Antenna Designation:	PCB antenna
	Antenna Gain(Peak)	2.15 dBi
Based on the application, features, or specification exhibited in User's Manual, the EUT is considered as an ITE/Computing Device. More details of EUT technical specification, please refer to the User's Manual.		
Channel List	Please refer to the Note 2.	
Adapter	N/A	
Battery	DC 3.3V	

Note:

1. For a more detailed features description, please refer to the manufacturer's specifications or the User's Manual.

2.

Channel	Frequency (MHz)	Channel	Frequency (MHz)
00	2402	01	2403
02	2404	03	2405
.....
.....
.....
.....
77	2479	78	2481
79	2480	80	2482

3.

Table for Filed Antenna

Ant	Brand	Model Name	Antenna Type	Connector	Gain (dBi)	NOTE
1	N/A	N/A	PCB Antenna	N/A	2.15	Antenna

2.2 DESCRIPTION OF TEST MODES

To investigate the maximum EMI emission characteristics generates from EUT, the test system was pre-scanning tested base on the consideration of following EUT operation mode or test configuration mode which possible have effect on EMI emission level. Each of these EUT operation mode(s) or test configuration mode(s) mentioned above was evaluated respectively.

Pretest Mode	Description
Mode 1	TX-CH 00(250k bps,1M bps,2M bps)
Mode 2	TX-CH 80(250k bps,1M bps,2M bps)
Mode 3	Link mode

For Radiated Emission	
Final Test Mode	Description
Mode 1	TX-CH 00(250k bps,1M bps,2M bps)
Mode 2	TX-CH 80(250k bps,1M bps,2M bps)
Mode 3	Link mode

For Conducted Emission	
Final Test Mode	Description
Mode 1	TX-CH 00(250k bps,1M bps,2M bps)
Mode 2	TX-CH 80(250k bps,1M bps,2M bps)

Note:

(1) The measurements are performed at the highest, lowest channels.

2.3 BLOCK DIGRAM SHOWING THE CONFIGURATION OF SYSTEM TESTED

Radiated Spurious Emission Test

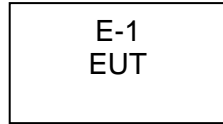

2.4 DESCRIPTION OF SUPPORT UNITS(CONDUCTED MODE)

The EUT has been tested as an independent unit together with other necessary accessories or support units. The following support units or accessories were used to form a representative test configuration during the tests.

Item	Equipment	Mfr/Brand	Model/Type No.	Series No.	Note
E-1	2.4G RF module with nRF2401+	G-NiceRF	RF2401Pro	N/A	EUT

Item	Shielded Type	Ferrite Core	Length	Note

Note:

- (1) The support equipment was authorized by Declaration of Confirmation.
- (2) For detachable type I/O cable should be specified the length in cm in 『Length』 column.

2.4.1 EQUIPMENTS LIST FOR ALL TEST ITEMS

Radiation Test equipment

Item	Kind of Equipment	Manufacturer	Type No.	Serial No.	Calibrated until
1	Spectrum Analyzer	Agilent	E4407B	160400005	Jul. 06. 2017
2	Test Receiver	R&S	ESPI	101318	Jul. 06. 2017
3	Bilog Antenna	TESEQ	CBL6111D	31216	Jul. 06. 2017
4	50Ω Coaxial Switch	Anritsu	MP59B	6200264416	Jul. 06. 2017
5	Spectrum Analyzer	ADVANTEST	R3132	150900201	Jul. 06. 2017
6	Horn Antenna	EM	EM-AH-10180	2011071402	Jul. 06. 2017
7	Horn Ant	Schwarzbeck	BBHA 9170	9170-181	Jul. 06. 2017
8	Amplifier	EM	EM-30180	060538	Jul. 06. 2017
9	Loop Antenna	ARA	PLA-1030/B	1029	Jul. 06. 2017
10	Power Meter	R&S	NRVS	100696	Jul. 06. 2017

Conduction Test equipment

Item	Kind of Equipment	Manufacturer	Type No.	Serial No.	Calibrated until
1	Test Receiver	R&S	ESCI	101160	Jul. 06. 2017
2	LISN	R&S	ENV216	101313	Jul. 06. 2017
3	LISN	EMCO	3816/2	00042990	Jul. 06. 2017
4	50Ω Coaxial Switch	Anritsu	MP59B	6200264417	Jul. 06. 2017
5	Passive Voltage Probe	R&S	ESH2-Z3	100196	Jul. 06. 2017
6	Absorbing clamp	R&S	MOS-21	100423	Jul. 06. 2017

3. ANTENNA REQUIREMENT

3.1 STANDARD REQUIREMENT

15.203 requirement: For intentional device, according to 15.203: an intentional radiator shall be designed to ensure that no antenna other than that furnished by the responsible party shall be used with the device.

3.2 EUT ANTENNA

The EUT antenna is non-standard PCB antenna connector, details to see internal photo, It comply with the standard requirement.

3.3 CONDUCTED EMISSION MEASUREMENT

3.3.1 POWER LINE CONDUCTED EMISSION Limits (Frequency Range 150KHz-30MHz)

FREQUENCY (MHz)	Class A (dBuV)		Class B (dBuV)		Standard
	Quasi-peak	Average	Quasi-peak	Average	
0.15 -0.5			66 - 56 *	56 - 46 *	CISPR
0.50 -5.0			56.00	46.00	CISPR
5.0 -30.0			60.00	50.00	CISPR

0.15 -0.5			66 - 56 *	56 - 46 *	LP002.
0.50 -5.0			56.00	46.00	LP002.
5.0 -30.0			60.00	50.00	LP002.

Note:

- (1) The tighter limit applies at the band edges.
- (2) The limit of " * " marked band means the limitation decreases linearly with the logarithm of the frequency in the range.

The following table is the setting of the receiver

Receiver Parameters	Setting
Attenuation	10 dB
Start Frequency	0.15 MHz
Stop Frequency	30 MHz
IF Bandwidth	9 kHz

3.3.2 TEST PROCEDURE

- a. The EUT was placed 0.4 meters from the horizontal ground plane with EUT being connected to the power mains through a line impedance stabilization network (LISN). All other support equipments powered from additional LISN(s). The LISN provide 50 Ohm/ 50uH of coupling impedance for the measuring instrument.
- b. Interconnecting cables that hang closer than 40 cm to the ground plane shall be folded back and forth in the center forming a bundle 30 to 40 cm long.
- c. I/O cables that are not connected to a peripheral shall be bundled in the center. The end of the cable may be terminated, if required, using the correct terminating impedance. The overall length shall not exceed 1 m.
- d. LISN at least 80 cm from nearest part of EUT chassis.
- e. For the actual test configuration, please refer to the related Item –EUT Test Photos.

3.3.3 DEVIATION FROM TEST STANDARD

No deviation

3.3.4 TEST SETUP

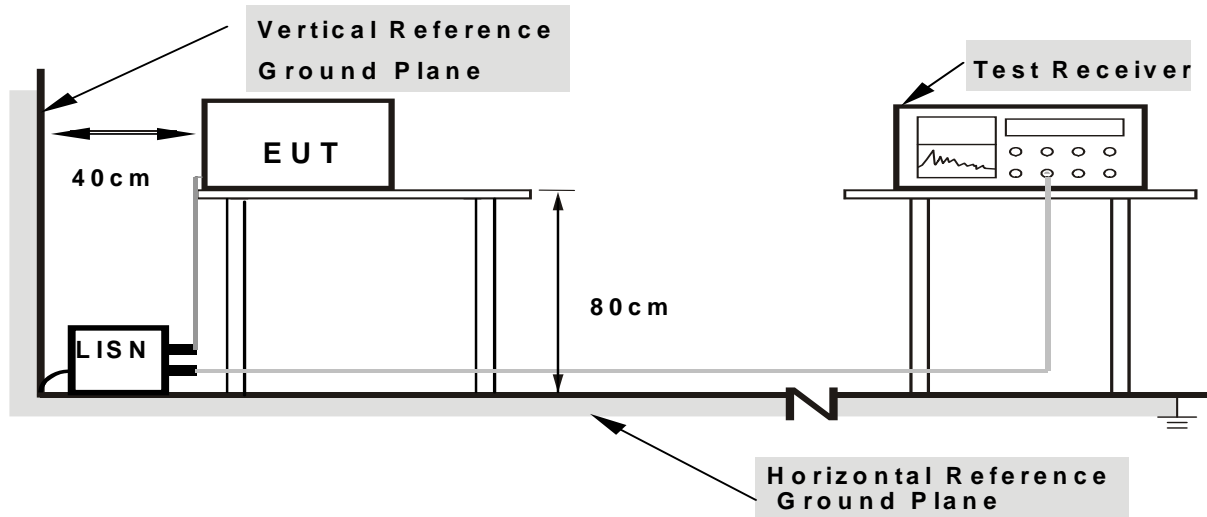

Note: 1. Support units were connected to second LISN.

2. Both of LISNs (AMN) are 80 cm from EUT and at least 80 cm from other units and other metal planes

3.2.5 TEST RESULT

EUT :	2.4G RF module with nRF2401+	Model Name. :	RF2401Pro
Temperature :	26 °C	Relative Humidity :	54%
Pressure :	1010hPa	Phase :	N/A
Test Voltage :	N/A	Test Mode :	N/A

3.4 RADIATED EMISSION MEASUREMENT

3.4.1 Radiated Emission Limits (FCC 15.209)

Frequencies (MHz)	Field Strength (micorvolts/meter)	Measurement Distance (meters)
0.009~0.490	2400/F(KHz)	300
0.490~1.705	24000/F(KHz)	30
1.705~30.0	30	30
Frequency (MHz)	Limit (dBuV)	
30~88	40	3
88~216	43.5	3
216~960	46	3
960 -10000	54.00	3
*902 - 928	94.00	3

Note:

- (1) The tighter limit applies at the band edges.
- (2) Emission level (dBuV/m)=20log Emission level (uV/m).
- (3) *Note: This is the limit for the fundamental frequency.

LIMITS OF RADIATED EMISSION MEASUREMENT (FCC 15.249)

Frequency of Emission (MHz)	Field Strength of fundamental ((millivolts /meter)	Field Strength of Harmonics (microvolts/meter)
2400-2483.5	50	500

Notes:

- (1) Emissions radiated outside of the specified frequency bands, except for harmonics, shall be attenuated by at least 50 dB below the level of the fundamental or to the general radiated emission limits in Section 15.209, whichever is the lesser attenuation.

Spectrum Parameter	Setting
Attenuation	Auto
Start Frequency	1000 MHz
Stop Frequency	10th carrier harmonic
RB / VB (emission in restricted band)	1MHz / 1MHz for Peak

Receiver Parameter	Setting
Attenuation	Auto
Start ~ Stop Frequency	9kHz~150kHz / RB 200Hz for QP
Start ~ Stop Frequency	150kHz~30MHz / RB 9kHz for QP
Start ~ Stop Frequency	30MHz~1000MHz / RB 120kHz for QP

3.4.2 TEST PROCEDURE

- a. The measuring distance of at 3 m shall be used for measurements at frequency up to 1GHz. For frequencies above 1GHz, any suitable measuring distance may be used.
- b. The EUT was placed on the top of a rotating table 0.8 m for below 1GHz and 1.5m for above 1GHz the ground at a 3 meter open area test site. The table was rotated 360 degrees to determine the position of the highest radiation.
- c. The height of the equipment or of the substitution antenna shall be 0.8 m for below 1GHz and 1.5m for above 1GHz; the height of the test antenna shall vary between 1 m to 4 m. Both horizontal and vertical polarizations of the antenna are set to make the measurement.
- d. The initial step in collecting conducted emission data is a spectrum analyzer peak detector mode pre-scanning the measurement frequency range. Significant peaks are then marked and then Quasi Peak detector mode re-measured.
- e. If the Peak Mode measured value compliance with and lower than Quasi Peak Mode Limit, the EUT shall be deemed to meet QP Limits and then no additional QP Mode measurement performed.
- f. For the actual test configuration, please refer to the related Item –EUT Test Photos.

Note:

Both horizontal and vertical antenna polarities were tested and performed pretest to three orthogonal axis. The worst case emissions were reported

During the radiated emission test, the Spectrum Analyzer was set with the following configurations:

Frequency Band (MHz)	Function	Resolution bandwidth	Video Bandwidth
30 to 1000	Peak	100 kHz	100 kHz
Above 1000	Peak	1 MHz	1 MHz
	Average	1 MHz	10 Hz

3.4.3 DEVIATION FROM TEST STANDARD

No deviation

3.4.4 TEST SETUP

(A) Radiated Emission Test-Up Frequency Below 30MHz

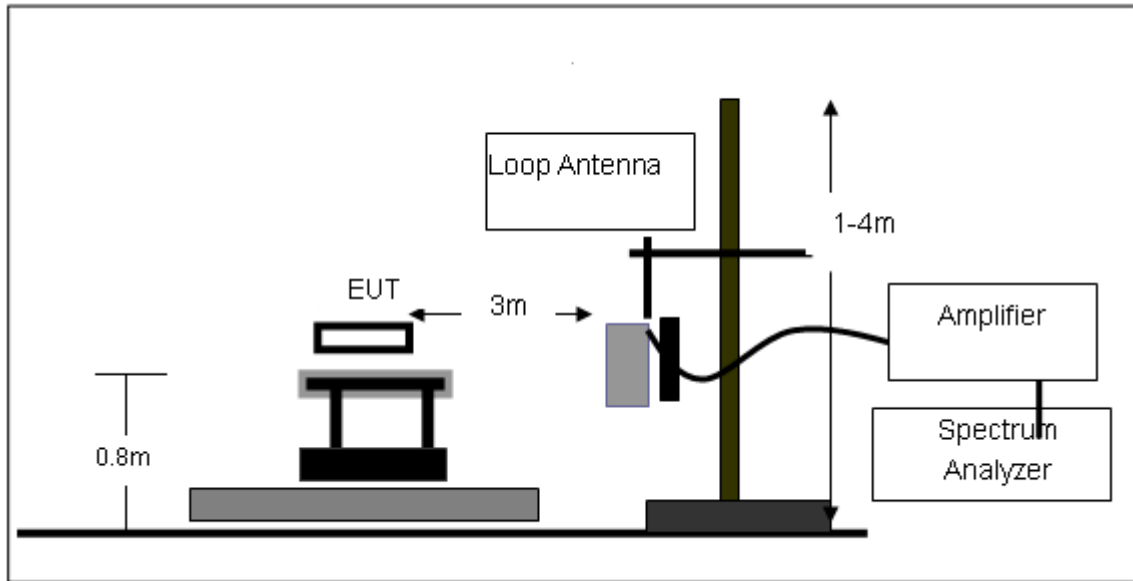

(B) Radiated Emission Test-Up Frequency 30MHz~1GHz

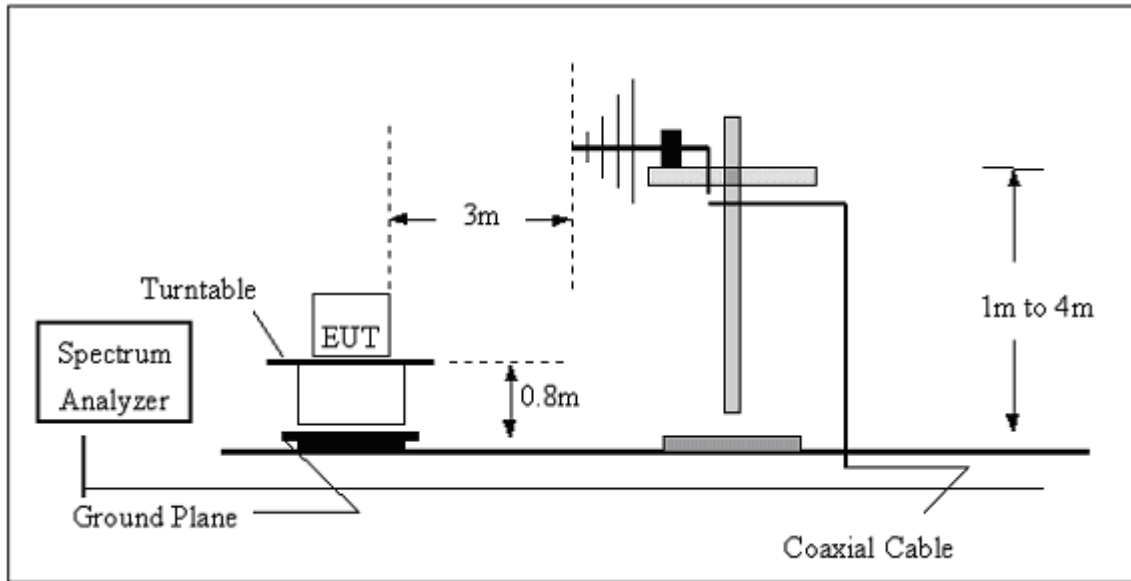

(C) Radiated Emission Test-Up Frequency Above 1GHz

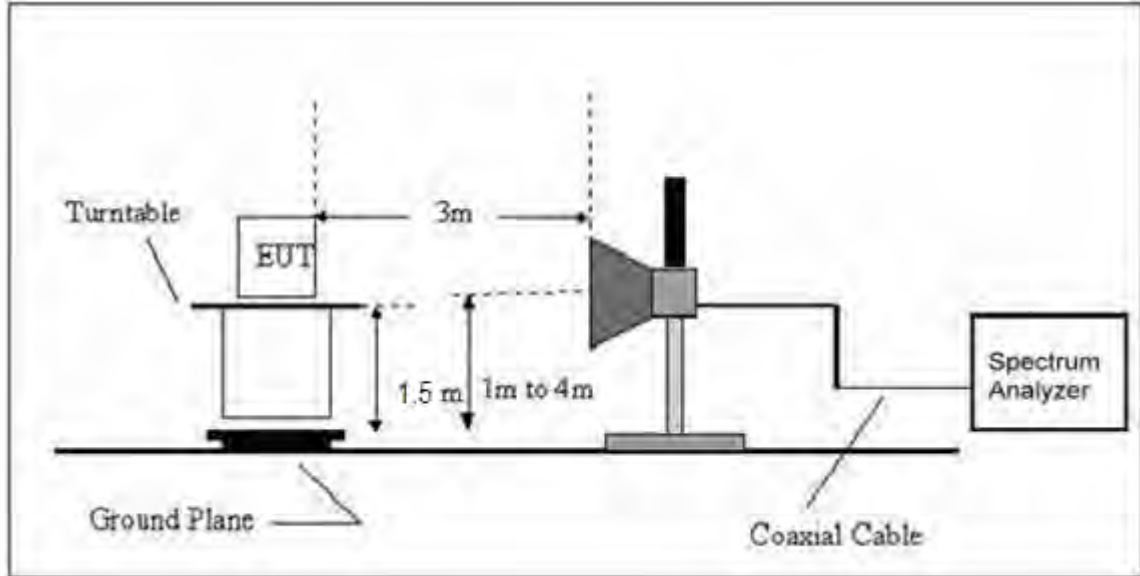

3.4.5 TEST RESULTS (BLOW 30MHz)

EUT :	2.4G RF module with nRF2401+	Model Name. :	RF2401Pro
Temperature :	20 °C	Relative Humidity :	48%
Pressure :	1010 hPa	Test Voltage :	DC 3.3V
Test Mode :	TX	Polarization :	--

Freq.	Reading	Limit	Margin	State
(MHz)	(dBuV/m)	(dBuV/m)	(dB)	P/F
--	--	--	--	PASS
--	--	--	--	PASS

NOTE:

The amplitude of spurious emissions which are attenuated by more than 20dB below the permissible value has no need to be reported.

Distance extrapolation factor = $20 \log (\text{specific distance}/\text{test distance})(\text{dB})$;

Limit line = specific limits(dBuv) + distance extrapolation factor.

3.4.6 TEST RESULTS (BETWEEN 30 – 1000 MHZ)

EUT :	2.4G RF module with nRF2401+	Model Name :	RF2401Pro
Temperature :	20 °C	Relative Humidity :	48%
Pressure :	1010 hPa	Test Voltage :	DC 3.3V
Test Mode :	Mode 3	Polarization :	Vertical

Frequency (MHz)	Meter Reading (dBµV)	Factor (dB)	Emission Level (dBµV/m)	Limits (dBµV/m)	Margin (dB)	Detector Type
30.3172	6.09	20.12	26.21	40	-13.79	QP
102.0014	5.54	11.28	16.82	43.5	-26.68	QP
151.0665	6.25	12.86	19.11	43.5	-24.39	QP
404.6664	17.17	16.06	33.23	46	-12.77	QP
463.9696	16.65	17.58	34.23	46	-11.77	QP
872.1832	7.21	24.99	32.2	46	-13.8	QP

Remark:

- Factor = Antenna Factor + Cable Loss – Pre-amplifier.

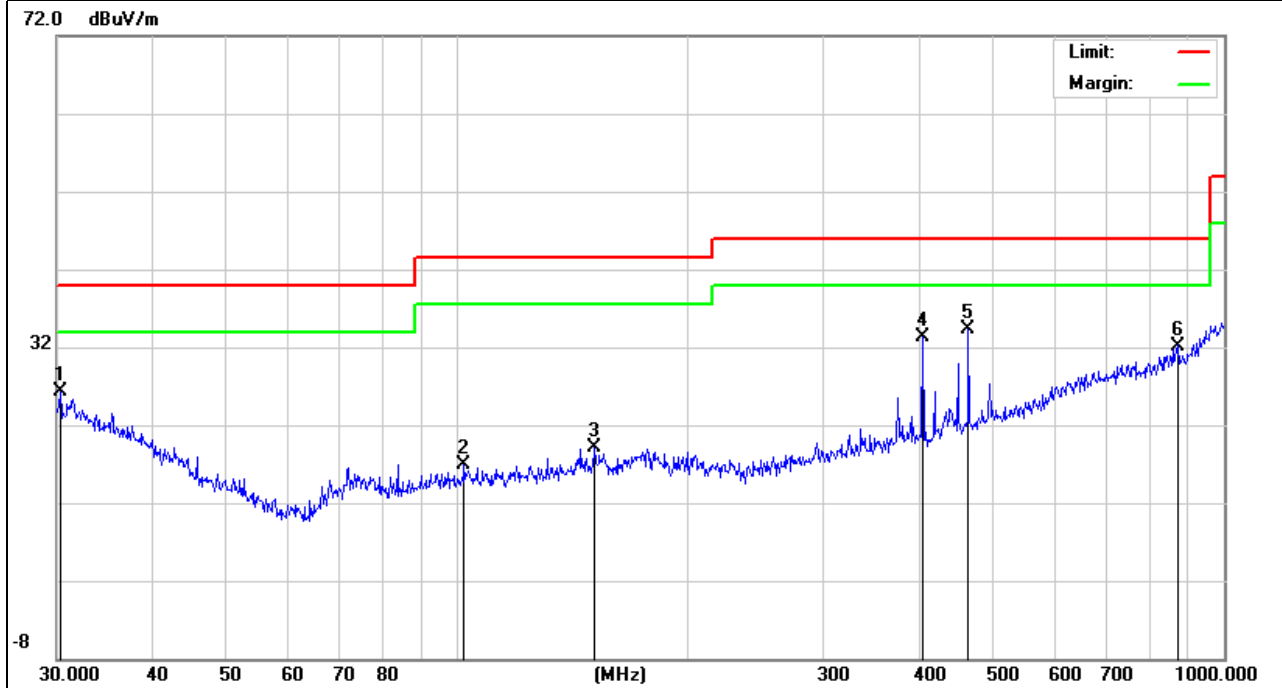

EUT :	2.4G RF module with nRF2401+	Model Name :	RF2401Pro
Temperature :	20 °C	Relative Humidity :	48%
Pressure :	1010 hPa	Test Voltage :	DC 3.3V
Test Mode :	Mode 3	Polarization :	Horizontal

Frequency (MHz)	Meter Reading (dBμV)	Factor (dB)	Emission Level (dBμV/m)	Limits (dBμV/m)	Margin (dB)	Detector Type
30.8535	5.78	19.94	25.72	40	-14.28	QP
36.0007	6.16	17.64	23.8	40	-16.2	QP
374.6225	10.46	16.1	26.56	46	-19.44	QP
403.25	12.33	16.07	28.4	46	-17.6	QP
460.7271	9.1	17.5	26.6	46	-19.4	QP
875.2468	7.85	24.95	32.8	46	-13.2	QP

Remark:

1. Factor = Antenna Factor + Cable Loss – Pre-amplifier.

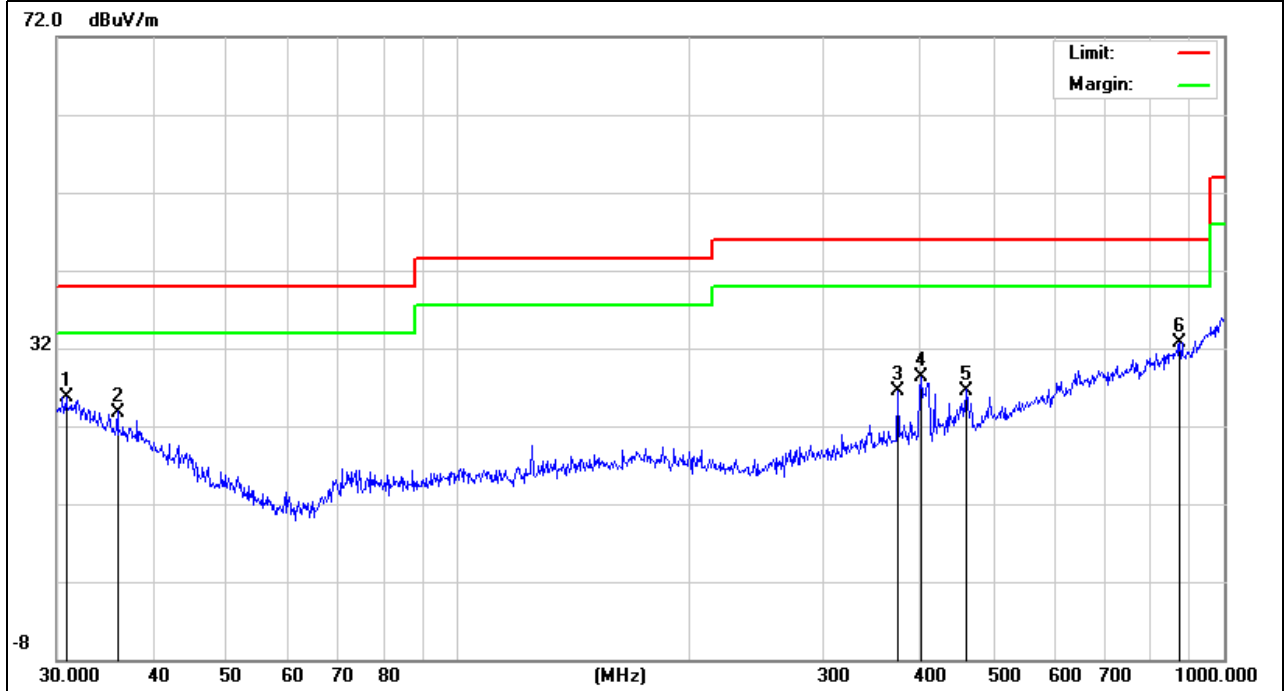

3.4.7 TEST RESULTS (ABOVE 1000 MHZ)

EUT :	2.4G RF module with nRF2401+	Model Name :	RF2401Pro
Temperature :	20 °C	Relative Humidity :	48%
Pressure :	1010 hPa	Test Voltage :	DC 3.3V
Test Mode :	TX-CH 00(250k bps)	Polarization :	Horizontal

Frequency (MHz)	Meter Reading (dBμV)	Factor (dB)	Emission Level (dBμV/m)	Limits (dBμV/m)	Margin (dB)	Detector Type
2402	93.08	-10.14	82.94	114.0 0	-31.06	peak
2402	84.64	-10.14	74.5	94	-19.5	AVG
4804	51.96	-2.5	49.46	74	-24.54	peak
4804	45.3	-2.5	42.8	54	-11.2	AVG

Remark:
 Factor = Antenna Factor + Cable Loss – Pre-amplifier.
 No emission above 18GHz.

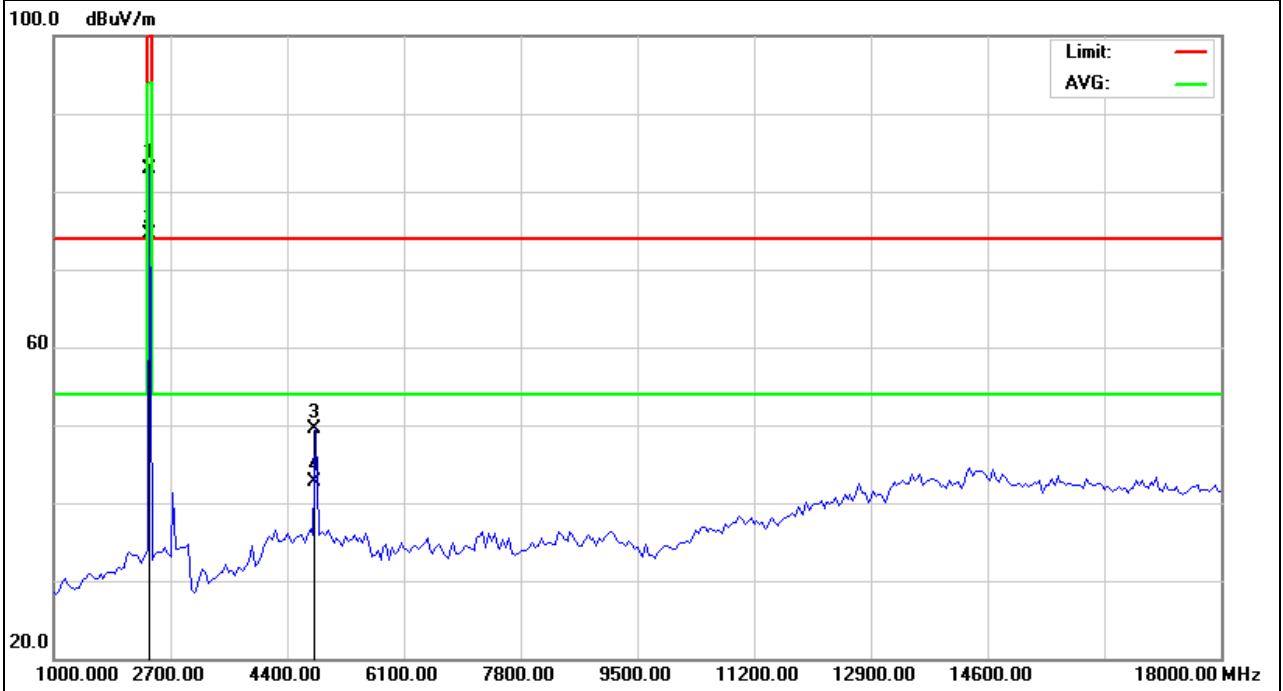

EUT :	2.4G RF module with nRF2401+	Model Name :	RF2401Pro
Temperature :	20 °C	Relative Humidity :	48%
Pressure :	1010 hPa	Test Voltage :	DC 3.3V
Test Mode :	TX-CH 00(250k bps)	Polarization :	Vertical

Frequency (MHz)	Meter Reading (dBμV)	Factor (dB)	Emission Level (dBμV/m)	Limits (dBμV/m)	Margin (dB)	Detector Type
2402	93.08	-10.14	82.94	114.0 0	-31.06	peak
2402	83.74	-10.14	73.6	94	-20.4	AVG
4804	51.96	-2.5	49.46	74	-24.54	peak
4804	44.6	-2.5	42.1	54	-11.9	AVG

Remark:
 Factor = Antenna Factor + Cable Loss – Pre-amplifier.
 No emission above 18GHz.

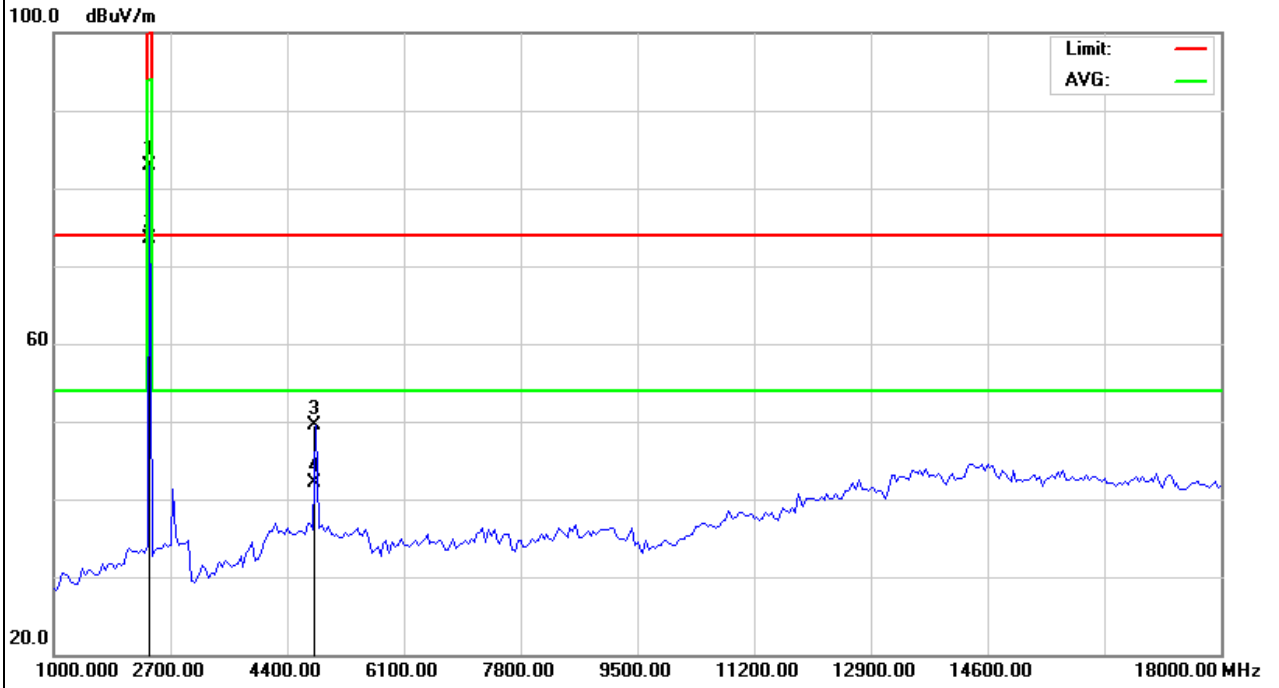

Note: EUT Pre-scan X/Y/Z orientation, only worst case is presented in the report(X orientation).

EUT :	2.4G RF module with nRF2401+	Model Name :	RF2401Pro
Temperature :	20 °C	Relative Humidity :	48%
Pressure :	1010 hPa	Test Voltage :	DC 3.3V
Test Mode :	TX-CH80(250k bps)	Polarization :	Horizontal

Frequency (MHz)	Meter Reading (dBμV)	Factor (dB)	Emission Level (dBμV/m)	Limits (dBμV/m)	Margin (dB)	Detector Type
2482	90.31	-10.44	79.87	114.0 0	-34.13	peak
2482	78.94	-10.44	68.5	94	-25.5	AVG
4964	55.62	-1.88	53.74	74	-20.26	peak
4964	42.48	-1.88	40.6	54	-13.4	AVG

Remark:
 Factor = Antenna Factor + Cable Loss – Pre-amplifier.
 No emission above 18GHz.

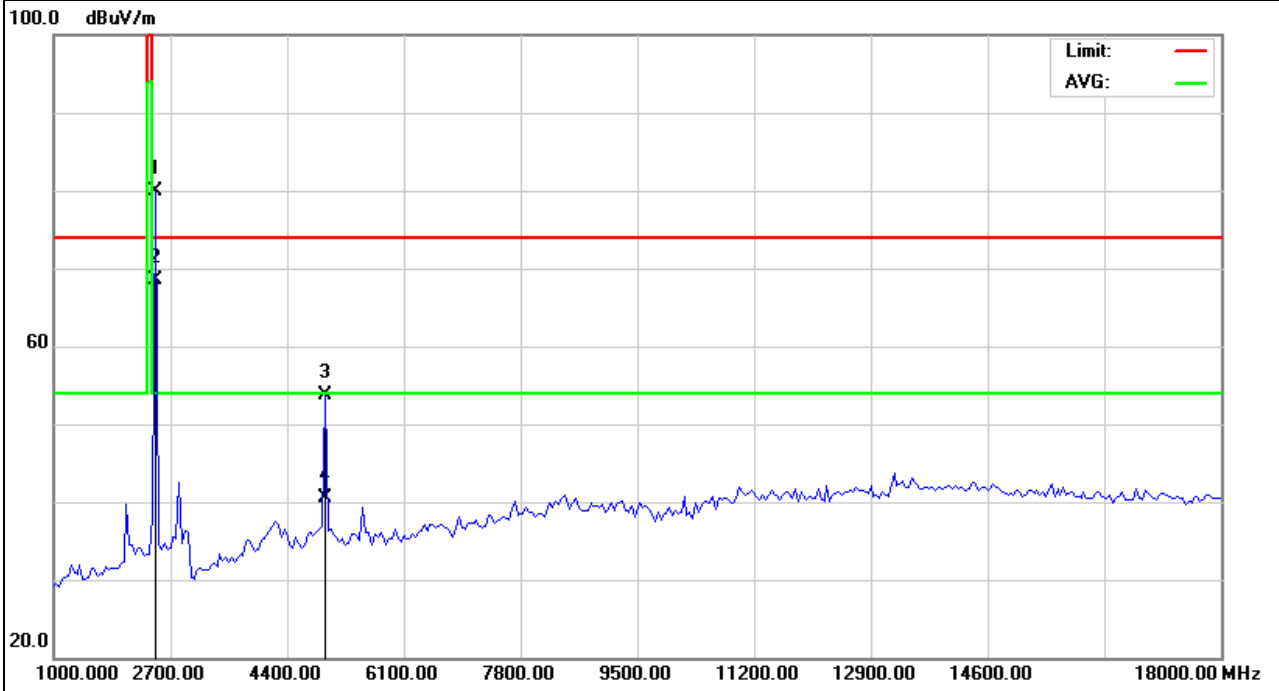

EUT :	2.4G RF module with nRF2401+	Model Name :	RF2401Pro
Temperature :	20 °C	Relative Humidity :	48%
Pressure :	1010 hPa	Test Voltage :	DC 3.3V
Test Mode :	TX-CH80(250k bps)	Polarization :	Vertical

Frequency (MHz)	Meter Reading (dBμV)	Factor (dB)	Emission Level (dBμV/m)	Limits (dBμV/m)	Margin (dB)	Detector Type
2482	91.5	-10.44	81.06	114.0 0	-32.94	peak
2482	79.84	-10.44	69.4	94	-24.6	AVG
4964	56.61	-1.88	54.73	74	-19.27	peak
4964	42.98	-1.88	41.1	54	-12.9	AVG

Remark:
 Factor = Antenna Factor + Cable Loss – Pre-amplifier.
 No emission above 18GHz.

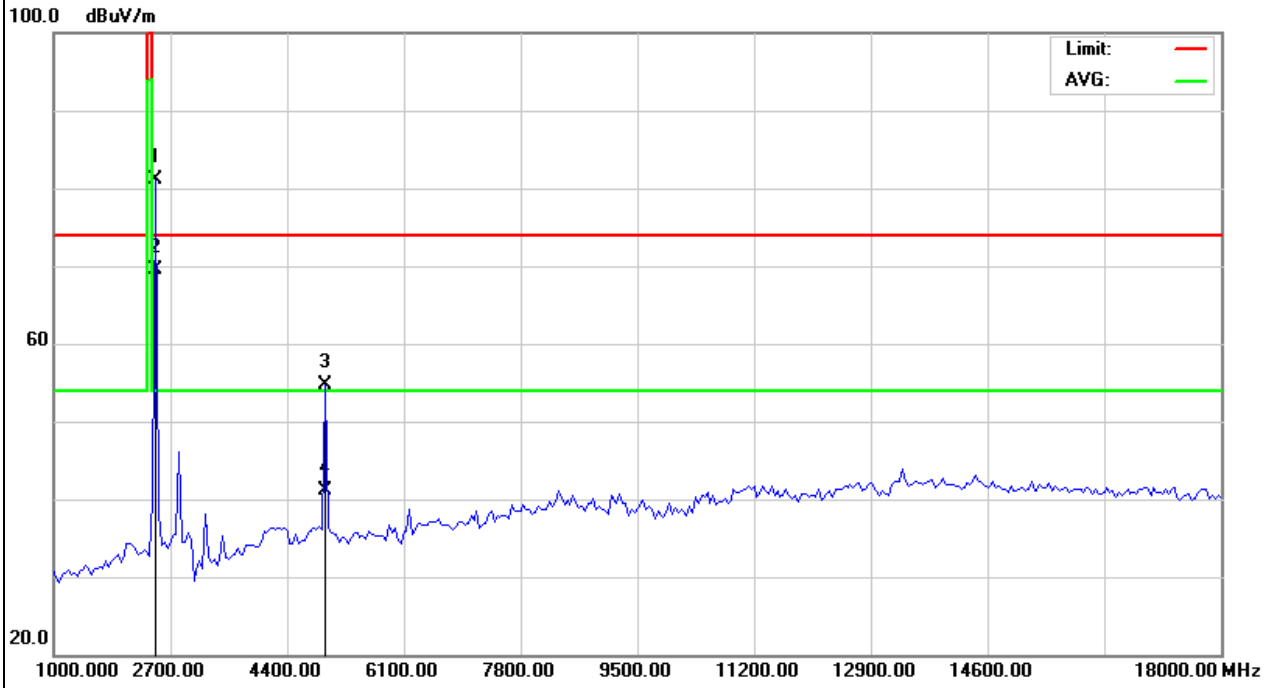

Note: EUT Pre-scan X/Y/Z orientation, only worst case is presented in the report(X orientation).

EUT :	2.4G RF module with nRF2401+	Model Name :	RF2401Pro
Temperature :	20 °C	Relative Humidity :	48%
Pressure :	1010 hPa	Test Voltage :	DC 3.3V
Test Mode :	TX-CH00(1M bps)	Polarization :	Horizontal

Frequency (MHz)	Meter Reading (dBμV)	Factor (dB)	Emission Level (dBμV/m)	Limits (dBμV/m)	Margin (dB)	Detector Type
2402	83.74	-10.14	73.6	114.0 0	-40.4	peak
2402	74.94	-10.14	64.8	94	-29.2	AVG
4804	44.75	-2.5	42.25	74	-31.75	peak
4804	37.1	-2.5	34.6	54	-19.4	AVG

Remark:
 Factor = Antenna Factor + Cable Loss – Pre-amplifier.
 No emission above 18GHz.

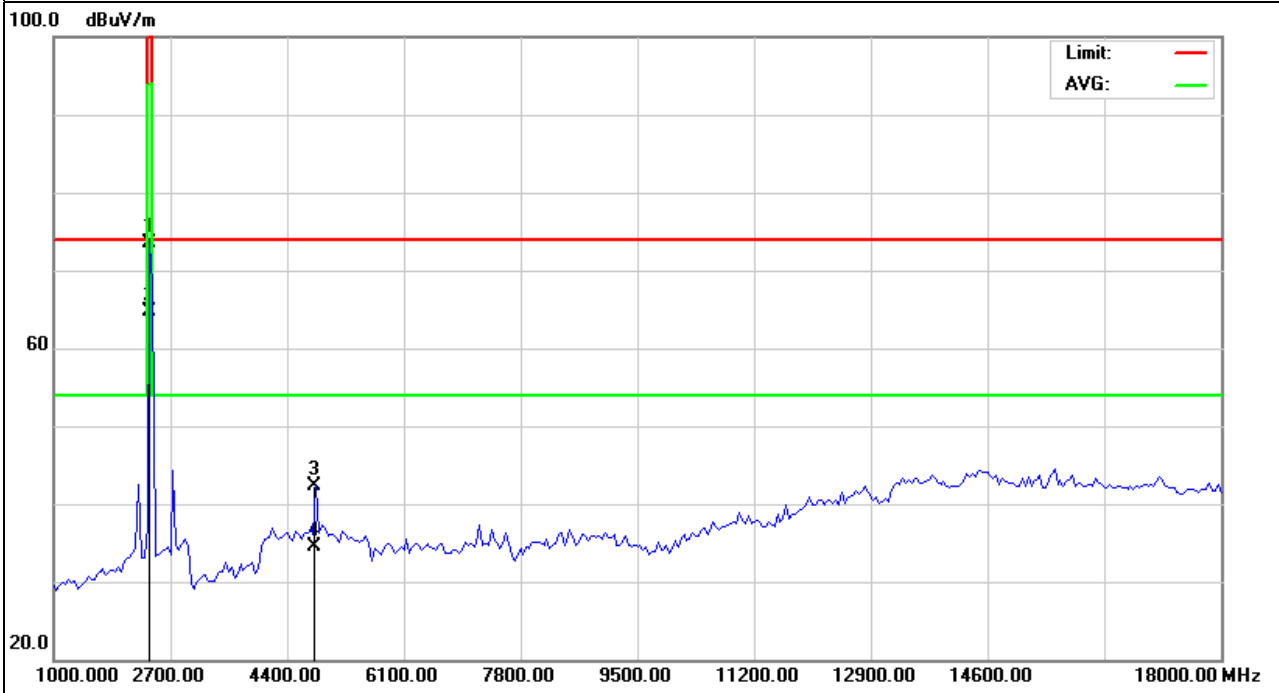

EUT :	2.4G RF module with nRF2401+	Model Name :	RF2401Pro
Temperature :	20 °C	Relative Humidity :	48%
Pressure :	1010 hPa	Test Voltage :	DC 3.3V
Test Mode :	TX-CH00(1M bps)	Polarization :	Vertical

Frequency (MHz)	Meter Reading (dBµV)	Factor (dB)	Emission Level (dBµV/m)	Limits (dBµV/m)	Margin (dB)	Detector Type
2402	94.53	-10.14	84.39	114.0 0	-29.61	peak
2402	85.34	-10.14	75.2	94	-18.8	AVG
4804	59.37	-2.5	56.87	74	-17.13	peak
4804	44.4	-2.5	41.9	54	-12.1	AVG

Remark:
 Factor = Antenna Factor + Cable Loss – Pre-amplifier.
 No emission above 18GHz.

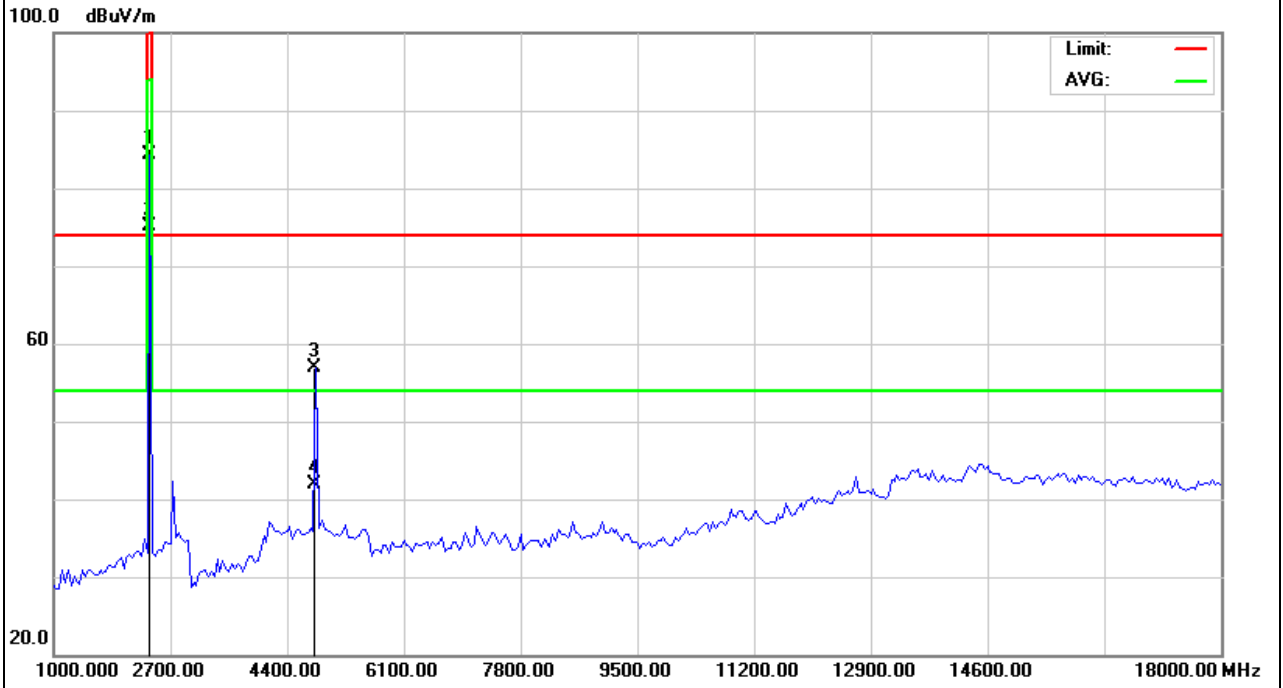

Note: EUT Pre-scan X/Y/Z orientation, only worst case is presented in the report(X orientation).

EUT :	2.4G RF module with nRF2401+	Model Name :	RF2401Pro
Temperature :	20 °C	Relative Humidity :	48%
Pressure :	1010 hPa	Test Voltage :	DC 3.3V
Test Mode :	TX-CH80(1M bps)	Polarization :	Horizontal

Frequency (MHz)	Meter Reading (dBμV)	Factor (dB)	Emission Level (dBμV/m)	Limits (dBμV/m)	Margin (dB)	Detector Type
2482	85.22	-10.44	74.78	114.0 0	-39.22	peak
2482	71.94	-10.44	61.5	94	-32.5	AVG
4964	38.15	-1.88	36.27	74	-37.73	peak
4964	24.48	-1.88	22.6	54	-31.4	AVG

Remark:
 Factor = Antenna Factor + Cable Loss – Pre-amplifier.
 No emission above 18GHz.

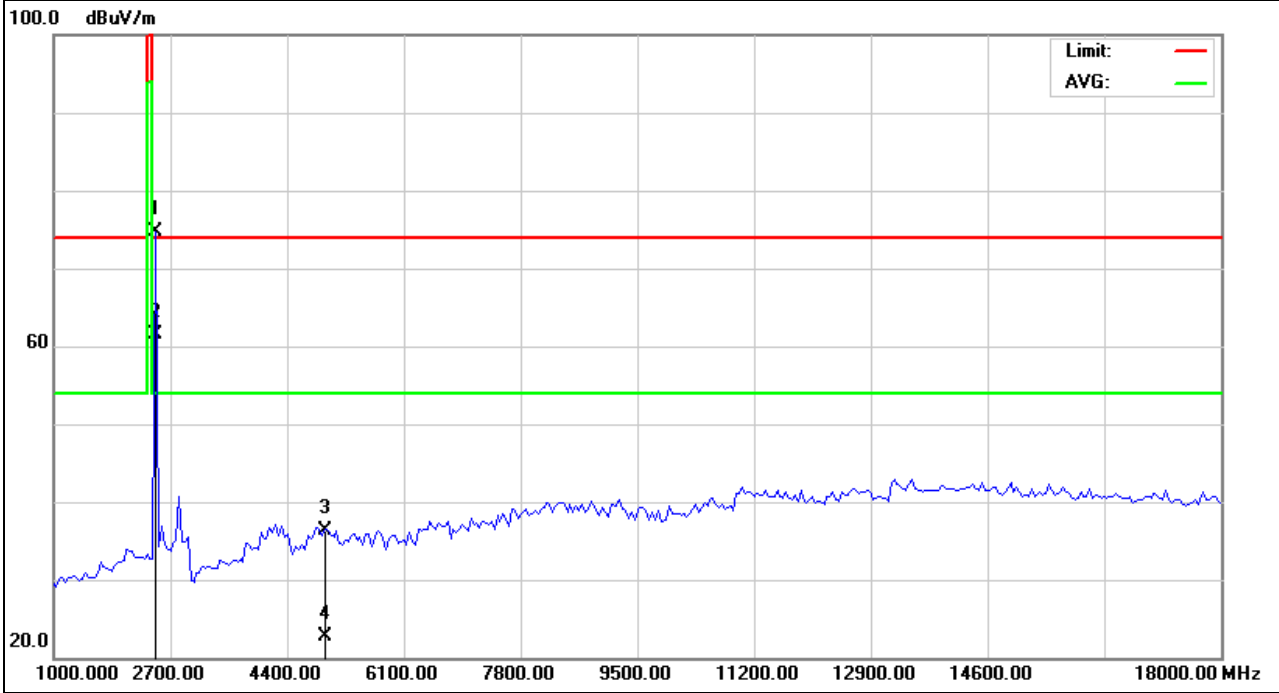

EUT :	2.4G RF module with nRF2401+	Model Name :	RF2401Pro
Temperature :	20 °C	Relative Humidity :	48%
Pressure :	1010 hPa	Test Voltage :	DC 3.3V
Test Mode :	TX-CH80(1M bps)	Polarization :	Vertical

Frequency (MHz)	Meter Reading (dBμV)	Factor (dB)	Emission Level (dBμV/m)	Limits (dBμV/m)	Margin (dB)	Detector Type
2482	90.37	-10.44	79.93	114.0 0	-34.07	peak
2482	77.84	-10.44	67.4	94	-26.6	AVG
4964	48.51	-1.88	46.63	74	-27.37	peak
4964	31.48	-1.88	29.6	54	-24.4	AVG

Remark:
 Factor = Antenna Factor + Cable Loss – Pre-amplifier.
 No emission above 18GHz.

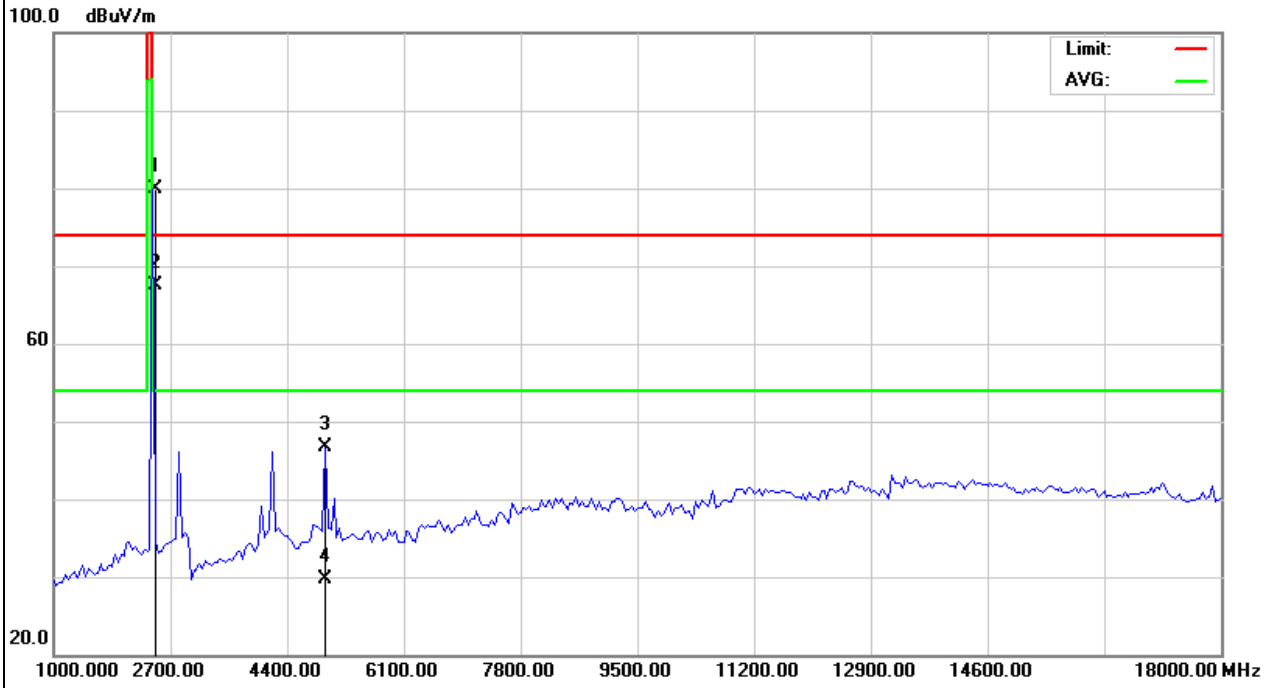

Note: EUT Pre-scan X/Y/Z orientation, only worst case is presented in the report(X orientation).

EUT :	2.4G RF module with nRF2401+	Model Name :	RF2401Pro
Temperature :	20 °C	Relative Humidity :	48%
Pressure :	1010 hPa	Test Voltage :	DC 3.3V
Test Mode :	TX-CH00(2M bps)	Polarization :	Horizontal

Frequency (MHz)	Meter Reading (dBμV)	Factor (dB)	Emission Level (dBμV/m)	Limits (dBμV/m)	Margin (dB)	Detector Type
2402	92.26	-10.14	82.12	114.0 0	-31.88	peak
2402	79.04	-10.14	68.9	94	-25.1	AVG
2742.5	49.67	-9.79	39.88	74	-34.12	peak
2742.5	38.29	-9.79	28.5	54	-25.5	AVG

Remark:
 Factor = Antenna Factor + Cable Loss – Pre-amplifier.
 No emission above 18GHz.

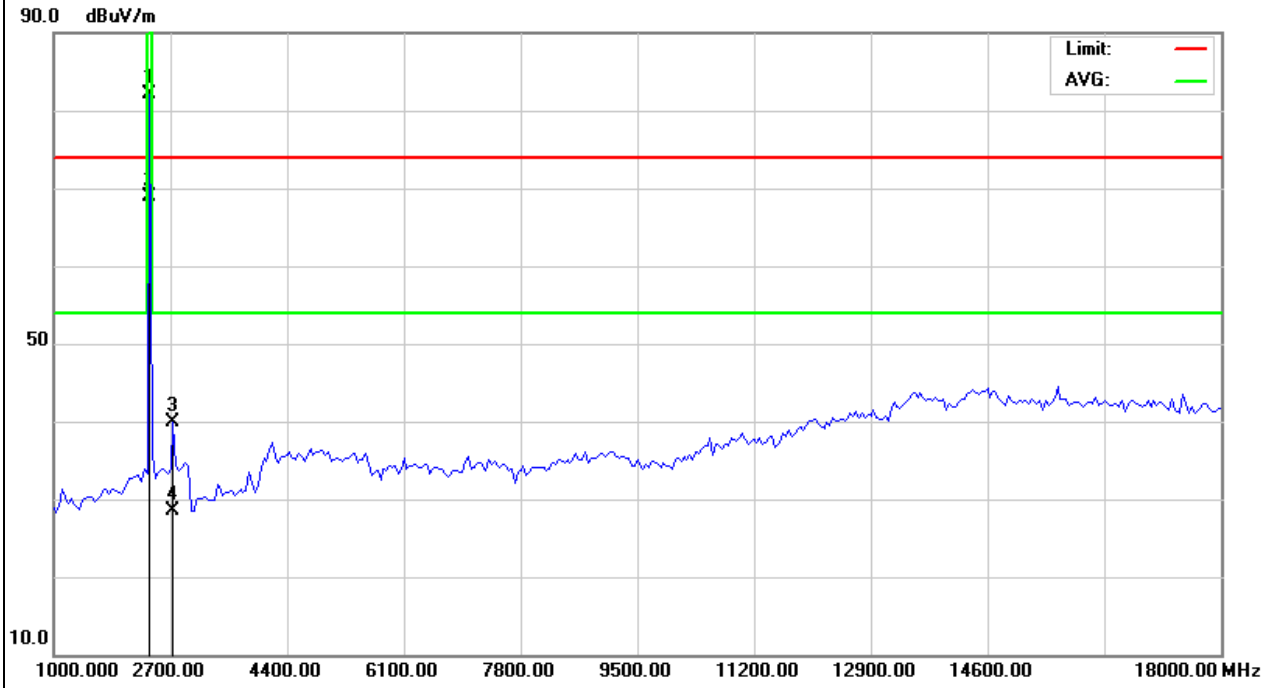

EUT :	2.4G RF module with nRF2401+	Model Name :	RF2401Pro
Temperature :	20 °C	Relative Humidity :	48%
Pressure :	1010 hPa	Test Voltage :	DC 3.3V
Test Mode :	TX-CH00(2M bps)	Polarization :	Vertical

Frequency (MHz)	Meter Reading (dBμV)	Factor (dB)	Emission Level (dBμV/m)	Limits (dBμV/m)	Margin (dB)	Detector Type
2402	86.34	-10.14	76.2	114.0 0	-37.8	peak
2402	71.34	-10.14	61.2	94	-32.8	AVG
4804	56.73	-2.5	54.23	74	-19.77	peak
4804	48.2	-2.5	45.7	54	-8.3	AVG

Remark:
 Factor = Antenna Factor + Cable Loss – Pre-amplifier.
 No emission above 18GHz.

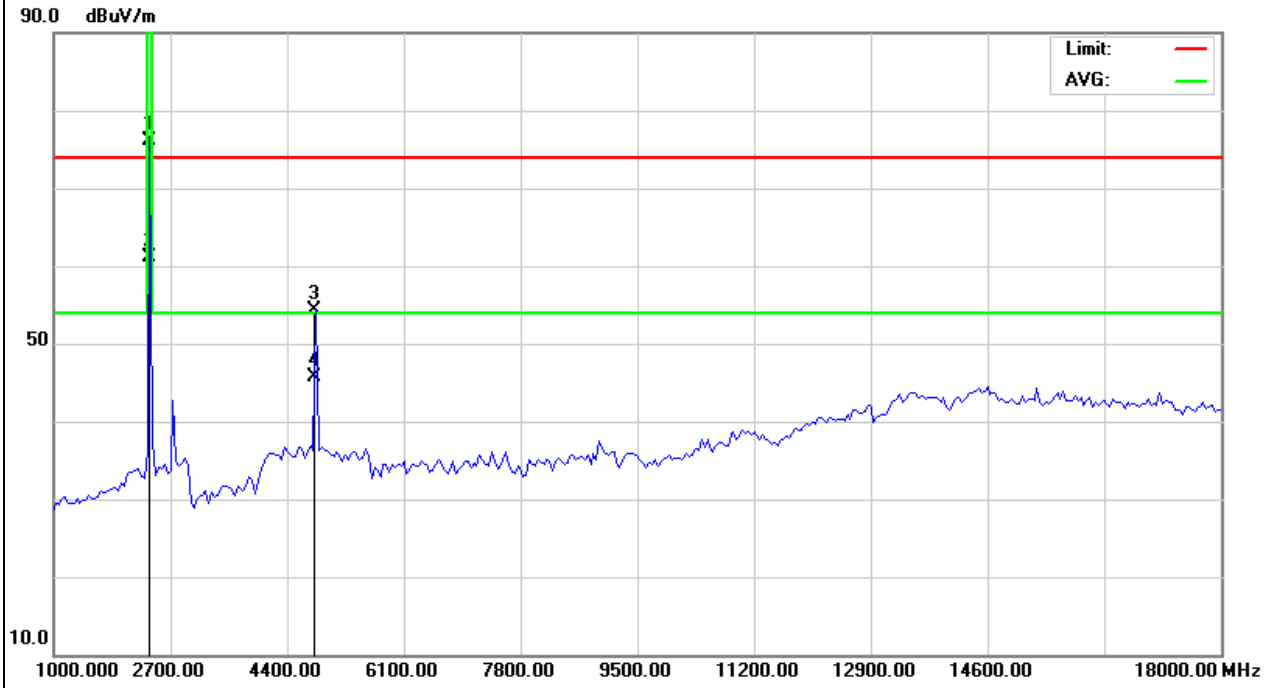

Note: EUT Pre-scan X/Y/Z orientation, only worst case is presented in the report(X orientation).

EUT :	2.4G RF module with nRF2401+	Model Name :	RF2401Pro
Temperature :	20 °C	Relative Humidity :	48%
Pressure :	1010 hPa	Test Voltage :	DC 3.3V
Test Mode :	TX-CH80(2M bps)	Polarization :	Horizontal

Frequency (MHz)	Meter Reading (dBμV)	Factor (dB)	Emission Level (dBμV/m)	Limits (dBμV/m)	Margin (dB)	Detector Type
2482	91.51	-10.44	81.07	114.0 0	-32.93	peak
2482	79.84	-10.44	69.4	94	-24.6	AVG
4964	54.84	-1.88	52.96	74	-21.04	peak
4964	41.58	-1.88	39.7	54	-14.3	AVG

Remark:
 Factor = Antenna Factor + Cable Loss – Pre-amplifier.
 No emission above 18GHz.

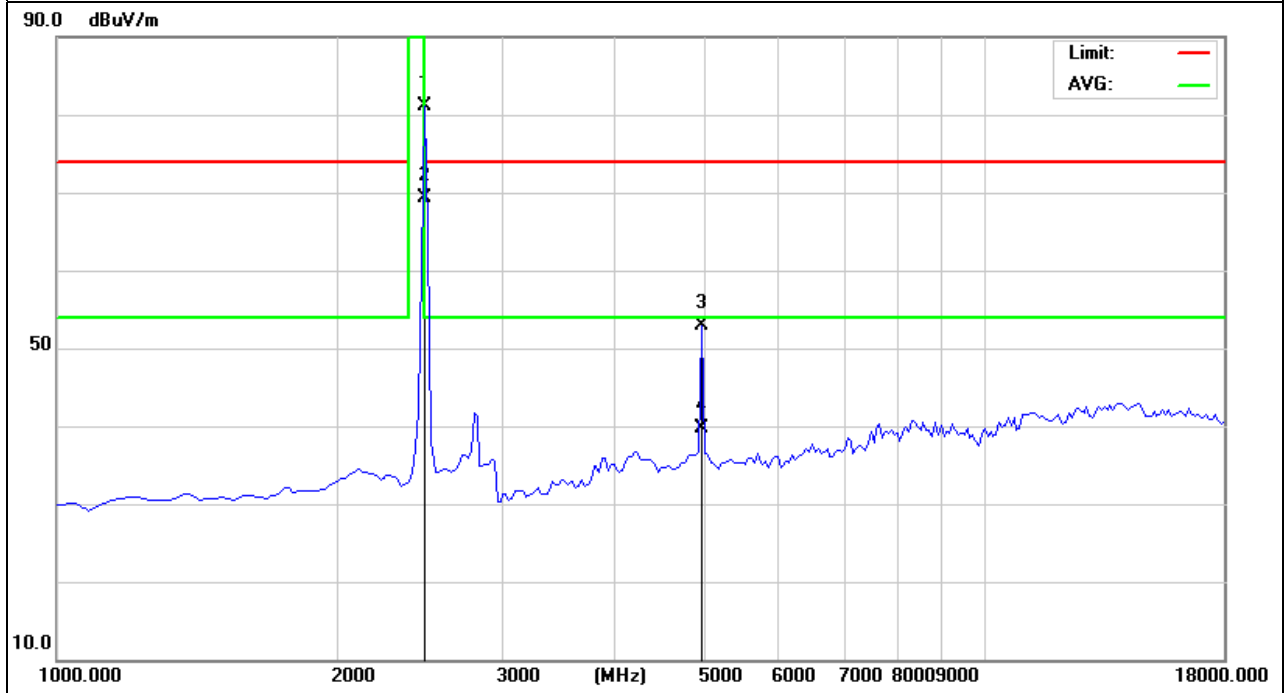

EUT :	2.4G RF module with nRF2401+	Model Name :	RF2401Pro
Temperature :	20 °C	Relative Humidity :	48%
Pressure :	1010 hPa	Test Voltage :	DC 3.3V
Test Mode :	TX-CH80(2M bps)	Polarization :	Vertical

Frequency (MHz)	Meter Reading (dBμV)	Factor (dB)	Emission Level (dBμV/m)	Limits (dBμV/m)	Margin (dB)	Detector Type
2482	91.53	-10.44	81.09	114.0 0	-32.91	peak
2482	79.24	-10.44	68.8	94	-25.2	AVG
4964	37.79	-1.88	35.91	74	-38.09	peak
4964	28.38	-1.88	26.5	54	-27.5	AVG

Remark:
 Factor = Antenna Factor + Cable Loss – Pre-amplifier.
 No emission above 18GHz.

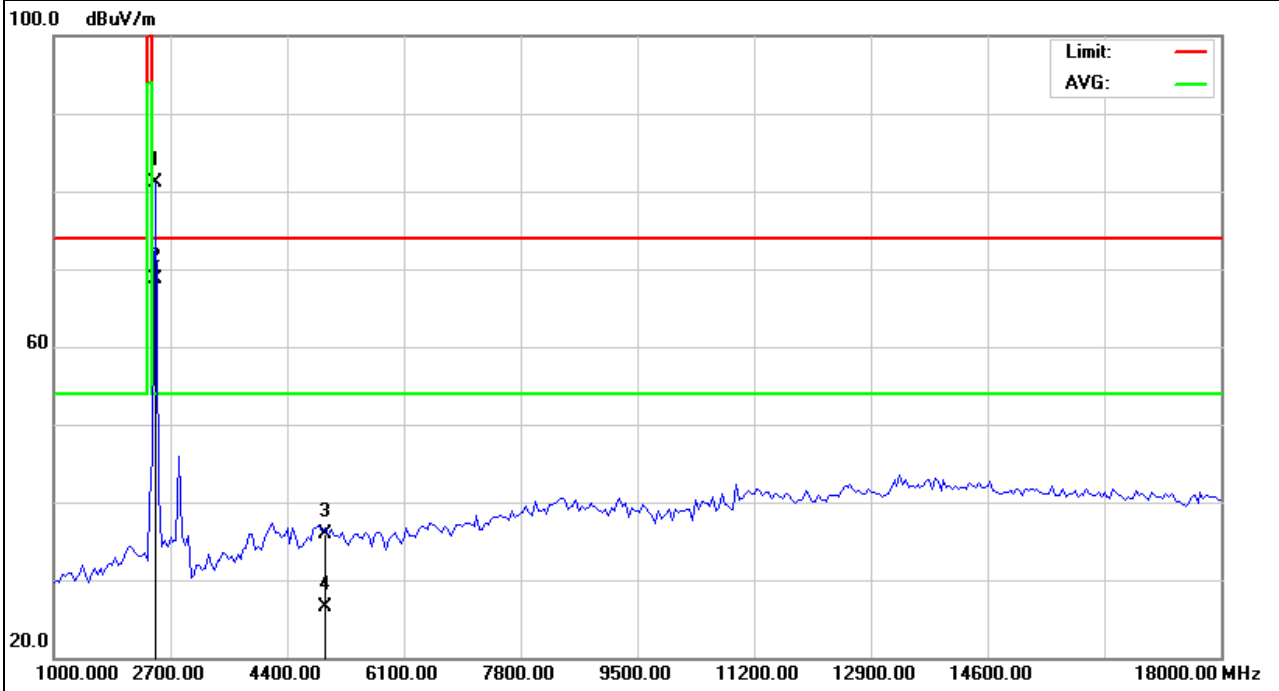

Note: EUT Pre-scan X/Y/Z orientation, only worst case is presented in the report(X orientation).

3.4.8 TEST RESULTS (RESTRICTED BANDS REQUIREMENTS)

EUT :	2.4G RF module with nRF2401+	Model Name :	RF2401Pro
Temperature :	20 °C	Relative Humidity :	48%
Pressure :	1010 hPa	Test Voltage :	DC 3.3V
Test Mode :	TX-CH00(250k bps)	Polarization :	Vertical

Frequency (MHz)	Meter Reading (dBμV)	Factor (dB)	Emission Level (dBμV/m)	Limits (dBμV/m)	Margin (dB)	Detector Type
2400	63.39	-10.09	53.3	74	-20.7	peak
2400	48.69	-10.09	38.6	54	-15.4	AVG

Remark:
Factor = Antenna Factor + Cable Loss – Pre-amplifier.

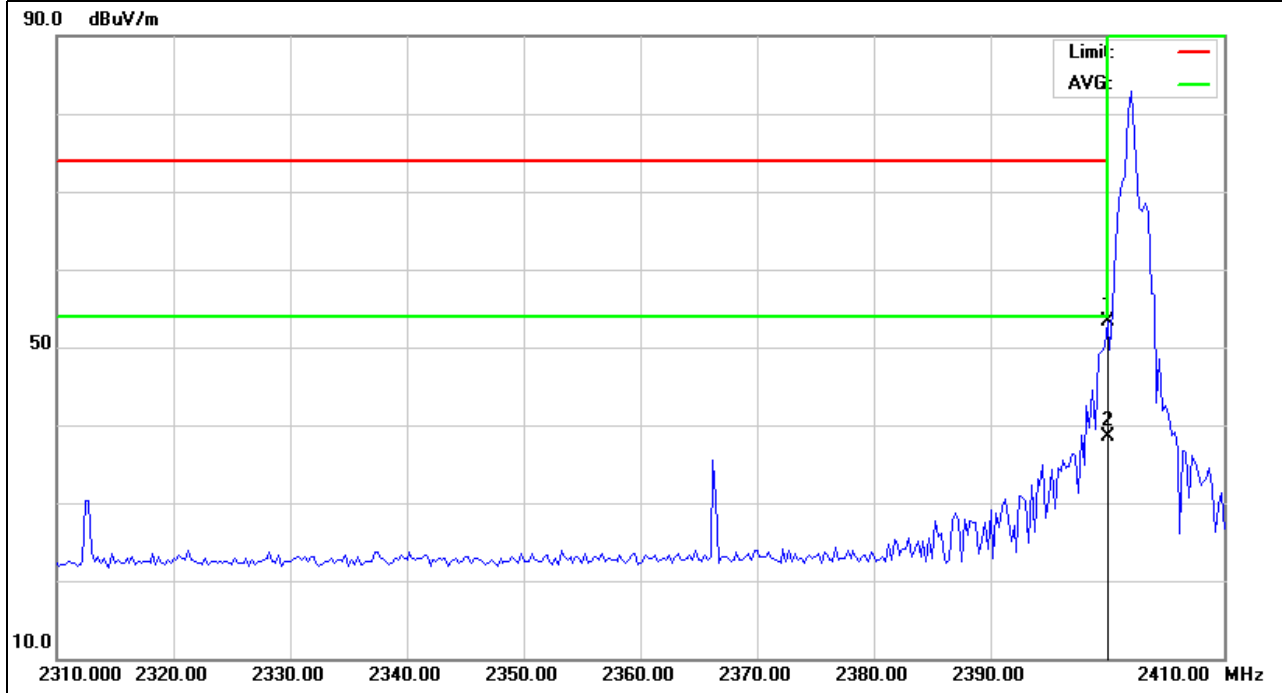

EUT :	2.4G RF module with nRF2401+	Model Name :	RF2401Pro
Temperature :	20 °C	Relative Humidity :	48%
Pressure :	1010 hPa	Test Voltage :	DC 3.3V
Test Mode :	TX-CH00(250k bps)	Polarization :	Horizontal

Frequency (MHz)	Meter Reading (dBμV)	Factor (dB)	Emission Level (dBμV/m)	Limits (dBμV/m)	Margin (dB)	Detector Type
2394.5	49.68	-10.11	39.57	74	-34.43	peak
2394.5	37.81	-10.11	27.7	54	-26.3	AVG
2400	65.86	-10.09	55.77	74	-18.23	peak
2400	44.69	-10.09	34.6	54	-19.4	AVG

Remark:
 Factor = Antenna Factor + Cable Loss – Pre-amplifier.

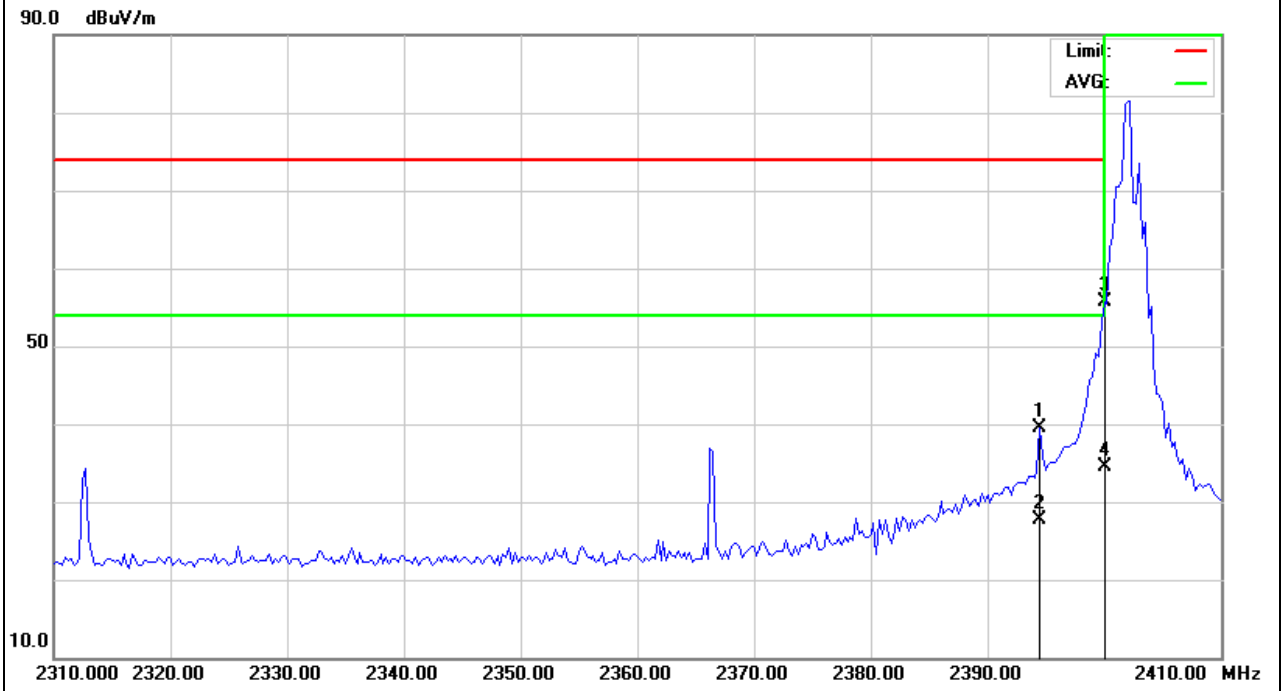

EUT :	2.4G RF module with nRF2401+	Model Name :	RF2401Pro
Temperature :	20 °C	Relative Humidity :	48%
Pressure :	1010 hPa	Test Voltage :	DC 3.3V
Test Mode :	TX-CH80(250k bps)	Polarization :	Vertical

Frequency (MHz)	Meter Reading (dBμV)	Factor (dB)	Emission Level (dBμV/m)	Limits (dBμV/m)	Margin (dB)	Detector Type
2483.5	56.97	-10.43	46.54	74	-27.46	peak
2483.5	43.23	-10.43	32.8	54	-21.2	AVG

Remark:
 Factor = Antenna Factor + Cable Loss – Pre-amplifier.

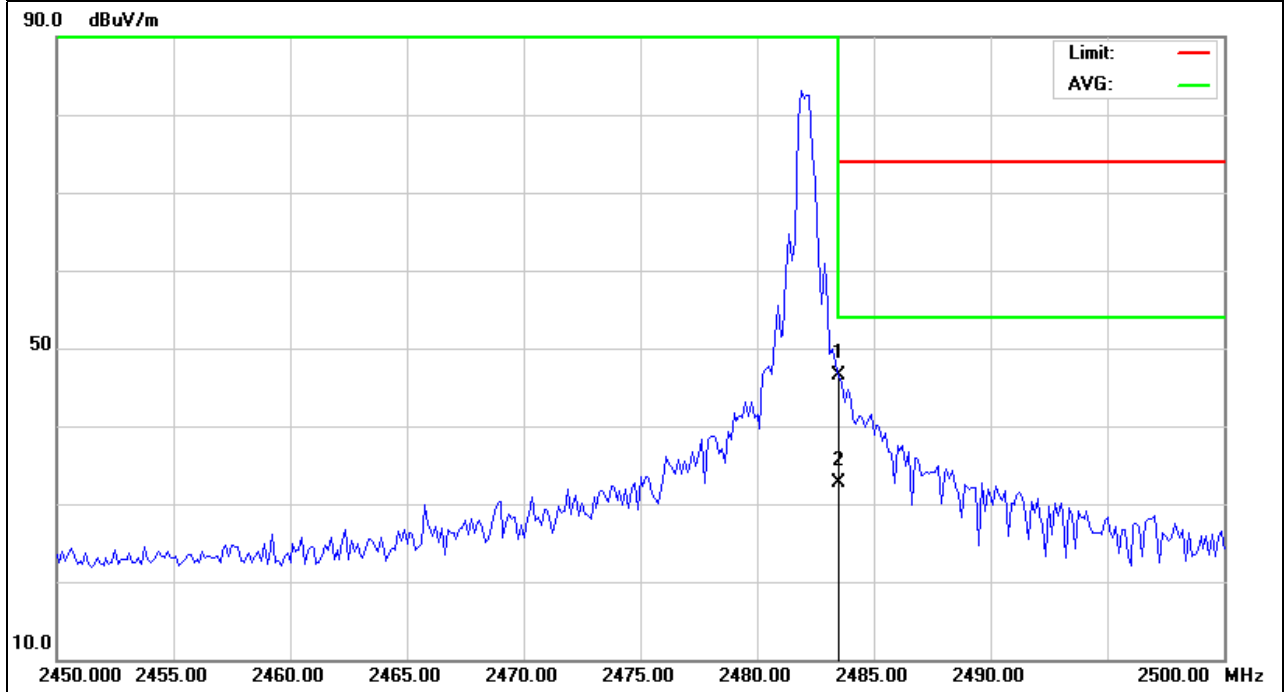

EUT :	2.4G RF module with nRF2401+	Model Name :	RF2401Pro
Temperature :	20 °C	Relative Humidity :	48%
Pressure :	1010 hPa	Test Voltage :	DC 3.3V
Test Mode :	TX-CH80(250k bps)	Polarization :	Horizontal

Frequency (MHz)	Meter Reading (dBμV)	Factor (dB)	Emission Level (dBμV/m)	Limits (dBμV/m)	Margin (dB)	Detector Type
2483.5	56.66	-10.43	46.23	74	-27.77	peak
2483.5	43.63	-10.43	33.2	54	-20.8	AVG

Remark:
Factor = Antenna Factor + Cable Loss – Pre-amplifier.

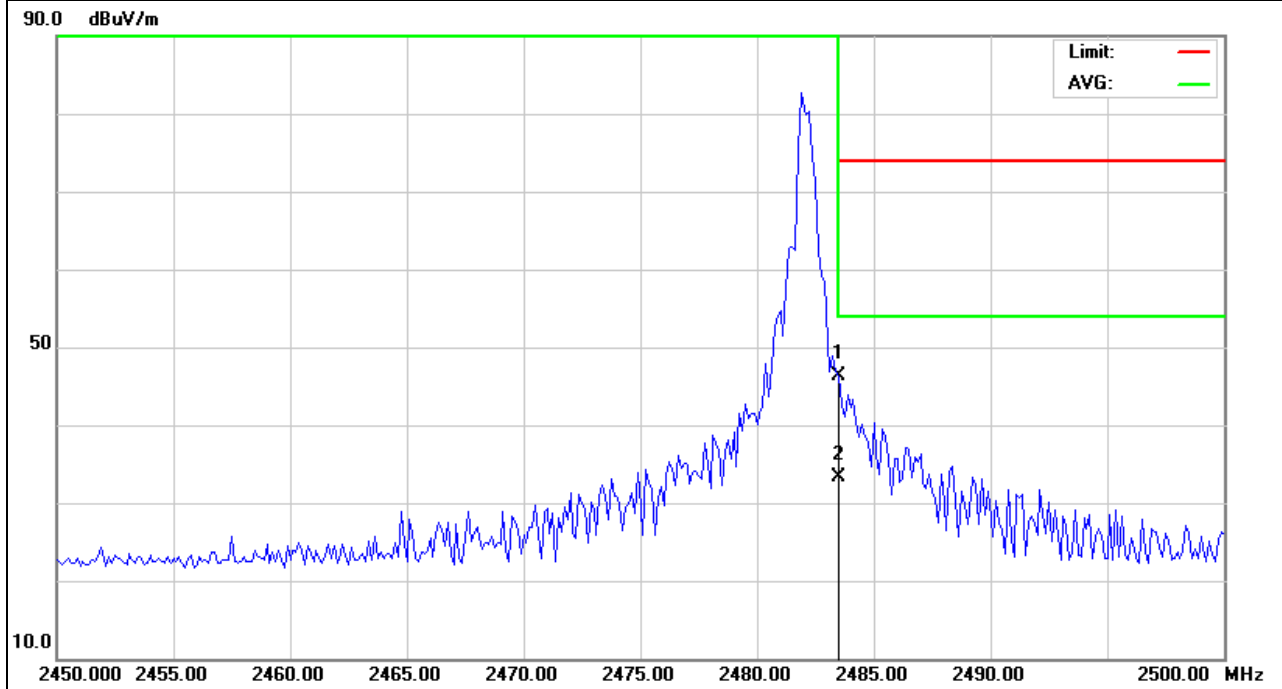

EUT :	2.4G RF module with nRF2401+	Model Name :	RF2401Pro
Temperature :	20 °C	Relative Humidity :	48%
Pressure :	1010 hPa	Test Voltage :	DC 3.3V
Test Mode :	TX-CH00 (1M bps)	Polarization :	Vertical

Frequency (MHz)	Meter Reading (dBμV)	Factor (dB)	Emission Level (dBμV/m)	Limits (dBμV/m)	Margin (dB)	Detector Type
2400	67.61	-10.09	57.52	74	-16.48	peak
2400	52.69	-10.09	42.6	54	-11.4	AVG

Remark:
Factor = Antenna Factor + Cable Loss – Pre-amplifier.

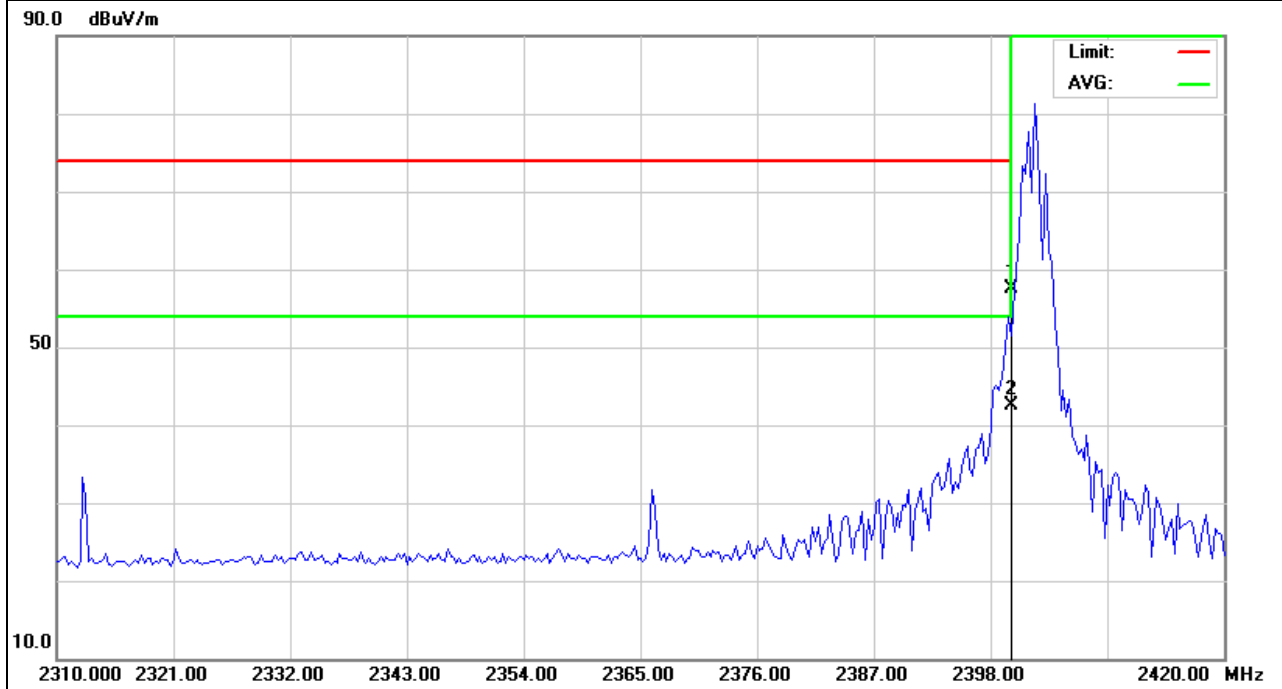

EUT :	2.4G RF module with nRF2401+	Model Name :	RF2401Pro
Temperature :	20 °C	Relative Humidity :	48%
Pressure :	1010 hPa	Test Voltage :	DC 3.3V
Test Mode :	TX-CH00 (1M bps)	Polarization :	Horizontal

Frequency (MHz)	Meter Reading (dBμV)	Factor (dB)	Emission Level (dBμV/m)	Limits (dBμV/m)	Margin (dB)	Detector Type
2400	66	-10.09	55.91	74	-18.09	peak
2400	50.59	-10.09	40.5	54	-13.5	AVG

Remark:
Factor = Antenna Factor + Cable Loss – Pre-amplifier.

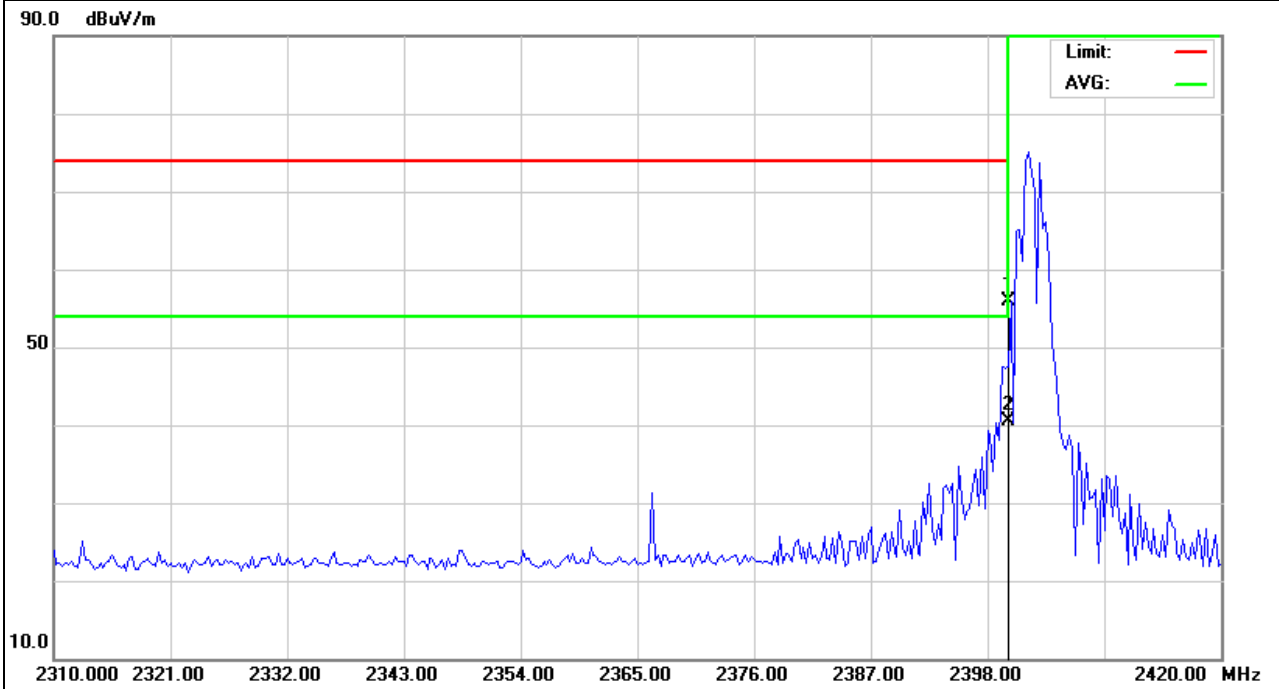

EUT :	2.4G RF module with nRF2401+	Model Name :	RF2401Pro
Temperature :	20 °C	Relative Humidity :	48%
Pressure :	1010 hPa	Test Voltage :	DC 3.3V
Test Mode :	TX-CH80 (1M bps)	Polarization :	Vertical

Frequency (MHz)	Meter Reading (dBμV)	Factor (dB)	Emission Level (dBμV/m)	Limits (dBμV/m)	Margin (dB)	Detector Type
2483.5	55.25	-10.43	44.82	74	-29.18	peak
2483.5	33.23	-10.43	22.8	54	-31.2	AVG

Remark:
 Factor = Antenna Factor + Cable Loss – Pre-amplifier.

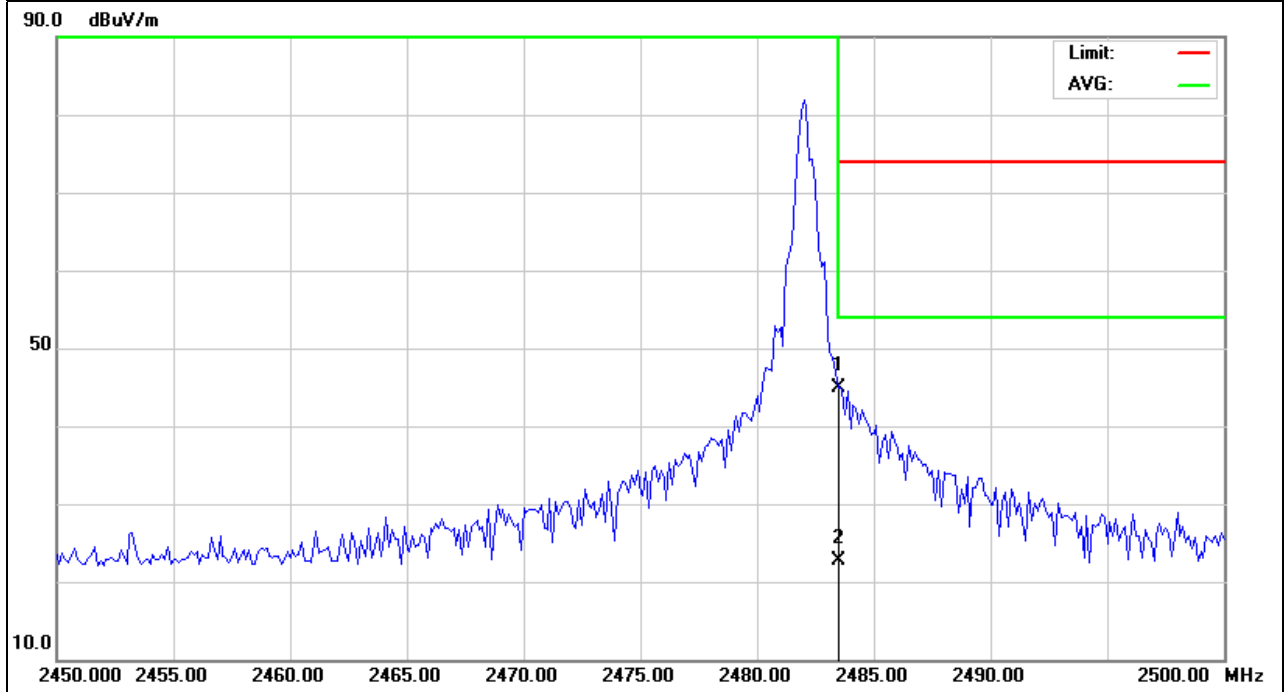

EUT :	2.4G RF module with nRF2401+	Model Name :	RF2401Pro
Temperature :	20 °C	Relative Humidity :	48%
Pressure :	1010 hPa	Test Voltage :	DC 3.3V
Test Mode :	TX-CH80 (1M bps)	Polarization :	Horizontal

Frequency (MHz)	Meter Reading (dBμV)	Factor (dB)	Emission Level (dBμV/m)	Limits (dBμV/m)	Margin (dB)	Detector Type
2483.5	53.43	-10.43	43	74	-31	peak
2483.5	33.23	-10.43	22.8	54	-31.2	AVG

Remark:
Factor = Antenna Factor + Cable Loss – Pre-amplifier.

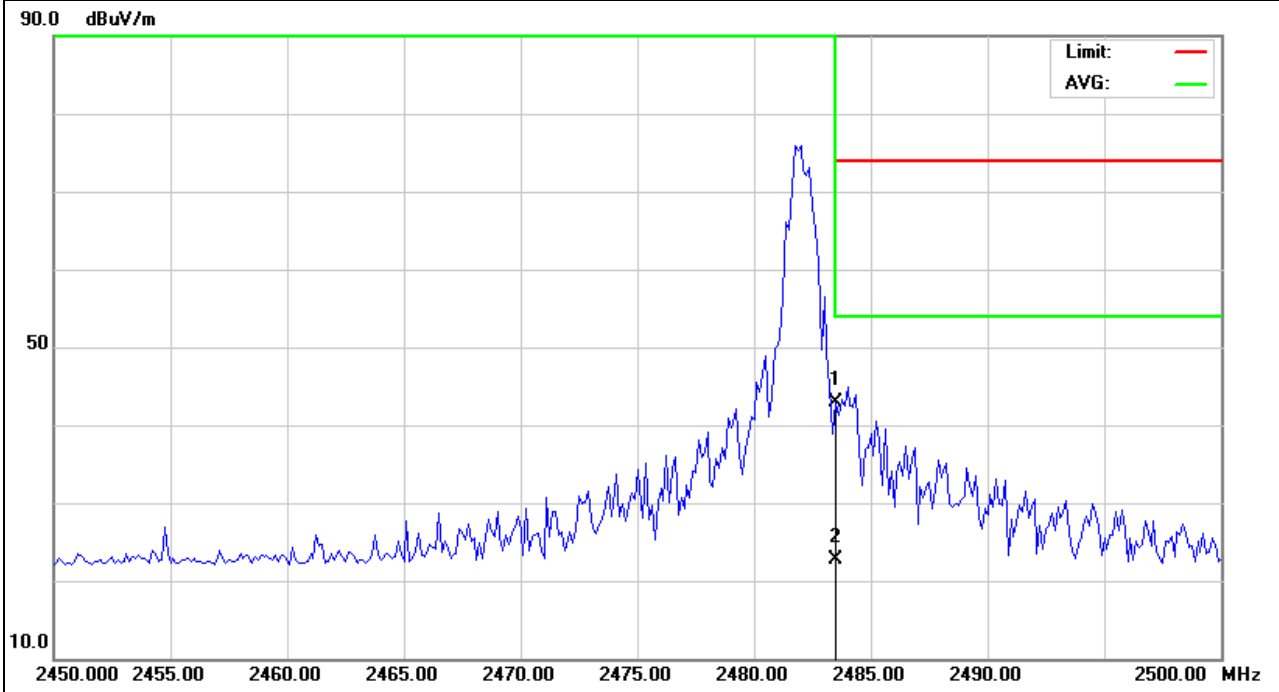

EUT :	2.4G RF module with nRF2401+	Model Name :	RF2401Pro
Temperature :	20 °C	Relative Humidity :	48%
Pressure :	1010 hPa	Test Voltage :	DC 3.3V
Test Mode :	TX-CH00 (2M bps)	Polarization :	Vertical

Frequency (MHz)	Meter Reading (dBμV)	Factor (dB)	Emission Level (dBμV/m)	Limits (dBμV/m)	Margin (dB)	Detector Type
2400	61.73	-10.09	51.64	74	-22.36	peak
2400	48.59	-10.09	38.5	54	-15.5	AVG

Remark:
 Factor = Antenna Factor + Cable Loss – Pre-amplifier.

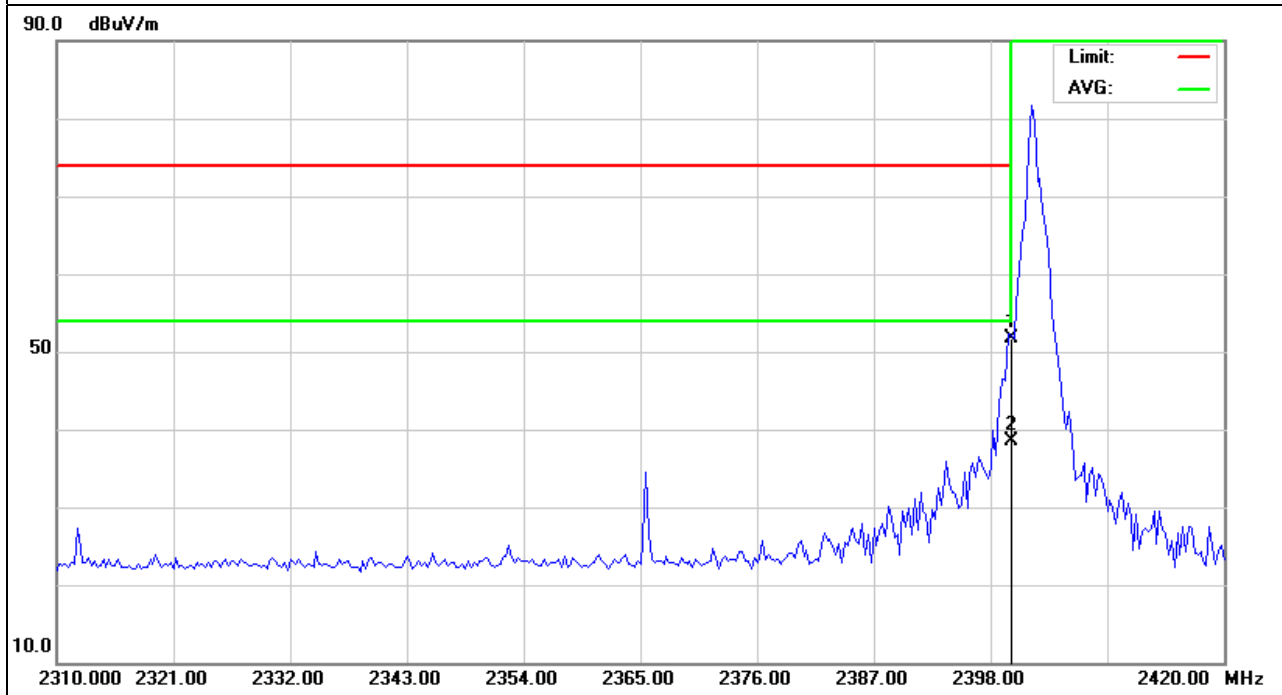

EUT :	2.4G RF module with nRF2401+	Model Name :	RF2401Pro
Temperature :	20 °C	Relative Humidity :	48%
Pressure :	1010 hPa	Test Voltage :	DC 3.3V
Test Mode :	TX-CH00 (2M bps)	Polarization :	Horizontal

Frequency (MHz)	Meter Reading (dBμV)	Factor (dB)	Emission Level (dBμV/m)	Limits (dBμV/m)	Margin (dB)	Detector Type
2400	68.51	-10.09	58.42	74	-15.58	peak
2400	51.39	-10.09	41.3	54	-12.7	AVG

Remark:

Factor = Antenna Factor + Cable Loss – Pre-amplifier.

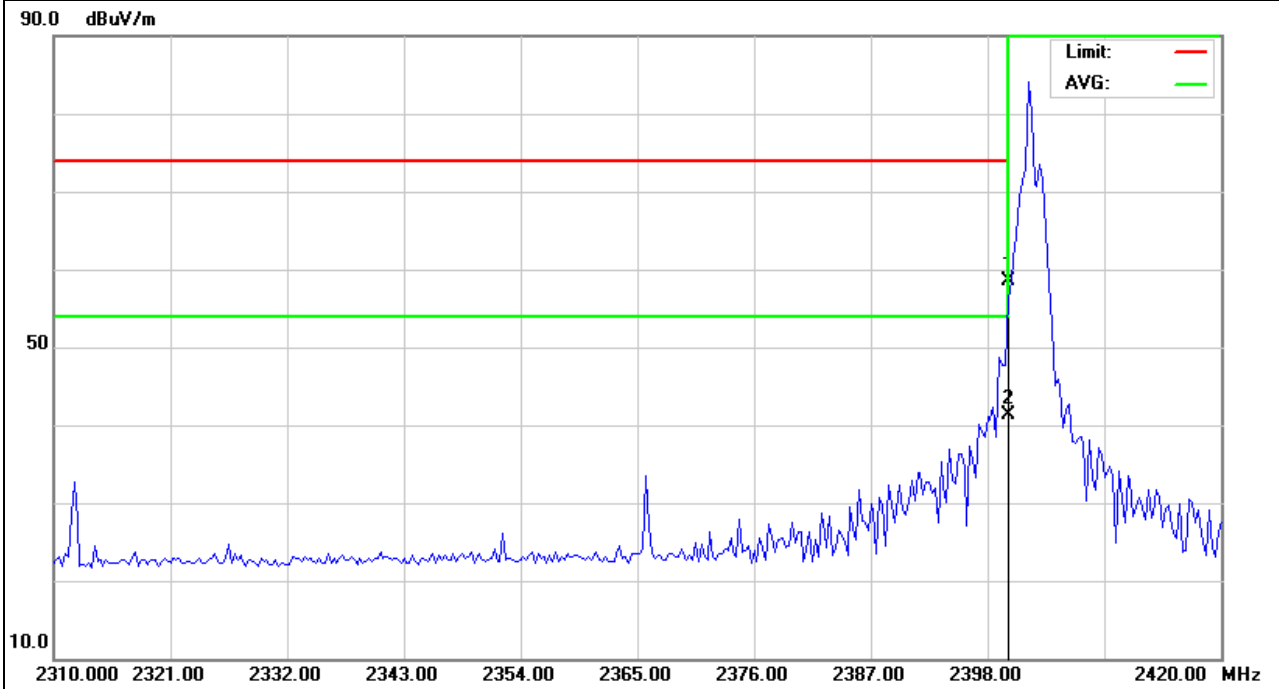

EUT :	2.4G RF module with nRF2401+	Model Name :	RF2401Pro
Temperature :	20 °C	Relative Humidity :	48%
Pressure :	1010 hPa	Test Voltage :	DC 3.3V
Test Mode :	TX-CH80 (2M bps)	Polarization :	Vertical

Frequency (MHz)	Meter Reading (dBμV)	Factor (dB)	Emission Level (dBμV/m)	Limits (dBμV/m)	Margin (dB)	Detector Type
2483.5	60.43	-10.43	50	74	-24	peak
2483.5	48.53	-10.43	38.1	54	-15.9	AVG

Remark:
 Factor = Antenna Factor + Cable Loss – Pre-amplifier.

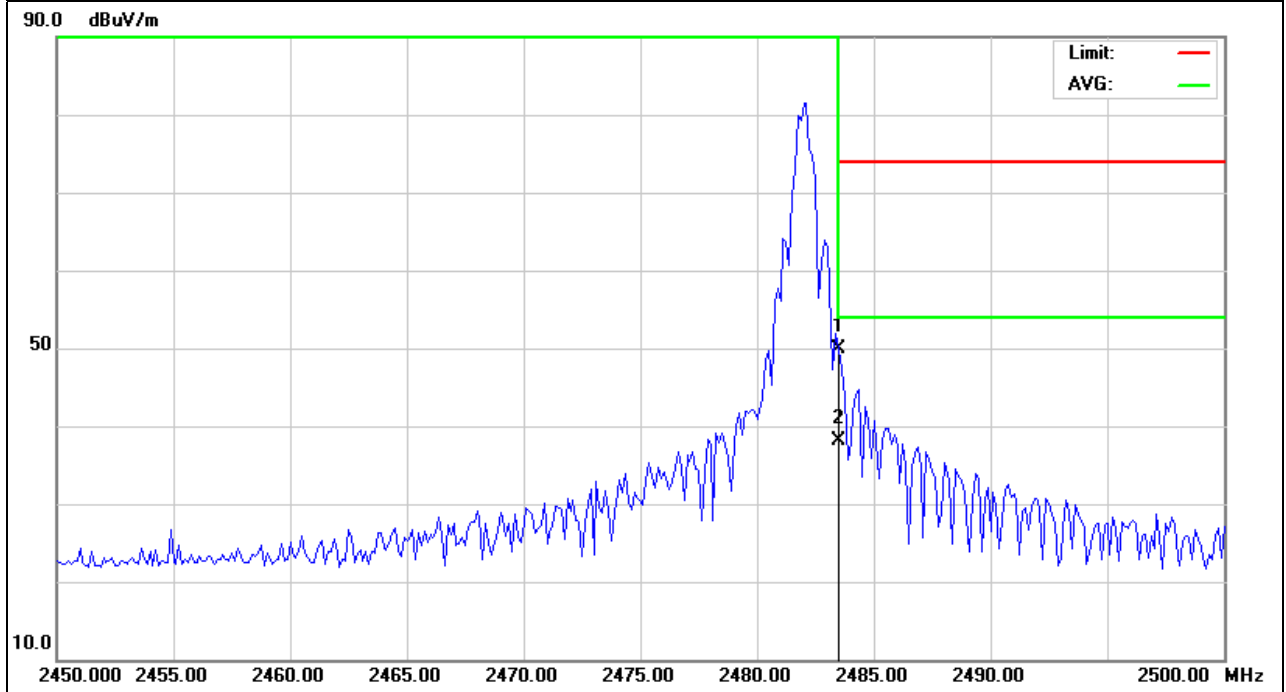

EUT :	2.4G RF module with nRF2401+	Model Name :	RF2401Pro
Temperature :	20 °C	Relative Humidity :	48%
Pressure :	1010 hPa	Test Voltage :	DC 3.3V
Test Mode :	TX-CH80 (2M bps)	Polarization :	Horizontal

Frequency (MHz)	Meter Reading (dBμV)	Factor (dB)	Emission Level (dBμV/m)	Limits (dBμV/m)	Margin (dB)	Detector Type
2483.5	52.55	-10.43	42.12	74	-31.88	peak
2483.5	41.83	-10.43	31.4	54	-22.6	AVG

Remark:
 Factor = Antenna Factor + Cable Loss – Pre-amplifier.

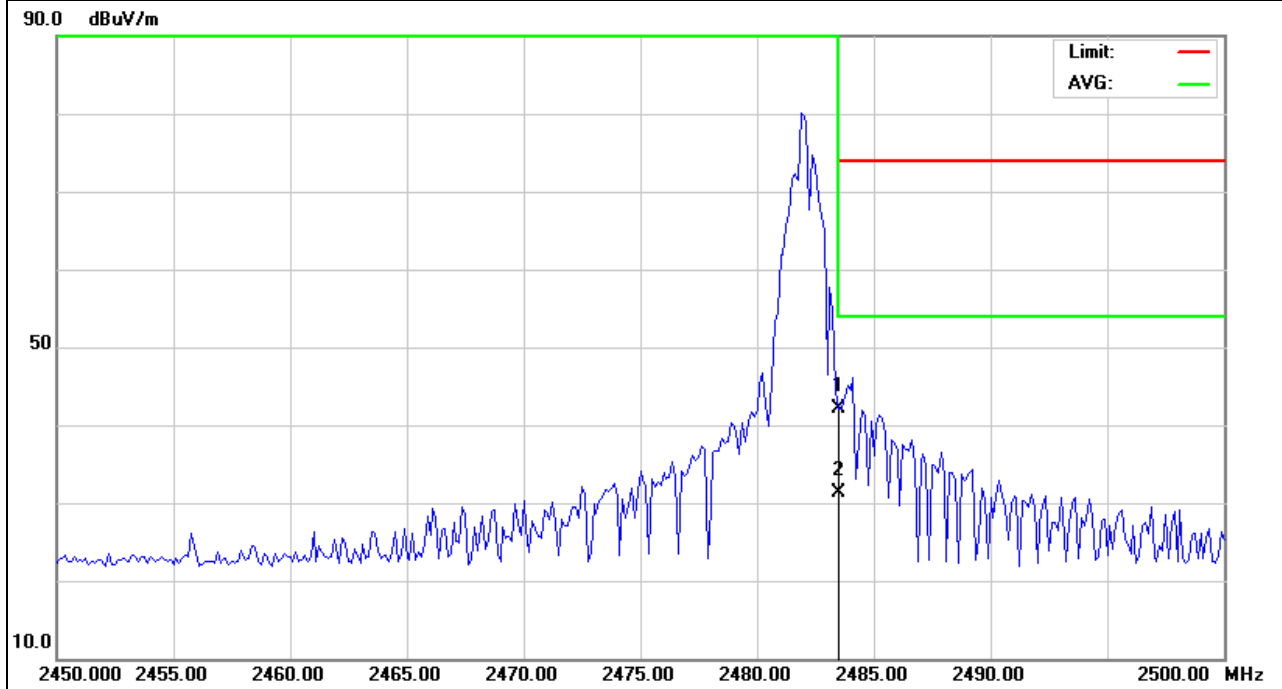

4. BANDWIDTH TEST

4.1 TEST PROCEDURE

- a. The EUT was directly connected to the spectrum analyzer and antenna output port as show in the block diagram below,
- b. Spectrum Setting : RBW= 100KHz, VBW \geq RBW, Sweep time = Auto.

4.2 DEVIATION FROM STANDARD

No deviation.

4.3 TEST SETUP



4.4 TEST RESULTS

EUT :	2.4G RF module with nRF2401+	Model Name :	RF2401Pro
Temperature :	26 °C	Relative Humidity :	53%
Pressure :	1020 hPa	Test Power :	DC 3.3V
Test Mode :	TX-CH00/CH80 (250k bps)		

Test Channel	Frequency (MHz)	20 dBc Bandwidth (kHz)
CH00	2402	4862
CH80	2482	3637

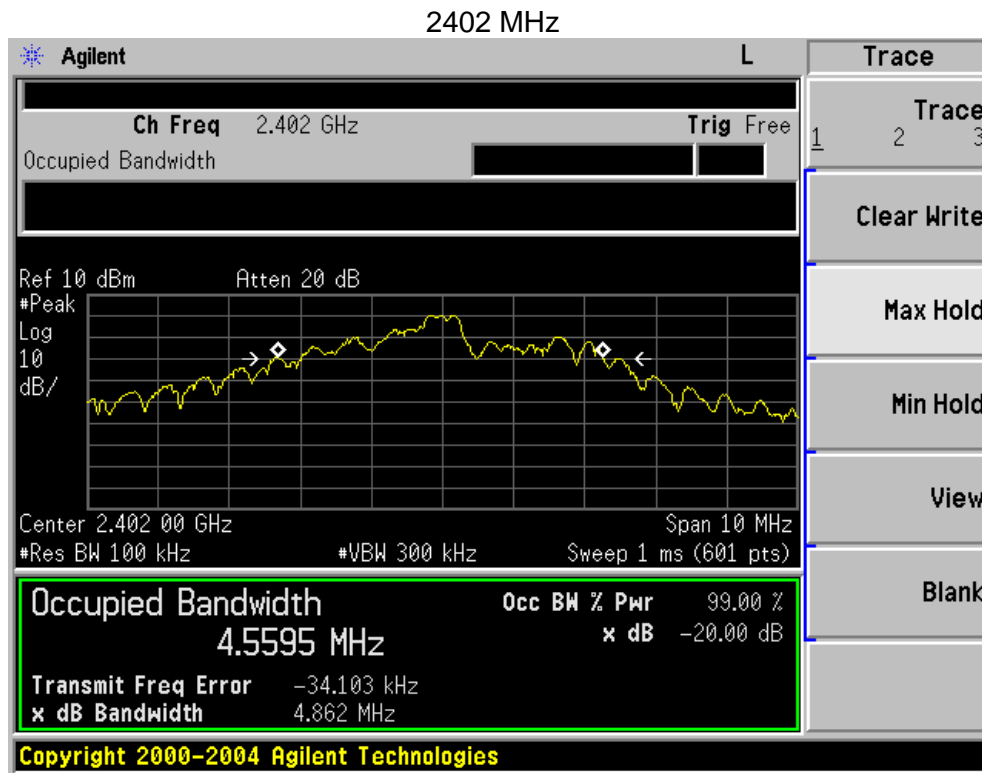

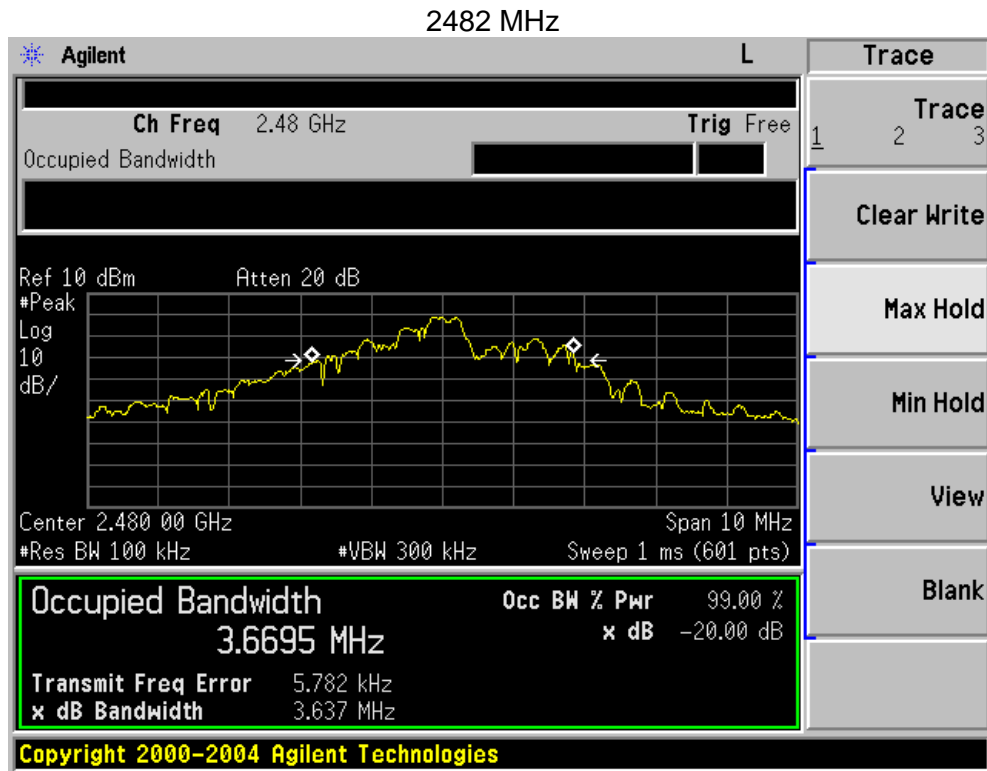

EUT :	2.4G RF module with nRF2401+	Model Name :	RF2401Pro
Temperature :	26 °C	Relative Humidity :	53%
Pressure :	1020 hPa	Test Power :	DC 3.3V
Test Mode :	TX-CH00/CH80 (1M bps)		

Test Channel	Frequency (MHz)	20 dBc Bandwidth (kHz)
CH00	2402	4632
CH80	2482	3554

2402 MHz

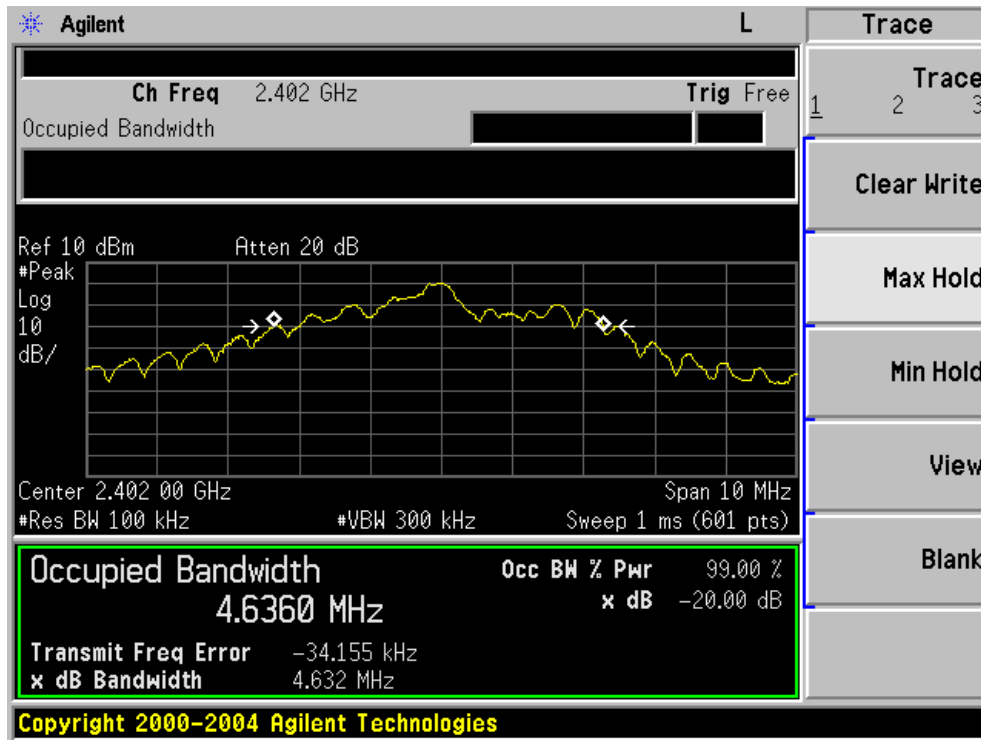

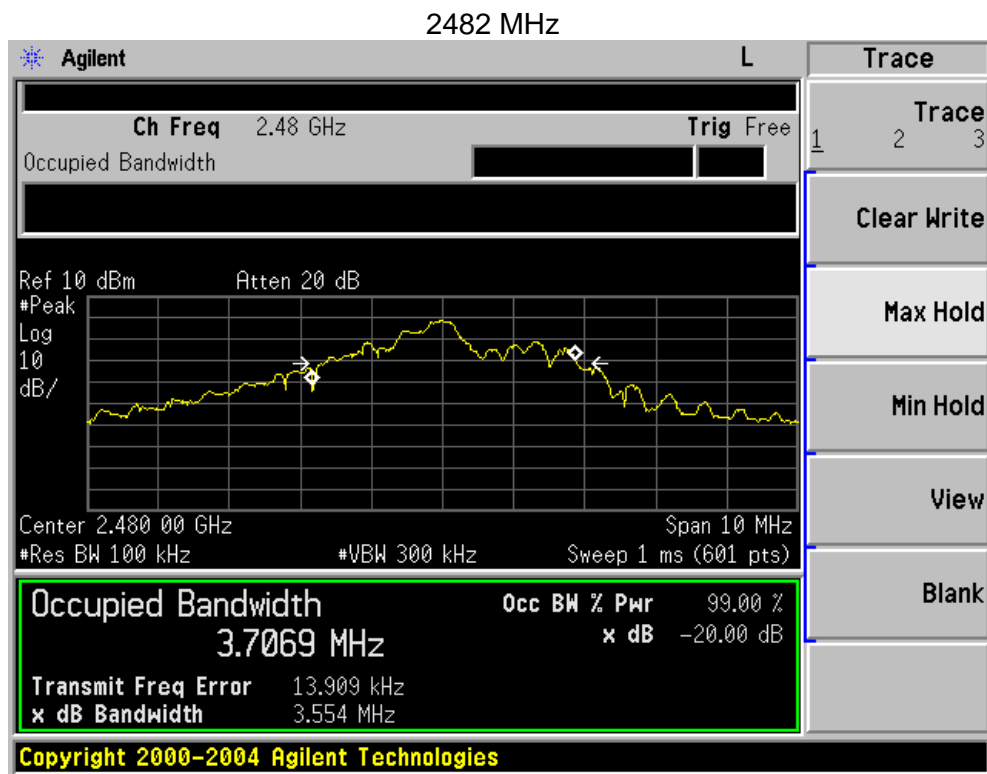

EUT :	2.4G RF module with nRF2401+	Model Name :	RF2401Pro
Temperature :	26 °C	Relative Humidity :	53%
Pressure :	1020 hPa	Test Power :	DC 3.3V
Test Mode :	TX-CH00/CH80 (2M bps)		

Test Channel	Frequency (MHz)	20 dBc Bandwidth (kHz)
CH00	2402	4893
CH80	2482	3680

2402 MHz

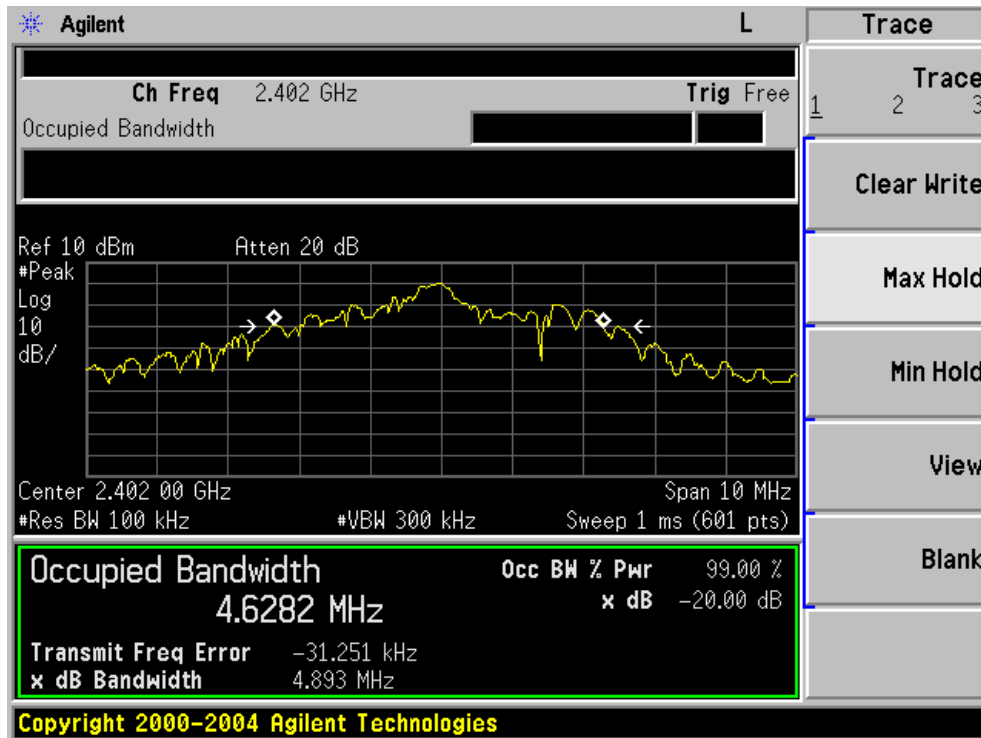

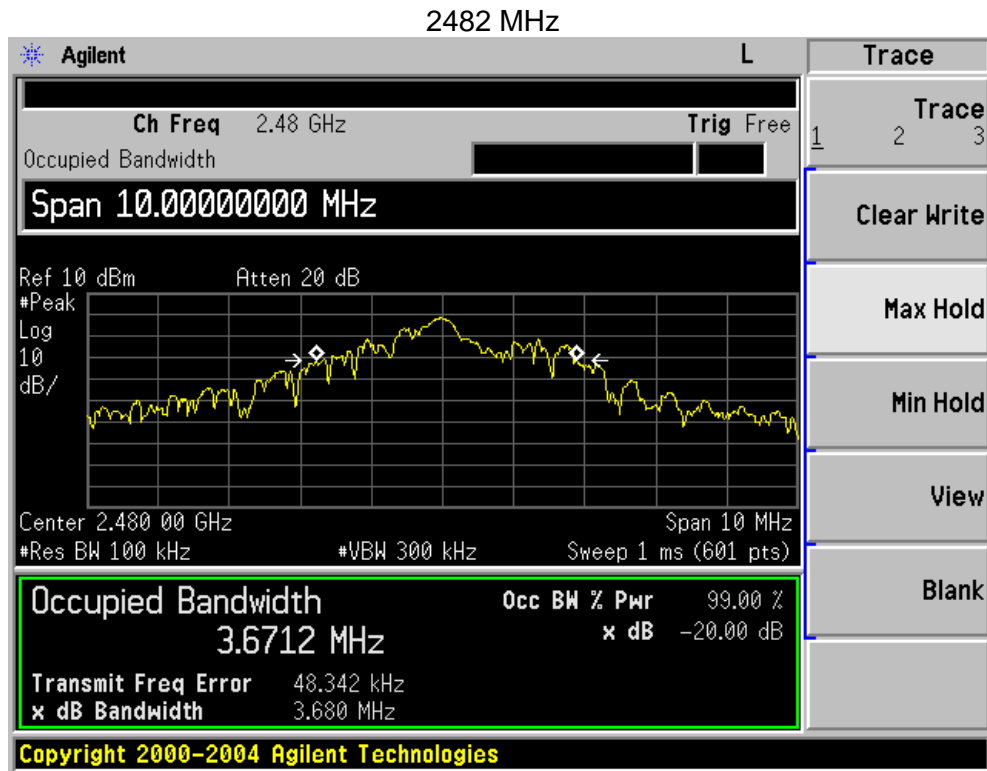

5. EUT TEST PHOTO

Radiated Measurement Photos

