



# FCC RADIO TEST REPORT

## FCC ID: 2AD66-RF2401F20

**Product :** 2.4G RF module with amplifier

**Trade Name :** N/A

**Model Name :** RF2401F20

**Serial Model :** N/A

**Report No. :** NTEK- 2014NT12042151F

### Prepared for

NiceRF Wireless Technology LTD.

4th floor of DuoTai Building, Anle Industrial Zone, Area 43, Baoan Dist,  
Shenzhen, China

### Prepared by

Shenzhen NTEK Testing Technology Co., Ltd.

1/F, Building E, Fenda Science Park, Sanwei Community, Xixiang Street  
Bao'an District, Shenzhen P.R. China

Tel.: +86-0755-61156588 Fax.: +86-0755-61156599

Website: [www.ntek.org.cn](http://www.ntek.org.cn)

### TEST RESULT CERTIFICATION

**Applicant's name** ..... : NiceRF Wireless Technology LTD.  
**Address** ..... : 4th floor of DuoTai Building, Anle Industrial Zone, Area 43, Baoan Dist, Shenzhen, China  
**Manufacture's Name**..... : NiceRF Wireless Technology LTD.  
**Address** ..... : 4th floor of DuoTai Building, Anle Industrial Zone, Area 43, Baoan Dist, Shenzhen, China

**Product description**

**Product name** ..... : 2.4G RF module with amplifier  
**Model and/or type reference** : RF2401F20  
**Serial Model** : N/A  
**Rating(s)**..... : DC 5.0V

**Standards** ..... : FCC Part15.249 01 Oct. 2014

**Test procedure**..... ANSI C63.4-2003

This device described above has been tested by NTEK, and the test results show that the equipment under test (EUT) is in compliance with the FCC requirements. And it is applicable only to the tested sample identified in the report.

This report shall not be reproduced except in full, without the written approval of NTEK, this document may be altered or revised by NTEK, personal only, and shall be noted in the revision of the document.

**Date of Test** ..... :  
**Date (s) of performance of tests** ..... : 04 Dec. 2014 ~28 Jan. 2015  
**Date of Issue**..... : 28 Jan. 2015  
**Test Result**..... : **Pass**

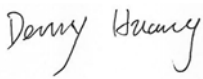
**Testing Engineer** :   
Denny Huang

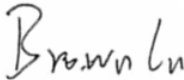
**Technical Manager** :   
(Brown Lu)

**Authorized Signatory** :   
(Bill Yao)

<b>Table of Contents</b>	<b>Page</b>
<b>1 . SUMMARY OF TEST RESULTS</b>	<b>4</b>
1.1 TEST FACILITY	5
1.2 MEASUREMENT UNCERTAINTY	5
<b>2 . GENERAL INFORMATION</b>	<b>6</b>
2.1 GENERAL DESCRIPTION OF EUT	6
2.2 DESCRIPTION OF TEST MODES	8
2.3 BLOCK DIGRAM SHOWING THE CONFIGURATION OF SYSTEM TESTED	9
2.4 DESCRIPTION OF SUPPORT UNITS(CONDUCTED MODE)	10
2.5 EQUIPMENTS LIST FOR ALL TEST ITEMS	11
<b>3 . ANTENNA REQUIREMENT</b>	<b>12</b>
3.1 STANDARD REQUIREMENT	12
3.2 EUT ANTENNA	12
3.3 CONDUCTED EMISSION MEASUREMENT	13
3.3.1 POWER LINE CONDUCTED EMISSION LIMITS	13
3.3.2 TEST PROCEDURE	14
3.3.3 DEVIATION FROM TEST STANDARD	14
3.3.4 TEST SETUP	14
3.2.5 TEST RESULT	15
3.4 RADIATED EMISSION MEASUREMENT	16
3.4.1 RADIATED EMISSION LIMITS	16
3.4.2 TEST PROCEDURE	17
3.4.3 DEVIATION FROM TEST STANDARD	17
3.4.4 TEST SETUP	18
3.4.5 TEST RESULTS (BLOW 30MHZ)	20
3.4.6 TEST RESULTS (BETWEEN 30 – 1000 MHZ)	21
3.4.7 TEST RESULTS (ABOVE 1000 MHZ)	23
3.4.8 TEST RESULTS (RESTRICTED BANDS REQUIREMENTS)	41
<b>4 . BANDWIDTH TEST</b>	<b>53</b>
4.1 TEST PROCEDURE	53
4.2 DEVIATION FROM STANDARD	53
4.3 TEST SETUP	53
4.4 TEST RESULTS	54
<b>5 . EUT TEST PHOTO</b>	<b>60</b>
APPENDIX-PHOTOGRAPHS OF EUT CONSTRUCTIONAL DETAILS	

## 1. SUMMARY OF TEST RESULTS

Test procedures according to the technical standards:

<b>FCC Part15, Subpart C (15.249)</b>			
<b>Standard Section</b>	<b>Test Item</b>	<b>Judgment</b>	<b>Remark</b>
15.207	Conducted Emission	N/A	
15.203	Antenna Requirement	Pass	
15.249	Radiated Spurious Emission	Pass	
15.205	Band Edge Emission	Pass	
15.249	Occupied Bandwidth	Pass	

## 1.1 TEST FACILITY

NTEK Testing Technology Co., Ltd

Add. : 1/F, Building E, Fenda Science Park, Sanwei Community, Xixiang Street, Bao'an District, Shenzhen P.R. China.

FCC FRN Registration No.:238937; IC Registration No.:9270A-1

CNAS Registration No.:L5516

## 1.2 MEASUREMENT UNCERTAINTY

The reported uncertainty of measurement  $y \pm U$ , where expanded uncertainty  $U$  is based on a standard uncertainty multiplied by a coverage factor of  $k=2$ , providing a level of confidence of approximately 95 %.

No.	Item	Uncertainty
1	Conducted Emission Test	$\pm 1.38\text{dB}$
2	RF power,conducted	$\pm 0.16\text{dB}$
3	Spurious emissions,conducted	$\pm 0.21\text{dB}$
4	All emissions,radiated(<1G)	$\pm 4.68\text{dB}$
5	All emissions,radiated(>1G)	$\pm 4.89\text{dB}$
6	Temperature	$\pm 0.5^\circ\text{C}$
7	Humidity	$\pm 2\%$

## 2. GENERAL INFORMATION

### 2.1 GENERAL DESCRIPTION OF EUT

Equipment	2.4G RF module with amplifier	
Trade Name	N/A	
Model Name	RF2401F20	
Serial Model	N/A	
Model Difference	N/A	
Product Description	The EUT is a 2.4G RF module with amplifier.	
	Operation Frequency:	2402MHz-2480MHz
	Modulation Type:	GFSK
	Bit Rate of Transmitter	250Kbps/1Mbps/2Mbps
	Antenna Designation:	Wire Antenna
	Antenna Gain(Peak)	1.0 dBi
	EIRP	105.08dBuv/m@3m
Based on the application, features, or specification exhibited in User's Manual, the EUT is considered as an ITE/Computing Device. More details of EUT technical specification, please refer to the User's Manual.		
Channel List	Please refer to the Note 2.	
Adapter	N/A	
Battery	N/A	
Power Supply	DC 5.0V	

Note:

1. For a more detailed features description, please refer to the manufacturer's specifications or the User's Manual.

2.

Channel List					
Channel	Frequency (MHz)	Channel	Frequency (MHz)	Channel	Frequency (MHz)
00	2402	27	2429	54	2456
01	2403	28	2430	55	2457
02	2404	29	2431	56	2458
03	2405	30	2432	57	2459
04	2406	31	2433	58	2460
05	2407	32	2434	59	2461
06	2408	33	2435	60	2462
07	2409	34	2436	61	2463
08	2410	35	2437	62	2464
09	2411	36	2438	63	2465
10	2412	37	2439	64	2466
11	2413	38	2440	65	2467
12	2414	39	2441	66	2468
13	2415	40	2442	67	2469
14	2416	41	2443	68	2470
15	2417	42	2444	69	2471
16	2418	43	2445	70	2472
17	2419	44	2446	71	2473
18	2420	45	2447	72	2474
19	2421	46	2448	73	2475
20	2422	47	2449	74	2476
21	2423	48	2450	75	2477
22	2424	49	2451	76	2478
23	2425	50	2452	77	2479
24	2426	51	2453	78	2480
25	2427	52	2454		
26	2428	53	2455		

3.

Table for Filed Antenna

Ant	Brand	Model Name	Antenna Type	Connector	Gain (dBi)	NOTE
1	N/A	N/A	Wire Antenna	N/A	1.0	Antenna

## 2.2 DESCRIPTION OF TEST MODES

To investigate the maximum EMI emission characteristics generates from EUT, the test system was pre-scanning tested base on the consideration of following EUT operation mode or test configuration mode which possible have effect on EMI emission level. Each of these EUT operation mode(s) or test configuration mode(s) mentioned above was evaluated respectively.

Pretest Mode	Description
Mode 1	TX CH 00
Mode 2	TX CH 39
Mode 3	TX CH 78

For Radiated Emission	
Final Test Mode	Description
Mode 1	TX CH 00
Mode 2	TX CH 39
Mode 3	TX CH 78

Note:

- (1) The measurements are performed at the highest, middle, lowest available channels.
- (2) The EUT use new battery.



### 2.3 BLOCK DIGRAM SHOWING THE CONFIGURATION OF SYSTEM TESTED

Radiated Spurious Emission Test

E-1 EUT	E-2 Test Demo
------------	------------------

**2.4 DESCRIPTION OF SUPPORT UNITS(CONDUCTED MODE)**

The EUT has been tested as an independent unit together with other necessary accessories or support units. The following support units or accessories were used to form a representative test configuration during the tests.

Item	Equipment	Mfr/Brand	Model/Type No.	Series No.	Note
E-1	2.4G RF module with amplifier	N/A	RF2401F20	N/A	EUT
E-2	Test Demo	N/A	N/A	N/A	

Item	Shielded Type	Ferrite Core	Length	Note

Note:

- (1) The support equipment was authorized by Declaration of Confirmation.
- (2) For detachable type I/O cable should be specified the length in cm in 『Length』 column.

**2.5 EQUIPMENTS LIST FOR ALL TEST ITEMS**
**Radiation Test equipment**

Item	Kind of Equipment	Manufacturer	Type No.	Serial No.	Calibrated until
1	Spectrum Analyzer	Agilent	E4407B	160400005	Jul. 06. 2016
2	Test Receiver	R&S	ESPI	101318	Jul. 06. 2016
3	Bilog Antenna	TESEQ	CBL6111D	31216	Jul. 06. 2016
4	50Ω Coaxial Switch	Anritsu	MP59B	6200264416	Jul. 06. 2016
5	Spectrum Analyzer	ADVANTEST	R3132	150900201	Jul. 06. 2016
6	Horn Antenna	EM	EM-AH-10180	2011071402	Jul. 06. 2016
7	Horn Ant	Schwarzbeck	BBHA 9170	9170-181	Jul. 06. 2016
8	Amplifier	EM	EM-30180	060538	Jul. 06. 2016
9	Loop Antenna	ARA	PLA-1030/B	1029	Jul. 06. 2016
10	Power Meter	R&S	NRVS	100696	Jul. 06. 2016

**Conduction Test equipment**

Item	Kind of Equipment	Manufacturer	Type No.	Serial No.	Calibrated until
1	Test Receiver	R&S	ESCI	101160	Jul. 06. 2016
2	LISN	R&S	ENV216	101313	Jul. 06. 2016
3	LISN	EMCO	3816/2	00042990	Jul. 06. 2016
4	50Ω Coaxial Switch	Anritsu	MP59B	6200264417	Jul. 06. 2016
5	Passive Voltage Probe	R&S	ESH2-Z3	100196	Jul. 06. 2016
6	Absorbing clamp	R&S	MOS-21	100423	Jul. 06. 2016

### **3. ANTENNA REQUIREMENT**

#### **3.1 STANDARD REQUIREMENT**

15.203 requirement: For intentional device, according to 15.203: an intentional radiator shall be designed to ensure that no antenna other than that furnished by the responsible party shall be used with the device.

#### **3.2 EUT ANTENNA**

The EUT antenna is Wire Antenna. It comply with the standard requirement.

### 3.3 CONDUCTED EMISSION MEASUREMENT

#### 3.3.1 POWER LINE CONDUCTED EMISSION Limits (Frequency Range 150KHz-30MHz)

FREQUENCY (MHz)	Class A (dBuV)		Class B (dBuV)		Standard
	Quasi-peak	Average	Quasi-peak	Average	
0.15 -0.5			66 - 56 *	56 - 46 *	CISPR
0.50 -5.0			56.00	46.00	CISPR
5.0 -30.0			60.00	50.00	CISPR

0.15 -0.5			66 - 56 *	56 - 46 *	LP002.
0.50 -5.0			56.00	46.00	LP002.
5.0 -30.0			60.00	50.00	LP002.

Note:

- (1) The tighter limit applies at the band edges.
- (2) The limit of " \* " marked band means the limitation decreases linearly with the logarithm of the frequency in the range.

The following table is the setting of the receiver

Receiver Parameters	Setting
Attenuation	10 dB
Start Frequency	0.15 MHz
Stop Frequency	30 MHz
IF Bandwidth	9 kHz

### 3.3.2 TEST PROCEDURE

- a. The EUT was placed 0.4 meters from the horizontal ground plane with EUT being connected to the power mains through a line impedance stabilization network (LISN). All other support equipments powered from additional LISN(s). The LISN provide 50 Ohm/ 50uH of coupling impedance for the measuring instrument.
- b. Interconnecting cables that hang closer than 40 cm to the ground plane shall be folded back and forth in the center forming a bundle 30 to 40 cm long.
- c. I/O cables that are not connected to a peripheral shall be bundled in the center. The end of the cable may be terminated, if required, using the correct terminating impedance. The overall length shall not exceed 1 m.
- d. LISN at least 80 cm from nearest part of EUT chassis.
- e. For the actual test configuration, please refer to the related Item –EUT Test Photos.

### 3.3.3 DEVIATION FROM TEST STANDARD

No deviation

### 3.3.4 TEST SETUP

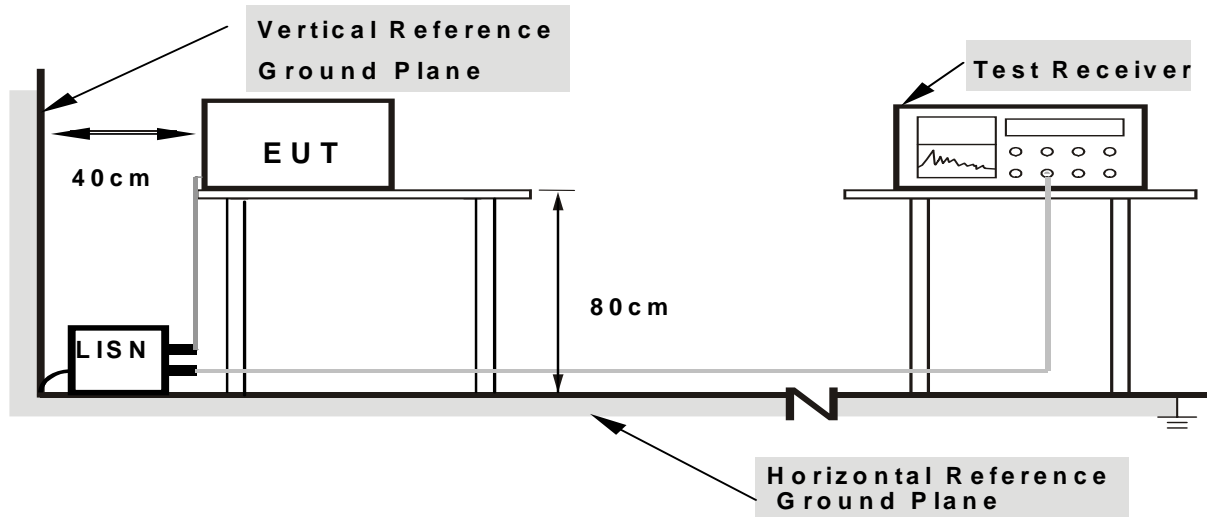

**Note: 1. Support units were connected to second LISN.**

**2. Both of LISNs (AMN) are 80 cm from EUT and at least 80 cm from other units and other metal planes**

**3.2.5 TEST RESULT**

N/A

### 3.4 RADIATED EMISSION MEASUREMENT

#### 3.4.1 Radiated Emission Limits ( FCC 15.209 )

Frequencies (MHz)	Field Strength (micorvolts/meter)	Measurement Distance (meters)
0.009~0.490	2400/F(KHz)	300
0.490~1.705	24000/F(KHz)	30
1.705~30.0	30	30
Frequency (MHz)	Limit (dBuV)	
30~88	40	3
88~216	43.5	3
216~960	46	3
960 -10000	54.00	3
*902 - 928	94.00	3

Note:

- (1) The tighter limit applies at the band edges.
- (2) Emission level (dBuV/m)=20log Emission level (uV/m).
- (3) \*Note: This is the limit for the fundamental frequency.

#### LIMITS OF RADIATED EMISSION MEASUREMENT ( FCC 15.249)

Frequency of Emission (MHz)	Field Strength of fundamental ((millivolts /meter)	Field Strength of Harmonics (microvolts/meter)
902-928	50	500

Notes:

- (1) Emissions radiated outside of the specified frequency bands, except for harmonics, shall be attenuated by at least 50 dB below the level of the fundamental or to the general radiated emission limits in Section 15.209, whichever is the lesser attenuation.

Spectrum Parameter	Setting
Attenuation	Auto
Start Frequency	1000 MHz
Stop Frequency	10th carrier harmonic
RB / VB (emission in restricted band)	1MHz / 1MHz for Peak

Receiver Parameter	Setting
Attenuation	Auto
Start ~ Stop Frequency	9kHz~150kHz / RB 200Hz for QP
Start ~ Stop Frequency	150kHz~30MHz / RB 9kHz for QP
Start ~ Stop Frequency	30MHz~1000MHz / RB 120kHz for QP



**3.4.2 TEST PROCEDURE**

- a. The measuring distance of at 3 m shall be used for measurements at frequency up to 1GHz. For frequencies above 1GHz, any suitable measuring distance may be used.
- b. The EUT was placed on the top of a rotating table 0.8 meters above the ground at a 3m meter open area test site. The table was rotated 360 degrees to determine the position of the highest radiation.
- c. The height of the equipment or of the substitution antenna shall be 0.8 m; the height of the test antenna shall vary between 1 m to 4 m.
- d. The initial step in collecting conducted emission data is a spectrum analyzer peak detector mode pre-scanning the measurement frequency range. Significant peaks are then marked and then Quasi Peak detector mode re-measured.
- e. If the Peak Mode measured value compliance with and lower than Quasi Peak Mode Limit, the EUT shall be deemed to meet QP Limits and then no additional QP Mode measurement performed.
- f. For the actual test configuration, please refer to the related Item –EUT Test Photos.

Note:

Both horizontal and vertical antenna polarities were tested and performed pretest to three orthogonal axis. The worst case emissions were reported

During the radiated emission test, the Spectrum Analyzer was set with the following configurations:

Frequency Band (MHz)	Function	Resolution bandwidth	Video Bandwidth
30 to 1000	Peak	100 kHz	100 kHz
Above 1000	Peak	1 MHz	1 MHz
	Average	1 MHz	10 Hz

**3.4.3 DEVIATION FROM TEST STANDARD**

No deviation

### 3.4.4 TEST SETUP

(A) Radiated Emission Test-Up Frequency Below 30MHz

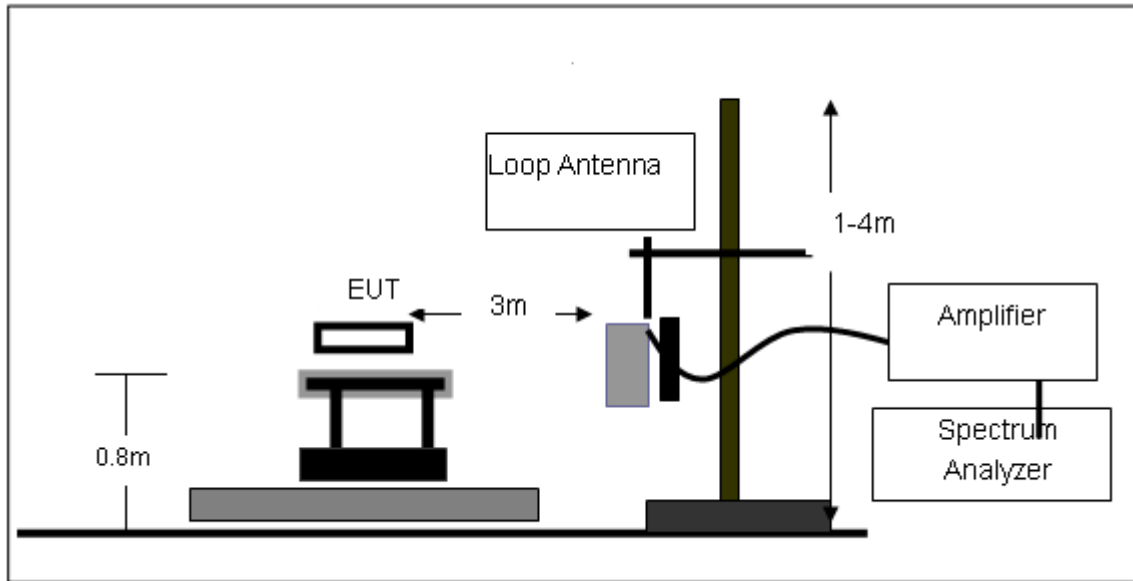

(B) Radiated Emission Test-Up Frequency 30MHz~1GHz

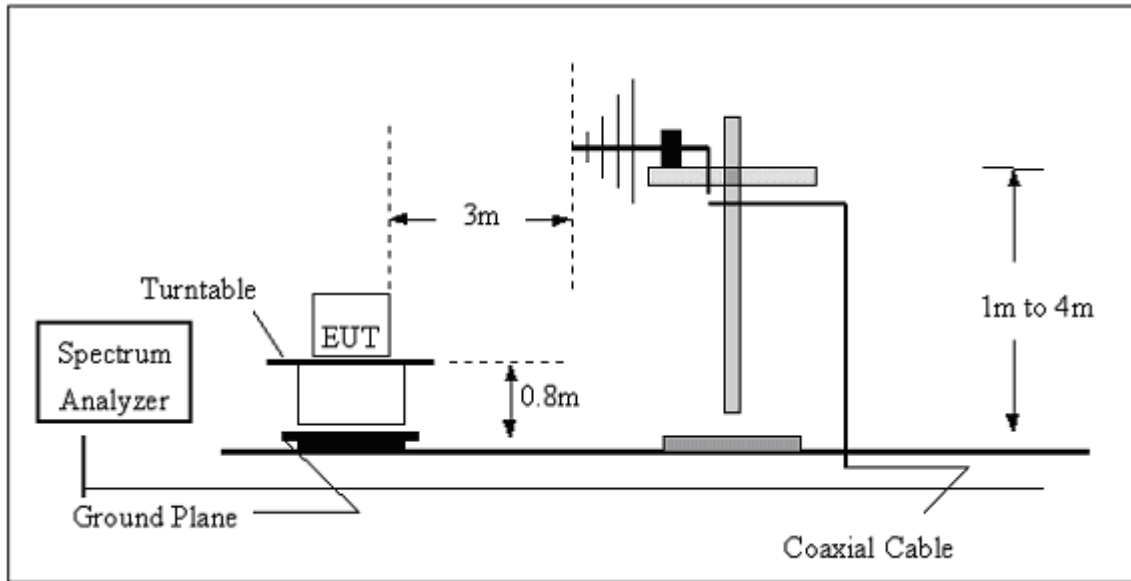

(C) Radiated Emission Test-Up Frequency Above 1GHz

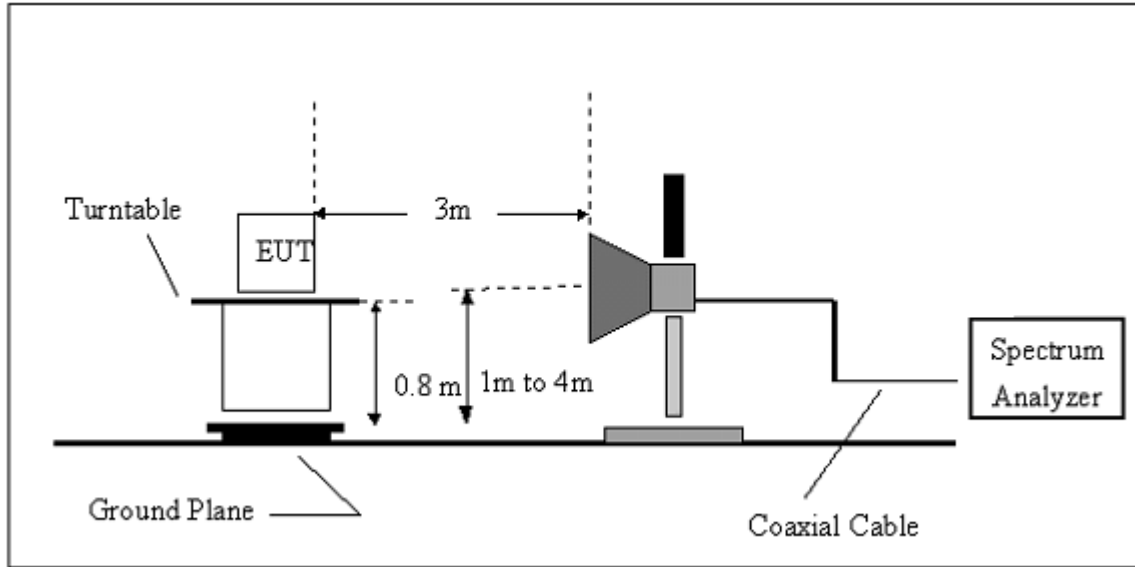

**3.4.5 TEST RESULTS (BLOW 30MHz)**

EUT :	2.4G RF module with amplifier	Model Name. :	RF2401F20
Temperature :	20 °C	Relative Humidity :	48%
Pressure :	1010 hPa	Test Voltage :	DC 5.0V
Test Mode :	TX	Polarization :	--

Freq.	Reading	Limit	Margin	State
(MHz)	(dBuV/m)	(dBuV/m)	(dB)	P/F
--	--	--	--	PASS
--	--	--	--	PASS

**NOTE:**

The amplitude of spurious emissions which are attenuated by more than 20dB below the permissible value has no need to be reported.

Distance extrapolation factor =  $20 \log (\text{specific distance}/\text{test distance})(\text{dB})$ ;

Limit line = specific limits(dBuv) + distance extrapolation factor.

### 3.4.6 TEST RESULTS (BETWEEN 30 – 1000 MHZ)

EUT :	2.4G RF module with amplifier	Model Name :	RF2401F20
Temperature :	20 °C	Relative Humidity :	48%
Pressure :	1010 hPa	Test Voltage :	DC 5.0V
Test Mode :	TX	Polarization :	Vertical

Frequency (MHz)	Meter Reading (dBμV)	Factor (dB)	Emission Level (dBμV/m)	Limits (dBμV/m)	Margin (dB)	Remark
32.4059	6.17	18.11	24.28	40.00	-15.72	QP
110.5687	10.48	10.07	20.55	43.50	-22.95	QP
126.7723	19.31	11.96	31.27	43.50	-12.23	QP
419.1081	7.14	18.69	25.83	46.00	-20.17	QP
647.3856	8.35	23.36	31.71	46.00	-14.29	QP

Remark:

1. Factor = Antenna Factor + Cable Loss – Pre-amplifier.

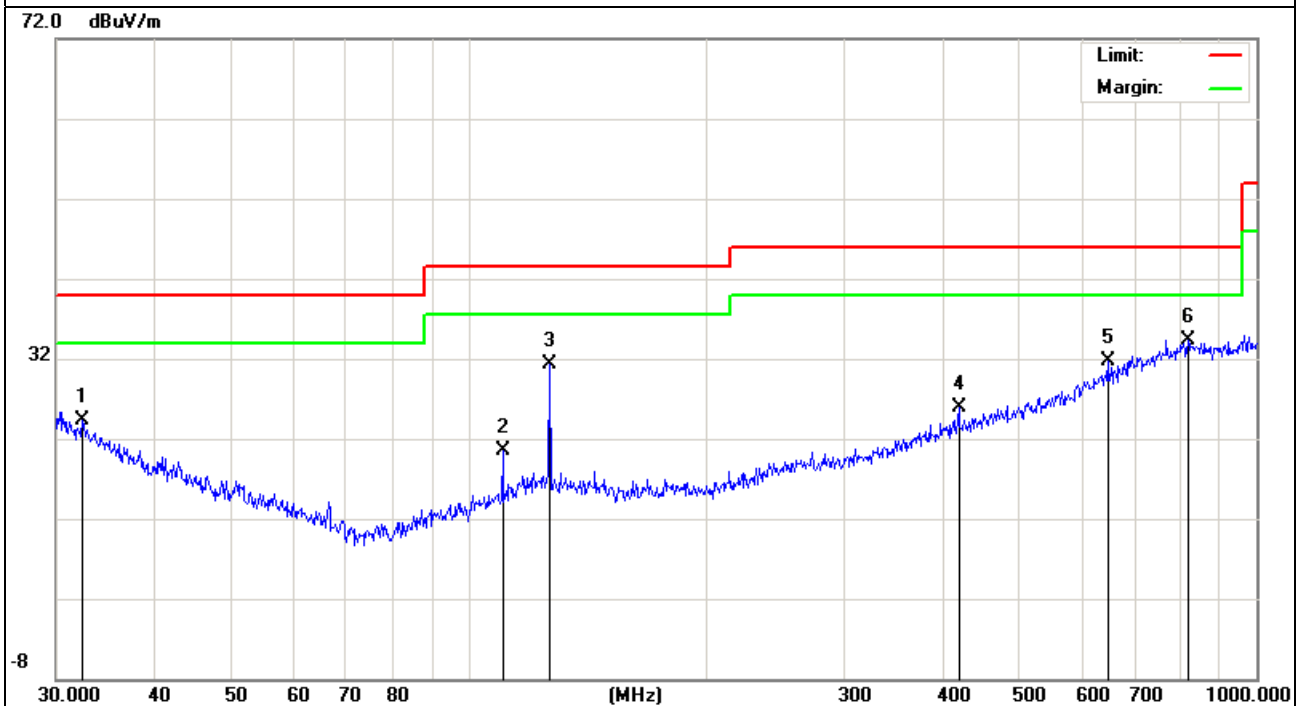

EUT :	2.4G RF module with amplifier	Model Name :	RF2401F20
Temperature :	20 °C	Relative Humidity :	48%
Pressure :	1010 hPa	Test Voltage :	DC 5.0V
Test Mode :	TX	Polarization :	Vertical

Frequency (MHz)	Meter Reading (dBμV)	Factor (dB)	Emission Level (dBμV/m)	Limits (dBμV/m)	Margin (dB)	Remark
38.7518	5.95	14.32	20.27	40.00	-19.73	QP
131.2965	5.99	11.83	17.82	43.50	-25.68	QP
169.5989	7.57	10.55	18.12	43.50	-25.38	QP
535.7073	6.62	21.04	27.66	46.00	-18.34	QP
810.2653	6.83	27.38	34.21	46.00	-11.79	QP
993.0113	6.67	27.53	34.2	54.00	-19.8	QP

Remark:

1. Factor = Antenna Factor + Cable Loss – Pre-amplifier.

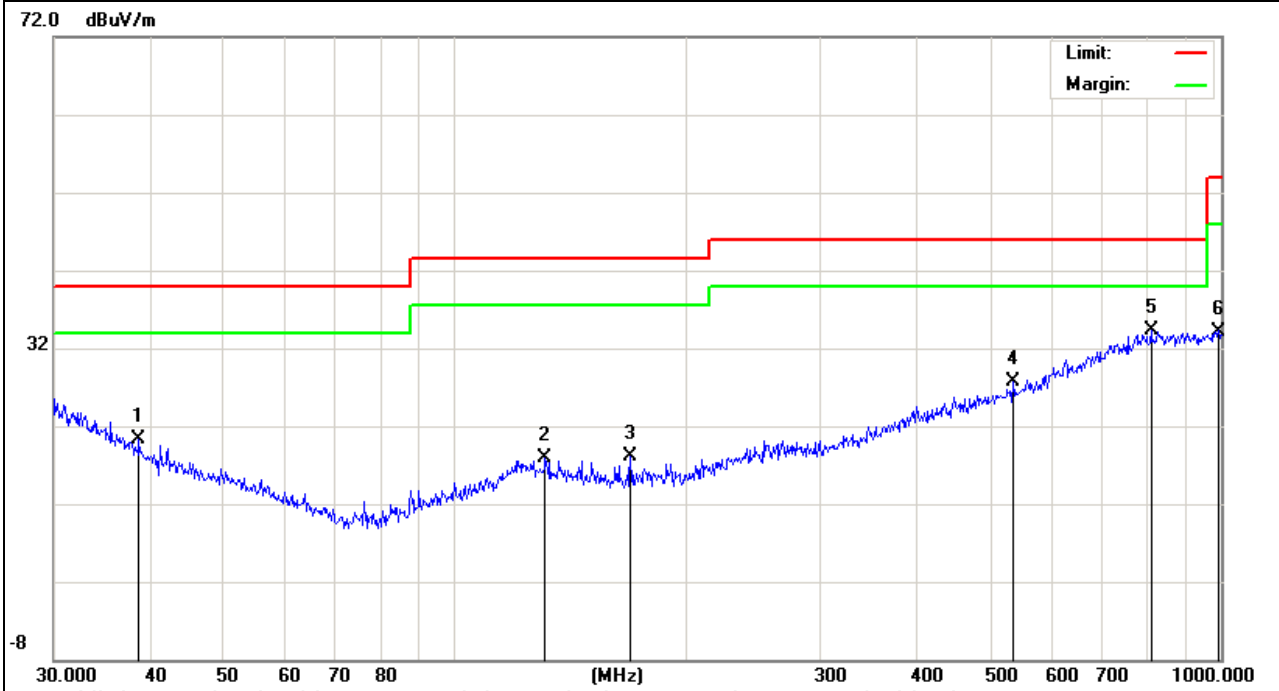

Note: All the modes had been tested, but only the worst data recorded in the report.

### 3.4.7 TEST RESULTS (ABOVE 1000 MHZ)

EUT :	2.4G RF module with amplifier	Model Name :	RF2401F20
Temperature :	20 °C	Relative Humidity :	48%
Pressure :	1010 hPa	Test Voltage :	DC 5.0V
Test Mode :	TX-2402MHz/250Kbps	Polarization :	Horizontal

Frequency (MHz)	Meter Reading (dBμV)	Factor (dB)	Emission Level (dBμV/m)	Limits (dBμV/m)	Margin (dB)	Detector Type
2402.125	109.77	-7.74	102.03	114.0 0	-11.97	peak
2402.125	84.52	-7.74	76.78	94.00	-17.22	AVG
4782.500	68.00	1.48	69.48	74.00	-4.52	peak
4782.500	45.32	1.48	46.80	54.00	-7.20	AVG
7205.000	19.20	42.99	62.19	74.00	-11.81	peak
7205.000	5.77	42.99	48.76	54.00	-5.24	AVG
9627.500	23.09	46.01	69.10	74.00	-4.90	peak
9627.500	2.74	46.01	48.75	54.00	-5.25	AVG
12007.500	14.44	48.92	63.36	74.00	-10.64	peak
12007.500	1.66	48.92	50.58	54.00	-3.42	AVG
14430.000	12.88	51.62	64.50	74.00	-9.50	peak
14430.000	-3.22	51.62	48.40	54.00	-5.60	AVG

Remark:

Factor = Antenna Factor + Cable Loss – Pre-amplifier.

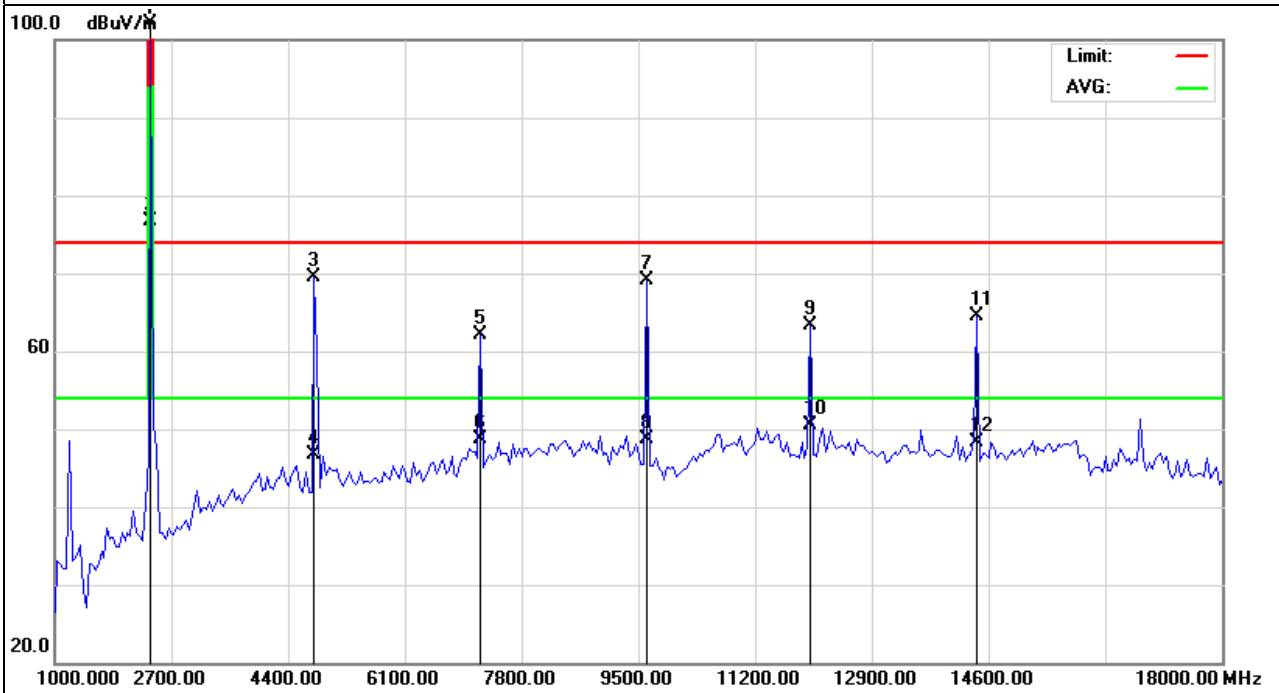

EUT :	2.4G RF module with amplifier	Model Name :	RF2401F20
Temperature :	20 °C	Relative Humidity :	48%
Pressure :	1010 hPa	Test Voltage :	DC 5.0V
Test Mode :	TX-2402MHz/250Kbps	Polarization :	Vertical

Frequency (MHz)	Meter Reading (dBμV)	Factor (dB)	Emission Level (dBμV/m)	Limits (dBμV/m)	Margin (dB)	Detector Type
2402.066	110.46	-7.74	102.72	114.00	-11.28	peak
2402.066	88.65	-7.74	80.91	94.00	-13.09	AVG
4782.500	66.14	1.48	67.62	74.00	-6.38	peak
4782.500	44.32	1.48	45.80	54.00	-8.20	AVG
7205.000	22.40	42.99	65.39	74.00	-8.61	peak
7205.000	6.55	42.99	49.54	54.00	-4.46	AVG
9627.500	23.33	46.01	69.34	74.00	-4.66	peak
9627.500	3.39	46.01	49.40	54.00	-4.60	AVG
12007.500	18.75	48.92	67.67	74.00	-6.33	peak
12007.500	1.33	48.92	50.25	54.00	-3.75	AVG
14430.000	14.47	51.62	66.09	74.00	-7.91	peak
14430.000	-3.39	51.62	48.23	54.00	-5.77	AVG

Remark:  
Factor = Antenna Factor + Cable Loss – Pre-amplifier.

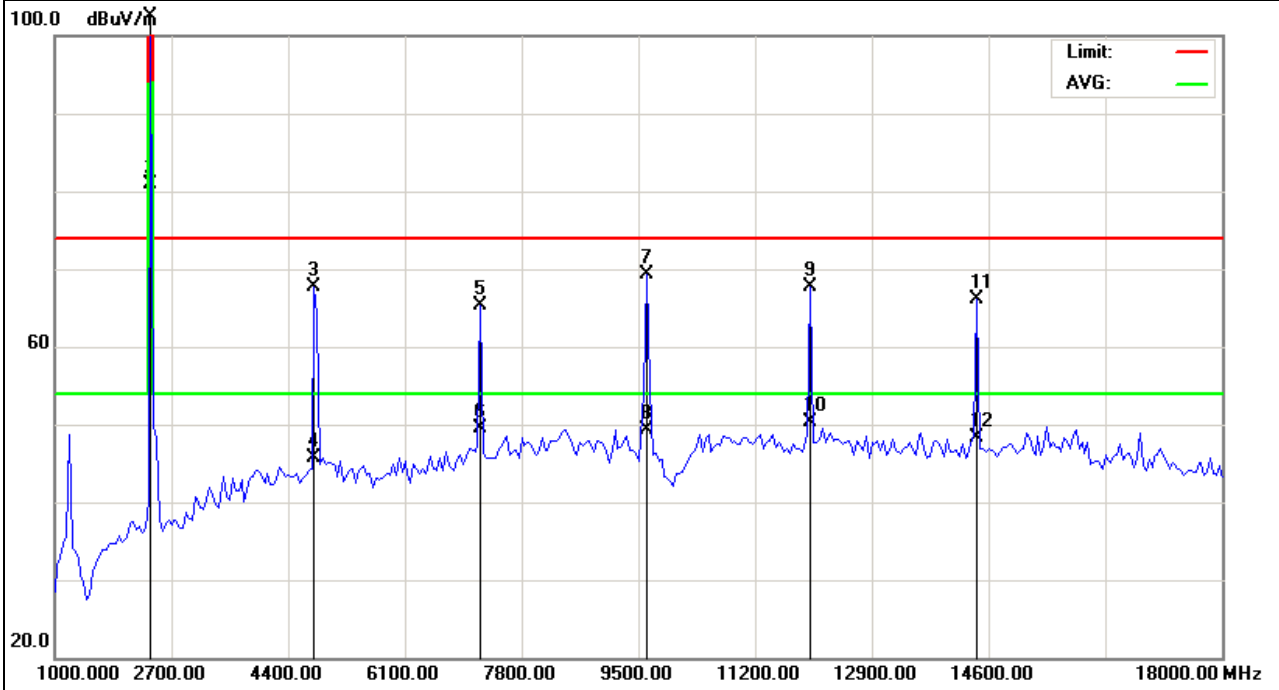



EUT :	2.4G RF module with amplifier	Model Name :	RF2401F20
Temperature :	20 °C	Relative Humidity :	48%
Pressure :	1010 hPa	Test Voltage :	DC 5.0V
Test Mode :	TX-2441MHz/250Kbps	Polarization :	Horizontal

Frequency (MHz)	Meter Reading (dBμV)	Factor (dB)	Emission Level (dBμV/m)	Limits (dBμV/m)	Margin (dB)	Detector Type
2441.315	109.66	-7.68	101.98	114.00	-12.02	peak
2441.315	85.26	-7.68	77.58	94.00	-16.42	AVG
4867.500	66.87	1.88	68.75	74.00	-5.25	peak
4867.500	46.31	1.88	48.19	54.00	-5.81	AVG
7332.500	25.22	43.41	68.63	74.00	-5.37	peak
7332.500	7.48	43.41	50.89	54.00	-3.11	AVG
9755.000	25.04	44.93	69.97	74.00	-4.03	peak
9755.000	2.41	44.93	47.34	54.00	-6.66	AVG
12220.000	20.97	48.44	69.41	74.00	-4.59	peak
12220.000	0.33	48.44	48.77	54.00	-5.23	AVG
14642.500	16.68	51.71	68.39	74.00	-5.61	peak
14642.500	-4.85	51.71	46.86	54.00	-7.14	AVG

Remark:  
 Factor = Antenna Factor + Cable Loss – Pre-amplifier.

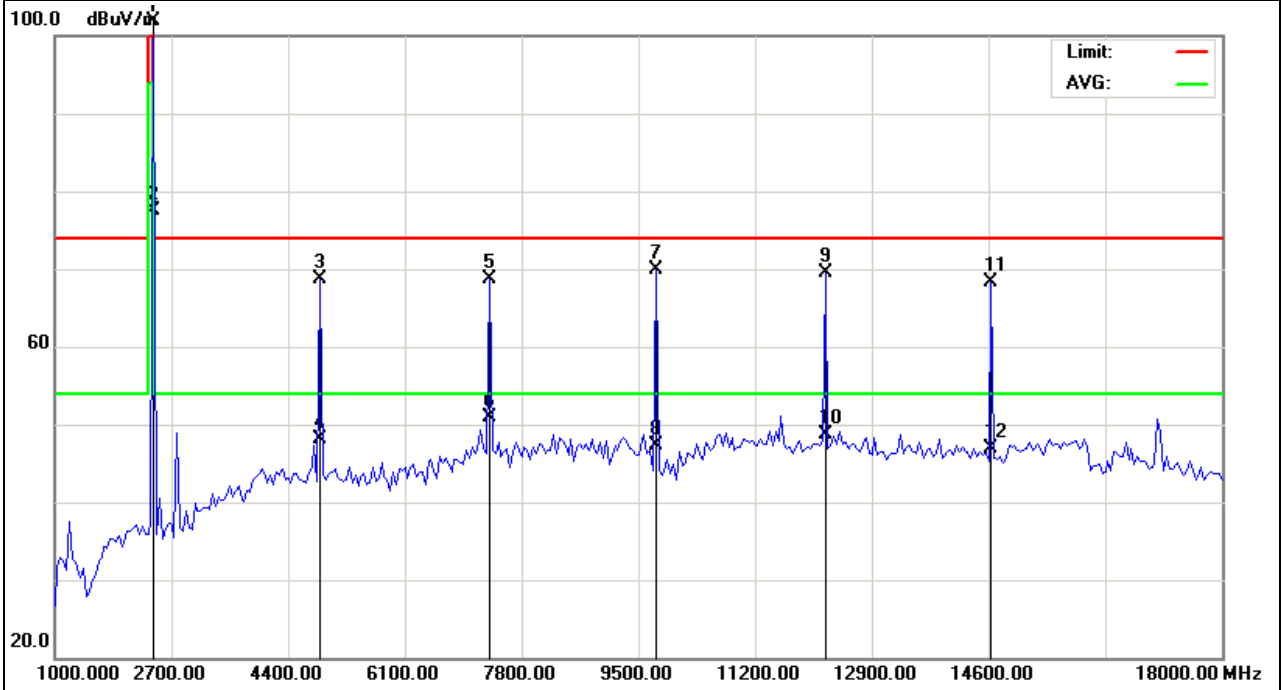

EUT :	2.4G RF module with amplifier	Model Name :	RF2401F20
Temperature :	20 °C	Relative Humidity :	48%
Pressure :	1010 hPa	Test Voltage :	DC 5.0V
Test Mode :	TX-2441MHz/250Kbps	Polarization :	Vertical

Frequency (MHz)	Meter Reading (dBμV)	Factor (dB)	Emission Level (dBμV/m)	Limits (dBμV/m)	Margin (dB)	Detector Type
2441.227	109.91	-7.68	102.23	114.00	-11.77	peak
2441.227	85.23	-7.68	77.55	94.00	-16.45	AVG
4867.500	67.25	1.88	69.13	74.00	-4.87	peak
4867.500	46.57	1.88	48.45	54.00	-5.55	AVG
7332.500	26.25	43.41	69.66	74.00	-4.34	peak
7332.500	7.46	43.41	50.87	54.00	-3.13	AVG
9755.000	24.46	44.93	69.39	74.00	-4.61	peak
9755.000	2.18	44.93	47.11	54.00	-6.89	AVG
12220.000	21.04	48.44	69.48	74.00	-4.52	peak
12220.000	0.42	48.44	48.86	54.00	-5.14	AVG
14642.500	10.74	51.71	62.45	74.00	-11.55	peak
14642.500	-5.11	51.71	46.60	54.00	-7.40	AVG

Remark:  
 Factor = Antenna Factor + Cable Loss – Pre-amplifier.

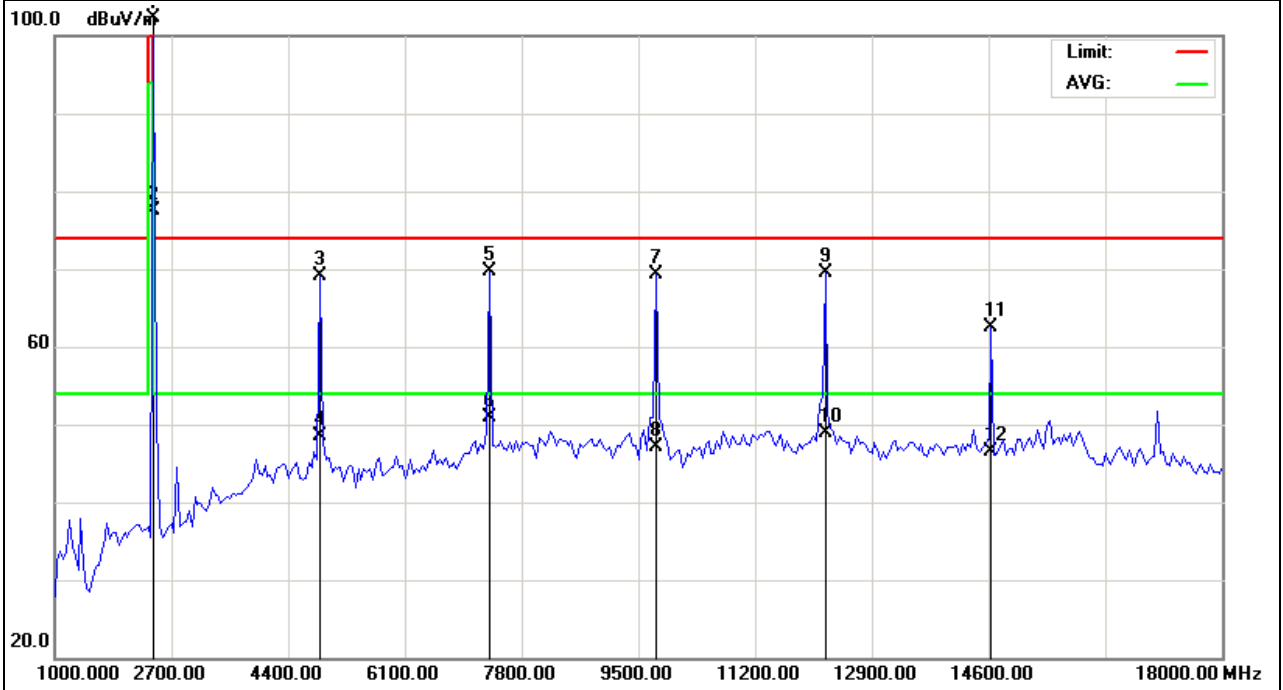

EUT :	2.4G RF module with amplifier	Model Name :	RF2401F20
Temperature :	20 °C	Relative Humidity :	48%
Pressure :	1010 hPa	Test Voltage :	DC 5.0V
Test Mode :	TX-2480MHz/250Kbps	Polarization :	Horizontal

Frequency (MHz)	Meter Reading (dBμV)	Factor (dB)	Emission Level (dBμV/m)	Limits (dBμV/m)	Margin (dB)	Detector Type
2480.214	112.62	-7.54	105.08	114.00	-8.92	peak
2480.214	86.25	-7.54	78.71	94.00	-15.29	AVG
4952.500	66.20	2.03	68.23	74.00	-5.77	peak
4952.500	46.31	2.03	48.34	54.00	-5.66	AVG
7460.000	22.76	43.83	66.59	74.00	-7.41	peak
7460.000	6.18	43.83	50.01	54.00	-3.99	AVG
9925.000	15.06	45.50	60.56	74.00	-13.44	peak
9925.000	2.33	45.50	47.83	54.00	-6.17	AVG
12390.000	19.17	49.12	68.29	74.00	-5.71	peak
12390.000	0.26	49.12	49.38	54.00	-4.62	AVG
14897.500	11.65	49.91	61.56	74.00	-12.44	peak
14897.500	-2.34	49.91	47.57	54.00	-6.43	AVG

Remark:  
Factor = Antenna Factor + Cable Loss – Pre-amplifier.

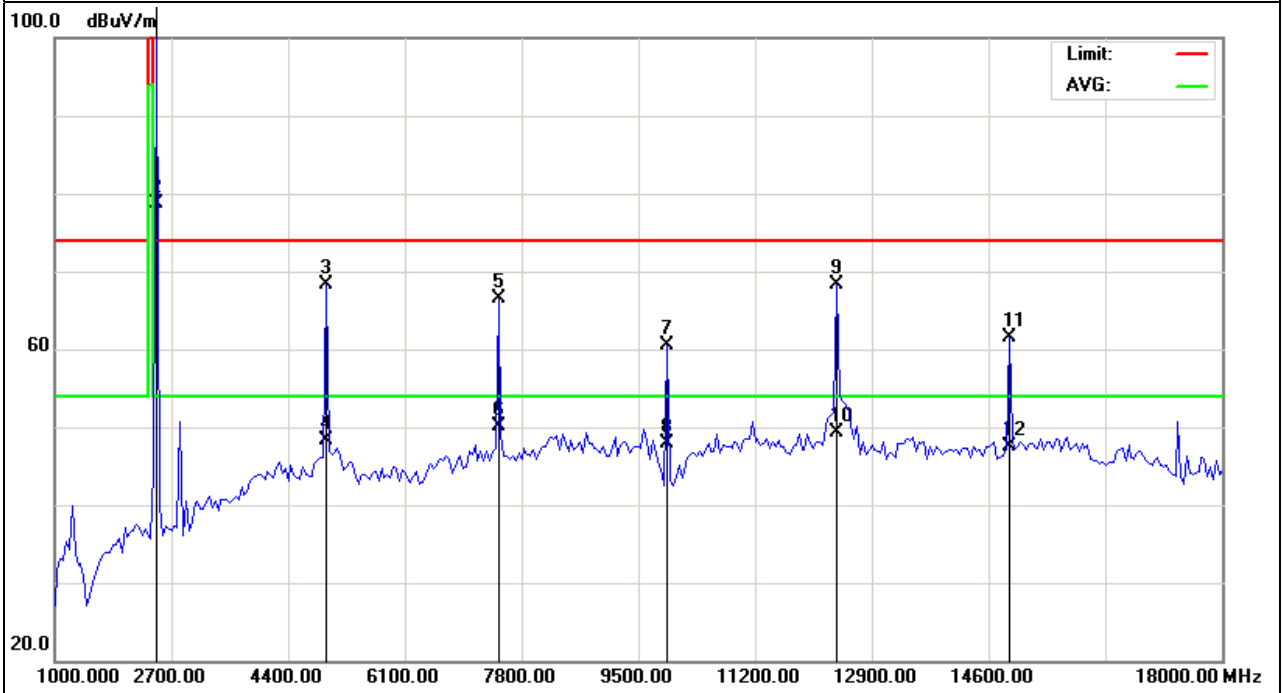

EUT :	2.4G RF module with amplifier	Model Name :	RF2401F20
Temperature :	20 °C	Relative Humidity :	48%
Pressure :	1010 hPa	Test Voltage :	DC 5.0V
Test Mode :	TX-2480MHz/250Kbps	Polarization :	Vertical

Frequency (MHz)	Meter Reading (dBμV)	Factor (dB)	Emission Level (dBμV/m)	Limits (dBμV/m)	Margin (dB)	Detector Type
2480.269	108.41	-7.54	100.87	114.00	-13.13	peak
2480.269	87.91	-7.54	80.37	94.00	-13.63	AVG
4952.500	58.88	2.03	60.91	74.00	-13.09	peak
4952.500	45.92	2.03	47.95	54.00	-6.05	AVG
7460.000	25.81	43.83	69.64	74.00	-4.36	peak
7460.000	6.94	43.83	50.77	54.00	-3.23	AVG
9925.000	16.48	45.50	61.98	74.00	-12.02	peak
9925.000	3.31	45.50	48.81	54.00	-5.19	AVG
12390.000	20.18	49.12	69.30	74.00	-4.70	peak
12390.000	0.88	49.12	50.00	54.00	-4.00	AVG
14897.500	18.58	49.91	68.49	74.00	-5.51	peak
14897.500	-2.05	49.91	47.86	54.00	-6.14	AVG

Remark:  
 Factor = Antenna Factor + Cable Loss – Pre-amplifier.

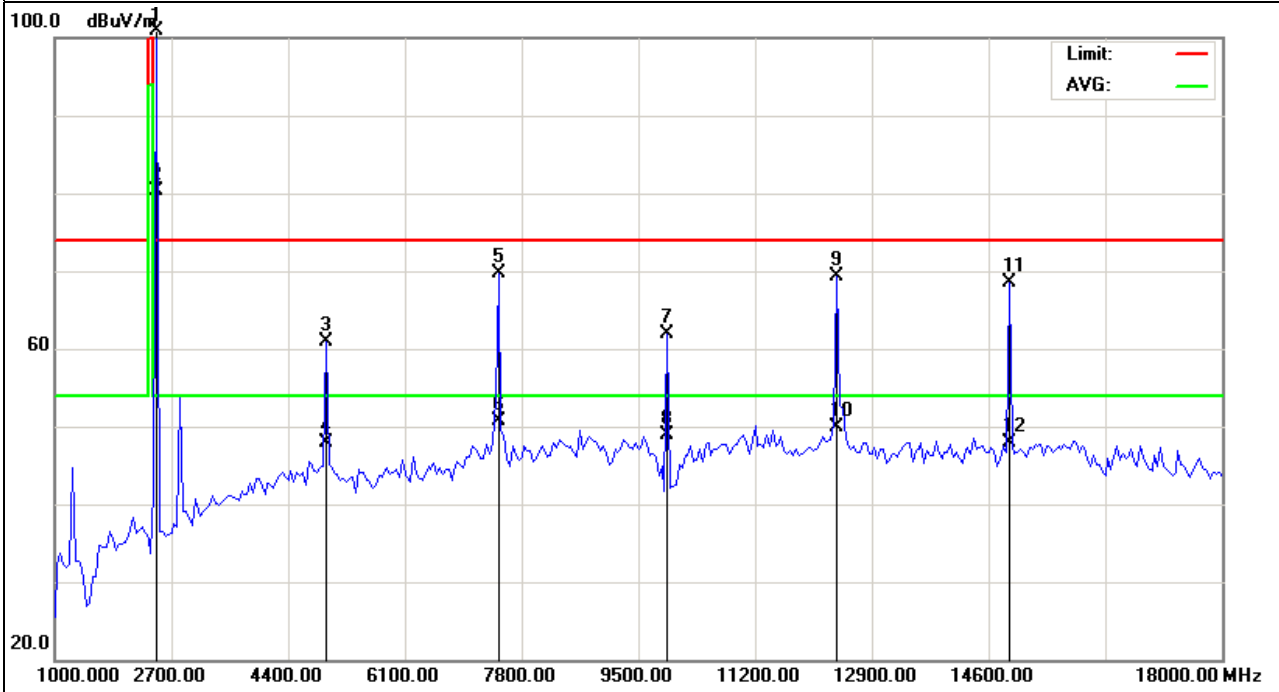

EUT :	2.4G RF module with amplifier	Model Name :	RF2401F20
Temperature :	20 °C	Relative Humidity :	48%
Pressure :	1010 hPa	Test Voltage :	DC 5.0V
Test Mode :	TX-2402MHz/1Mbps	Polarization :	Horizontal

Frequency (MHz)	Meter Reading (dBμV)	Factor (dB)	Emission Level (dBμV/m)	Limits (dBμV/m)	Margin (dB)	Detector Type
2402.301	108.15	-7.74	100.41	114.00	-13.59	peak
2402.301	85.63	-7.74	77.89	94.00	-16.11	AVG
4782.500	68.66	1.48	70.14	74.00	-3.86	peak
4782.500	47.52	1.48	49.00	54.00	-5.00	AVG
7205.000	23.35	42.99	66.34	74.00	-7.66	peak
7205.000	5.42	42.99	48.41	54.00	-5.59	AVG
9627.500	23.83	46.01	69.84	74.00	-4.16	peak
9627.500	1.22	46.01	47.23	54.00	-6.77	AVG
12007.500	20.89	48.92	69.81	74.00	-4.19	peak
12007.500	0.33	48.92	49.25	54.00	-4.75	AVG
14430.000	7.72	51.62	59.34	74.00	-14.66	peak
14430.000	-4.68	51.62	46.94	54.00	-7.06	AVG

Remark:  
Factor = Antenna Factor + Cable Loss – Pre-amplifier.

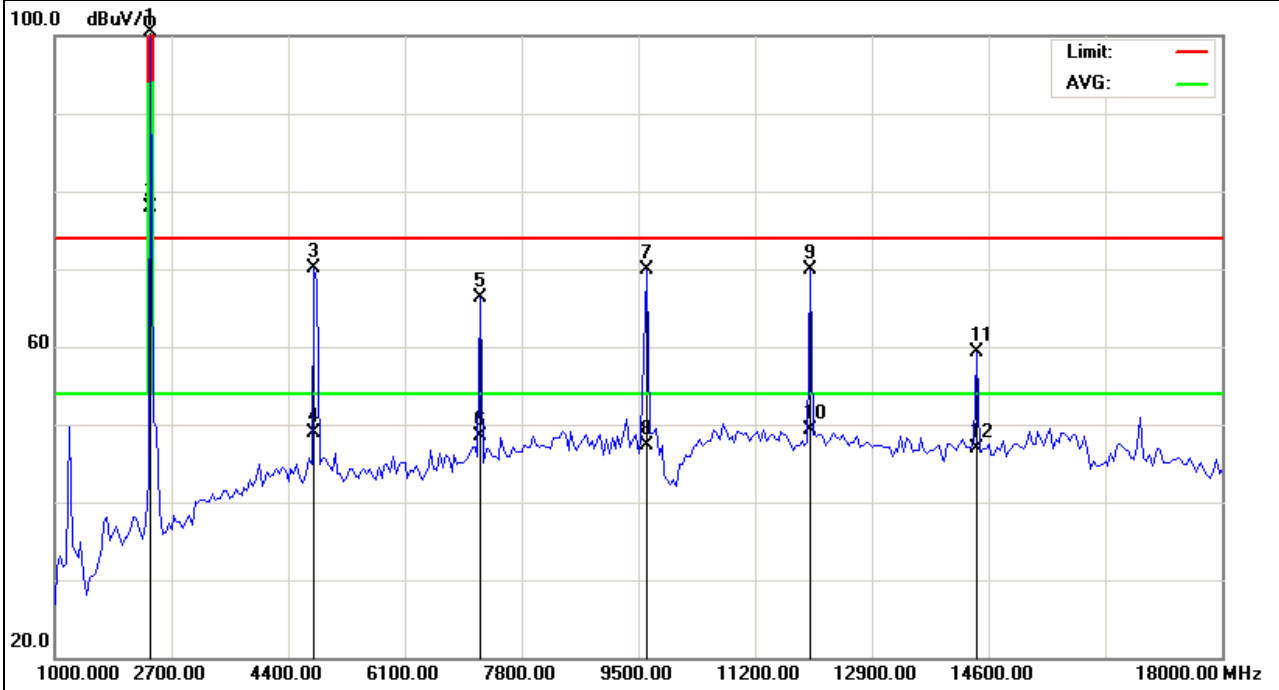

EUT :	2.4G RF module with amplifier	Model Name :	RF2401F20
Temperature :	20 °C	Relative Humidity :	48%
Pressure :	1010 hPa	Test Voltage :	DC 5.0V
Test Mode :	TX-2402MHz/1Mbps	Polarization :	Vertical

Frequency (MHz)	Meter Reading (dBμV)	Factor (dB)	Emission Level (dBμV/m)	Limits (dBμV/m)	Margin (dB)	Detector Type
2402.096	108.62	-7.74	100.88	114.00	-13.12	peak
2402.096	85.31	-7.74	77.57	94.00	-16.43	AVG
4782.500	61.14	1.48	62.62	74.00	-11.38	peak
4782.500	48.25	1.48	49.73	54.00	-4.27	AVG
7205.000	21.20	42.99	64.19	74.00	-9.81	peak
7205.000	7.66	42.99	50.65	54.00	-3.35	AVG
9627.500	21.56	46.01	67.57	74.00	-6.43	peak
9627.500	2.18	46.01	48.19	54.00	-5.81	AVG
12007.500	18.63	48.92	67.55	74.00	-6.45	peak
12007.500	1.05	48.92	49.97	54.00	-4.03	AVG
14430.000	16.40	51.62	68.02	74.00	-5.98	peak
14430.000	-4.22	51.62	47.40	54.00	-6.60	AVG

Remark:  
Factor = Antenna Factor + Cable Loss – Pre-amplifier.

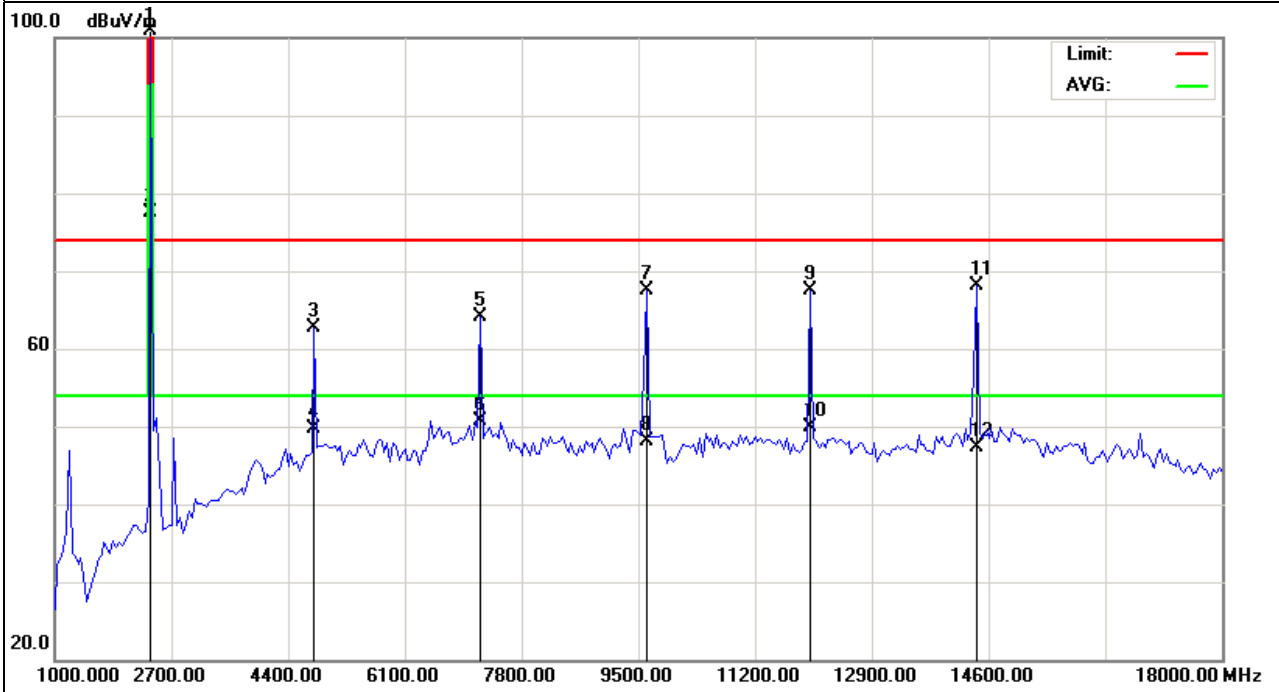

EUT :	2.4G RF module with amplifier	Model Name :	RF2401F20
Temperature :	20 °C	Relative Humidity :	48%
Pressure :	1010 hPa	Test Voltage :	DC 5.0V
Test Mode :	TX-2441MHz/1Mbps	Polarization :	Horizontal

Frequency (MHz)	Meter Reading (dBμV)	Factor (dB)	Emission Level (dBμV/m)	Limits (dBμV/m)	Margin (dB)	Detector Type
2441.133	112.72	-7.68	105.04	114.00	-8.96	peak
2441.133	88.39	-7.68	80.71	94.00	-13.29	AVG
4867.500	66.89	1.88	68.77	74.00	-5.23	peak
4867.500	47.92	1.88	49.80	54.00	-4.20	AVG
7332.500	24.48	43.41	67.89	74.00	-6.11	peak
7332.500	5.22	43.41	48.63	54.00	-5.37	AVG
9755.000	24.16	44.93	69.09	74.00	-4.91	peak
9755.000	3.33	44.93	48.26	54.00	-5.74	AVG
12220.000	20.79	48.44	69.23	74.00	-4.77	peak
12220.000	1.58	48.44	50.02	54.00	-3.98	AVG
14642.500	13.28	51.71	64.99	74.00	-9.01	peak
14642.500	-3.82	51.71	47.89	54.00	-6.11	AVG

Remark:  
 Factor = Antenna Factor + Cable Loss – Pre-amplifier.

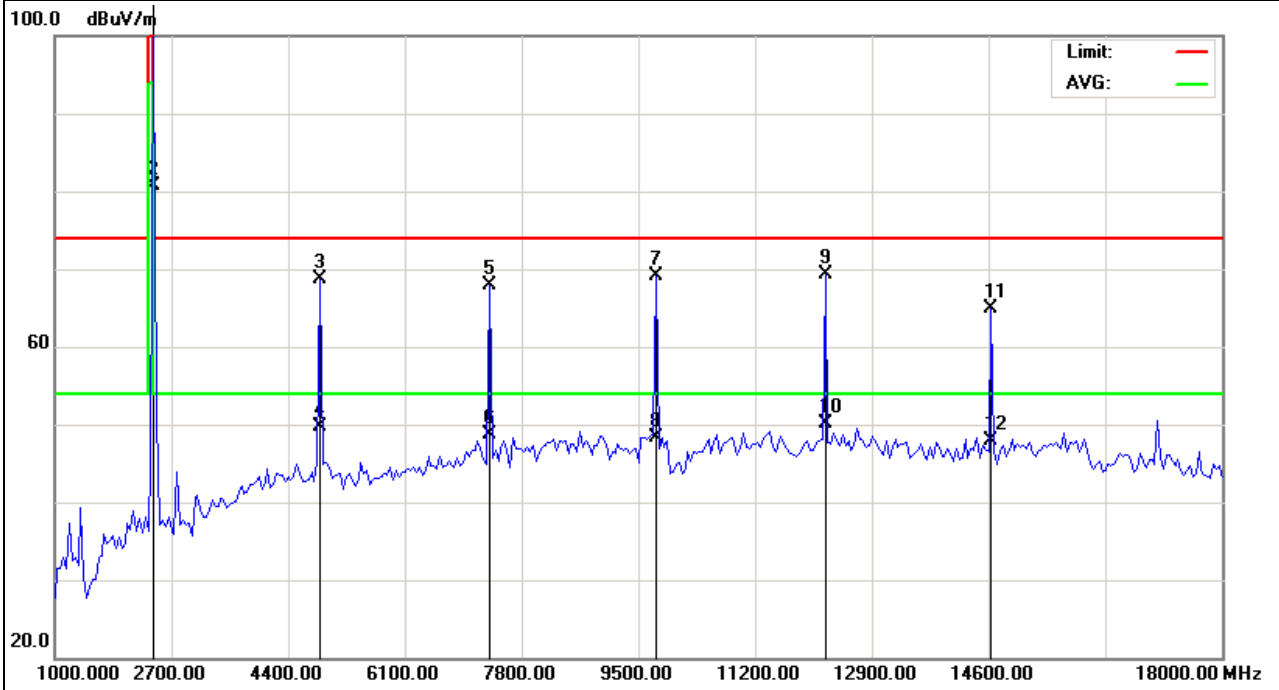

EUT :	2.4G RF module with amplifier	Model Name :	RF2401F20
Temperature :	20 °C	Relative Humidity :	48%
Pressure :	1010 hPa	Test Voltage :	DC 5.0V
Test Mode :	TX-2441MHz/1Mbps	Polarization :	Vertical

Frequency (MHz)	Meter Reading (dBμV)	Factor (dB)	Emission Level (dBμV/m)	Limits (dBμV/m)	Margin (dB)	Detector Type
2441.269	106.51	-7.68	98.83	114.00	-15.17	peak
2441.269	87.24	-7.68	79.56	94.00	-14.44	AVG
4867.500	66.57	1.88	68.45	74.00	-5.55	peak
4867.500	46.31	1.88	48.19	54.00	-5.81	AVG
7332.500	23.78	43.41	67.19	74.00	-6.81	peak
7332.500	6.58	43.41	49.99	54.00	-4.01	AVG
9755.000	24.73	44.93	69.66	74.00	-4.34	peak
9755.000	2.41	44.93	47.34	54.00	-6.66	AVG
12220.000	19.50	48.44	67.94	74.00	-6.06	peak
12220.000	0.33	48.44	48.77	54.00	-5.23	AVG
14642.500	14.65	51.71	66.36	74.00	-7.64	peak
14642.500	-4.12	51.71	47.59	54.00	-6.41	AVG

Remark:  
 Factor = Antenna Factor + Cable Loss – Pre-amplifier.

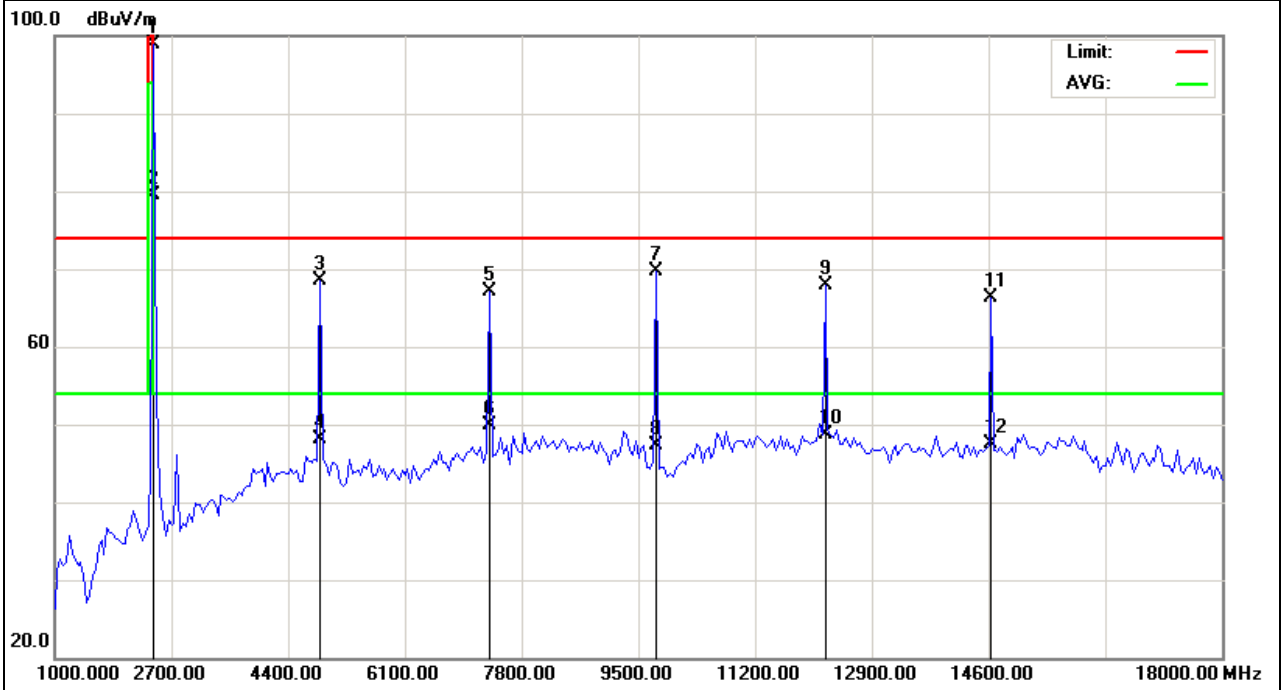



EUT :	2.4G RF module with amplifier	Model Name :	RF2401F20
Temperature :	20 °C	Relative Humidity :	48%
Pressure :	1010 hPa	Test Voltage :	DC 5.0V
Test Mode :	TX-2480MHz/1Mbps	Polarization :	Horizontal

Frequency (MHz)	Meter Reading (dBμV)	Factor (dB)	Emission Level (dBμV/m)	Limits (dBμV/m)	Margin (dB)	Detector Type
2480.055	111.02	-7.54	103.48	114.00	-10.52	peak
2480.055	85.29	-7.54	77.75	94.00	-16.25	AVG
4952.500	68.01	2.03	70.04	74.00	-3.96	peak
4952.500	46.98	2.03	49.01	54.00	-4.99	AVG
7460.000	25.61	43.83	69.44	74.00	-4.56	peak
7460.000	5.58	43.83	49.41	54.00	-4.59	AVG
9925.000	11.62	45.50	57.12	74.00	-16.88	peak
9925.000	2.29	45.50	47.79	54.00	-6.21	AVG
12390.000	21.66	49.12	70.78	74.00	-3.22	peak
12390.000	0.88	49.12	50.00	54.00	-4.00	AVG
14897.500	11.08	49.91	60.99	74.00	-13.01	peak
14897.500	-4.17	49.91	45.74	54.00	-8.26	AVG

Remark:  
Factor = Antenna Factor + Cable Loss – Pre-amplifier.

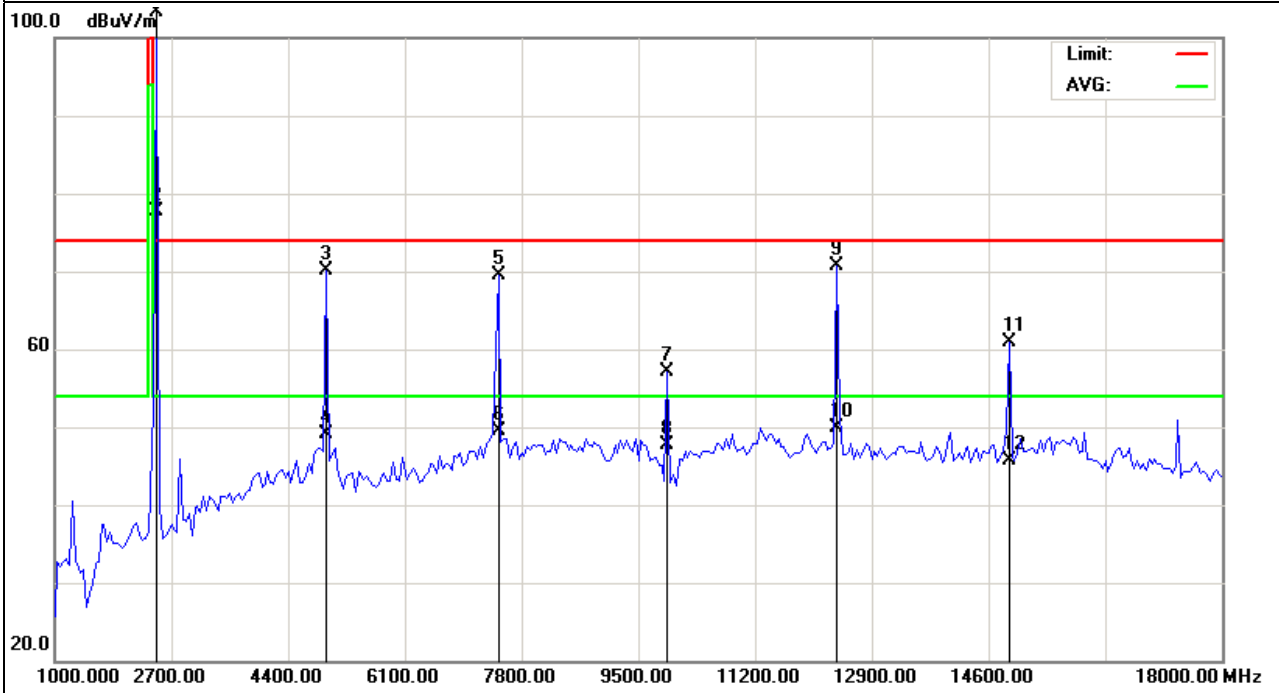

EUT :	2.4G RF module with amplifier	Model Name :	RF2401F20
Temperature :	20 °C	Relative Humidity :	48%
Pressure :	1010 hPa	Test Voltage :	DC 5.0V
Test Mode :	TX-2480MHz/1Mbps	Polarization :	Vertical

Frequency (MHz)	Meter Reading (dBμV)	Factor (dB)	Emission Level (dBμV/m)	Limits (dBμV/m)	Margin (dB)	Detector Type
2480.269	111.98	-7.54	104.44	114.00	-9.56	peak
2480.269	88.26	-7.54	80.72	94.00	-13.28	AVG
4952.500	66.58	2.03	68.61	74.00	-5.39	peak
4952.500	45.79	2.03	47.82	54.00	-6.18	AVG
7460.000	19.81	43.83	63.64	74.00	-10.36	peak
7460.000	6.88	43.83	50.71	54.00	-3.29	AVG
9925.000	11.77	45.50	57.27	74.00	-16.73	peak
9925.000	3.17	45.50	48.67	54.00	-5.33	AVG
12390.000	20.07	49.12	69.19	74.00	-4.81	peak
12390.000	0.58	49.12	49.70	54.00	-4.30	AVG
14897.500	8.03	49.91	57.94	74.00	-16.06	peak
14897.500	-2.79	49.91	47.12	54.00	-6.88	AVG

Remark:  
Factor = Antenna Factor + Cable Loss – Pre-amplifier.

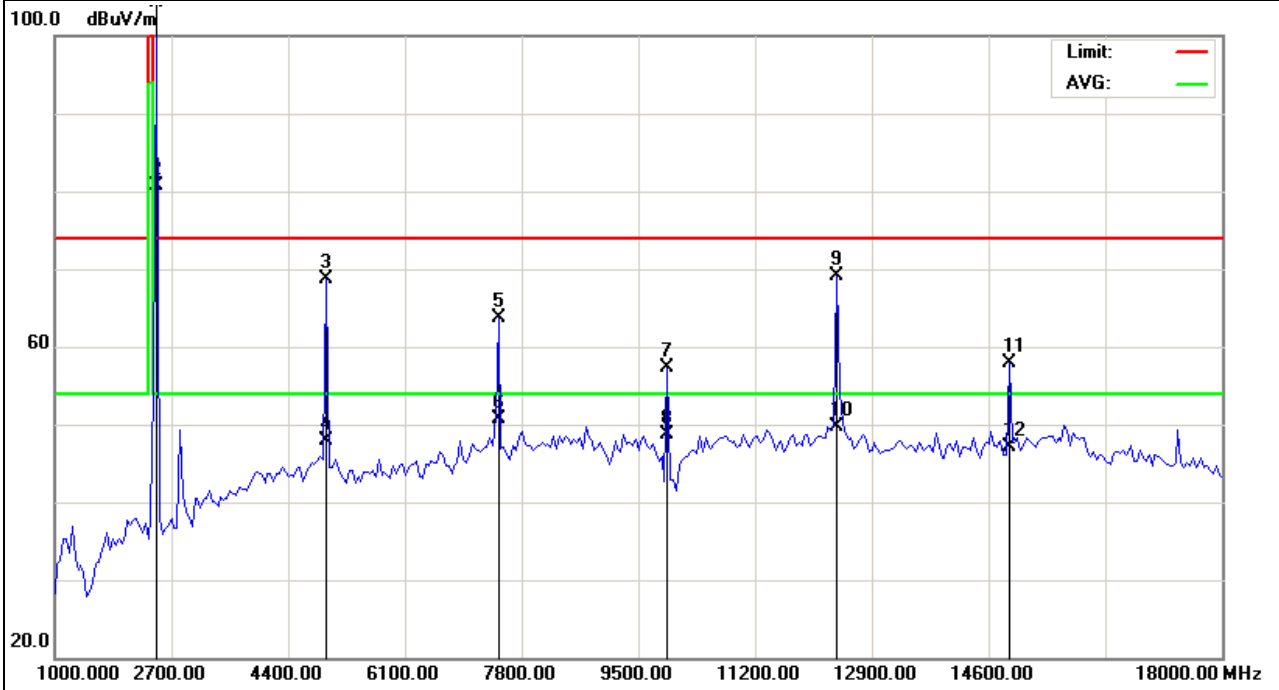

EUT :	2.4G RF module with amplifier	Model Name :	RF2401F20
Temperature :	20 °C	Relative Humidity :	48%
Pressure :	1010 hPa	Test Voltage :	DC 5.0V
Test Mode :	TX-2402MHz/2Mbps	Polarization :	Horizontal

Frequency (MHz)	Meter Reading (dBμV)	Factor (dB)	Emission Level (dBμV/m)	Limits (dBμV/m)	Margin (dB)	Detector Type
2402.122	109.04	-7.74	101.30	114.00	-12.70	peak
2402.122	88.52	-7.74	80.78	94.00	-13.22	AVG
4825.000	67.34	1.85	69.19	74.00	-4.81	peak
4825.000	46.59	1.85	48.44	54.00	-5.56	AVG
7205.000	22.29	42.99	65.28	74.00	-8.72	peak
7205.000	6.32	42.99	49.31	54.00	-4.69	AVG
9585.000	22.94	46.39	69.33	74.00	-4.67	peak
9585.000	3.66	46.39	50.05	54.00	-3.95	AVG
12007.500	17.86	48.92	66.78	74.00	-7.22	peak
12007.500	0.52	48.92	49.44	54.00	-4.56	AVG
14430.000	5.44	51.62	57.06	74.00	-16.94	peak
14430.000	-3.26	51.62	48.36	54.00	-5.64	AVG

Remark:  
 Factor = Antenna Factor + Cable Loss – Pre-amplifier.

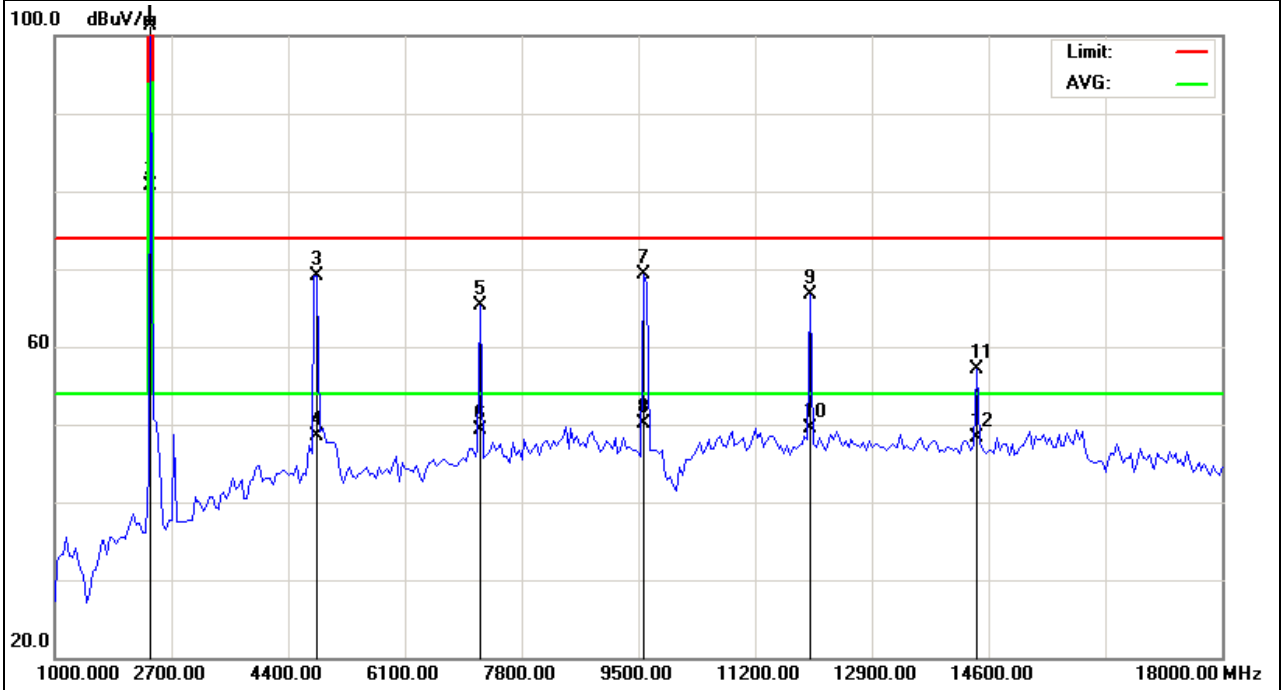

EUT :	2.4G RF module with amplifier	Model Name :	RF2401F20
Temperature :	20 °C	Relative Humidity :	48%
Pressure :	1010 hPa	Test Voltage :	DC 5.0V
Test Mode :	TX-2402MHz/2Mbps	Polarization :	Vertical

Frequency (MHz)	Meter Reading (dBμV)	Factor (dB)	Emission Level (dBμV/m)	Limits (dBμV/m)	Margin (dB)	Detector Type
2402.147	108.23	-7.74	100.49	114.00	-13.51	peak
2402.147	87.56	-7.74	79.82	94.00	-14.18	AVG
4782.500	67.40	1.48	68.88	74.00	-5.12	peak
4782.500	47.62	1.48	49.10	54.00	-4.90	AVG
7205.000	24.24	42.99	67.23	74.00	-6.77	peak
7205.000	5.66	42.99	48.65	54.00	-5.35	AVG
9627.500	23.17	46.01	69.18	74.00	-4.82	peak
9627.500	4.21	46.01	50.22	54.00	-3.78	AVG
12007.500	19.21	48.92	68.13	74.00	-5.87	peak
12007.500	1.06	48.92	49.98	54.00	-4.02	AVG
14430.000	9.30	51.62	60.92	74.00	-13.08	peak
14430.000	-4.22	51.62	47.40	54.00	-6.60	AVG

Remark:  
 Factor = Antenna Factor + Cable Loss – Pre-amplifier.

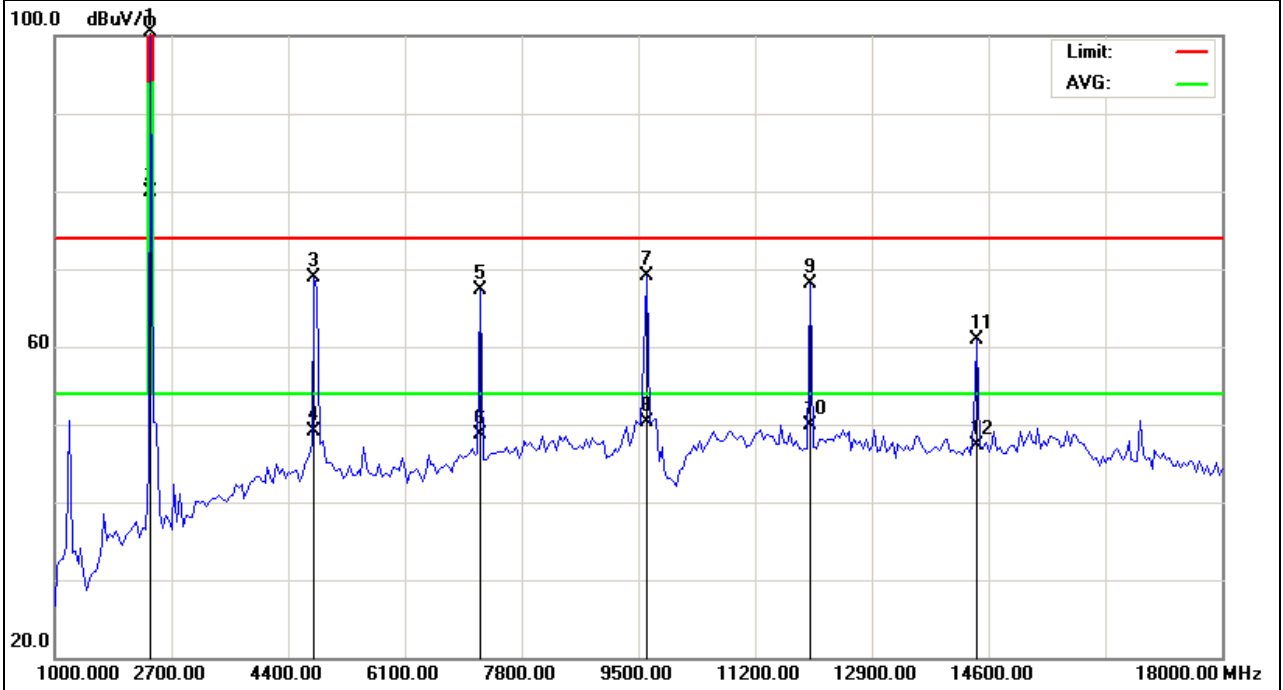

EUT :	2.4G RF module with amplifier	Model Name :	RF2401F20
Temperature :	20 °C	Relative Humidity :	48%
Pressure :	1010 hPa	Test Voltage :	DC 5.0V
Test Mode :	TX-2441MHz/2Mbps	Polarization :	Horizontal

Frequency (MHz)	Meter Reading (dBμV)	Factor (dB)	Emission Level (dBμV/m)	Limits (dBμV/m)	Margin (dB)	Detector Type
2441.123	112.33	-7.68	104.65	114.00	-9.35	peak
2441.123	87.29	-7.68	79.61	94.00	-14.39	AVG
4867.500	66.82	1.88	68.70	74.00	-5.30	peak
4867.500	48.53	1.88	50.41	54.00	-3.59	AVG
7332.500	20.39	43.41	63.80	74.00	-10.20	peak
7332.500	5.94	43.41	49.35	54.00	-4.65	AVG
9755.000	23.03	44.93	67.96	74.00	-6.04	peak
9755.000	1.33	44.93	46.26	54.00	-7.74	AVG
12220.000	21.41	48.44	69.85	74.00	-4.15	peak
12220.000	0.62	48.44	49.06	54.00	-4.94	AVG
14642.500	13.63	51.71	65.34	74.00	-8.66	peak
14642.500	-3.17	51.71	48.54	54.00	-5.46	AVG

Remark:  
 Factor = Antenna Factor + Cable Loss – Pre-amplifier.

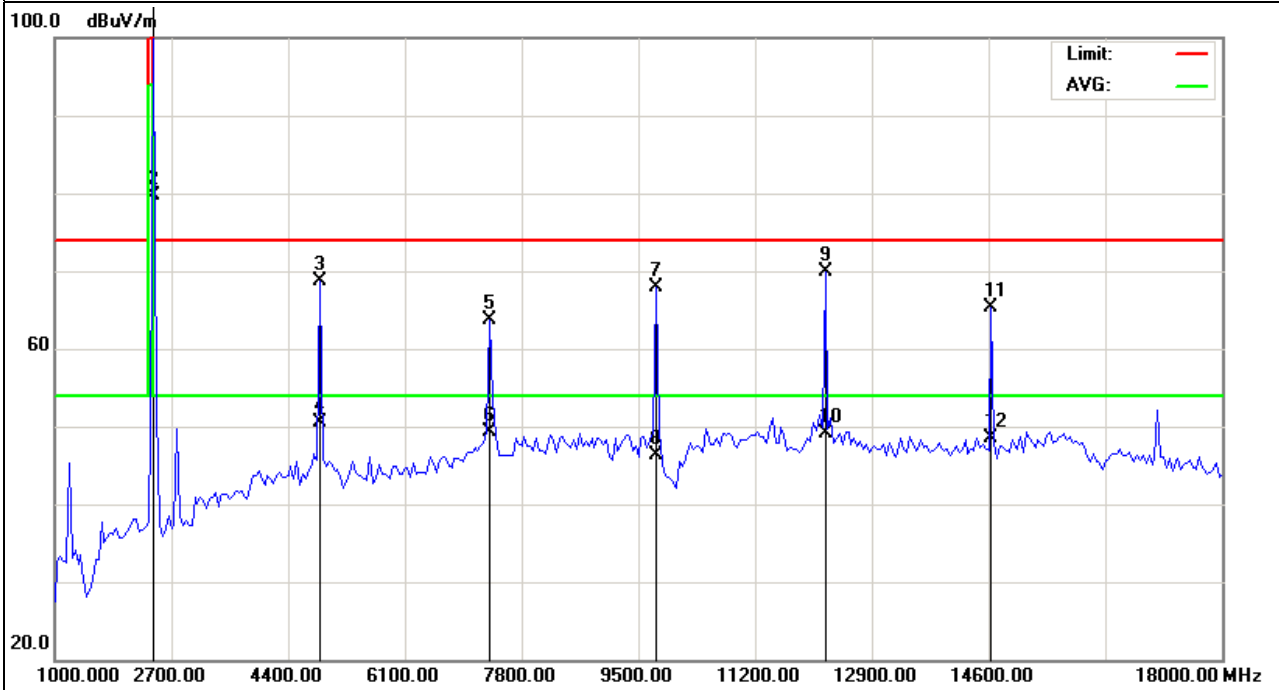

EUT :	2.4G RF module with amplifier	Model Name :	RF2401F20
Temperature :	20 °C	Relative Humidity :	48%
Pressure :	1010 hPa	Test Voltage :	DC 5.0V
Test Mode :	TX-2441MHz/2Mbps	Polarization :	Vertical

Frequency (MHz)	Meter Reading (dBμV)	Factor (dB)	Emission Level (dBμV/m)	Limits (dBμV/m)	Margin (dB)	Detector Type
2441.169	111.04	-7.68	103.36	114.00	-10.64	peak
2441.169	86.22	-7.68	78.54	94.00	-15.46	AVG
4867.500	66.34	1.88	68.22	74.00	-5.78	peak
4867.500	46.31	1.88	48.19	54.00	-5.81	AVG
7332.500	16.55	43.41	59.96	74.00	-14.04	peak
7332.500	6.58	43.41	49.99	54.00	-4.01	AVG
9755.000	24.15	44.93	69.08	74.00	-4.92	peak
9755.000	2.14	44.93	47.07	54.00	-6.93	AVG
12220.000	17.12	48.44	65.56	74.00	-8.44	peak
12220.000	0.33	48.44	48.77	54.00	-5.23	AVG
14642.500	10.73	51.71	62.44	74.00	-11.56	peak
14642.500	-3.16	51.71	48.55	54.00	-5.45	AVG

Remark:  
Factor = Antenna Factor + Cable Loss – Pre-amplifier.

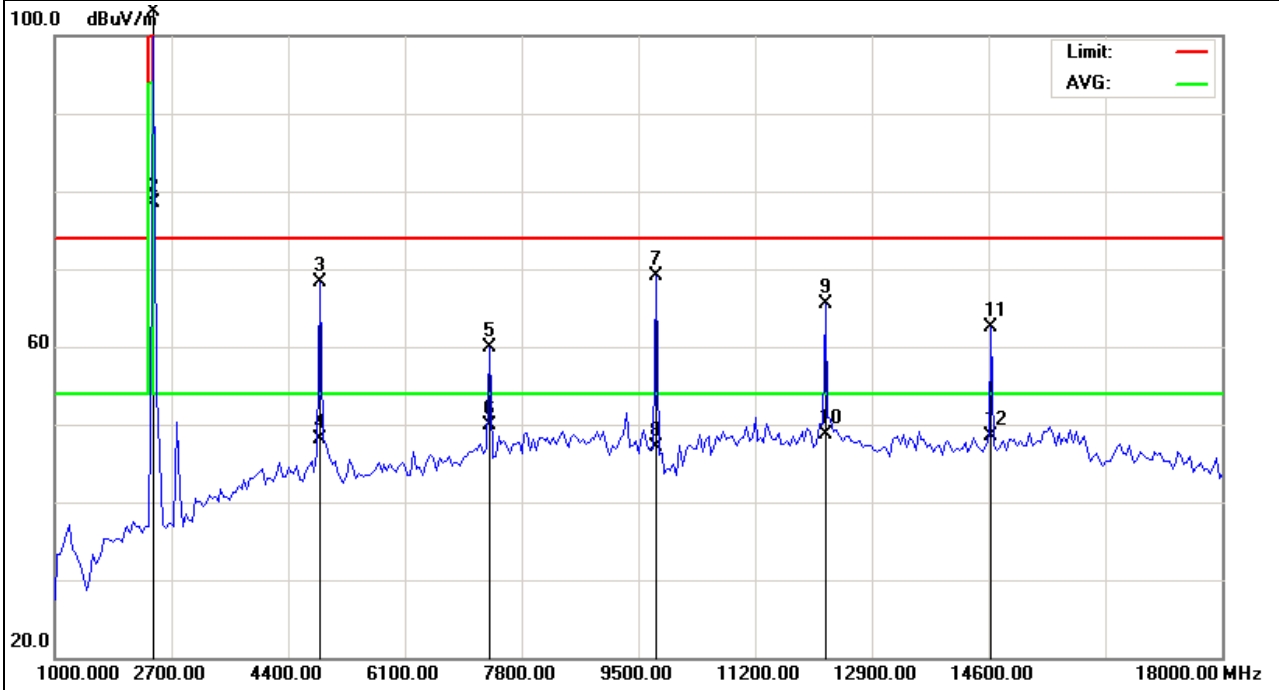

EUT :	2.4G RF module with amplifier	Model Name :	RF2401F20
Temperature :	20 °C	Relative Humidity :	48%
Pressure :	1010 hPa	Test Voltage :	DC 5.0V
Test Mode :	TX-2480MHz/2Mbps	Polarization :	Horizontal

Frequency (MHz)	Meter Reading (dBμV)	Factor (dB)	Emission Level (dBμV/m)	Limits (dBμV/m)	Margin (dB)	Detector Type
2480.124	111.58	-7.54	104.04	114.00	-9.96	peak
2480.124	84.27	-7.54	76.73	94.00	-17.27	AVG
4952.500	66.27	2.03	68.30	74.00	-5.70	peak
4952.500	46.33	2.03	48.36	54.00	-5.64	AVG
7460.000	19.15	43.83	62.98	74.00	-11.02	peak
7460.000	5.48	43.83	49.31	54.00	-4.69	AVG
9925.000	14.03	45.50	59.53	74.00	-14.47	peak
9925.000	2.11	45.50	47.61	54.00	-6.39	AVG
12390.000	18.54	49.12	67.66	74.00	-6.34	peak
12390.000	0.38	49.12	49.50	54.00	-4.50	AVG
14897.500	10.82	49.91	60.73	74.00	-13.27	peak
14897.500	-4.29	49.91	45.62	54.00	-8.38	AVG

Remark:  
Factor = Antenna Factor + Cable Loss – Pre-amplifier.

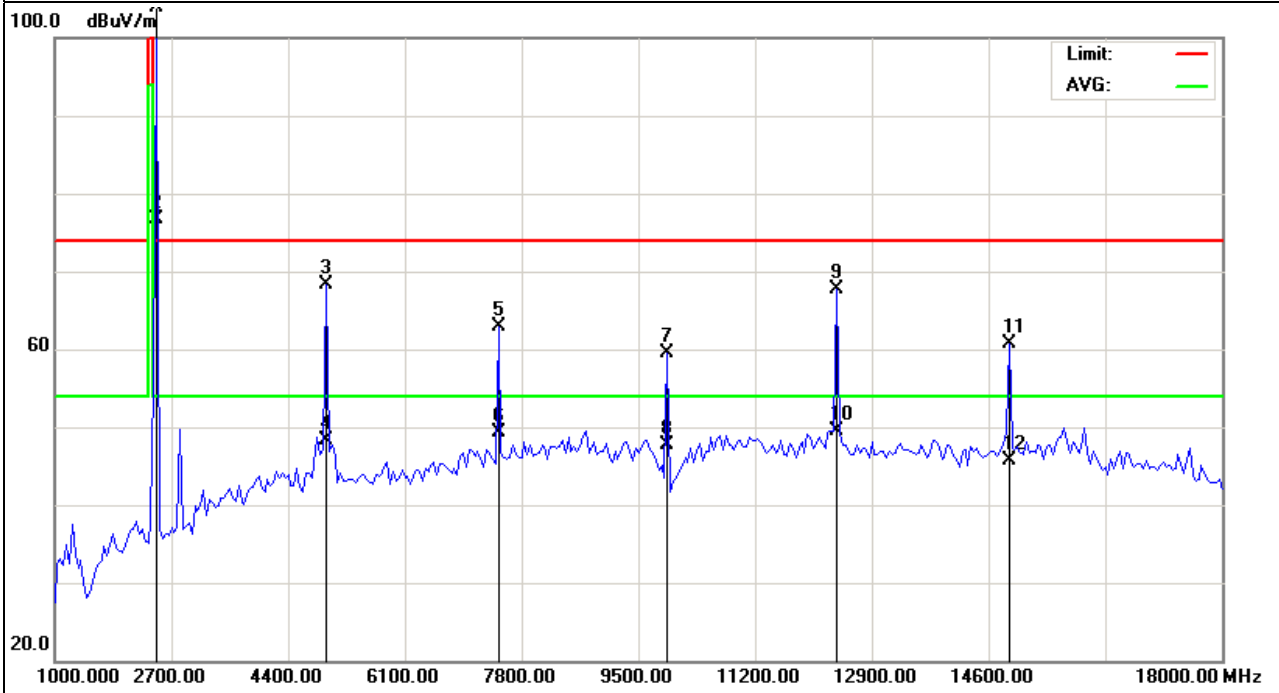

EUT :	2.4G RF module with amplifier	Model Name :	RF2401F20
Temperature :	20 °C	Relative Humidity :	48%
Pressure :	1010 hPa	Test Voltage :	DC 5.0V
Test Mode :	TX-2480MHz/2Mbps	Polarization :	Vertical

Frequency (MHz)	Meter Reading (dBμV)	Factor (dB)	Emission Level (dBμV/m)	Limits (dBμV/m)	Margin (dB)	Detector Type
2480.309	108.94	-7.54	101.40	114.00	-12.60	peak
2480.309	87.41	-7.54	79.87	94.00	-14.13	AVG
4952.500	64.94	2.03	66.97	74.00	-7.03	peak
4952.500	46.52	2.03	48.55	54.00	-5.45	AVG
7460.000	20.19	43.83	64.02	74.00	-9.98	peak
7460.000	6.10	43.83	49.93	54.00	-4.07	AVG
9925.000	16.06	45.50	61.56	74.00	-12.44	peak
9925.000	3.44	45.50	48.94	54.00	-5.06	AVG
12390.000	19.03	49.12	68.15	74.00	-5.85	peak
12390.000	0.58	49.12	49.70	54.00	-4.30	AVG
14897.500	3.65	49.91	53.56	74.00	-20.44	peak
14897.500	-2.17	49.91	47.74	54.00	-6.26	AVG

Remark:  
Factor = Antenna Factor + Cable Loss – Pre-amplifier.

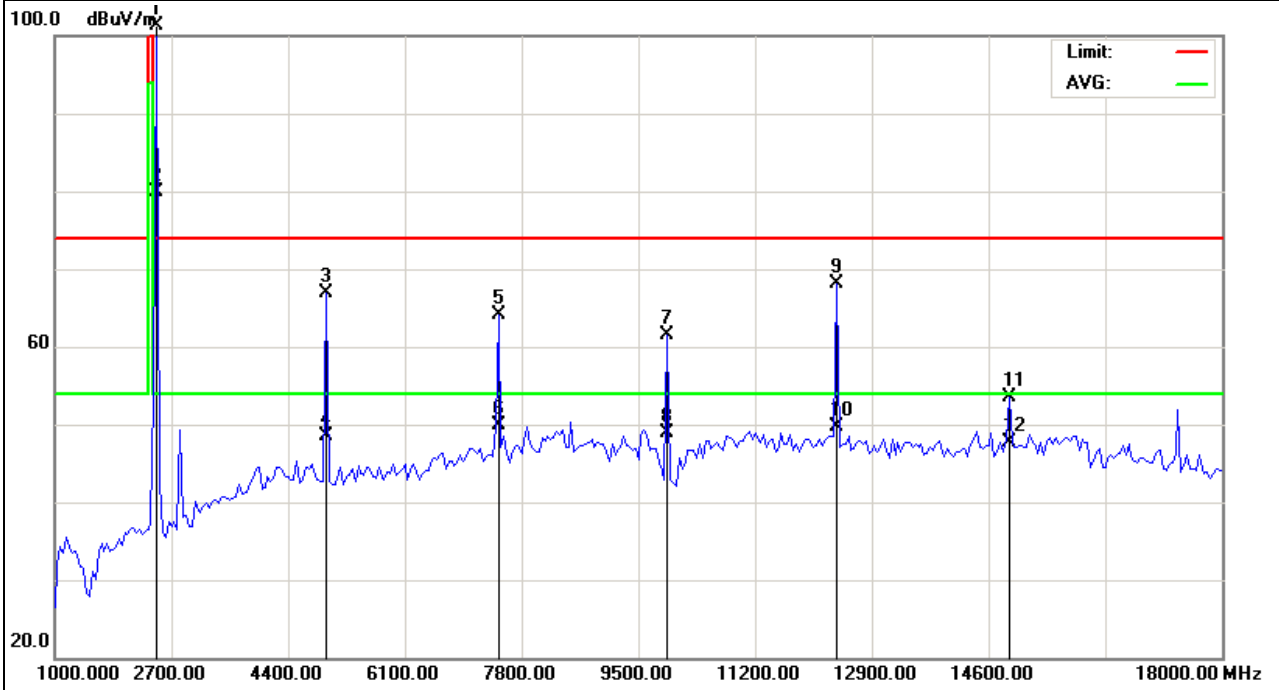



### 3.4.8 TEST RESULTS (RESTRICTED BANDS REQUIREMENTS)

EUT :	2.4G RF module with amplifier	Model Name :	RF2401F20
Temperature :	20 °C	Relative Humidity :	48%
Pressure :	1010 hPa	Test Voltage :	DC 5.0V
Test Mode :	TX-2402MHz/250Kbps	Polarization :	Horizontal

Frequency (MHz)	Meter Reading (dBμV)	Factor (dB)	Emission Level (dBμV/m)	Limits (dBμV/m)	Margin (dB)	Detector Type
2326.500	18.32	30.97	49.29	74.00	-24.71	peak

Remark:  
Factor = Antenna Factor + Cable Loss – Pre-amplifier.

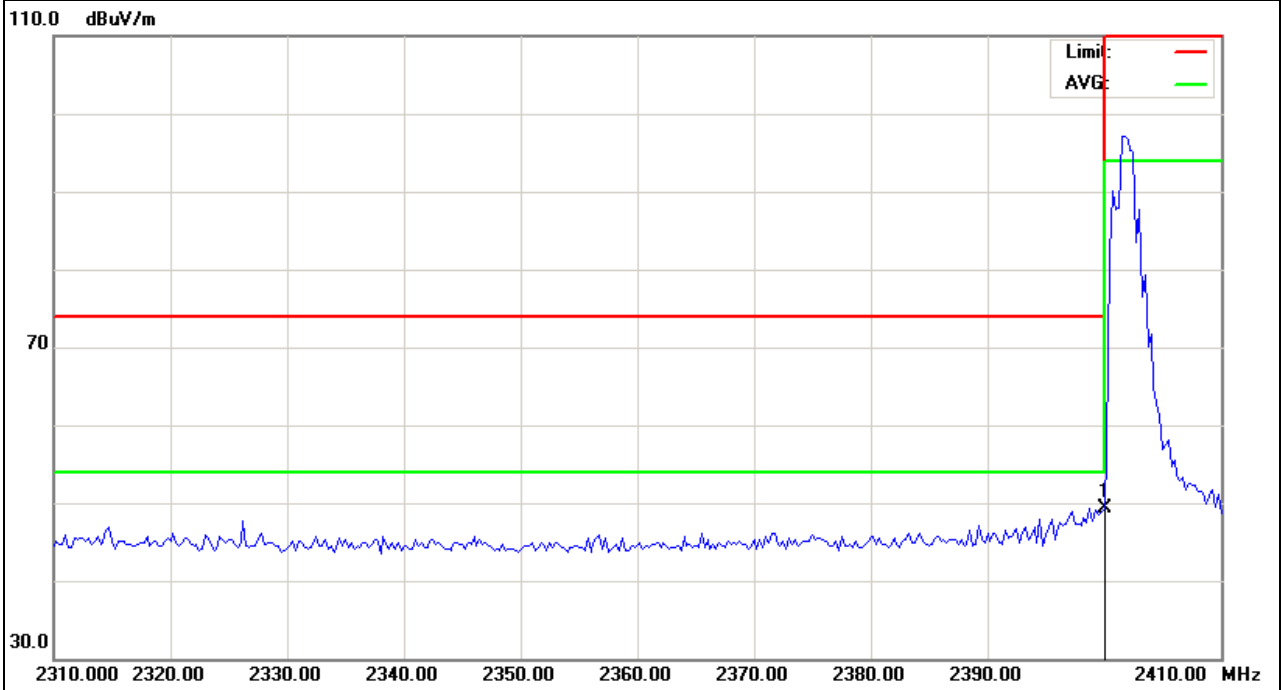

EUT :	2.4G RF module with amplifier	Model Name :	RF2401F20
Temperature :	20 °C	Relative Humidity :	48%
Pressure :	1010 hPa	Test Voltage :	DC 5.0V
Test Mode :	TX-2402MHz/250Kbps	Polarization :	Vertical

Frequency (MHz)	Meter Reading (dBμV)	Factor (dB)	Emission Level (dBμV/m)	Limits (dBμV/m)	Margin (dB)	Detector Type
2400.000	16.49	30.97	47.46	74.00	-26.54	peak

Remark:  
Factor = Antenna Factor + Cable Loss – Pre-amplifier.

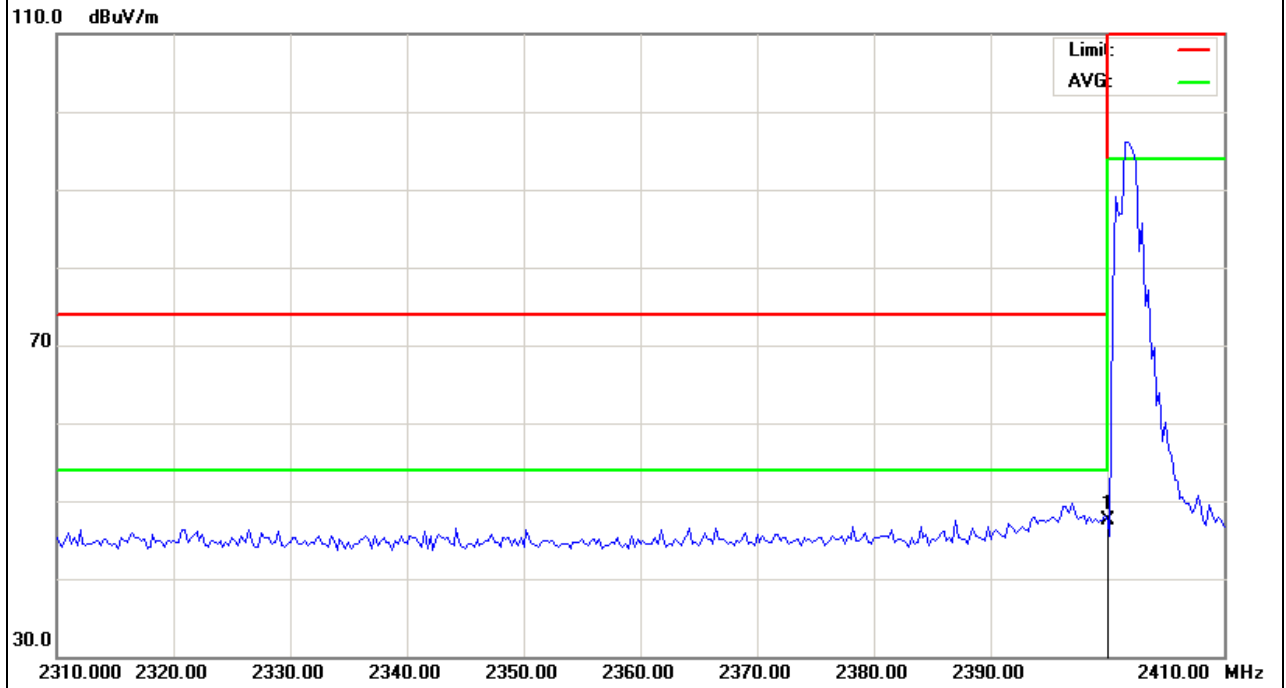

EUT :	2.4G RF module with amplifier	Model Name :	RF2401F20
Temperature :	20 °C	Relative Humidity :	48%
Pressure :	1010 hPa	Test Voltage :	DC 5.0V
Test Mode :	TX-2480MHz/250Kbps	Polarization :	Horizontal

Frequency (MHz)	Meter Reading (dBμV)	Factor (dB)	Emission Level (dBμV/m)	Limits (dBμV/m)	Margin (dB)	Detector Type
2483.50	18.84	31.21	50.05	74.00	-23.95	peak

Remark:  
Factor = Antenna Factor + Cable Loss – Pre-amplifier.

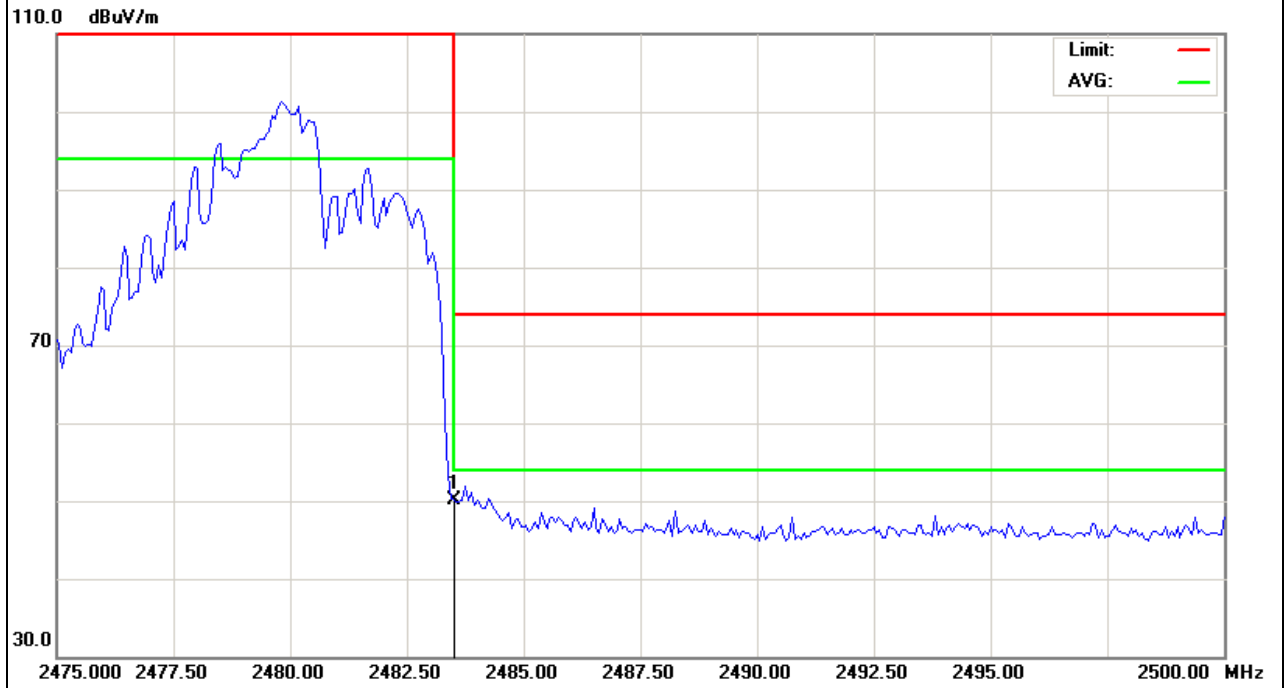

EUT :	2.4G RF module with amplifier	Model Name :	RF2401F20
Temperature :	20 °C	Relative Humidity :	48%
Pressure :	1010 hPa	Test Voltage :	DC 5.0V
Test Mode :	TX-2480MHz/250Kbps	Polarization :	Vertical

Frequency (MHz)	Meter Reading (dBμV)	Factor (dB)	Emission Level (dBμV/m)	Limits (dBμV/m)	Margin (dB)	Detector Type
2483.500	18.15	31.21	49.36	74.00	-24.64	peak

Remark:  
 Factor = Antenna Factor + Cable Loss – Pre-amplifier.

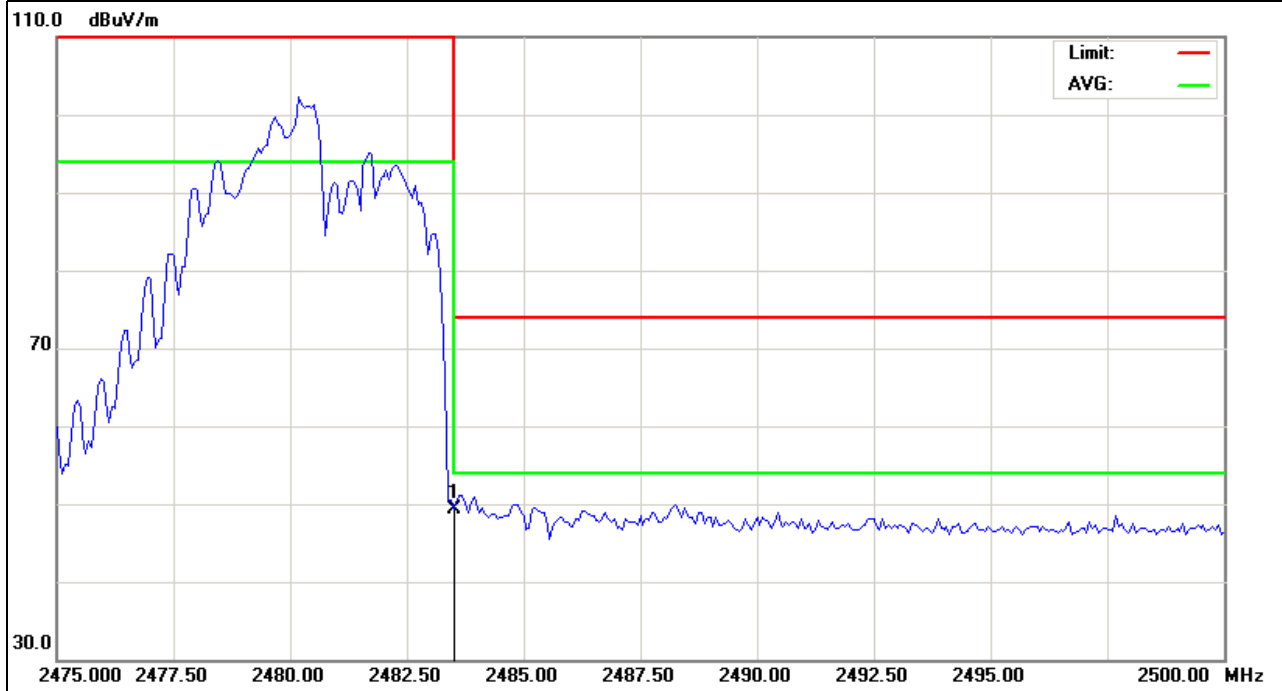

EUT :	2.4G RF module with amplifier	Model Name :	RF2401F20
Temperature :	20 °C	Relative Humidity :	48%
Pressure :	1010 hPa	Test Voltage :	DC 5.0V
Test Mode :	TX-2402MHz/1Mbps	Polarization :	Horizontal

Frequency (MHz)	Meter Reading (dBμV)	Factor (dB)	Emission Level (dBμV/m)	Limits (dBμV/m)	Margin (dB)	Detector Type
2400.000	20.44	30.97	51.41	74.00	-22.59	peak

Remark:  
Factor = Antenna Factor + Cable Loss – Pre-amplifier.

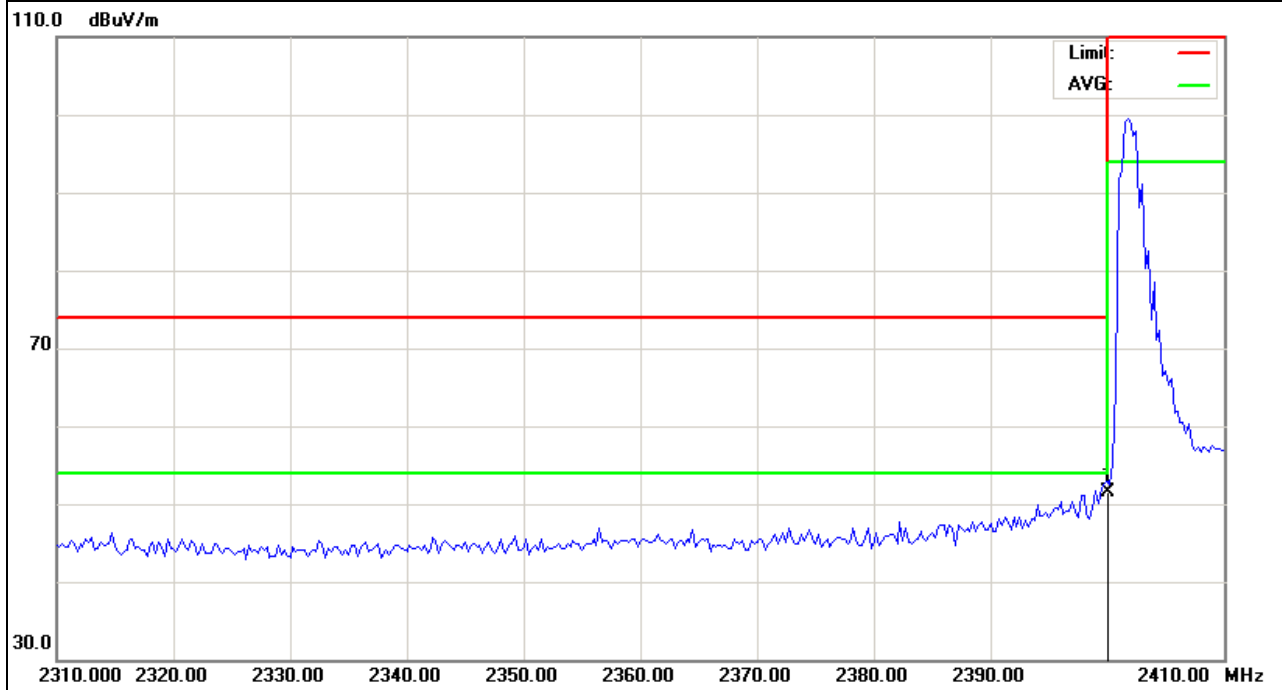

EUT :	2.4G RF module with amplifier	Model Name :	RF2401F20
Temperature :	20 °C	Relative Humidity :	48%
Pressure :	1010 hPa	Test Voltage :	DC 5.0V
Test Mode :	TX-2402MHz/1Mbps	Polarization :	Vertical

Frequency (MHz)	Meter Reading (dBμV)	Factor (dB)	Emission Level (dBμV/m)	Limits (dBμV/m)	Margin (dB)	Detector Type
2400.000	17.11	30.97	48.08	74.00	-25.92	peak

Remark:  
Factor = Antenna Factor + Cable Loss – Pre-amplifier.

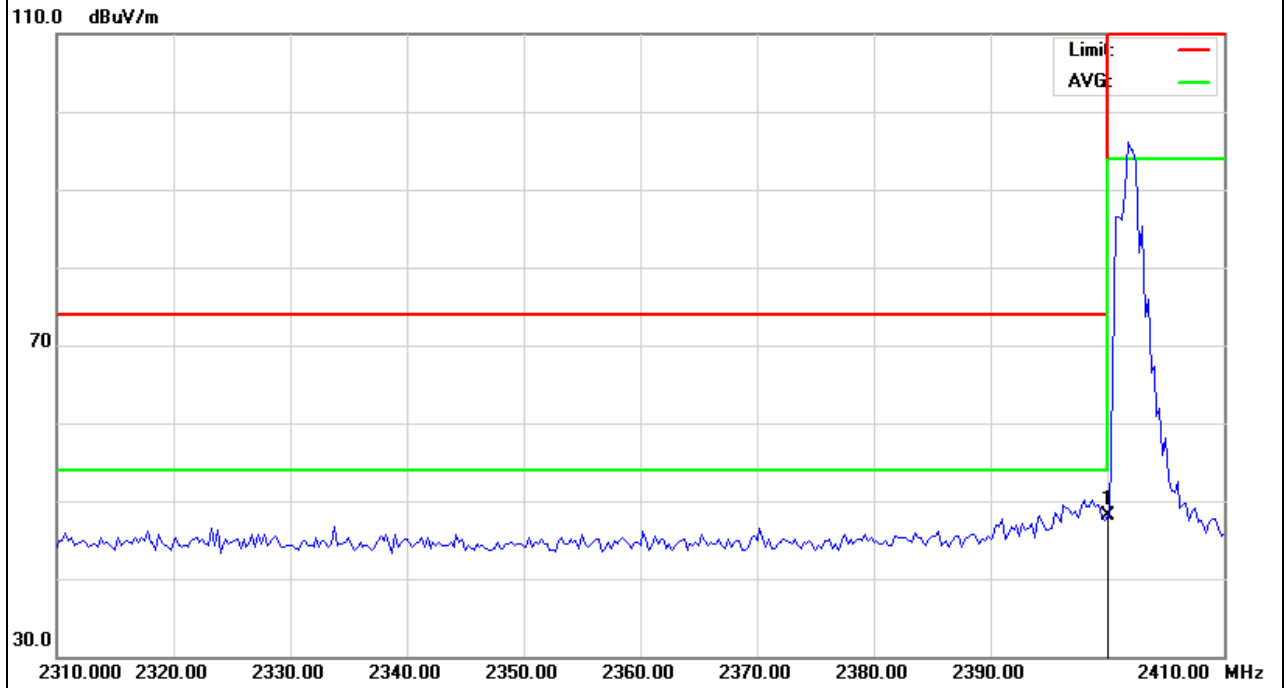

EUT :	2.4G RF module with amplifier	Model Name :	RF2401F20
Temperature :	20 °C	Relative Humidity :	48%
Pressure :	1010 hPa	Test Voltage :	DC 5.0V
Test Mode :	TX-2480MHz/1Mbps	Polarization :	Horizontal

Frequency (MHz)	Meter Reading (dBμV)	Factor (dB)	Emission Level (dBμV/m)	Limits (dBμV/m)	Margin (dB)	Detector Type
2483.50	20.25	31.21	51.46	74.00	-22.54	peak

Remark:  
Factor = Antenna Factor + Cable Loss – Pre-amplifier.

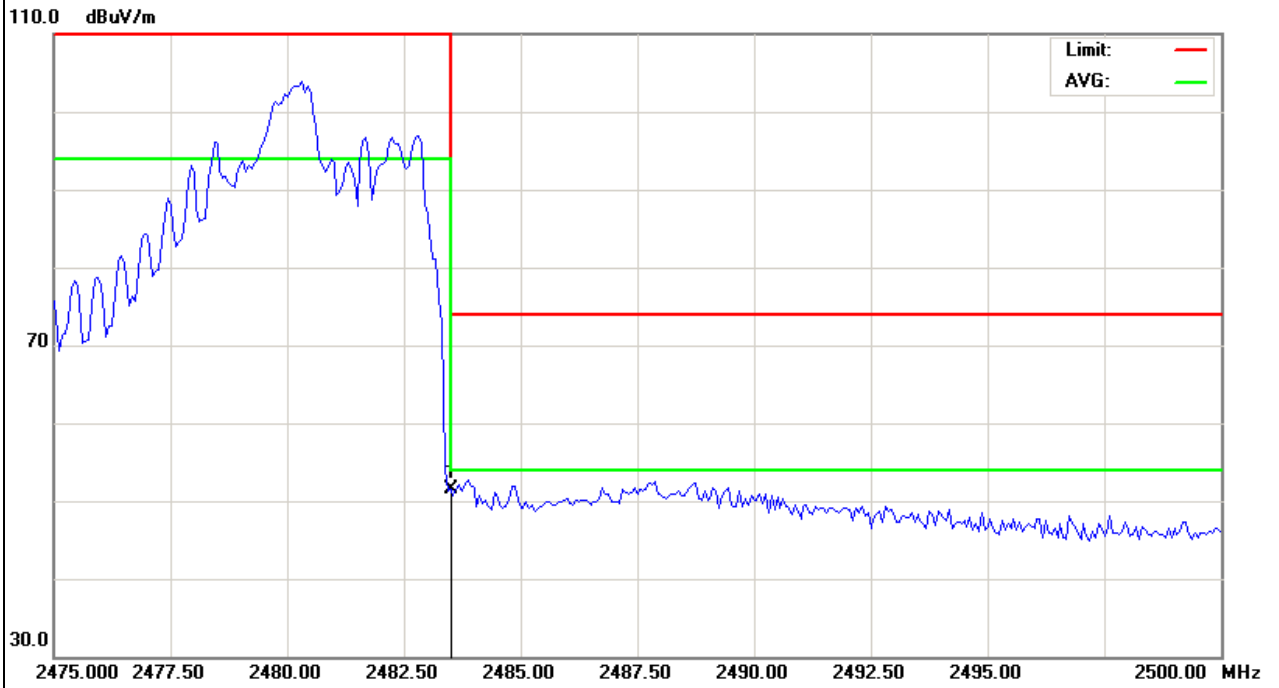

EUT :	2.4G RF module with amplifier	Model Name :	RF2401F20
Temperature :	20 °C	Relative Humidity :	48%
Pressure :	1010 hPa	Test Voltage :	DC 5.0V
Test Mode :	TX-2480MHz/1Mbps	Polarization :	Vertical

Frequency (MHz)	Meter Reading (dBμV)	Factor (dB)	Emission Level (dBμV/m)	Limits (dBμV/m)	Margin (dB)	Detector Type
2483.500	18.70	31.21	49.91	74.00	-24.09	peak

Remark:  
Factor = Antenna Factor + Cable Loss – Pre-amplifier.

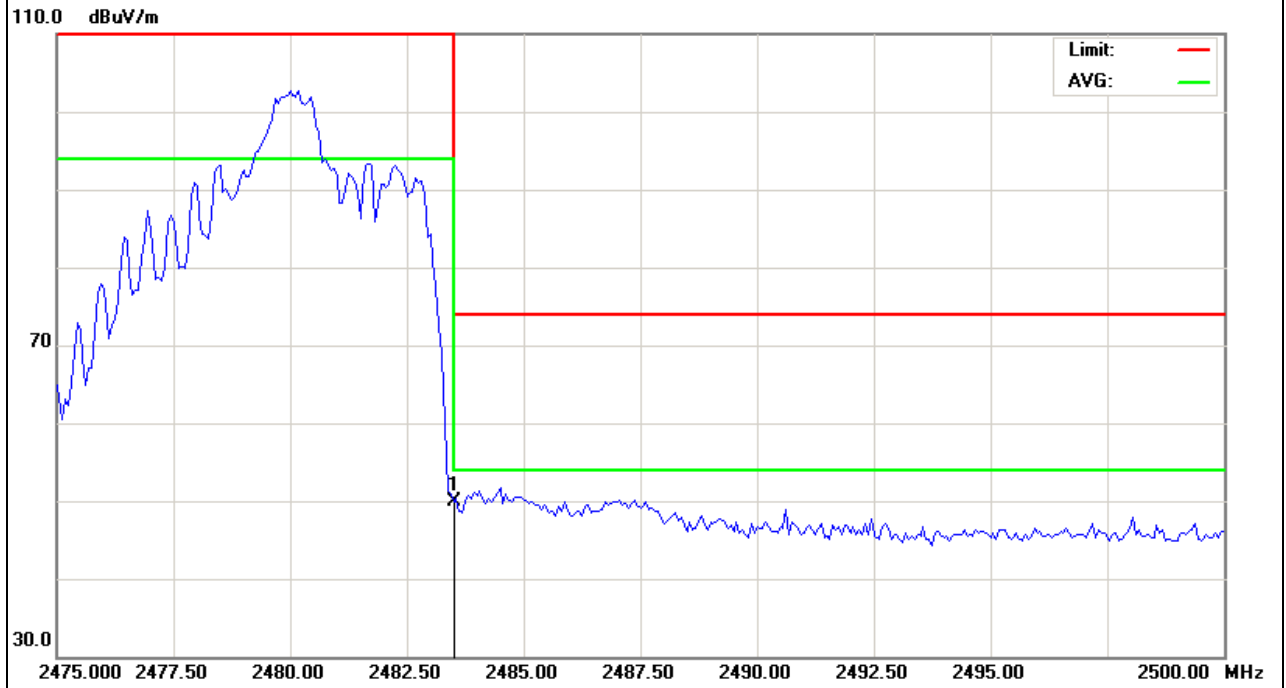



EUT :	2.4G RF module with amplifier	Model Name :	RF2401F20
Temperature :	20 °C	Relative Humidity :	48%
Pressure :	1010 hPa	Test Voltage :	DC 5.0V
Test Mode :	TX-2402MHz/2Mbps	Polarization :	Horizontal

Frequency (MHz)	Meter Reading (dBμV)	Factor (dB)	Emission Level (dBμV/m)	Limits (dBμV/m)	Margin (dB)	Detector Type
2400.000	20.78	30.97	51.75	74.00	-22.25	peak

Remark:  
Factor = Antenna Factor + Cable Loss – Pre-amplifier.

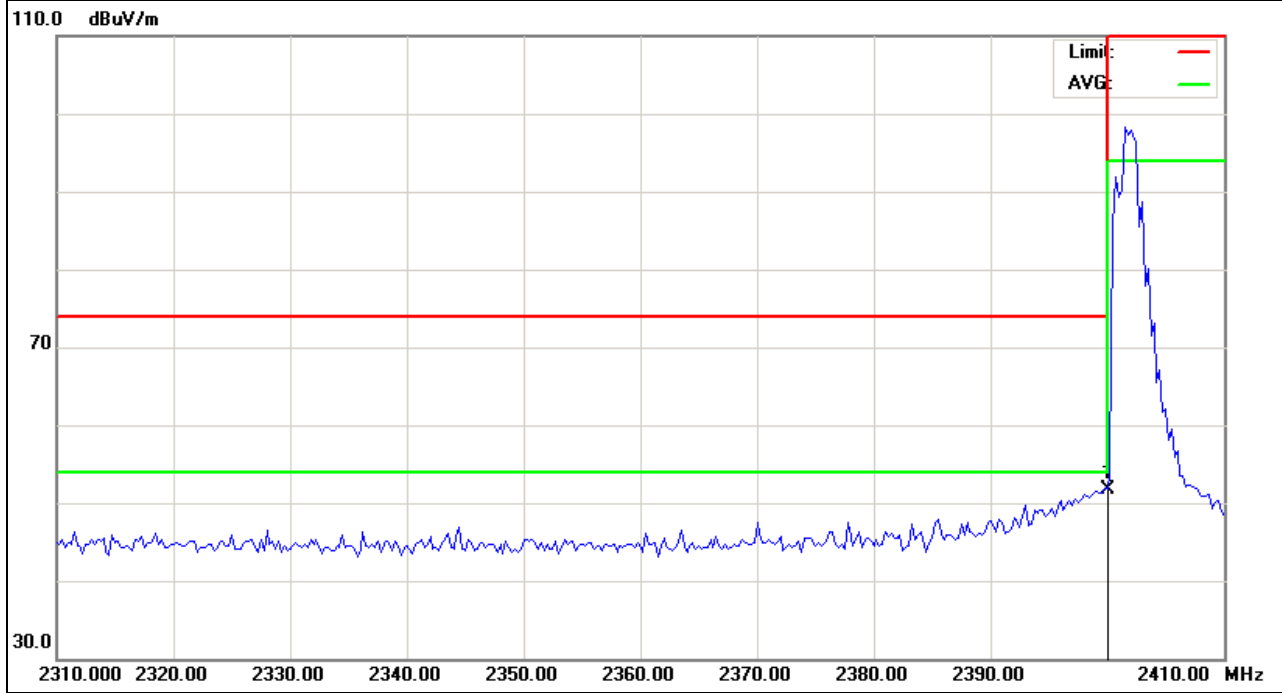

EUT :	2.4G RF module with amplifier	Model Name :	RF2401F20
Temperature :	20 °C	Relative Humidity :	48%
Pressure :	1010 hPa	Test Voltage :	DC 5.0V
Test Mode :	TX-2402MHz/2Mbps	Polarization :	Vertical

Frequency (MHz)	Meter Reading (dBμV)	Factor (dB)	Emission Level (dBμV/m)	Limits (dBμV/m)	Margin (dB)	Detector Type
2400.000	19.73	30.97	50.70	74.00	-23.30	peak

Remark:  
Factor = Antenna Factor + Cable Loss – Pre-amplifier.

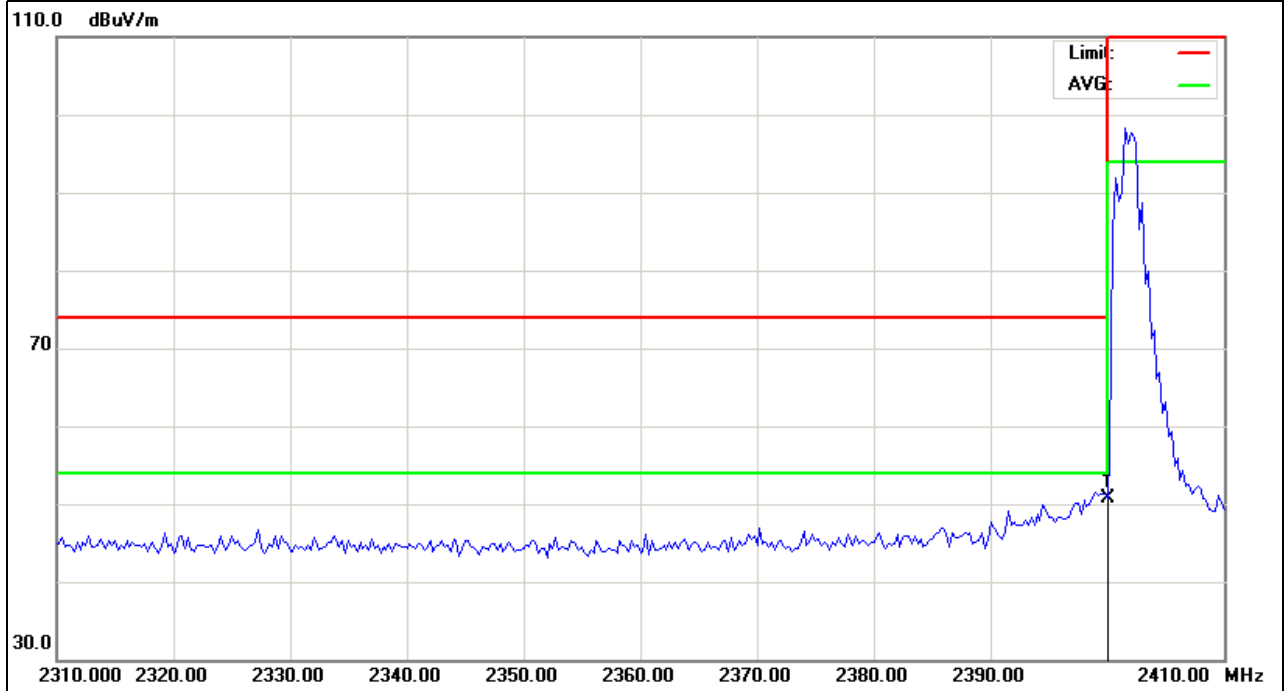

EUT :	2.4G RF module with amplifier	Model Name :	RF2401F20
Temperature :	20 °C	Relative Humidity :	48%
Pressure :	1010 hPa	Test Voltage :	DC 5.0V
Test Mode :	TX-2480MHz/2Mbps	Polarization :	Horizontal

Frequency (MHz)	Meter Reading (dBμV)	Factor (dB)	Emission Level (dBμV/m)	Limits (dBμV/m)	Margin (dB)	Detector Type
2483.50	17.40	31.21	48.61	74.00	-25.39	peak

Remark:  
 Factor = Antenna Factor + Cable Loss – Pre-amplifier.

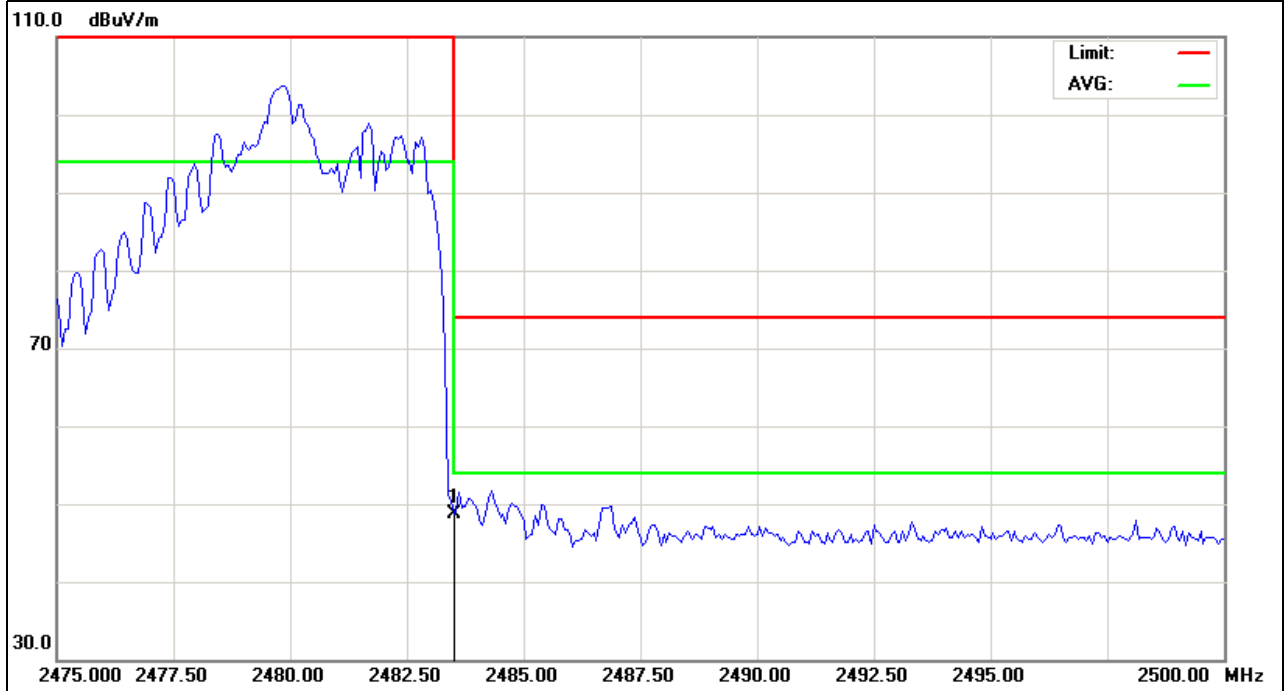

EUT :	2.4G RF module with amplifier	Model Name :	RF2401F20
Temperature :	20 °C	Relative Humidity :	48%
Pressure :	1010 hPa	Test Voltage :	DC 5.0V
Test Mode :	TX-2480MHz/2Mbps	Polarization :	Vertical

Frequency (MHz)	Meter Reading (dBμV)	Factor (dB)	Emission Level (dBμV/m)	Limits (dBμV/m)	Margin (dB)	Detector Type
2483.500	19.16	31.21	50.37	74.00	-23.63	peak

Remark:  
 Factor = Antenna Factor + Cable Loss – Pre-amplifier.

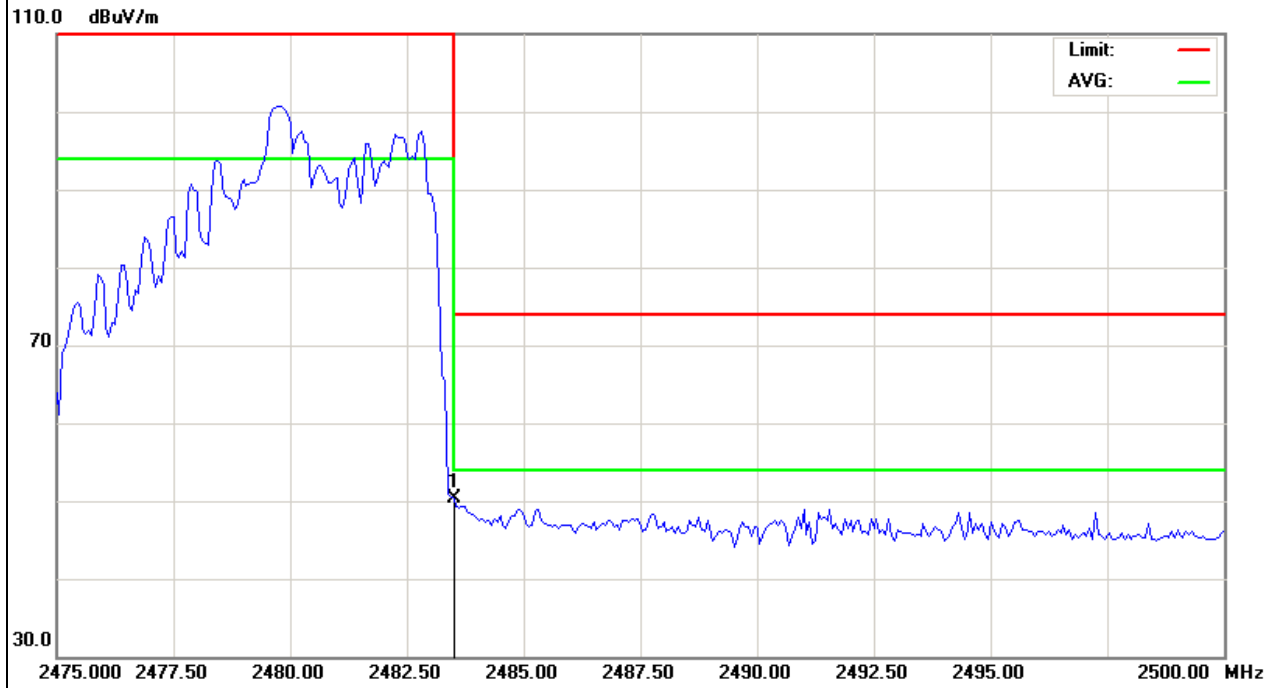

## 4. BANDWIDTH TEST

### 4.1 TEST PROCEDURE

- a. The EUT was directly connected to the spectrum analyzer and antenna output port as show in the block diagram below,
- b. Spectrum Setting : RBW= 100KHz, VBW $\geq$ RBW, Sweep time = Auto.

### 4.2 DEVIATION FROM STANDARD

No deviation.

### 4.3 TEST SETUP



#### 4.4 TEST RESULTS

EUT :	2.4G RF module with amplifier	Model Name :	RF2401F20
Temperature :	26 °C	Relative Humidity :	53%
Pressure :	1020 hPa	Test Power :	DC 5.0V
Test Mode :	TX/250Kbps		

Frequency (MHz)	20 dBc Bandwidth (MHz)	99% Bandwidth (MHz)
2402	2.296	2.0689
2441	2.245	2.0501
2480	2.120	1.9390

The Lowest Channel:2402MHz

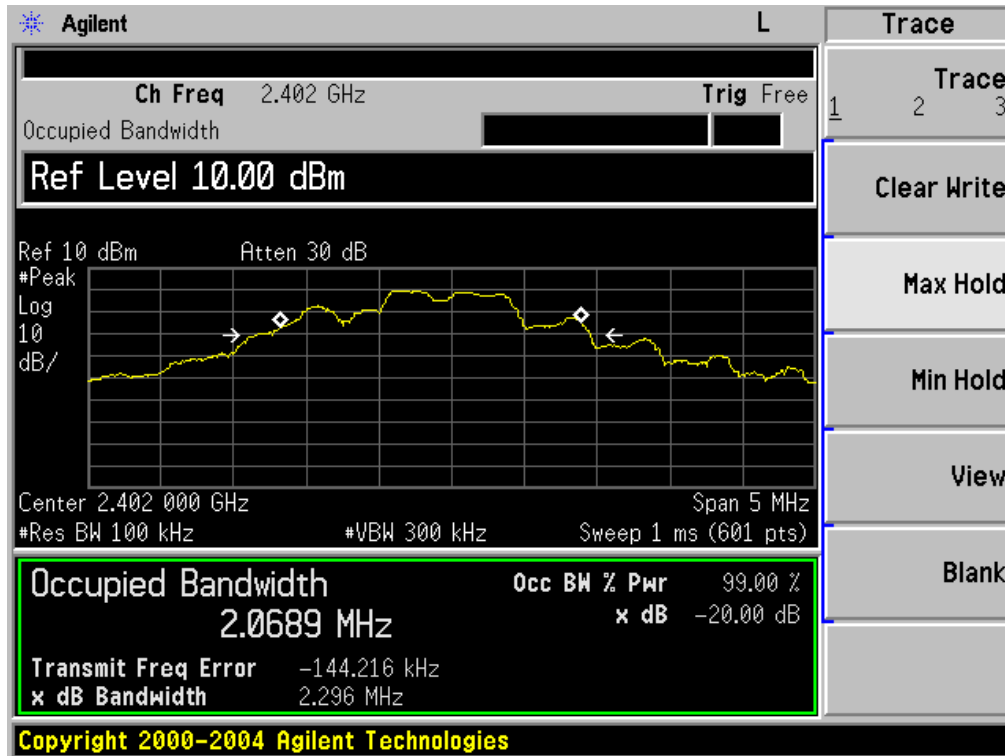

The Middle Channel:2441MHz

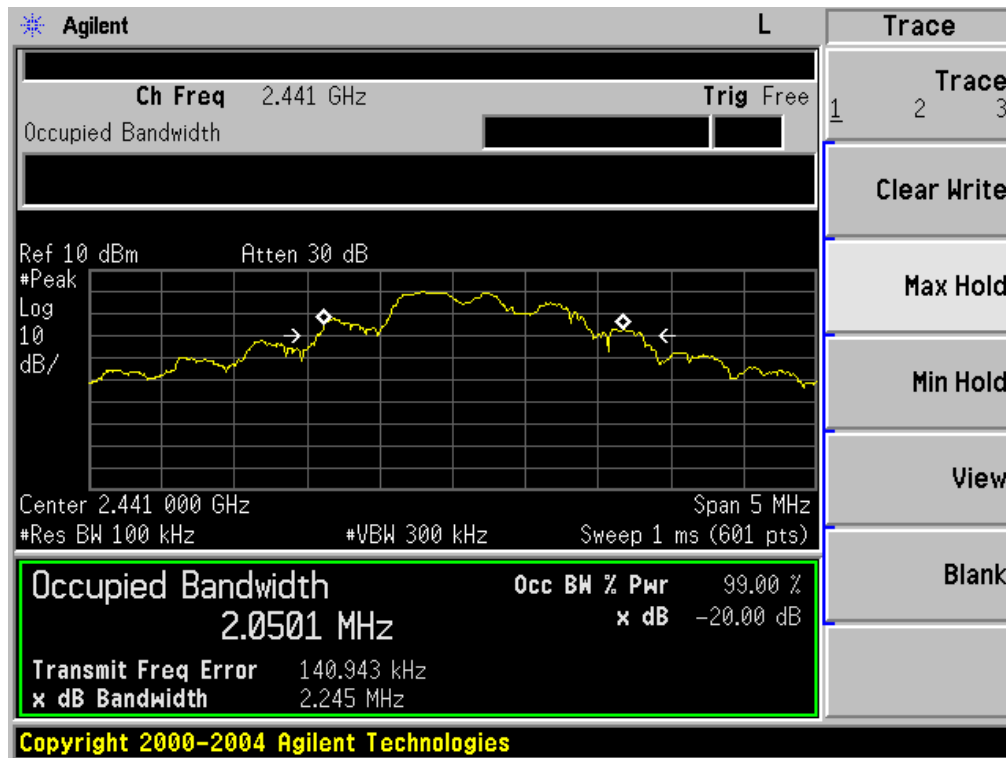

The HIGH Channel: 2480MHz

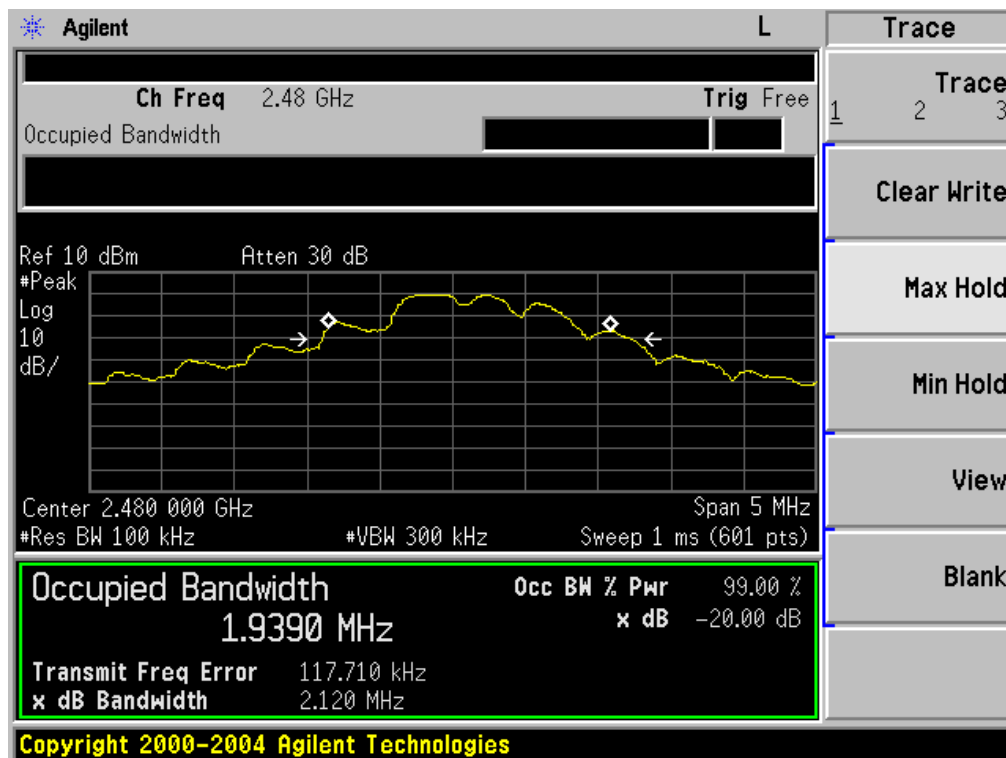

EUT :	2.4G RF module with amplifier	Model Name :	RF2401F20
Temperature :	26 °C	Relative Humidity :	53%
Pressure :	1020 hPa	Test Power :	DC 5.0V
Test Mode :	TX/1Mbps		

Frequency (MHz)	20 dBc Bandwidth (MHz)	99% Bandwidth (MHz)
2402	2.349	2.1270
2441	2.299	2.0198
2480	2.177	2.0359

The Lowest Channel:2402MHz





### The Middle Channel:2441MHz

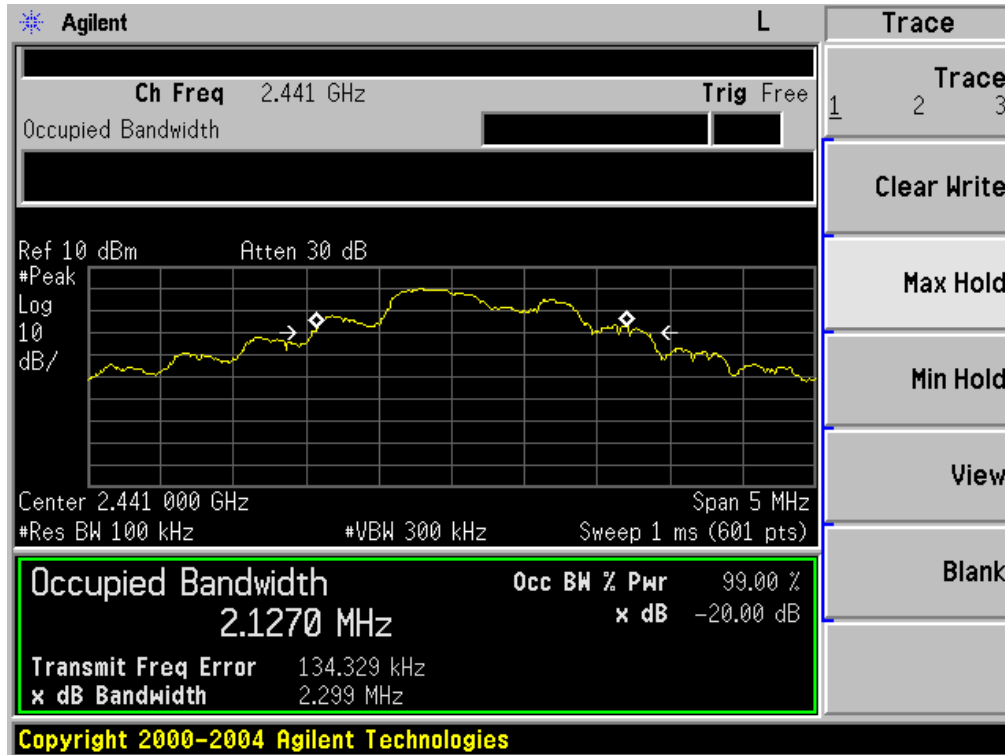

### The HIGH Channel: 2480MHz

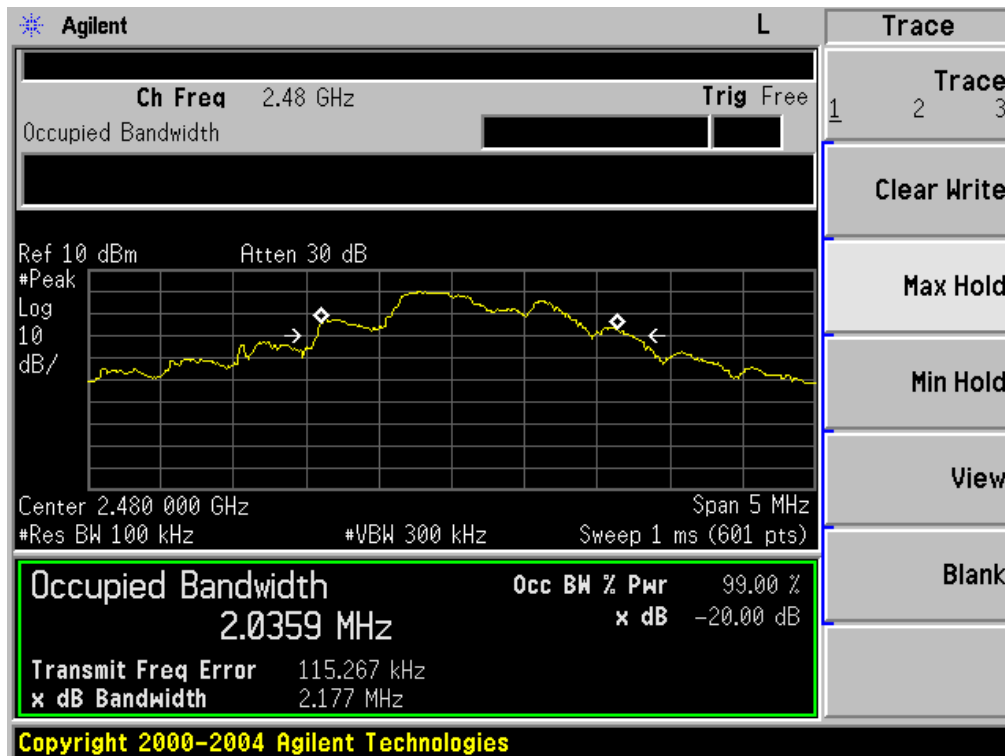

EUT :	2.4G RF module with amplifier	Model Name :	RF2401F20
Temperature :	26 °C	Relative Humidity :	53%
Pressure :	1020 hPa	Test Power :	DC 5.0V
Test Mode :	TX/2Mbps		

Frequency (MHz)	20 dBc Bandwidth (MHz)	99% Bandwidth (MHz)
2402	2.460	2.2201
2441	2.343	2.1565
2480	2.239	2.0142

The Lowest Channel:2402MHz

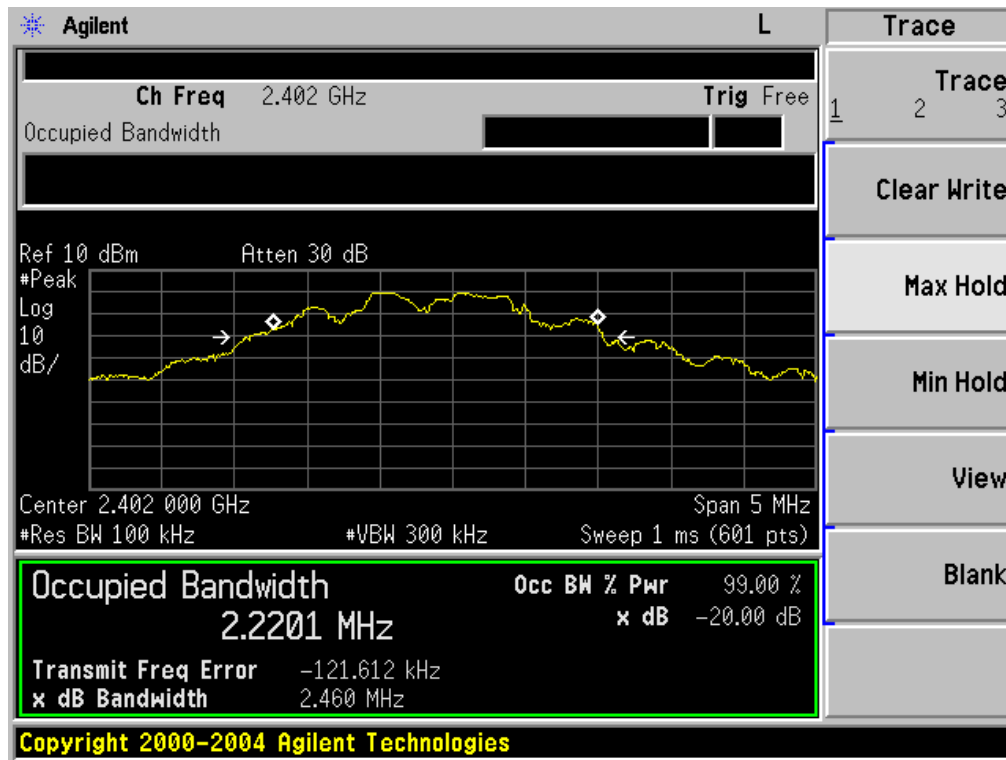

The Middle Channel:2441MHz

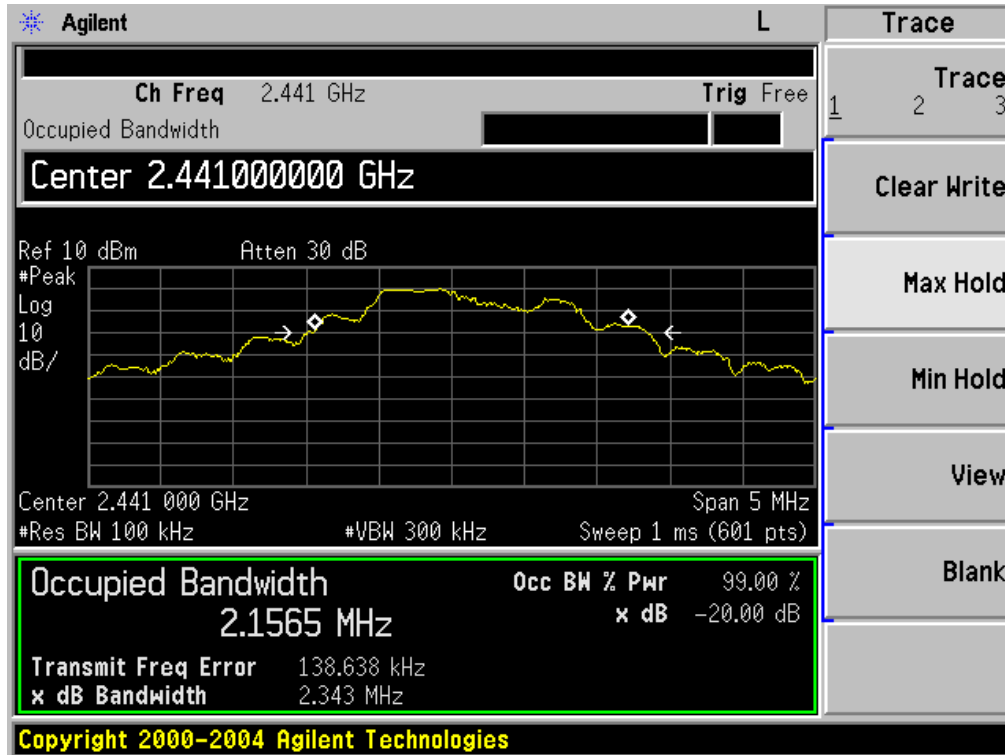

The HIGH Channel: 2480MHz

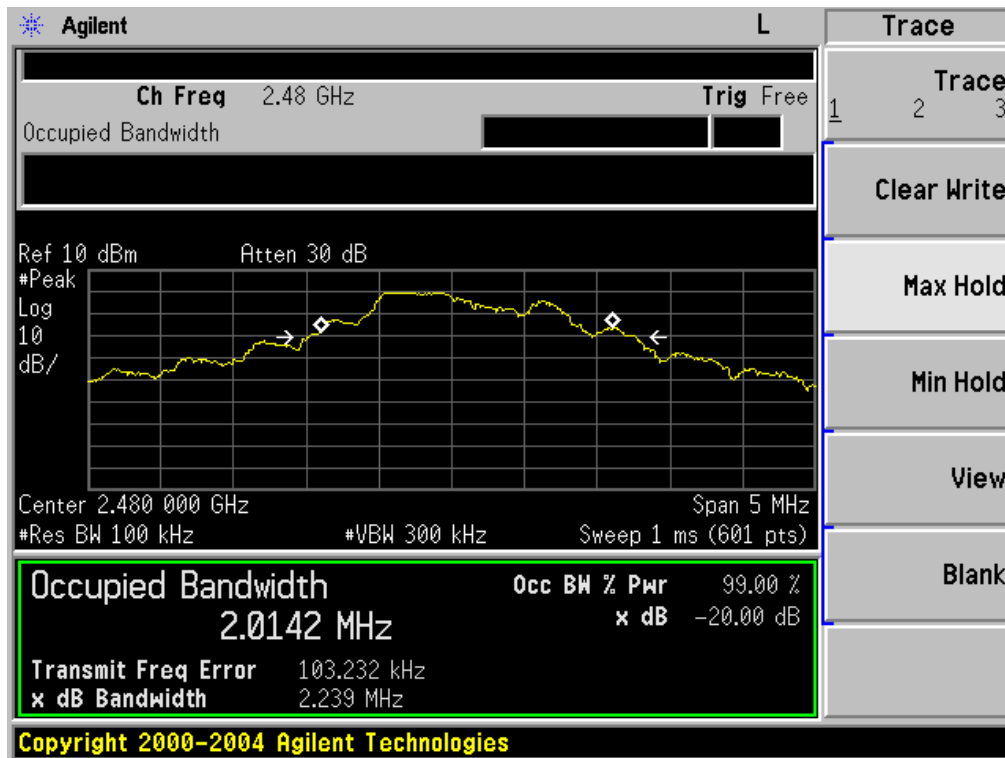

**5. EUT TEST PHOTO**

**Radiated Measurement Photos**

