



FCC RADIO TEST REPORT

FCC ID: 2AD66-4463H1

Product : 915Mhz si4463 wireless module with U.FL (IPEX) connector

Trade Mark : G-NiceRF

Model Name : RF4463Pro-915-H1

Serial Model : N/A

Report No. : NTEK-2016NT11210004F

Prepared for

NiceRF Wireless Technology LTD.,
309-314, Bldg A, Hongdu business building, Xin'an street, Zone 43,
Baoan Dist, Shenzhen 518101, China

Prepared by

NTEK Testing Technology Co., Ltd.

1/F, Building E, Fenda Science Park, Sanwei Community, Xixiang Street
Bao'an District, Shenzhen 518126 P.R. China
Tel.: +86-755-6115 6588 Fax.: +86-755-6115 6599
Website: <http://www.ntek.org.cn>

Table of Contents	Page
1 . SUMMARY OF TEST RESULTS	4
1.1 TEST FACILITY	5
1.2 MEASUREMENT UNCERTAINTY	5
2 . GENERAL INFORMATION	6
2.1 GENERAL DESCRIPTION OF EUT	6
2.2 DESCRIPTION OF TEST MODES	8
2.3 BLOCK DIGRAM SHOWING THE CONFIGURATION OF SYSTEM TESTED	9
2.4 DESCRIPTION OF SUPPORT UNITS(CONDUCTED MODE)	10
3 . ANTENNA REQUIREMENT	12
3.1 STANDARD REQUIREMENT	12
3.2 EUT ANTENNA	12
3.3 CONDUCTED EMISSION MEASUREMENT	13
3.3.1 POWER LINE CONDUCTED EMISSION LIMITS	13
3.3.2 TEST PROCEDURE	14
3.3.3 DEVIATION FROM TEST STANDARD	14
3.3.4 TEST SETUP	14
3.4 RADIATED EMISSION MEASUREMENT	16
3.4.1 RADIATED EMISSION LIMITS	16
3.4.2 TEST PROCEDURE	17
3.4.3 DEVIATION FROM TEST STANDARD	17
3.4.4 TEST SETUP	18
3.4.5 TEST RESULTS (BLOW 30MHZ)	20
3.4.6 TEST RESULTS (BETWEEN 30 – 1000 MHZ)	21
3.4.7 TEST RESULTS (ABOVE 1000 MHZ)	25
3.4.8 TEST RESULTS (RESTRICTED BANDS REQUIREMENTS)	29
4 . BANDWIDTH TEST	33
4.1 TEST PROCEDURE	33
4.2 DEVIATION FROM STANDARD	33
4.3 TEST SETUP	33
4.4 TEST RESULTS	34
5 . EUT TEST PHOTO	36
APPENDIX-PHOTOGRAPHS OF EUT CONSTRUCTIONAL DETAILS	

1. SUMMARY OF TEST RESULTS

Test procedures according to the technical standards:

FCC Part15, Subpart C (15.249)			
Standard Section	Test Item	Judgment	Remark
15.207	Conducted Emission	N/A	
15.203	Antenna Requirement	Pass	
15.249	Radiated Spurious Emission	Pass	
15.205	Band Edge Emission	Pass	
15.249	Occupied Bandwidth	Pass	

Note: The AC line testing is exempted due to the EUT is powered solely by batteries.

1.1 TEST FACILITY

NTEK Testing Technology Co., Ltd
 Add. : 1/F, Building E, Fenda Science Park, Sanwei Community, Xixiang Street, Bao'an District, Shenzhen P.R. China.
 FCC FRN Registration No.:238937; IC Registration No.:9270A-1
 CNAS Registration No.:L5516

1.2 MEASUREMENT UNCERTAINTY

The reported uncertainty of measurement $y \pm U$, where expanded uncertainty U is based on a standard uncertainty multiplied by a coverage factor of $k=2$, providing a level of confidence of approximately 95 %.

No.	Item	Uncertainty
1	Conducted Emission Test	$\pm 1.38\text{dB}$
2	RF power,conducted	$\pm 0.16\text{dB}$
3	Spurious emissions,conducted	$\pm 0.21\text{dB}$
4	All emissions,radiated(<1G)	$\pm 4.68\text{dB}$
5	All emissions,radiated(>1G)	$\pm 4.89\text{dB}$
6	Temperature	$\pm 0.5^\circ\text{C}$
7	Humidity	$\pm 2\%$

2. GENERAL INFORMATION

2.1 GENERAL DESCRIPTION OF EUT

Equipment	915Mhz si4463 wireless module with U.FL (IPEX) connector	
Trade Mark	G-NiceRF	
Model Name	RF4463Pro-915-H1	
Serial Model	N/A	
Model Difference	N/A	
Product Description	The EUT is a 915Mhz si4463 wireless module with U.FL (IPEX) connector	
	Operation Frequency:	902.5 MHz -927.5MHz
	Modulation Type:	GFSK
	Antenna Designation:	coaxial antenna
	Antenna Gain(Peak)	2.15 dBi
	Based on the application, features, or specification exhibited in User's Manual, the EUT is considered as an ITE/Computing Device. More details of EUT technical specification, please refer to the User's Manual.	
Channel List	Please refer to the Note 2.	
Adapter	N/A	
Battery	DC 3.3V	
SW Version	RF4463 TEST DEMO	
HW Version	RADIOBOARD V3.3	

Note:

1. For a more detailed features description, please refer to the manufacturer's specifications or the User's Manual.

2.

Channel	Frequency (MHz)	Channel	Frequency (MHz)
01	902.5	14	915.5
02	903.5	15	916.5
03	904.5	16	917.5
04	905.5	17	918.5
05	906.5	18	919.5
06	907.5	19	920.5
07	908.5	20	921.5
08	909.5	21	922.5
09	910.5	22	923.5
10	911.5	23	924.5
11	912.5	24	925.5
12	913.5	25	926.5
13	914.5	26	927.5

3.

Table for Filed Antenna

Ant	Brand	Model Name	Antenna Type	Connector	Gain (dBi)	NOTE
1	N/A	N/A	Spring Antenna	N/A	2.15	Antenna

2.2 DESCRIPTION OF TEST MODES

To investigate the maximum EMI emission characteristics generates from EUT, the test system was pre-scanning tested base on the consideration of following EUT operation mode or test configuration mode which possible have effect on EMI emission level. Each of these EUT operation mode(s) or test configuration mode(s) mentioned above was evaluated respectively.

Pretest Mode	Description
Mode 1	CH 01
Mode 2	CH 26
Mode 3	Link mode

For Radiated Emission	
Final Test Mode	Description
Mode 1	CH 01
Mode 2	CH 26

Note:

(1) The measurements are performed at the highest, lowest channels.

2.3 BLOCK DIGRAM SHOWING THE CONFIGURATION OF SYSTEM TESTED

Radiated Spurious Emission Test

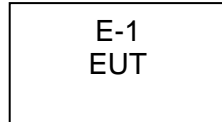

2.4 DESCRIPTION OF SUPPORT UNITS(CONDUCTED MODE)

The EUT has been tested as an independent unit together with other necessary accessories or support units. The following support units or accessories were used to form a representative test configuration during the tests.

Item	Equipment	Mfr/Brand	Model/Type No.	Series No.	Note
E-1	915Mhz si4463 wireless module with U.FL (IPEX) connector	G-NiceRF	RF4463Pro-915-H1	N/A	EUT

Item	Shielded Type	Ferrite Core	Length	Note

Note:

- (1) The support equipment was authorized by Declaration of Confirmation.
- (2) For detachable type I/O cable should be specified the length in cm in 『Length』 column.

2.4.1 EQUIPMENTS LIST FOR ALL TEST ITEMS
Radiation Test equipment

Item	Kind of Equipment	Manufacturer	Type No.	Serial No.	Calibrated until
1	Spectrum Analyzer	Agilent	E4407B	160400005	Jul. 06. 2017
2	Test Receiver	R&S	ESPI	101318	Jul. 06. 2017
3	Bilog Antenna	TESEQ	CBL6111D	31216	Jul. 06. 2017
4	50Ω Coaxial Switch	Anritsu	MP59B	6200264416	Jul. 06. 2017
5	Spectrum Analyzer	ADVANTEST	R3132	150900201	Jul. 06. 2017
6	Horn Antenna	EM	EM-AH-10180	2011071402	Jul. 06. 2017
7	Horn Ant	Schwarzbeck	BBHA 9170	9170-181	Jul. 06. 2017
8	Amplifier	EM	EM-30180	060538	Jul. 06. 2017
9	Loop Antenna	ARA	PLA-1030/B	1029	Jul. 06. 2017
10	Power Meter	R&S	NRVS	100696	Jul. 06. 2017

Conduction Test equipment

Item	Kind of Equipment	Manufacturer	Type No.	Serial No.	Calibrated until
1	Test Receiver	R&S	ESCI	101160	Jul. 06. 2017
2	LISN	R&S	ENV216	101313	Jul. 06. 2017
3	LISN	EMCO	3816/2	00042990	Jul. 06. 2017
4	50Ω Coaxial Switch	Anritsu	MP59B	6200264417	Jul. 06. 2017
5	Passive Voltage Probe	R&S	ESH2-Z3	100196	Jul. 06. 2017
6	Absorbing clamp	R&S	MOS-21	100423	Jul. 06. 2017

3. ANTENNA REQUIREMENT

3.1 STANDARD REQUIREMENT

15.203 requirement: For intentional device, according to 15.203: an intentional radiator shall be designed to ensure that no antenna other than that furnished by the responsible party shall be used with the device.

3.2 EUT ANTENNA

The EUT antenna is spring antenna, details to see internal photo, it comply with the standard requirement.

3.3 CONDUCTED EMISSION MEASUREMENT

3.3.1 POWER LINE CONDUCTED EMISSION Limits (Frequency Range 150KHz-30MHz)

FREQUENCY (MHz)	Class A (dBuV)		Class B (dBuV)		Standard
	Quasi-peak	Average	Quasi-peak	Average	
0.15 -0.5			66 - 56 *	56 - 46 *	CISPR
0.50 -5.0			56.00	46.00	CISPR
5.0 -30.0			60.00	50.00	CISPR

0.15 -0.5			66 - 56 *	56 - 46 *	LP002.
0.50 -5.0			56.00	46.00	LP002.
5.0 -30.0			60.00	50.00	LP002.

Note:

- (1) The tighter limit applies at the band edges.
- (2) The limit of " * " marked band means the limitation decreases linearly with the logarithm of the frequency in the range.

The following table is the setting of the receiver

Receiver Parameters	Setting
Attenuation	10 dB
Start Frequency	0.15 MHz
Stop Frequency	30 MHz
IF Bandwidth	9 kHz

3.3.2 TEST PROCEDURE

- a. The EUT was placed 0.4 meters from the horizontal ground plane with EUT being connected to the power mains through a line impedance stabilization network (LISN). All other support equipments powered from additional LISN(s). The LISN provide 50 Ohm/ 50uH of coupling impedance for the measuring instrument.
- b. Interconnecting cables that hang closer than 40 cm to the ground plane shall be folded back and forth in the center forming a bundle 30 to 40 cm long.
- c. I/O cables that are not connected to a peripheral shall be bundled in the center. The end of the cable may be terminated, if required, using the correct terminating impedance. The overall length shall not exceed 1 m.
- d. LISN at least 80 cm from nearest part of EUT chassis.
- e. For the actual test configuration, please refer to the related Item –EUT Test Photos.

3.3.3 DEVIATION FROM TEST STANDARD

No deviation

3.3.4 TEST SETUP

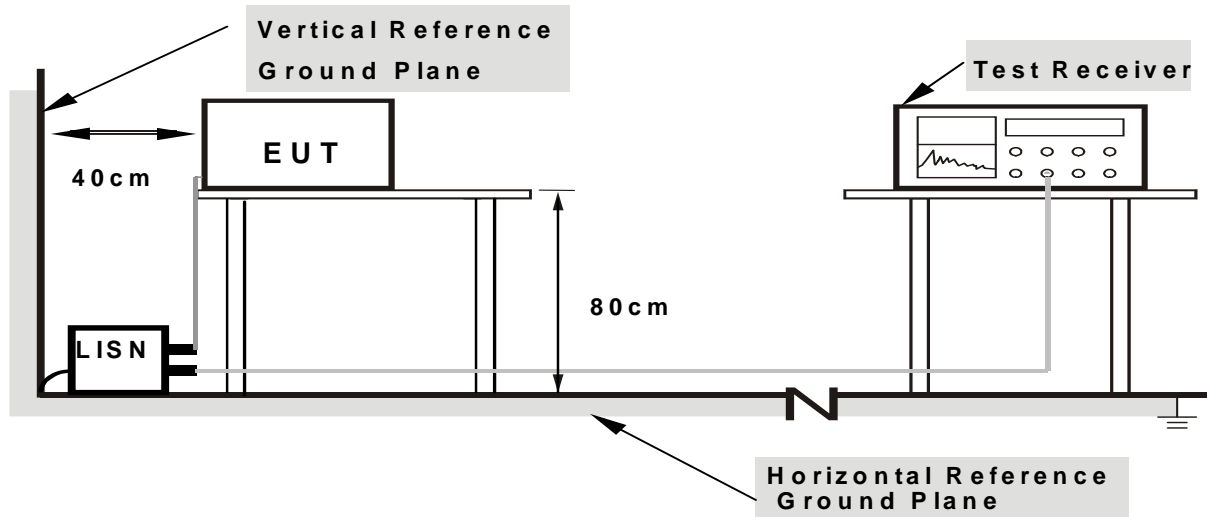

Note: 1. Support units were connected to second LISN.

2. Both of LISNs (AMN) are 80 cm from EUT and at least 80 cm from other units and other metal planes

3.2.5 TEST RESULT

EUT :	915Mhz si4463 wireless module with U.FL (IPEX) connector	Model Name. :	RF4463Pro-915-H1
Temperature :	26 °C	Relative Humidity :	54%
Pressure :	1010hPa	Phase :	N/A
Test Voltage :	N/A	Test Mode :	N/A

3.4 RADIATED EMISSION MEASUREMENT

3.4.1 Radiated Emission Limits (FCC 15.209)

Frequencies (MHz)	Field Strength (micorvolts/meter)	Measurement Distance (meters)
0.009~0.490	2400/F(KHz)	300
0.490~1.705	24000/F(KHz)	30
1.705~30.0	30	30
Frequency (MHz)	Limit (dBuV)	
30~88	40	3
88~216	43.5	3
216~960	46	3
960 -10000	54.00	3
*902 - 928	94.00	3

Note:

- (1) The tighter limit applies at the band edges.
- (2) Emission level (dBuV/m)=20log Emission level (uV/m).
- (3) *Note: This is the limit for the fundamental frequency.

LIMITS OF RADIATED EMISSION MEASUREMENT (FCC 15.249)

Frequency of Emission (MHz)	Field Strength of fundamental ((millivolts /meter)	Field Strength of Harmonics (microvolts/meter)
902-928	50	500

Notes:

- (1) Emissions radiated outside of the specified frequency bands, except for harmonics, shall be attenuated by at least 50 dB below the level of the fundamental or to the general radiated emission limits in Section 15.209, whichever is the lesser attenuation.

Spectrum Parameter	Setting
Attenuation	Auto
Start Frequency	1000 MHz
Stop Frequency	10th carrier harmonic
RB / VB (emission in restricted band)	1MHz / 1MHz for Peak

Receiver Parameter	Setting
Attenuation	Auto
Start ~ Stop Frequency	9kHz~150kHz / RB 200Hz for QP
Start ~ Stop Frequency	150kHz~30MHz / RB 9kHz for QP
Start ~ Stop Frequency	30MHz~1000MHz / RB 120kHz for QP

3.4.2 TEST PROCEDURE

- a. The measuring distance of at 3 m shall be used for measurements at frequency up to 1GHz. For frequencies above 1GHz, any suitable measuring distance may be used.
- b. The EUT was placed on the top of a rotating table 0.8 m for below 1GHz and 1.5m for above 1GHz the ground at a 3 meter open area test site. The table was rotated 360 degrees to determine the position of the highest radiation.
- c. The height of the equipment or of the substitution antenna shall be 0.8 m for below 1GHz and 1.5m for above 1GHz; the height of the test antenna shall vary between 1 m to 4 m. Both horizontal and vertical polarizations of the antenna are set to make the measurement.
- d. The initial step in collecting conducted emission data is a spectrum analyzer peak detector mode pre-scanning the measurement frequency range. Significant peaks are then marked and then Quasi Peak detector mode re-measured.
- e. If the Peak Mode measured value compliance with and lower than Quasi Peak Mode Limit, the EUT shall be deemed to meet QP Limits and then no additional QP Mode measurement performed.
- f. For the actual test configuration, please refer to the related Item –EUT Test Photos.

Note:

Both horizontal and vertical antenna polarities were tested and performed pretest to three orthogonal axis. The worst case emissions were reported

During the radiated emission test, the Spectrum Analyzer was set with the following configurations:

Frequency Band (MHz)	Function	Resolution bandwidth	Video Bandwidth
30 to 1000	Peak	100 kHz	100 kHz
Above 1000	Peak	1 MHz	1 MHz
	Average	1 MHz	10 Hz

3.4.3 DEVIATION FROM TEST STANDARD

No deviation

3.4.4 TEST SETUP

(A) Radiated Emission Test-Up Frequency Below 30MHz

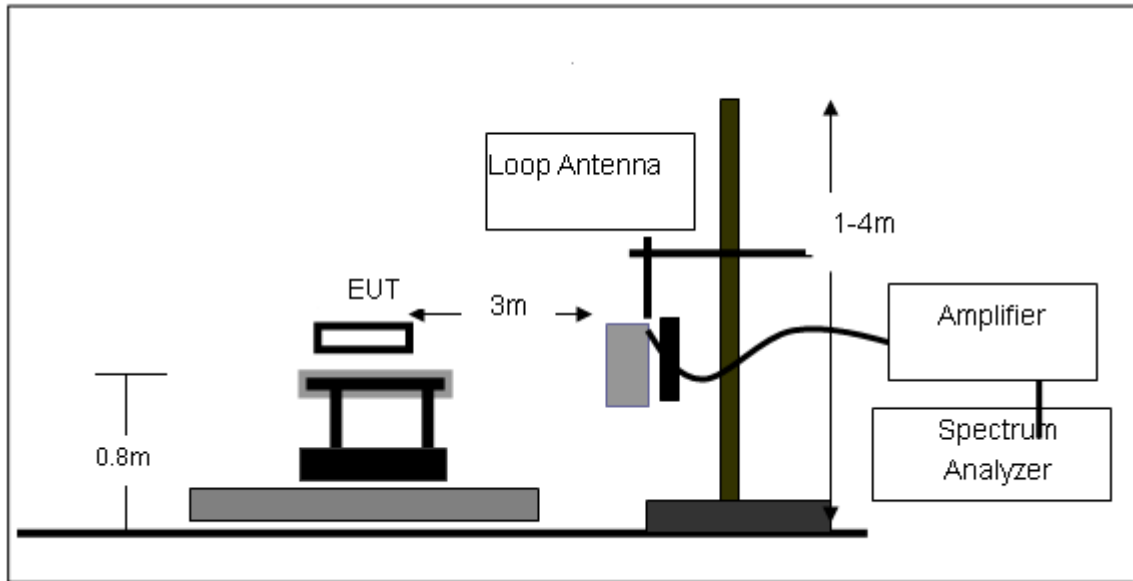

(B) Radiated Emission Test-Up Frequency 30MHz~1GHz

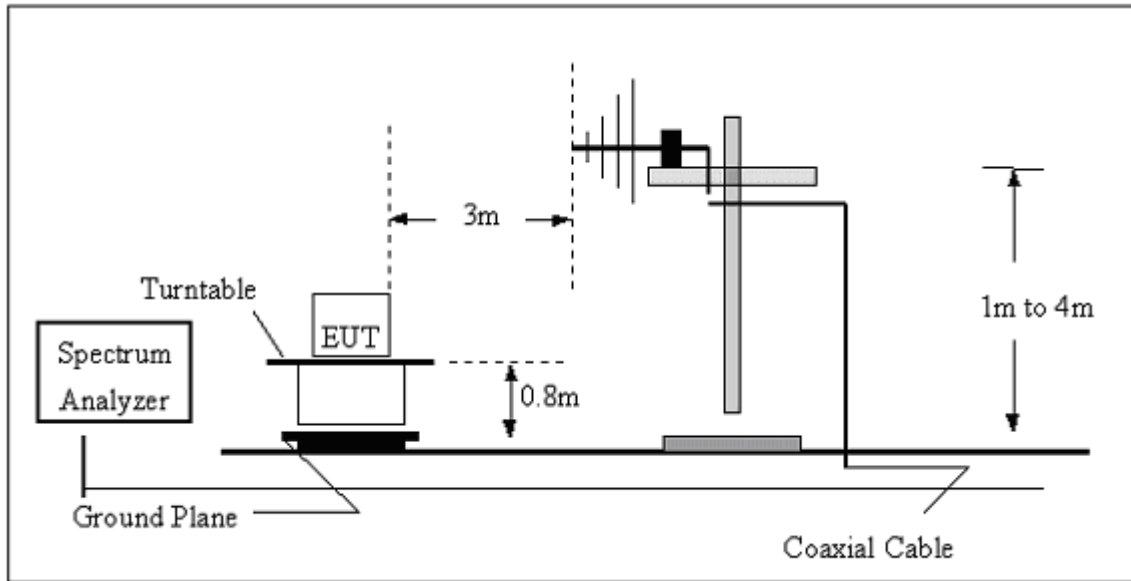

(C) Radiated Emission Test-Up Frequency Above 1GHz

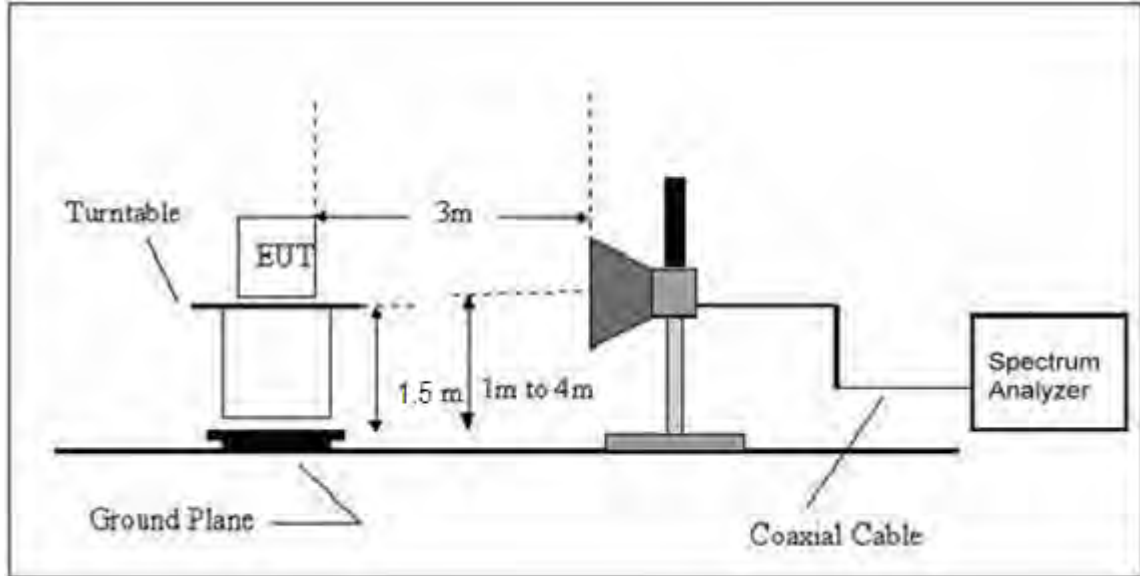

3.4.5 TEST RESULTS (BLOW 30MHz)

EUT :	915Mhz si4463 wireless module with U.FL (IPEX) connector	Model Name. :	RF4463Pro-915-H1
Temperature :	20 °C	Relative Humidity :	48%
Pressure :	1010 hPa	Test Voltage :	DC 3.3V
Test Mode :	TX	Polarization :	--

Freq.	Reading	Limit	Margin	State
(MHz)	(dBuV/m)	(dBuV/m)	(dB)	P/F
--	--	--	--	PASS
--	--	--	--	PASS

NOTE:

The amplitude of spurious emissions which are attenuated by more than 20dB below the permissible value has no need to be reported.

Distance extrapolation factor = $20 \log (\text{specific distance}/\text{test distance})(\text{dB})$;

Limit line = specific limits(dBuv) + distance extrapolation factor.

3.4.6 TEST RESULTS (BETWEEN 30 – 1000 MHZ)

EUT :	915Mhz si4463 wireless module with U.FL (IPEX) connector	Model Name :	RF4463Pro-915-H1
Temperature :	20 °C	Relative Humidity :	48%
Pressure :	1010 hPa	Test Voltage :	DC 3.3V
Test Mode :	TX-902.5MHz	Polarization :	Vertical

Frequency (MHz)	Meter Reading (dBμV)	Factor (dB)	Emission Level (dBμV/m)	Limits (dBμV/m)	Margin (dB)	Detector Type
34.3962	8.19	18.11	26.3	40	-13.7	QP
111.7377	9.09	11.31	20.4	43.5	-23.1	QP
223.7333	9.13	12.17	21.3	46	-24.7	QP
423.5403	10.35	16.05	26.4	46	-19.6	QP
672.8444	8.83	22.07	30.9	46	-15.1	QP
903.3093	68.29	25.61	93.9	114	-20.1	QP

Remark:

1. Factor = Antenna Factor + Cable Loss – Pre-amplifier.

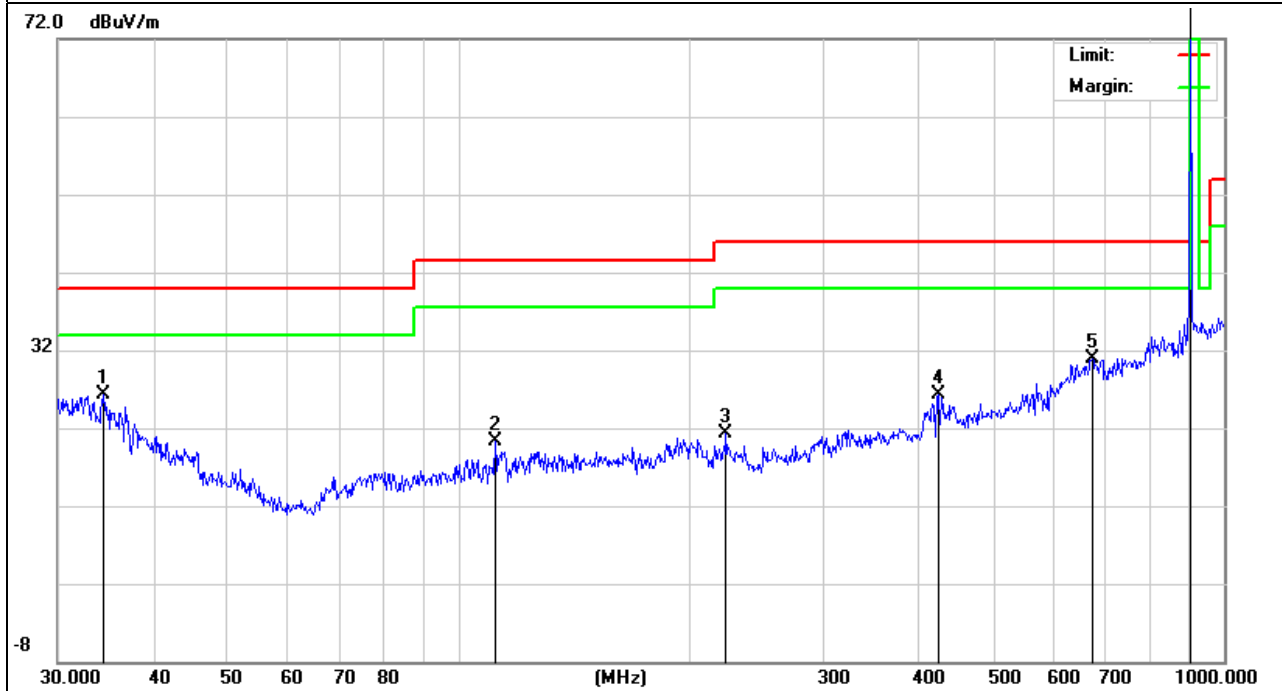

EUT :	915Mhz si4463 wireless module with U.FL (IPEX) connector	Model Name :	RF4463Pro-915-H1
Temperature :	20 °C	Relative Humidity :	48%
Pressure :	1010 hPa	Test Voltage :	DC 3.3V
Test Mode :	TX-902.5MHz	Polarization :	Horizontal

Frequency (MHz)	Meter Reading (dBμV)	Factor (dB)	Emission Level (dBμV/m)	Limits (dBμV/m)	Margin (dB)	Detector Type
32.2924	6.26	19.34	25.6	40	-14.4	QP
47.1599	7.72	10.88	18.6	40	-21.4	QP
104.9033	6.18	11.32	17.5	43.5	-26	QP
171.9944	5.44	13.56	19	43.5	-24.5	QP
336.035	7.49	15.11	22.6	46	-23.4	QP
903.3093	67.09	25.61	92.7	114	-21.3	QP

Remark:

1. Factor = Antenna Factor + Cable Loss – Pre-amplifier.

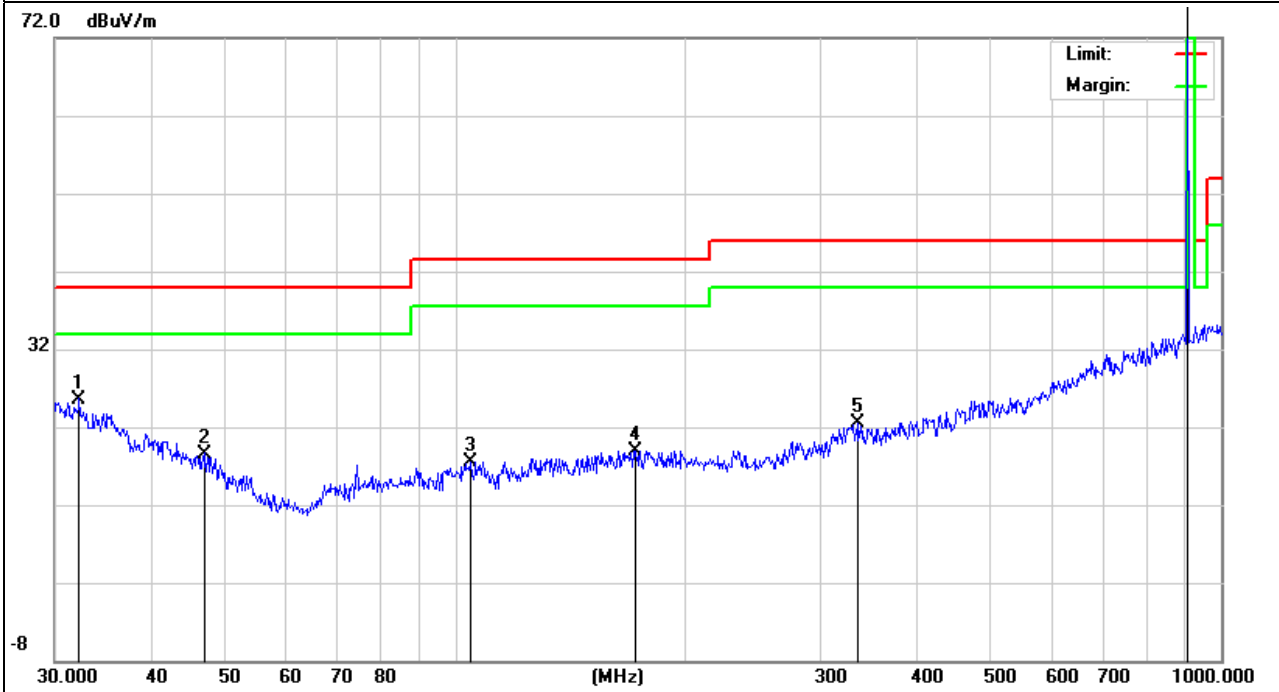

EUT :	915Mhz si4463 wireless module with U.FL (IPEX) connector	Model Name :	RF4463Pro-915-H1
Temperature :	20 °C	Relative Humidity :	48%
Pressure :	1010 hPa	Test Voltage :	DC 3.3V
Test Mode :	TX-927.5MHz	Polarization :	Vertical

Frequency (MHz)	Meter Reading (dBμV)	Factor (dB)	Emission Level (dBμV/m)	Limits (dBμV/m)	Margin (dB)	Detector Type
34.8823	6.49	17.96	24.45	40	-15.55	QP
42.1542	9.32	14.08	23.4	40	-16.6	QP
141.8262	6.51	12.19	18.7	43.5	-24.8	QP
260.1444	9.62	12.08	21.7	46	-24.3	QP
580.7024	6.39	20.01	26.4	46	-19.6	QP
925.7563	67.41	26.59	94	114	-20	QP

Remark:

1. Factor = Antenna Factor + Cable Loss – Pre-amplifier.

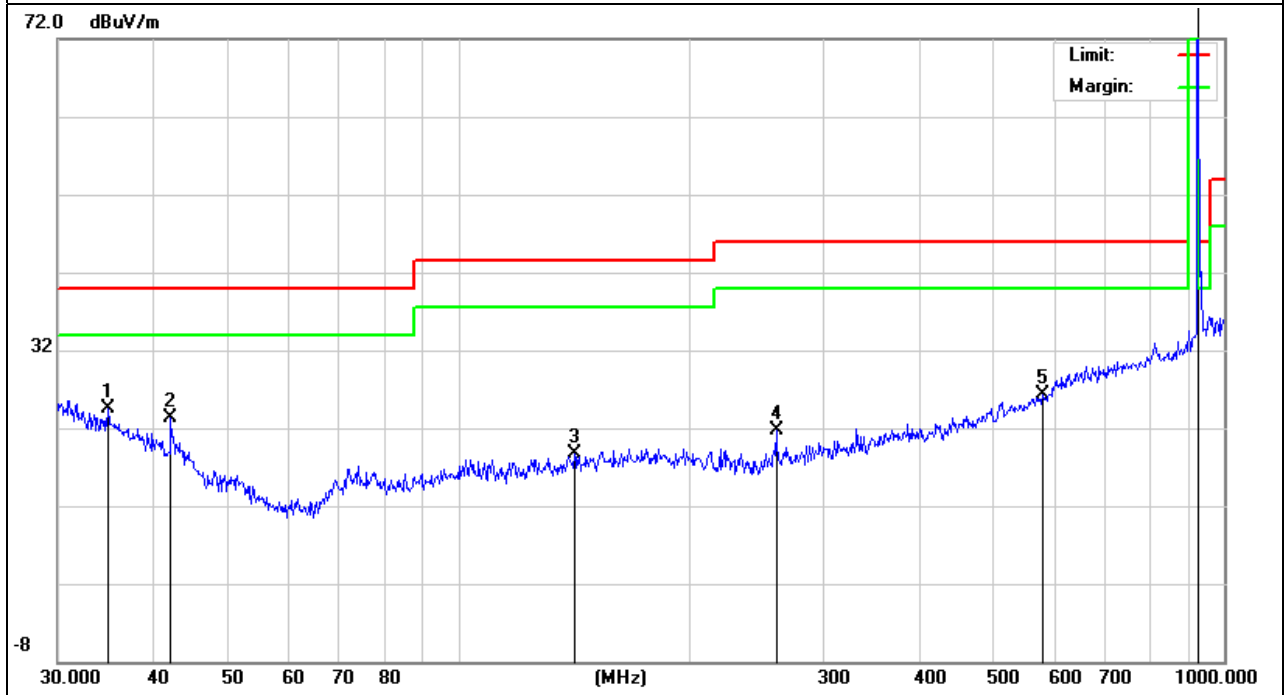

EUT :	915Mhz si4463 wireless module with U.FL (IPEX) connector	Model Name :	RF4463Pro-915-H1
Temperature :	20 °C	Relative Humidity :	48%
Pressure :	1010 hPa	Test Voltage :	DC 3.3V
Test Mode :	TX-927.5MHz	Polarization :	Horizontal

Frequency (MHz)	Meter Reading (dBμV)	Factor (dB)	Emission Level (dBμV/m)	Limits (dBμV/m)	Margin (dB)	Detector Type
36.6375	5.5	17.24	22.74	40	-17.26	QP
50.2324	6.37	10.16	16.53	40	-23.47	QP
106.0126	6.08	11.33	17.41	43.5	-26.09	QP
176.2684	6.54	13.41	19.95	43.5	-23.55	QP
369.4045	6.1	15.92	22.02	46	-23.98	QP
925.7563	70.61	26.59	97.2	114	-16.8	QP

Remark:

1. Factor = Antenna Factor + Cable Loss – Pre-amplifier.

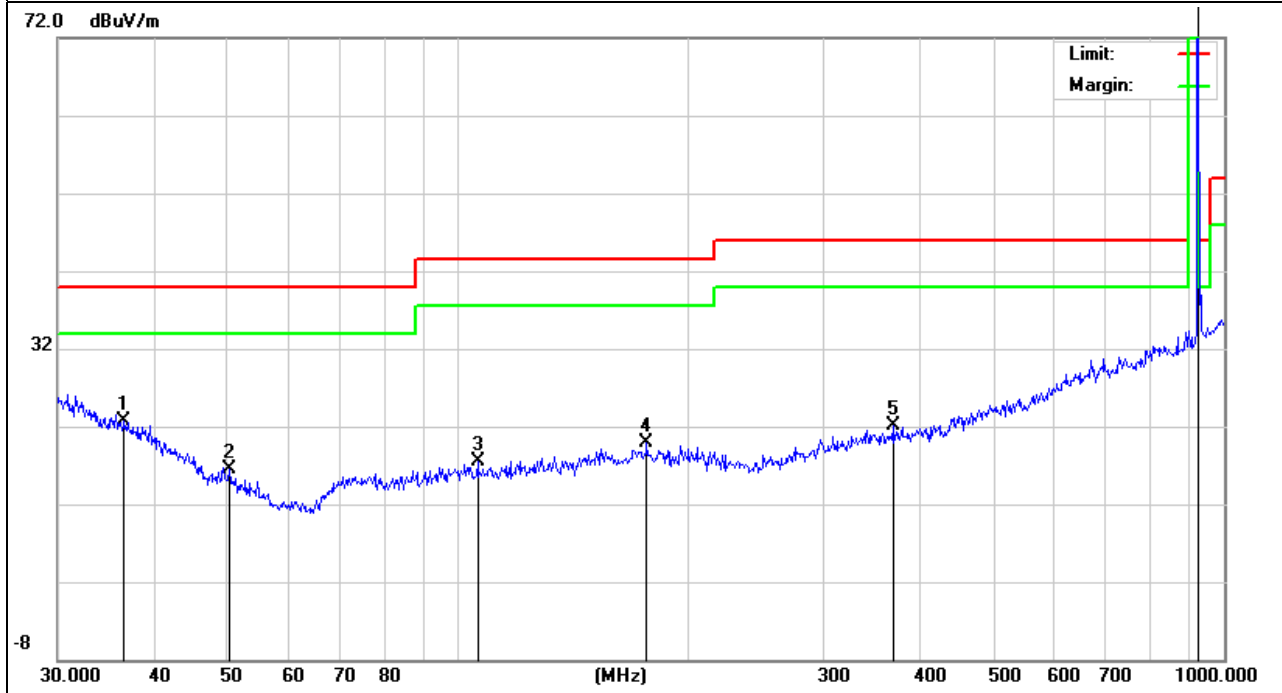

3.4.7 TEST RESULTS (ABOVE 1000 MHZ)

EUT :	915Mhz si4463 wireless module with U.FL (IPEX) connector	Model Name :	RF4463Pro-915-H1
Temperature :	20 °C	Relative Humidity :	48%
Pressure :	1010 hPa	Test Voltage :	DC 3.3V
Test Mode :	TX-902.5MHz	Polarization :	Horizontal

Frequency (MHz)	Meter Reading (dBµV)	Factor (dB)	Emission Level (dBµV/m)	Limits (dBµV/m)	Margin (dB)	Detector Type
1807.5	53.44	-12.34	41.1	74	-32.9	peak
1807.5	34.89	-12.34	22.55	54	-31.45	AVG
2700	53.66	-9.88	43.78	74	-30.22	peak
2700	34.65	-9.88	24.77	54	-29.23	AVG
3635	49.87	-8.07	41.8	74	-32.2	peak
3635	31.69	-8.07	23.62	54	-30.38	AVG
4527.5	47.7	-3.4	44.3	74	-29.7	peak
4527.5	30.24	-3.4	26.84	54	-27.16	AVG

Remark:
 Factor = Antenna Factor + Cable Loss – Pre-amplifier.
 No emission above 18GHz.

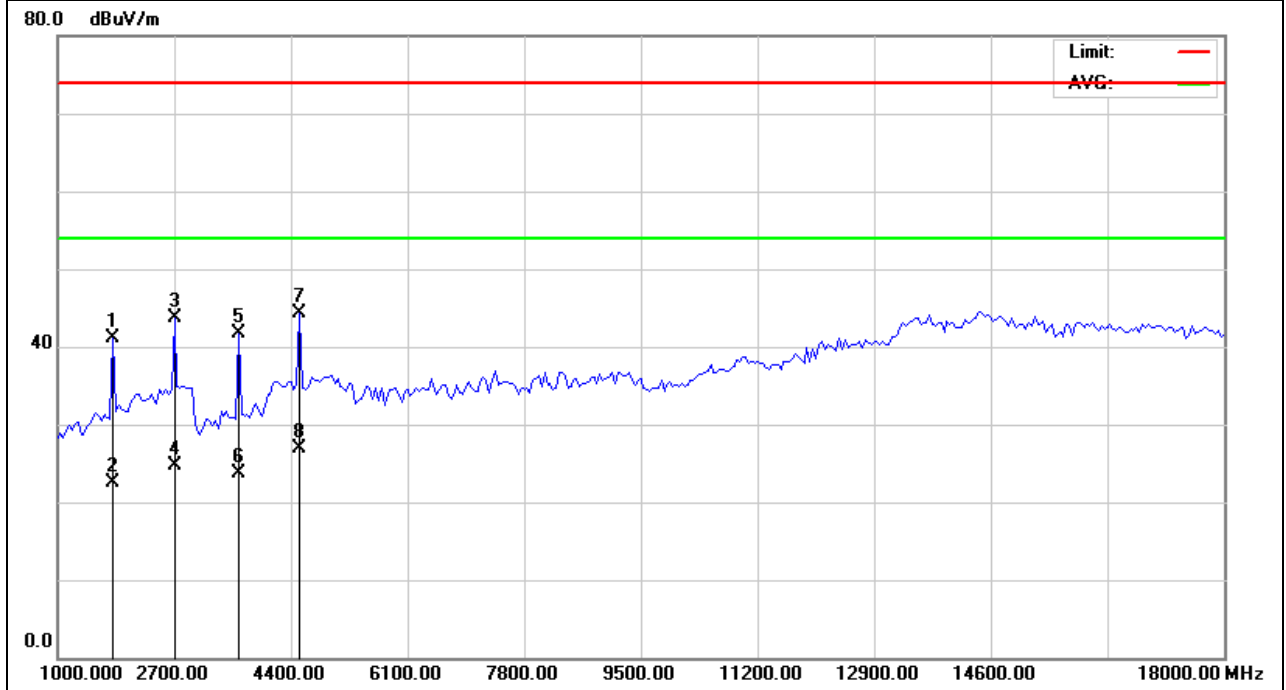

EUT :	915Mhz si4463 wireless module with U.FL (IPEX) connector	Model Name :	RF4463Pro-915-H1
Temperature :	20 °C	Relative Humidity :	48%
Pressure :	1010 hPa	Test Voltage :	DC 3.3V
Test Mode :	TX-902.5MHz	Polarization :	Vertical

Frequency (MHz)	Meter Reading (dBµV)	Factor (dB)	Emission Level (dBµV/m)	Limits (dBµV/m)	Margin (dB)	Detector Type
1807.5	57.34	-12.34	45	74	-29	peak
1807.5	35.21	-12.34	22.87	54	-31.13	AVG
2700	52.93	-9.88	43.05	74	-30.95	peak
2700	34.62	-9.88	24.74	54	-29.26	AVG
3635	48.27	-8.07	40.2	74	-33.8	peak
3635	32.16	-8.07	24.09	54	-29.91	AVG
4527.5	47.8	-3.4	44.4	74	-29.6	peak
4527.5	30.75	-3.4	27.35	54	-26.65	AVG

Remark:
 Factor = Antenna Factor + Cable Loss – Pre-amplifier.
 No emission above 18GHz.

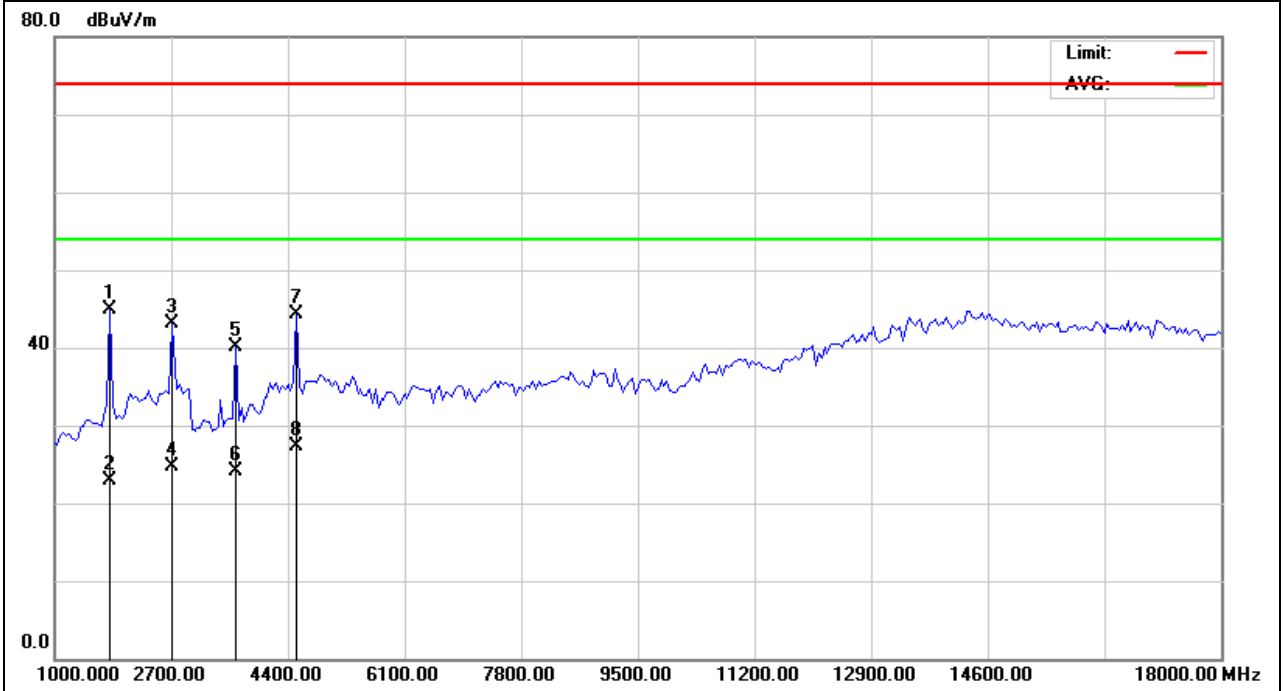

Note: EUT Pre-scan X/Y/Z orientation, only worst case is presented in the report(X orientation).

EUT :	915Mhz si4463 wireless module with U.FL (IPEX) connector	Model Name :	RF4463Pro-915-H1
Temperature :	20 °C	Relative Humidity :	48%
Pressure :	1010 hPa	Test Voltage :	DC 3.3V
Test Mode :	TX-927.5MHz	Polarization :	Horizontal

Frequency (MHz)	Meter Reading (dBμV)	Factor (dB)	Emission Level (dBμV/m)	Limits (dBμV/m)	Margin (dB)	Detector Type
1850	51.29	-11.89	39.4	74	-34.6	peak
1850	32.54	-11.89	20.65	74	-53.35	AVG
2827.5	53.83	-9.83	44	74	-30	peak
2827.5	34.16	-9.83	24.33	74	-49.67	AVG
3720	49.03	-7.73	41.3	74	-32.7	peak
3720	30.47	-7.73	22.74	54	-31.26	AVG
4655	48.51	-2.91	45.6	74	-28.4	peak
4655	29.16	-2.91	26.25	54	-27.75	AVG

Remark:
 Factor = Antenna Factor + Cable Loss – Pre-amplifier.
 No emission above 18GHz.

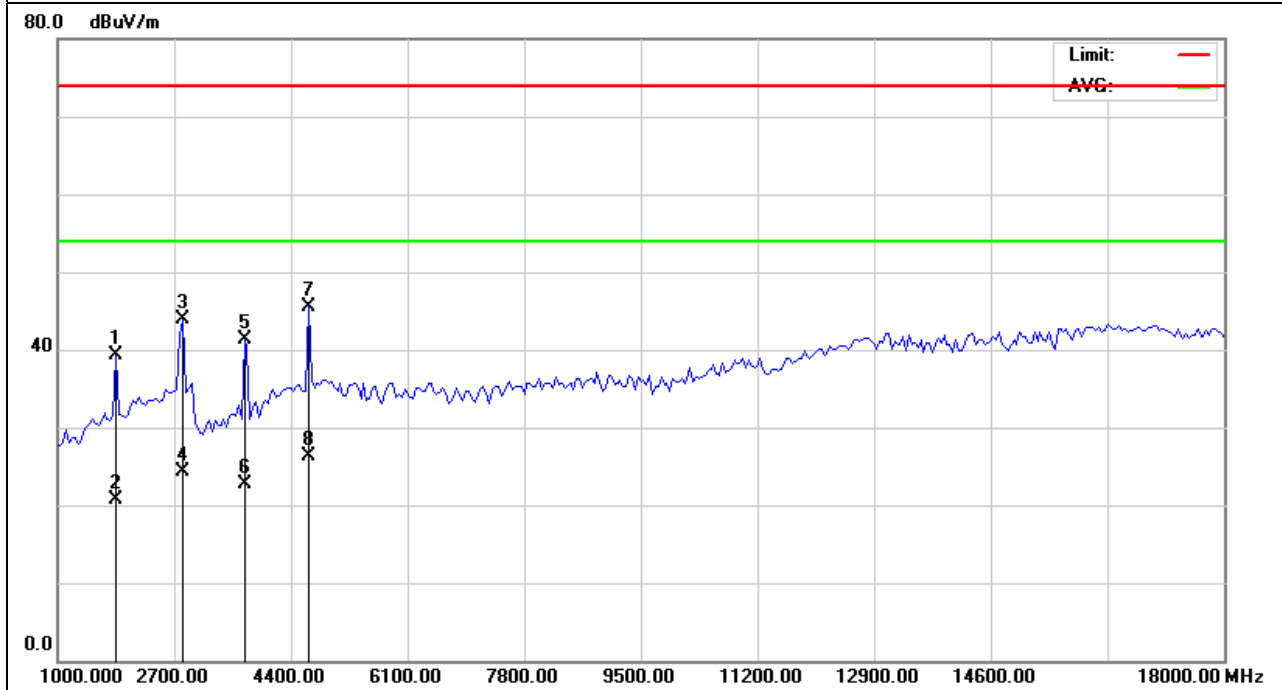

EUT :	915Mhz si4463 wireless module with U.FL (IPEX) connector	Model Name :	RF4463Pro-915-H1
Temperature :	20 °C	Relative Humidity :	48%
Pressure :	1010 hPa	Test Voltage :	DC 3.3V
Test Mode :	TX-927.5MHz	Polarization :	Vertical

Frequency (MHz)	Meter Reading (dBµV)	Factor (dB)	Emission Level (dBµV/m)	Limits (dBµV/m)	Margin (dB)	Detector Type
1850	56.39	-11.89	44.5	74	-29.5	peak
1850	34.42	-11.89	22.53	54	-31.47	AVG
2785	55.27	-9.77	45.5	74	-28.5	peak
2785	35.15	-9.77	25.38	54	-28.62	AVG
3720	52.23	-7.73	44.5	74	-29.5	peak
3720	32.25	-7.73	24.52	54	-29.48	AVG
4655	50.51	-2.91	47.6	74	-26.4	peak
4655	30.75	-2.91	27.84	54	-26.16	AVG

Remark:
 Factor = Antenna Factor + Cable Loss – Pre-amplifier.
 No emission above 18GHz.

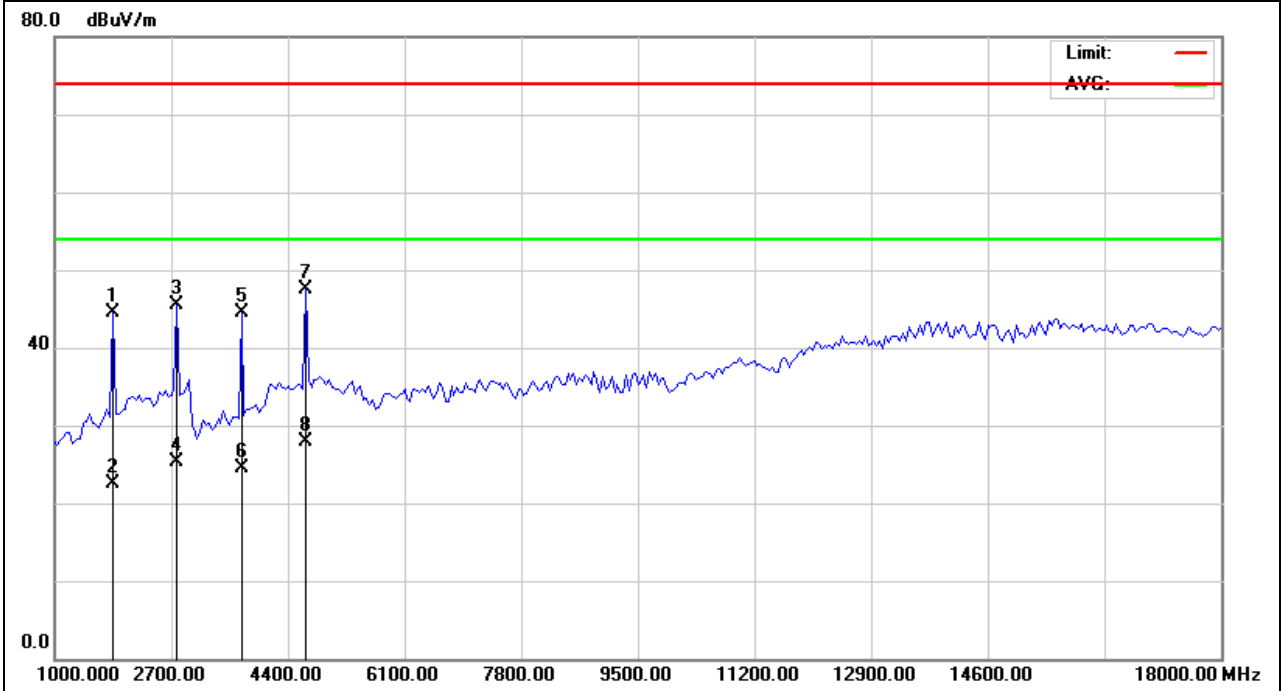

Note: EUT Pre-scan X/Y/Z orientation, only worst case is presented in the report(X orientation).

3.4.8 TEST RESULTS (RESTRICTED BANDS REQUIREMENTS)

EUT :	915Mhz si4463 wireless module with U.FL (IPEX) connector	Model Name :	RF4463Pro-915-H1
Temperature :	20 °C	Relative Humidity :	48%
Pressure :	1010 hPa	Test Voltage :	DC 3.3V
Test Mode :	TX -902.5MHz	Polarization :	Vertical

Frequency (MHz)	Meter Reading (dBμV)	Factor (dB)	Emission Level (dBμV/m)	Limits (dBμV/m)	Margin (dB)	Detector Type
855.0638	7.41	24.82	32.23	46	-13.77	QP
902	6.54	25.55	32.09	46	-13.91	QP
928	6.04	26.72	32.76	46	-13.24	QP
957.8568	7.13	27.99	35.12	46	-10.88	QP

Remark:
Factor = Antenna Factor + Cable Loss – Pre-amplifier.

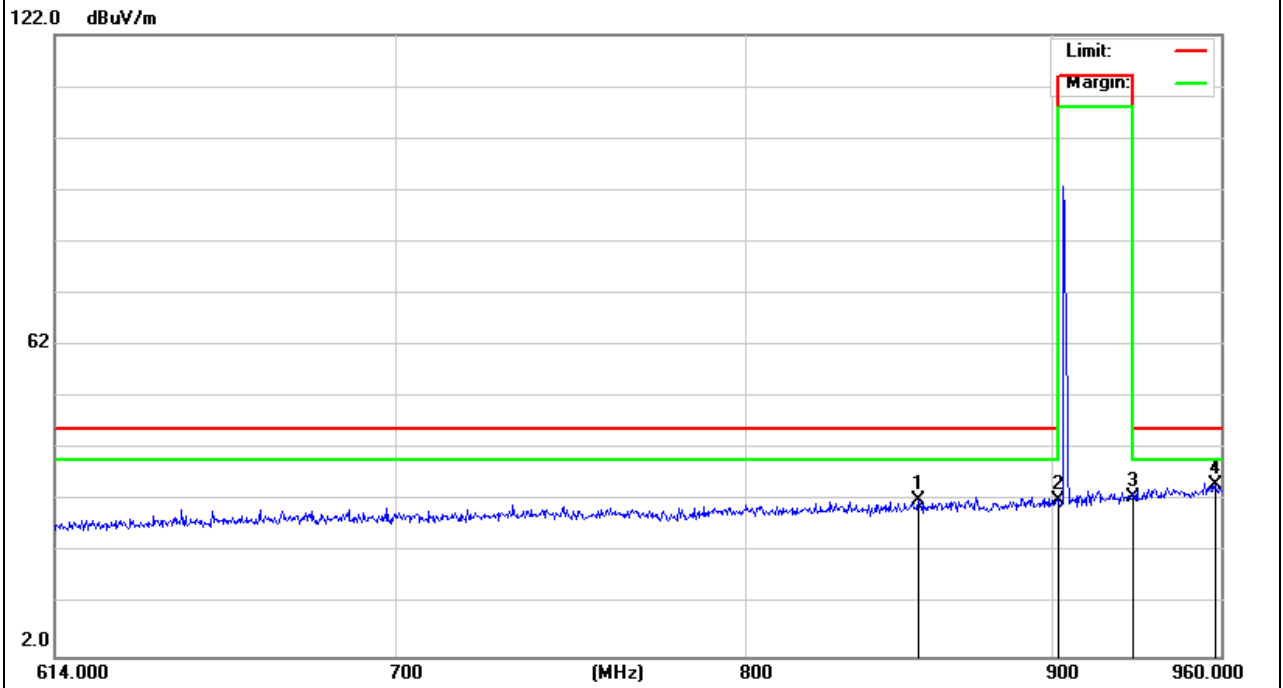

EUT :	915Mhz si4463 wireless module with U.FL (IPEX) connector	Model Name :	RF4463Pro-915-H1
Temperature :	20 °C	Relative Humidity :	48%
Pressure :	1010 hPa	Test Voltage :	DC 3.3V
Test Mode :	TX -902.5MHz	Polarization :	Horizontal

Frequency (MHz)	Meter Reading (dBμV)	Factor (dB)	Emission Level (dBμV/m)	Limits (dBμV/m)	Margin (dB)	Detector Type
836.5416	7.98	24.57	32.55	46	-13.45	QP
902	5.84	25.55	31.39	46	-14.61	QP
928	5.78	26.72	32.5	46	-13.5	QP
940.4646	7.45	27.53	34.98	46	-11.02	QP

Remark:
 Factor = Antenna Factor + Cable Loss – Pre-amplifier.

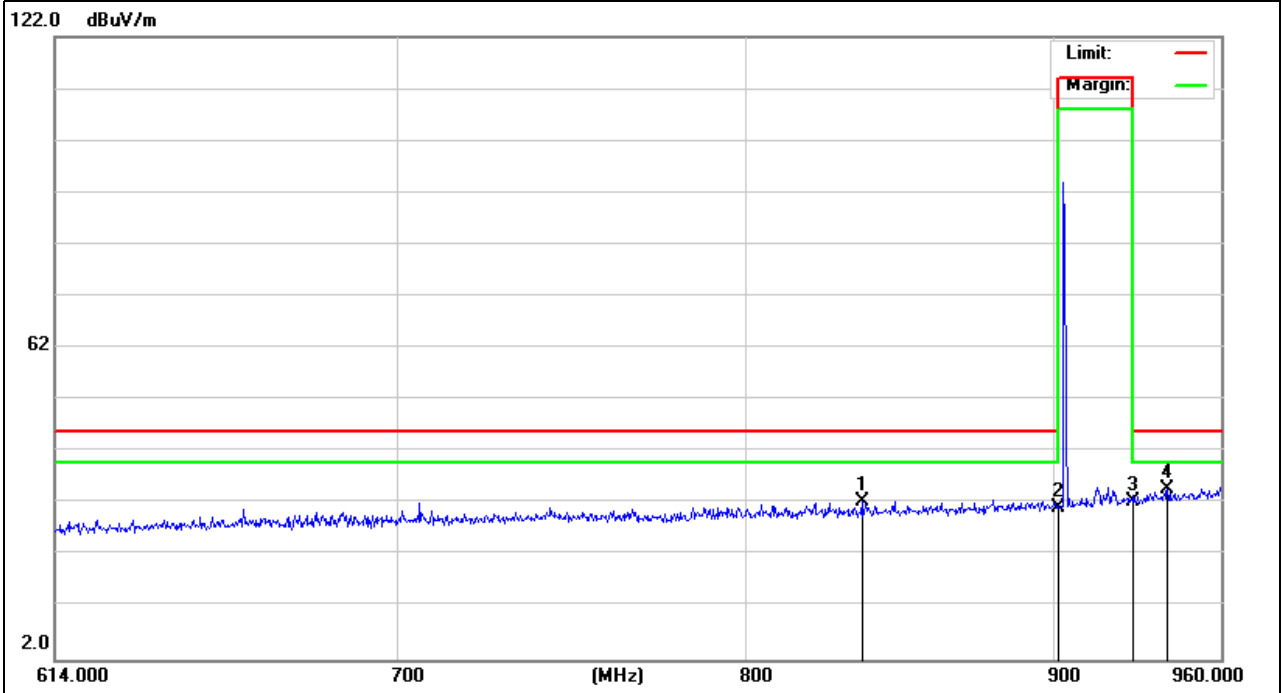

EUT :	915Mhz si4463 wireless module with U.FL (IPEX) connector	Model Name :	RF4463Pro-915-H1
Temperature :	20 °C	Relative Humidity :	48%
Pressure :	1010 hPa	Test Voltage :	DC 3.3V
Test Mode :	TX -927.5MHz	Polarization :	Vertical

Frequency (MHz)	Meter Reading (dBµV)	Factor (dB)	Emission Level (dBµV/m)	Limits (dBµV/m)	Margin (dB)	Detector Type
866.9932	7.77	24.97	32.74	46	-13.26	QP
902	5.87	25.55	31.42	46	-14.58	QP
928	6.96	26.72	33.68	46	-12.32	QP
946.3677	6.59	27.58	34.17	46	-11.83	QP

Remark:
 Factor = Antenna Factor + Cable Loss – Pre-amplifier.

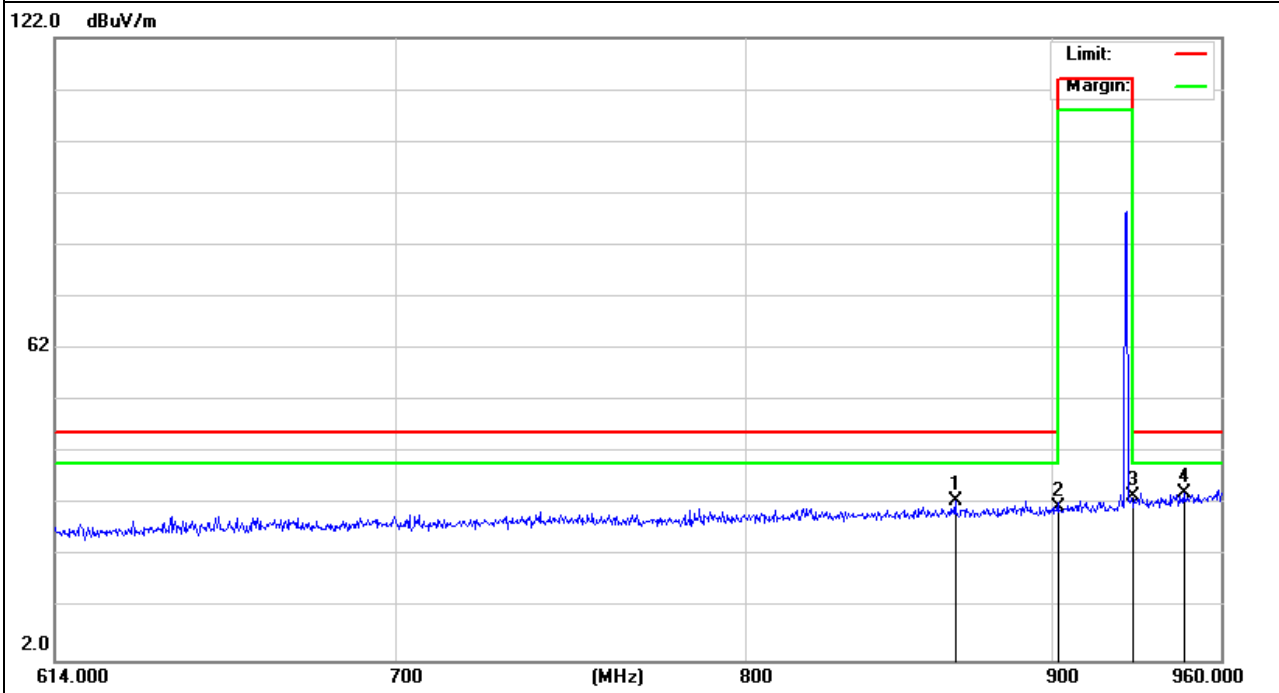

EUT :	915Mhz si4463 wireless module with U.FL (IPEX) connector	Model Name :	RF4463Pro-915-H1
Temperature :	20 °C	Relative Humidity :	48%
Pressure :	1010 hPa	Test Voltage :	DC 3.3V
Test Mode :	TX -927.5MHz	Polarization :	Horizontal

Frequency (MHz)	Meter Reading (dBμV)	Factor (dB)	Emission Level (dBμV/m)	Limits (dBμV/m)	Margin (dB)	Detector Type
814.7708	7.44	24.29	31.73	46	-14.27	QP
902	6.34	25.55	31.89	46	-14.11	QP
928	6.3	26.72	33.02	46	-12.98	QP
941.3057	7.36	27.54	34.9	46	-11.1	QP

Remark:
 Factor = Antenna Factor + Cable Loss – Pre-amplifier.

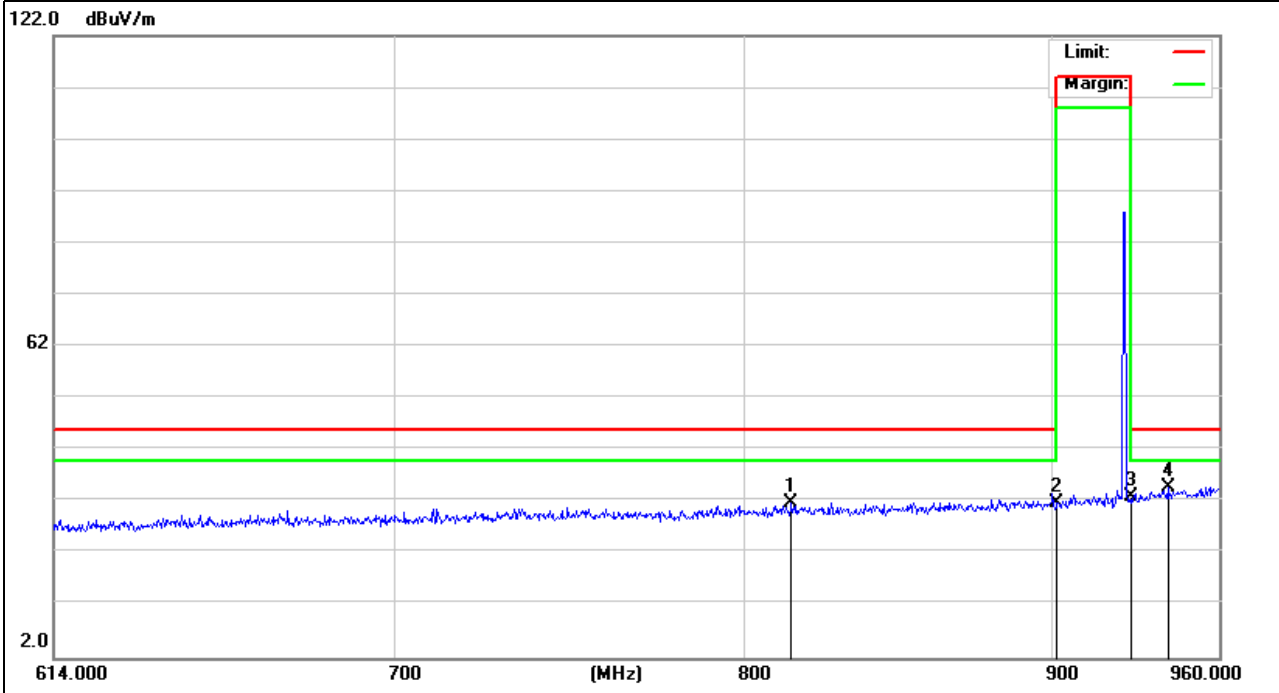

4. BANDWIDTH TEST

4.1 TEST PROCEDURE

- a. The EUT was directly connected to the spectrum analyzer and antenna output port as show in the block diagram below,
- b. Spectrum Setting : RBW= 100KHz, VBW \geq RBW, Sweep time = Auto.

4.2 DEVIATION FROM STANDARD

No deviation.

4.3 TEST SETUP



4.4 TEST RESULTS

EUT :	915Mhz si4463 wireless module with U.FL (IPEX) connector	Model Name :	RF4463Pro-915-H1
Temperature :	26 °C	Relative Humidity :	53%
Pressure :	1020 hPa	Test Power :	DC 3.3V
Test Mode :	TX		

Test Channel	Frequency (MHz)	20 dBc Bandwidth (kHz)
CH01	902.5	350.378
CH26	927.5	332.214

902.5 MHz

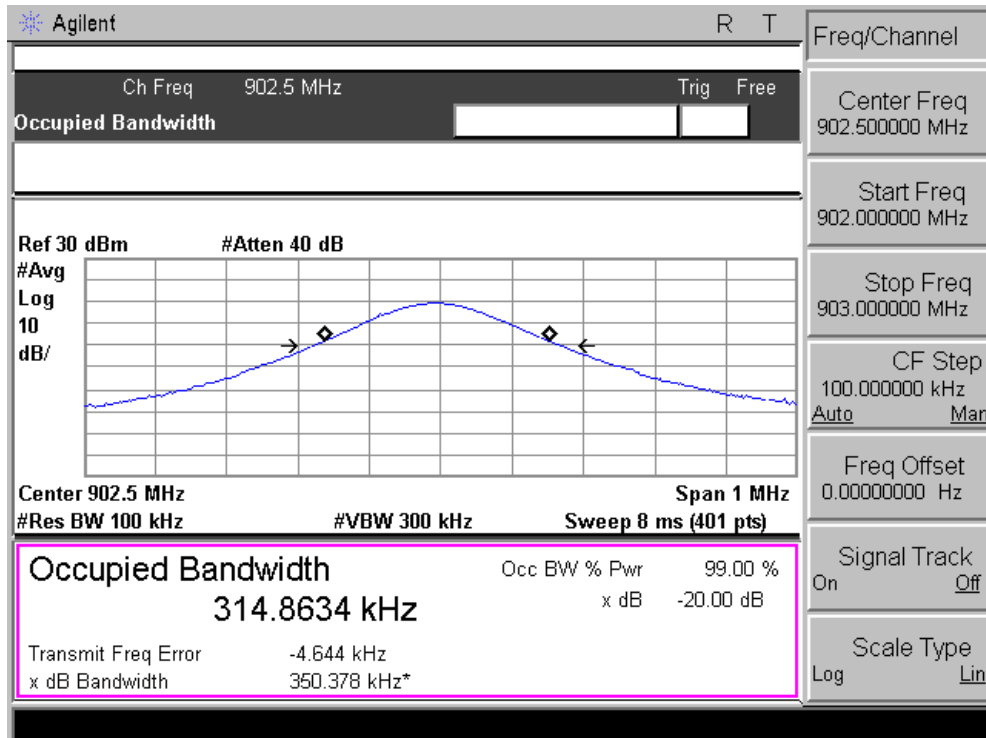

927.5 MHz

Agilent
R T

Ch Freq 927.5 MHz
Trig Free

Occupied Bandwidth

Ref 30 dBm
#Atten 40 dB

#Avg
Log
10
dB/

Center 927.5 MHz
Span 1 MHz

#Res BW 100 kHz
#VBW 300 kHz
Sweep 8 ms (401 pts)

Occupied Bandwidth	Occ BW % Pwr	99.00 %
299.0720 kHz	x dB	-20.00 dB
Transmit Freq Error	-5.133 kHz	
x dB Bandwidth	332.214 kHz*	

Freq/Channel

Center Freq
927.500000 MHz

Start Freq
927.000000 MHz

Stop Freq
928.000000 MHz

CF Step
100.000000 kHz
Auto Man

Freq Offset
0.00000000 Hz

Signal Track
On Off

Scale Type
Log Lin

5. EUT TEST PHOTO

Radiated Measurement Photos

