



# FCC RADIO TEST REPORT

## FCC ID: 2AD66-1276C1

**Product :** LoRa RF Transceiver Module

**Trade Mark :** G-NiceRF

**Model Name :** LoRa 1276-C1-915

**Serial Model :** N/A

**Report No. :** SER171019769001E

### Prepared for

NiceRF Wireless Technology LTD.,  
309-314, Bldg A, Hongdu business building, Xin'an street, Zone 43, Baoan  
Dist, Shenzhen 518101, China

### Prepared by

NTEK Testing Technology Co., Ltd.  
1/F, Building E, Fenda Science Park, Sanwei Community, Xixiang Street  
Bao'an District, Shenzhen 518126 P.R. China  
Tel.: +86-755-6115 6588 Fax.: +86-755-6115 6599  
Website: <http://www.ntek.org.cn>



<b>Table of Contents</b>	<b>Page</b>
<b>1 . SUMMARY OF TEST RESULTS</b>	<b>4</b>
1.1 TEST FACILITY	5
1.2 MEASUREMENT UNCERTAINTY	5
<b>2 . GENERAL INFORMATION</b>	<b>6</b>
2.1 GENERAL DESCRIPTION OF EUT	6
2.2 DESCRIPTION OF TEST MODES	8
2.3 BLOCK DIGRAM SHOWING THE CONFIGURATION OF SYSTEM TESTED	9
2.4 DESCRIPTION OF SUPPORT UNITS(CONDUCTED MODE)	10
<b>3 . ANTENNA REQUIREMENT</b>	<b>12</b>
3.1 STANDARD REQUIREMENT	12
3.2 EUT ANTENNA	12
3.3 CONDUCTED EMISSION MEASUREMENT	13
3.3.1 POWER LINE CONDUCTED EMISSION LIMITS	13
3.3.2 TEST PROCEDURE	14
3.3.3 DEVIATION FROM TEST STANDARD	14
3.3.4 TEST SETUP	14
3.4 RADIATED EMISSION MEASUREMENT	15
3.4.1 RADIATED EMISSION LIMITS	15
3.4.2 TEST PROCEDURE	16
3.4.3 DEVIATION FROM TEST STANDARD	16
3.4.4 TEST SETUP	17
3.4.5 TEST RESULTS (BLOW 30MHZ)	19
3.4.6 TEST RESULTS (BETWEEN 30 – 1000 MHZ)	20
3.4.7 TEST RESULTS (ABOVE 1000 MHZ)	32
3.4.8 TEST RESULTS (RESTRICTED BANDS REQUIREMENTS)	44
<b>4 . BANDWIDTH TEST</b>	<b>52</b>
4.1 TEST PROCEDURE	52
4.2 DEVIATION FROM STANDARD	52
4.3 TEST SETUP	52
4.4 TEST RESULTS	53
<b>5 . EUT TEST PHOTO</b>	<b>55</b>
<b>APPENDIX-PHOTOGRAPHS OF EUT CONSTRUCTIONAL DETAILS</b>	

## 1. SUMMARY OF TEST RESULTS

Test procedures according to the technical standards:

<b>FCC Part15, Subpart C (15.249)</b>			
Standard Section	Test Item	Judgment	Remark
15.207	Conducted Emission	N/A	
15.203	Antenna Requirement	Pass	
15.249	Radiated Spurious Emission	Pass	
15.205	Band Edge Emission	Pass	
15.249	Occupied Bandwidth	Pass	

**1.1 TEST FACILITY**

NTEK Testing Technology Co., Ltd

Add. : 1/F, Building E, Fenda Science Park, Sanwei Community, Xixiang Street, Bao'an District, Shenzhen 518126 P.R. China.

FCC FRN Registration No.: 463705; IC Registration No.:9270A-1

CNAS Registration No.:L5516

**1.2 MEASUREMENT UNCERTAINTY**

The reported uncertainty of measurement  $y \pm U$ , where expanded uncertainty  $U$  is based on a standard uncertainty multiplied by a coverage factor of  $k=2$ , providing a level of confidence of approximately **95 %**.

No.	Item	Uncertainty
1	Conducted Emission Test	$\pm 1.38\text{dB}$
2	RF power,conducted	$\pm 0.16\text{dB}$
3	Spurious emissions,conducted	$\pm 0.21\text{dB}$
4	All emissions,radiated(<1G)	$\pm 4.68\text{dB}$
5	All emissions,radiated(>1G)	$\pm 4.89\text{dB}$
6	Temperature	$\pm 0.5^\circ\text{C}$
7	Humidity	$\pm 2\%$

## 2. GENERAL INFORMATION

### 2.1 GENERAL DESCRIPTION OF EUT

Equipment	LoRa RF Transceiver Module
Trade Mark	G-NiceRF
Model Name	LoRa 1276-C1-915
Serial Model	N/A
Model Difference	N/A
Product Description	The EUT is a LoRa RF Transceiver Module
	Operation Frequency: 902.5 MHz -927.5MHz
	Modulation Type: LORA
	Antenna Designation: ANT A: Cable antenna ANT B: Spring antenna
	Antenna Gain(Peak) ANT A :2.15 dBi ANT B :2.15dBi
	Test Set the power level 4
Based on the application, features, or specification exhibited in User's Manual, the EUT is considered as an ITE/Computing Device. More details of EUT technical specification, please refer to the User's Manual.	
Channel List	Please refer to the Note 2.
Adapter	N/A
Battery	N/A
SW Version	V1.0
HW Version	PCB V1.1

Note:

1. For a more detailed features description, please refer to the manufacturer's specifications or the User's Manual.

2.

Channel	Frequency (MHz)	Channel	Frequency (MHz)
01	902.5	14	915.5
02	903.5	15	916.5
03	904.5	16	917.5
04	905.5	17	918.5
05	906.5	18	919.5
06	907.5	19	920.5
07	908.5	20	921.5
08	909.5	21	922.5
09	910.5	22	923.5
10	911.5	23	924.5
11	912.5	24	925.5
12	913.5	25	926.5
13	914.5	26	927.5

3.

Table for Filed Antenna

Ant	Brand	Model Name	Antenna Type	Connector	Gain (dBi)	NOTE
A	N/A	N/A	Cable Antenna	N/A	2.15	Antenna
B	N/A	N/A	Spring Antenna	N/A	2.15	Antenna

## 2.2 DESCRIPTION OF TEST MODES

To investigate the maximum EMI emission characteristics generates from EUT, the test system was pre-scanning tested base on the consideration of following EUT operation mode or test configuration mode which possible have effect on EMI emission level. Each of these EUT operation mode(s) or test configuration mode(s) mentioned above was evaluated respectively.

Pretest Mode	Description
Mode 1	CH 01
Mode 2	CH 14
Mode 3	CH 26
Mode 4	Link mode

For Radiated Emission	
Final Test Mode	Description
Mode 1	CH 01
Mode 2	CH 14
Mode 3	CH 26

Note:

- (1) The measurements are performed at the highest, lowest channels.
- (2) This EUT sets the transmit power level to 0 level when testing



### 2.3 BLOCK DIGRAM SHOWING THE CONFIGURATION OF SYSTEM TESTED

Radiated Spurious Emission Test

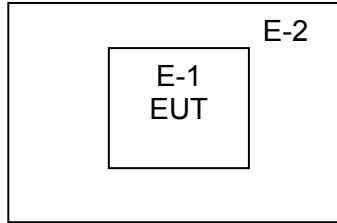

## 2.4 DESCRIPTION OF SUPPORT UNITS(CONDUCTED MODE)

The EUT has been tested as an independent unit together with other necessary accessories or support units. The following support units or accessories were used to form a representative test configuration during the tests.

Item	Equipment	Mfr/Brand	Model/Type No.	Series No.	Note
E-1	LoRa RF Transceiver Module	G-NiceRF	LoRa 1276-C1-915	N/A	EUT
E-2	Power supply base	N/A	N/A	N/A	Auxiliary equipment

Item	Shielded Type	Ferrite Core	Length	Note

**Note:**

- (1) The support equipment was authorized by Declaration of Confirmation.
- (2) For detachable type I/O cable should be specified the length in cm in 『Length』 column.

## 2.4.1 EQUIPMENTS LIST FOR ALL TEST ITEMS

**Radiation Test equipment**

Item	Kind of Equipment	Manufacturer	Type No.	Serial No.	Last calibration	Calibrated until	Calibration period
1	Spectrum Analyzer	Agilent	E4407B	160400005	Jul. 07. 2017	Jul. 06. 2018	1 year
2	Test Receiver	R&S	ESPI	101318	Jul. 07. 2017	Jul. 06. 2018	1 year
3	Bilog Antenna	TESEQ	CBL6111D	31216	Jul. 07. 2017	Jul. 06. 2018	1 year
4	50Ω Coaxial Switch	Anritsu	MP59B	6200264416	Jul. 07. 2017	Jul. 06. 2018	1 year
5	Spectrum Analyzer	ADVANTEST	R3132	150900201	Jul. 07. 2017	Jul. 06. 2018	1 year
6	Horn Antenna	EM	EM-AH-10180	2011071402	Jul. 07. 2017	Jul. 06. 2018	1 year
7	Horn Ant	Schwarzbeck	BBHA 9170	9170-181	Jul. 07. 2017	Jul. 06. 2018	1 year
8	Amplifier	EM	EM-30180	060538	Jul. 07. 2017	Jul. 06. 2018	1 year
9	Loop Antenna	ARA	PLA-1030/B	1029	Jul. 07. 2017	Jul. 06. 2018	1 year
10	Power Meter	R&S	NRVS	100696	Jul. 07. 2017	Jul. 06. 2018	1 year

**Conduction Test equipment**

Item	Kind of Equipment	Manufacturer	Type No.	Serial No.	Last calibration	Calibrated until	Calibration period
1	Test Receiver	R&S	ESCI	101160	Jul. 07. 2017	Jul. 06. 2018	1 year
2	LISN	R&S	ENV216	101313	Jul. 07. 2017	Jul. 06. 2018	1 year
3	LISN	EMCO	3816/2	00042990	Jul. 07. 2017	Jul. 06. 2018	1 year
4	50Ω Coaxial Switch	Anritsu	MP59B	6200264417	Jul. 07. 2017	Jul. 06. 2018	1 year
5	Passive Voltage Probe	R&S	ESH2-Z3	100196	Jul. 07. 2017	Jul. 06. 2018	1 year
6	Absorbing clamp	R&S	MOS-21	100423	Jul. 07. 2017	Jul. 06. 2018	1 year

### **3. ANTENNA REQUIREMENT**

#### **3.1 STANDARD REQUIREMENT**

15.203 requirement: For intentional device, according to 15.203: an intentional radiator shall be designed to ensure that no antenna other than that furnished by the responsible party shall be used with the device.

#### **3.2 EUT ANTENNA**

The EUT antenna is spring antenna, details to see internal photo, it comply with the standard requirement.

### 3.3 CONDUCTED EMISSION MEASUREMENT

#### 3.3.1 POWER LINE CONDUCTED EMISSION Limits (Frequency Range 150KHz-30MHz)

FREQUENCY (MHz)	Class A (dBuV)		Class B (dBuV)		Standard
	Quasi-peak	Average	Quasi-peak	Average	
0.15 -0.5			66 - 56 *	56 - 46 *	CISPR
0.50 -5.0			56.00	46.00	CISPR
5.0 -30.0			60.00	50.00	CISPR

Note:

- (1) The tighter limit applies at the band edges.
- (2) The limit of " \* " marked band means the limitation decreases linearly with the logarithm of the frequency in the range.

The following table is the setting of the receiver

Receiver Parameters	Setting
Attenuation	10 dB
Start Frequency	0.15 MHz
Stop Frequency	30 MHz
IF Bandwidth	9 kHz

**3.3.2 TEST PROCEDURE**

- a. The EUT was placed 0.4 meters from the horizontal ground plane with EUT being connected to the power mains through a line impedance stabilization network (LISN). All other support equipments powered from additional LISN(s). The LISN provide 50 Ohm/ 50uH of coupling impedance for the measuring instrument.
- b. Interconnecting cables that hang closer than 40 cm to the ground plane shall be folded back and forth in the center forming a bundle 30 to 40 cm long.
- c. I/O cables that are not connected to a peripheral shall be bundled in the center. The end of the cable may be terminated, if required, using the correct terminating impedance. The overall length shall not exceed 1 m.
- d. LISN at least 80 cm from nearest part of EUT chassis.
- e. For the actual test configuration, please refer to the related Item –EUT Test Photos.

**3.3.3 DEVIATION FROM TEST STANDARD**

No deviation

**3.3.4 TEST SETUP**

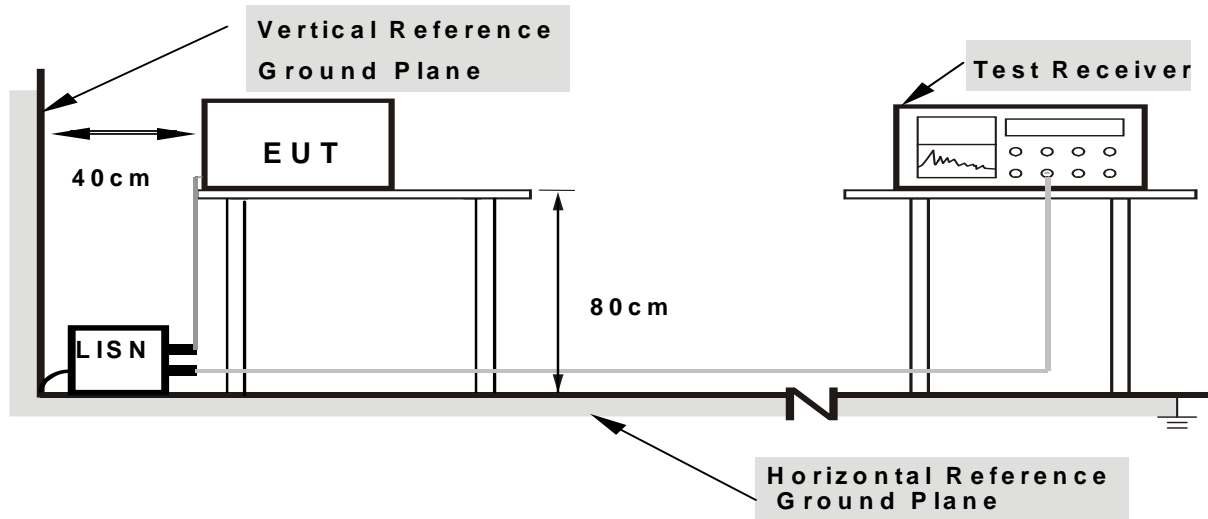

- Note:**
- 1. Support units were connected to second LISN.
  - 2. Both of LISNs (AMN) are 80 cm from EUT and at least 80 from other units and other metal planes

### 3.4 RADIATED EMISSION MEASUREMENT

#### 3.4.1 Radiated Emission Limits ( FCC 15.209 )

Frequencies (MHz)	Field Strength (micorvolts/meter)	Measurement Distance (meters)
0.009~0.490	2400/F(KHz)	300
0.490~1.705	24000/F(KHz)	30
1.705~30.0	30	30
Frequency (MHz)	Limit (dBuV)	
30~88	40	3
88~216	43.5	3
216~960	46	3
960 -10000	54.00	3
*902 - 928	94.00	3

Note:

- (1) The tighter limit applies at the band edges.
- (2) Emission level (dBuV/m)=20log Emission level (uV/m).
- (3) \*Note: This is the limit for the fundamental frequency.

#### LIMITS OF RADIATED EMISSION MEASUREMENT ( FCC 15.249)

Frequency of Emission (MHz)	Field Strength of fundamental ((millivolts /meter)	Field Strength of Harmonics (microvolts/meter)
902-928	50	500

Notes:

- (1) Emissions radiated outside of the specified frequency bands, except for harmonics, shall be attenuated by at least 50 dB below the level of the fundamental or to the general radiated emission limits in Section 15.209, whichever is the lesser attenuation.

Spectrum Parameter	Setting
Attenuation	Auto
Start Frequency	1000 MHz
Stop Frequency	10th carrier harmonic
RB / VB (emission in restricted band)	1MHz / 1MHz for Peak

Receiver Parameter	Setting
Attenuation	Auto
Start ~ Stop Frequency	9kHz~150kHz / RB 200Hz for QP
Start ~ Stop Frequency	150kHz~30MHz / RB 9kHz for QP
Start ~ Stop Frequency	30MHz~1000MHz / RB 120kHz for QP

**3.4.2 TEST PROCEDURE**

- a. The measuring distance of at 3 m shall be used for measurements at frequency up to 1GHz. For frequencies above 1GHz, any suitable measuring distance may be used.
- b. The EUT was placed on the top of a rotating table 0.8 m for below 1GHz and 1.5m for above 1GHz the ground at a 3 meter open area test site. The table was rotated 360 degrees to determine the position of the highest radiation.
- c. The height of the equipment or of the substitution antenna shall be 0.8 m for below 1GHz and 1.5m for above 1GHz; the height of the test antenna shall vary between 1 m to 4 m. Both horizontal and vertical polarizations of the antenna are set to make the measurement.
- d. The initial step in collecting conducted emission data is a spectrum analyzer peak detector mode pre-scanning the measurement frequency range. Significant peaks are then marked and then Quasi Peak detector mode re-measured.
- e. If the Peak Mode measured value compliance with and lower than Quasi Peak Mode Limit, the EUT shall be deemed to meet QP Limits and then no additional QP Mode measurement performed.
- f. For the actual test configuration, please refer to the related Item –EUT Test Photos.

Note:

Both horizontal and vertical antenna polarities were tested and performed pretest to three orthogonal axis. The worst case emissions were reported

During the radiated emission test, the Spectrum Analyzer was set with the following configurations:

Frequency Band (MHz)	Function	Resolution bandwidth	Video Bandwidth
30 to 1000	Peak	100 kHz	100 kHz
Above 1000	Peak	1 MHz	1 MHz
	Average	1 MHz	10 Hz

**3.4.3 DEVIATION FROM TEST STANDARD**

No deviation



### 3.4.4 TEST SETUP

(A) Radiated Emission Test-Up Frequency Below 30MHz

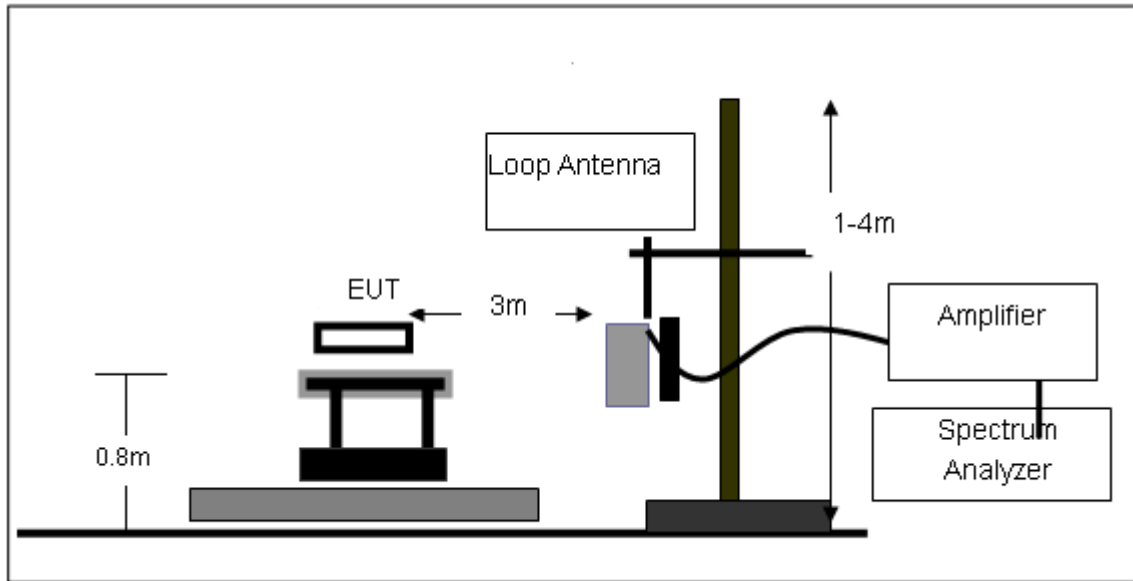

(B) Radiated Emission Test-Up Frequency 30MHz~1GHz

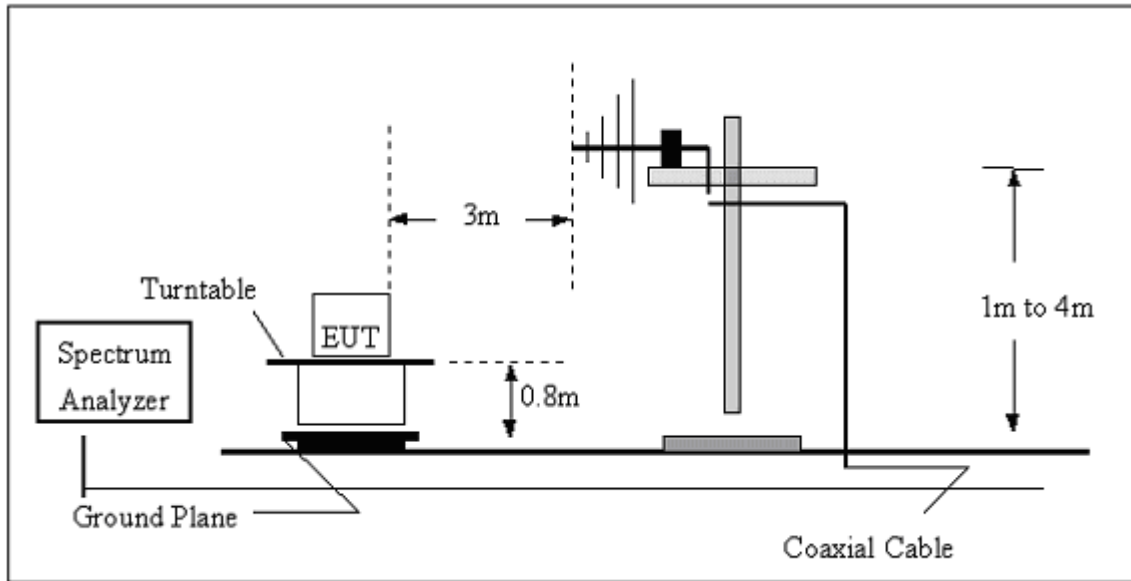

(C) Radiated Emission Test-Up Frequency Above 1GHz

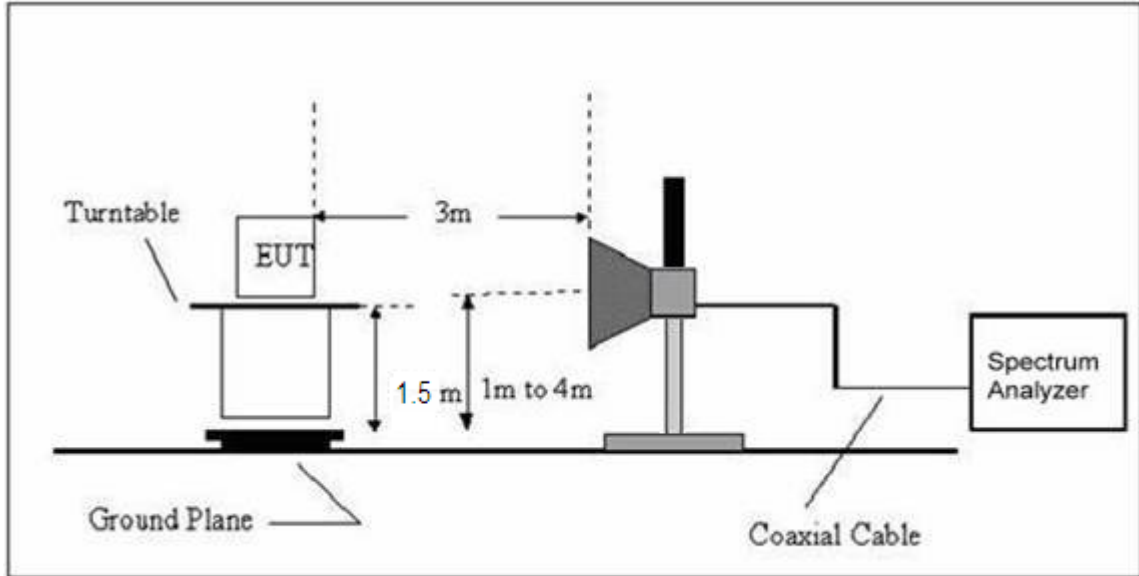

### 3.4.5 TEST RESULTS (BLOW 30MHz)

EUT :	LoRa RF Transceiver Module	Model Name. :	LoRa 1276-C1-915
Temperature :	20 °C	Relative Humidity :	48%
Pressure :	1010 hPa	Test Voltage :	DC 3.3V
Test Mode :	TX	Polarization :	--

Freq.	Reading	Limit	Margin	State
(MHz)	(dBuV/m)	(dBuV/m)	(dB)	P/F
--	--	--	--	PASS
--	--	--	--	PASS

**NOTE:**

The amplitude of spurious emissions which are attenuated by more than 20dB below the permissible value has no need to be reported.

Distance extrapolation factor =  $20 \log(\text{specific distance}/\text{test distance})(\text{dB})$ ;

Limit line = specific limits(dBuv) + distance extrapolation factor.

### 3.4.6 TEST RESULTS (BETWEEN 30 – 1000 MHZ)

EUT :	LoRa RF Transceiver Module	Model Name :	LoRa 1276-C1-915
Temperature :	20 °C	Relative Humidity :	48%
Pressure :	1010 hPa	Test Voltage :	DC 3.3V
Test Mode :	TX-902.5MHz (ANT A)	Polarization :	Vertical

Frequency (MHz)	Meter Reading (dBμV)	Factor (dB)	Emission Level (dBμV/m)	Limits (dBμV/m)	Margin (dB)	Detector Type
48.8429	15.49	13.36	28.85	40	-11.15	QP
52.9453	14.91	12.8	27.71	40	-12.29	QP
202.8103	6.1	13.84	19.94	43.5	-23.56	QP
318.817	7.91	13.39	21.3	46	-24.7	QP
620.7096	7.03	20.05	27.08	46	-18.92	QP
903.3094	63.22	24.67	87.89	94	-6.11	QP

Remark:

1. Factor = Antenna Factor + Cable Loss – Pre-amplifier.

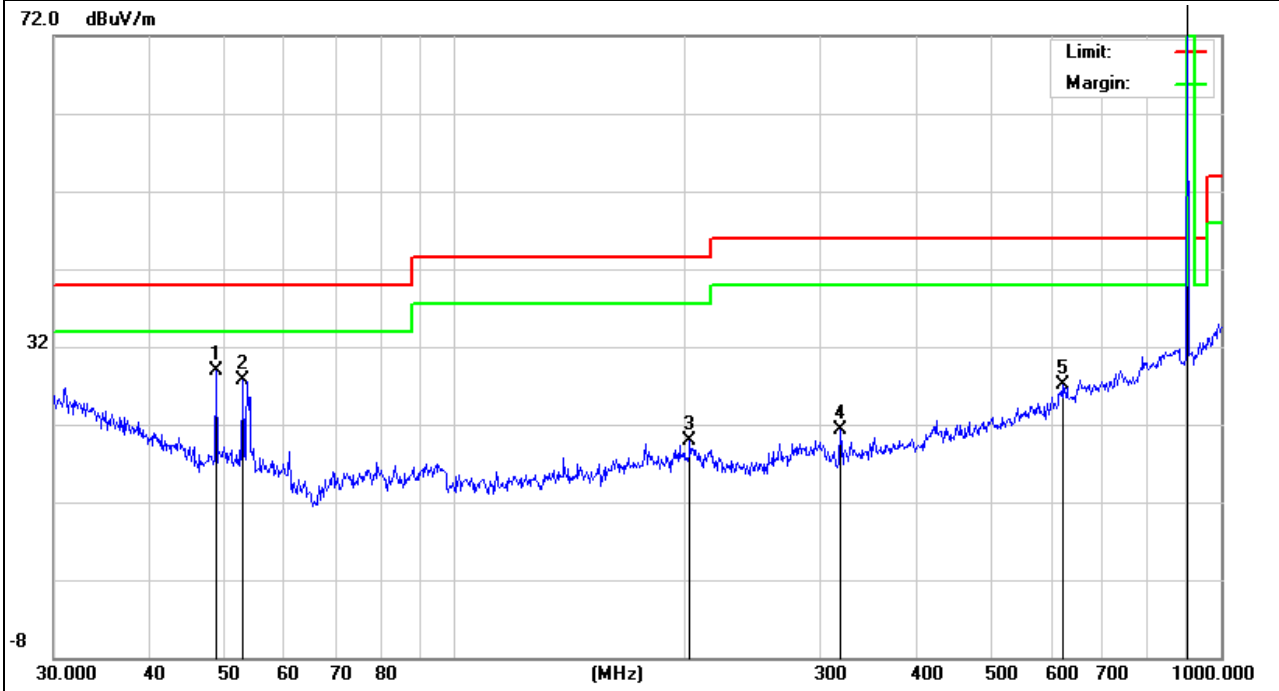

EUT :	LoRa RF Transceiver Module	Model Name :	LoRa 1276-C1-915
Temperature :	20 °C	Relative Humidity :	48%
Pressure :	1010 hPa	Test Voltage :	DC 3.3V
Test Mode :	TX-902.5MHz (ANT A)	Polarization :	Horizontal

Frequency (MHz)	Meter Reading (dBμV)	Factor (dB)	Emission Level (dBμV/m)	Limits (dBμV/m)	Margin (dB)	Detector Type
32.2925	5.55	20.2	25.75	40	-14.25	QP
105.6414	15.36	10.35	25.71	43.5	-17.79	QP
133.6188	16.35	11.36	27.71	43.5	-15.79	QP
176.8875	12.32	12.67	24.99	43.5	-18.51	QP
352.9433	15.73	14.39	30.12	46	-15.88	QP
903.3093	65.63	24.67	90.3	94	-3.7	QP

Remark:

- Factor = Antenna Factor + Cable Loss – Pre-amplifier.

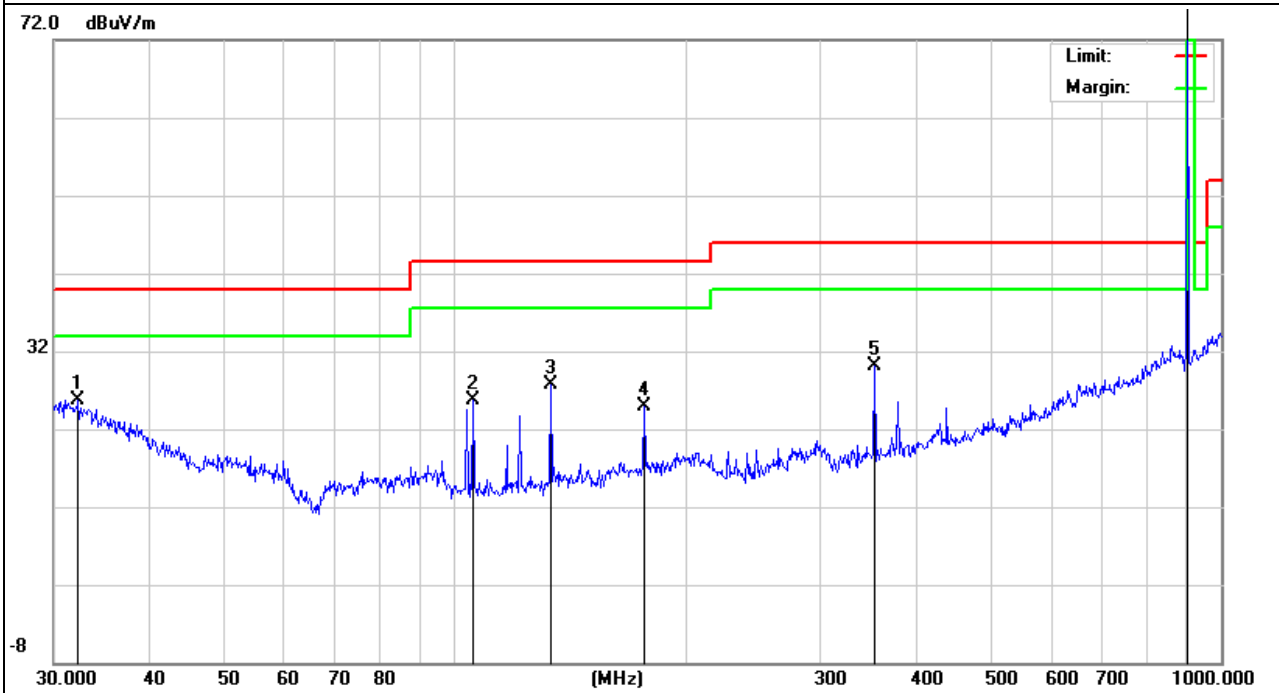

EUT :	LoRa RF Transceiver Module	Model Name :	LoRa 1276-C1-915
Temperature :	20 °C	Relative Humidity :	48%
Pressure :	1010 hPa	Test Voltage :	DC 3.3V
Test Mode :	TX-915.5MHz (ANT A)	Polarization :	Vertical

Frequency (MHz)	Meter Reading (dB $\mu$ V)	Factor (dB)	Emission Level (dB $\mu$ V/m)	Limits (dB $\mu$ V/m)	Margin (dB)	Detector Type
53.5052	21.67	12.53	34.2	40	-5.8	QP
61.1315	21.18	10.11	31.29	40	-8.71	QP
66.9668	24.13	8.61	32.74	40	-7.26	QP
204.9551	6.01	13.89	19.9	43.5	-23.6	QP
319.937	10.35	13.41	23.76	46	-22.24	QP
916.0687	62.91	25.09	88	94	-6	QP

Remark:

1. Factor = Antenna Factor + Cable Loss – Pre-amplifier.

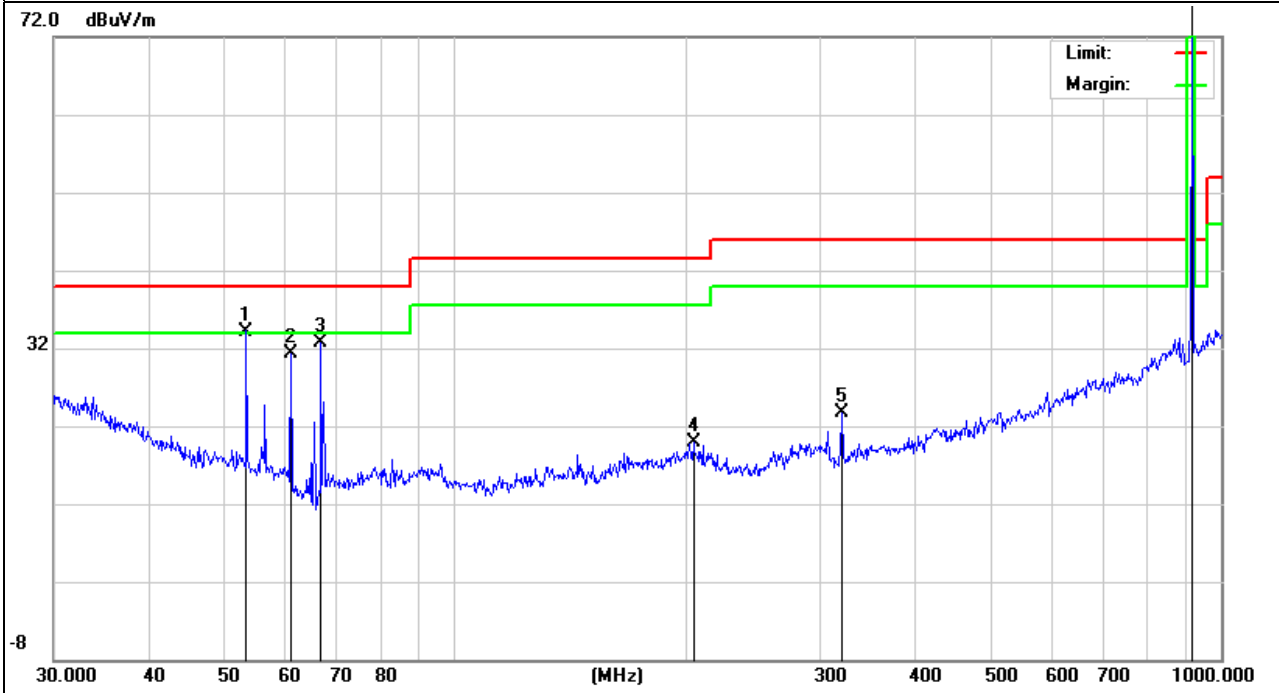

EUT :	LoRa RF Transceiver Module	Model Name :	LoRa 1276-C1-915
Temperature :	20 °C	Relative Humidity :	48%
Pressure :	1010 hPa	Test Voltage :	DC 3.3V
Test Mode :	TX-915.5MHz (ANT A)	Polarization :	Horizontal

Frequency (MHz)	Meter Reading (dBμV)	Factor (dB)	Emission Level (dBμV/m)	Limits (dBμV/m)	Margin (dB)	Detector Type
36.7661	5.77	18.09	23.86	40	-16.14	QP
53.1313	5.62	12.7	18.32	40	-21.68	QP
88.9637	5.12	11.76	16.88	43.5	-26.62	QP
133.6187	5.96	11.36	17.32	43.5	-26.18	QP
286.9823	6.31	14.06	20.37	46	-25.63	QP
916.0687	66.01	25.09	91.1	94	-2.9	QP

Remark:

1. Factor = Antenna Factor + Cable Loss – Pre-amplifier.

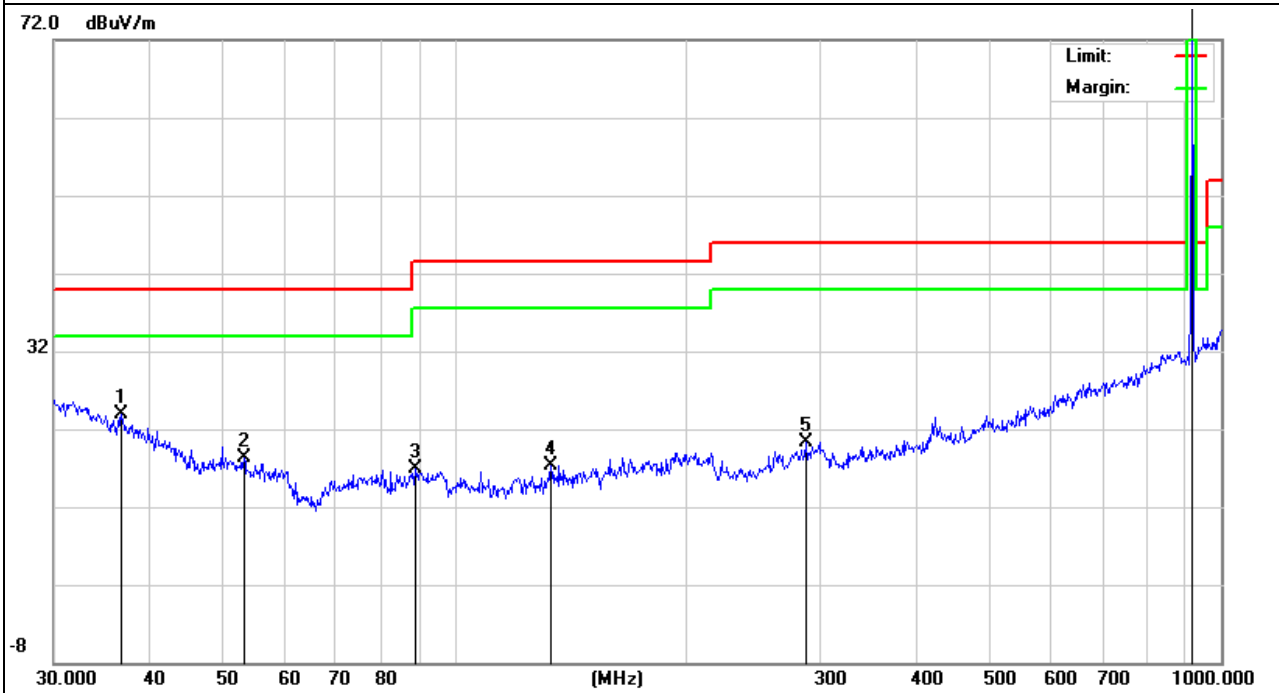

EUT :	LoRa RF Transceiver Module	Model Name :	LoRa 1276-C1-915
Temperature :	20 °C	Relative Humidity :	48%
Pressure :	1010 hPa	Test Voltage :	DC 3.3V
Test Mode :	TX-927.5MHz (ANT A)	Polarization :	Vertical

Frequency (MHz)	Meter Reading (dB $\mu$ V)	Factor (dB)	Emission Level (dB $\mu$ V/m)	Limits (dB $\mu$ V/m)	Margin (dB)	Detector Type
30.6379	4.96	20.93	25.89	40.00	-14.11	QP
68.1514	18.82	9.89	28.71	40.00	-11.29	QP
128.1130	16.60	10.52	27.12	43.50	-16.38	QP
468.8762	15.03	16.60	31.63	46.00	-14.37	QP
549.0193	10.07	18.24	28.31	46.00	-17.69	QP
925.7563	62.86	25.54	88.40	94.00	-5.60	QP

Remark:

1. Factor = Antenna Factor + Cable Loss – Pre-amplifier.

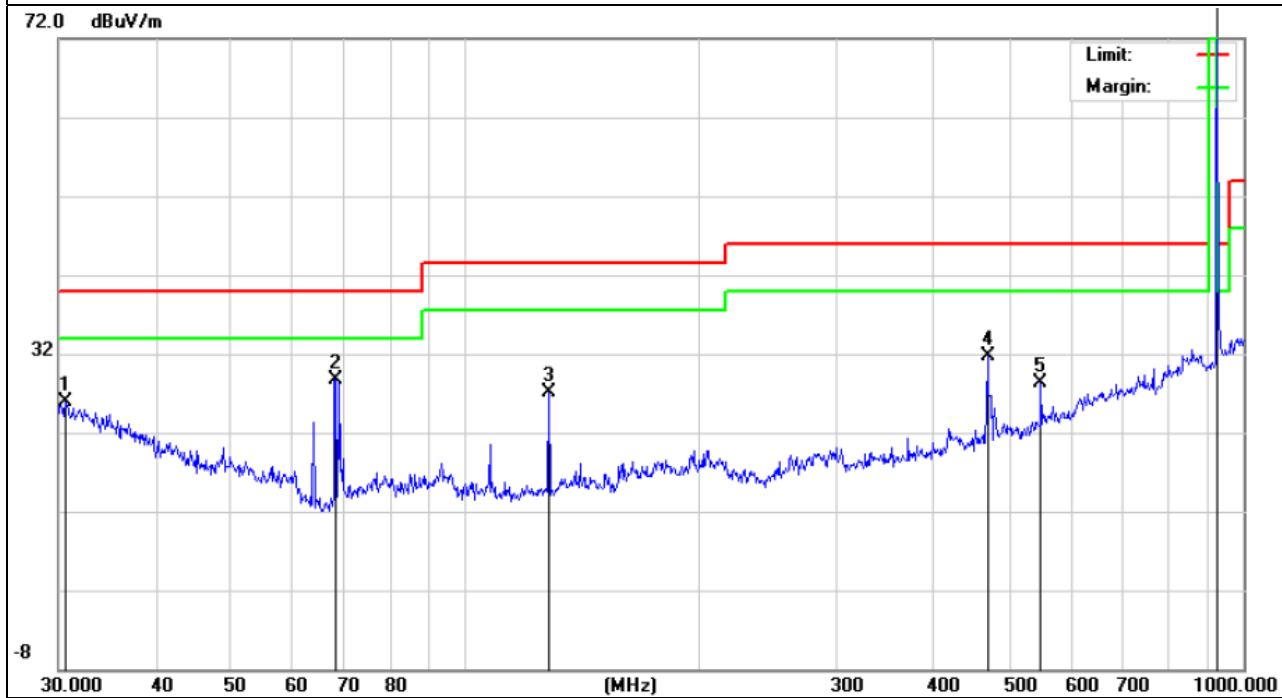



EUT :	LoRa RF Transceiver Module	Model Name :	LoRa 1276-C1-915
Temperature :	20 °C	Relative Humidity :	48%
Pressure :	1010 hPa	Test Voltage :	DC 3.3V
Test Mode :	TX-927.5MHz (ANT A)	Polarization :	Horizontal

Frequency (MHz)	Meter Reading (dBμV)	Factor (dB)	Emission Level (dBμV/m)	Limits (dBμV/m)	Margin (dB)	Detector Type
32.1794	5.44	20.26	25.70	40.00	-14.30	QP
116.9495	9.70	10.27	19.97	43.50	-23.53	QP
121.5485	13.02	10.60	23.62	43.50	-19.88	QP
169.0054	8.19	12.61	20.80	43.50	-22.70	QP
338.4001	12.42	14.18	26.60	46.00	-19.40	QP
903.3093	63.33	24.67	88.00	94.00	-6.00	QP

**Remark:**

1. Factor = Antenna Factor + Cable Loss – Pre-amplifier.

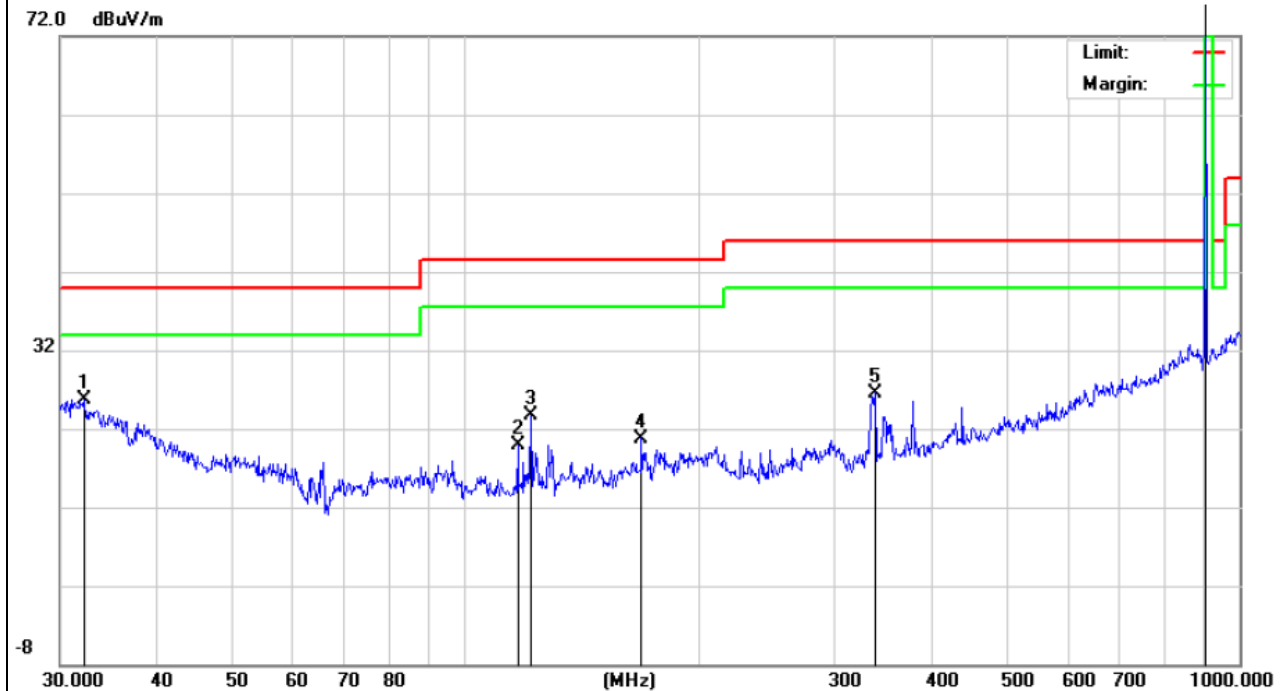

EUT :	LoRa RF Transceiver Module	Model Name :	LoRa 1276-C1-915
Temperature :	20 °C	Relative Humidity :	48%
Pressure :	1010 hPa	Test Voltage :	DC 3.3V
Test Mode :	TX-902.5MHz (ANT B)	Polarization :	Vertical

Frequency (MHz)	Meter Reading (dBμV)	Factor (dB)	Emission Level (dBμV/m)	Limits (dBμV/m)	Margin (dB)	Detector Type
31.0701	7.96	20.74	28.70	40.00	-11.30	QP
47.3253	9.74	13.26	23.00	40.00	-17.00	QP
79.2425	5.53	11.59	17.12	40.00	-22.88	QP
177.5089	6.84	12.69	19.53	43.50	-23.97	QP
321.0605	7.24	13.46	20.70	46.00	-25.30	QP
903.3093	62.13	24.67	86.80	94.00	-7.20	QP

Remark:

1. Factor = Antenna Factor + Cable Loss – Pre-amplifier.

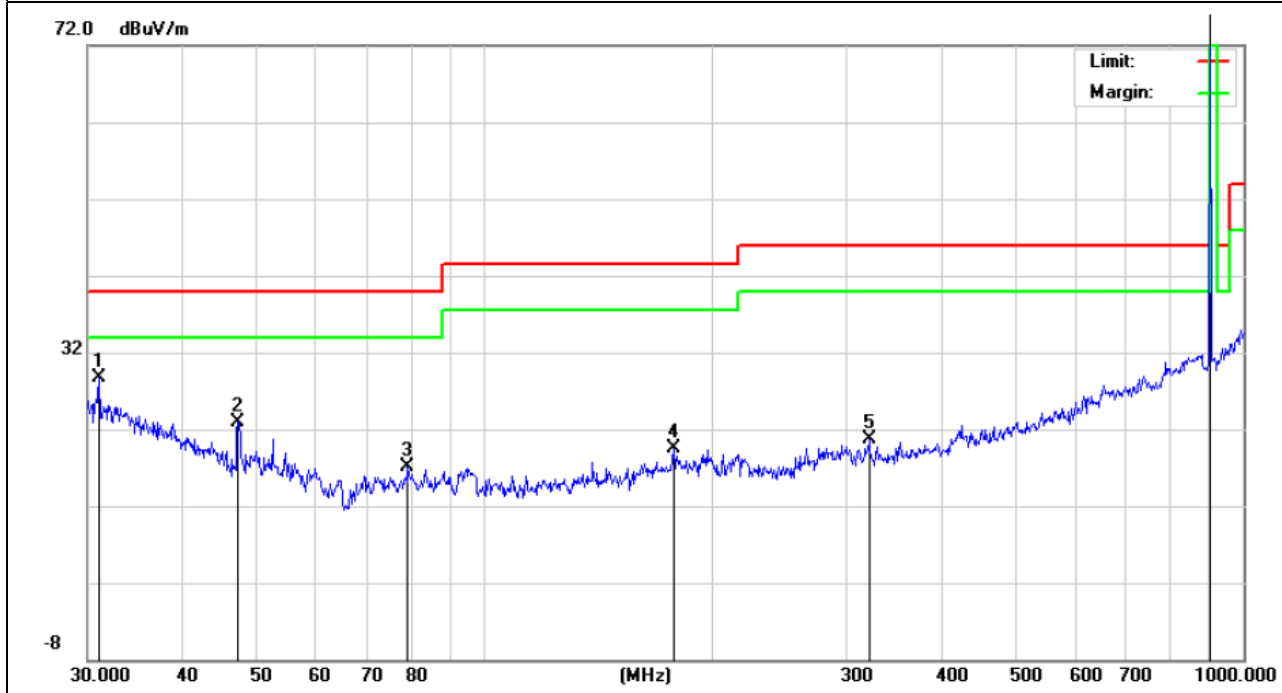

EUT :	LoRa RF Transceiver Module	Model Name :	LoRa 1276-C1-915
Temperature :	20 °C	Relative Humidity :	48%
Pressure :	1010 hPa	Test Voltage :	DC 3.3V
Test Mode :	TX-902.5MHz (ANTB)	Polarization :	Horizontal

Frequency (MHz)	Meter Reading (dBμV)	Factor (dB)	Emission Level (dBμV/m)	Limits (dBμV/m)	Margin (dB)	Detector Type
32.1794	5.44	20.26	25.70	40.00	-14.30	QP
116.9495	9.70	10.27	19.97	43.50	-23.53	QP
121.5485	13.02	10.60	23.62	43.50	-19.88	QP
169.0054	8.19	12.61	20.80	43.50	-22.70	QP
338.4001	12.42	14.18	26.60	46.00	-19.40	QP
903.3093	63.33	24.67	88.00	94.00	-6.00	QP

Remark:

- Factor = Antenna Factor + Cable Loss – Pre-amplifier.

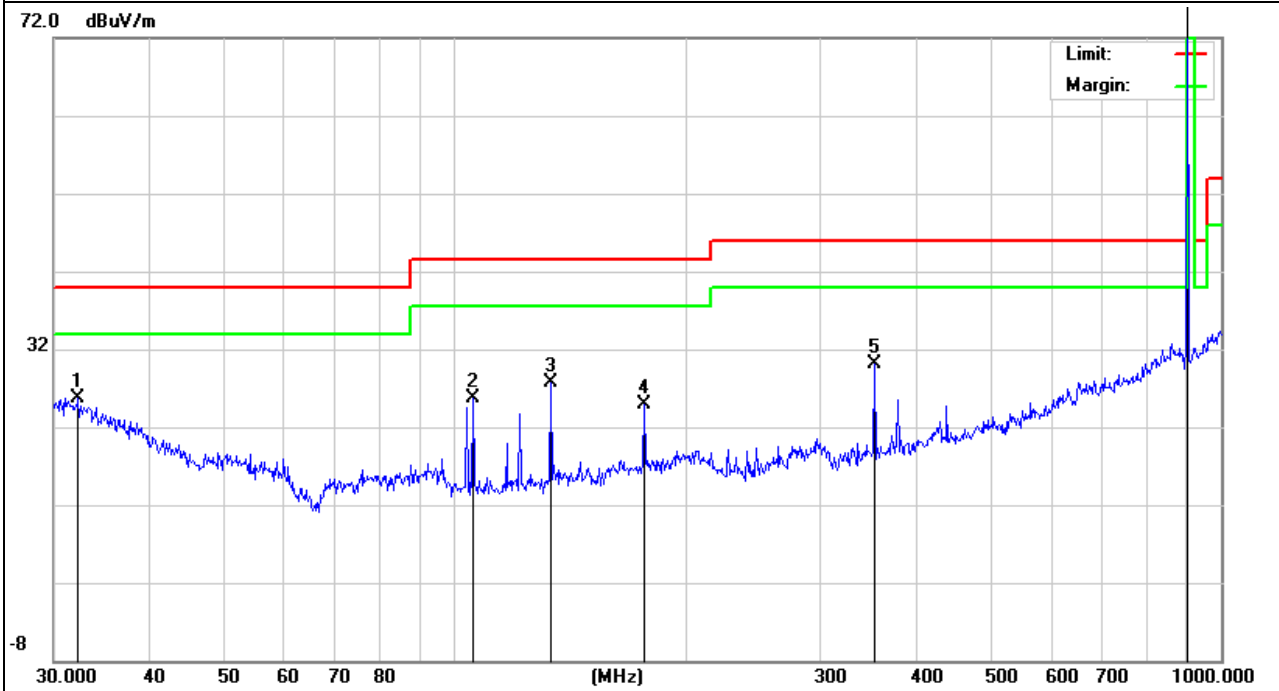

EUT :	LoRa RF Transceiver Module	Model Name :	LoRa 1276-C1-915
Temperature :	20 °C	Relative Humidity :	48%
Pressure :	1010 hPa	Test Voltage :	DC 3.3V
Test Mode :	TX-915.5MHz (ANT B)	Polarization :	Vertical

Frequency (MHz)	Meter Reading (dBμV)	Factor (dB)	Emission Level (dBμV/m)	Limits (dBμV/m)	Margin (dB)	Detector Type
33.7986	6.20	19.47	25.67	40.00	-14.33	QP
53.3179	18.38	12.62	31.00	40.00	-9.00	QP
56.5929	12.62	12.05	24.67	40.00	-15.33	QP
65.5725	14.71	7.76	22.47	40.00	-17.53	QP
313.2760	8.79	13.31	22.10	46.00	-23.90	QP
916.0687	61.71	25.09	86.80	94.00	-7.20	QP

Remark:

1. Factor = Antenna Factor + Cable Loss – Pre-amplifier.

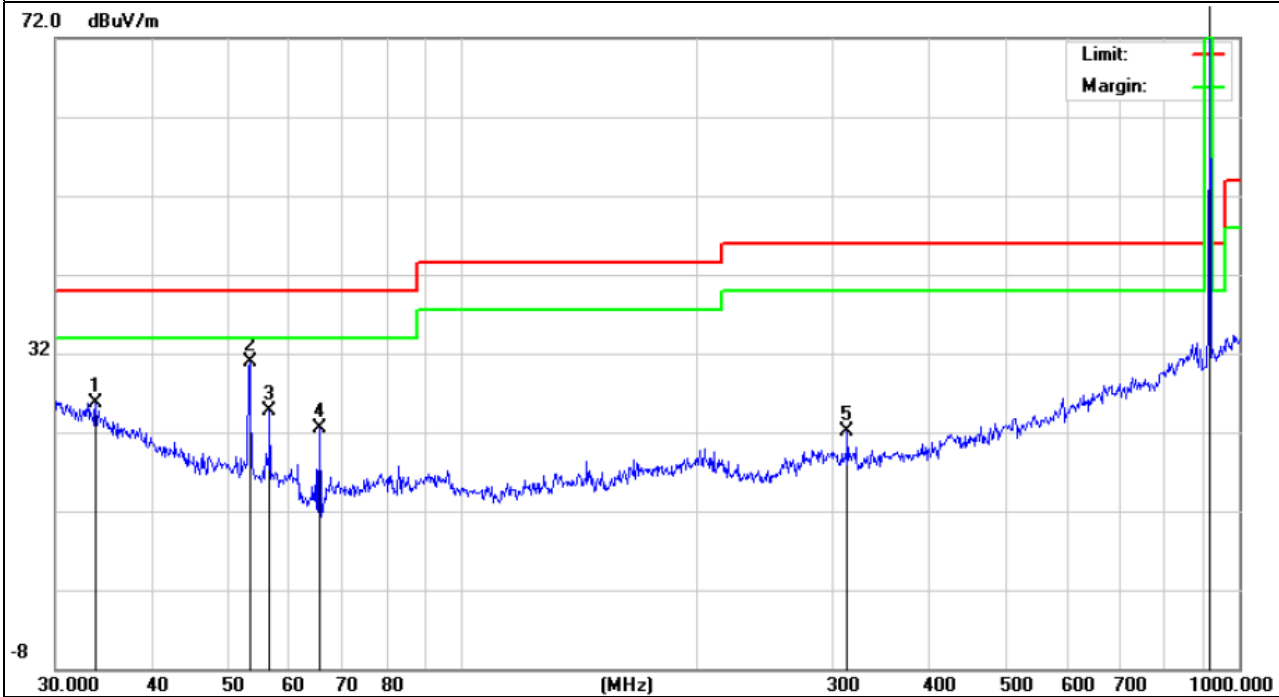

EUT :	LoRa RF Transceiver Module	Model Name :	LoRa 1276-C1-915
Temperature :	20 °C	Relative Humidity :	48%
Pressure :	1010 hPa	Test Voltage :	DC 3.3V
Test Mode :	TX-915.5MHz (ANTB)	Polarization :	Horizontal

Frequency (MHz)	Meter Reading (dBμV)	Factor (dB)	Emission Level (dBμV/m)	Limits (dBμV/m)	Margin (dB)	Detector Type
31.8427	5.19	20.41	25.60	40.00	-14.40	QP
45.8551	8.96	13.14	22.10	40.00	-17.90	QP
125.8863	9.64	10.56	20.20	43.50	-23.30	QP
286.9823	6.31	14.06	20.37	46.00	-25.63	QP
539.4773	7.13	18.17	25.30	46.00	-20.70	QP
916.0687	65.41	25.09	90.50	94.00	-3.50	QP

Remark:

1. Factor = Antenna Factor + Cable Loss – Pre-amplifier.

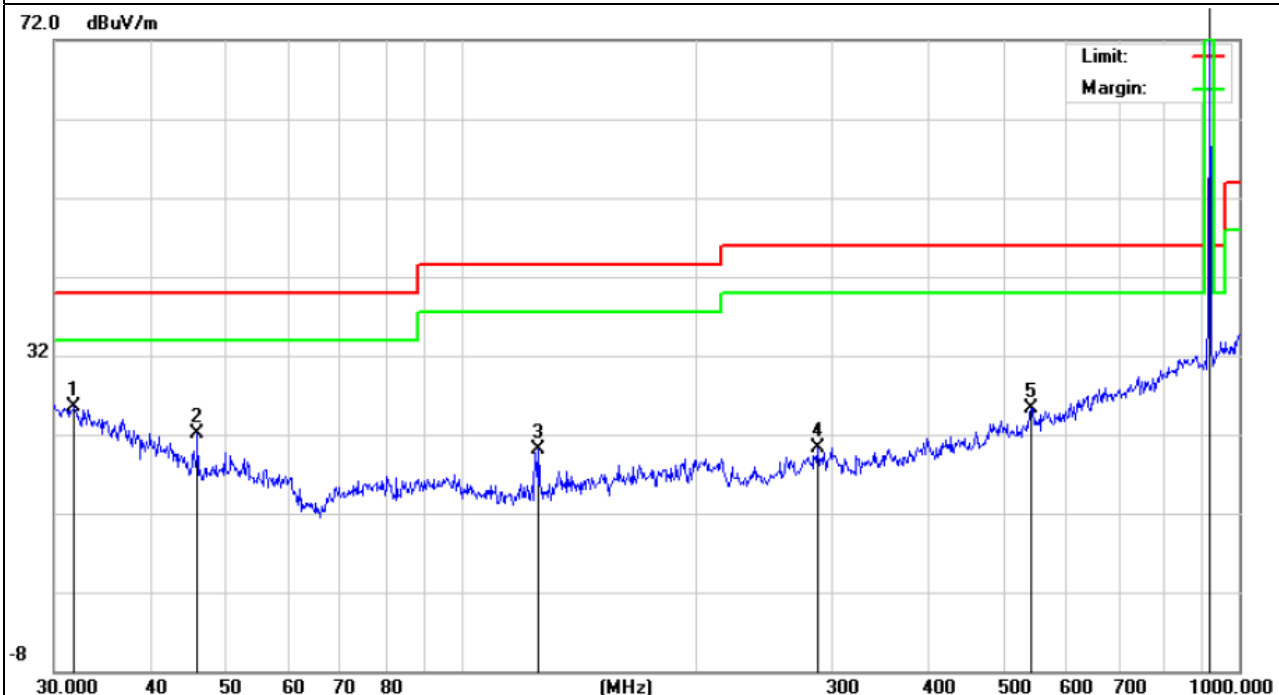

EUT :	LoRa RF Transceiver Module	Model Name :	LoRa 1276-C1-915
Temperature :	20 °C	Relative Humidity :	48%
Pressure :	1010 hPa	Test Voltage :	DC 3.3V
Test Mode :	TX-927.5MHz (ANT B)	Polarization :	Vertical

Frequency (MHz)	Meter Reading (dBμV)	Factor (dB)	Emission Level (dBμV/m)	Limits (dBμV/m)	Margin (dB)	Detector Type
36.8952	5.03	18.02	23.05	40.00	-16.95	QP
48.8429	6.44	13.36	19.80	40.00	-20.20	QP
93.1132	6.22	11.98	18.20	43.50	-25.30	QP
156.4576	12.64	11.46	24.10	43.50	-19.40	QP
411.8240	11.65	15.35	27.00	46.00	-19.00	QP
925.7563	61.06	25.54	86.60	94.00	-7.40	QP

**Remark:**

1. Factor = Antenna Factor + Cable Loss – Pre-amplifier.

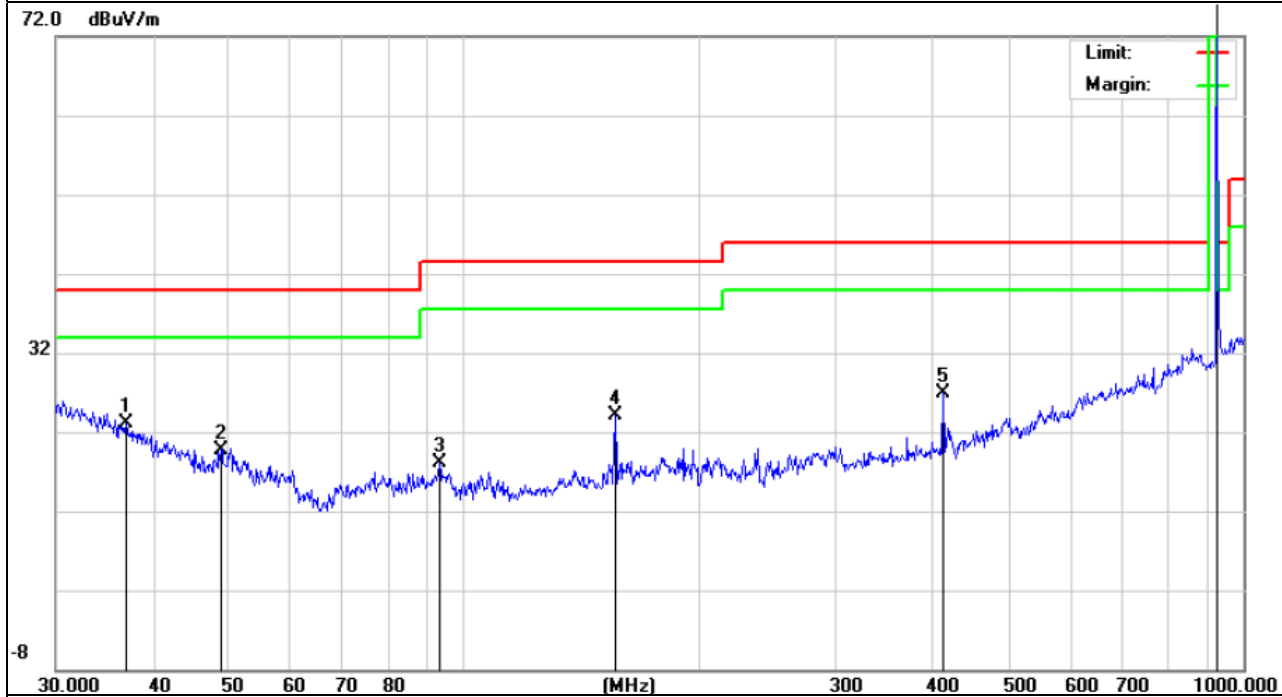

EUT :	LoRa RF Transceiver Module	Model Name :	LoRa 1276-C1-915
Temperature :	20 °C	Relative Humidity :	48%
Pressure :	1010 hPa	Test Voltage :	DC 3.3V
Test Mode :	TX-927.5MHz (ANT B)	Polarization :	Horizontal

Frequency (MHz)	Meter Reading (dBμV)	Factor (dB)	Emission Level (dBμV/m)	Limits (dBμV/m)	Margin (dB)	Detector Type
32.6340	5.36	20.04	25.40	40.00	-14.60	QP
57.1914	8.52	11.88	20.40	40.00	-19.60	QP
91.8161	5.81	11.89	17.70	43.50	-25.80	QP
193.0945	6.48	13.36	19.84	43.50	-23.66	QP
510.0436	7.09	17.43	24.52	46.00	-21.48	QP
925.7563	65.76	25.54	91.30	94.00	-2.70	QP

Remark:

1. Factor = Antenna Factor + Cable Loss – Pre-amplifier.

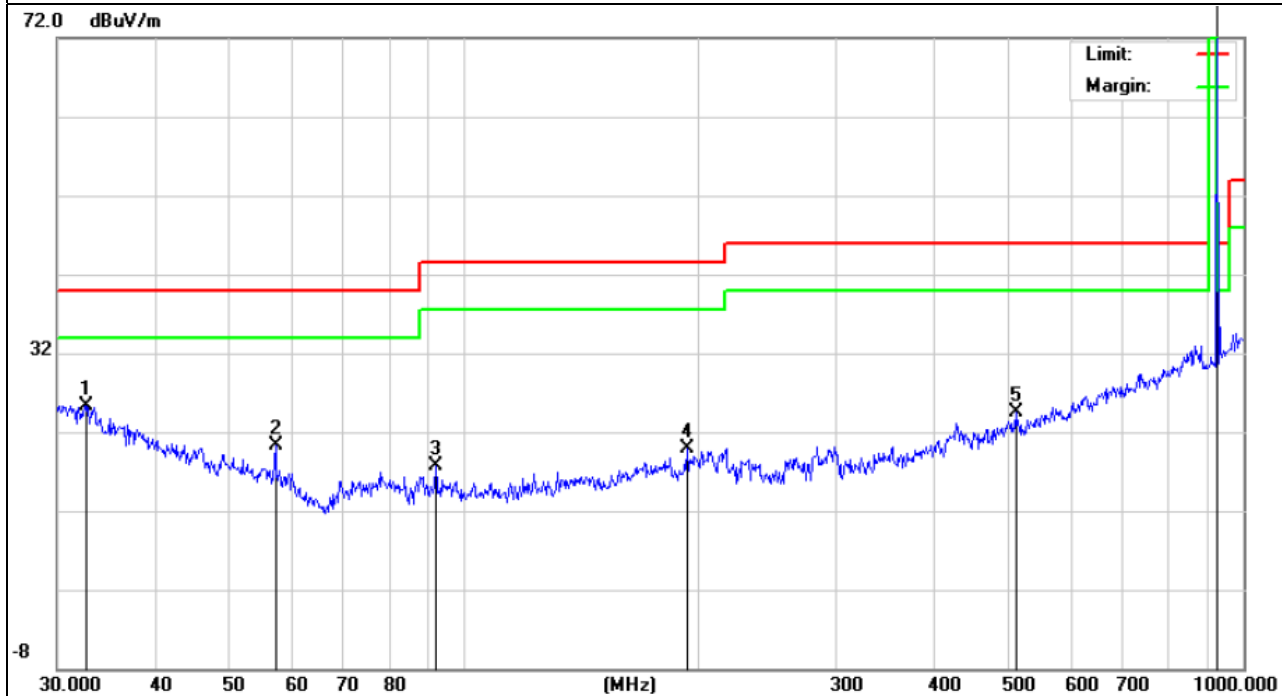

### 3.4.7 TEST RESULTS (ABOVE 1000 MHZ)

EUT :	LoRa RF Transceiver Module	Model Name :	LoRa 1276-C1-915
Temperature :	20 °C	Relative Humidity :	48%
Pressure :	1010 hPa	Test Voltage :	DC 3.3V
Test Mode :	TX-902.5MHz (ANT A)	Polarization :	Horizontal

Frequency (MHz)	Meter Reading (dBμV)	Factor (dB)	Emission Level (dBμV/m)	Limits (dBμV/m)	Margin (dB)	Detector Type
1807.5	61.41	-11.96	49.45	74	-24.55	peak
1807.5	32.17	-11.96	20.21	54	-33.79	AVG
2742.5	53.2	-9.84	43.36	74	-30.64	peak
2742.5	32.06	-9.84	22.22	54	-31.78	AVG
4527.5	42.42	-3.66	38.76	74	-35.24	peak
4527.5	27.14	-3.66	23.48	54	-30.52	AVG

Remark:  
 Factor = Antenna Factor + Cable Loss – Pre-amplifier.  
 No emission above 18GHz.

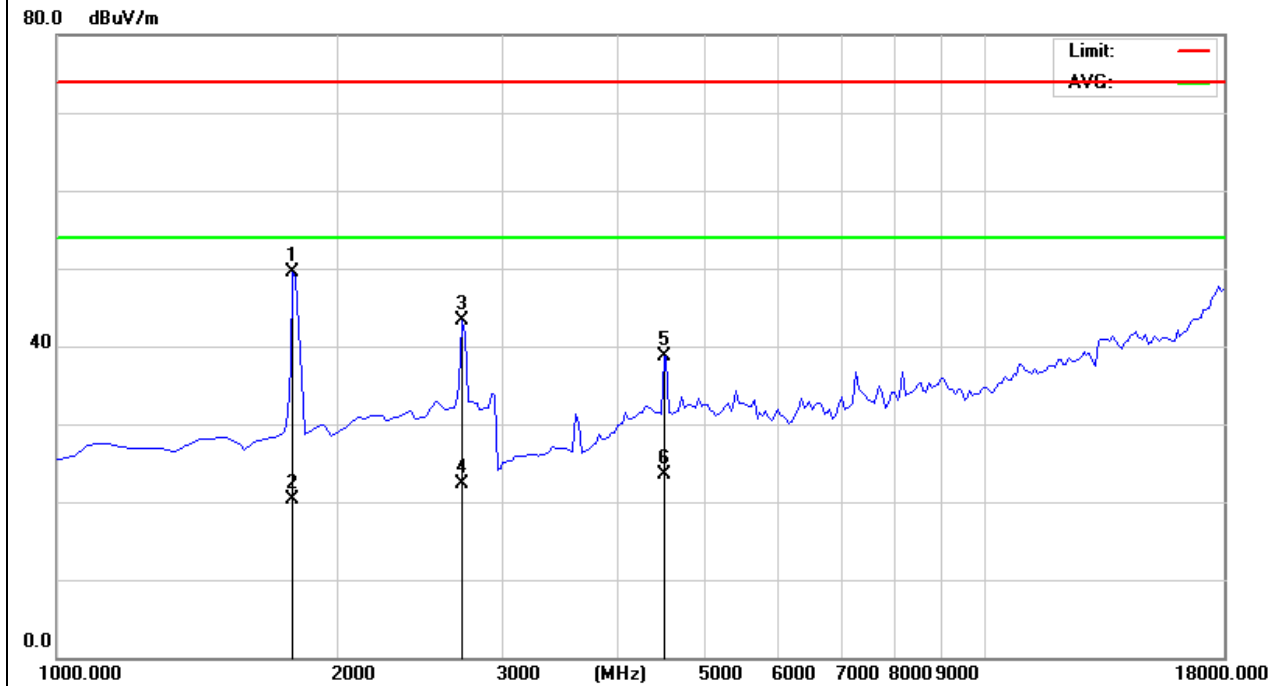



EUT :	LoRa RF Transceiver Module	Model Name :	LoRa 1276-C1-915
Temperature :	20 °C	Relative Humidity :	48%
Pressure :	1010 hPa	Test Voltage :	DC 3.3V
Test Mode :	TX-902.5MHz (ANT A)	Polarization :	Vertical

Frequency (MHz)	Meter Reading (dBμV)	Factor (dB)	Emission Level (dBμV/m)	Limits (dBμV/m)	Margin (dB)	Detector Type
1807.5	64.23	-11.96	52.27	74	-21.73	peak
1807.5	32.15	-11.96	20.19	54	-33.81	AVG
2742.5	58.93	-9.84	49.09	74	-24.91	peak
2742.5	31.24	-9.84	21.4	54	-32.6	AVG
5420	42.28	-1.97	40.31	74	-33.69	peak
5420	26.89	-1.97	24.92	54	-29.08	AVG

Remark:  
 Factor = Antenna Factor + Cable Loss – Pre-amplifier.  
 No emission above 18GHz.

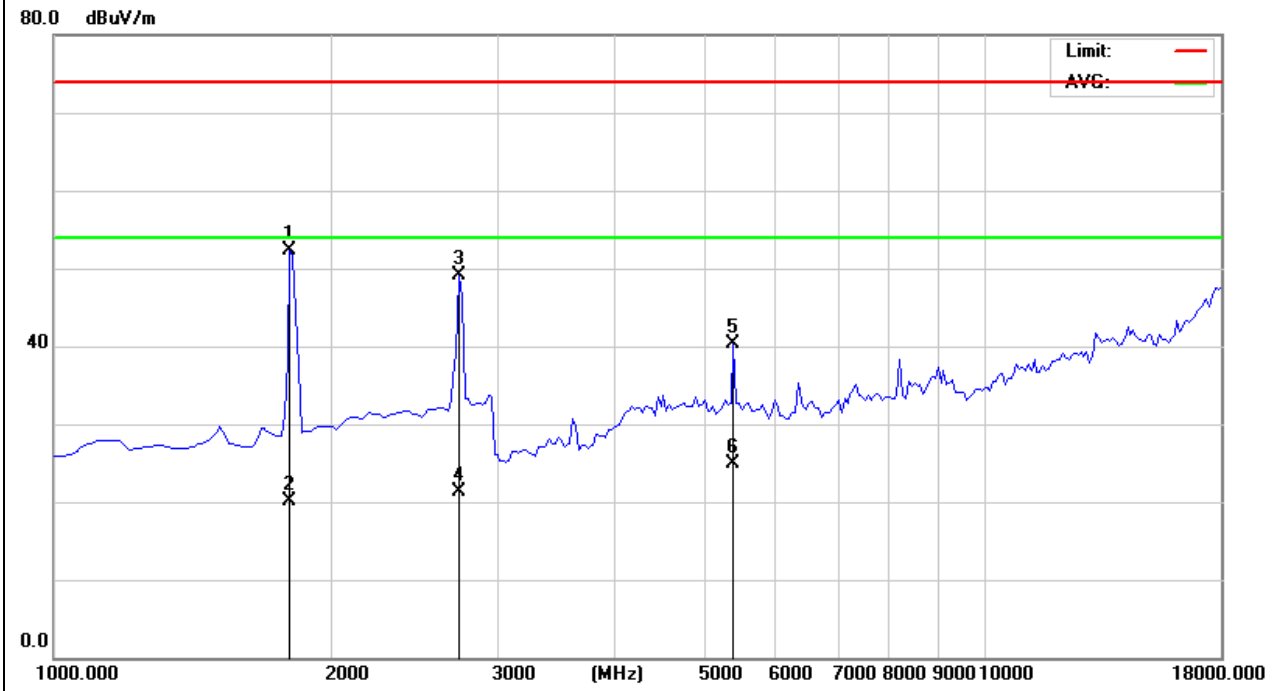

Note: EUT Pre-scan X/Y/Z orientation, only worst case is presented in the report(X orientation).

EUT :	LoRa RF Transceiver Module	Model Name :	LoRa 1276-C1-915
Temperature :	20 °C	Relative Humidity :	48%
Pressure :	1010 hPa	Test Voltage :	DC 3.3V
Test Mode :	TX-915.5MHz (ANT A)	Polarization :	Horizontal

Frequency (MHz)	Meter Reading (dBμV)	Factor (dB)	Emission Level (dBμV/m)	Limits (dBμV/m)	Margin (dB)	Detector Type
1850	60.25	-11.92	48.33	74	-25.67	peak
1850	30.52	-11.92	18.6	54	-35.4	AVG
4570	44.91	-3.41	41.5	74	-32.5	peak
4570	27.26	-3.41	23.85	54	-30.15	AVG

Remark:  
 Factor = Antenna Factor + Cable Loss – Pre-amplifier.  
 No emission above 18GHz.

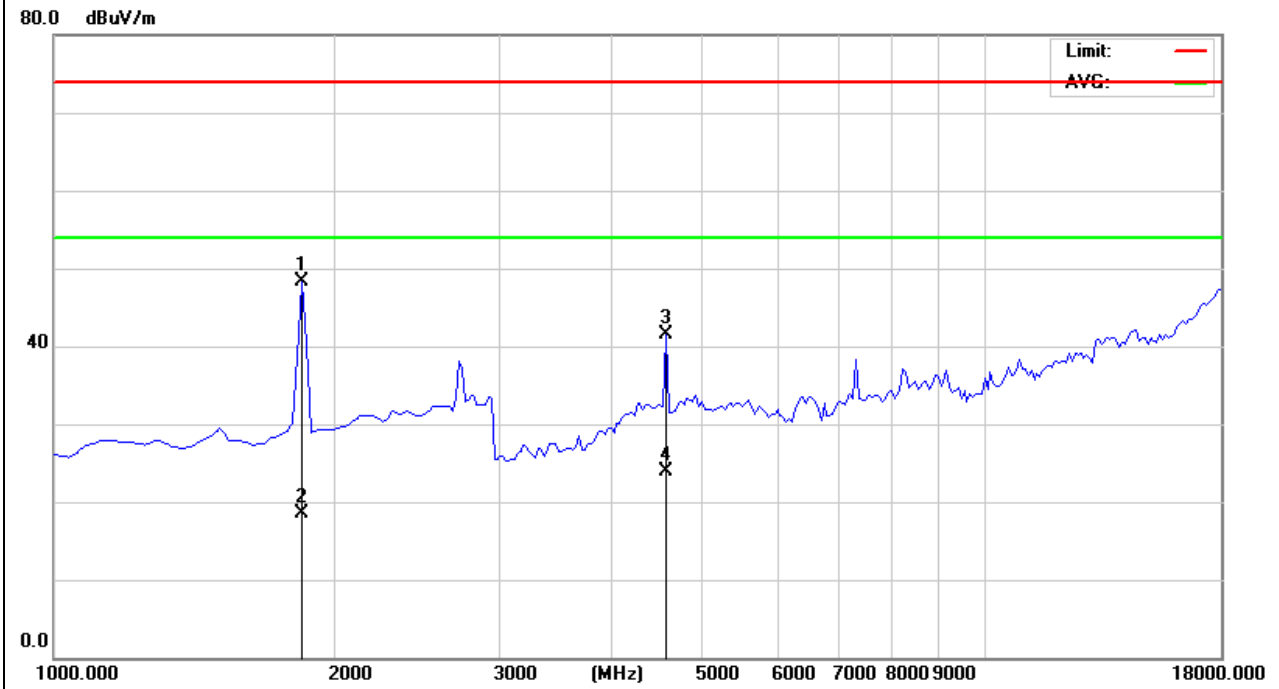

EUT :	LoRa RF Transceiver Module	Model Name :	LoRa 1276-C1-915
Temperature :	20 °C	Relative Humidity :	48%
Pressure :	1010 hPa	Test Voltage :	DC 3.3V
Test Mode :	TX-915.5MHz (ANT A)	Polarization :	Vertical

Frequency (MHz)	Meter Reading (dBμV)	Factor (dB)	Emission Level (dBμV/m)	Limits (dBμV/m)	Margin (dB)	Detector Type
1850	68.03	-11.92	56.11	74	-17.89	peak
1850	33.48	-11.92	21.56	54	-32.44	AVG
2742.5	57.69	-9.84	47.85	74	-26.15	peak
2742.5	31.24	-9.84	21.4	54	-32.6	AVG

Remark:  
 Factor = Antenna Factor + Cable Loss – Pre-amplifier.  
 No emission above 18GHz.

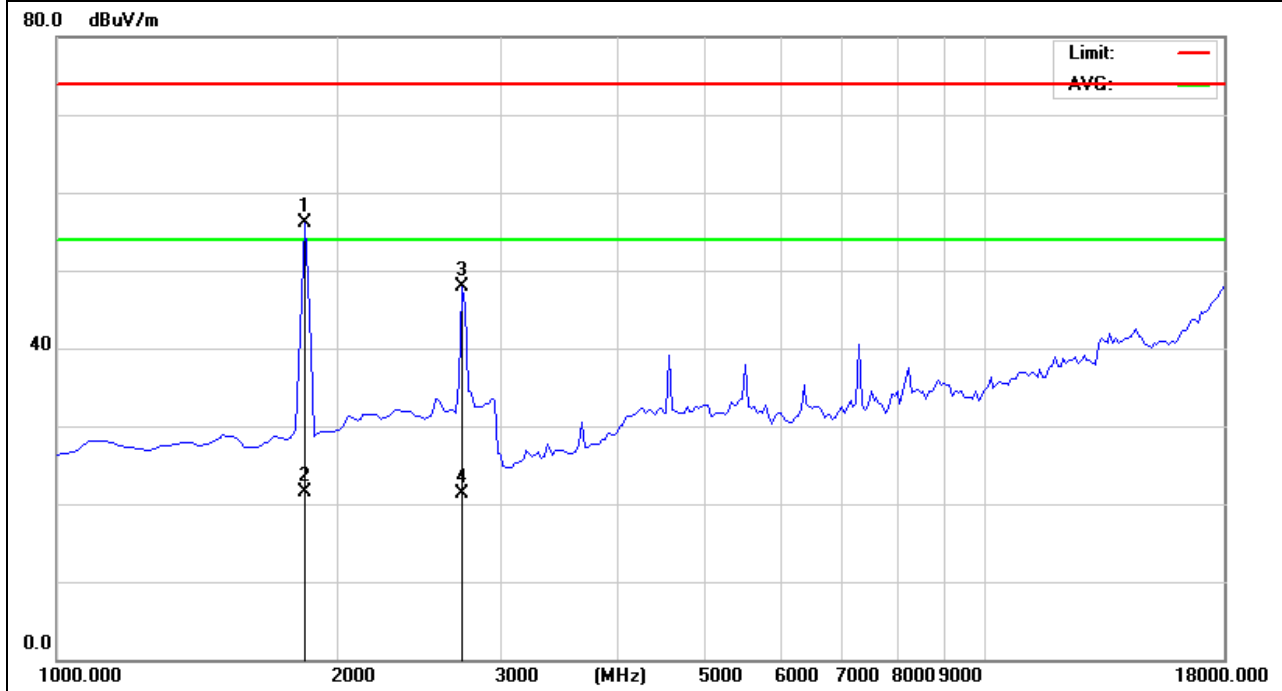

Note: EUT Pre-scan X/Y/Z orientation, only worst case is presented in the report(X orientation).

EUT :	LoRa RF Transceiver Module	Model Name :	LoRa 1276-C1-915
Temperature :	20 °C	Relative Humidity :	48%
Pressure :	1010 hPa	Test Voltage :	DC 3.3V
Test Mode :	TX-927.5MHz (ANT A)	Polarization :	Horizontal

Frequency (MHz)	Meter Reading (dBμV)	Factor (dB)	Emission Level (dBμV/m)	Limits (dBμV/m)	Margin (dB)	Detector Type
1850	63.56	-11.92	51.64	74	-22.36	peak
1850	32.18	-11.92	20.26	74	-53.74	AVG
2785	49.47	-9.8	39.67	74	-34.33	peak
2785	32.04	-9.8	22.24	54	-31.76	AVG
4655	43.91	-3.03	40.88	74	-33.12	peak
4655	27.46	-3.03	24.43	54	-29.57	AVG

Remark:  
 Factor = Antenna Factor + Cable Loss – Pre-amplifier.  
 No emission above 18GHz.

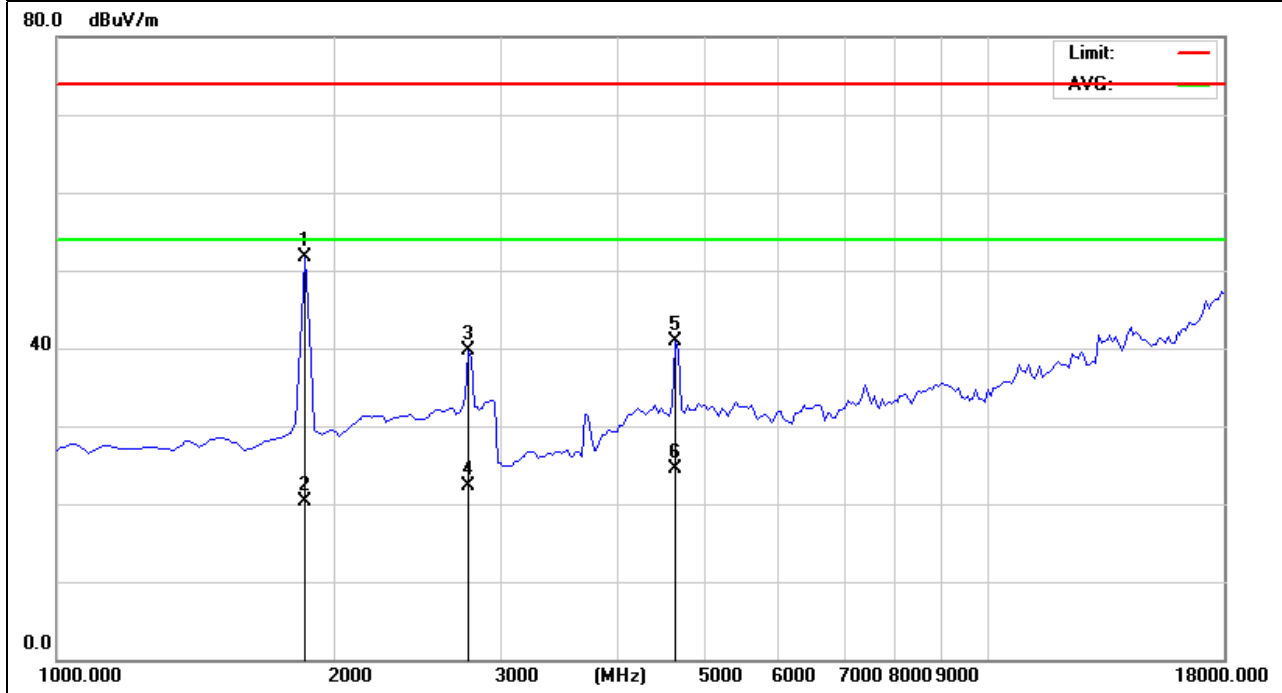

EUT :	LoRa RF Transceiver Module	Model Name :	LoRa 1276-C1-915
Temperature :	20 °C	Relative Humidity :	48%
Pressure :	1010 hPa	Test Voltage :	DC 3.3V
Test Mode :	TX-927.5MHz (ANT A)	Polarization :	Vertical

Frequency (MHz)	Meter Reading (dBμV)	Factor (dB)	Emission Level (dBμV/m)	Limits (dBμV/m)	Margin (dB)	Detector Type
1850	69.32	-11.92	57.4	74	-16.6	peak
1850	32.6	-11.92	20.68	54	-33.32	AVG
2785	56.04	-9.8	46.24	74	-27.76	peak
2785	31.54	-9.8	21.74	54	-32.26	AVG
4655	48.09	-3.03	45.06	74	-28.94	peak
4655	27.35	-3.03	24.32	54	-29.68	AVG

Remark:

Factor = Antenna Factor + Cable Loss – Pre-amplifier.

No emission above 18GHz.

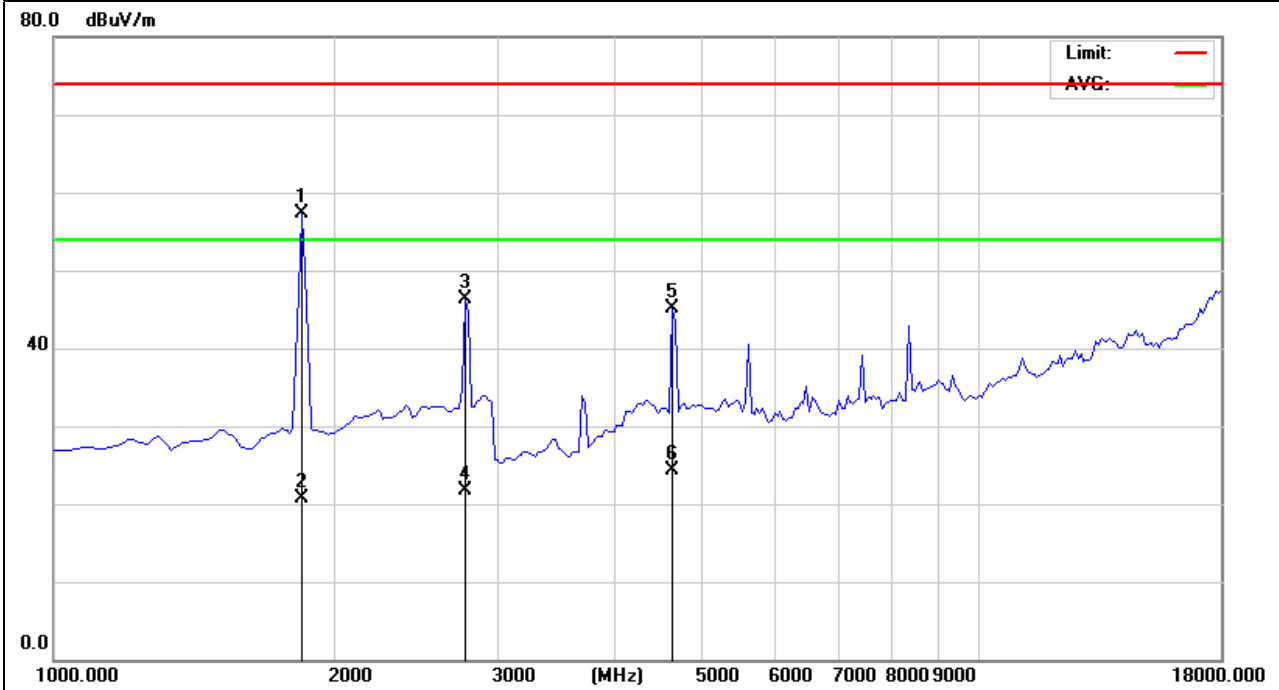

Note: 1:EUT Pre-scan X/Y/Z orientation, only worst case is presented in the report(X orientation).

EUT :	LoRa RF Transceiver Module	Model Name :	LoRa 1276-C1-915
Temperature :	20 °C	Relative Humidity :	48%
Pressure :	1010 hPa	Test Voltage :	DC 3.3V
Test Mode :	TX-902.5MHz (ANT B)	Polarization :	Horizontal

Frequency (MHz)	Meter Reading (dBμV)	Factor (dB)	Emission Level (dBμV/m)	Limits (dBμV/m)	Margin (dB)	Detector Type
1807.5	56.16	-11.96	44.20	74.00	-29.80	peak
1807.5	30.51	-11.96	18.55	54.00	-35.45	AVG
2742.5	49.14	-9.84	39.30	74.00	-34.70	peak
2742.5	31.26	-9.84	21.42	54.00	-32.58	AVG
4527.5	42.42	-3.66	38.76	74.00	-35.24	peak
4527.5	28.63	-3.66	24.97	54.00	-29.03	AVG

Remark:

Factor = Antenna Factor + Cable Loss – Pre-amplifier.

No emission above 18GHz.

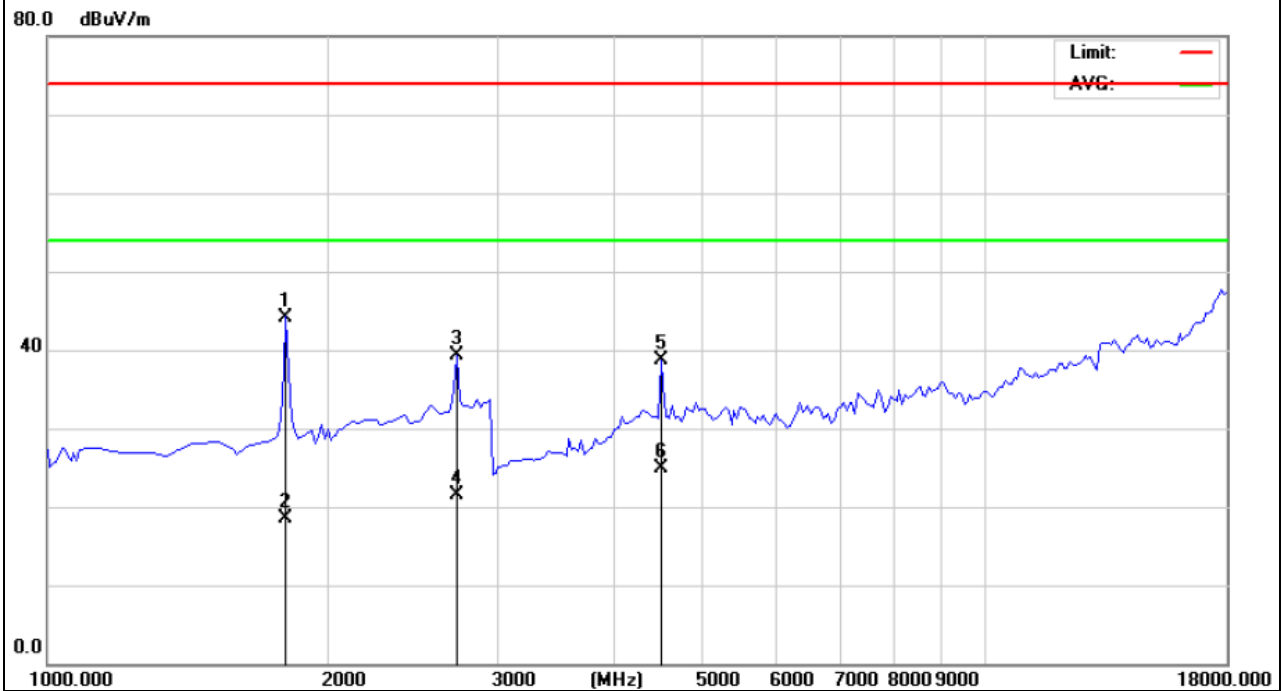

EUT :	LoRa RF Transceiver Module	Model Name :	LoRa 1276-C1-915
Temperature :	20 °C	Relative Humidity :	48%
Pressure :	1010 hPa	Test Voltage :	DC 3.3V
Test Mode :	TX-902.5MHz (ANT B)	Polarization :	Vertical

Frequency (MHz)	Meter Reading (dBμV)	Factor (dB)	Emission Level (dBμV/m)	Limits (dBμV/m)	Margin (dB)	Detector Type
1808.551	57.06	-11.96	45.10	74.00	-28.90	peak
1808.551	31.15	-11.96	19.19	54.00	-34.81	AVG
2742.5	52.94	-9.84	43.10	74.00	-30.90	peak
2742.5	31.18	-9.84	21.34	54.00	-32.66	AVG
5420	39.37	-1.97	37.40	74.00	-36.60	peak
5420	28.03	-1.97	26.06	54.00	-27.94	AVG

Remark:

Factor = Antenna Factor + Cable Loss – Pre-amplifier.

No emission above 18GHz.

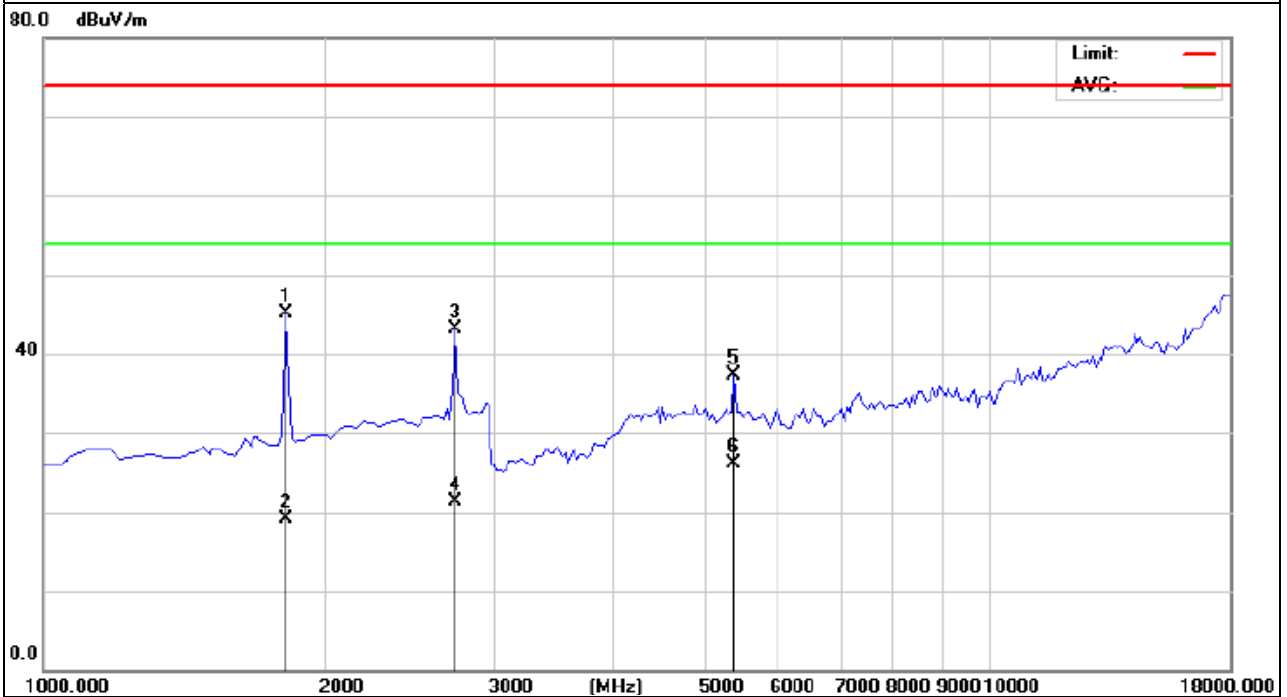

Note: EUT Pre-scan X/Y/Z orientation, only worst case is presented in the report(X orientation).

EUT :	LoRa RF Transceiver Module	Model Name :	LoRa 1276-C1-915
Temperature :	20 °C	Relative Humidity :	48%
Pressure :	1010 hPa	Test Voltage :	DC 3.3V
Test Mode :	TX-915.5MHz (ANT B)	Polarization :	Horizontal

Frequency (MHz)	Meter Reading (dB $\mu$ V)	Factor (dB)	Emission Level (dB $\mu$ V/m)	Limits (dB $\mu$ V/m)	Margin (dB)	Detector Type
1850	56.22	-11.92	44.30	74.00	-29.70	peak
1850	31.24	-11.92	19.32	54.00	-34.68	AVG
4570	41.31	-3.41	37.90	74.00	-36.10	peak
4570	28.46	-3.41	25.05	54.00	-28.95	AVG

Remark:  
 Factor = Antenna Factor + Cable Loss – Pre-amplifier.  
 No emission above 18GHz.

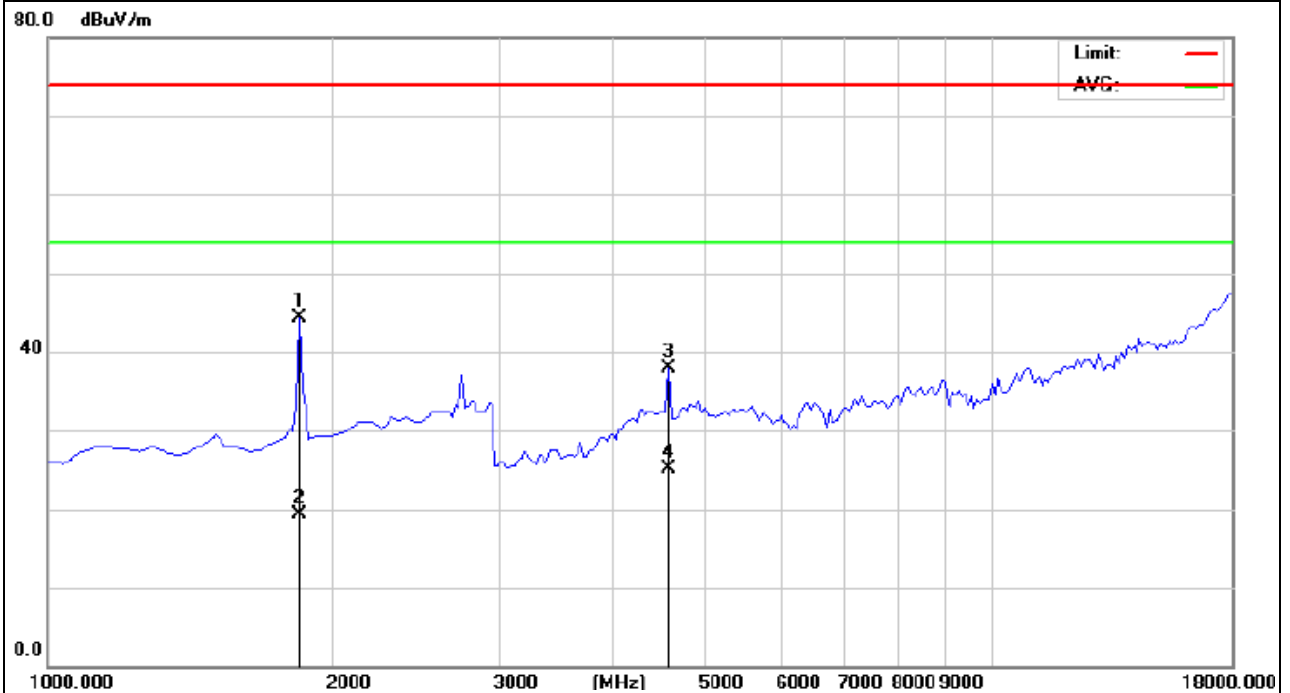



EUT :	LoRa RF Transceiver Module	Model Name :	LoRa 1276-C1-915
Temperature :	20 °C	Relative Humidity :	48%
Pressure :	1010 hPa	Test Voltage :	DC 3.3V
Test Mode :	TX-915.5MHz (ANT B)	Polarization :	Vertical

Frequency (MHz)	Meter Reading (dBμV)	Factor (dB)	Emission Level (dBμV/m)	Limits (dBμV/m)	Margin (dB)	Detector Type
1850	58.62	-11.92	46.70	74.00	-27.30	peak
1850	30.57	-11.92	18.65	54.00	-35.35	AVG
2742.5	51.94	-9.84	42.10	74.00	-31.90	peak
2742.5	32.66	-9.84	22.82	54.00	-31.18	AVG

Remark:  
 Factor = Antenna Factor + Cable Loss – Pre-amplifier.  
 No emission above 18GHz.

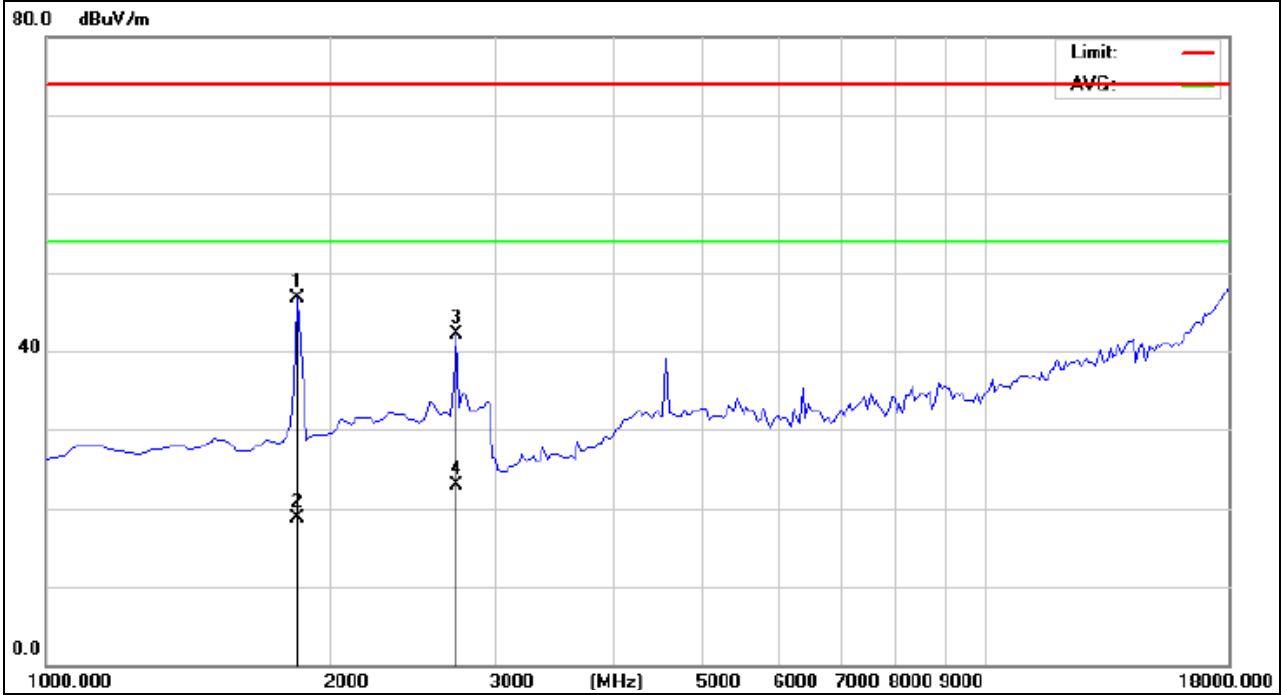

Note: EUT Pre-scan X/Y/Z orientation, only worst case is presented in the report(X orientation).

EUT :	LoRa RF Transceiver Module	Model Name :	LoRa 1276-C1-915
Temperature :	20 °C	Relative Humidity :	48%
Pressure :	1010 hPa	Test Voltage :	DC 3.3V
Test Mode :	TX-927.5MHz (ANT B)	Polarization :	Horizontal

Frequency (MHz)	Meter Reading (dBμV)	Factor (dB)	Emission Level (dBμV/m)	Limits (dBμV/m)	Margin (dB)	Detector Type
1850	60.52	-11.92	48.60	74.00	-25.40	peak
1850	31.47	-11.92	19.55	54.00	-34.45	AVG
2790.113	48.62	-9.80	38.82	74.00	-35.18	peak
2790.113	32.68	-9.80	22.88	54.00	-31.12	AVG
4660.501	42.75	-3.01	39.74	74.00	-34.26	peak
4660.501	28.62	-3.01	25.61	54.00	-28.39	AVG

Remark:

Factor = Antenna Factor + Cable Loss – Pre-amplifier.

No emission above 18GHz.

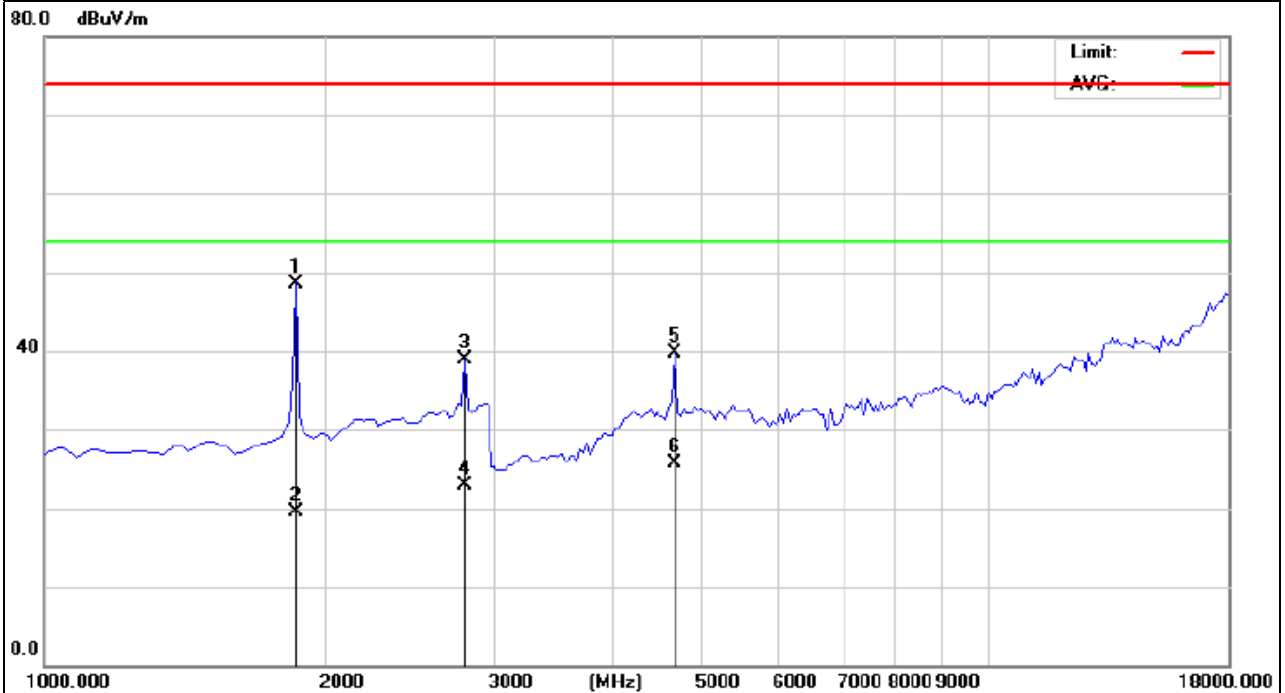

EUT :	LoRa RF Transceiver Module	Model Name :	LoRa 1276-C1-915
Temperature :	20 °C	Relative Humidity :	48%
Pressure :	1010 hPa	Test Voltage :	DC 3.3V
Test Mode :	TX-927.5MHz (ANT B)	Polarization :	Vertical

Frequency (MHz)	Meter Reading (dBμV)	Factor (dB)	Emission Level (dBμV/m)	Limits (dBμV/m)	Margin (dB)	Detector Type
1850	61.02	-11.92	49.10	74.00	-24.90	peak
1850	31.57	-11.92	19.65	54.00	-34.35	AVG
2785	52.40	-9.80	42.60	74.00	-31.40	peak
2785	32.54	-9.80	22.74	54.00	-31.26	AVG
4655	42.63	-3.03	39.60	74.00	-34.40	peak
4655	29.05	-3.03	26.02	54.00	-27.98	AVG

Remark:  
 Factor = Antenna Factor + Cable Loss – Pre-amplifier.  
 No emission above 18GHz.

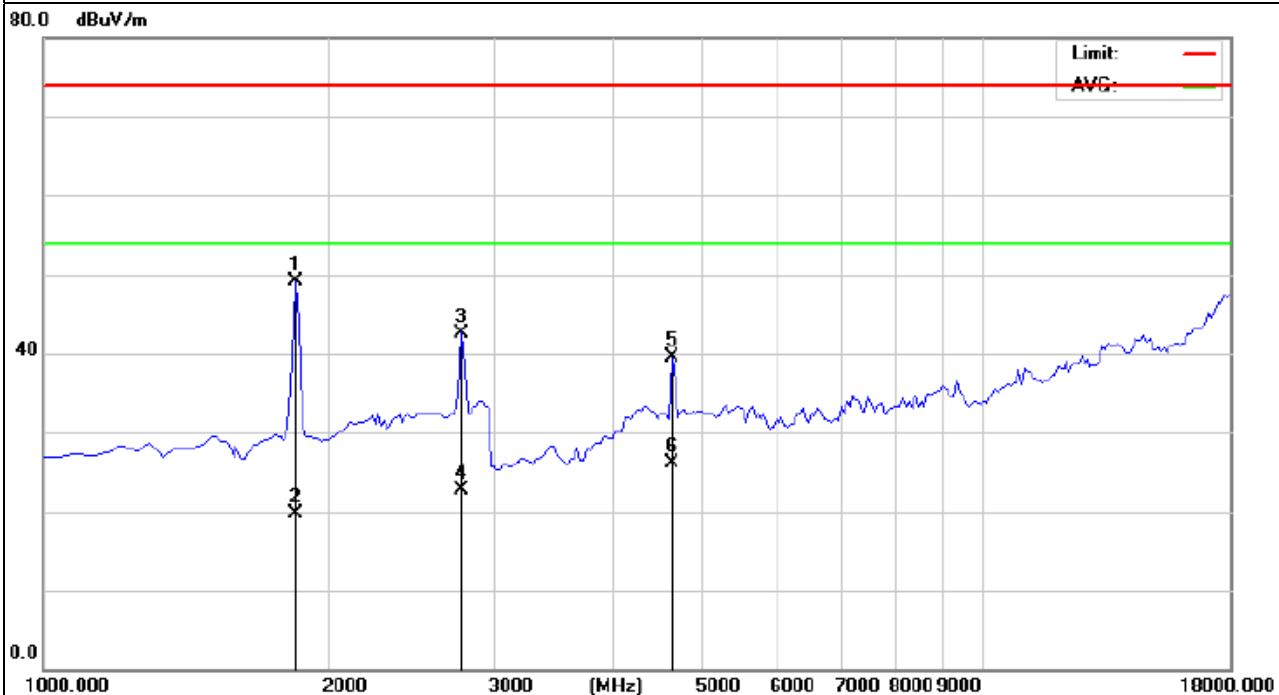

Note: 1:EUT Pre-scan X/Y/Z orientation, only worst case is presented in the report(X orientation).

### 3.4.8 TEST RESULTS (RESTRICTED BANDS REQUIREMENTS)

EUT :	LoRa RF Transceiver Module	Model Name :	LoRa 1276-C1-915
Temperature :	20 °C	Relative Humidity :	48%
Pressure :	1010 hPa	Test Voltage :	DC 3.3V
Test Mode :	TX -902.5MHz (ANT A)	Polarization :	Vertical

Frequency (MHz)	Meter Reading (dBμV)	Factor (dB)	Emission Level (dBμV/m)	Limits (dBμV/m)	Margin (dB)	Detector Type
839.9133	7.01	25.66	32.67	46	-13.33	QP
902	5.79	24.61	30.4	46	-15.6	QP
928	6.06	25.7	31.76	46	-14.24	QP
947.2141	6.57	26.64	33.21	46	-12.79	QP

Remark:  
Factor = Antenna Factor + Cable Loss – Pre-amplifier.

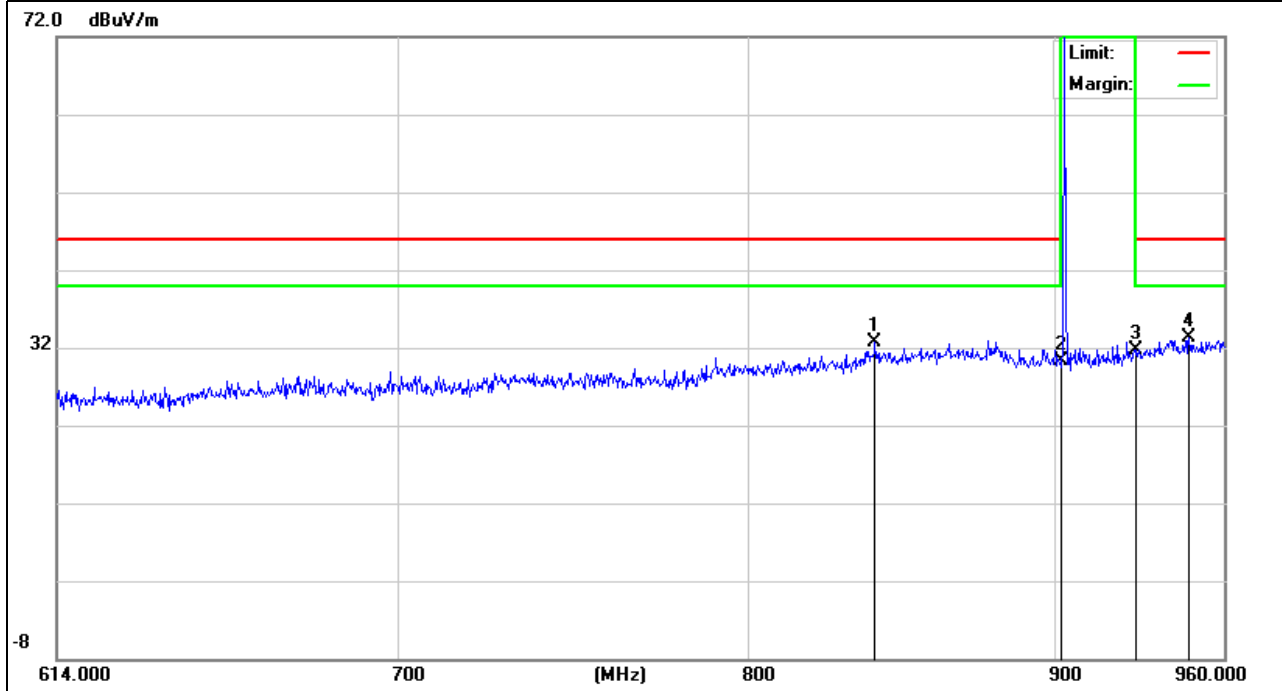

EUT :	LoRa RF Transceiver Module	Model Name :	LoRa 1276-C1-915
Temperature :	20 °C	Relative Humidity :	48%
Pressure :	1010 hPa	Test Voltage :	DC 3.3V
Test Mode :	TX -902.5MHz (ANT A)	Polarization :	Horizontal

Frequency (MHz)	Meter Reading (dBμV)	Factor (dB)	Emission Level (dBμV/m)	Limits (dBμV/m)	Margin (dB)	Detector Type
877.9112	7.05	25.93	32.98	46	-13.02	QP
902	7.02	24.61	31.63	46	-14.37	QP
928	6.08	25.7	31.78	46	-14.22	QP
954.865	7.32	26.82	34.14	46	-11.86	QP

Remark:  
Factor = Antenna Factor + Cable Loss – Pre-amplifier.

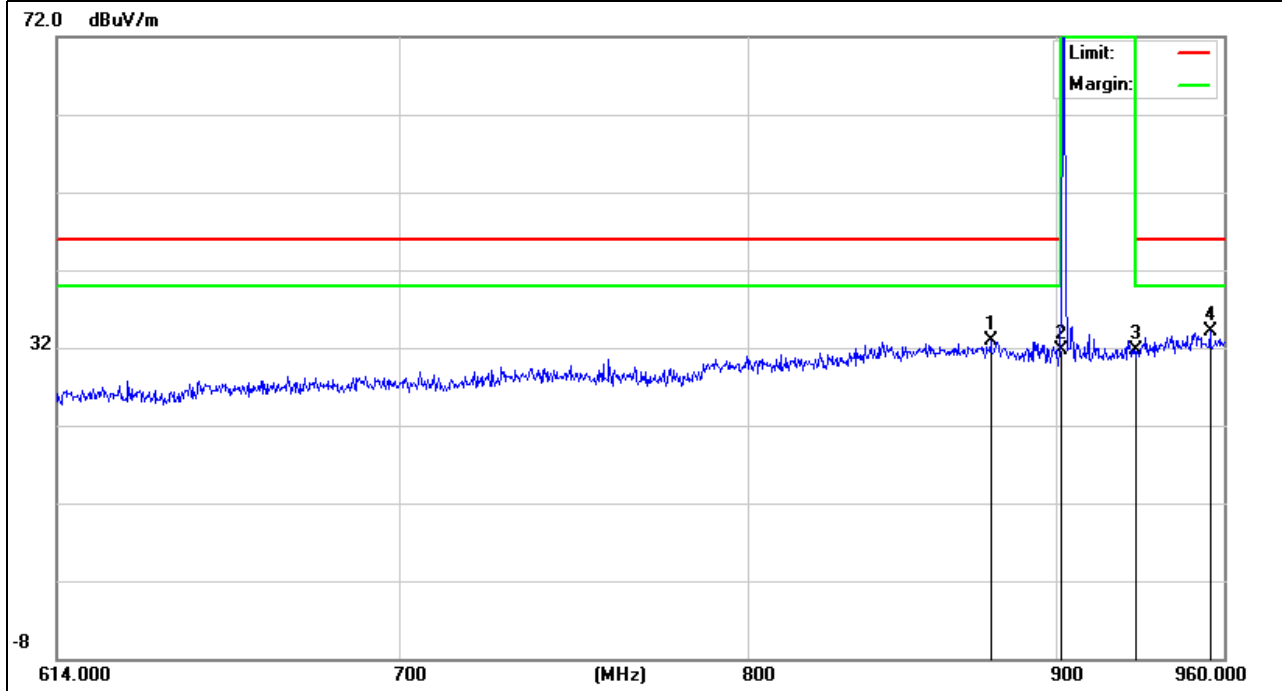

EUT :	LoRa RF Transceiver Module	Model Name :	LoRa 1276-C1-915
Temperature :	20 °C	Relative Humidity :	48%
Pressure :	1010 hPa	Test Voltage :	DC 3.3V
Test Mode :	TX -927.5MHz (ANT A)	Polarization :	Vertical

Frequency (MHz)	Meter Reading (dBμV)	Factor (dB)	Emission Level (dBμV/m)	Limits (dBμV/m)	Margin (dB)	Detector Type
856.9769	7.09	25.86	32.95	46	-13.05	QP
902	5.8	24.61	30.41	46	-15.59	QP
928	6.43	25.7	32.13	46	-13.87	QP
954.865	6.71	26.82	33.53	46	-12.47	QP

Remark:  
Factor = Antenna Factor + Cable Loss – Pre-amplifier.

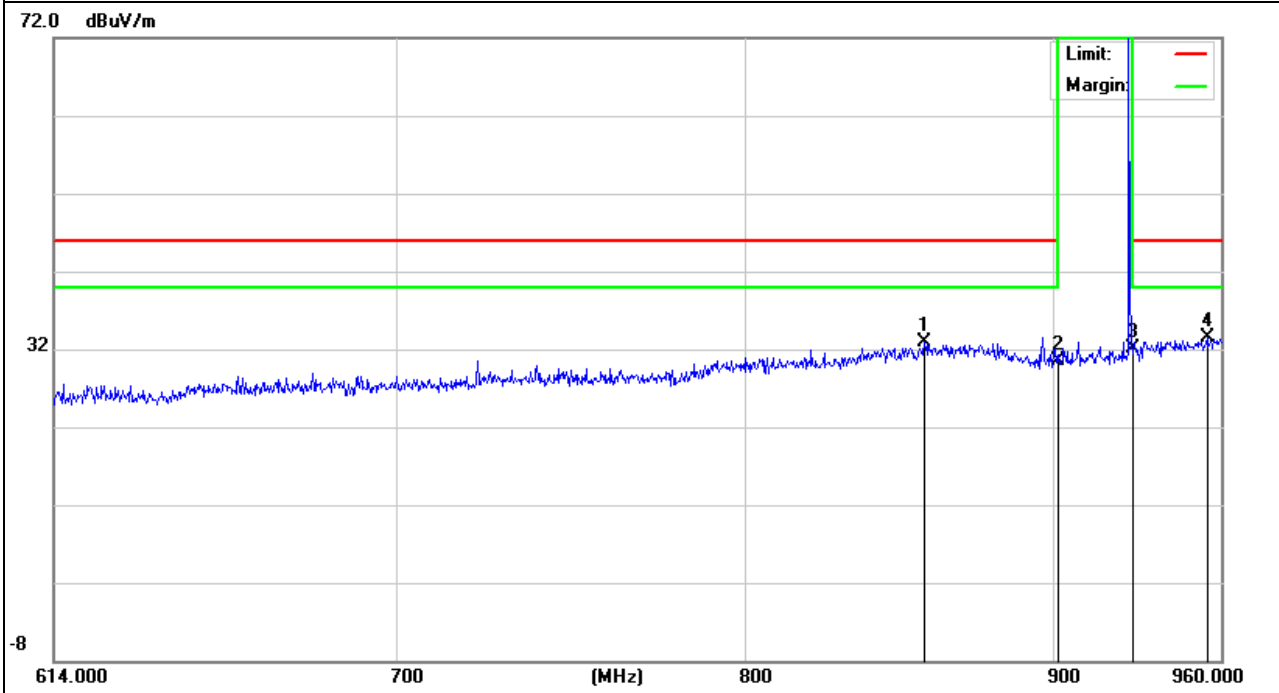

EUT :	LoRa RF Transceiver Module	Model Name :	LoRa 1276-C1-915
Temperature :	20 °C	Relative Humidity :	48%
Pressure :	1010 hPa	Test Voltage :	DC 3.3V
Test Mode :	TX -927.5MHz (ANT A)	Polarization :	Horizontal

Frequency (MHz)	Meter Reading (dBμV)	Factor (dB)	Emission Level (dBμV/m)	Limits (dBμV/m)	Margin (dB)	Detector Type
839.1629	7.63	25.58	33.21	46	-12.79	QP
902	5.87	24.61	30.48	46	-15.52	QP
928	8.03	25.7	33.73	46	-12.27	QP
936.6893	8.21	26.34	34.55	46	-11.45	QP

Remark:  
 Factor = Antenna Factor + Cable Loss – Pre-amplifier.

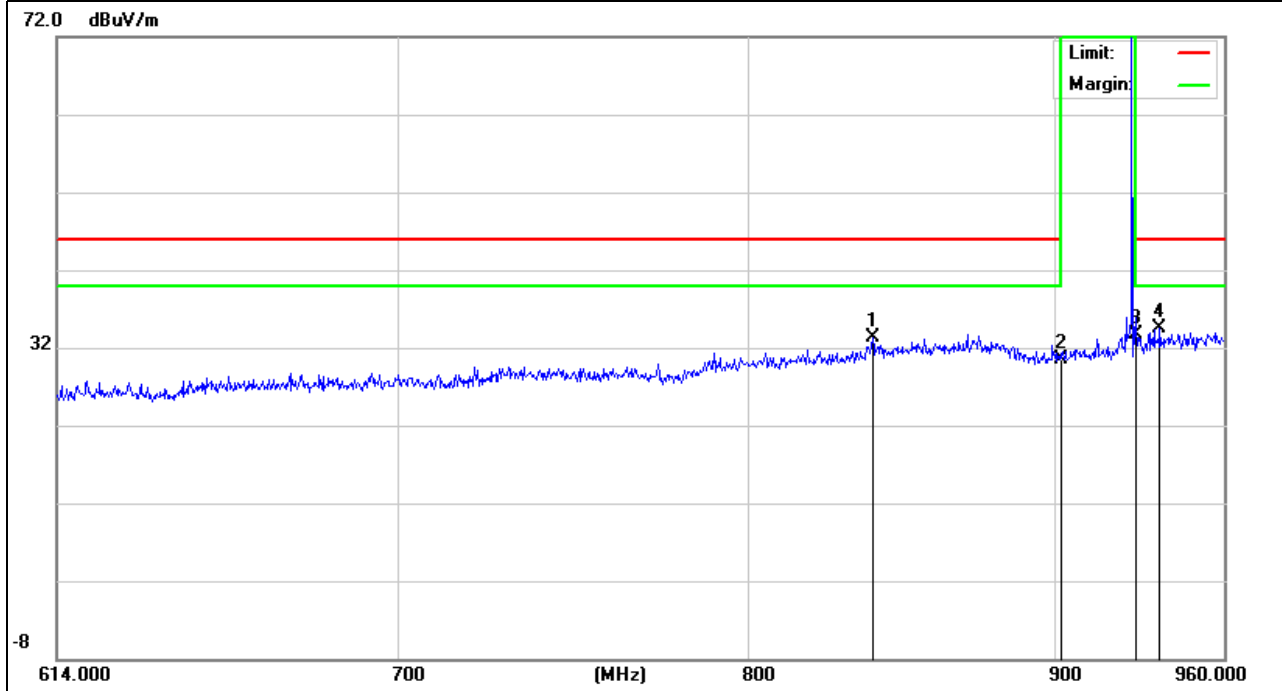

EUT :	LoRa RF Transceiver Module	Model Name :	LoRa 1276-C1-915
Temperature :	20 °C	Relative Humidity :	48%
Pressure :	1010 hPa	Test Voltage :	DC 3.3V
Test Mode :	TX -902.5MHz (ANT B)	Polarization :	Vertical

Frequency (MHz)	Meter Reading (dBμV)	Factor (dB)	Emission Level (dBμV/m)	Limits (dBμV/m)	Margin (dB)	Detector Type
839.9133	7.01	25.66	32.67	46.00	-13.33	QP
902	5.81	24.61	30.42	46.00	-15.58	QP
928	6.13	25.70	31.83	46.00	-14.17	QP
945.5221	6.57	26.63	33.20	46.00	-12.80	QP

Remark:  
 Factor = Antenna Factor + Cable Loss – Pre-amplifier.

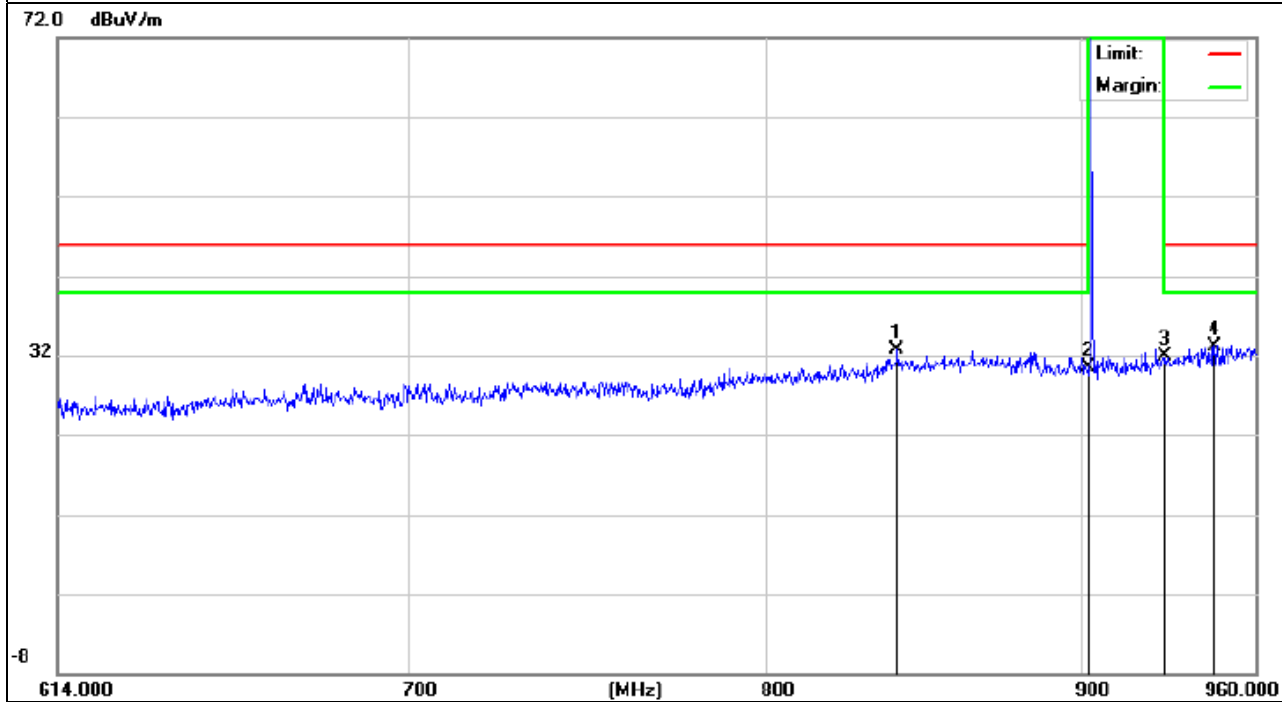



EUT :	LoRa RF Transceiver Module	Model Name :	LoRa 1276-C1-915
Temperature :	20 °C	Relative Humidity :	48%
Pressure :	1010 hPa	Test Voltage :	DC 3.3V
Test Mode :	TX -902.5MHz (ANT B)	Polarization :	Horizontal

Frequency (MHz)	Meter Reading (dBμV)	Factor (dB)	Emission Level (dBμV/m)	Limits (dBμV/m)	Margin (dB)	Detector Type
877.9112	7.05	25.93	32.98	46.00	-13.02	QP
902	5.88	24.61	30.49	46.00	-15.51	QP
928	4.88	25.70	30.58	46.00	-15.42	QP
954.865	7.32	26.82	34.14	46.00	-11.86	QP

Remark:  
Factor = Antenna Factor + Cable Loss – Pre-amplifier.

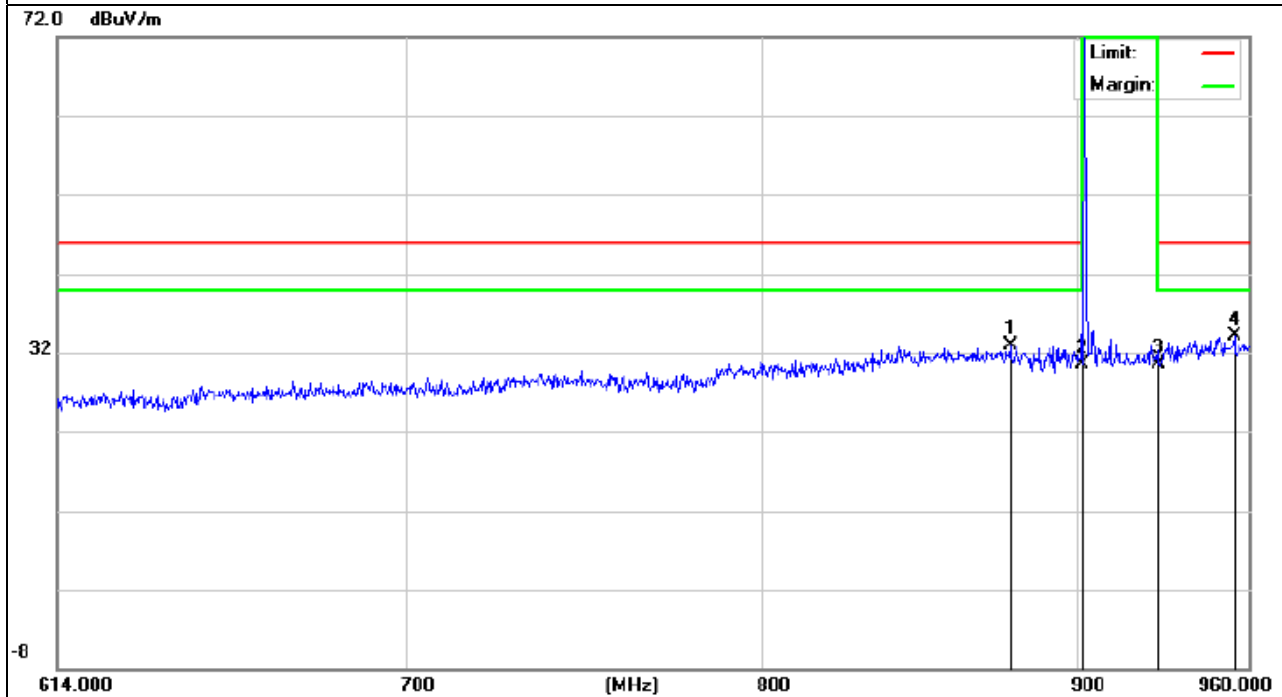

EUT :	LoRa RF Transceiver Module	Model Name :	LoRa 1276-C1-915
Temperature :	20 °C	Relative Humidity :	48%
Pressure :	1010 hPa	Test Voltage :	DC 3.3V
Test Mode :	TX -927.5MHz (ANT B)	Polarization :	Vertical

Frequency (MHz)	Meter Reading (dBμV)	Factor (dB)	Emission Level (dBμV/m)	Limits (dBμV/m)	Margin (dB)	Detector Type
856.9769	7.09	25.86	32.95	46.00	-13.05	QP
902	6.03	24.61	30.64	46.00	-15.36	QP
928	5.88	25.70	31.58	46.00	-14.42	QP
950.1820	5.88	26.66	32.54	46.00	-13.46	QP

Remark:  
Factor = Antenna Factor + Cable Loss – Pre-amplifier.

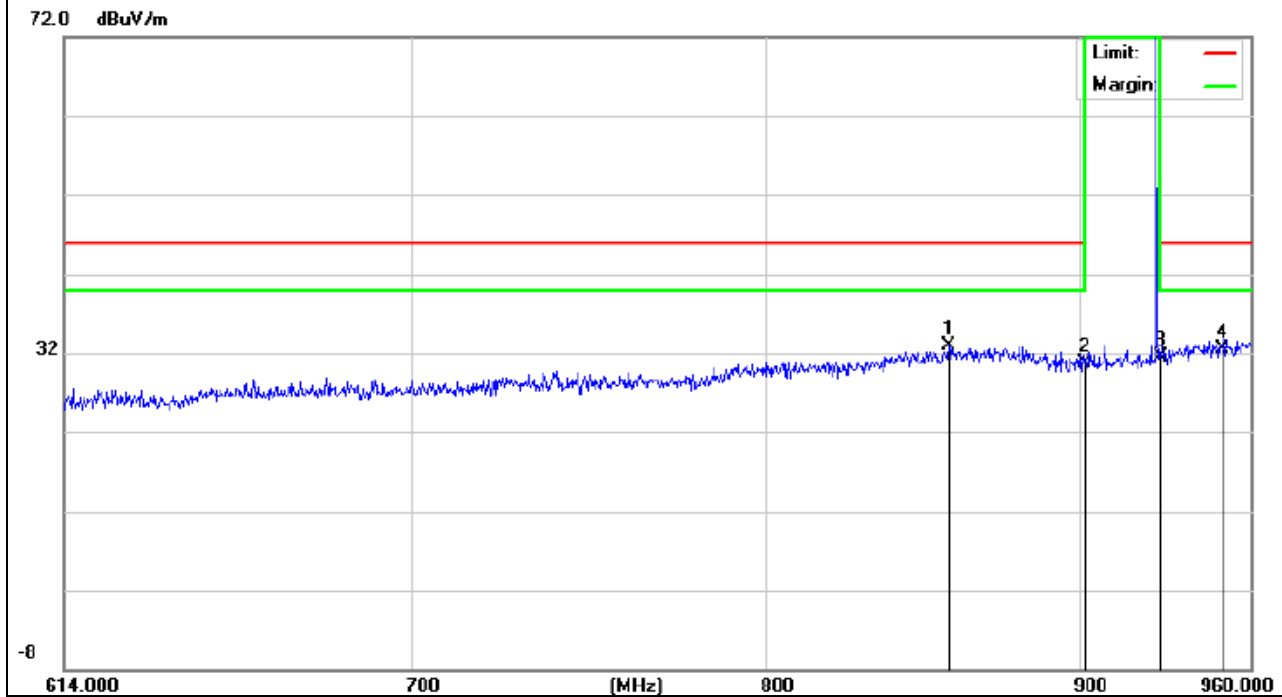

EUT :	LoRa RF Transceiver Module	Model Name :	LoRa 1276-C1-915
Temperature :	20 °C	Relative Humidity :	48%
Pressure :	1010 hPa	Test Voltage :	DC 3.3V
Test Mode :	TX -927.5MHz (ANT B)	Polarization :	Horizontal

Frequency (MHz)	Meter Reading (dBμV)	Factor (dB)	Emission Level (dBμV/m)	Limits (dBμV/m)	Margin (dB)	Detector Type
870.0987	7.68	25.93	33.61	46.00	-12.39	QP
902	6.03	24.61	30.64	46.00	-15.36	QP
928	8.90	25.70	34.60	46.00	-11.40	QP
942.5687	7.39	26.61	34.00	46.00	-12.00	QP

Remark:  
 Factor = Antenna Factor + Cable Loss – Pre-amplifier.

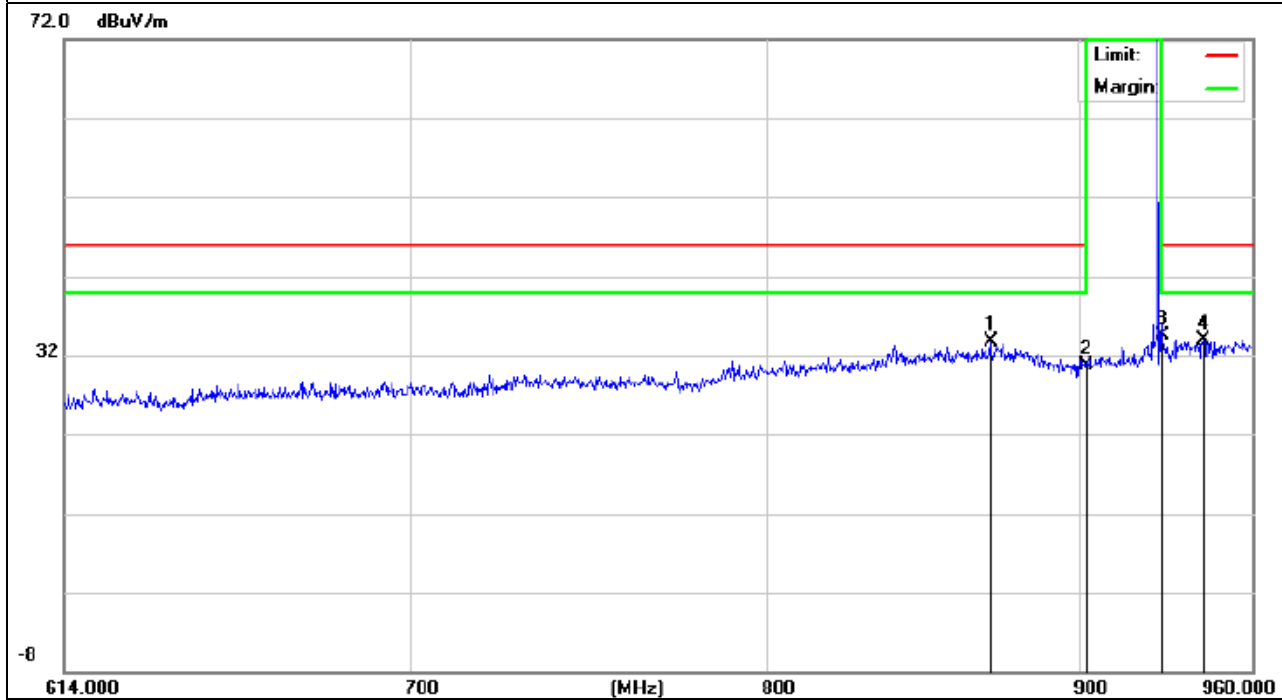

## 4. BANDWIDTH TEST

### 4.1 TEST PROCEDURE

- a) The spectrum analyzer center frequency is set to the nominal EUT channel center frequency. The span range for the EMI receiver or spectrum analyzer shall be between two times and five times the OBW.
- b) The nominal IF filter bandwidth (3 dB RBW) shall be in the range of 1% to 5% of the OBW and video bandwidth (VBW) shall be approximately three times RBW, unless otherwise specified by the applicable requirement.

### 4.2 DEVIATION FROM STANDARD

No deviation.

### 4.3 TEST SETUP



#### 4.4 TEST RESULTS

EUT :	LoRa RF Transceiver Module	Model Name :	LoRa 1276-C1-915
Temperature :	26 °C	Relative Humidity :	53%
Pressure :	1020 hPa	Test Power :	DC 3.3V
Test Mode :	TX		

Test Channel	Frequency (MHz)	20 dBc Bandwidth (kHz)
CH01	902.5	312.624
CH14	915.5	317.587
CH26	927.5	317.012

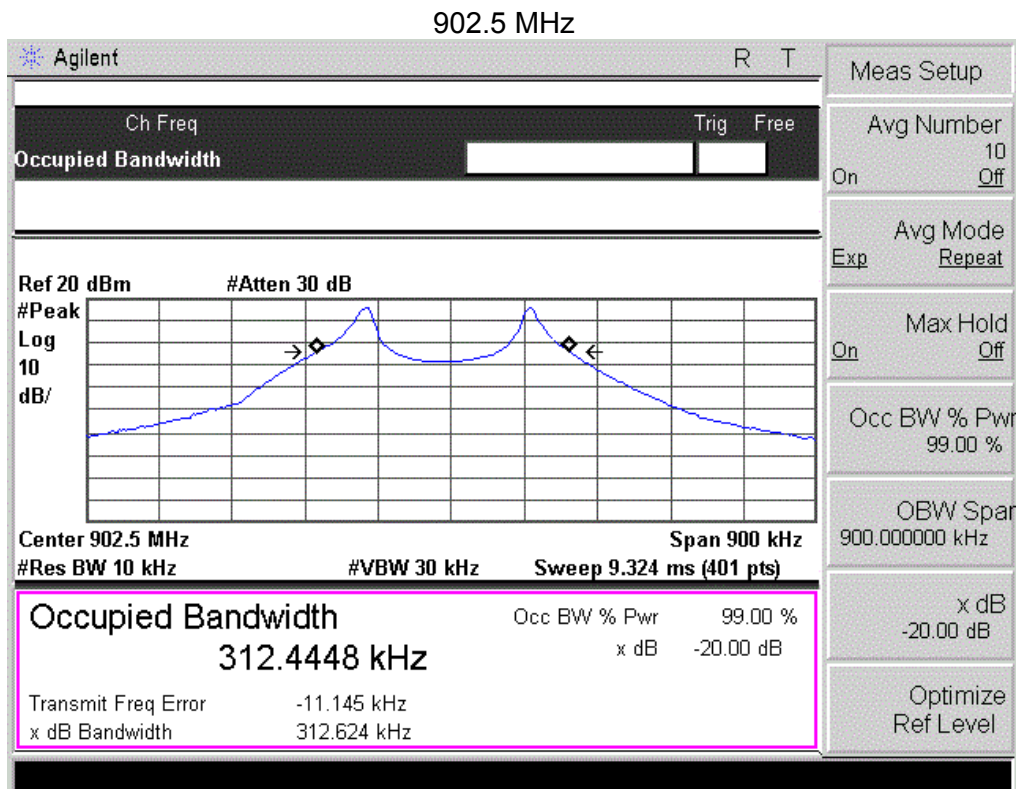

## 915.5 MHz

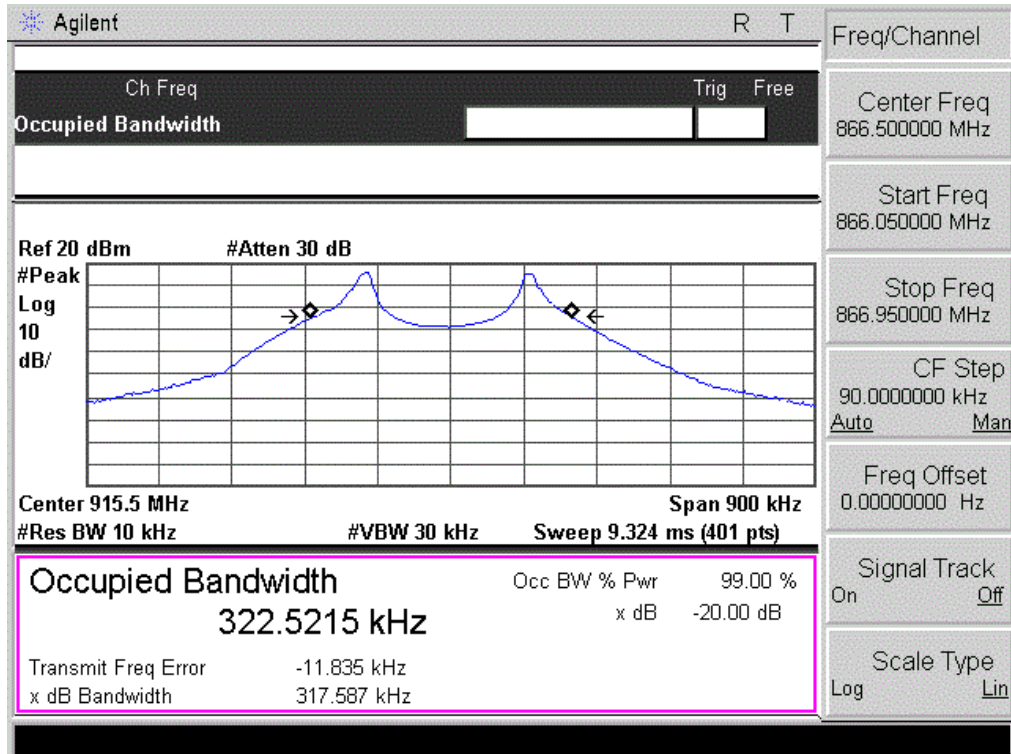

## 927.5 MHz

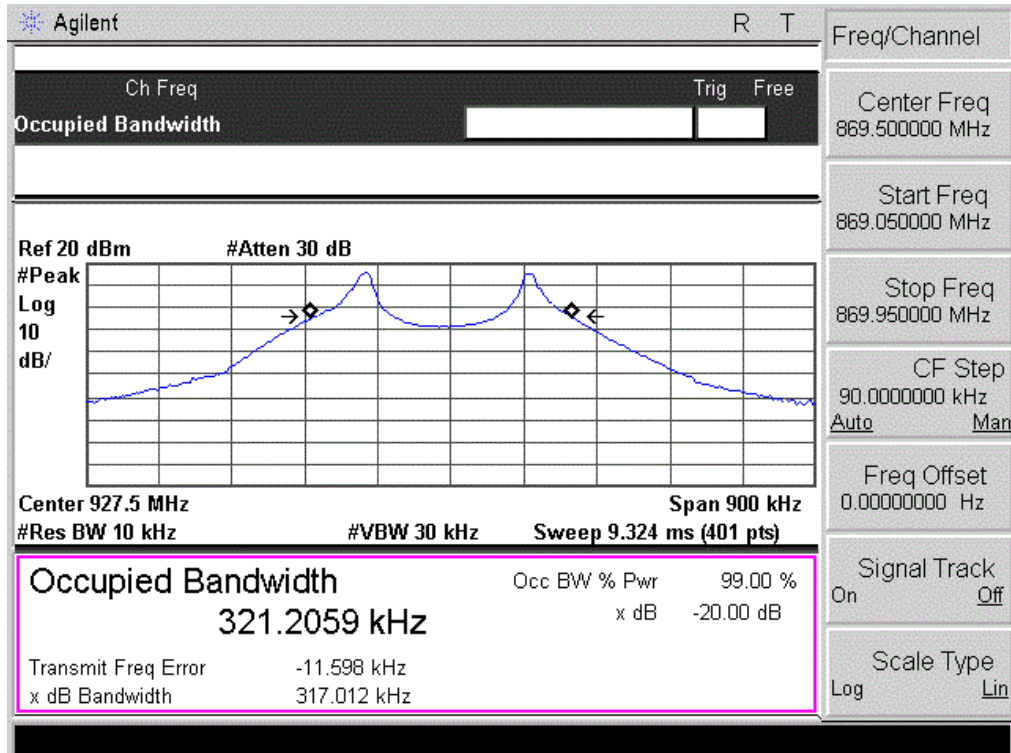

### 5. EUT TEST PHOTO

Radiated Measurement Photos

