



blackwebTM

**BLUETOOTH[®]
FM TRANSMITTER**

Model: BWB17AV004

PRODUCT GUIDE

FCC Statement

Warning: Changes or modifications to this unit not expressly approved by the party responsible

for compliance could void the user's authority to operate the equipment.

NOTE: This equipment has been tested and found to comply with the limits for a Class B digital device, pursuant to Part 15 of the FCC Rules. These limits are designed to provide reasonable protection against harmful interference in a residential installation. This equipment generates, uses and can radiate radio frequency energy and, if not installed and used in accordance with the instructions, may cause harmful interference to radio communications.

However, there is no guarantee that interference will not occur in a particular installation. If this equipment does cause harmful interference to radio or television reception, which can be determined by turning the equipment off and on, the user is encouraged to try to correct the interference by one or more of the following measures:

- Reorient or relocate the receiving antenna.
- Increase the separation between the equipment and receiver.
- Connect the equipment into an outlet on a circuit different from that to which the receiver is connected.
- Consult the dealer or an experienced radio/TV technician for help

The device must not be co-located or operating in conjunction with any other antenna or transmitter.

This device complies with Part 15 of the FCC Rules. Operation is subject to the following two conditions : (1) this device may not cause harmful interference, and (2) this device must accept any interference received, including interference that may cause undesired operation.

FCC RF Radiation Exposure Statement Caution: To maintain compliance with the FCC'S RF exposure guidelines, place the product at least 20cm from nearby persons.

FCC RF exposure information (SAR)

This device meets the government's requirements for exposure to radio waves. This device is designed and manufactured not to exceed the emission limits for exposure to radio frequency (RF) energy set by the Federal Communications Commission of the U.S. Government.



The exposure standard for wireless devices employs a unit of measurement known as the Specific Absorption Rate, or SAR. The SAR limit set by the FCC is 1.6 W/kg. Tests for SAR are conducted using standard operating positions accepted by the FCC with the device transmitting at its highest certified power level in all tested frequency bands. Although the SAR is determined at the highest certified power level, the actual SAR level of the device while operating can be well below the maximum value. This is because the device is designed to operate at multiple power levels so as to use only the power required to reach the network. In general, the closer you are to a wireless base station antenna, the lower the power output. While there may be differences between the SAR levels of various devices and at various positions, they all meet the government requirement.

Shielded cables must be used with this unit to ensure compliance with the Class B FCC limits.

- 1) The Responsible party information: Name, Address, Telephone Number**
- 2) The name and model number of the product**

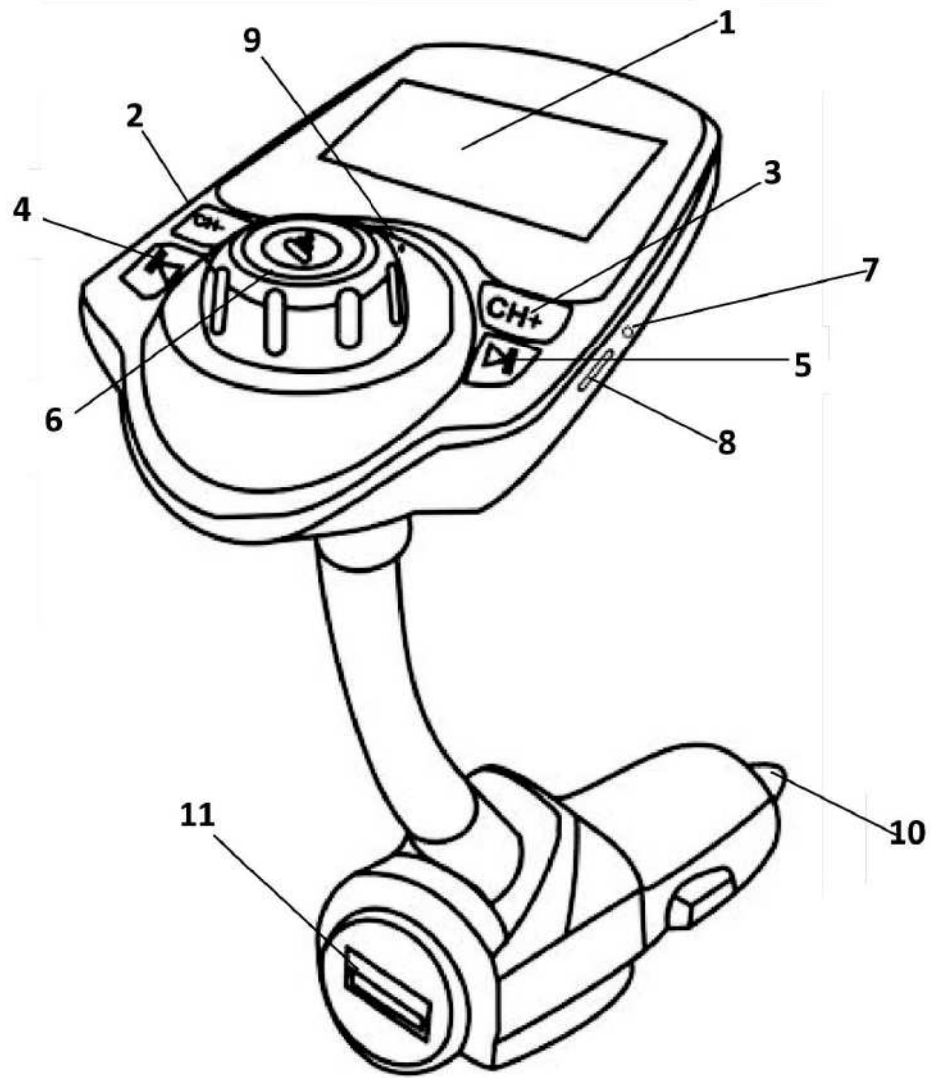
LOCATION OF CONTROLS



1. LCD Display
2. CH- Button
3. CH+ Button
4.  Button
5.  Button
6. Volume Control/  Knob
7. AUX (In) Jack
8. Micro SD Card Slot
9. Built-in Microphone
10. Car Cigarette Plug
11. USB Port (For charging the external USB Device)

OPERATION

For listening to music from your BT Device through the unit and your Car Radio, follow the steps below:

PAIRING:

Step1:

Pairing the unit to your Car Radio:

1. Connect the unit to the car cigarette lighter socket as illustrated below:

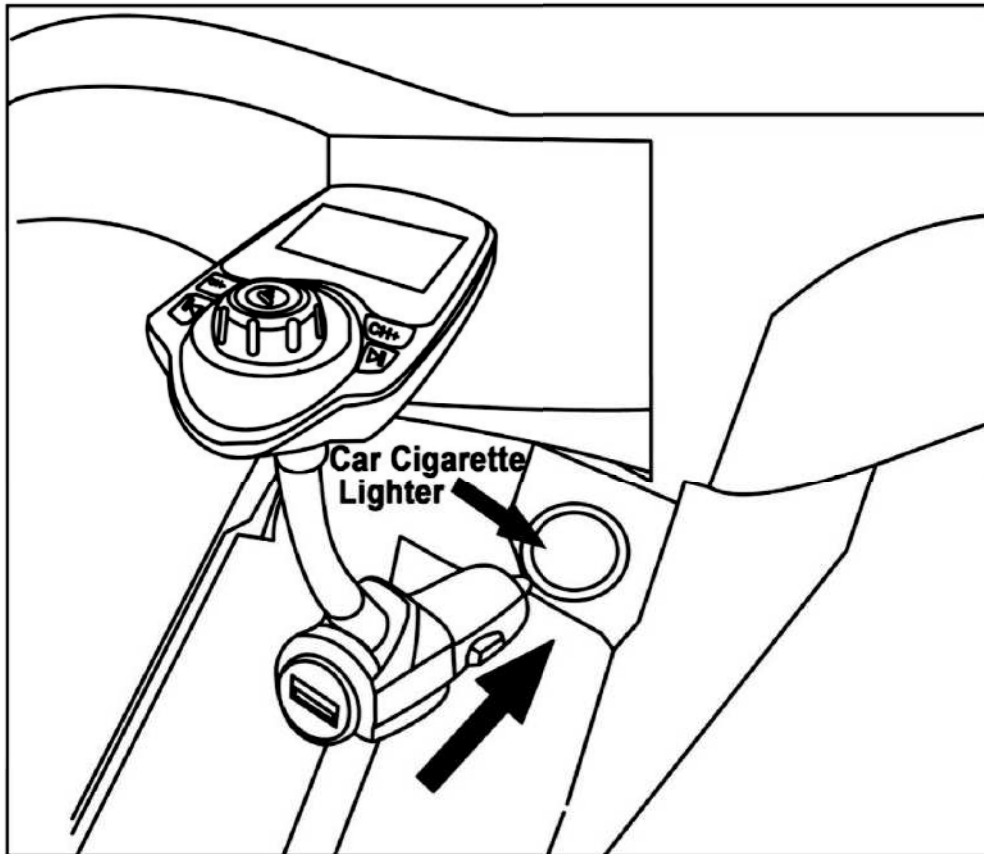

2. The unit will automatically power on and the voltage of the car battery will appear on the LCD Display on the unit as illustrated below:



3. A few seconds later, the following screen will appear:

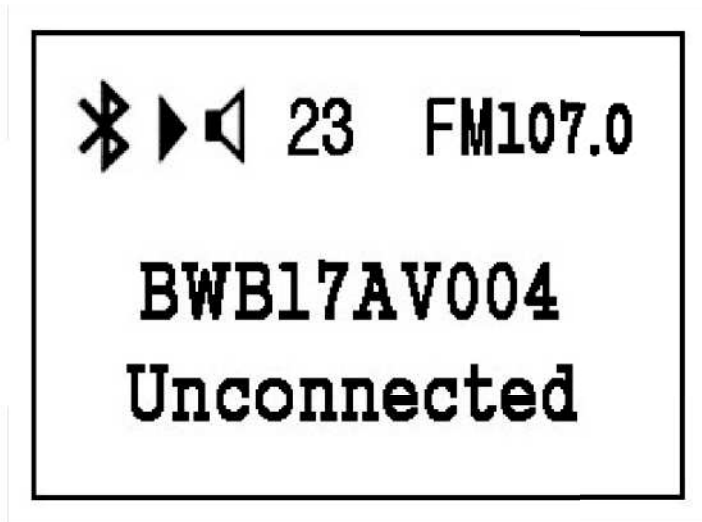

4. Turn on your Car Radio and enter the radio FM mode as usual. Search for a blank FM channel without any radio signal received (For example: 107.0 MHz).
5. Then press the CH- or CH+ Button on the unit repeatedly until the same channel frequency appear on the LCD display as illustrated below (For example: 107.0 MHz):

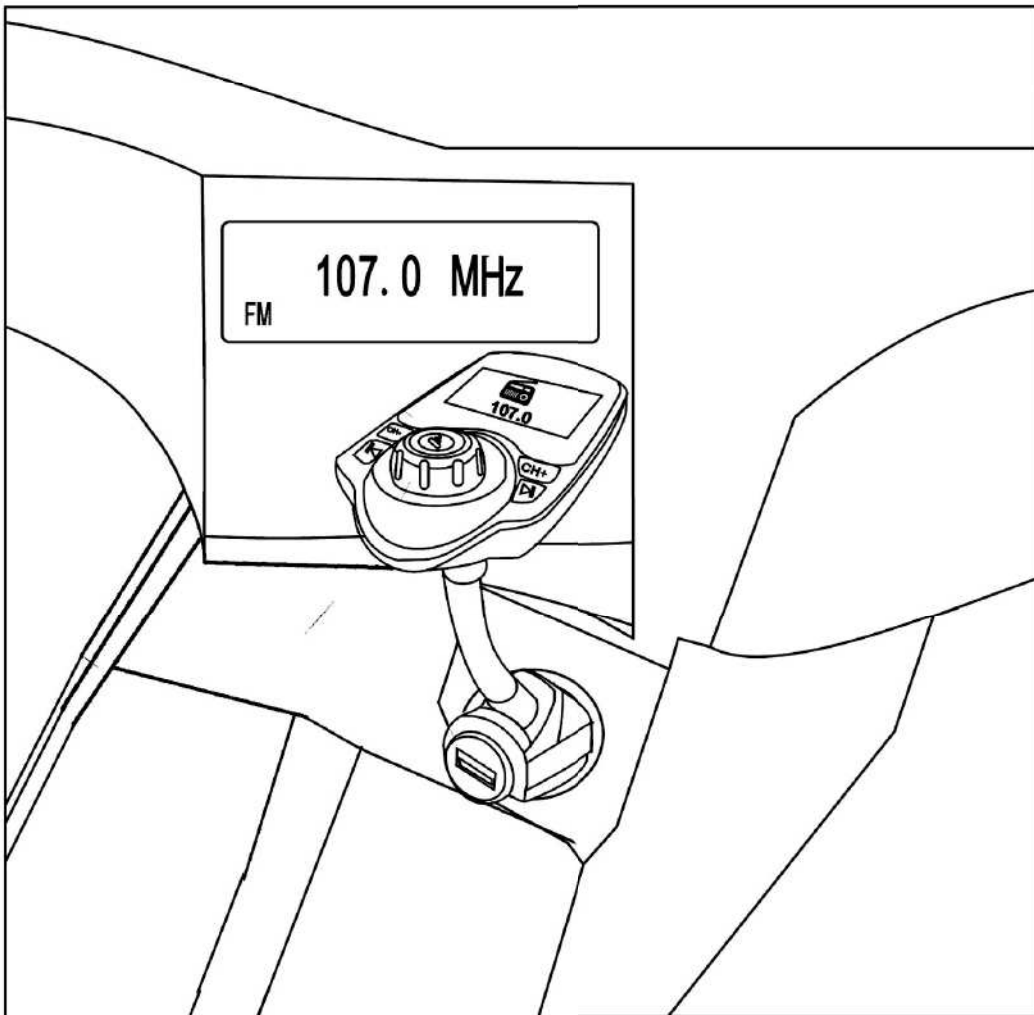

Step 2:

Pair your BT (Bluetooth) Device to the unit:

In first time use or re-pairing the unit to a new BT Device, pairing it as below:

1. Power on and pair the unit to Car Radio as step 1 above.
2. The BT logo  on the LCD Display and the Red Indicator on the Volume Control/

 Knob will blink.





3. Power on the external BT Device and enter to BT mode.
4. The unit will start pairing to the BT Device automatically. After pairing, the BT

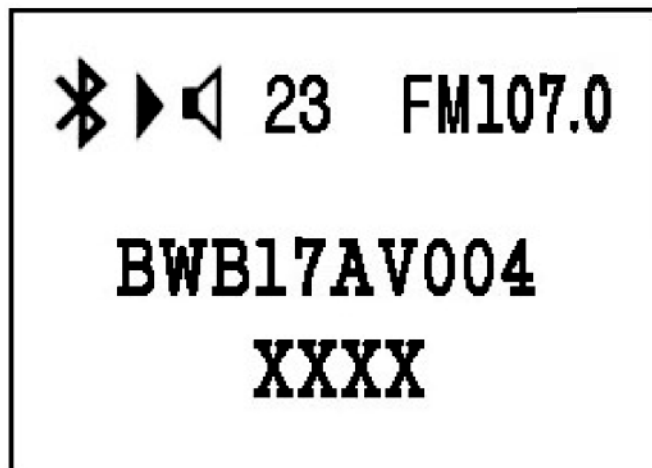

logo  on the LCD Display and the Red Indicator on the Volume Control/ 

Knob will stop blinking. The following picture will appear on the LCD Display (XXXX on the display is the name of paired device).



LISTENING TO MUSIC THROUGH PAIRED BT DEVICE:





1. After step 1 & 2, now you can play the music or answer the incoming call with the paired BT Device as usual.
2. During playback:
 - Turn the Volume Control/  Knob on the unit to adjust volume level as desire. (Or, use the Volume Controls on the Car Radio or paired BT Device to adjust volume level).
 - Press the Volume Control /  Knob to pause; press again to resume normal playback.
 - Press the  or  Buttons repeatedly to skip tracks.

3. If the unit is paired to a Cell Phone and a call is incoming during an active music session. Press and release the Volume Control /  Knob then speak to the built-in microphone to answer the call (Or, press and hold the knob approximately 1 second to reject the call). When your call is complete, press the Volume Control/  Knob to disconnect or end the call and resume to music playback.
4. To shut off the unit, unplug the unit from car cigarette lighter socket.

Notes:

- *When the external BT Device searches the unit, our model number "BWB17AV004" will appear on the display of external BT Device.*
- *If while pairing you are asked for a code please try "0000" or "1234".*

Normal operation after paired:

1. Power on the external BT Device and enter to BT mode.
2. Power on the Car Radio and previously receiving the preset FM frequency same as the preset of unit (For example: 107.0 MHz).
3. Connect the unit to the car cigarette lighter socket. The LCD Display will illuminate and the BT logo  and the Red Indicator on the Volume Control/  Knob on it will blink.
4. Wait a few seconds, the unit will automatically pair to the unit. After paired, the BT logo  and the Red Indicator on the Volume Control/  Knob on the LCD Display will stop blinking.
5. If pairing is complete you may now play music and answer the incoming call with your external BT Device.

AUX (IN):

For listening to music from external Audio Player (such as a MP3 Player, Discman ...etc.):





1. Connect one end of the supplied Audio Connection Cable to the AUX Out/Line Out/Phone Jack on the external Audio Player.
2. Connect the other end of the cable to the AUX Jack on the right of unit.

3. Play the music on the connected Player as usual. (Make sure the volume level of the connected Audio Player is turned to high level.)
4. Power on the Car Radio and the unit will pair them together as previously step 1.
5. Play the music on the connected Player as usual. (Make sure the volume level of the connected Audio Player is turned to high level.)
6. During playback
 - Use the Volume Controls on the Car Radio or connected Audio Player to adjust volume level.
 - Press the Volume Control/  Knob to pause: press again to resume normal playback
7. To shut off the unit, unplug the unit from car cigarette lighter socket.

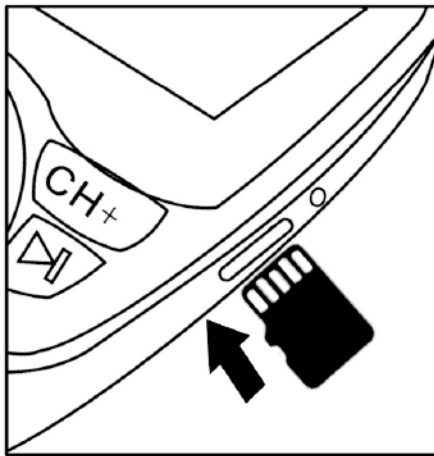
MICRO SD CARD:

1. Insert the Micro SD Card into the Micro SD Card Slot with contact finger face to the front as the marking on the unit and illustrated follows:



2. Connect the unit to the car cigarette lighter socket to power on the unit. Play will automatically start.
3. During playback:
 - Turn the Volume Control/  Knob on the unit to adjust volume level as desire. (Or, use the Volume Controls on the Car Radio or paired BT Device to adjust volume level).
 - Press the Volume Control/  Knob to pause: press again to resume normal playback.
 - Press the  or  Buttons to skip tracks.

4. To shut off the unit, unplug the unit from car cigarette lighter socket.





Notes:

- **When Micro SD Card is inserted into the unit. BT will automatically shut off. Unplug the card from the unit before use BT.**
- Up to 32 GB Micro SD Card the unit support to play.
- Before replacing Micro SD Card, make sure the unit is unplugged from the car cigarette lighter socket.
- When inserting the Micro SD Card, make sure the direction you selected is correct. Never insert violently to avoid damaging the Micro SD Card or the unit.
- If it doesn't work, please check if the direction is correct.
- You also need to download the desired music in MP3 format into the Micro SD Card before insert into the unit.

AUX (OUT):

If your car radio (or any external Audio Player) equipped AUX IN Jack. Connect the unit to your car radio (or the external Audio Player) through it and listen music from the paired BT device (or the external Audio Player) as follow:

1. Connect one end of the supplied Audio Connection Cable to the AUX IN Jack on your car radio (or the external Audio Player).
2. Connect the other end of the cable to the AUX Jack on the right of unit.
3. Power on the external BT Device and enter to BT mode.
4. Power on the Car Radio (or the external Audio Player) and set the input source to AUX IN mode.
5. Pair the external BT Device to the unit and play the music on it (or play the music on the Micro SD Card) as previously instructed.

6. During playback:
 - Turn the Volume Control/ Knob on the unit to adjust volume level as desire. (Or, use the Volume Controls on the Car Radio or paired BT Device to adjust volume level).
 - Press the Volume Control/ Knob to pause;+ press again to resume normal playback.
 - Press the  or  Buttons to skip tracks.
7. To shut off the unit, unplug the unit from car cigarette lighter socket.

NOTE:

When the Audio Connection Cable was inserted into the AUX Jack. BT will be cut off automatically. Unplug the cable from the AUX Jack before use BT.

BUILT-IN USB CHARGER:

The unit has a built-in USB Charger. Use it to charging the external USD Device as below:



1. Connect the unit to the car cigarette lighter socket to power on the unit.
2. Connect the full size USB Plug of the charging cable from the external USB Device to the USB Port.
3. Charging will automatically start. Monitoring the charging status by the Charging Indicators on the external USB Device as usual.
4. When finished charging, disconnect the external USB Device from the USB Port.

Note:

The unit has a built-in overload/overheats protector. If the output of the unit is overload (or short circuit). The charger will auto shut off. Unplug the external USB Device from the USB Port. The charge will auto reset.

TROUBLESHOOTING

Check the following before requesting service:

SYMPTOM	POSSIBLE CAUSE	POSSIBLE SOLUTION
Car Radio no sound	The radio frequency between the unit and Car Radio mismatch	Found and set the radio frequency of the Car Radio and unit in the same frequency
No sound or sound weak	Volume of the unit was set to minimum position	Increase the volume by turn the Volume Control/  Knob on the unit clockwise.
	Volume level of paired/connected device is in low level	Rise the volume level of the paired/connected device
Sound distortion	Volume level too high	Reduce the volume level by turn the Volume Control/  Knob on the unit counterclockwise
	Volume level of the connected/paired device too high	Reduce the volume level of the connected/paired device
BT not functioning	The external BT Device had NOT paired to the unit	Pair the external BT device to the unit as page 4-5
	The external BT device too far from the unit	Place the external BT device close to the unit
	Micro SD Card was inserted into the unit	Unplug the card from the unit before use BT
	Audio Connection Cable was inserted into the AUX Jack	Unplug the Audio Connection Cable from the AUX Jack before use BT

SPECIFICATTIONS:

Power source: DC  12 or 24 V, 1300 mAh (Max.) from car cigarette lighter socket

Output from Built-in USB Charger: DC  5 V, 2.1 A(Max.)

FM Transmitting Frequency: 87.5-108 MHz

FM Transmitting Power: 87 dBuv/107 dBuv

BT Version: 3.0

BT Operation Distance: 32 Feet in open area

PACKAGE INCLUDES:

1 x Owner's Manual

1 x Audio Connection Cables with 3.5mm Plugs

SPECIFICATIONS AND ACCESSORIES ARE SUBJECT TO CHANGE WITHOUT NOTICE