



## STC Test Report

Date: 2015-08-05

Page 1 of 86

No.: DM120254

**Applicant:** Shenzhen Orderly Electronics Co., Ltd.  
4F, Building 7, Asian Industry Park, Bantian Street,  
Longgang District, Shenzhen, China

**Manufacturer:** Shenzhen Orderly Electronics Co., Ltd.  
4F, Building 7, Asian Industry Park, Bantian Street,  
Longgang District, Shenzhen, China

**Description of Sample(s):** Product: Bluetooth Speaker  
Brand Name: CRAIG  
Model Number: CMA3568  
FCC ID: 2AD5YBS201502

**Date Sample(s) Received:** 2015-07-14

**Date Tested:** 2015-07-18 to 2015-08-04

**Investigation Requested:** Perform ElectroMagnetic Interference measurement in accordance with FCC 47CFR [Codes of Federal Regulations] Part 15: 2014 and ANSI C63.4: 2009 for FCC Certification.

**Conclusion(s):** The submitted product COMPLIED with the requirements of Federal Communications Commission [FCC] Rules and Regulations Part 15. The tests were performed in accordance with the standards described above and on Section 2.2 in this Test Report.

**Remark(s):** ---



LONG Yun Jian, Along  
Authorized Signatory  
ElectroMagnetic Compatibility Department  
For and on behalf of  
STC (Dongguan) Company Limited

### STC (Dongguan) Company Limited

68 Fumin Nan Road, Dalang, Dongguan, China. (Zip Code : 523 770)

Tel : (86 769) 8111 9888 Fax : (86 769) 8111 6222 E-mail : dgstc@dgstc.org Homepage : www.dgstc.org

This report shall not be reproduced unless with prior written approval from STC (Dongguan) Company Limited.  
For Conditions of Issuance of this test report, please refer to the overleaf or Homepage.



## STC Test Report

Date: 2015-08-05

Page 2 of 86

No.: DM120254

### **CONTENT:**

Cover	Page 1 of 86	
Content	Page 2 of 86	
<b><u>1.0</u></b>	<b><u>General Details</u></b>	
1.1	Test Laboratory	Page 3 of 86
1.2	Equipment Under Test [EUT] Description of EUT operation	Page 3 of 86
1.3	Date of Order	Page 3 of 86
1.4	Submitted Sample	Page 3 of 86
1.5	Test Duration	Page 3 of 86
1.6	Country of Origin	Page 3 of 86
1.7	RF Module Details	Page 4 of 86
1.8	Antenna Details	Page 4 of 86
<b><u>2.0</u></b>	<b><u>Technical Details</u></b>	
2.1	Investigations Requested	Page 5 of 86
2.2	Test Standards and Results Summary	Page 5 of 86
2.3	Table for Test Modes	Page 6 of 86
<b><u>3.0</u></b>	<b><u>Test Results</u></b>	
3.1	Emission	Page 7 – 82 of 86
	<b><u>Appendix A</u></b> List of Measurement Equipment	Page 83 of 86
	<b><u>Appendix B</u></b> Ancillary Equipment	Page 83 of 86
	<b><u>Appendix C</u></b> Photographs	Page 84-86 of 86

### **STC (Dongguan) Company Limited**

68 Fumin Nan Road, Dalang, Dongguan, China. (Zip Code : 523 770)

Tel : (86 769) 8111 9888 Fax : (86 769) 8111 6222 E-mail : dgstc@dgstc.org Homepage : www.dgstc.org

This report shall not be reproduced unless with prior written approval from STC (Dongguan) Company Limited.  
For Conditions of Issuance of this test report, please refer to the overleaf or Homepage.



## STC Test Report

Date: 2015-08-05

Page 3 of 86

No.: DM120254

### **1.0 General Details**

#### **1.1 Test Laboratory**

STC (Dongguan) Company Limited  
EMC Laboratory  
68 Fumin Nan Road, Dalang, Dongguan, Guangdong, China

Telephone: (86 769) 81119888

Fax: (86 769) 81116222

#### **1.2 Equipment Under Test [EUT]**

##### **Description of Sample(s)**

Product: Bluetooth Speaker  
Manufacturer: Shenzhen Orderly Electronics Co., Ltd.  
4F, Building 7, Asian Industry Park, Bantian Street,  
Longgang District, Shenzhen, China  
Brand Name: CRAIG  
Model Number: CMA3568  
Rating: 5.0Vd.c. (Powered by USB port) / Li-ion rechargeable  
battery x1 = 3.7Vd.c-

##### **1.2.1 Description of EUT Operation**

The Equipment Under Test (EUT) is a Bluetooth Speaker. The r.f. signal was modulated by IC and type of modulation was frequency hopping spread spectrum Modulation.

#### **1.3 Date of Order**

2015-07-14

#### **1.4 Submitted Sample(s):**

1 Sample

#### **1.5 Test Duration**

2015-07-18 to 2015-08-04

#### **1.6 Country of Origin**

China

### **STC (Dongguan) Company Limited**

68 Fumin Nan Road, Dalang, Dongguan, China. (Zip Code : 523 770)

Tel : (86 769) 8111 9888 Fax : (86 769) 8111 6222 E-mail : dgstc@dgstc.org Homepage : www.dgstc.org

This report shall not be reproduced unless with prior written approval from STC (Dongguan) Company Limited.  
For Conditions of Issuance of this test report, please refer to the overleaf or Homepage.



## STC Test Report

Date: 2015-08-05

Page 4 of 86

No.: DM120254

### **1.7 RF Module Details**

Module Model Number:	CW6685C
Module FCC ID:	N/A
Module Transmission Type:	Bluetooth 3.0+EDR
Modulation:	FHSS (GFSK / $\pi/4$ -DQPSK / 8DPSK)
Data Rates:	1Mbps: GFSK 2 Mbps: $\pi/4$ -DQPSK 3 Mbps: 8DPSK
Frequency Range:	2400-2483.5MHz
Carrier Frequencies:	2402MHz – 2480MHz

Module Specification (specification provided by manufacturer)

### **1.8 Antenna Details**

Antenna Type:	Meander type PCB antenna
Antenna Gain:	1.9dBi

## **STC (Dongguan) Company Limited**

68 Fumin Nan Road, Dalang, Dongguan, China. (Zip Code : 523 770)

Tel : (86 769) 8111 9888 Fax : (86 769) 8111 6222 E-mail : dgstc@dgstc.org Homepage : www.dgstc.org

This report shall not be reproduced unless with prior written approval from STC (Dongguan) Company Limited.  
For Conditions of Issuance of this test report, please refer to the overleaf or Homepage.



## STC Test Report

Date: 2015-08-05

Page 5 of 86

No.: DM120254

### **2.0** **Technical Details**

#### **2.1** **Investigations Requested**

Perform Electromagnetic Interference measurements in accordance with FCC 47CFR [Codes of Federal Regulations] Part 15: 2014 Regulations. FCC Pubic Notice DA 00-705 and ANSI C63.4: 2009 for FCC Certification.

#### **2.2** **Test Standards and Results Summary Tables**

EMISSION Results Summary						
Test Condition	Test Requirement	Test Method	Class / Severity	Test Result		
				Pass	Fail	N/A
Maximum Peak Conducted Output Power	FCC 47CFR 15.247(b)(1)	FCC Pubic Notice DA 00-705	N/A	<input checked="" type="checkbox"/>	<input type="checkbox"/>	<input type="checkbox"/>
Radiated Spurious Emissions	FCC 47CFR 15.209	ANSI C63.4:2009	N/A	<input checked="" type="checkbox"/>	<input type="checkbox"/>	<input type="checkbox"/>
AC Mains Conducted Emissions	FCC 47CFR 15.207	ANSI C63.4:2009	N/A	<input checked="" type="checkbox"/>	<input type="checkbox"/>	<input type="checkbox"/>
Number of Hopping Frequency	FCC 47CFR 15.247 (b)(1)	FCC Pubic Notice DA 00-705	N/A	<input checked="" type="checkbox"/>	<input type="checkbox"/>	<input type="checkbox"/>
20dB Bandwidth	FCC 47CFR 15.247(a)(2)	FCC Pubic Notice DA 00-705	N/A	<input checked="" type="checkbox"/>	<input type="checkbox"/>	<input type="checkbox"/>
Hopping Channel Separation	FCC 47CFR 15.247(a)(1)	FCC Pubic Notice DA 00-705	N/A	<input checked="" type="checkbox"/>	<input type="checkbox"/>	<input type="checkbox"/>
Band-edge measurement (Radiated)	FCC 47CFR 15.247(d)	FCC Pubic Notice DA 00-705	N/A	<input checked="" type="checkbox"/>	<input type="checkbox"/>	<input type="checkbox"/>
Pseudorandom Hopping Algorithm	FCC 47CFR 15.247(a)(1)	N/A	N/A	<input checked="" type="checkbox"/>	<input type="checkbox"/>	<input type="checkbox"/>
Time of Occupancy (Dwell Time)	FCC 47CFR 15.247(a)(1)(iii)	FCC Pubic Notice DA 00-705	N/A	<input checked="" type="checkbox"/>	<input type="checkbox"/>	<input type="checkbox"/>
Antenna requirement	FCC 47CFR 15.203	N/A	N/A	<input checked="" type="checkbox"/>	<input type="checkbox"/>	<input type="checkbox"/>
RF Exposure	FCC 47CFR 15.247(i)	N/A	N/A	<input checked="" type="checkbox"/>	<input type="checkbox"/>	<input type="checkbox"/>

Note: N/A – Not Applicable

### **STC (Dongguan) Company Limited**

68 Fumin Nan Road, Dalang, Dongguan, China. (Zip Code : 523 770)

Tel : (86 769) 8111 9888 Fax : (86 769) 8111 6222 E-mail : dgstc@dgstc.org Homepage : www.dgstc.org

This report shall not be reproduced unless with prior written approval from STC (Dongguan) Company Limited.  
For Conditions of Issuance of this test report, please refer to the overleaf or Homepage.



## STC Test Report

Date: 2015-08-05

Page 6 of 86

No.: DM120254

### 2.3 Table for Test Modes

Preliminary tests were performed in different data rate to find the worst radiated emission. The data rate in the table below is the worst case rate with respect to the specific test item.

Investigation has been done on all the possible configurations for searching the worst cases.

The following table is a list of the test modes shown in this test report.

Test Items	Mode	Data Rate
Maximum Peak Conducted Output Power	GFSK / $\pi/4$ -DQPSK / 8DPSK	1MBps / 2MBps / 3MBps
Hopping Channel Separation	GFSK / $\pi/4$ -DQPSK / 8DPSK	1MBps / 2MBps / 3MBps
Number of Hopping Frequency	GFSK / $\pi/4$ -DQPSK / 8DPSK	2MBps
Time of Occupancy(Dwell Time)	8DPSK (DH1 / DH3 / DH5)	2MBps
Radiated Spurious Emissions	GFSK / $\pi/4$ -DQPSK / 8DPSK	1MBps / 2MBps / 3MBps
Band-edge compliance of Conducted Emission	GFSK / $\pi/4$ -DQPSK / 8DPSK	2MBps

### STC (Dongguan) Company Limited

68 Fumin Nan Road, Dalang, Dongguan, China. (Zip Code : 523 770)

Tel : (86 769) 8111 9888 Fax : (86 769) 8111 6222 E-mail : dgstc@dgstc.org Homepage : www.dgstc.org

This report shall not be reproduced unless with prior written approval from STC (Dongguan) Company Limited.

For Conditions of Issuance of this test report, please refer to the overleaf or Homepage.



## STC Test Report

Date: 2015-08-05

Page 7 of 86

No.: DM120254

### **3.0 Test Results**

#### **3.1 Emission**

##### **3.1.1 Maximum Peak Conducted Output Power**

Test Requirement:	FCC 47CFR 15.247(b)(1)
Test Method:	FCC Pubic Notice DA 00-705
Test Date:	2015-07-21
Mode of Operation:	Tx mode

#### **Test Method:**

A temporary antenna connector was soldered to the RF output. The RF output of the EUT was connected to the spectrum analyzer. All the attenuation or cable loss will be added to the measured maximum output power. The results are recorded in dBm.

#### **Spectrum Analyzer Setting:**

RBW = 3 MHz, VBW = 3MHz, Sweep = Auto, Span = 10MHz  
Detector = Peak, Trace = Max. hold

#### **Test Setup:**

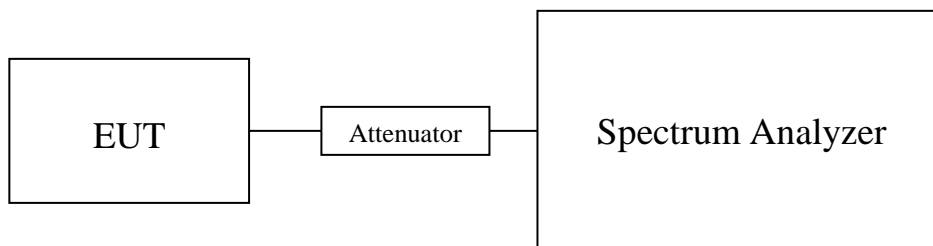

Note: a temporary antenna connector was soldered to the RF output.

### **STC (Dongguan) Company Limited**

68 Fumin Nan Road, Dalang, Dongguan, China. (Zip Code : 523 770)

Tel : (86 769) 8111 9888 Fax : (86 769) 8111 6222 E-mail : dgstc@dgstc.org Homepage : www.dgstc.org

This report shall not be reproduced unless with prior written approval from STC (Dongguan) Company Limited.  
For Conditions of Issuance of this test report, please refer to the overleaf or Homepage.



## STC Test Report

Date: 2015-08-05

Page 8 of 86

No.: DM120254

### Limits for Maximum Peak Conducted Output Power [FCC 47CFR 15.247]:

The maximum peak output power shall not exceeded the following limits:  
 For frequency hopping systems employing at least 75 hopping channels: 1 Watt  
 For all other frequency hopping systems in the 2400-2483.5 MHz band: 0.125 Watts  
 For Digital Transmission systems in 2400-2483.5 MHz Band: 1 Watt

### Results of Bluetooth Communication mode (GFSK) (Fundamental Power): Pass

Transmitter Frequency (MHz)	Maximum conducted output power (Watt)
2402	0.000230

Transmitter Frequency (MHz)	Maximum conducted output power (Watt)
2441	0.000197

Transmitter Frequency (MHz)	Maximum conducted output power (Watt)
2480	0.000173

### Results of Bluetooth Communication mode ( $\pi/4$ -DQPSK) (Fundamental Power): Pass

Transmitter Frequency (MHz)	Maximum conducted output power (Watt)
2402	0.000147

Transmitter Frequency (MHz)	Maximum conducted output power (Watt)
2441	0.000149

Transmitter Frequency (MHz)	Maximum conducted output power (Watt)
2480	0.000132

### Results of Bluetooth Communication mode (8 DPSK) (Fundamental Power): Pass

Transmitter Frequency (MHz)	Maximum conducted output power (Watt)
2402	0.000171

Transmitter Frequency (MHz)	Maximum conducted output power (Watt)
2441	0.000165

Transmitter Frequency (MHz)	Maximum conducted output power (Watt)
2480	0.000132

Calculated measurement uncertainty : 30MHz to 1GHz 1.7dB  
 1GHz to 18GHz 1.7dB

#### Remark:

1. All test data for each data rate were verified, but only the worst case was reported.
2. The EUT is programmed to transmit signals continuously for all testing.

### STC (Dongguan) Company Limited

68 Fumin Nan Road, Dalang, Dongguan, China. (Zip Code : 523 770)

Tel : (86 769) 8111 9888 Fax : (86 769) 8111 6222 E-mail : dgstc@dgstc.org Homepage : www.dgstc.org

This report shall not be reproduced unless with prior written approval from STC (Dongguan) Company Limited.  
For Conditions of Issuance of this test report, please refer to the overleaf or Homepage.







## STC Test Report

Date: 2015-08-05

Page 10 of 86

No.: DM120254

### Bluetooth Communication mode (GFSK, 2480MHz)

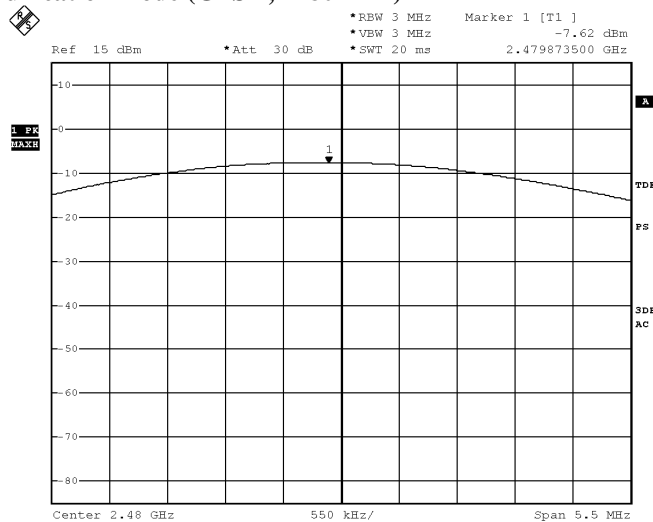

BMP  
Date: 20.JUL.2015 14:04:40

### Bluetooth Communication mode ( $\pi/4$ -DQPSK, 2402MHz)

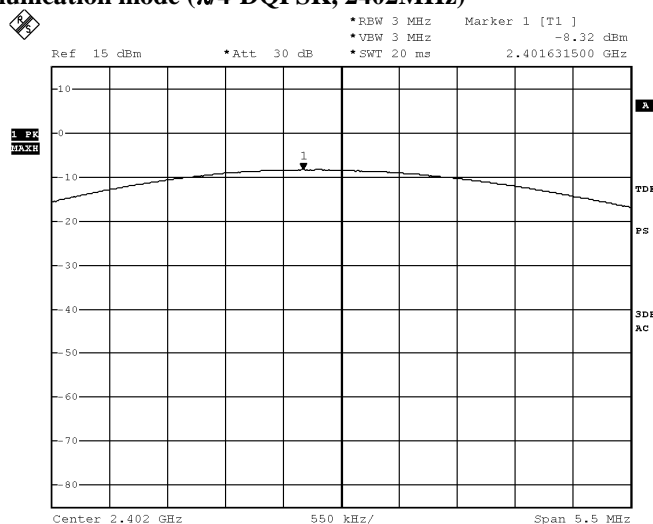

BMP  
Date: 20.JUL.2015 13:59:40

## STC (Dongguan) Company Limited

68 Fumin Nan Road, Dalang, Dongguan, China. (Zip Code : 523 770)

Tel : (86 769) 8111 9888 Fax : (86 769) 8111 6222 E-mail : dgstc@dgstc.org Homepage : www.dgstc.org

This report shall not be reproduced unless with prior written approval from STC (Dongguan) Company Limited.  
For Conditions of Issuance of this test report, please refer to the overleaf or Homepage.







## STC Test Report

Date: 2015-08-05

Page 13 of 86

No.: DM120254

### Bluetooth Communication mode (8DPSK, 2480MHz)

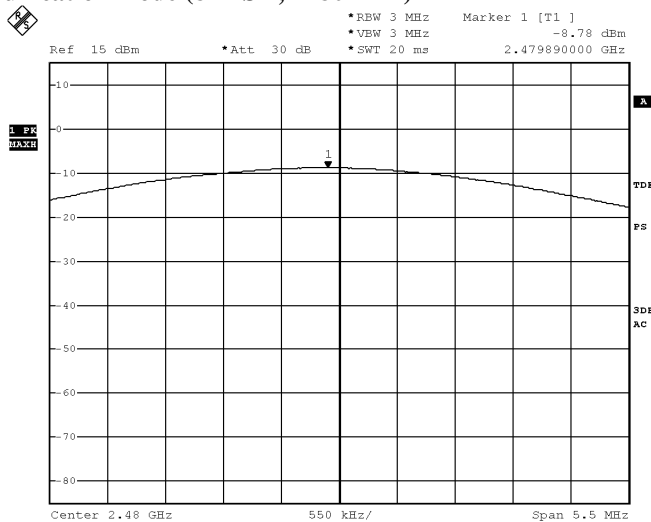

BMP

Date: 20.JUL.2015 14:06:33

### STC (Dongguan) Company Limited

68 Fumin Nan Road, Dalang, Dongguan, China. (Zip Code : 523 770)

Tel : (86 769) 8111 9888 Fax : (86 769) 8111 6222 E-mail : dgstc@dgstc.org Homepage : www.dgstc.org

This report shall not be reproduced unless with prior written approval from STC (Dongguan) Company Limited.  
For Conditions of Issuance of this test report, please refer to the overleaf or Homepage.



## STC Test Report

Date: 2015-08-05

Page 14 of 86

No.: DM120254

### **3.1.2 Radiated Spurious Emissions**

Test Requirement:	FCC 47CFR 15.209
Test Method:	ANSI C63.4:2009
Test Date:	2015-07-20 to 2015-08-04
Mode of Operation:	Tx mode/ Bluetooth mode (GFSK / $\pi/4$ -DQPSK/ 8DPSK)

#### **Test Method:**

The sample was placed 0.8m above the ground plane of semi-anechoic Chamber\*. Measurements in both horizontal and vertical polarities were performed. During the test, each emission was maximized by: having the EUT continuously working, investigated all operating modes, considered typical configuration to obtain worst position, manipulating interconnecting cables, rotating turntable, varying antenna height from 1m to 4m in both horizontal and vertical polarizations. The emissions worst-case are shown in Test Results of the following pages.

- \*: Semi-anechoic chamber located on the STC (Dongguan) Company Ltd. 68 Fumin Nan Road, Dalang, Dongguan, Guangdong, PRC with a metal ground plane filed with the FCC pursuant to section 2.948 of the FCC rules, with Registration Number: 629686.

### **STC (Dongguan) Company Limited**

68 Fumin Nan Road, Dalang, Dongguan, China. (Zip Code : 523 770)

Tel : (86 769) 8111 9888 Fax : (86 769) 8111 6222 E-mail : dgstc@dgstc.org Homepage : www.dgstc.org

This report shall not be reproduced unless with prior written approval from STC (Dongguan) Company Limited.  
For Conditions of Issuance of this test report, please refer to the overleaf or Homepage.



## STC Test Report

Date: 2015-08-05

Page 15 of 86

No.: DM120254

### **Spectrum Analyzer Setting:**

9KHz – 30MHz (Pk & Av)	RBW: 10kHz
	VBW: 30kHz
	Sweep: Auto
	Span: Fully capture the emissions being measured
	Trace: Max. hold
30MHz – 1GHz (QP)	RBW: 120kHz
	VBW: 120kHz
	Sweep: Auto
	Span: Fully capture the emissions being measured
	Trace: Max. hold
Above 1GHz (Pk & Av)	RBW: 1MHz
	VBW: 3MHz
	Sweep: Auto
	Span: Fully capture the emissions being measured
	Trace: Max. hold

### **Test Setup:**

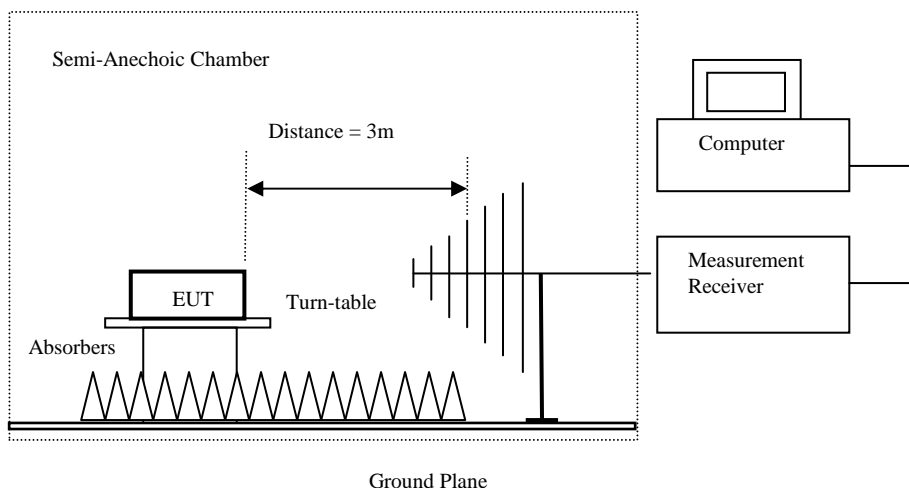

- Absorbers placed on top of the ground plane are for measurements above 1000MHz only.
- Measurements between 30MHz to 1000MHz made with Bi-log antennas, above 1000MHz horn antennas are used, 9kHz to 30MHz loop antennas are used.

### **STC (Dongguan) Company Limited**

68 Fumin Nan Road, Dalang, Dongguan, China. (Zip Code : 523 770)

Tel : (86 769) 8111 9888 Fax : (86 769) 8111 6222 E-mail : dgstc@dgstc.org Homepage : www.dgstc.org

This report shall not be reproduced unless with prior written approval from STC (Dongguan) Company Limited.  
For Conditions of Issuance of this test report, please refer to the overleaf or Homepage.



## STC Test Report

Date: 2015-08-05

Page 16 of 86

No.: DM120254

### Limits for Radiated Emissions [FCC 47 CFR 15.209 Class B]:

Frequency Range [MHz]	Quasi-Peak Limits [ $\mu$ V/m]
0.009-0.490	2400/F (kHz)
0.490-1.705	24000/F (kHz)
1.705-30	30
30-88	100
88-216	150
216-960	200
Above960	500

The emission limits shown in the above table are based on measurement employing a CISPR quasi-peak detector and above 1000MHz are based on measurements employing an average detector.

### Result of Tx mode (2402.0 MHz) (GFSK mode) (9kHz – 30MHz): Pass

Field Strength of Spurious Emissions Peak Value						
Frequency MHz	Measured Level dBuV	Correction Factor dB/m	Field Strength dBuV/m	Field Strength uV/m	Limit uV/m	E-Field Polarity
<b>Emissions detected are more than 20 dB below the FCC Limits</b>						

### Result of Tx mode (2402.0 MHz) (GFSK mode) (30MHz – 1GHz): Pass

Field Strength of Spurious Emissions Quasi-Peak Value						
Frequency MHz	Measured Level dBuV	Correction Factor dB/m	Field Strength dBuV/m	Field Strength uV/m	Limit uV/m	E-Field Polarity
<b>Emissions detected are more than 20 dB below the FCC Limits</b>						

### Result of Tx mode (2402.0 MHz) (GFSK mode) (Above 1GHz): Pass

Field Strength of Spurious Emissions Peak Value						
Frequency MHz	Measured Level @ 3m dB $\mu$ V	Correction Factor dB/m	Field Strength dB $\mu$ V/m	Limit @ 3m dB $\mu$ V/m	Margin dB $\mu$ V/m	E-Field Polarity
4804.0	16.8	41.5	58.3	74.0	15.7	Vertical
4804.0	14.5	42.4	56.9	74.0	17.1	Horizontal
7206.0	10.4	45.1	55.5	74.0	18.5	Vertical
7206.0	7.6	46.2	53.8	74.0	20.3	Horizontal
9608.0	7.1	48.0	55.1	74.0	18.9	Vertical
9608.0	4.1	48.8	52.9	74.0	21.1	Horizontal
12010.0	2.9	51.5	54.4	74.0	19.6	Vertical
12010.0	0.0	52.4	52.4	74.0	21.6	Horizontal

## STC (Dongguan) Company Limited

68 Fumin Nan Road, Dalang, Dongguan, China. (Zip Code : 523 770)

Tel : (86 769) 8111 9888 Fax : (86 769) 8111 6222 E-mail : dgstc@dgstc.org Homepage : www.dgstc.org

This report shall not be reproduced unless with prior written approval from STC (Dongguan) Company Limited.

For Conditions of Issuance of this test report, please refer to the overleaf or Homepage.





## STC Test Report

Date: 2015-08-05

Page 17 of 86

No.: DM120254

**Result of Tx mode (2402.0 MHz) (GFSK mode) (Above 1GHz): Pass**

Field Strength of Spurious Emissions Average Value						
Frequency MHz	Measured Level @3m dBuV	Correction Factor dB/m	Field Strength dBuV/m	Limit @3m dBuV/m	Margin dBuV/m	E-Field Polarity
4804.0	1.7	41.5	43.2	54.0	10.8	Vertical
4804.0	-0.7	42.4	41.7	54.0	12.3	Horizontal
7206.0	-5.0	45.1	40.1	54.0	13.9	Vertical
7206.0	-7.6	46.2	38.6	54.0	15.4	Horizontal
9608.0	-8.1	48.0	39.9	54.0	14.1	Vertical
9608.0	-11.2	48.8	37.6	54.0	16.4	Horizontal
12010.0	-12.4	51.5	39.1	54.0	14.9	Vertical
12010.0	-15.1	52.4	37.3	54.0	16.7	Horizontal

**Result of Tx mode (2441.0 MHz) (GFSK mode) (9kHz – 30MHz): Pass**

Field Strength of Spurious Emissions Peak Value						
Frequency MHz	Measured Level dBuV	Correction Factor dB/m	Field Strength dBuV/m	Field Strength uV/m	Limit uV/m	E-Field Polarity
<b>Emissions detected are more than 20 dB below the FCC Limits</b>						

**Results of Tx mode (2441.0 MHz) (GFSK mode) (30MHz – 1000MHz): PASS**

Field Strength of Spurious Emissions Quasi-Peak Value						
Frequency MHz	Measured Level dBuV	Correction Factor dB/m	Field Strength dBuV/m	Field Strength uV/m	Limit uV/m	E-Field Polarity
<b>Emissions detected are more than 20 dB below the FCC Limits</b>						

### STC (Dongguan) Company Limited

68 Fumin Nan Road, Dalang, Dongguan, China. (Zip Code : 523 770)

Tel : (86 769) 8111 9888 Fax : (86 769) 8111 6222 E-mail : dgstc@dgstc.org Homepage : www.dgstc.org

This report shall not be reproduced unless with prior written approval from STC (Dongguan) Company Limited.

For Conditions of Issuance of this test report, please refer to the overleaf or Homepage.



## STC Test Report

Date: 2015-08-05

Page 18 of 86

No.: DM120254

### Result of Tx mode (2441.0 MHz) (GFSK mode) (Above 1GHz): Pass

Field Strength of Spurious Emissions Peak Value						
Frequency MHz	Measured Level @3m dBuV	Correction Factor dB/m	Field Strength dBuV/m	Limit @3m dBuV/m	Margin dBuV/m	E-Field Polarity
4882.0	16.2	41.6	57.8	74.0	16.2	Vertical
4882.0	13.0	42.5	55.5	74.0	18.5	Horizontal
7323.0	0.7	45.2	45.9	74.0	28.1	Vertical
7323.0	6.2	46.3	52.5	74.0	21.5	Horizontal
9764.0	6.2	48.1	54.3	74.0	19.7	Vertical
9764.0	3.7	48.9	52.6	74.0	21.4	Horizontal
12205.0	2.4	51.6	54.0	74.0	20.0	Vertical
12205.0	-0.1	52.5	52.4	74.0	21.6	Horizontal

### Result of Tx mode (2441.0 MHz) (GFSK mode) (Above 1GHz): Pass

Field Strength of Spurious Emissions Average Value						
Frequency MHz	Measured Level @3m dBuV	Correction Factor dB/m	Field Strength dBuV/m	Limit @3m dBuV/m	Margin dBuV/m	E-Field Polarity
4882.0	1.1	41.6	42.7	54.0	11.3	Vertical
4882.0	-2.2	42.5	40.3	54.0	13.7	Horizontal
7323.0	-6.6	45.2	38.6	54.0	15.4	Vertical
7323.0	-8.9	46.3	37.4	54.0	16.6	Horizontal
9764.0	-8.9	48.1	39.2	54.0	14.8	Vertical
9764.0	-11.5	48.9	37.4	54.0	16.6	Horizontal
12205.0	-12.8	51.6	38.8	54.0	15.2	Vertical
12205.0	-15.2	52.5	37.3	54.0	16.7	Horizontal

### STC (Dongguan) Company Limited

68 Fumin Nan Road, Dalang, Dongguan, China. (Zip Code : 523 770)

Tel : (86 769) 8111 9888 Fax : (86 769) 8111 6222 E-mail : dgstc@dgstc.org Homepage : www.dgstc.org

This report shall not be reproduced unless with prior written approval from STC (Dongguan) Company Limited.  
For Conditions of Issuance of this test report, please refer to the overleaf or Homepage.



## STC Test Report

Date: 2015-08-05

Page 19 of 86

No.: DM120254

**Result of Tx mode (2480.0 MHz) (GFSK mode) (9kHz – 30MHz): Pass**

Field Strength of Spurious Emissions Peak Value						
Frequency MHz	Measured Level dBuV	Correction Factor dB/m	Field Strength dBuV/m	Field Strength uV/m	Limit uV/m	E-Field Polarity
<b>Emissions detected are more than 20 dB below the FCC Limits</b>						

**Results of Tx mode (2480.0 MHz) (GFSK mode) (30MHz – 1000MHz): PASS**

Field Strength of Spurious Emissions Quasi-Peak Value						
Frequency MHz	Measured Level dBuV	Correction Factor dB/m	Field Strength dBuV/m	Field Strength uV/m	Limit uV/m	E-Field Polarity
<b>Emissions detected are more than 20 dB below the FCC Limits</b>						

**Result of Tx mode (2480.0 MHz) (GFSK mode) (Above 1GHz): Pass**

Field Strength of Spurious Emissions Peak Value						
Frequency MHz	Measured Level @3m dBuV	Correction Factor dB/m	Field Strength dBuV/m	Limit @3m dBuV/m	Margin dBuV/m	E-Field Polarity
4960.0	16.3	41.4	57.7	74.0	16.3	Vertical
4960.0	13.0	42.7	55.7	74.0	18.3	Horizontal
7440.0	8.1	45.6	53.7	74.0	20.3	Vertical
7440.0	6.3	46.5	52.8	74.0	21.2	Horizontal
9920.0	5.2	48.6	53.8	74.0	20.2	Vertical
9920.0	2.5	49.7	52.2	74.0	21.8	Horizontal
12400.0	1.7	51.7	53.4	74.0	20.6	Vertical
12400.0	-0.5	52.7	52.2	74.0	21.8	Horizontal

### STC (Dongguan) Company Limited

68 Fumin Nan Road, Dalang, Dongguan, China. (Zip Code : 523 770)

Tel : (86 769) 8111 9888 Fax : (86 769) 8111 6222 E-mail : dgstc@dgstc.org Homepage : www.dgstc.org

This report shall not be reproduced unless with prior written approval from STC (Dongguan) Company Limited.  
For Conditions of Issuance of this test report, please refer to the overleaf or Homepage.



## STC Test Report

Date: 2015-08-05

Page 20 of 86

No.: DM120254

**Result of Tx mode (2480.0 MHz) (GFSK mode) (Above 1GHz): Pass**

Field Strength of Spurious Emissions Average Value						
Frequency MHz	Measured Level @3m dBuV	Correction Factor dB/m	Field Strength dBuV/m	Limit @3m dBuV/m	Margin dBuV/m	E-Field Polarity
4960.0	1.2	41.4	42.6	54.0	11.4	Vertical
4960.0	-2.2	42.7	40.5	54.0	13.5	Horizontal
7440.0	-7.2	45.6	38.4	54.0	15.6	Vertical
7440.0	-8.8	46.5	37.7	54.0	16.3	Horizontal
9920.0	-9.9	48.6	38.7	54.0	15.3	Vertical
9920.0	-12.7	49.7	37.0	54.0	17.0	Horizontal
12400.0	-13.6	51.7	38.1	54.0	15.9	Vertical
12400.0	-15.6	52.7	37.1	54.0	16.9	Horizontal

**Result of Tx mode (2402.0 MHz) ( $\pi/4$ -DQPSK mode) (9kHz – 30MHz): Pass**

Field Strength of Spurious Emissions Peak Value						
Frequency MHz	Measured Level dBuV	Correction Factor dB/m	Field Strength dBuV/m	Field Strength uV/m	Limit uV/m	E-Field Polarity
<b>Emissions detected are more than 20 dB below the FCC Limits</b>						

**Result of Tx mode (2402.0 MHz) ( $\pi/4$ -DQPSK mode) (30MHz – 1GHz): Pass**

Field Strength of Spurious Emissions Quasi-Peak Value						
Frequency MHz	Measured Level dBuV	Correction Factor dB/m	Field Strength dBuV/m	Field Strength uV/m	Limit uV/m	E-Field Polarity
<b>Emissions detected are more than 20 dB below the FCC Limits</b>						

### STC (Dongguan) Company Limited

68 Fumin Nan Road, Dalang, Dongguan, China. (Zip Code : 523 770)

Tel : (86 769) 8111 9888 Fax : (86 769) 8111 6222 E-mail : dgstc@dgstc.org Homepage : www.dgstc.org

This report shall not be reproduced unless with prior written approval from STC (Dongguan) Company Limited.

For Conditions of Issuance of this test report, please refer to the overleaf or Homepage.



## STC Test Report

Date: 2015-08-05

Page 21 of 86

No.: DM120254

Result of Tx mode (2402.0 MHz) ( $\pi/4$ -DQPSK mode) (Above 1GHz): Pass

Field Strength of Spurious Emissions Peak Value						
Frequency MHz	Measured Level @3m dBuV	Correction Factor dB/m	Field Strength dBuV/m	Limit @3m dBuV/m	Margin dBuV/m	E-Field Polarity
4804.0	16.1	41.5	57.6	74.0	16.4	Vertical
4804.0	13.8	42.4	56.2	74.0	17.8	Horizontal
7206.0	9.7	45.1	54.8	74.0	19.2	Vertical
7206.0	7.4	46.2	53.6	74.0	20.4	Horizontal
9608.0	6.9	48.0	54.9	74.0	19.1	Vertical
9608.0	4.7	48.8	53.5	74.0	20.5	Horizontal
12010.0	2.1	51.5	53.6	74.0	20.4	Vertical
12010.0	0.3	52.4	52.7	74.0	21.3	Horizontal

Result of Tx mode (2402.0 MHz) ( $\pi/4$ -DQPSK mode) (Above 1GHz): Pass

Field Strength of Spurious Emissions Average Value						
Frequency MHz	Measured Level @3m dBuV	Correction Factor dB/m	Field Strength dBuV/m	Limit @3m dBuV/m	Margin dBuV/m	E-Field Polarity
4804.0	1.0	41.5	42.5	54.0	11.5	Vertical
4804.0	-1.4	42.4	41.0	54.0	13.0	Horizontal
7206.0	-5.7	45.1	39.4	54.0	14.6	Vertical
7206.0	-7.7	46.2	38.5	54.0	15.5	Horizontal
9608.0	-8.3	48.0	39.7	54.0	14.3	Vertical
9608.0	-10.6	48.8	38.2	54.0	15.8	Horizontal
12010.0	-13.2	51.5	38.3	54.0	15.7	Vertical
12010.0	-14.8	52.4	37.6	54.0	16.4	Horizontal

### STC (Dongguan) Company Limited

68 Fumin Nan Road, Dalang, Dongguan, China. (Zip Code : 523 770)

Tel : (86 769) 8111 9888 Fax : (86 769) 8111 6222 E-mail : dgstc@dgstc.org Homepage : www.dgstc.org

This report shall not be reproduced unless with prior written approval from STC (Dongguan) Company Limited.

For Conditions of Issuance of this test report, please refer to the overleaf or Homepage.



## STC Test Report

Date: 2015-08-05

Page 22 of 86

No.: DM120254

**Result of Tx mode (2441.0 MHz) ( $\pi/4$ -DQPSK mode) (9kHz – 30MHz): Pass**

Field Strength of Spurious Emissions Peak Value						
Frequency MHz	Measured Level dBuV	Correction Factor dB/m	Field Strength dBuV/m	Field Strength uV/m	Limit uV/m	E-Field Polarity
<b>Emissions detected are more than 20 dB below the FCC Limits</b>						

**Results of Tx mode (2441.0 MHz) ( $\pi/4$ -DQPSK mode) (30MHz – 1000MHz): PASS**

Field Strength of Spurious Emissions Quasi-Peak Value						
Frequency MHz	Measured Level dBuV	Correction Factor dB/m	Field Strength dBuV/m	Field Strength uV/m	Limit uV/m	E-Field Polarity
<b>Emissions detected are more than 20 dB below the FCC Limits</b>						

**Result of Tx mode (2441.0 MHz) ( $\pi/4$ -DQPSK mode) (Above 1GHz): Pass**

Field Strength of Spurious Emissions Peak Value						
Frequency MHz	Measured Level @3m dBuV	Correction Factor dB/m	Field Strength dBuV/m	Limit @3m dBuV/m	Margin dBuV/m	E-Field Polarity
4882.0	15.8	41.6	57.4	74.0	16.6	Vertical
4882.0	13.7	42.5	56.2	74.0	17.8	Horizontal
7323.0	1.4	45.2	46.6	74.0	27.4	Vertical
7323.0	6.7	46.3	53.0	74.0	21.0	Horizontal
9764.0	6.0	48.1	54.1	74.0	19.9	Vertical
9764.0	4.4	48.9	53.3	74.0	20.7	Horizontal
12205.0	2.1	51.6	53.7	74.0	20.3	Vertical
12205.0	0.3	52.5	52.8	74.0	21.2	Horizontal

### STC (Dongguan) Company Limited

68 Fumin Nan Road, Dalang, Dongguan, China. (Zip Code : 523 770)

Tel : (86 769) 8111 9888 Fax : (86 769) 8111 6222 E-mail : dgstc@dgstc.org Homepage : www.dgstc.org

This report shall not be reproduced unless with prior written approval from STC (Dongguan) Company Limited.  
For Conditions of Issuance of this test report, please refer to the overleaf or Homepage.



## STC Test Report

Date: 2015-08-05

Page 23 of 86

No.: DM120254

### Result of Tx mode (2441.0 MHz) ( $\pi/4$ -DQPSK mode) (Above 1GHz): Pass

Field Strength of Spurious Emissions Average Value						
Frequency MHz	Measured Level @3m dBuV	Correction Factor dB/m	Field Strength dBuV/m	Limit @3m dBuV/m	Margin dBuV/m	E-Field Polarity
4882.0	0.6	41.6	42.2	54.0	11.8	Vertical
4882.0	-1.5	42.5	41.0	54.0	13.0	Horizontal
7323.0	-6.0	45.2	39.2	54.0	14.8	Vertical
7323.0	-8.4	46.3	37.9	54.0	16.1	Horizontal
9764.0	-9.1	48.1	39.0	54.0	15.0	Vertical
9764.0	-10.8	48.9	38.1	54.0	15.9	Horizontal
12205.0	-13.1	51.6	38.5	54.0	15.5	Vertical
12205.0	-14.8	52.5	37.7	54.0	16.3	Horizontal

### Result of Tx mode (2480.0 MHz) ( $\pi/4$ -DQPSK mode) (9kHz – 30MHz): Pass

Field Strength of Spurious Emissions Peak Value						
Frequency MHz	Measured Level dBuV	Correction Factor dB/m	Field Strength dBuV/m	Field Strength uV/m	Limit uV/m	E-Field Polarity
<b>Emissions detected are more than 20 dB below the FCC Limits</b>						

### Results of Tx mode (2480.0 MHz) ( $\pi/4$ -DQPSK mode) (30MHz – 1000MHz): PASS

Field Strength of Spurious Emissions Quasi-Peak Value						
Frequency MHz	Measured Level dBuV	Correction Factor dB/m	Field Strength dBuV/m	Field Strength uV/m	Limit uV/m	E-Field Polarity
<b>Emissions detected are more than 20 dB below the FCC Limits</b>						

## STC (Dongguan) Company Limited

68 Fumin Nan Road, Dalang, Dongguan, China. (Zip Code : 523 770)

Tel : (86 769) 8111 9888 Fax : (86 769) 8111 6222 E-mail : dgstc@dgstc.org Homepage : www.dgstc.org

This report shall not be reproduced unless with prior written approval from STC (Dongguan) Company Limited.  
For Conditions of Issuance of this test report, please refer to the overleaf or Homepage.



## STC Test Report

Date: 2015-08-05

Page 24 of 86

No.: DM120254

**Result of Tx mode (2480.0 MHz) ( $\pi/4$ -DQPSK mode) (Above 1GHz): Pass**

Field Strength of Spurious Emissions Peak Value						
Frequency MHz	Measured Level @3m dBuV	Correction Factor dB/m	Field Strength dBuV/m	Limit @3m dBuV/m	Margin dBuV/m	E-Field Polarity
4960.0	15.8	41.4	57.2	74.0	16.8	Vertical
4960.0	13.1	42.7	55.8	74.0	18.2	Horizontal
7440.0	9.0	45.6	54.6	74.0	19.4	Vertical
7440.0	7.4	46.5	53.9	74.0	20.1	Horizontal
9920.0	5.6	48.6	54.2	74.0	19.8	Vertical
9920.0	3.8	49.7	53.5	74.0	20.5	Horizontal
12400.0	3.0	51.7	54.7	74.0	19.3	Vertical
12400.0	0.4	52.7	53.1	74.0	20.9	Horizontal

**Result of Tx mode (2480.0 MHz) ( $\pi/4$ -DQPSK mode) (Above 1GHz): Pass**

Field Strength of Spurious Emissions Average Value						
Frequency MHz	Measured Level @3m dBuV	Correction Factor dB/m	Field Strength dBuV/m	Limit @3m dBuV/m	Margin dBuV/m	E-Field Polarity
4960.0	0.7	41.4	42.1	54.0	11.9	Vertical
4960.0	-2.1	42.7	40.6	54.0	13.4	Horizontal
7440.0	-6.3	45.6	39.3	54.0	14.7	Vertical
7440.0	-7.7	46.5	38.8	54.0	15.2	Horizontal
9920.0	-9.5	48.6	39.1	54.0	14.9	Vertical
9920.0	-11.5	49.7	38.2	54.0	15.8	Horizontal
12400.0	-12.3	51.7	39.4	54.0	14.6	Vertical
12400.0	-14.8	52.7	37.9	54.0	16.1	Horizontal

### STC (Dongguan) Company Limited

68 Fumin Nan Road, Dalang, Dongguan, China. (Zip Code : 523 770)

Tel : (86 769) 8111 9888 Fax : (86 769) 8111 6222 E-mail : dgstc@dgstc.org Homepage : www.dgstc.org

This report shall not be reproduced unless with prior written approval from STC (Dongguan) Company Limited.

For Conditions of Issuance of this test report, please refer to the overleaf or Homepage.





## STC Test Report

Date: 2015-08-05

Page 25 of 86

No.: DM120254

### Result of Tx mode (2402.0 MHz) (8DPSK) (9kHz – 30MHz): Pass

Field Strength of Spurious Emissions Peak Value						
Frequency MHz	Measured Level dBuV	Correction Factor dB/m	Field Strength dBuV/m	Field Strength uV/m	Limit uV/m	E-Field Polarity
Emissions detected are more than 20 dB below the FCC Limits						

### Result of Tx mode (2402.0 MHz) (8DPSK) (30MHz – 1GHz): Pass

Field Strength of Spurious Emissions Quasi-Peak Value						
Frequency MHz	Measured Level dBuV	Correction Factor dB/m	Field Strength dBuV/m	Field Strength uV/m	Limit uV/m	E-Field Polarity
Emissions detected are more than 20 dB below the FCC Limits						

### Result of Tx mode (2402.0 MHz) (8DPSK) (Above 1GHz): Pass

Field Strength of Spurious Emissions Peak Value						
Frequency MHz	Measured Level @3m dBuV	Correction Factor dB/m	Field Strength dBuV/m	Limit @3m dBuV/m	Margin dBuV/m	E-Field Polarity
4804.0	16.4	41.5	57.9	74.0	16.1	Vertical
4804.0	13.5	42.4	55.9	74.0	18.1	Horizontal
7206.0	10.2	45.1	55.3	74.0	18.7	Vertical
7206.0	8.5	46.2	54.7	74.0	19.3	Horizontal
9608.0	6.4	48.0	54.4	74.0	19.6	Vertical
9608.0	3.9	48.8	52.7	74.0	21.3	Horizontal
12010.0	2.3	51.8	54.1	74.0	19.9	Vertical
12010.0	0.3	52.4	52.7	74.0	21.3	Horizontal

### STC (Dongguan) Company Limited

68 Fumin Nan Road, Dalang, Dongguan, China. (Zip Code : 523 770)

Tel : (86 769) 8111 9888 Fax : (86 769) 8111 6222 E-mail : dgstc@dgstc.org Homepage : www.dgstc.org

This report shall not be reproduced unless with prior written approval from STC (Dongguan) Company Limited.

For Conditions of Issuance of this test report, please refer to the overleaf or Homepage.



## STC Test Report

Date: 2015-08-05

Page 26 of 86

No.: DM120254

**Result of Tx mode (2402.0 MHz) (8DPSK) (Above 1GHz): Pass**

Field Strength of Spurious Emissions Average Value						
Frequency MHz	Measured Level @3m dBuV	Correction Factor dB/m	Field Strength dBuV/m	Limit @3m dBuV/m	Margin dBuV/m	E-Field Polarity
4804.0	1.2	41.5	42.7	54.0	11.3	Vertical
4804.0	-1.7	42.4	40.7	54.0	13.3	Horizontal
7206.0	-5.1	45.1	40.0	54.0	14.0	Vertical
7206.0	-6.7	46.2	39.5	54.0	14.5	Horizontal
9608.0	-8.7	48.0	39.3	54.0	14.7	Vertical
9608.0	-11.3	48.8	37.5	54.0	16.5	Horizontal
12010.0	-13.1	51.8	38.7	54.0	15.3	Vertical
12010.0	-14.8	52.4	37.6	54.0	16.4	Horizontal

**Result of Tx mode (2441.0 MHz) (8DPSK) (9kHz – 30MHz): Pass**

Field Strength of Spurious Emissions Peak Value						
Frequency MHz	Measured Level dBuV	Correction Factor dB/m	Field Strength dBuV/m	Field Strength uV/m	Limit uV/m	E-Field Polarity
<b>Emissions detected are more than 20 dB below the FCC Limits</b>						

**Results of Tx mode (2441.0 MHz) (8DPSK) (30MHz – 1000MHz): PASS**

Field Strength of Spurious Emissions Quasi-Peak Value						
Frequency MHz	Measured Level dBuV	Correction Factor dB/m	Field Strength dBuV/m	Field Strength uV/m	Limit uV/m	E-Field Polarity
<b>Emissions detected are more than 20 dB below the FCC Limits</b>						

### STC (Dongguan) Company Limited

68 Fumin Nan Road, Dalang, Dongguan, China. (Zip Code : 523 770)

Tel : (86 769) 8111 9888 Fax : (86 769) 8111 6222 E-mail : dgstc@dgstc.org Homepage : www.dgstc.org

This report shall not be reproduced unless with prior written approval from STC (Dongguan) Company Limited.  
For Conditions of Issuance of this test report, please refer to the overleaf or Homepage.



## STC Test Report

Date: 2015-08-05

Page 27 of 86

No.: DM120254

### Result of Tx mode (2441.0 MHz) (8DPSK) (Above 1GHz): Pass

Field Strength of Spurious Emissions Peak Value						
Frequency MHz	Measured Level @3m dBuV	Correction Factor dB/m	Field Strength dBuV/m	Limit @3m dBuV/m	Margin dBuV/m	E-Field Polarity
4882.0	15.4	41.6	57.0	74.0	17.0	Vertical
4882.0	13.8	42.5	56.3	74.0	17.7	Horizontal
7323.0	1.5	45.2	46.7	74.0	27.3	Vertical
7323.0	6.3	46.3	52.6	74.0	21.4	Horizontal
9764.0	6.1	48.1	54.2	74.0	19.8	Vertical
9764.0	4	48.9	52.9	74.0	21.1	Horizontal
12205.0	2.4	51.6	54.0	74.0	20.0	Vertical
12205.0	0	52.5	52.5	74.0	21.5	Horizontal

### Result of Tx mode (2441.0 MHz) (8DPSK) (Above 1GHz): Pass

Field Strength of Spurious Emissions Average Value						
Frequency MHz	Measured Level @3m dBuV	Correction Factor dB/m	Field Strength dBuV/m	Limit @3m dBuV/m	Margin dBuV/m	E-Field Polarity
4882.0	0.3	41.6	41.9	54.0	12.1	Vertical
4882.0	-1.4	42.5	41.1	54.0	12.9	Horizontal
7323.0	-5.8	45.2	39.4	54.0	14.6	Vertical
7323.0	-8.8	46.3	37.5	54.0	16.5	Horizontal
9764.0	-9.0	48.1	39.1	54.0	14.9	Vertical
9764.0	-11.2	48.9	37.7	54.0	16.3	Horizontal
12205.0	-12.7	51.6	38.9	54.0	15.1	Vertical
12205.0	-15.1	52.5	37.4	54.0	16.6	Horizontal

### STC (Dongguan) Company Limited

68 Fumin Nan Road, Dalang, Dongguan, China. (Zip Code : 523 770)

Tel : (86 769) 8111 9888 Fax : (86 769) 8111 6222 E-mail : dgstc@dgstc.org Homepage : www.dgstc.org

This report shall not be reproduced unless with prior written approval from STC (Dongguan) Company Limited.

For Conditions of Issuance of this test report, please refer to the overleaf or Homepage.



## STC Test Report

Date: 2015-08-05

Page 28 of 86

No.: DM120254

**Result of Tx mode (2480.0 MHz) (8DPSK) (9kHz – 30MHz): Pass**

Field Strength of Spurious Emissions Peak Value						
Frequency MHz	Measured Level dBuV	Correction Factor dB/m	Field Strength dBuV/m	Field Strength uV/m	Limit uV/m	E-Field Polarity
<b>Emissions detected are more than 20 dB below the FCC Limits</b>						

**Results of Tx mode (2480.0 MHz) (8DPSK) (30MHz – 1000MHz): PASS**

Field Strength of Spurious Emissions Quasi-Peak Value						
Frequency MHz	Measured Level dBuV	Correction Factor dB/m	Field Strength dBuV/m	Field Strength uV/m	Limit uV/m	E-Field Polarity
<b>Emissions detected are more than 20 dB below the FCC Limits</b>						

**Result of Tx mode (2480.0 MHz) (8DPSK) (Above 1GHz): Pass**

Field Strength of Spurious Emissions Peak Value						
Frequency MHz	Measured Level @3m dBuV	Correction Factor dB/m	Field Strength dBuV/m	Limit @3m dBuV/m	Margin dBuV/m	E-Field Polarity
4960.0	16.0	41.4	57.4	74.0	16.6	Vertical
4960.0	13.4	42.7	56.1	74.0	17.9	Horizontal
7440.0	9.1	45.6	54.7	74.0	19.3	Vertical
7440.0	6.4	46.5	52.9	74.0	21.1	Horizontal
9920.0	6.4	48.6	55.0	74.0	19.0	Vertical
9920.0	4.1	49.7	53.8	74.0	20.2	Horizontal
12400.0	2.6	51.7	54.3	74.0	19.7	Vertical
12400.0	-0.3	52.7	52.4	74.0	21.6	Horizontal

### STC (Dongguan) Company Limited

68 Fumin Nan Road, Dalang, Dongguan, China. (Zip Code : 523 770)

Tel : (86 769) 8111 9888 Fax : (86 769) 8111 6222 E-mail : dgstc@dgstc.org Homepage : www.dgstc.org

This report shall not be reproduced unless with prior written approval from STC (Dongguan) Company Limited.  
For Conditions of Issuance of this test report, please refer to the overleaf or Homepage.



## STC Test Report

Date: 2015-08-05

Page 29 of 86

No.: DM120254

**Result of Tx mode (2480.0 MHz) (8DPSK) (Above 1GHz): Pass**

Field Strength of Spurious Emissions Average Value						
Frequency MHz	Measured Level @3m dBuV	Correction Factor dB/m	Field Strength dBuV/m	Limit @3m dBuV/m	Margin dBuV/m	E-Field Polarity
4960.0	0.9	41.4	42.3	54.0	11.7	Vertical
4960.0	-1.8	42.7	40.9	54.0	13.1	Horizontal
7440.0	-6.2	45.6	39.4	54.0	14.6	Vertical
7440.0	-8.8	46.5	37.7	54.0	16.3	Horizontal
9920.0	-8.7	48.6	39.9	54.0	14.1	Vertical
9920.0	-11.1	49.7	38.6	54.0	15.4	Horizontal
12400.0	-12.7	51.7	39.0	54.0	15.0	Vertical
12400.0	-15.4	52.7	37.3	54.0	16.7	Horizontal

Remarks:

\* Denotes restricted band of operation.

Measurements were made using a peak detector. Any emission less than 1000MHz and falling within the restricted bands of FCC Rules Part 15 Section 15.205 and the limits of FCC Rules Part 15 Section 15.209 were applied.

Correction Factor included Antenna Factor and Cable Attenuation.

Calculated measurement uncertainty: (9kHz - 30MHz): 3.3dB  
(30MHz - 1GHz): 4.6dB  
(1GHz - 26GHz): 4.4dB

Emissions in the vertical and horizontal polarizations have been investigated and the worst-case test results are recorded in this report.

### STC (Dongguan) Company Limited

68 Fumin Nan Road, Dalang, Dongguan, China. (Zip Code : 523 770)

Tel : (86 769) 8111 9888 Fax : (86 769) 8111 6222 E-mail : dgstc@dgstc.org Homepage : www.dgstc.org

This report shall not be reproduced unless with prior written approval from STC (Dongguan) Company Limited.  
For Conditions of Issuance of this test report, please refer to the overleaf or Homepage.



## STC Test Report

Date: 2015-08-05

Page 30 of 86

No.: DM120254

### Limits for Radiated Emissions [FCC 47 CFR 15.209 Class B]:

Frequency Range [MHz]	Quasi-Peak Limits [ $\mu\text{V}/\text{m}$ ]
0.009-0.490	2400/F (kHz)
0.490-1.705	24000/F (kHz)
1.705-30	30
30-88	100
88-216	150
216-960	200
Above960	500

The emission limits shown in the above table are based on measurement employing a CISPR quasi-peak detector and above 1000MHz are based on measurements employing an average detector.

### Result of Bluetooth play mode (GFSK / $\pi/4$ -DQPSK/ 8DPSK) (30MHz – 1GHz): Pass

Please refer to the following table for result details

#### Horizontal

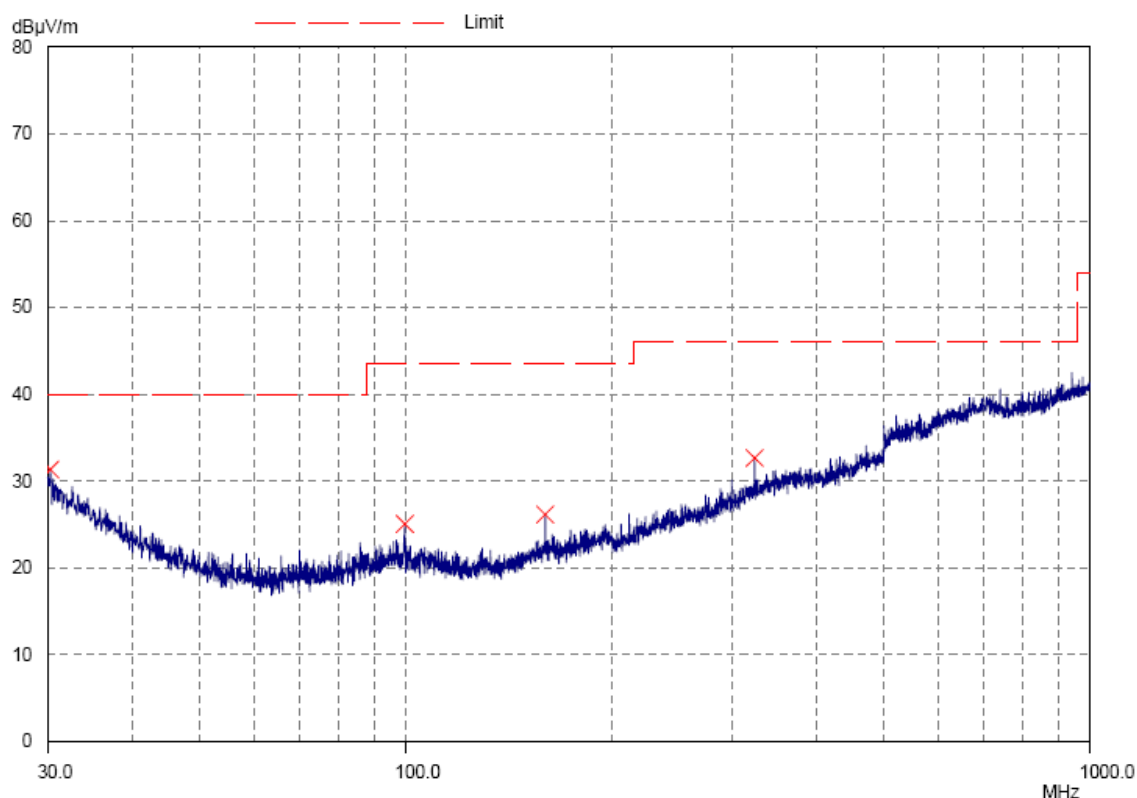

### STC (Dongguan) Company Limited

68 Fumin Nan Road, Dalang, Dongguan, China. (Zip Code : 523 770)

Tel : (86 769) 8111 9888 Fax : (86 769) 8111 6222 E-mail : dgstc@dgstc.org Homepage : www.dgstc.org

This report shall not be reproduced unless with prior written approval from STC (Dongguan) Company Limited.  
For Conditions of Issuance of this test report, please refer to the overleaf or Homepage.



## STC Test Report

Date: 2015-08-05

Page 31 of 86

No.: DM120254

### **Result of Bluetooth play mode (GFSK / $\pi/4$ -DQPSK/ 8DPSK) (30MHz – 1GHz): Pass**

<b>Radiated Emissions Quasi-Peak</b>					
Emission Frequency MHz	E-Field Polarity	Level @3m dB $\mu$ V/m	Limit @3m dB $\mu$ V/m	Level @3m $\mu$ V/m	Limit @3m $\mu$ V/m
30.3	Horizontal	31.3	40.0	36.7	100
99.9	Horizontal	25.1	43.5	18.0	150
160.1	Horizontal	26.2	43.5	20.4	150
324.0	Horizontal	32.7	46.0	43.2	200

### **STC (Dongguan) Company Limited**

68 Fumin Nan Road, Dalang, Dongguan, China. (Zip Code : 523 770)

Tel : (86 769) 8111 9888 Fax : (86 769) 8111 6222 E-mail : dgstc@dgstc.org Homepage : www.dgstc.org

This report shall not be reproduced unless with prior written approval from STC (Dongguan) Company Limited.  
For Conditions of Issuance of this test report, please refer to the overleaf or Homepage.



## STC Test Report

Date: 2015-08-05

Page 32 of 86

No.: DM120254

### Limits for Radiated Emissions [FCC 47 CFR 15.209 Class B]:

Frequency Range [MHz]	Quasi-Peak Limits [ $\mu\text{V}/\text{m}$ ]
0.009-0.490	2400/F (kHz)
0.490-1.705	24000/F (kHz)
1.705-30	30
30-88	100
88-216	150
216-960	200
Above960	500

The emission limits shown in the above table are based on measurement employing a CISPR quasi-peak detector and above 1000MHz are based on measurements employing an average detector.

### Result of Bluetooth play mode (GFSK / $\pi/4$ -DQPSK/ 8DPSK) (30MHz – 1GHz): Pass

Please refer to the following table for result details

Vertical

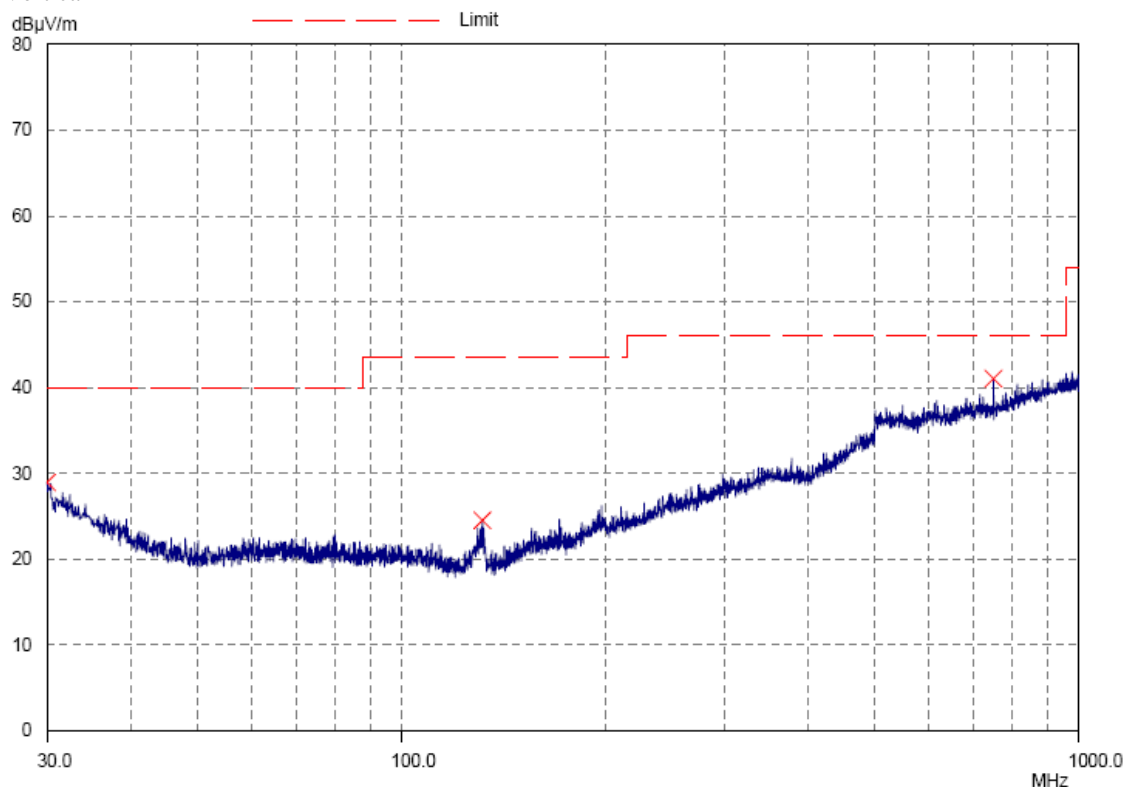

### STC (Dongguan) Company Limited

68 Fumin Nan Road, Dalang, Dongguan, China. (Zip Code : 523 770)

Tel : (86 769) 8111 9888 Fax : (86 769) 8111 6222 E-mail : dgstc@dgstc.org Homepage : www.dgstc.org

This report shall not be reproduced unless with prior written approval from STC (Dongguan) Company Limited.  
For Conditions of Issuance of this test report, please refer to the overleaf or Homepage.





## STC Test Report

Date: 2015-08-05

Page 33 of 86

No.: DM120254

**Result of Bluetooth play mode (GFSK /  $\pi/4$ -DQPSK/ 8DPSK) (30MHz – 1GHz): Pass**

<b>Radiated Emissions Quasi-Peak</b>					
Emission Frequency MHz	E-Field Polarity	Level @3m dB $\mu$ V/m	Limit @3m dB $\mu$ V/m	Level @3m $\mu$ V/m	Limit @3m $\mu$ V/m
30.0	Vertical	29.0	40.0	28.2	100
131.8	Vertical	24.6	43.5	17.0	150
749.8	Vertical	40.1	46.0	101.2	200

**Remarks:**

Calculated measurement uncertainty (30MHz – 1GHz): 4.6dB

Emissions in the vertical and horizontal polarizations have been investigated and the worst-case test results are recorded in this report.

### **STC (Dongguan) Company Limited**

68 Fumin Nan Road, Dalang, Dongguan, China. (Zip Code : 523 770)

Tel : (86 769) 8111 9888 Fax : (86 769) 8111 6222 E-mail : dgstc@dgstc.org Homepage : www.dgstc.org

This report shall not be reproduced unless with prior written approval from STC (Dongguan) Company Limited.

For Conditions of Issuance of this test report, please refer to the overleaf or Homepage.



## STC Test Report

Date: 2015-08-05

Page 34 of 86

No.: DM120254

### 3.1.3 AC Mains Conducted Emissions (0.15MHz to 30MHz)

Test Requirement:	FCC 47CFR 15.207
Test Method:	ANSI C63.4:2009
Test Date:	2015-07-20
Mode of Operation:	Bluetooth play mode
Test Voltage:	120Va.c. 60Hz

#### Test Method:

The test was performed in accordance with ANSI C63.4: 2009, with the following: an initial measurement was performed in peak and average detection mode on the live line, any emissions recorded within 30dB of the relevant limit line were re-measured using quasi-peak and average detection on the live and neutral lines with the worst case recorded in the table of results.

#### Test Setup:

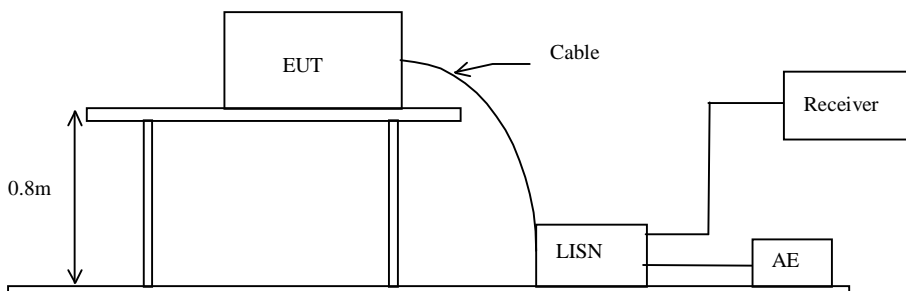

### STC (Dongguan) Company Limited

68 Fumin Nan Road, Dalang, Dongguan, China. (Zip Code : 523 770)

Tel : (86 769) 8111 9888 Fax : (86 769) 8111 6222 E-mail : dgstc@dgstc.org Homepage : www.dgstc.org

This report shall not be reproduced unless with prior written approval from STC (Dongguan) Company Limited.  
For Conditions of Issuance of this test report, please refer to the overleaf or Homepage.



## STC Test Report

Date: 2015-08-05

Page 35 of 86

No.: DM120254

**Limit for Conducted Emissions (FCC 47 CFR 15.207):**

Frequency Range [MHz]	Quasi-Peak Limits [dBμV]	Average [dBμV]
0.15-0.5	66 to 56*	56 to 46*
0.5-5.0	56	46
5.0-30.0	60	50

\* Decreases with the logarithm of the frequency.

Limits for Conducted Emissions Test, please refer to limit lines (Quasi-Peak and Average) in the following diagram.

**Result of Bluetooth play mode(Charging, Connect to PC) (L): PASS**

Please refer to the following diagram for individual results.

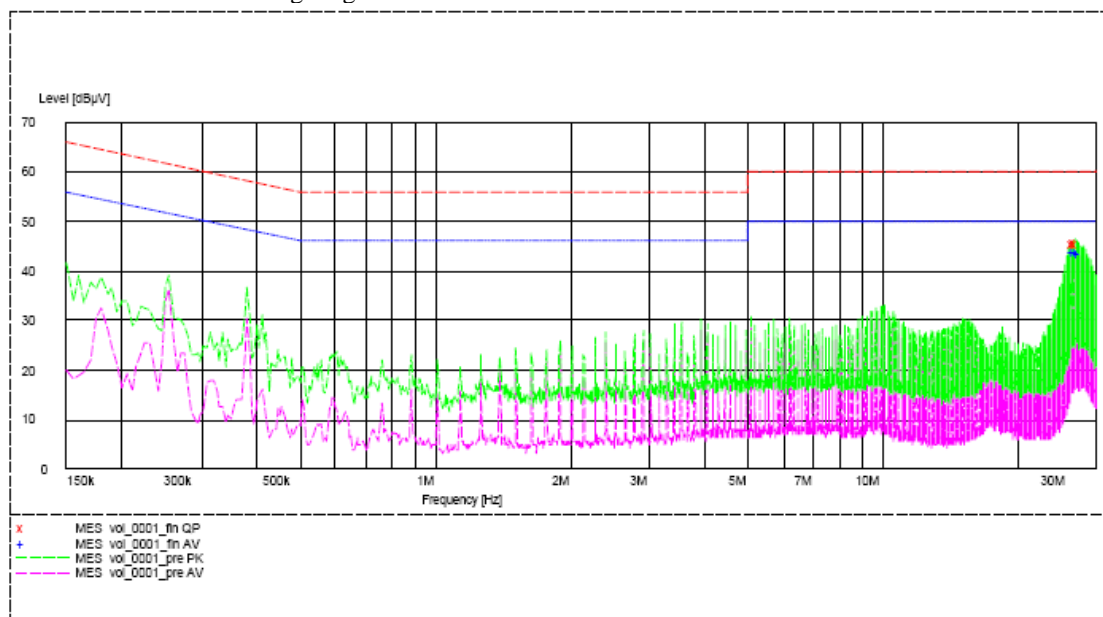

Conductor Live or Neutral	Frequency MHz	Quasi-peak		Average	
		Level dBμV	Limit dBμV	Level dBμV	Limit dBμV
Live	26.720	45.5	60.0	-*-	-*-
Live	26.975	45.6	60.0	-*-	-*-
Live	27.100	45.4	60.0	-*-	-*-
Live	26.720	-*-	-*-	44.1	50.0
Live	27.100	-*-	-*-	44.1	50.0
Live	27.480	-*-	-*-	43.8	50.0

### STC (Dongguan) Company Limited

68 Fumin Nan Road, Dalang, Dongguan, China. (Zip Code : 523 770)

Tel : (86 769) 8111 9888 Fax : (86 769) 8111 6222 E-mail : dgstc@dgstc.org Homepage : www.dgstc.org

This report shall not be reproduced unless with prior written approval from STC (Dongguan) Company Limited.

For Conditions of Issuance of this test report, please refer to the overleaf or Homepage.



## STC Test Report

Date: 2015-08-05

Page 36 of 86

No.: DM120254

**Limit for Conducted Emissions (FCC 47 CFR 15.207):**

Frequency Range [MHz]	Quasi-Peak Limits [dBμV]	Average [dBμV]
0.15-0.5	66 to 56*	56 to 46*
0.5-5.0	56	46
5.0-30.0	60	50

\* Decreases with the logarithm of the frequency.

Limits for Conducted Emissions Test, please refer to limit lines (Quasi-Peak and Average) in the following diagram.

**Result of Bluetooth play mode(Charging, Connect to PC) (N): PASS**

Please refer to the following diagram for individual results.

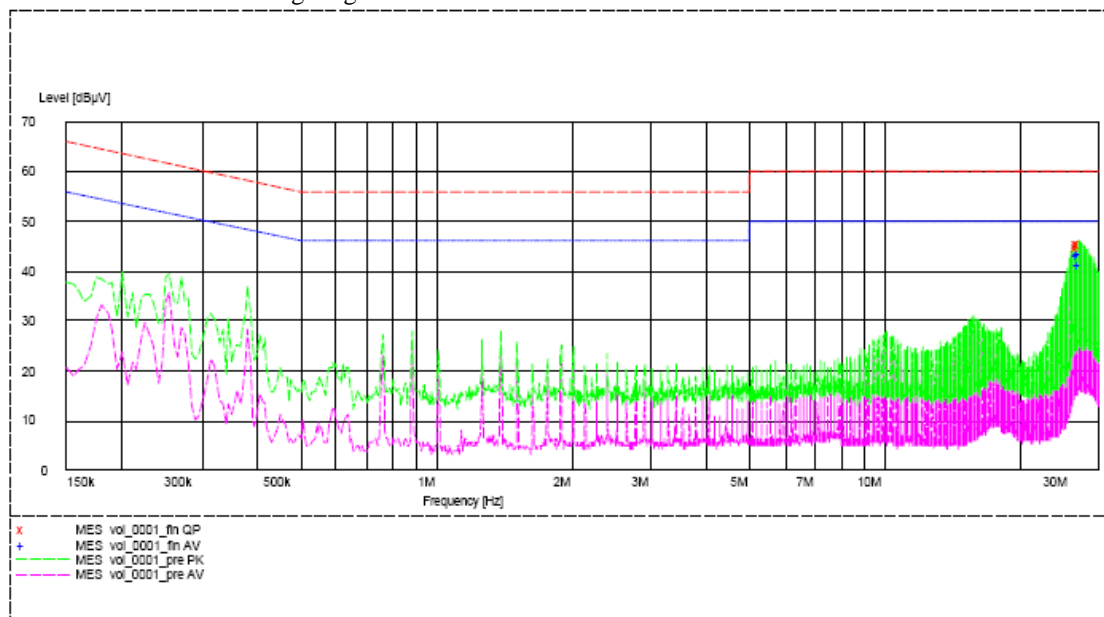

Conductor Live or Neutral	Frequency MHz	Quasi-peak		Average	
		Level dBμV	Limit dBμV	Level dBμV	Limit dBμV
Neutral	26.835	45.3	60.0	-*-	-*-
Neutral	26.960	44.7	60.0	-*-	-*-
Neutral	27.090	45.3	60.0	-*-	-*-
Neutral	26.835	-*-	-*-	43.2	50.0
Neutral	27.215	-*-	-*-	43.5	50.0
Neutral	27.340	-*-	-*-	41.3	50.0

Remarks:

Calculated measurement uncertainty (0.15MHz – 30MHz): 3.2dB

-\*- Emission(s) that is far below the corresponding limit line.

### STC (Dongguan) Company Limited

68 Fumin Nan Road, Dalang, Dongguan, China. (Zip Code : 523 770)

Tel : (86 769) 8111 9888 Fax : (86 769) 8111 6222 E-mail : dgstc@dgstc.org Homepage : www.dgstc.org

This report shall not be reproduced unless with prior written approval from STC (Dongguan) Company Limited.

For Conditions of Issuance of this test report, please refer to the overleaf or Homepage.



## STC Test Report

Date: 2015-08-05

Page 37 of 86

No.: DM120254

### 3.1.4 Number of Hopping Frequency

#### Limit of Number of Hopping Frequency

Frequency hopping systems in the 2400–2483.5 MHz band shall use at least 15 channels

#### Test Method:

The RF output of the EUT was connected to the spectrum analyzer by a low loss cable.

#### Spectrum Analyzer Setting:

RBW = 1MHz, VBW  $\geq$  RBW, Sweep = Auto, Span = the frequency band of operation

Detector = Peak, Trace = Max. hold

#### Test Setup:

As Test Setup of clause 3.1.1 in this test report.

#### Measurement Data:

##### GFSK: 79 of 79 Channel

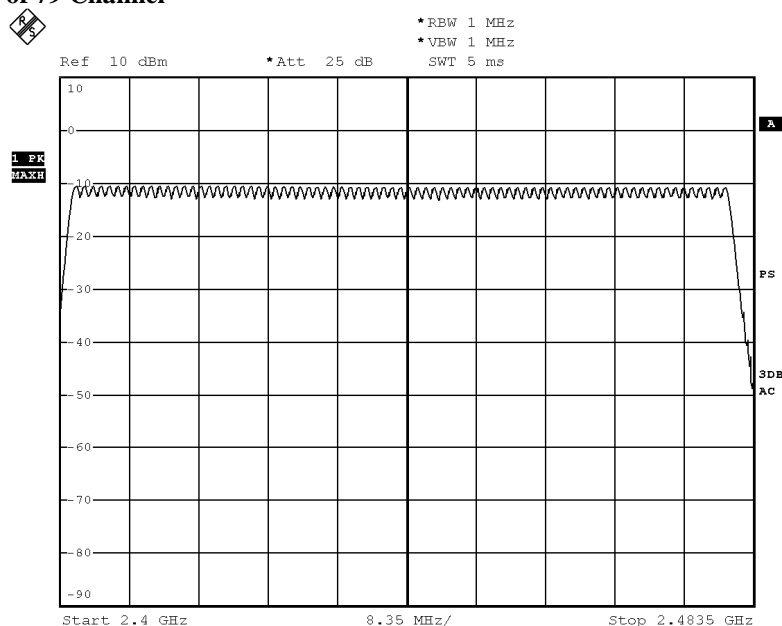

BMP

Date: 18.JUL.2015 13:33:54

### STC (Dongguan) Company Limited

68 Fumin Nan Road, Dalang, Dongguan, China. (Zip Code : 523 770)

Tel : (86 769) 8111 9888 Fax : (86 769) 8111 6222 E-mail : dgstc@dgstc.org Homepage : www.dgstc.org

This report shall not be reproduced unless with prior written approval from STC (Dongguan) Company Limited.

For Conditions of Issuance of this test report, please refer to the overleaf or Homepage.



## STC Test Report

Date: 2015-08-05

Page 38 of 86

No.: DM120254

### Pi/4 DQPSK: 79 of 79 Channel

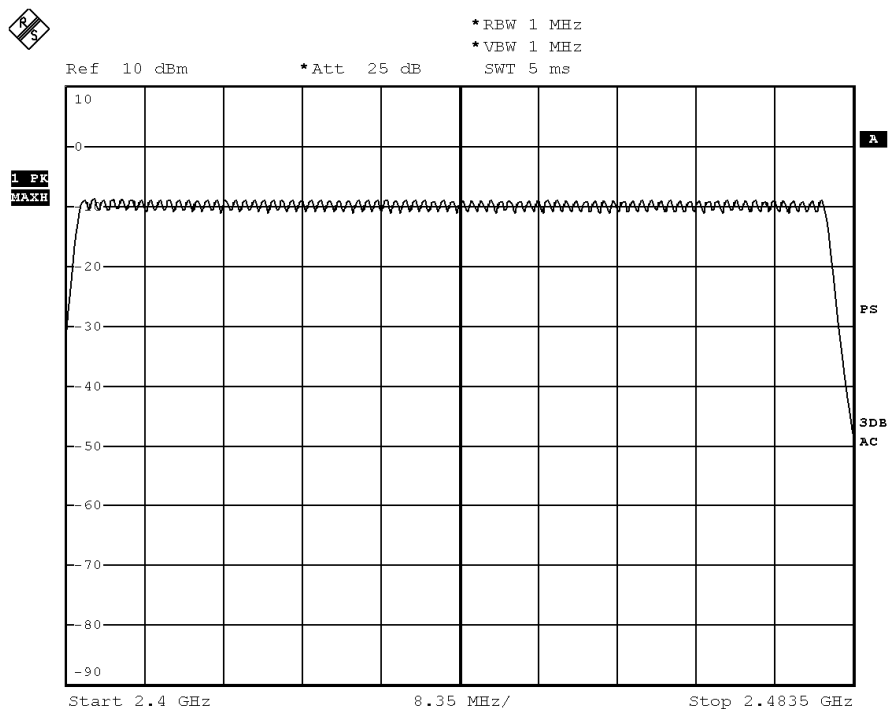

BMP

Date: 18.JUL.2015 13:40:05

### STC (Dongguan) Company Limited

68 Fumin Nan Road, Dalang, Dongguan, China. (Zip Code : 523 770)

Tel : (86 769) 8111 9888 Fax : (86 769) 8111 6222 E-mail : dgstc@dgstc.org Homepage : www.dgstc.org

This report shall not be reproduced unless with prior written approval from STC (Dongguan) Company Limited.  
For Conditions of Issuance of this test report, please refer to the overleaf or Homepage.



## STC Test Report

Date: 2015-08-05

Page 39 of 86

No.: DM120254

### 8DPSK: 79 of 79 Channel



\*RBW 1 MHz  
\*VBW 1 MHz  
SWT 5 ms

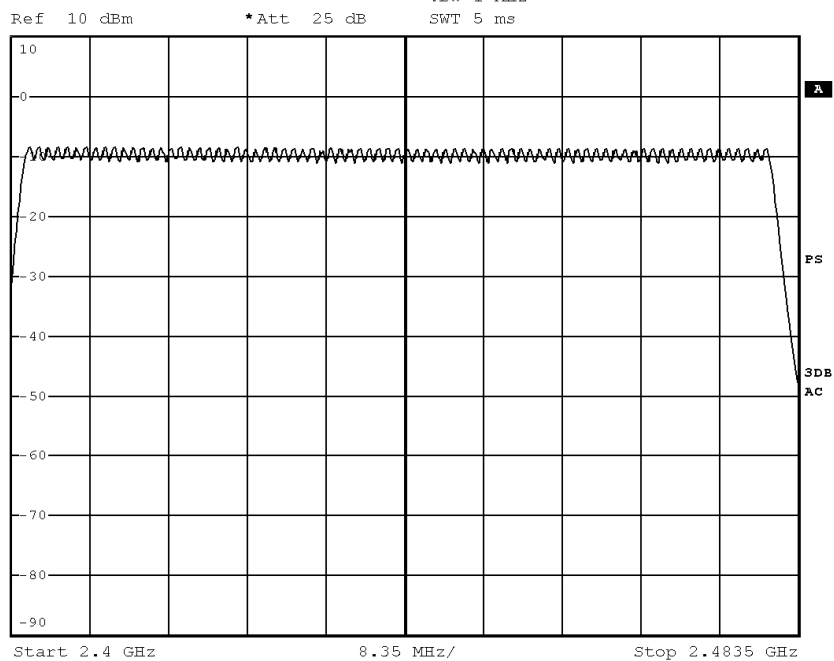

BMP

Date: 18.JUL.2015 13:42:55

### STC (Dongguan) Company Limited

68 Fumin Nan Road, Dalang, Dongguan, China. (Zip Code : 523 770)

Tel : (86 769) 8111 9888 Fax : (86 769) 8111 6222 E-mail : dgstc@dgstc.org Homepage : www.dgstc.org

This report shall not be reproduced unless with prior written approval from STC (Dongguan) Company Limited.  
For Conditions of Issuance of this test report, please refer to the overleaf or Homepage.



## STC Test Report

Date: 2015-08-05

Page 40 of 86

No.: DM120254

### **3.1.5 20dB Bandwidth**

Test Requirement:	FCC 47CFR 15.247(a)(1)
Test Method:	ANSI C63.4:2009
Test Date:	2015-07-18
Mode of Operation:	Communication mode

#### **Remark:**

The result has been done on all the possible configurations for searching the worst cases.

#### **Test Method:**

The bandwidth is measured at an amplitude level reduced from the reference level by a specified ratio. The reference level is the level of the highest amplitude signal observed from the transmitter at the fundamental frequency. Once the reference level is established, the equipment is conditioned with typical modulating signal to produce the worst-case (i.e. the widest) bandwidth.

#### **Test Setup:**

As Test Setup of clause 3.1.1 in this test report.

### **STC (Dongguan) Company Limited**

68 Fumin Nan Road, Dalang, Dongguan, China. (Zip Code : 523 770)

Tel : (86 769) 8111 9888 Fax : (86 769) 8111 6222 E-mail : dgstc@dgstc.org Homepage : www.dgstc.org

This report shall not be reproduced unless with prior written approval from STC (Dongguan) Company Limited.  
For Conditions of Issuance of this test report, please refer to the overleaf or Homepage.





# STC Test Report

Date: 2015-08-05

Page 41 of 86

No.: DM120254

Fundamental Frequency [MHz]	20dB Bandwidth [MHz]	FCC Limits [MHz]
2402	1.065	Within 2400-2483.5

## (Lowest Operating Frequency) - (GFSK)

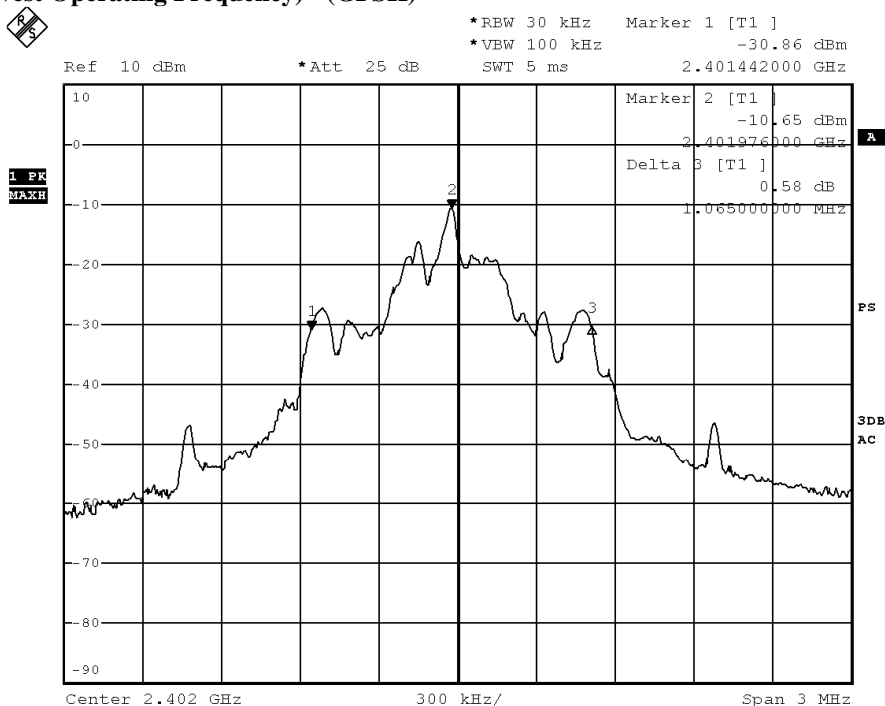

BMP

Date: 18.JUL.2015 14:24:25

### STC (Dongguan) Company Limited

68 Fumin Nan Road, Dalang, Dongguan, China. (Zip Code : 523 770)

Tel : (86 769) 8111 9888 Fax : (86 769) 8111 6222 E-mail : dgstc@dgstc.org Homepage : www.dgstc.org

This report shall not be reproduced unless with prior written approval from STC (Dongguan) Company Limited.  
For Conditions of Issuance of this test report, please refer to the overleaf or Homepage.



# STC Test Report

Date: 2015-08-05

Page 42 of 86

No.: DM120254

Fundamental Frequency [MHz]	20dB Bandwidth [MHz]	FCC Limits [MHz]
2441	1.020	Within 2400-2483.5

## (Middle Operating Frequency) - (GFSK)

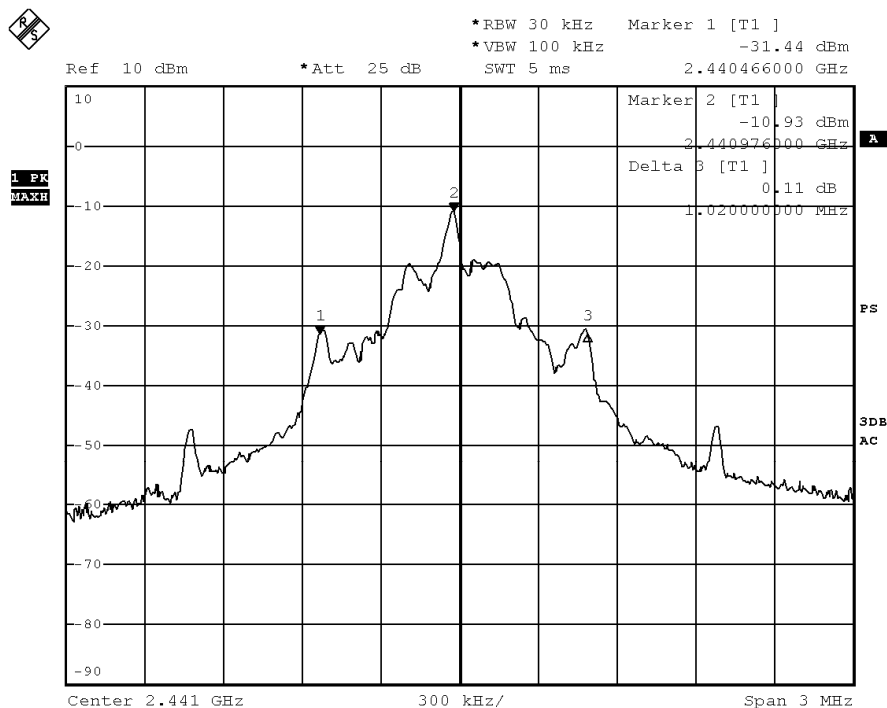

BMP

Date: 18.JUL.2015 14:36:14

### STC (Dongguan) Company Limited

68 Fumin Nan Road, Dalang, Dongguan, China. (Zip Code : 523 770)

Tel : (86 769) 8111 9888 Fax : (86 769) 8111 6222 E-mail : dgstc@dgstc.org Homepage : www.dgstc.org

This report shall not be reproduced unless with prior written approval from STC (Dongguan) Company Limited.  
For Conditions of Issuance of this test report, please refer to the overleaf or Homepage.



# STC Test Report

Date: 2015-08-05

Page 43 of 86

No.: DM120254

Fundamental Frequency [MHz]	20dB Bandwidth [MHz]	FCC Limits [MHz]
2480	1.014	Within 2400-2483.5

## (Highest Operating Frequency) - (GFSK)

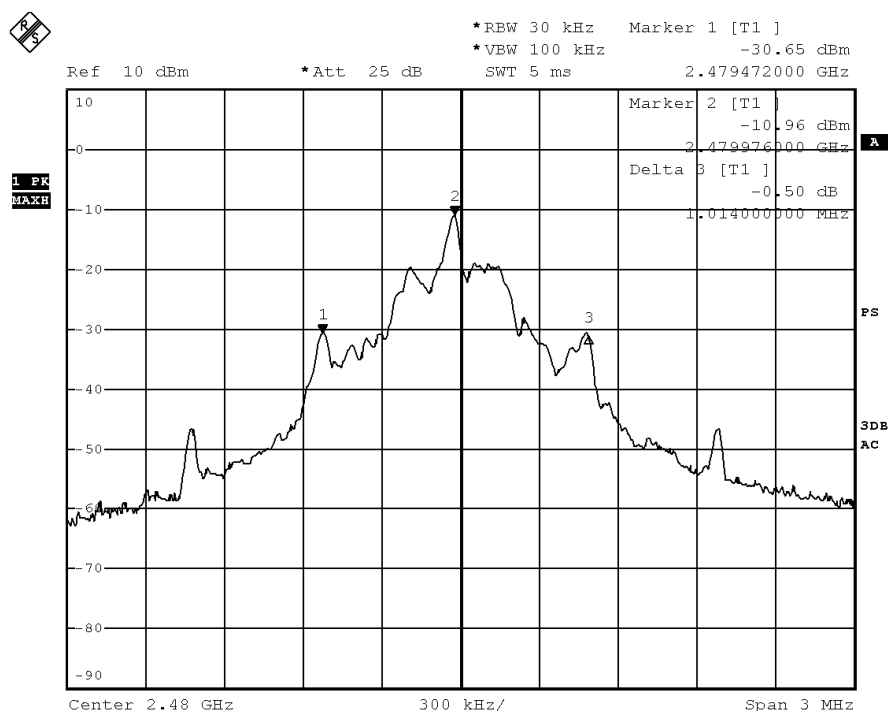

BMP

Date: 18.JUL.2015 14:43:37

### STC (Dongguan) Company Limited

68 Fumin Nan Road, Dalang, Dongguan, China. (Zip Code : 523 770)

Tel : (86 769) 8111 9888 Fax : (86 769) 8111 6222 E-mail : dgstc@dgstc.org Homepage : www.dgstc.org

This report shall not be reproduced unless with prior written approval from STC (Dongguan) Company Limited.  
For Conditions of Issuance of this test report, please refer to the overleaf or Homepage.



# STC Test Report

Date: 2015-08-05

Page 44 of 86

No.: DM120254

Fundamental Frequency [MHz]	20dB Bandwidth [MHz]	FCC Limits [MHz]
2402	1.071	Within 2400-2483.5

## (Lowest Operating Frequency) - ( $\pi/4$ -DQPSK)

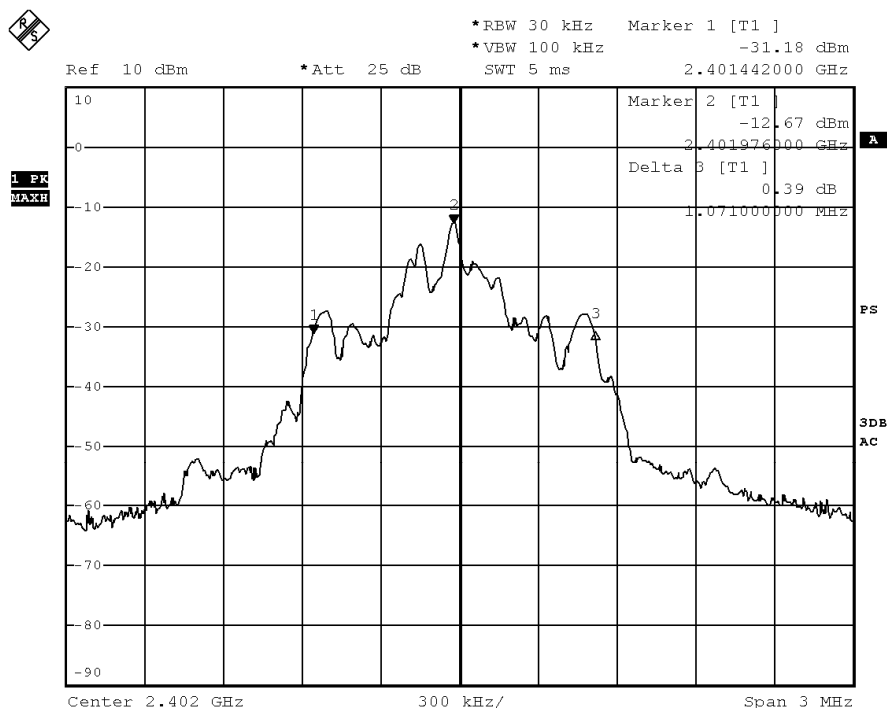

BMP

Date: 18.JUL.2015 14:26:06

### STC (Dongguan) Company Limited

68 Fumin Nan Road, Dalang, Dongguan, China. (Zip Code : 523 770)

Tel : (86 769) 8111 9888 Fax : (86 769) 8111 6222 E-mail : dgstc@dgstc.org Homepage : www.dgstc.org

This report shall not be reproduced unless with prior written approval from STC (Dongguan) Company Limited.  
For Conditions of Issuance of this test report, please refer to the overleaf or Homepage.



# STC Test Report

Date: 2015-08-05

Page 45 of 86

No.: DM120254

Fundamental Frequency [MHz]	20dB Bandwidth [MHz]	FCC Limits [MHz]
2441	1.098	Within 2400-2483.5

## (Middle Operating Frequency) - ( $\pi/4$ -DQPSK)

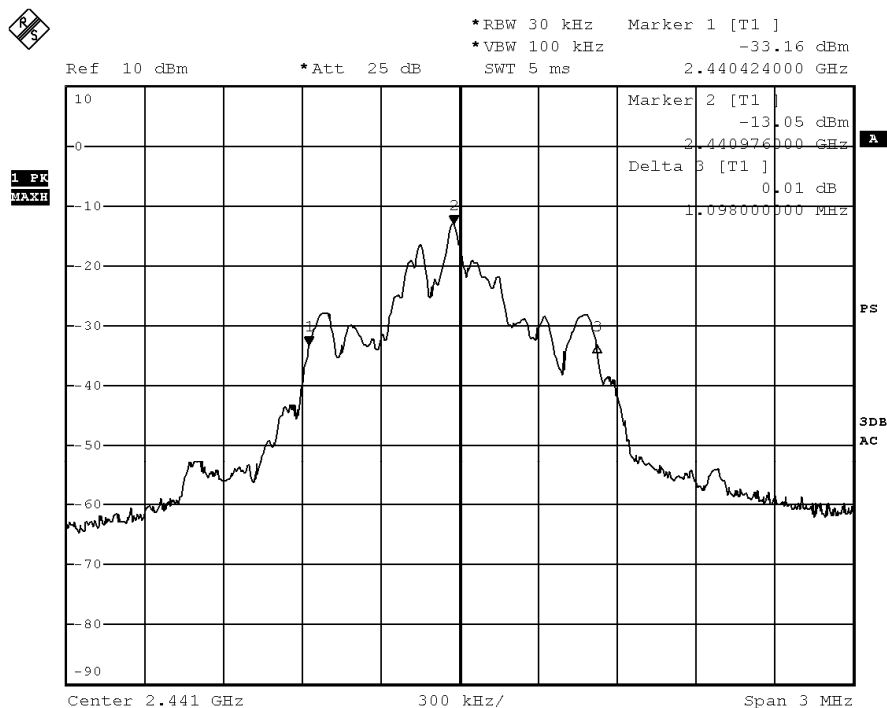

BMP

Date: 18.JUL.2015 14:34:13

### STC (Dongguan) Company Limited

68 Fumin Nan Road, Dalang, Dongguan, China. (Zip Code : 523 770)

Tel : (86 769) 8111 9888 Fax : (86 769) 8111 6222 E-mail : dgstc@dgstc.org Homepage : www.dgstc.org

This report shall not be reproduced unless with prior written approval from STC (Dongguan) Company Limited.  
For Conditions of Issuance of this test report, please refer to the overleaf or Homepage.



# STC Test Report

Date: 2015-08-05

Page 46 of 86

No.: DM120254

Fundamental Frequency [MHz]	20dB Bandwidth [MHz]	FCC Limits [MHz]
2480	1.092	Within 2400-2483.5

## (Highest Operating Frequency) - ( $\pi/4$ -DQPSK)

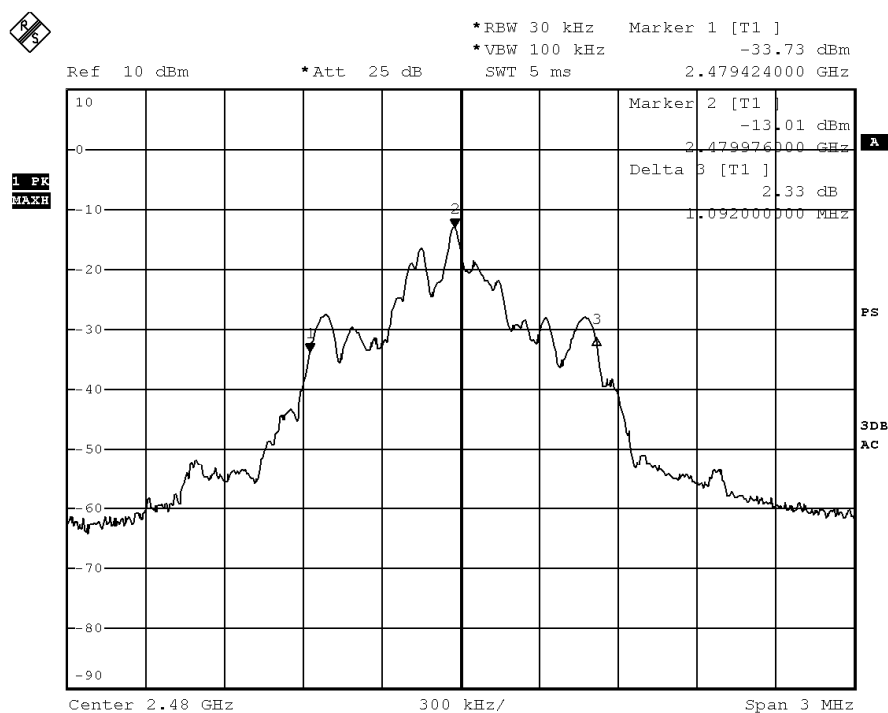

BMP

Date: 18.JUL.2015 14:46:03

### STC (Dongguan) Company Limited

68 Fumin Nan Road, Dalang, Dongguan, China. (Zip Code : 523 770)

Tel : (86 769) 8111 9888 Fax : (86 769) 8111 6222 E-mail : dgstc@dgstc.org Homepage : www.dgstc.org

This report shall not be reproduced unless with prior written approval from STC (Dongguan) Company Limited.  
For Conditions of Issuance of this test report, please refer to the overleaf or Homepage.



# STC Test Report

Date: 2015-08-05

Page 47 of 86

No.: DM120254

Fundamental Frequency [MHz]	20dB Bandwidth [MHz]	FCC Limits [MHz]
2402	1.161	Within 2400-2483.5

## (Lowest Operating Frequency) - (8DPSK)

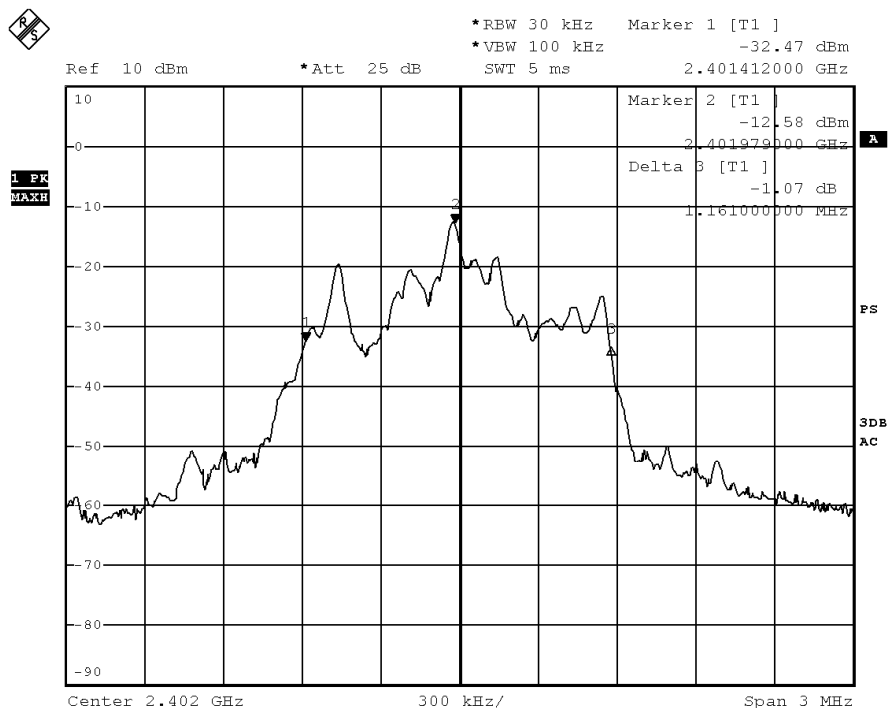

BMP

Date: 18.JUL.2015 14:30:25

### STC (Dongguan) Company Limited

68 Fumin Nan Road, Dalang, Dongguan, China. (Zip Code : 523 770)

Tel : (86 769) 8111 9888 Fax : (86 769) 8111 6222 E-mail : dgstc@dgstc.org Homepage : www.dgstc.org

This report shall not be reproduced unless with prior written approval from STC (Dongguan) Company Limited. For Conditions of Issuance of this test report, please refer to the overleaf or Homepage.



# STC Test Report

Date: 2015-08-05

Page 48 of 86

No.: DM120254

Fundamental Frequency [MHz]	20dB Bandwidth [MHz]	FCC Limits [MHz]
2441	1.158	Within 2400-2483.5

## (Middle Operating Frequency) - (8DPSK)

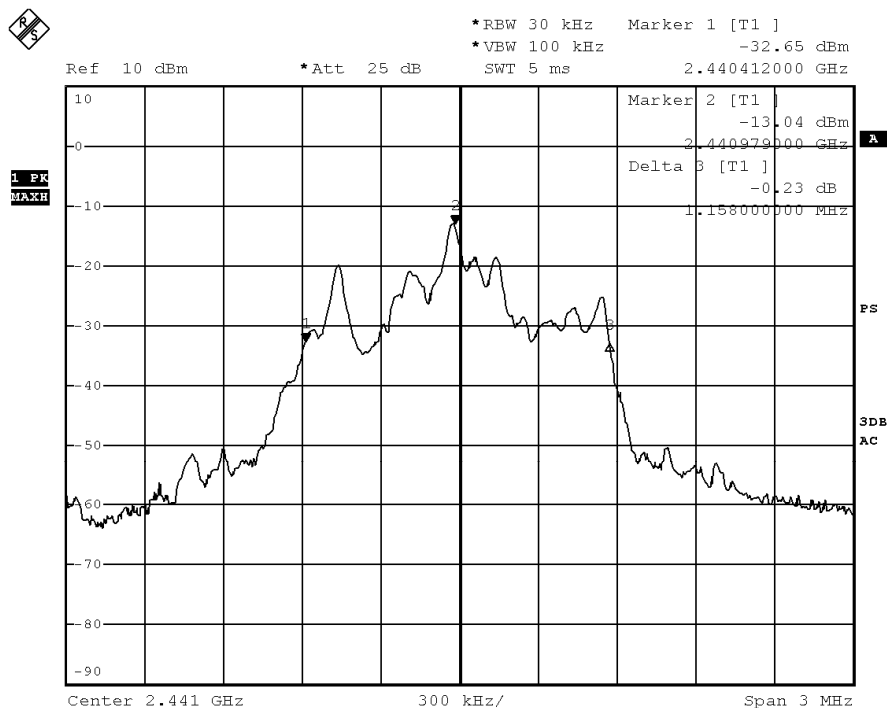

BMP

Date: 18.JUL.2015 14:32:51

### STC (Dongguan) Company Limited

68 Fumin Nan Road, Dalang, Dongguan, China. (Zip Code : 523 770)

Tel : (86 769) 8111 9888 Fax : (86 769) 8111 6222 E-mail : dgstc@dgstc.org Homepage : www.dgstc.org

This report shall not be reproduced unless with prior written approval from STC (Dongguan) Company Limited.  
For Conditions of Issuance of this test report, please refer to the overleaf or Homepage.





# STC Test Report

Date: 2015-08-05

Page 49 of 86

No.: DM120254

Fundamental Frequency [MHz]	20dB Bandwidth [MHz]	FCC Limits [MHz]
2480	1.164	Within 2400-2483.5

## (Highest Operating Frequency) - (8DPSK)

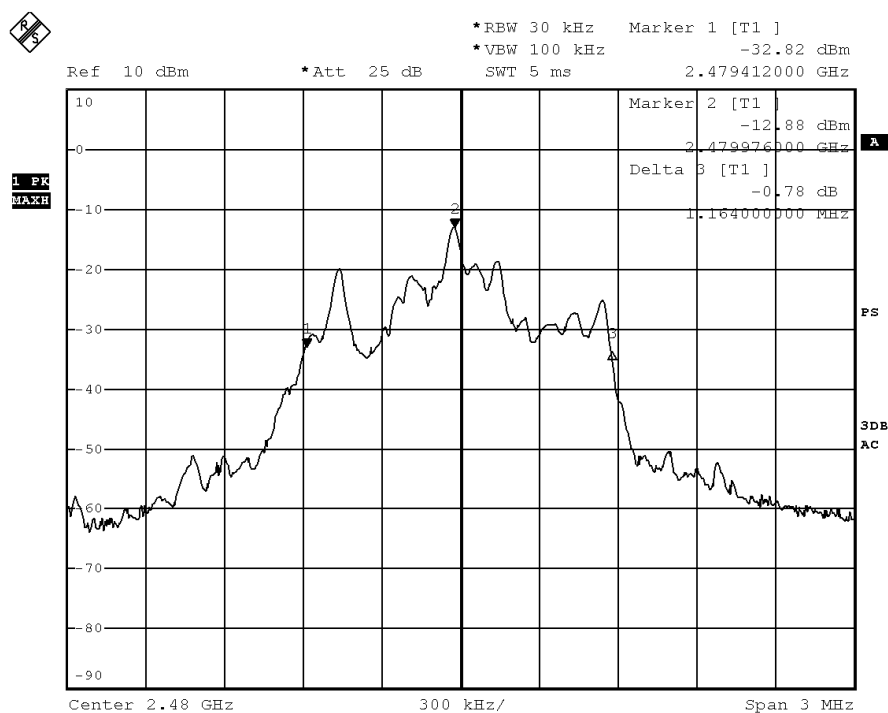

BMP

Date: 18.JUL.2015 14:47:54

### STC (Dongguan) Company Limited

68 Fumin Nan Road, Dalang, Dongguan, China. (Zip Code : 523 770)

Tel : (86 769) 8111 9888 Fax : (86 769) 8111 6222 E-mail : dgstc@dgstc.org Homepage : www.dgstc.org

This report shall not be reproduced unless with prior written approval from STC (Dongguan) Company Limited.  
For Conditions of Issuance of this test report, please refer to the overleaf or Homepage.



## STC Test Report

Date: 2015-08-05

Page 50 of 86

No.: DM120254

### **3.1.6 Hopping Channel Separation**

#### **Requirements:**

Frequency hopping systems operating in the 2400-2483.5 MHz band may have hopping channel carrier frequencies that are separated by 25 kHz or two-thirds of the 20 dB bandwidth of the hopping channel, whichever is greater, provided the systems operate with an output power no greater than 125 mW.

#### **Limit:**

The measured maximum bandwidth \* 2/3 = 1.164MHz \* 2/3 = 776kHz

### **STC (Dongguan) Company Limited**

68 Fumin Nan Road, Dalang, Dongguan, China. (Zip Code : 523 770)

Tel : (86 769) 8111 9888 Fax : (86 769) 8111 6222 E-mail : dgstc@dgstc.org Homepage : www.dgstc.org

This report shall not be reproduced unless with prior written approval from STC (Dongguan) Company Limited.  
For Conditions of Issuance of this test report, please refer to the overleaf or Homepage.



# STC Test Report

Date: 2015-08-05

Page 51 of 86

No.: DM120254

Channel separation = 1MHz (>776kHz) (GFSK)

Channel 1 – Channel 2, Pass

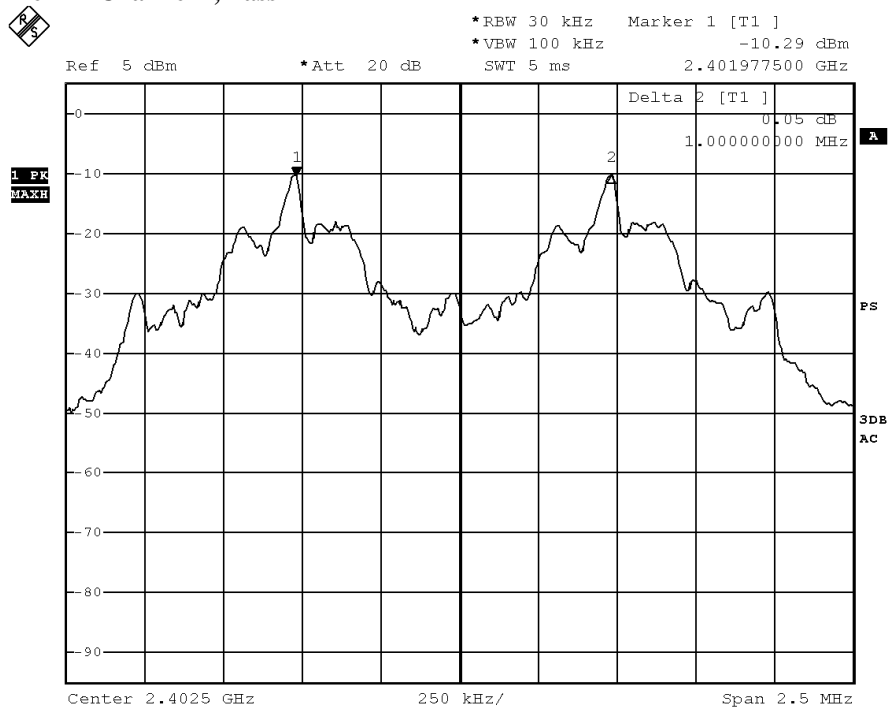

BMP

Date: 18.JUL.2015 10:45:36

## STC (Dongguan) Company Limited

68 Fumin Nan Road, Dalang, Dongguan, China. (Zip Code : 523 770)

Tel : (86 769) 8111 9888 Fax : (86 769) 8111 6222 E-mail : dgstc@dgstc.org Homepage : www.dgstc.org

This report shall not be reproduced unless with prior written approval from STC (Dongguan) Company Limited.  
For Conditions of Issuance of this test report, please refer to the overleaf or Homepage.



# STC Test Report

Date: 2015-08-05

Page 52 of 86

No.: DM120254

## Channel 39 – Channel 40, Pass

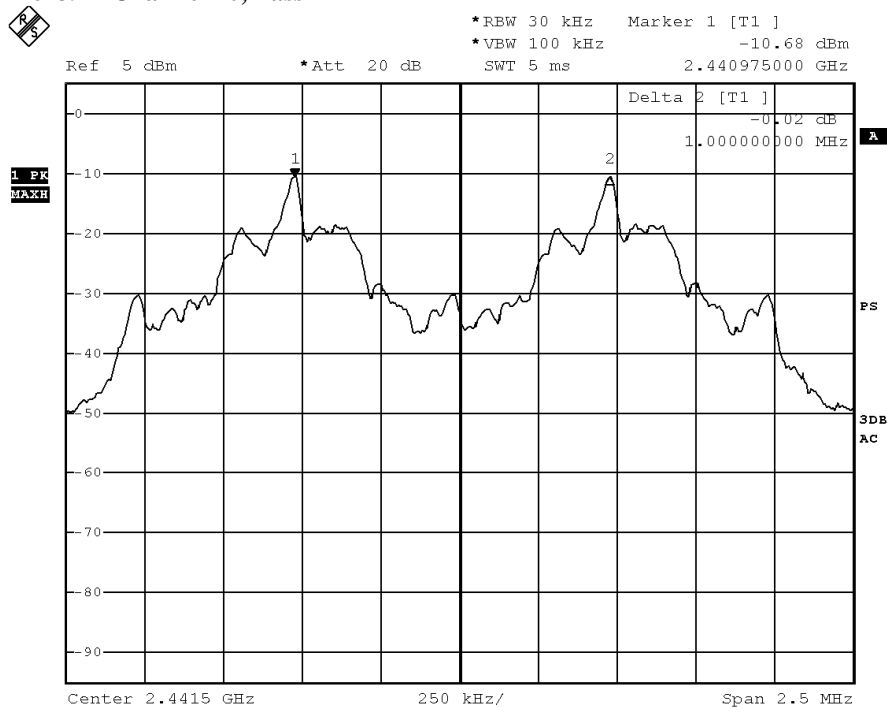

BMP

Date: 18.JUL.2015 10:59:19

## STC (Dongguan) Company Limited

68 Fumin Nan Road, Dalang, Dongguan, China. (Zip Code : 523 770)

Tel : (86 769) 8111 9888 Fax : (86 769) 8111 6222 E-mail : dgstc@dgstc.org Homepage : www.dgstc.org

This report shall not be reproduced unless with prior written approval from STC (Dongguan) Company Limited.  
 For Conditions of Issuance of this test report, please refer to the overleaf or Homepage.



# STC Test Report

Date: 2015-08-05

Page 53 of 86

No.: DM120254

## Channel 78 – Channel 79, Pass

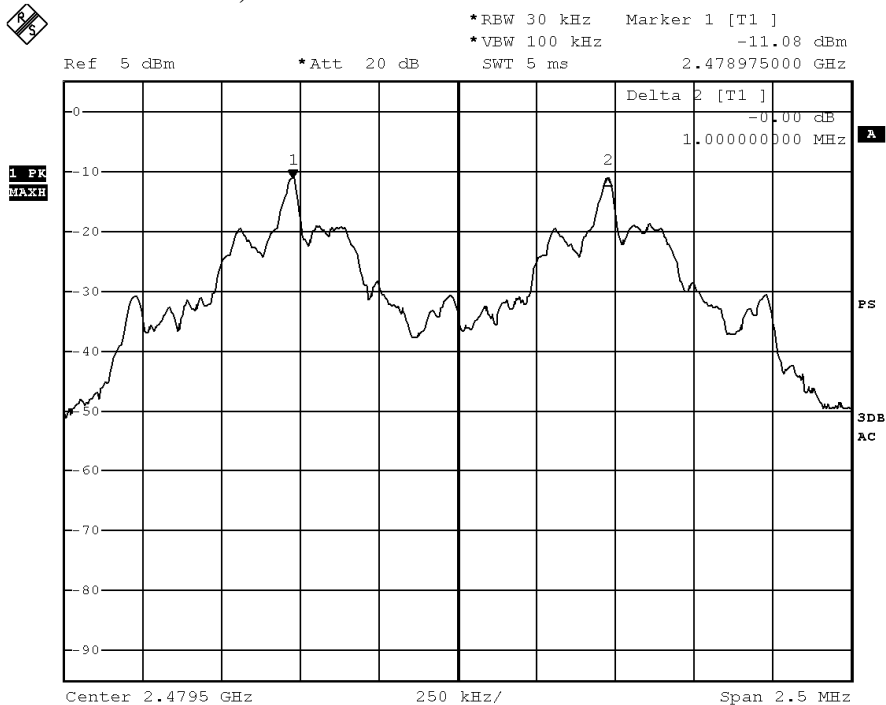

BMP

Date: 18.JUL.2015 11:10:38

### STC (Dongguan) Company Limited

68 Fumin Nan Road, Dalang, Dongguan, China. (Zip Code : 523 770)

Tel : (86 769) 8111 9888 Fax : (86 769) 8111 6222 E-mail : dgstc@dgstc.org Homepage : www.dgstc.org

This report shall not be reproduced unless with prior written approval from STC (Dongguan) Company Limited.  
For Conditions of Issuance of this test report, please refer to the overleaf or Homepage.



## STC Test Report

Date: 2015-08-05

Page 54 of 86

No.: DM120254

Channel separation = 1MHz (>776kHz) ( $\pi/4$ - DQPSK)

Channel 1 – Channel 2, Pass

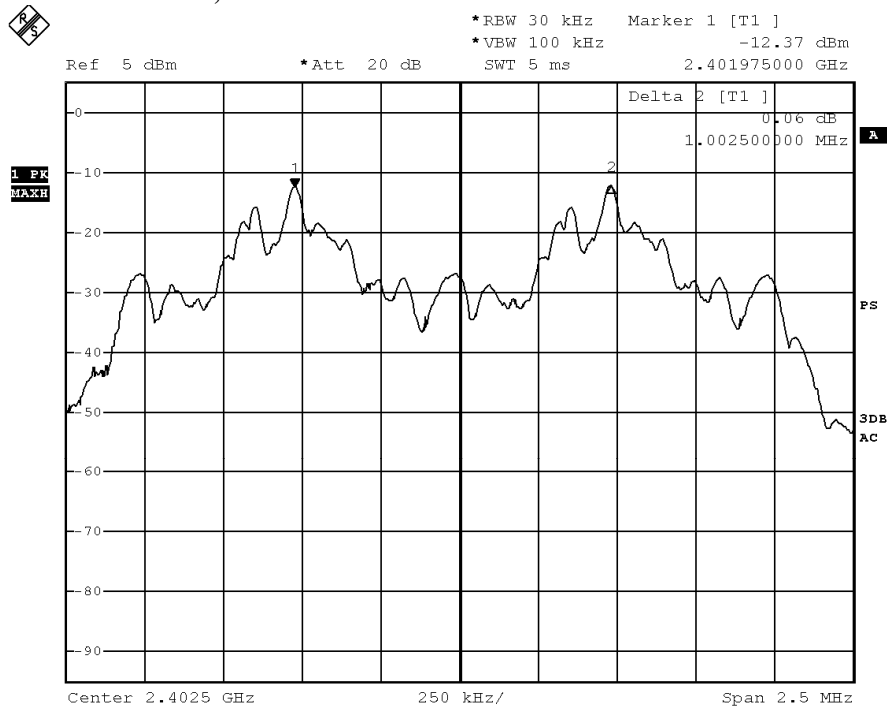

BMP

Date: 18.JUL.2015 10:50:56

### STC (Dongguan) Company Limited

68 Fumin Nan Road, Dalang, Dongguan, China. (Zip Code : 523 770)

Tel : (86 769) 8111 9888 Fax : (86 769) 8111 6222 E-mail : dgstc@dgstc.org Homepage : www.dgstc.org

This report shall not be reproduced unless with prior written approval from STC (Dongguan) Company Limited.  
For Conditions of Issuance of this test report, please refer to the overleaf or Homepage.



# STC Test Report

Date: 2015-08-05

Page 55 of 86

No.: DM120254

## Channel 39 – Channel 40, Pass

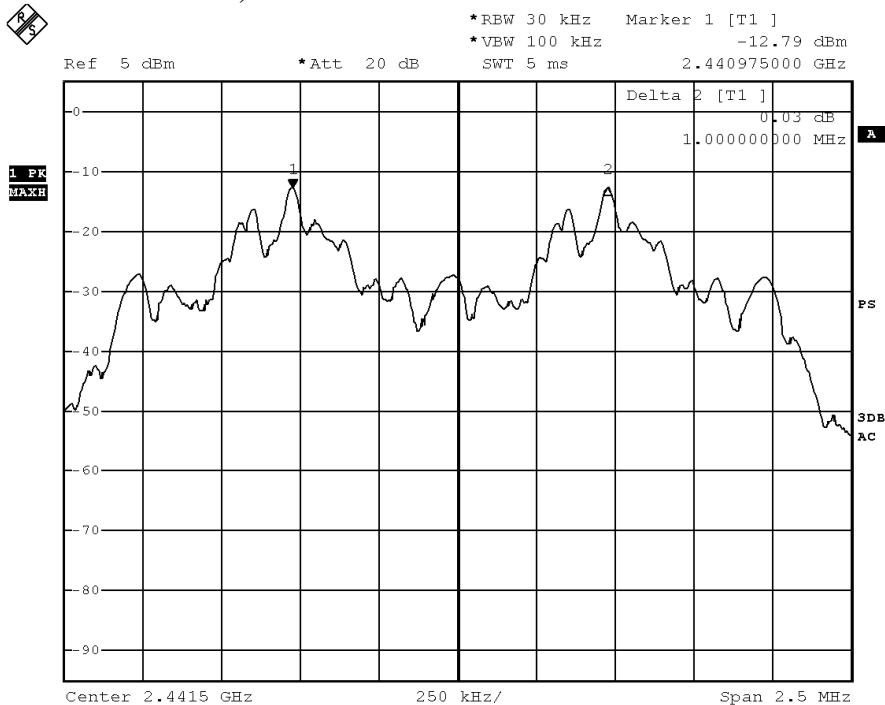

BMP

Date: 18.JUL.2015 11:05:03

### STC (Dongguan) Company Limited

68 Fumin Nan Road, Dalang, Dongguan, China. (Zip Code : 523 770)

Tel : (86 769) 8111 9888 Fax : (86 769) 8111 6222 E-mail : dgstc@dgstc.org Homepage : www.dgstc.org

This report shall not be reproduced unless with prior written approval from STC (Dongguan) Company Limited.  
For Conditions of Issuance of this test report, please refer to the overleaf or Homepage.



# STC Test Report

Date: 2015-08-05

Page 56 of 86

No.: DM120254

## Channel 78 – Channel 79, Pass

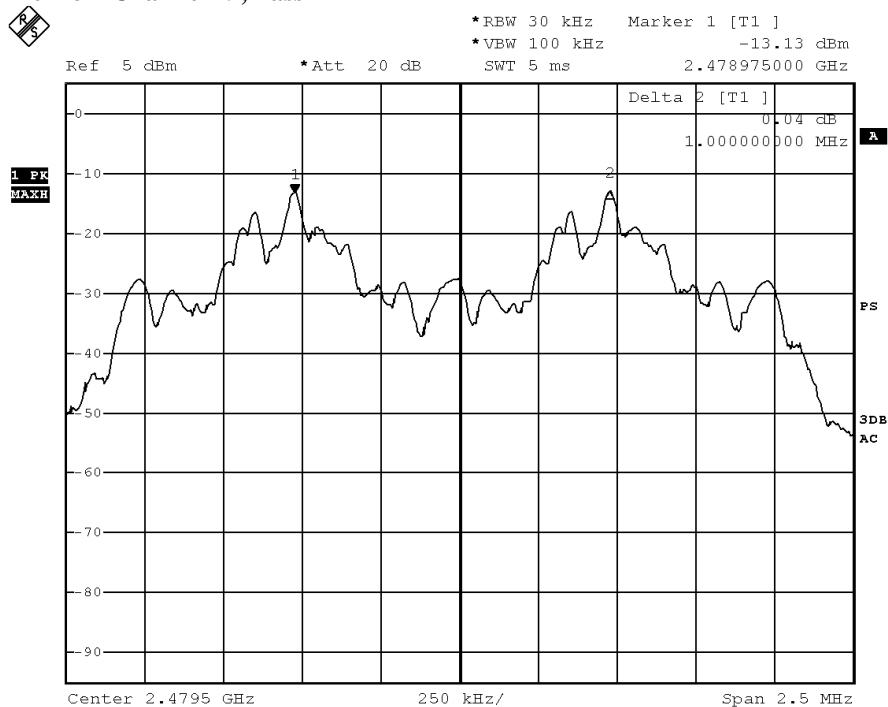

BMP

Date: 18.JUL.2015 11:16:57

### STC (Dongguan) Company Limited

68 Fumin Nan Road, Dalang, Dongguan, China. (Zip Code : 523 770)

Tel : (86 769) 8111 9888 Fax : (86 769) 8111 6222 E-mail : dgstc@dgstc.org Homepage : www.dgstc.org

This report shall not be reproduced unless with prior written approval from STC (Dongguan) Company Limited.  
For Conditions of Issuance of this test report, please refer to the overleaf or Homepage.





# STC Test Report

Date: 2015-08-05

Page 57 of 86

No.: DM120254

Channel separation = 1MHz (>776kHz) (8DPSK)

Channel 1 – Channel 2, Pass



\*RBW 30 kHz    Marker 1 [T1 ]  
\*VBW 100 kHz    -12.30 dBm  
SWT 5 ms    2.401977500 GHz

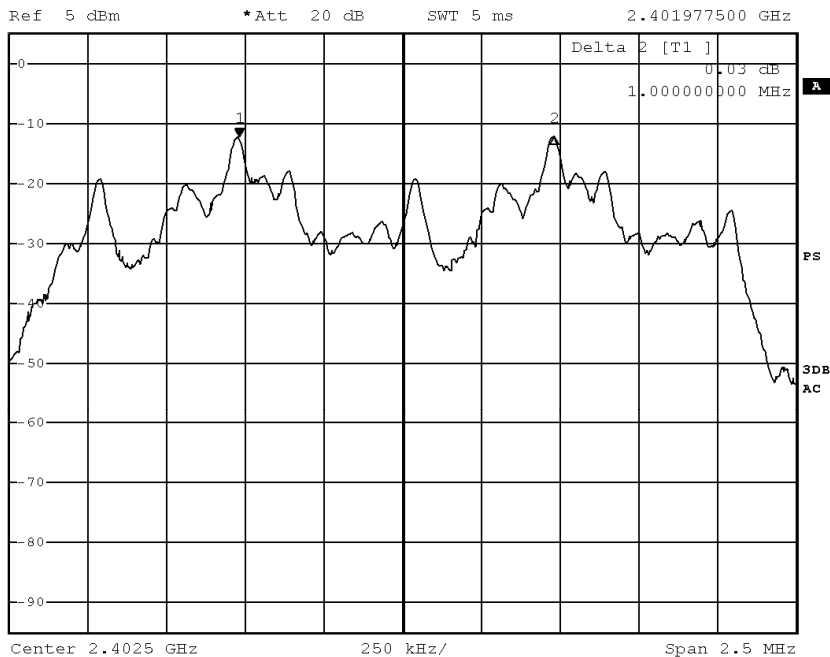

BMP

Date: 18.JUL.2015 10:54:19

## STC (Dongguan) Company Limited

68 Fumin Nan Road, Dalang, Dongguan, China. (Zip Code : 523 770)

Tel : (86 769) 8111 9888 Fax : (86 769) 8111 6222 E-mail : dgstc@dgstc.org Homepage : www.dgstc.org

This report shall not be reproduced unless with prior written approval from STC (Dongguan) Company Limited.  
For Conditions of Issuance of this test report, please refer to the overleaf or Homepage.



# STC Test Report

Date: 2015-08-05

Page 58 of 86

No.: DM120254

## Channel 39 – Channel 40, Pass

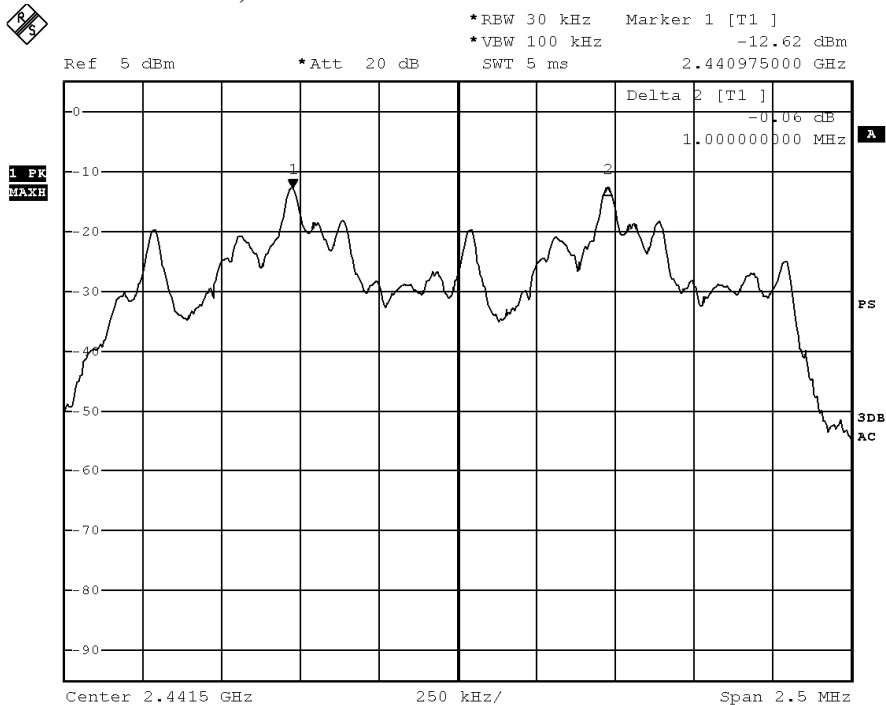

BMP

Date: 18.JUL.2015 11:07:51

### STC (Dongguan) Company Limited

68 Fumin Nan Road, Dalang, Dongguan, China. (Zip Code : 523 770)

Tel : (86 769) 8111 9888 Fax : (86 769) 8111 6222 E-mail : dgstc@dgstc.org Homepage : www.dgstc.org

This report shall not be reproduced unless with prior written approval from STC (Dongguan) Company Limited.  
 For Conditions of Issuance of this test report, please refer to the overleaf or Homepage.



# STC Test Report

Date: 2015-08-05

Page 59 of 86

No.: DM120254

## Channel 78 – Channel 79, Pass

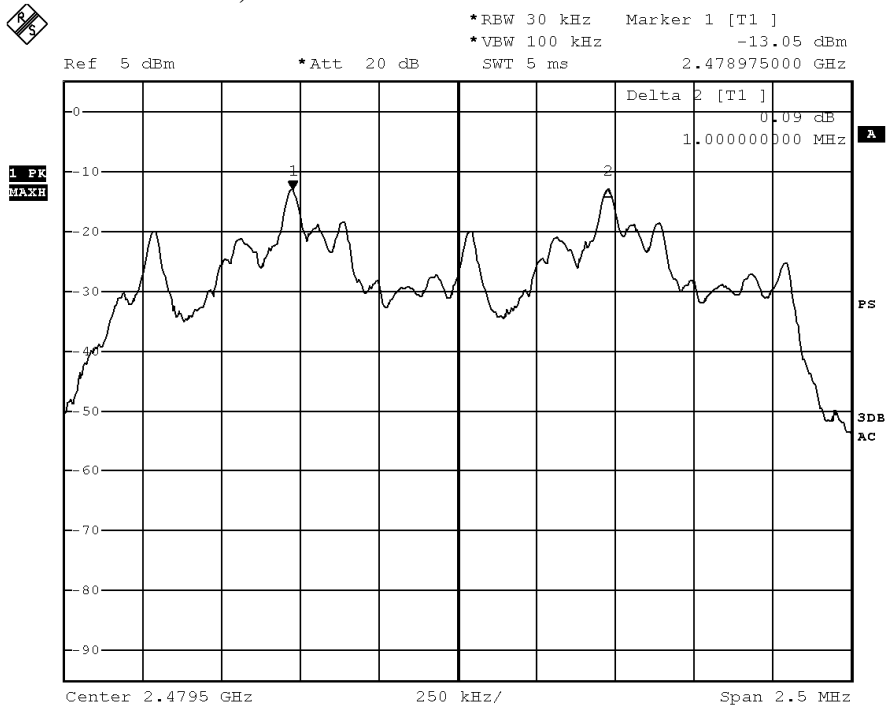

BMP

Date: 18.JUL.2015 11:23:28

### STC (Dongguan) Company Limited

68 Fumin Nan Road, Dalang, Dongguan, China. (Zip Code : 523 770)

Tel : (86 769) 8111 9888 Fax : (86 769) 8111 6222 E-mail : dgstc@dgstc.org Homepage : www.dgstc.org

This report shall not be reproduced unless with prior written approval from STC (Dongguan) Company Limited.  
For Conditions of Issuance of this test report, please refer to the overleaf or Homepage.



## STC Test Report

Date: 2015-08-05

Page 60 of 86

No.: DM120254

### 3.1.7 Band-edge Compliance of RF Conducted Emissions Measurement:

#### Limit :

In any 100 kHz bandwidth outside the frequency band in which the spread spectrum or digitally modulated intentional radiator is operating, the radio frequency power that is produced by the intentional radiator shall be at least 20 dB below that in the 100 kHz bandwidth within the band that contains the highest level of the desired power, based on either an RF conducted or a radiated measurement. Attenuation below the general limits specified in Section 15.209(a) is not required.

Remark: Emissions under the fixed frequency mode and hopping mode have been investigated, the worst-case measurement results were recorded in the test report

Frequency Range [MHz]	Radiated Emission Attenuated below the Fundamental [dB]
2400 – Lowest Fundamental (2402)	41.43

### Band-edge Compliance of RF Conducted Emissions (GFSK Lowest)

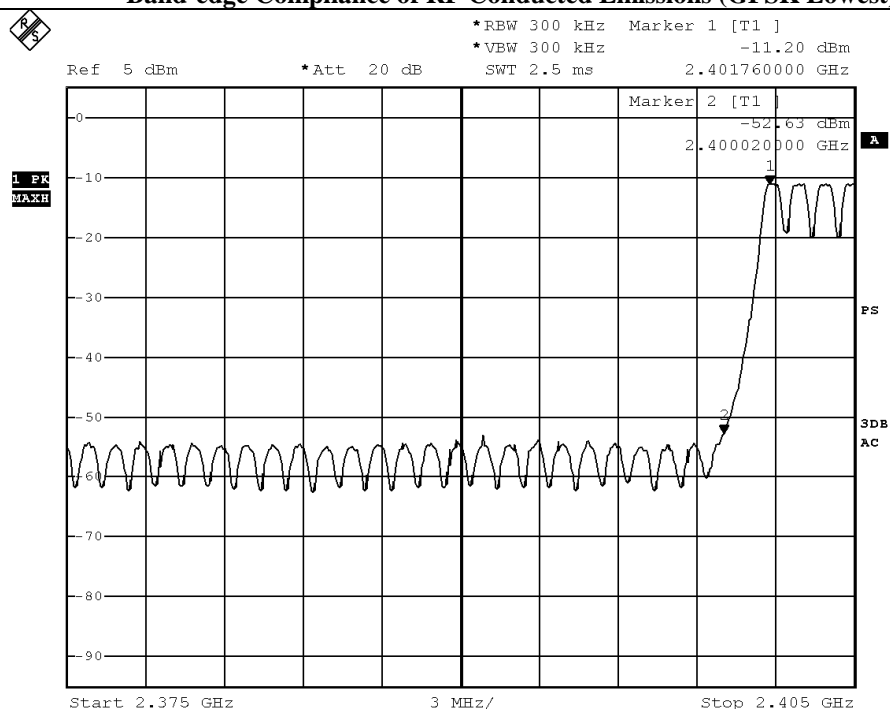

BMP

Date: 24.JUL.2015 10:54:11

### STC (Dongguan) Company Limited

68 Fumin Nan Road, Dalang, Dongguan, China. (Zip Code : 523 770)

Tel : (86 769) 8111 9888 Fax : (86 769) 8111 6222 E-mail : dgstc@dgstc.org Homepage : www.dgstc.org

This report shall not be reproduced unless with prior written approval from STC (Dongguan) Company Limited.  
For Conditions of Issuance of this test report, please refer to the overleaf or Homepage.





# STC Test Report

Date: 2015-08-05

Page 62 of 86

No.: DM120254

### Band-edge Compliance of RF Conducted Emissions Measurement:

Frequency Range [MHz]	Radiated Emission Attenuated below the Fundamental [dB]
2400 - Lowest Fundamental (2402)	41.84

### Band-edge Compliance of RF Conducted Emissions ( $\pi/4$ -DQPSK Lowest)

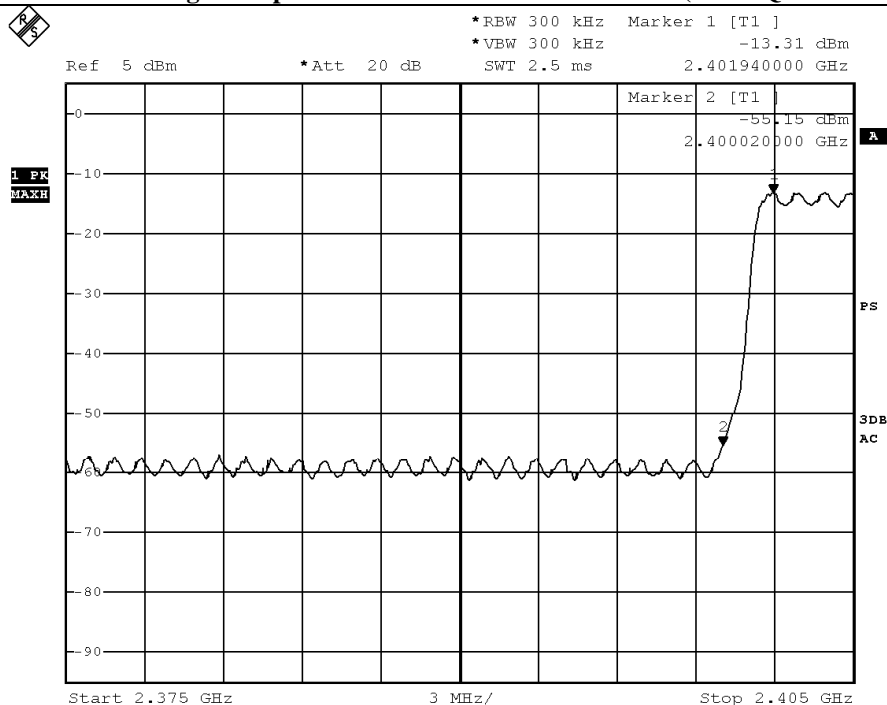

BMP

Date: 24.JUL.2015 11:04:50

## STC (Dongguan) Company Limited

68 Fumin Nan Road, Dalang, Dongguan, China. (Zip Code : 523 770)

Tel : (86 769) 8111 9888 Fax : (86 769) 8111 6222 E-mail : dgstc@dgstc.org Homepage : www.dgstc.org

This report shall not be reproduced unless with prior written approval from STC (Dongguan) Company Limited. For Conditions of Issuance of this test report, please refer to the overleaf or Homepage.



# STC Test Report

Date: 2015-08-05

Page 63 of 86

No.: DM120254

### Band-edge Compliance of RF Conducted Emissions Measurement:

Frequency Range [MHz]	Radiated Emission Attenuated below the Fundamental [dB]
Highest Fundamental (2480) - 2483.5	43.79

### Band-edge Compliance of RF Conducted Emissions ( $\pi/4$ -DQPSK Highest)

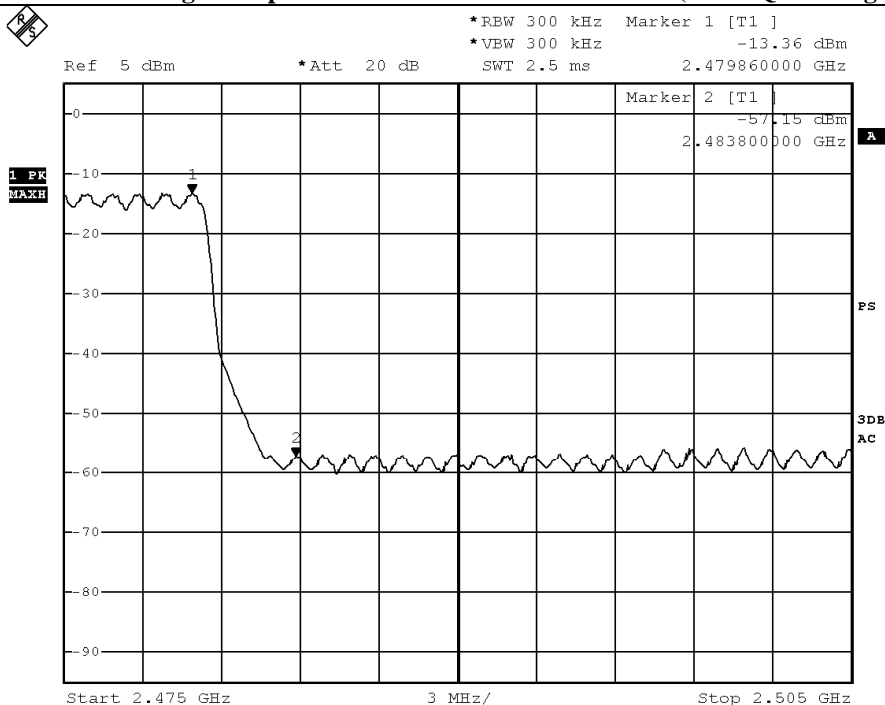

BMP

Date: 24.JUL.2015 14:00:31

## STC (Dongguan) Company Limited

68 Fumin Nan Road, Dalang, Dongguan, China. (Zip Code : 523 770)

Tel : (86 769) 8111 9888 Fax : (86 769) 8111 6222 E-mail : dgstc@dgstc.org Homepage : www.dgstc.org

This report shall not be reproduced unless with prior written approval from STC (Dongguan) Company Limited.  
For Conditions of Issuance of this test report, please refer to the overleaf or Homepage.



# STC Test Report

Date: 2015-08-05

Page 64 of 86

No.: DM120254

### Band-edge Compliance of RF Conducted Emissions Measurement:

Frequency Range [MHz]	Radiated Emission Attenuated below the Fundamental [dB]
2400 - Lowest Fundamental (2402)	41.07

### Band-edge Compliance of RF Conducted Emissions (8DPSK Lowest)

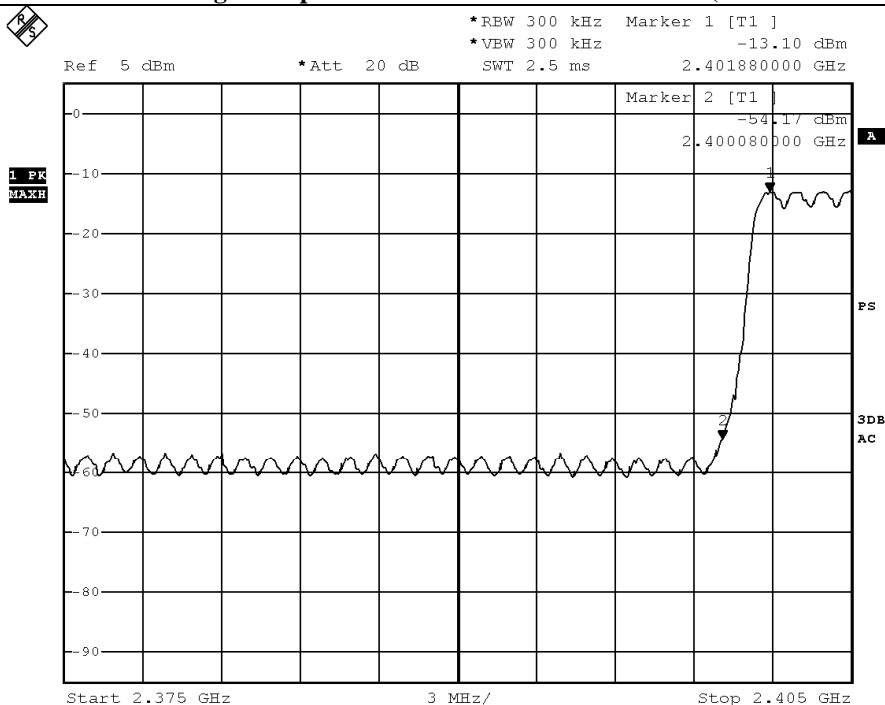

BMP

Date: 24.JUL.2015 11:32:48

## STC (Dongguan) Company Limited

68 Fumin Nan Road, Dalang, Dongguan, China. (Zip Code : 523 770)

Tel : (86 769) 8111 9888 Fax : (86 769) 8111 6222 E-mail : dgstc@dgstc.org Homepage : www.dgstc.org

This report shall not be reproduced unless with prior written approval from STC (Dongguan) Company Limited. For Conditions of Issuance of this test report, please refer to the overleaf or Homepage.





## STC Test Report

Date: 2015-08-05

Page 65 of 86

No.: DM120254

### Band-edge Compliance of RF Conducted Emissions Measurement:

Frequency Range [MHz]	Radiated Emission Attenuated below the Fundamental [dB]
Highest Fundamental (2480) - 2483.5	43.44

### Band-edge Compliance of RF Conducted Emissions (8DPSK Highest)

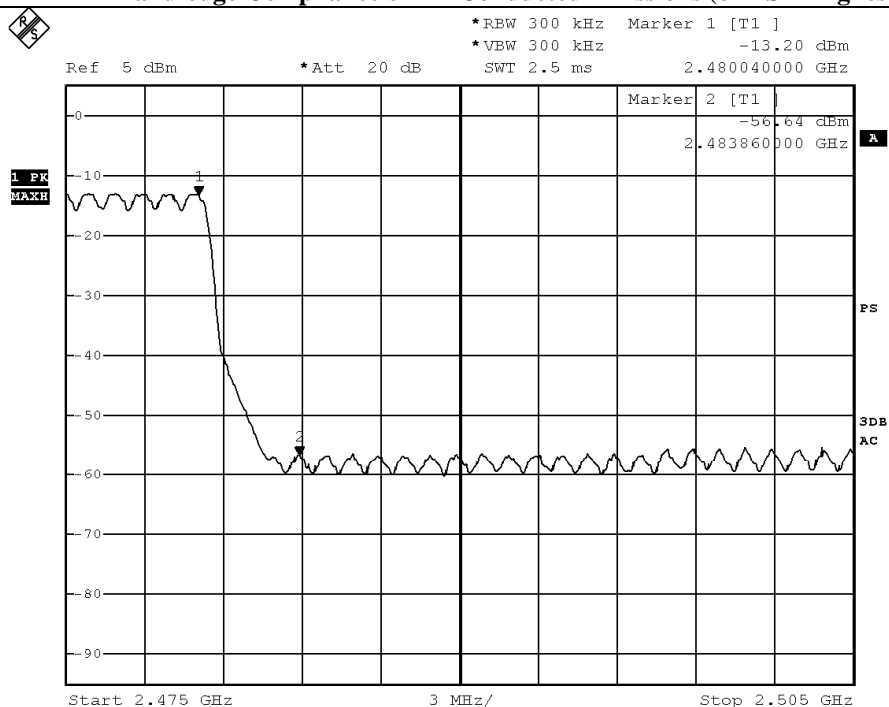

BMP

Date: 24.JUL.2015 14:18:11

### STC (Dongguan) Company Limited

68 Fumin Nan Road, Dalang, Dongguan, China. (Zip Code : 523 770)

Tel : (86 769) 8111 9888 Fax : (86 769) 8111 6222 E-mail : dgstc@dgstc.org Homepage : www.dgstc.org

This report shall not be reproduced unless with prior written approval from STC (Dongguan) Company Limited.  
For Conditions of Issuance of this test report, please refer to the overleaf or Homepage.



## STC Test Report

Date: 2015-08-05

Page 66 of 86

No.: DM120254

### Band-edge Compliance of RF Radiated Emissions Measurement:

#### Limit :

In any 100 kHz bandwidth outside the frequency band in which the spread spectrum or digitally modulated intentional radiator is operating, the radio frequency power that is produced by the intentional radiator shall be at least 20 dB below that in the 100 kHz bandwidth within the band that contains the highest level of the desired power, based on either an RF conducted or a radiated measurement. Attenuation below the general limits specified in Section 15.209(a) is not required. In addition, radiated emissions which fall in the restricted bands, as defined in Section 15.205(a), must also comply with the radiated emission limits specified in Section 15.209(a) (see Section 5.205(c)).

### Result: Band-edge Compliance of RF Radiated Emissions (GFSK Lowest)

Field Strength of Band-edge Compliance Peak Value						
Frequency MHz	Measured Level @3m dB $\mu$ V	Correction Factor dB/m	Field Strength dB $\mu$ V/m	Limit @3m dB $\mu$ V/m	Margin dB $\mu$ V/m	E-Field Polarity
2390.0	22.0	36.8	58.8	74.0	15.2	Vertical

Field Strength of Band-edge Compliance Average Value						
Frequency MHz	Measured Level @3m dB $\mu$ V	Correction Factor dB/m	Field Strength dB $\mu$ V/m	Limit @3m dB $\mu$ V/m	Margin dB $\mu$ V/m	E-Field Polarity
2390.0	6.8	36.8	43.6	54.0	10.4	Vertical

### Result: Band-edge Compliance of RF Radiated Emissions (GFSK Highest)

Field Strength of Band-edge Compliance Peak Value						
Frequency MHz	Measured Level @3m dB $\mu$ V	Correction Factor dB/m	Field Strength dB $\mu$ V/m	Limit @3m dB $\mu$ V/m	Margin dB $\mu$ V/m	E-Field Polarity
2483.5	14.0	36.8	50.8	74.0	23.3	Vertical

Field Strength of Band-edge Compliance Average Value						
Frequency MHz	Measured Level @3m dB $\mu$ V	Correction Factor dB/m	Field Strength dB $\mu$ V/m	Limit @3m dB $\mu$ V/m	Margin dB $\mu$ V/m	E-Field Polarity
2483.5	-1.3	36.8	35.5	54.0	18.5	Vertical

### STC (Dongguan) Company Limited

68 Fumin Nan Road, Dalang, Dongguan, China. (Zip Code : 523 770)

Tel : (86 769) 8111 9888 Fax : (86 769) 8111 6222 E-mail : dgstc@dgstc.org Homepage : www.dgstc.org

This report shall not be reproduced unless with prior written approval from STC (Dongguan) Company Limited.

For Conditions of Issuance of this test report, please refer to the overleaf or Homepage.



## STC Test Report

Date: 2015-08-05

Page 67 of 86

No.: DM120254

### Result: Band-edge Compliance of RF Radiated Emissions ( $\pi/4$ -DQPSK Lowest)

Field Strength of Band-edge Compliance Peak Value						
Frequency MHz	Measured Level @3m dB $\mu$ V	Correction Factor dB/m	Field Strength dB $\mu$ V/m	Limit @3m dB $\mu$ V/m	Margin dB $\mu$ V/m	E-Field Polarity
2390.0	20.0	36.8	56.8	74.0	17.2	Vertical

Field Strength of Band-edge Compliance Average Value						
Frequency MHz	Measured Level @3m dB $\mu$ V	Correction Factor dB/m	Field Strength dB $\mu$ V/m	Limit @3m dB $\mu$ V/m	Margin dB $\mu$ V/m	E-Field Polarity
2390.0	4.9	36.8	41.7	54.0	12.3	Vertical

### Result: Band-edge Compliance of RF Radiated Emissions ( $\pi/4$ -DQPSK Highest)

Field Strength of Band-edge Compliance Peak Value						
Frequency MHz	Measured Level @3m dB $\mu$ V	Correction Factor dB/m	Field Strength dB $\mu$ V/m	Limit @3m dB $\mu$ V/m	Margin dB $\mu$ V/m	E-Field Polarity
2483.5	12.9	36.8	49.7	74.0	24.3	Vertical

Field Strength of Band-edge Compliance Average Value						
Frequency MHz	Measured Level @3m dB $\mu$ V	Correction Factor dB/m	Field Strength dB $\mu$ V/m	Limit @3m dB $\mu$ V/m	Margin dB $\mu$ V/m	E-Field Polarity
2483.5	-2.3	36.8	34.5	54.0	19.5	Vertical

### STC (Dongguan) Company Limited

68 Fumin Nan Road, Dalang, Dongguan, China. (Zip Code : 523 770)

Tel : (86 769) 8111 9888 Fax : (86 769) 8111 6222 E-mail : dgstc@dgstc.org Homepage : www.dgstc.org

This report shall not be reproduced unless with prior written approval from STC (Dongguan) Company Limited.

For Conditions of Issuance of this test report, please refer to the overleaf or Homepage.



## STC Test Report

Date: 2015-08-05

Page 68 of 86

No.: DM120254

### **Result: Band-edge Compliance of RF Radiated Emissions (8DPSK Lowest)**

<b>Field Strength of Band-edge Compliance Peak Value</b>						
Frequency MHz	Measured Level @3m dB $\mu$ V	Correction Factor dB/m	Field Strength dB $\mu$ V/m	Limit @3m dB $\mu$ V/m	Margin dB $\mu$ V/m	E-Field Polarity
2390.0	20.9	36.8	57.7	74.0	16.3	Vertical

<b>Field Strength of Band-edge Compliance Average Value</b>						
Frequency MHz	Measured Level @3m dB $\mu$ V	Correction Factor dB/m	Field Strength dB $\mu$ V/m	Limit @3m dB $\mu$ V/m	Margin dB $\mu$ V/m	E-Field Polarity
2390.0	5.7	36.8	42.5	54.0	11.5	Vertical

### **Result: Band-edge Compliance of RF Radiated Emissions (8DPSK Highest)**

<b>Field Strength of Band-edge Compliance Peak Value</b>						
Frequency MHz	Measured Level @3m dB $\mu$ V	Correction Factor dB/m	Field Strength dB $\mu$ V/m	Limit @3m dB $\mu$ V/m	Margin dB $\mu$ V/m	E-Field Polarity
2483.5	14.5	36.8	51.3	74.0	22.7	Vertical

<b>Field Strength of Band-edge Compliance Average Value</b>						
Frequency MHz	Measured Level @3m dB $\mu$ V	Correction Factor dB/m	Field Strength dB $\mu$ V/m	Limit @3m dB $\mu$ V/m	Margin dB $\mu$ V/m	E-Field Polarity
2483.5	-0.7	36.8	36.1	54.0	17.9	Vertical

### **STC (Dongguan) Company Limited**

68 Fumin Nan Road, Dalang, Dongguan, China. (Zip Code : 523 770)

Tel : (86 769) 8111 9888 Fax : (86 769) 8111 6222 E-mail : dgstc@dgstc.org Homepage : www.dgstc.org

This report shall not be reproduced unless with prior written approval from STC (Dongguan) Company Limited.  
For Conditions of Issuance of this test report, please refer to the overleaf or Homepage.



## STC Test Report

Date: 2015-08-05

Page 69 of 86

No.: DM120254

### 3.1.8 Time of Occupancy (Dwell Time)

#### Requirements:

The average time of occupancy on any channel shall not be greater than 0.4 seconds within a period of 0.4 seconds multiplied by the number of hopping channel employed.  
No requirements for Digital Transmission System.

**Dwell Time = Pulse Duration \* hop rate / number of channel \* observation duration**

**Observed duration: 0.4s x 79 = 31.6s**

#### Measurement Data:

**Channel Occupied in 8DPSK: 79 of 79 Channel**

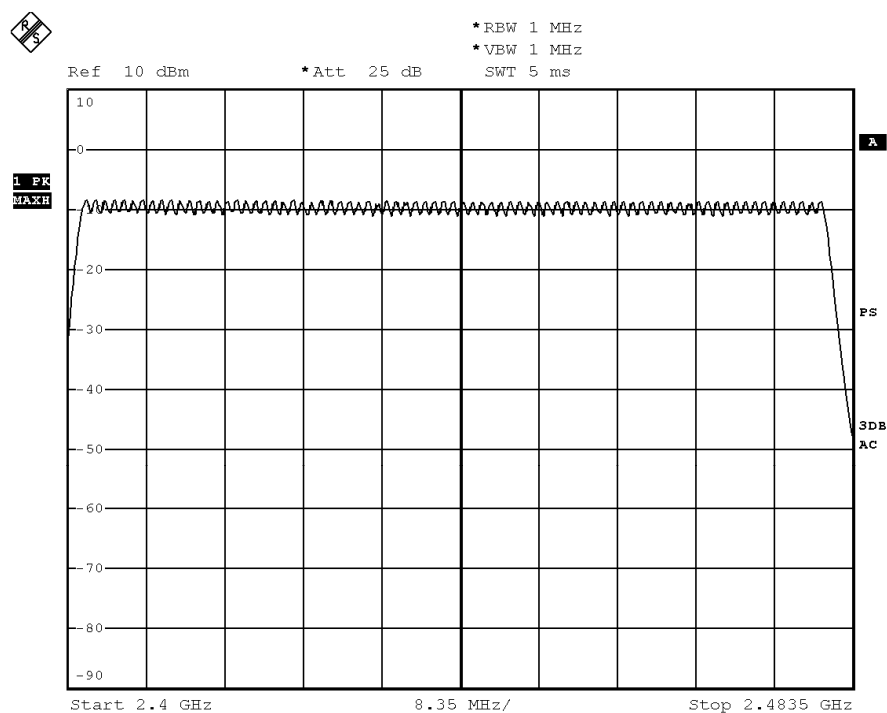

BMP

Date: 18.JUL.2015 13:42:55

### STC (Dongguan) Company Limited

68 Fumin Nan Road, Dalang, Dongguan, China. (Zip Code : 523 770)

Tel : (86 769) 8111 9888 Fax : (86 769) 8111 6222 E-mail : dgstc@dgstc.org Homepage : www.dgstc.org

This report shall not be reproduced unless with prior written approval from STC (Dongguan) Company Limited.  
For Conditions of Issuance of this test report, please refer to the overleaf or Homepage.



# STC Test Report

Date: 2015-08-05

Page 70 of 86

No.: DM120254

## DH5 Packet:

DH5 Packet permit maximum  $1600/79/6 = 3.37$  hops per second in each channel (5 time slots RX, 1 time slot TX). The Dwell time is the time duration of the pulse times  $3.37 \times 31.6 = 106.6$  within 31.6 seconds

**Fig. A**  
**[Pulse duration of Lowest Channel]**

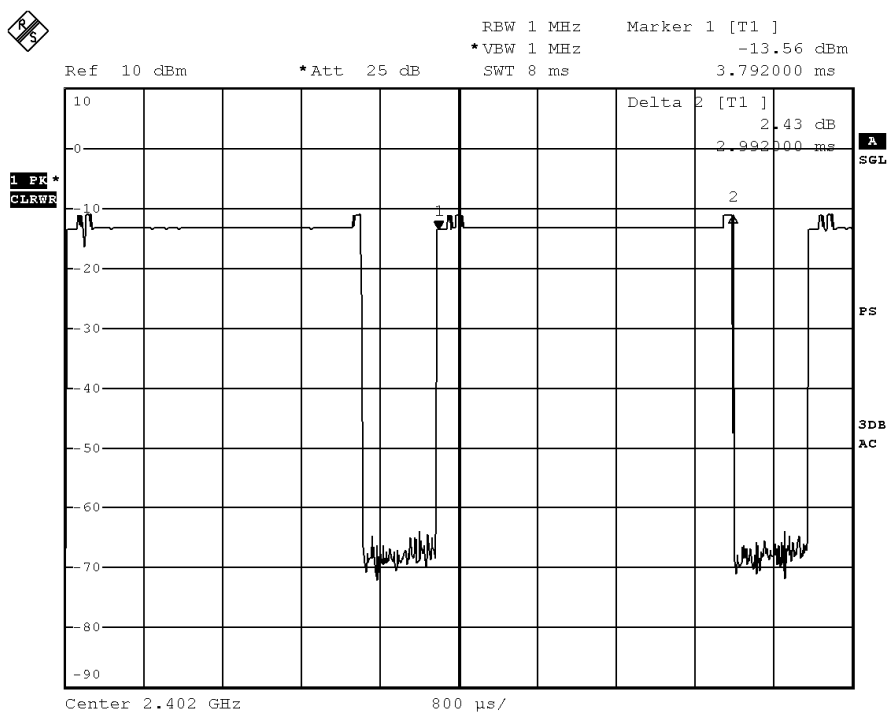

BMP

Date: 18.JUL.2015 14:09:21

## STC (Dongguan) Company Limited

68 Fumin Nan Road, Dalang, Dongguan, China. (Zip Code : 523 770)

Tel : (86 769) 8111 9888 Fax : (86 769) 8111 6222 E-mail : dgstc@dgstc.org Homepage : www.dgstc.org

This report shall not be reproduced unless with prior written approval from STC (Dongguan) Company Limited.  
For Conditions of Issuance of this test report, please refer to the overleaf or Homepage.



## STC Test Report

Date: 2015-08-05

Page 71 of 86

No.: DM120254

**Fig. B**  
**[Pulse duration of Middle Channel]**

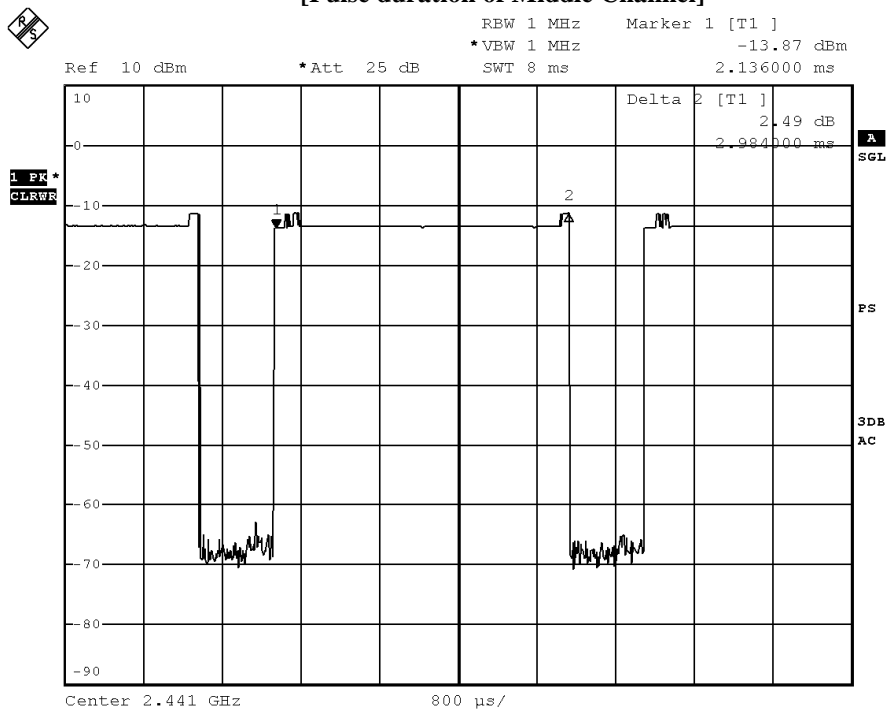

BMP

Date: 18.JUL.2015 14:08:15

### STC (Dongguan) Company Limited

68 Fumin Nan Road, Dalang, Dongguan, China. (Zip Code : 523 770)

Tel : (86 769) 8111 9888 Fax : (86 769) 8111 6222 E-mail : dgstc@dgstc.org Homepage : www.dgstc.org

This report shall not be reproduced unless with prior written approval from STC (Dongguan) Company Limited.  
For Conditions of Issuance of this test report, please refer to the overleaf or Homepage.



# STC Test Report

Date: 2015-08-05

Page 72 of 86

No.: DM120254

### Fig. C [Pulse duration of Highest Channel]

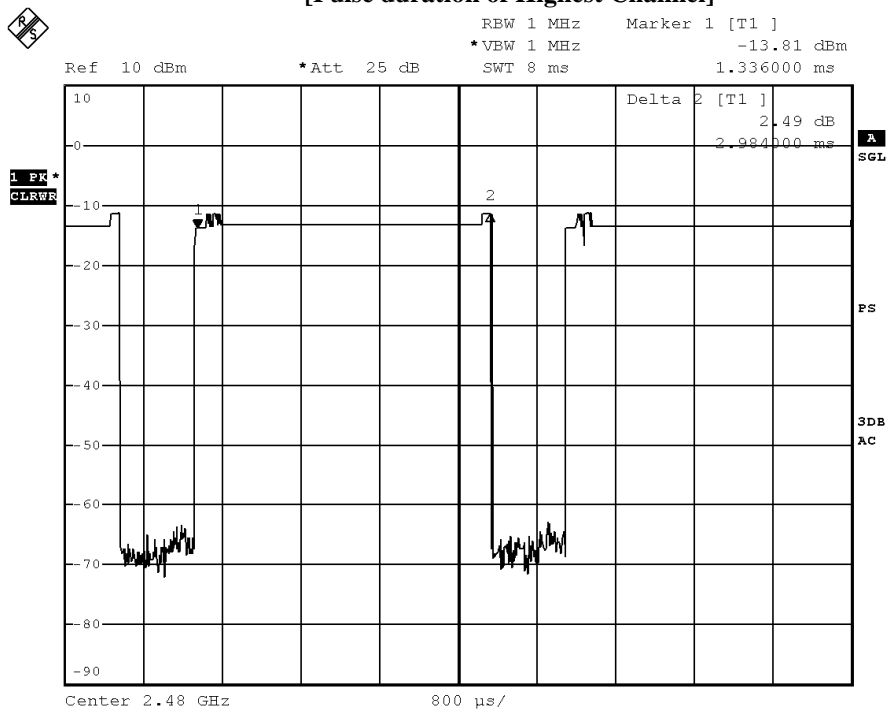

BMP

Date: 18.JUL.2015 14:13:53

## STC (Dongguan) Company Limited

68 Fumin Nan Road, Dalang, Dongguan, China. (Zip Code : 523 770)

Tel : (86 769) 8111 9888 Fax : (86 769) 8111 6222 E-mail : dgstc@dgstc.org Homepage : www.dgstc.org

This report shall not be reproduced unless with prior written approval from STC (Dongguan) Company Limited.  
For Conditions of Issuance of this test report, please refer to the overleaf or Homepage.





## STC Test Report

Date: 2015-08-05

Page 73 of 86

No.: DM120254

### DH3 Packet:

DH3 Packet permit maximum  $1600/79/4 = 5.06$  hops per second in each channel (3 time slots RX, 1 time slot TX). The Dwell time is the time duration of the pulse times  $5.06 \times 31.6 = 160$  within 31.6 seconds

**Fig. D**  
**[Pulse duration of Lowest Channel]**

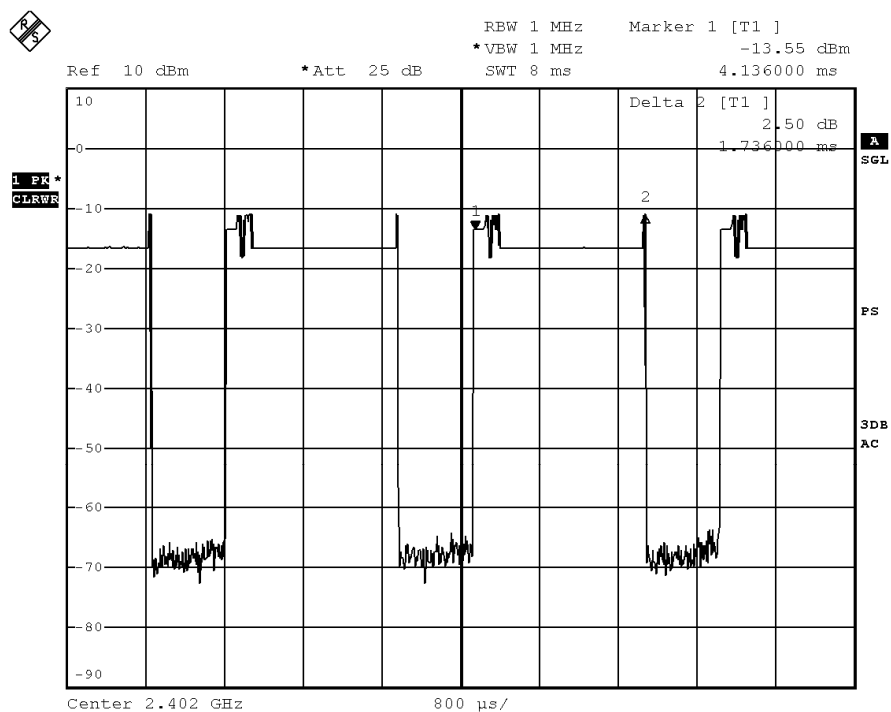

BMP

Date: 18.JUL.2015 14:10:07

### STC (Dongguan) Company Limited

68 Fumin Nan Road, Dalang, Dongguan, China. (Zip Code : 523 770)

Tel : (86 769) 8111 9888 Fax : (86 769) 8111 6222 E-mail : dgstc@dgstc.org Homepage : www.dgstc.org

This report shall not be reproduced unless with prior written approval from STC (Dongguan) Company Limited.  
For Conditions of Issuance of this test report, please refer to the overleaf or Homepage.



## STC Test Report

Date: 2015-08-05

Page 74 of 86

No.: DM120254

**Fig. E**  
**[Pulse duration of Middle Channel]**

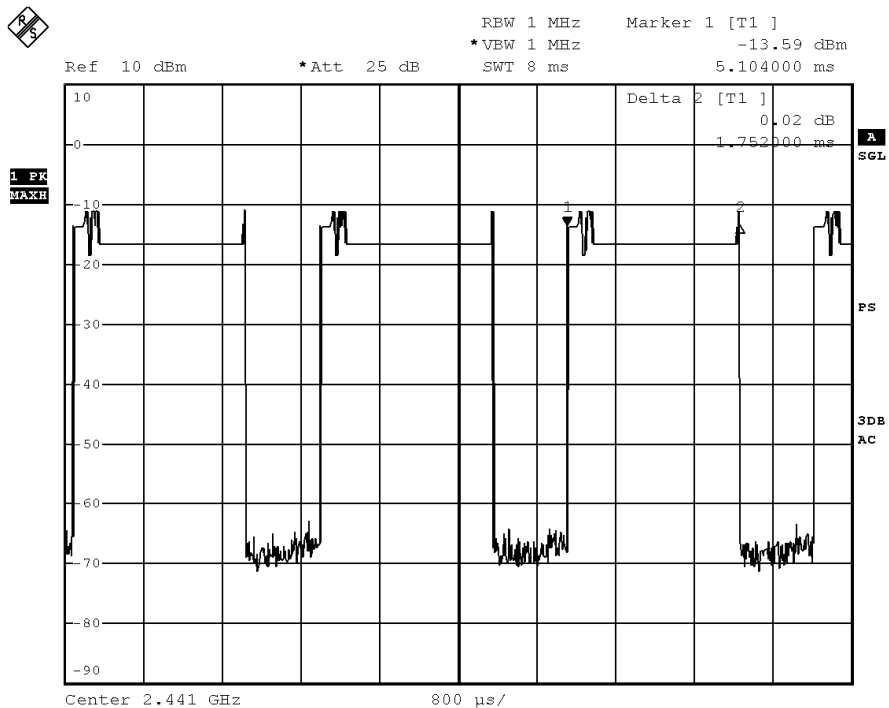

BMP

Date: 18.JUL.2015 13:53:40

### STC (Dongguan) Company Limited

68 Fumin Nan Road, Dalang, Dongguan, China. (Zip Code : 523 770)

Tel : (86 769) 8111 9888 Fax : (86 769) 8111 6222 E-mail : dgstc@dgstc.org Homepage : www.dgstc.org

This report shall not be reproduced unless with prior written approval from STC (Dongguan) Company Limited.  
For Conditions of Issuance of this test report, please refer to the overleaf or Homepage.



# STC Test Report

Date: 2015-08-05

Page 75 of 86

No.: DM120254

### Fig. F [Pulse duration of Highest Channel]

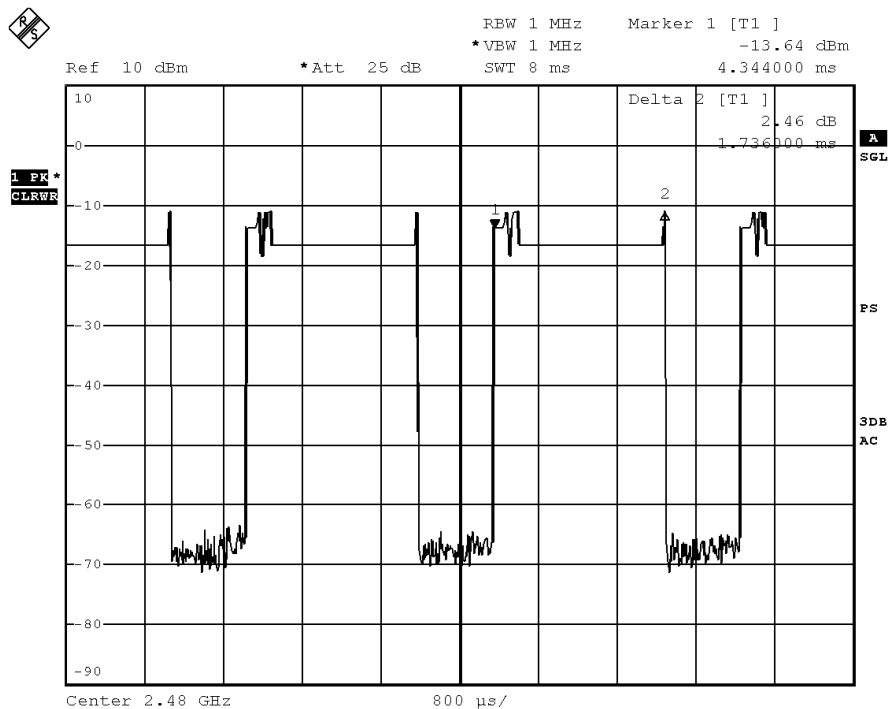

BMP

Date: 18.JUL.2015 14:12:56

## STC (Dongguan) Company Limited

68 Fumin Nan Road, Dalang, Dongguan, China. (Zip Code : 523 770)

Tel : (86 769) 8111 9888 Fax : (86 769) 8111 6222 E-mail : dgstc@dgstc.org Homepage : www.dgstc.org

This report shall not be reproduced unless with prior written approval from STC (Dongguan) Company Limited.  
For Conditions of Issuance of this test report, please refer to the overleaf or Homepage.



# STC Test Report

Date: 2015-08-05

Page 76 of 86

No.: DM120254

### DH1 Packet:

DH1 Packet permit maximum  $1600/79/2 = 10.12$  hops per second in each channel (3 time slots RX, 1 time slot TX). The Dwell time is the time duration of the pulse times  $10.12 \times 31.6 = 320$  within 31.6 seconds

**Fig. G**  
**[Pulse duration of Lowest Channel]**

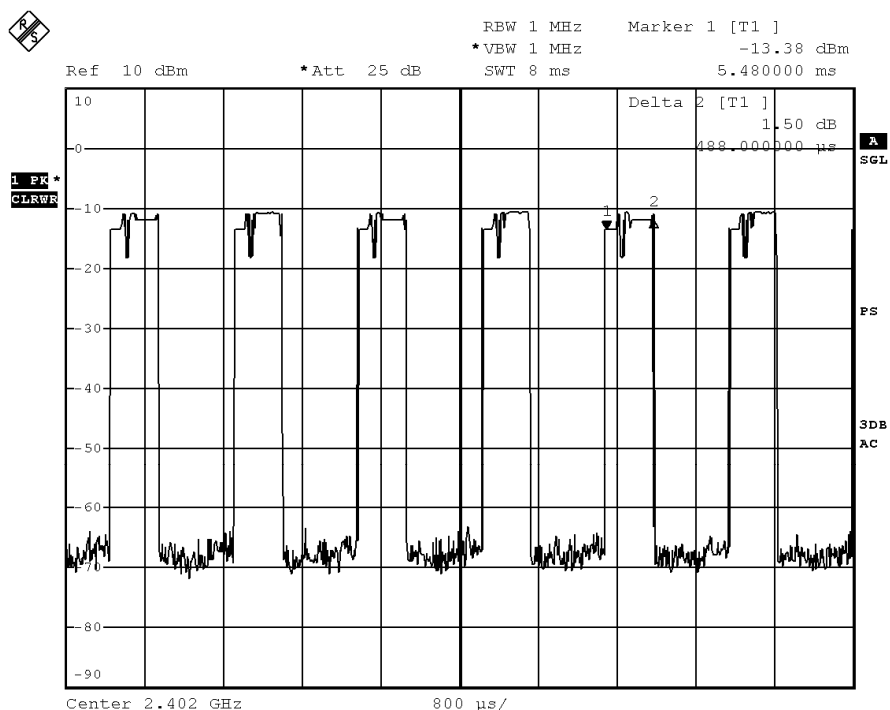

BMP

Date: 18.JUL.2015 14:10:43

## STC (Dongguan) Company Limited

68 Fumin Nan Road, Dalang, Dongguan, China. (Zip Code : 523 770)

Tel : (86 769) 8111 9888 Fax : (86 769) 8111 6222 E-mail : dgstc@dgstc.org Homepage : www.dgstc.org

This report shall not be reproduced unless with prior written approval from STC (Dongguan) Company Limited.  
For Conditions of Issuance of this test report, please refer to the overleaf or Homepage.



## STC Test Report

Date: 2015-08-05

Page 77 of 86

No.: DM120254

**Fig. H**  
**[Pulse duration of Middle Channel]**

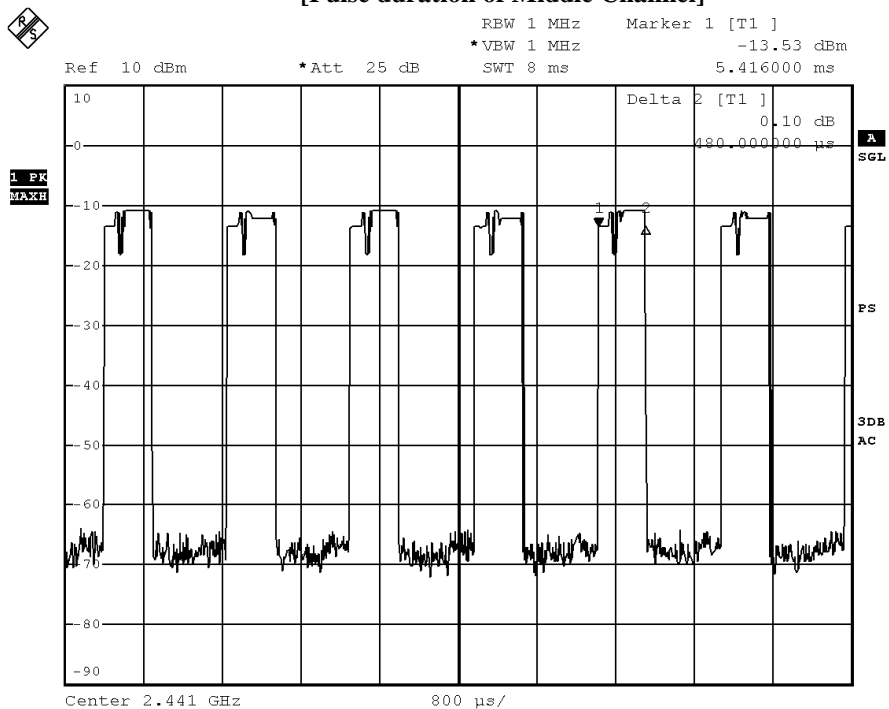

BMP

Date: 18.JUL.2015 13:50:07

### STC (Dongguan) Company Limited

68 Fumin Nan Road, Dalang, Dongguan, China. (Zip Code : 523 770)

Tel : (86 769) 8111 9888 Fax : (86 769) 8111 6222 E-mail : dgstc@dgstc.org Homepage : www.dgstc.org

This report shall not be reproduced unless with prior written approval from STC (Dongguan) Company Limited.  
For Conditions of Issuance of this test report, please refer to the overleaf or Homepage.



## STC Test Report

Date: 2015-08-05

Page 78 of 86

No.: DM120254

**Fig. I**  
**[Pulse duration of Highest Channel]**

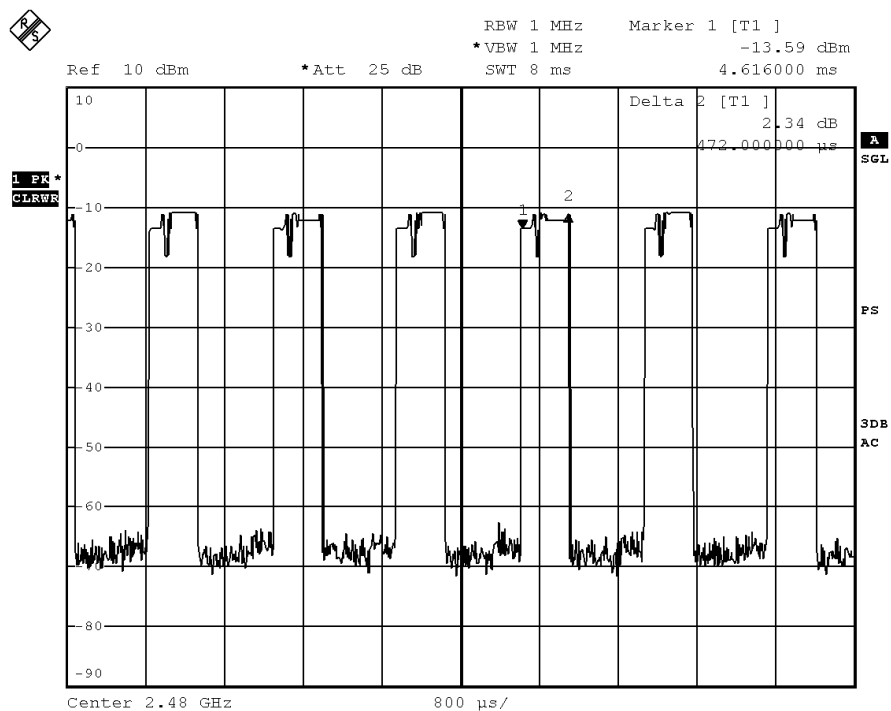

BMP

Date: 18.JUL.2015 14:12:25

**Time of occupancy (Dwell Time):**

Data Packet	Frequency (MHz)	Pulse Duration (ms)	Dwell Time (s)	Limits (s)	Test Results
DH5	2402	2.992	0.284	0.400	Complies
DH5	2441	2.984	0.283	0.400	Complies
DH5	2480	2.984	0.283	0.400	Complies
DH3	2402	1.736	0.274	0.400	Complies
DH3	2441	1.752	0.277	0.400	Complies
DH3	2480	1.736	0.274	0.400	Complies
DH1	2402	0.488	0.154	0.400	Complies
DH1	2441	0.480	0.152	0.400	Complies
DH1	2480	0.472	0.149	0.400	Complies

### STC (Dongguan) Company Limited

68 Fumin Nan Road, Dalang, Dongguan, China. (Zip Code : 523 770)

Tel : (86 769) 8111 9888 Fax : (86 769) 8111 6222 E-mail : dgstc@dgstc.org Homepage : www.dgstc.org

This report shall not be reproduced unless with prior written approval from STC (Dongguan) Company Limited.  
 For Conditions of Issuance of this test report, please refer to the overleaf or Homepage.



## STC Test Report

Date: 2015-08-05

Page 79 of 86

No.: DM120254

### **3.1.9 Channel Centre Frequency**

#### **Requirements:**

Frequency hopping system in the 2400-2483.5MHz band shall use at least 79 (Channel 0 to 78) non-overlapping channels.

The EUT operates in according with the Bluetooth system specification within the 2400 - 2483.5 MHz frequency band.

RF channels for Bluetooth systems are spaced 1 MHz and are ordered in channel number k. In order to comply with out-of-band regulations, a lower frequency guard band of 2.0 MHz and a higher frequency guard band of 3.5MHz is used.

The operating frequencies of each channel are as follows:

First RF channel start from 2400MHz + 2MHz guard band = 2402MHz

Frequency of RF Channel = 2402+k MHz, k = 0,...,78 (Channel separation = 1MHz)

### **STC (Dongguan) Company Limited**

68 Fumin Nan Road, Dalang, Dongguan, China. (Zip Code : 523 770)

Tel : (86 769) 8111 9888 Fax : (86 769) 8111 6222 E-mail : dgstc@dgstc.org Homepage : www.dgstc.org

This report shall not be reproduced unless with prior written approval from STC (Dongguan) Company Limited.  
For Conditions of Issuance of this test report, please refer to the overleaf or Homepage.



## **STC Test Report**

Date: 2015-08-05

Page 80 of 86

No.: DM120254

### **3.1.10 Pseudorandom Hopping Algorithm**

#### **Requirements:**

The channel frequencies shall be selected from a pseudorandom ordered list of hopping frequencies. Each frequency must be used equally by the transmitter.

#### **EUT Pseudorandom Hopping Algorithm**

The EUT is a Bluetooth device, the Pseudo-random hopping pattern; hopping characteristics and algorithm are based on the Bluetooth specification.

### **STC (Dongguan) Company Limited**

68 Fumin Nan Road, Dalang, Dongguan, China. (Zip Code : 523 770)

Tel : (86 769) 8111 9888 Fax : (86 769) 8111 6222 E-mail : dgstc@dgstc.org Homepage : www.dgstc.org

This report shall not be reproduced unless with prior written approval from STC (Dongguan) Company Limited.  
For Conditions of Issuance of this test report, please refer to the overleaf or Homepage.





## **STC Test Report**

Date: 2015-08-05

Page 81 of 86

No.: DM120254

### **3.1.11 Antenna Requirement**

#### **Test Requirements: § 15.203**

#### **Test Specification:**

An intentional radiator shall be designed to ensure that no antenna other than that furnished by the responsible party shall be used with the device. The use of a permanently attached antenna or of an antenna that uses a unique coupling to the intentional radiator shall be considered sufficient to comply with the provisions of this section. The manufacturer may design the unit so that a broken antenna can be replaced by the user, but the use of a standard antenna jack or electrical connector is prohibited.

#### **Test Results:**

This is meander type PCB antenna. There is no external antenna, the antenna gain = 1.9dBi. User is unable to remove or changed the Antenna.

### **STC (Dongguan) Company Limited**

68 Fumin Nan Road, Dalang, Dongguan, China. (Zip Code : 523 770)

Tel : (86 769) 8111 9888 Fax : (86 769) 8111 6222 E-mail : dgstc@dgstc.org Homepage : www.dgstc.org

This report shall not be reproduced unless with prior written approval from STC (Dongguan) Company Limited.  
For Conditions of Issuance of this test report, please refer to the overleaf or Homepage.



## STC Test Report

Date: 2015-08-05

Page 82 of 86

No.: DM120254

### **3.1.12 RF Exposure**

Test Requirement: FCC 47CFR 15.247(i)  
Test Date: 2015-07-22  
Mode of Operation: Tx mode

#### **Requirements:**

In 15.247(i), an equipment shall be operated in a manner that ensures that the public is not exposed to radio frequency energy levels in excess of the limits in §§ 1.1310 and 2.1093 of this chapter. Applications to the Commission for construction permits, licenses to transmit or renewals thereof, equipment authorizations or modifications in existing facilities must contain a statement confirming compliance with the limits unless the facility, operation, or transmitter is categorically excluded, as discussed below. Technical information showing the basis for this statement must be submitted to the Commission upon request.

According to KDB447498 D01 General RF Exposure Guidance v05, unless specifically required by the published RF exposure KDB procedures, standalone 1-g head or body and 10-g extremity SAR evaluation for general population exposure conditions, by measurement or numerical simulation, is not required when the corresponding SAR Exclusion Threshold condition.

#### **Test Results:**

##### **RF Exposure Evaluation**

The Maximum conducted output power = 0.230 mW (at frequency = 2.402 GHz)

**It's Conducted source-based time-averaging output power = 0.210 mW (at frequency = 2.402 GHz)**

**Since the SAR test exclusion thresholds for 2450MHz at test separation distances  $\leq 5$  mm = 10mW and the Conducted source-based time-averaging output power is less than 10mW.**

**Therefore, the SAR evaluation can be exempted.**

### **STC (Dongguan) Company Limited**

68 Fumin Nan Road, Dalang, Dongguan, China. (Zip Code : 523 770)

Tel : (86 769) 8111 9888 Fax : (86 769) 8111 6222 E-mail : dgstc@dgstc.org Homepage : www.dgstc.org

This report shall not be reproduced unless with prior written approval from STC (Dongguan) Company Limited.  
For Conditions of Issuance of this test report, please refer to the overleaf or Homepage.



## STC Test Report

Date: 2015-08-05

Page 83 of 86

No.: DM120254

### Appendix A

#### List of Measurement Equipment

EQP NO.	DESCRIPTION	MANUFACTURER	MODEL NO.	SERIAL NO.	LAST CAL	DUE CAL
EMD004	LISN	ROHDE & SCHWARZ	ESH3-Z5	100102	2015.3.24	2016.3.24
EMD022	EMI Test Receiver	ROHDE & SCHWARZ	ESCS30	100314	2015.3.24	2016.3.24
EMD035	EMI Test Receiver	ROHDE & SCHWARZ	ESCI	100441	2014.06.10	2015.06.10
EMD036	EMI Test Receiver	ROHDE & SCHWARZ	ESIB 26	100388	2014.06.10	2015.06.10
EMD041	TWO-LINE V-NETWORK	ROHDE & SCHWARZ	ENV216	100261	2015.3.24	2016.3.24
EMD061	Biconilog Antenna	ETS.LINDGREN	3142C	00060439	2014.11.29	2016.11.29
EMD062	Double-Ridged Waveguide (1GHz – 18GHz)	ETS.LINDGREN	3117	00075933	2014.11.15	2015.11.15
EMD084	MULTI-DVICE CONTROLLER	ETS.LINDGREN	2090	00060107	N/A	N/A
EMD088	Video Contol Unit	ETS.LINDGREN	Y21953A	2601073	N/A	N/A
EMD093	Monitor	ViewSonic	VA9036	Q8X064201876	N/A	N/A
EMD102	Intelligent Frequency	Ainuo Instrument Co., Ltd	AN97005SS	79707454	N/A	N/A
EMD103	Intelligent Frequency	Ainuo Instrument Co., Ltd	AN97005SS	79707455	N/A	N/A
EMD105	FACT-3 EMC Chamber	ETS.LINDGREN	FACT-3	3803	N/A	N/A
EMD106	Shielding Room #1	ETS.LINDGREN	RFD-100	3802	N/A	N/A
EMD111	Power meter	ROHDE & SCHWARZ	NRVD	102051	2015.3.24	2016.3.24
	100V Insertion Unit	ROHDE & SCHWARZ	URV5-Z4	100464	2015.3.24	2016.3.24
EMD113	Pre-Amplifier	ROHDE & SCHWARZ	N/A	1129588	2015.3.24	2016.3.24
EMD124	Loop Antenna	ETS-Lindgren	6502	00104905	2014.04.28	2016.04.28
EMD131	Standard Gain Horn Antenna (18GHz – 26.5GHz)	Chengdu AINFO Inc.	JXTXLB-42-15-C-KF	J2021100721001	2015.04.09	2017.04.09
RE01	RF cable	N/A	N/A	N/A	2014-9-28	2015-9-27
RE02	RF cable	N/A	N/A	N/A	2014-9-28	2015-9-27

Remarks:-

N/A Not Applicable or Not Available

### Appendix B

#### Ancillary Equipment

ITEM NO.	DESCRIPTION	MODEL NO.	FCC ID	REMARK
1	DELL COMPUTER	DMC	N/A	N/A

## STC (Dongguan) Company Limited

68 Fumin Nan Road, Dalang, Dongguan, China. (Zip Code : 523 770)

Tel : (86 769) 8111 9888 Fax : (86 769) 8111 6222 E-mail : dgstc@dgstc.org Homepage : www.dgstc.org

This report shall not be reproduced unless with prior written approval from STC (Dongguan) Company Limited.

For Conditions of Issuance of this test report, please refer to the overleaf or Homepage.



## STC Test Report

Date: 2015-08-05

Page 84 of 86

No.: DM120254

### Appendix C

#### Photographs of EUT

**Front View of the product**



**Rear View of the product**



**Inside View of the product**



**Inner Circuit Top View**



**Inner Circuit Bottom View**



**Battery View of the product**



### STC (Dongguan) Company Limited

68 Fumin Nan Road, Dalang, Dongguan, China. (Zip Code : 523 770)

Tel : (86 769) 8111 9888 Fax : (86 769) 8111 6222 E-mail : dgstc@dgstc.org Homepage : www.dgstc.org

This report shall not be reproduced unless with prior written approval from STC (Dongguan) Company Limited.  
For Conditions of Issuance of this test report, please refer to the overleaf or Homepage.



## **STC Test Report**

Date: 2015-08-05

Page 85 of 86

No.: DM120254

### **Photographs of EUT**

**Measurement of Radiated Emission Test Set Up**

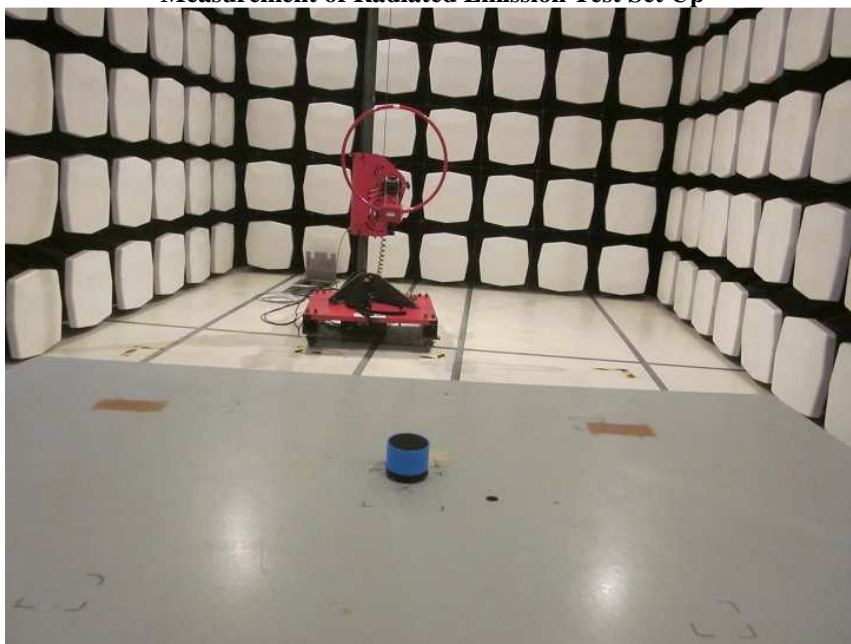

**Measurement of Radiated Emission Test Set Up**

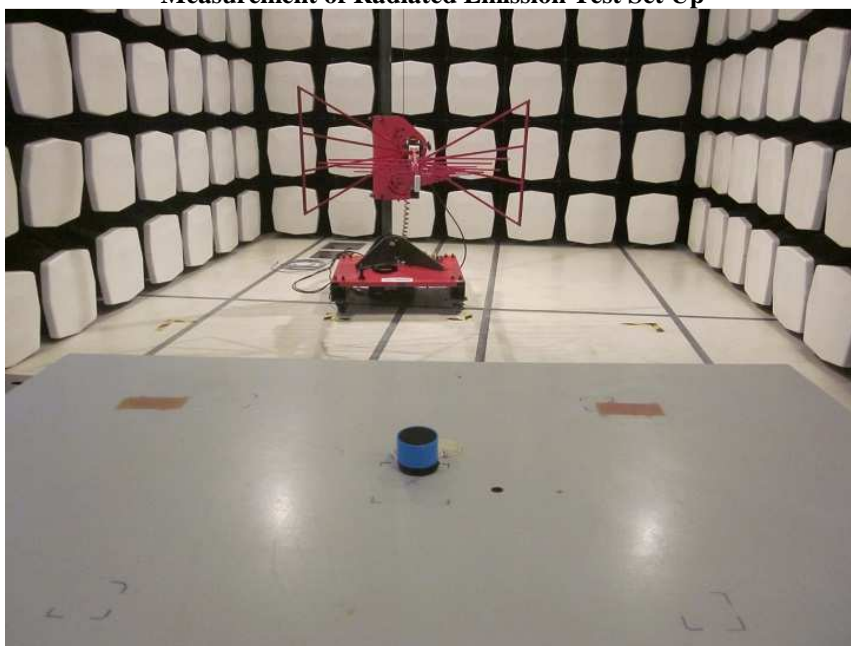

### **STC (Dongguan) Company Limited**

68 Fumin Nan Road, Dalang, Dongguan, China. (Zip Code : 523 770)

Tel : (86 769) 8111 9888 Fax : (86 769) 8111 6222 E-mail : [dgstc@dgstc.org](mailto:dgstc@dgstc.org) Homepage : [www.dgstc.org](http://www.dgstc.org)

This report shall not be reproduced unless with prior written approval from STC (Dongguan) Company Limited.  
For Conditions of Issuance of this test report, please refer to the overleaf or Homepage.





## STC Test Report

Date: 2015-08-05

Page 86 of 86

No.: DM120254

### Photographs of EUT

**Measurement of Radiated Emission Test Set Up**

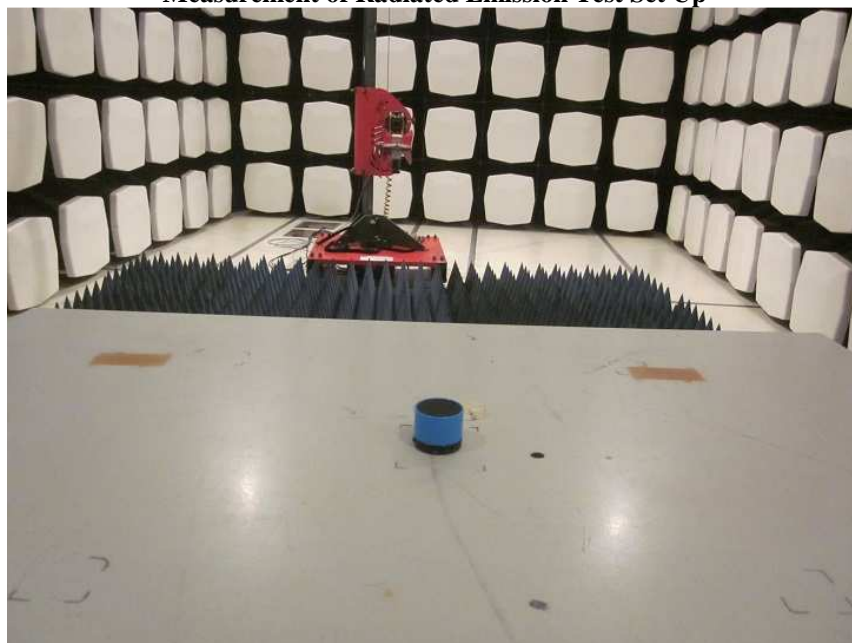

**Measurement of Conducted Emission Test Set Up**



\*\*\*\*\* End of Test Report \*\*\*\*\*

### **STC (Dongguan) Company Limited**

68 Fumin Nan Road, Dalang, Dongguan, China. (Zip Code : 523 770)

Tel : (86 769) 8111 9888 Fax : (86 769) 8111 6222 E-mail : dgstc@dgstc.org Homepage : www.dgstc.org

This report shall not be reproduced unless with prior written approval from STC (Dongguan) Company Limited.  
For Conditions of Issuance of this test report, please refer to the overleaf or Homepage.