

Test Report for FCC

FCC ID : 2AD5K-C8723RHPSH

Report Number		ESTRFC2001-001		
Applicant	Company name	PARTRON CO., LTD		
	Address	22, Samsung 1-ro 2-gil, Hwaseong-si, Gyeonggi-do, Republic of Korea		
	Telephone	+82-31-371-1583		
	Contact person	Jong Koo Kim		
Product	Product name	Wlan module		
	Model No.	C8723RHPS-H	Manufacturer	PARTRON CO., LTD
	Serial No.	None	Country of origin	Vietnam
Test date	15-Oct-19 ~ 29-Nov-19		Date of issue	16-Jan-20
Testing location	347-69, Jungbu-daero 147beon-gil, Majang-myeon, Icheon-si, Gyeonggi-do 467-811, R. O. Korea			
Standard	FCC PART 15 Subpart C (15.247) , ANSI C 63.10(2013) , KDB 558074 D01v05r02			
Measurement facility registration number		659627		
Tested by	Asst Manager Y.M. Won		(Signature)	
Reviewed by	Engineering Manager I.K. Hong		(Signature)	
Abbreviation	OK, Pass = Passed, Fail = Failed, N/A = not applicable			
<p>* Note</p> <ul style="list-style-type: none"> - This test report is not permitted to copy partly without our permission - This test result is dependent on only equipment to be used - This test result based on a single evaluation of one sample of the above mentioned 				

Contents

1. Laboratory Information	3
2. Description of EUT	4
3. Test Standards	5
4. Measurement condition	6
5. DTS bandwidth	10
5.1 Test procedure	10
5.2 Test instruments and measurement setup	10
5.3 Measurement results	10
5.4 Trace data	11
6. Maximum Peak Output Power	15
6.1 Test procedure	15
6.2 Measurement results	15
7. Maximum conducted (average) output power	16
7.1 Test procedure	16
7.2 Measurement results	16
8. Maximum power spectral density level in the fundamental emission	17
8.1 Test procedure	17
8.2 Test instruments and measurement setup	17
8.3 Measurement results	17
8.4 Trace data	18
9. Emissions in non-restricted frequency bands	22
9.1 Test procedure	22
9.2 Test instruments and measurement setup	22
9.3 Measurement results	22
9.4 Trace data of band-edge & out of emissioin	23
10. Measurement of radiated emission	29
10.1 Measurement equipment	29
10.2 Environmental conditions	29
10.3 Measurement Instrument setting for Radiated Emission	30
10.4 Test Data.....	31
10.5 Restricted Band Edges	39
11. Measurement of conducted emission	47
11.1 Measurement equipment	47
11.2 Environmental conditions	47
11.3 Test Data.....	48

Appendix 1. Special diagram

Appendix 2. Antenna Requirement

1. Laboratory Information

1.1 General

This EUT (Equipment Under Test) has been shown to be capable of compliance with the applicable technical standards and is tested in accordance with the measurement procedures as indicated in this report.

ESTECH Lab attests to accuracy of test data. All measurement reported herein were performed by ESTECH Co., Ltd.

ESTECH Lab assume full responsibility for the completeness of these measurements and vouch for the qualifications of all persons taking them.

1.2 Test Lab.

Corporation Name : ESTECH Co., Ltd.

Head Office : Suite 1015 World Meridian II, 123 Gasan Digital 2-ro, Geumcheon-gu, Seoul 153-759, R. O. Korea

EMC/Telecom/Safety Test Lab : 347-69, Jungbu-daero 147beon-gil, Majang-myeon, Icheon-si,
Gyeonggi-do 467-811, R. O. Korea

1.3 Official Qualification(s)

MSIP : Granted Accreditation from Ministry of Information & Communication for EMC, Safety and Telecommunication

KOLAS : Accredited Lab By Korea Laboratory Accreditation Schema base on CENELEC requirements

FCC : Conformity Assessment Body(CAB) with registration number 659627 under APEC TEL MRA between the RRA and the FCC

VCCI : Granted Accreditation from Voluntary Control Council for Interference from ITE

2. Description of EUT

2.1 Summary of Equipment Under Test

Modulation Type	:	CCK, OFDM
Transfer Rate	:	11 Mbps , 54 Mbps
Number of Channel	:	11 ch
PEAK Output Power	:	15.18 dBm
Rating	:	Test Zig 5.0 V
Receipt Date	:	16-Aug-19
Testing Voltage	:	DC 5 V
X-tal list(s) or Frequencies generated	:	The highest operating frequency is 2 462 MHz

2.2 General descriptions of EUT

External Inputs	DC 3.3 V, 1 A
Wireless network	2.4 GHz, 802.11 b/g
Operating temperature	0 ~ +70℃
Features	<ol style="list-style-type: none"> 1. IEEE 802.11 single spatial stream 2.4GHz up to 54Mbps 2. Support for IEEE 802.11 b/g 3. Complies with SDIO 1.1 / 2.0 / 3.0 for WLAN with clock rate up to 100MHz 4. Support for IEEE 802.11e Qos Enhancement (WMM) 5. Support for 802.11i (WPA, WPA2). Open, shared key, and pair-wise key authentication services 6. Support for 20 MHz bandwidth transmission

3. Test Standards

Test Standard : FCC PART 15 Subpart C (15.247)

This Standard sets out the regulations under which an intentional, unintentional, or incidental radiator may be operated without an individual license. It also contains the technical specifications, administrative requirements and other conditions relating to the marketing of Part 15 devices.

Test Method : ANSI C 63.10 (2013) & KDB558074 D01v05r02

This standard sets forth uniform methods of measurement of radio-frequency (RF) signals and noise emitted from both unintentional and intentional emitters of RF energy in the frequency range 9 kHz to 40 GHz. Methods for the measurement of radiated and AC power-line conducted radio noise are covered and may be applied to any such equipment unless otherwise specified by individual equipment requirements. These methods cover measurement of certain devices that deliberately radiate energy, such as intentional emitters, but does not cover licensed transmitters. This standard is not intended for certification/approval of avionic equipment or for industrial, scientific, and medical (ISM) equipment. These methods apply to the measurement of individual units or systems.

Summary of Test Results

Applied Standard : 47 CFR Part 15 Subpart C				remark
Standard	Test Type	Result	Remark	Limit
15.207	AC Power Conducted Emission	Pass	Meet the requirement	
15.205 & 15.209	Restricted band / Intentional Radiated Emission	Pass	Meet the requirement	
15.247(a)(2)	6 dB Bandwidth	Pass	Meet the requirement	Min. 500 kHz
	99 % Bandwidth			
15.247(b)(3)	Maximum Peak/average output power	Pass	Meet the requirement	Max. 30 dBm
15.247(c)	Transmitter Radiated Emission	Pass	Meet the requirement	Table 15.209
15.247(e)	Power Spectral Density	Pass	Meet the requirement	Max. 8 dBm
15.247(d)	Band Edge Measurement	Pass	Meet the requirement	20 dB less

4. Measurement Condition

4.1 EUT Operation

a. Channel

Ch.	Frequency	Ch.	Frequency
1	2 412 MHz	7	2 442 MHz
2	2 417 MHz	8	2 447 MHz
3	2 422 MHz	9	2 452 MHz
4	2 427 MHz	10	2 457 MHz
5	2 432 MHz	11	2 462 MHz
6	2 437 MHz		

b. Measurement Channel : WLAN : Low(2 412 MHz), Middle(2 437 MHz), High(2 462 MHz)

c. Test Mode : Continuous Output, CCK, OFDM

d. Test rate : 11 Mbps, 54 Mbps

4.2 EUT Operation

- The EUT was in the following operation mode during all testing
 - * Wireless LAN 2.4 GHz operation check
 - * Transmit mode were measured each channels(802.11b, 802.11g)

4.3 Configuration and Peripherals

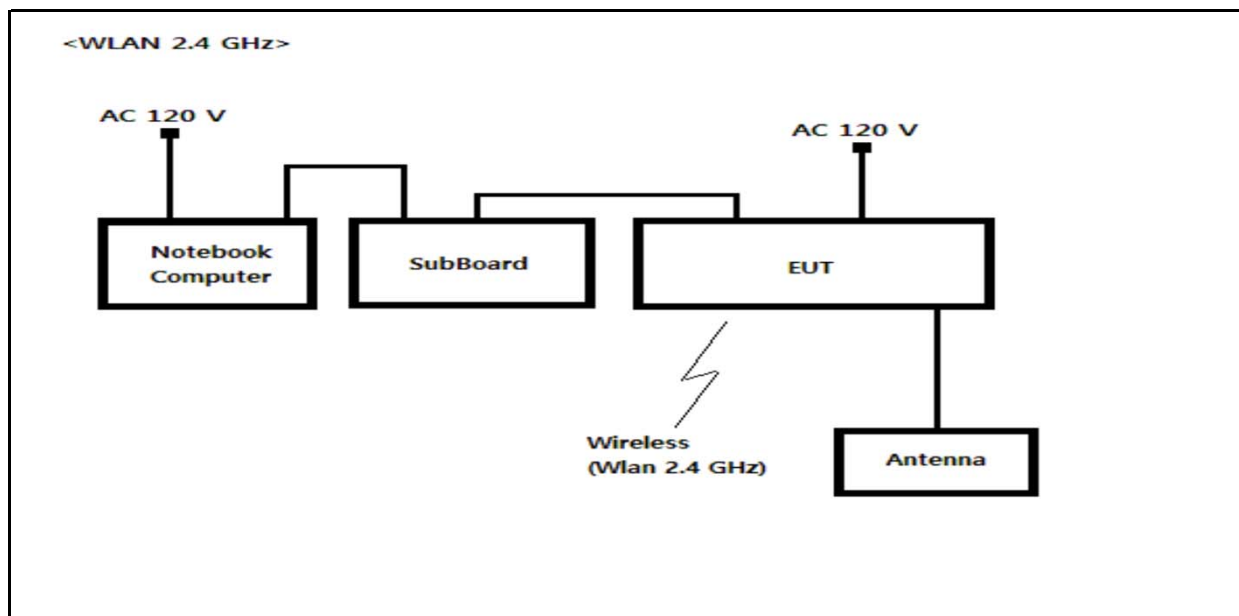

4.4 EUT and Support equipment

Equipment Name	Model Name	S/N	Manufacturer	Remark (FCC ID)
Wlan module	C8723RHPS-H	NONE	PARTRON CO., LTD	EUT
Adapter	KSAC0500200W1KO	NONE	Ktec	
Notebook Computer		NONE	lenovo	
Adapter	ADLX90NCC3A	NONE	lenovo	
ANT	HPW24	NONE	HUTEC	

4.5 Cable Connecting

Start Equipment		End Equipment		Cable Standard		Remark
Name	I/O port	Name	I/O port	Length	Shielded	
Wlan module	Power	Adapter	-	2	Unshielded	
Wlan module	WIRELESS (2.4 GHz)	ANT	-	0.1	Unshielded	
SUBBOARD	LINE	Notebook Computer	USB	1	shielded	
Notebook Computer	Power	Adapter	-	2	Unshielded	

4.6 DUTY CYCLE OF TEST SIGNAL

Duty cycle is > 98 %, duty factor shall be considered.

802.11b

duty cycle = 90.5% , duty factor = $10 \cdot \log(1/0.905594) = 0.430$

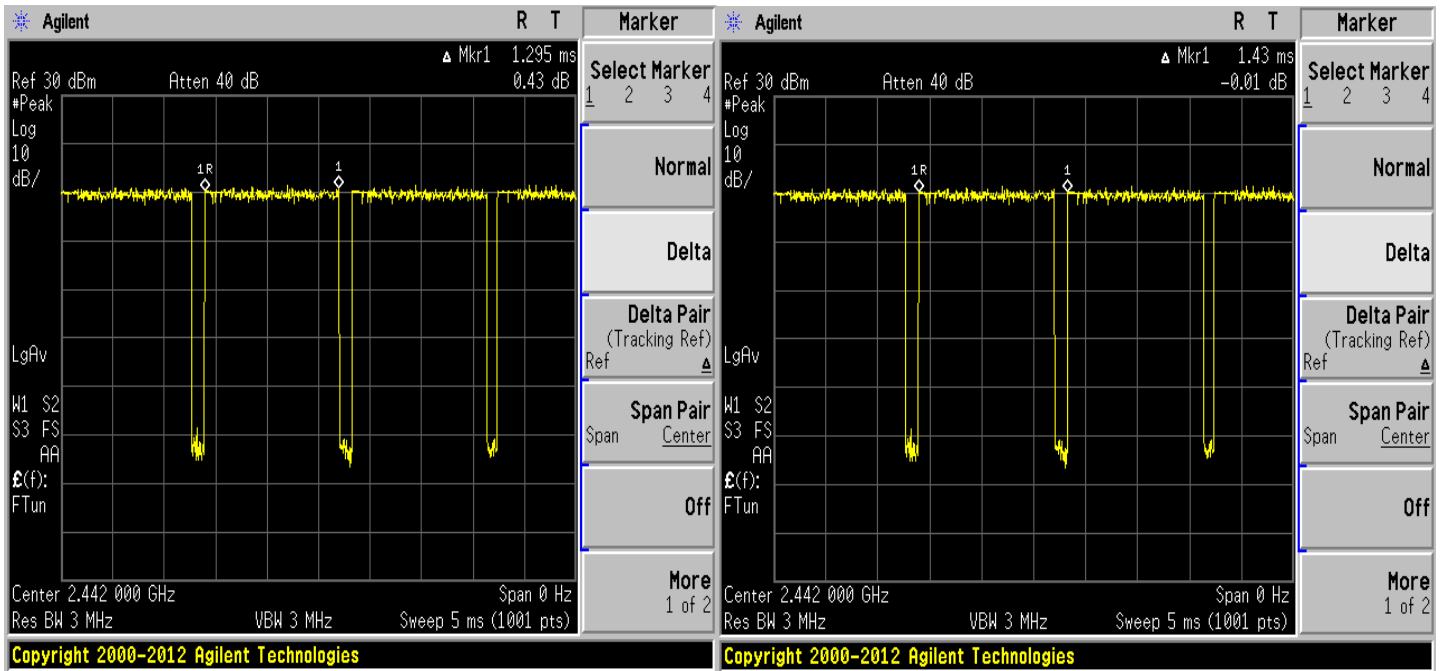

802.11g

duty cycle = 21.6% , duty factor = $10 \cdot \log(1/0.216) = 6.575$

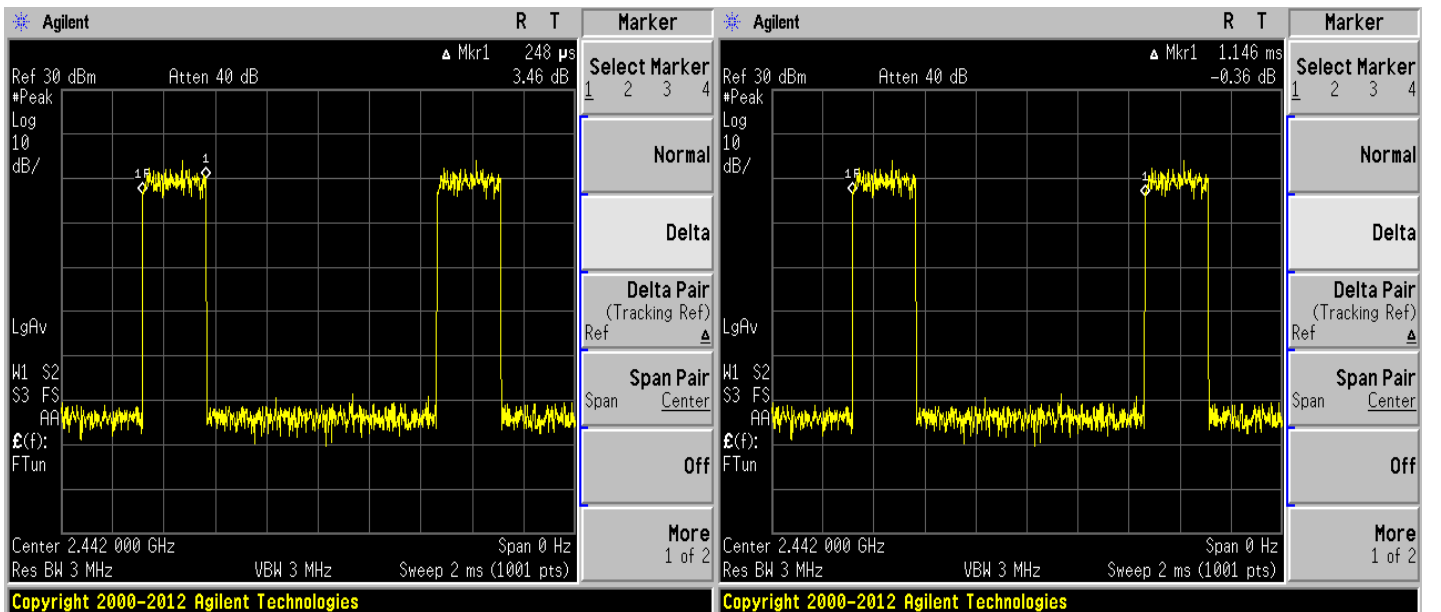

5. DTS bandwidth

5.1 Test procedure

558074 D01 DTS Meas Guidance v05 8.2 Option 2 :The automatic bandwidth measurement capability of an instrument may be employed using the X dB bandwidth mode with X set to 6 dB, if the functionality described above (i.e., RBW = 100 kHz, VBW ≥ 3 x RBW, peak detector with maximum hold) is implemented by the instrumentation function. When using this capability, care shall be taken so that the bandwidth measurement is not influenced by any intermediate power nulls in the fundamental emission that might be ≥ 6 dB.

5.2 might be > 6 dB Test instruments and measurement setup

The spectrum analyzer is set to as following.

- . RBW= 100 KHz . VBW≥ 3 x RBW
- . Span= 50 MHz . Sweep= suitable duration based on the EUT specification.

Limits : FCC § 15.247(a)(2)

6dB Bandwidth Test Instruments

Description	Model	Serial Number	Cal. Due Date
Spectrum Analyzer	E4440A	US41421291	2-Dec-20
RF Cable	Length: 30 cm	-	
-Spectrum Analyzer <=> EUT	Loss: 1.0 dB	-	

5.3 Measurement results

EUT	Wlan module	MODEL	C8723RHPS-H
MODE	802.11b, g	ENVIRONMENTAL CONDITION	23.0 °C, 47.0 % R.H.
INPUT POWER	DC 5.0 V		

MODE – 802.11b

Channel Frequency (MHz)	Emission bandwidth (MHz)	Bandwidth at 6dB below(MHz)	Minimum Limit (MHz)	PASS/FAIL
2 412	15.02	8.48	0.5	PASS
2 437	14.89	10.17	0.5	PASS
2 462	15.05	8.99	0.5	PASS

MODE – 802.11g

Channel Frequency (MHz)	Emission bandwidth (MHz)	Bandwidth at 6dB below(MHz)	Minimum Limit (MHz)	PASS/FAIL
2 412	16.42	16.36	0.5	PASS
2 437	16.43	16.43	0.5	PASS
2 462	16.48	16.46	0.5	PASS

5.4 Trace data – 802.11b
(ch_1)

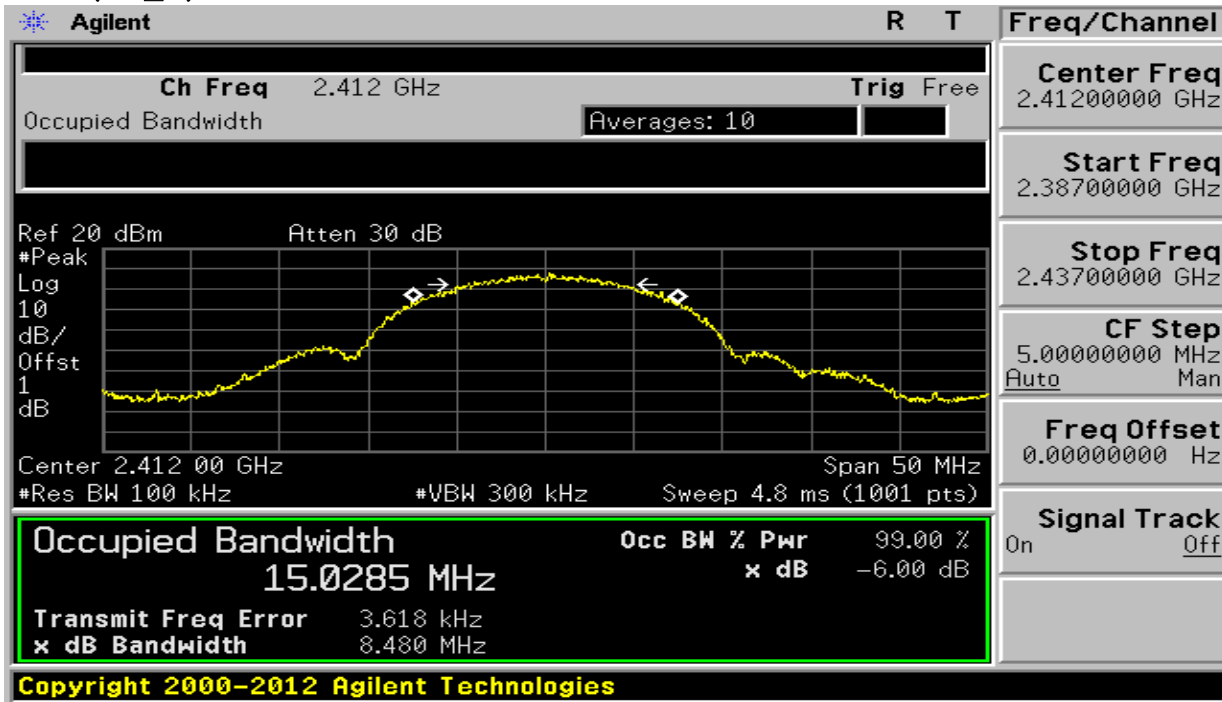

(ch_6)

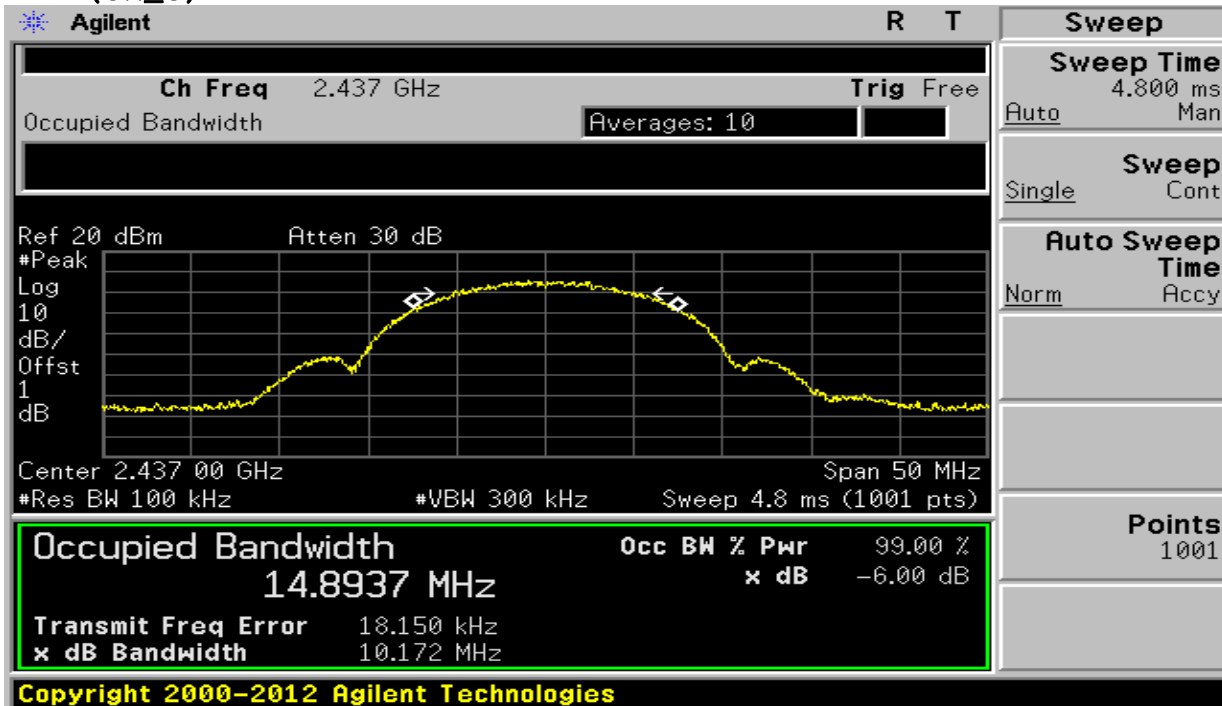

(ch_11)

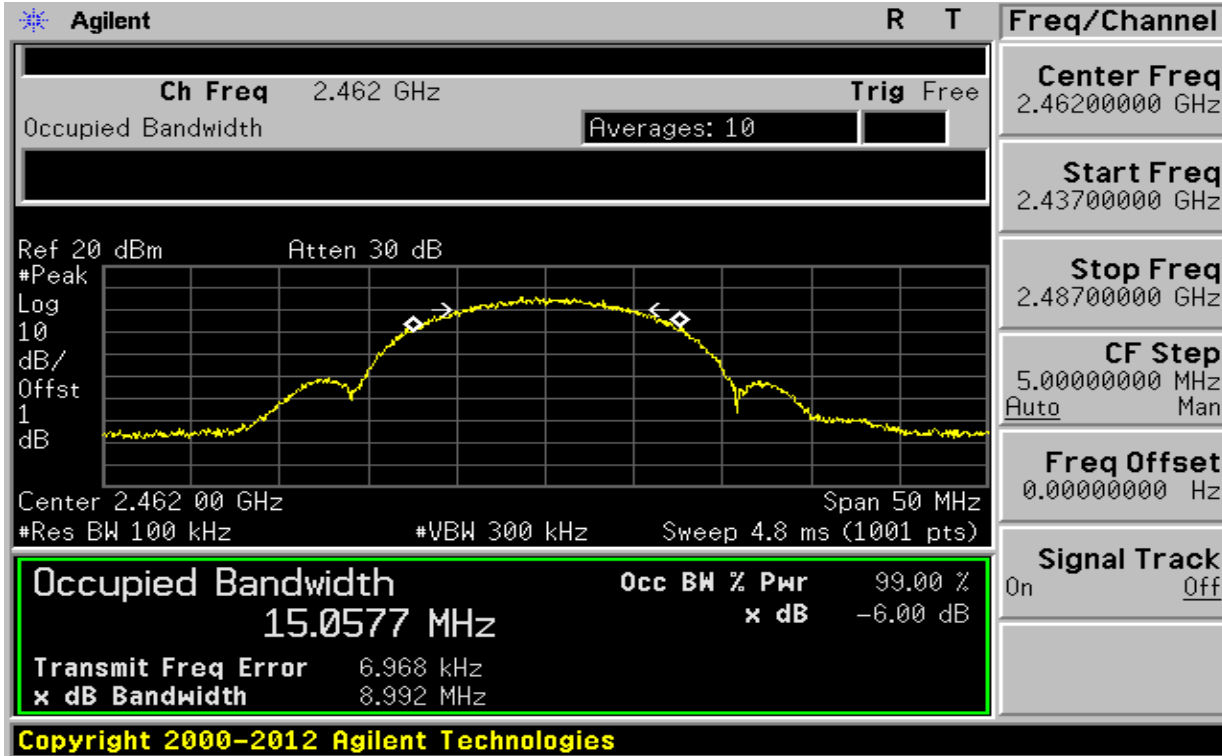

5.4 Trace data – 802.11g
(ch_1)

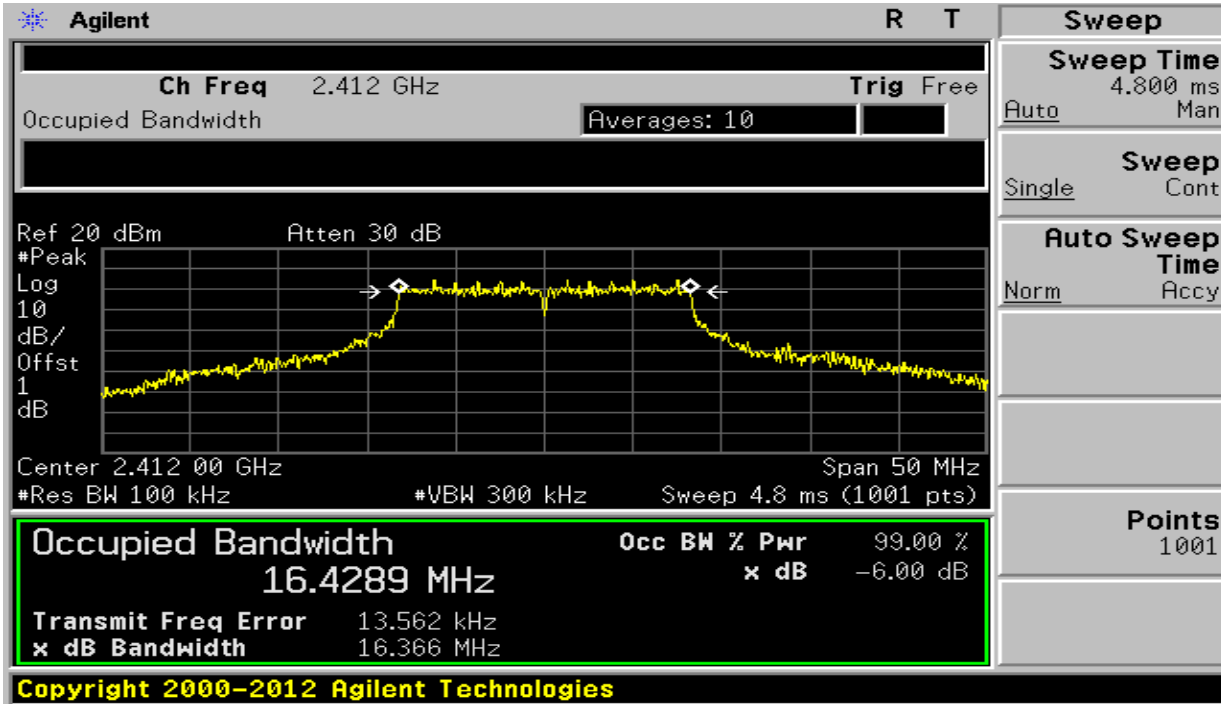

(ch_6)

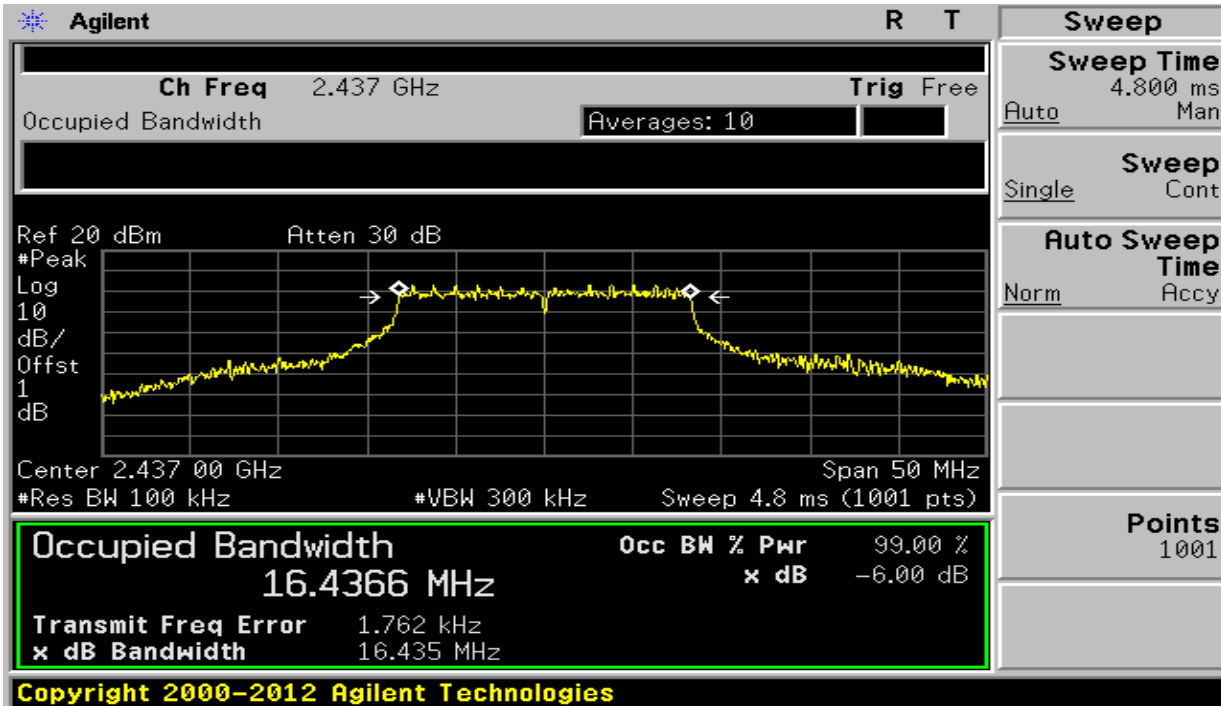

(ch_11)

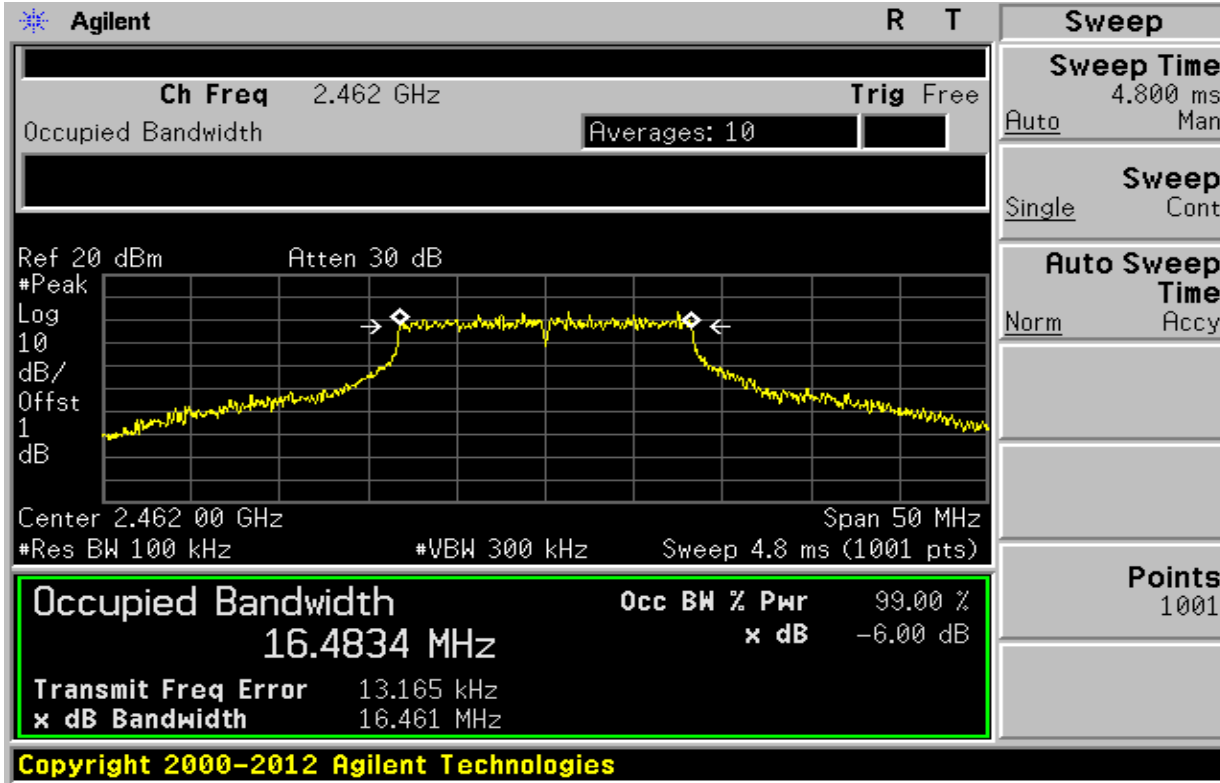

6. Maximum peak conducted output power

6.1 Test procedure

The transmitter antenna terminal is connected to the input of a Power Sensor. Measurement is made while EUT is operating in transmission mode at the appropriate center frequency. The maximum peak output power measurement is 30 dBm.

Maximum Peak Output Power Test Instruments

Description	Model	Serial Number	Cal. Due Date
Power Meter	N1912A	MY45100570	2020-12-02
Power Sensor	A1921A	MY45240427	2020-12-02
Power Meter <=> EUT	Loss: 1 dB	-	

6.2 Measurement results

EUT	Wlan module	MODEL	C8723RHPS-H
MODE	802.11b, g	ENVIRONMENTAL CONDITION	23.3 °C, 46.9 % R.H.
INPUT POWER	DC 5.0 V		

MODE – 802.11b

CHANNEL	Channel frequency (MHz)	Conducted Power Output(dBm)			Limit[1W] (dBm)	PASS/FAIL
		Detector	(dBm)	(W)		
1	2 412	PEAK	15.18	0.0330	30.0	PASS
6	2 437	PEAK	13.82	0.0241	30.0	PASS
11	2 462	PEAK	13.50	0.0224	30.0	PASS

MODE – 802.11g

CHANNEL	Channel frequency (MHz)	Conducted Power Output(dBm)			Limit[1W] (dBm)	PASS/FAIL
		Detector	(dBm)	(W)		
1	2 412	PEAK	12.77	0.0189	30.0	PASS
6	2 437	PEAK	12.17	0.0165	30.0	PASS
11	2 462	PEAK	11.84	0.0153	30.0	PASS

7. Maximum conducted (average) output power

7.1 Test procedure

The transmitter antenna terminal is connected to the input of a Power Sensor. Measurement is made while EUT is operating in transmission mode at the appropriate center frequency. The maximum Average output power measurement is 30 dBm.

Maximum conducted (average) output power Test Instruments

Description	Model	Serial Number	Cal. Due Date
Power Meter	N1912A	MY45100570	2020-12-02
Power Sensor	A1921A	MY45240427	2020-12-02
Power Meter <=> EUT	Loss: 1 dB	-	

7.2 Measurement results

EUT	Wlan module	MODEL	C8723RHPS-H
MODE	802.11b, g	ENVIRONMENTAL CONDITION	23.0 °C, 47.0 % R.H.
INPUT POWER	DC 5.0 V		

MODE – 802.11b

CHANNEL	Channel frequency (MHz)	Conducted Power Output(dBm)			Measured + Duty Cycle(dBm)	Measured + Duty Cycle(W)
		Detector	(dBm)	Duty Cycle		
1	2 412	AVG	6.45	0.43	6.88	0.0049
6	2 437	AVG	5.51	0.43	5.94	0.0039
11	2 462	AVG	5.80	0.43	6.23	0.0042

MODE – 802.11g

CHANNEL	Channel frequency (MHz)	Conducted Power Output(dBm)			Measured + Duty Cycle(dBm)	Measured + Duty Cycle(W)
		Detector	(dBm)	Duty Cycle		
1	2 412	AVG	4.39	6.58	10.96	0.0125
6	2 437	AVG	3.67	6.58	10.25	0.0106
11	2 462	AVG	3.65	6.58	10.23	0.0105

8. Maximum power spectral density level in the fundamental emission

8.1 Test procedure

KDB 558074 D01v05r02 DTS Meas Guidance V05 10.2 Method PKPSD (peak PSD)

8.2 Test instruments and measurement setup

The spectrum analyzer is set to as following.

- a) Set analyzer center frequency to DTS channel center frequency.
- b) Set the span to 1.5 times the DTS bandwidth.
- c) Set the RBW to: $3 \text{ kHz} \leq \text{RBW} \leq 100 \text{ kHz}$.
- d) Set the VBW $\geq 3 \times \text{RBW}$.
- e) Detector = peak.
- f) Sweep time = auto couple.
- g) Trace mode = max hold.
- h) Allow trace to fully stabilize.
- i) Use the peak marker function to determine the maximum amplitude level within the RBW.
- j) If measured value exceeds limit, reduce RBW (no less than 3 kHz) and repeat.

Limits FCC § 15.247

The peak power density Test Instruments

Description	Model	Serial Number	Cal. Due Date
Spectrum Analyzer	E440A	US41421291	2-Dec-20
RF Cable	Length: 30 cm	-	
Spectrum Analyzer <=> EUT	Loss: 1.0 dB	-	

8.3 Measurement results

EUT	Wlan module	MODEL	C8723RHPS-H
MODE	802.11b, g	ENVIRONMENTAL CONDITION	22.0 °C, 47.0 % R.H.
INPUT POWER	DC 5.0 V		

MODE – 802.11b

CHANNEL	Channel Frequency (MHz)	Measured Power Spectral Density (dBm)	Maximum Permissible Power Density (dBm/3kHz)	Margin
1	2 412	-2.83	8.00	10.83
6	2 437	-3.49	8.00	11.49
11	2 462	-3.55	8.00	11.55

MODE – 802.11g

CHANNEL	Channel Frequency (MHz)	Measured Power Spectral Density (dBm)	Maximum Permissible Power Density (dBm/3kHz)	Margin
1	2 412	-5.72	8.00	13.72
6	2 437	-5.05	8.00	13.05
11	2 462	-5.44	8.00	13.44

8.4 Trace data – 802.11b mode (ch_1)

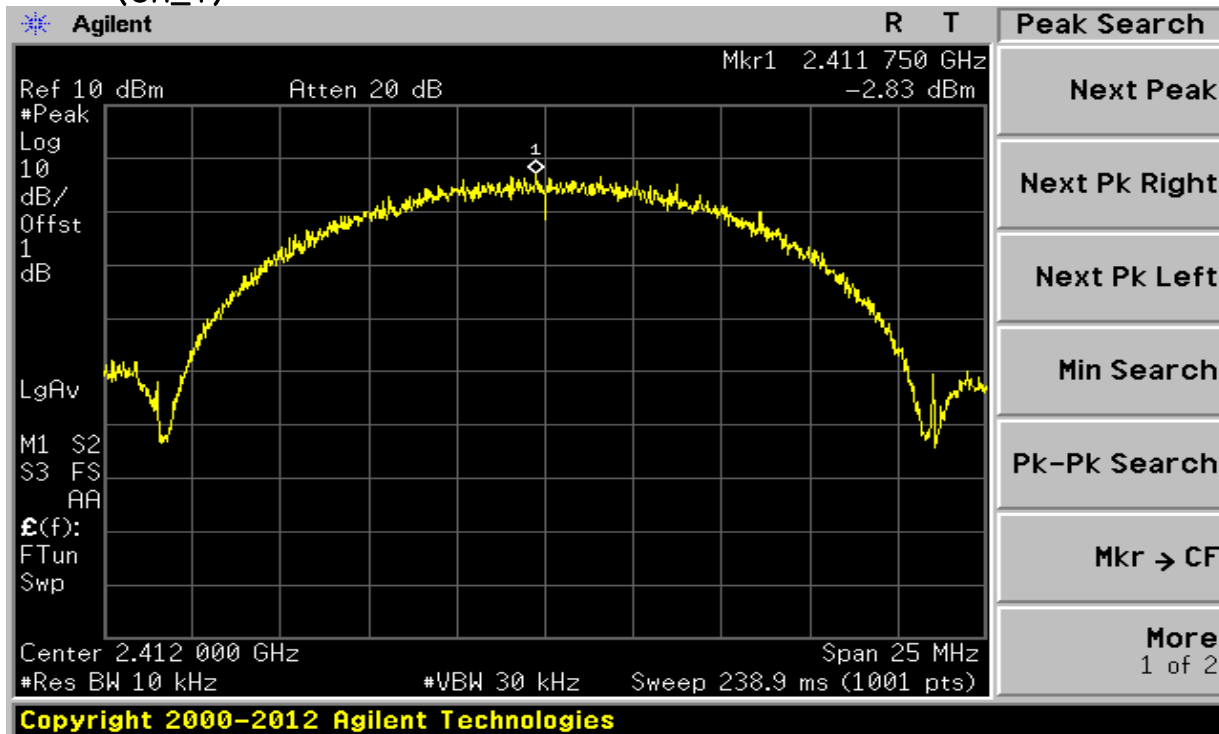

(ch_6)

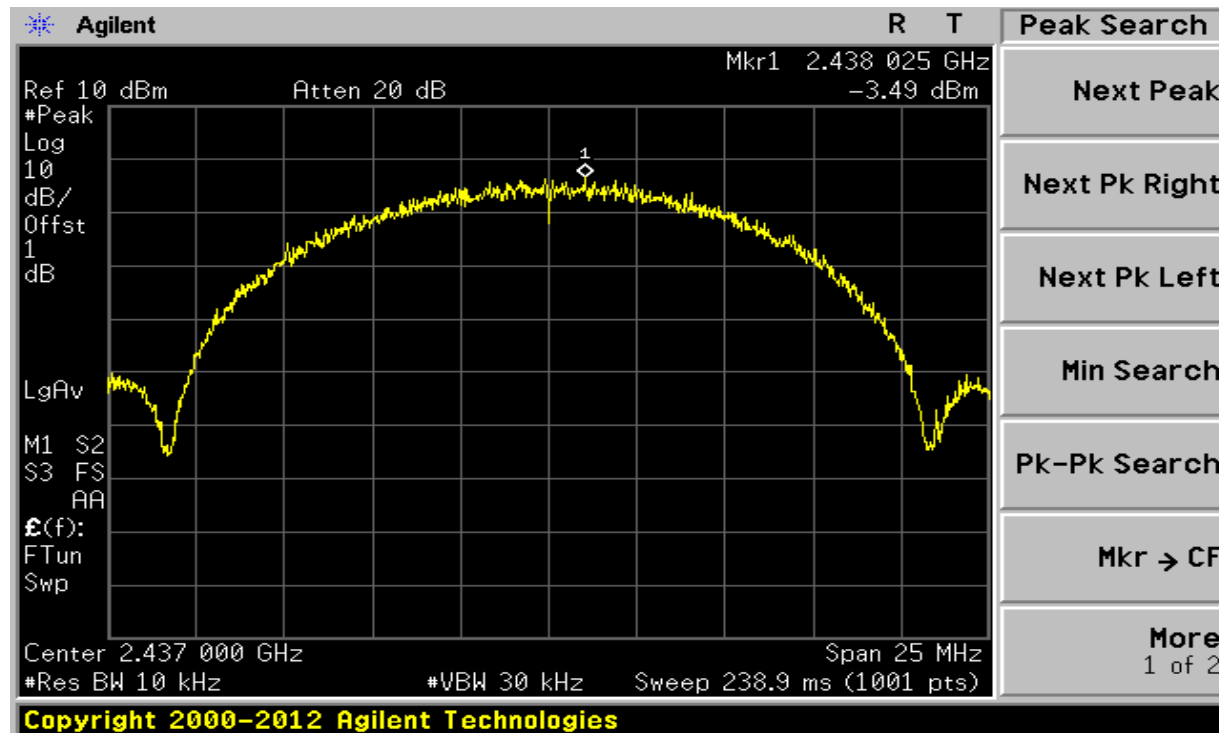

8.4 Trace data – 802.11b
(ch_11)

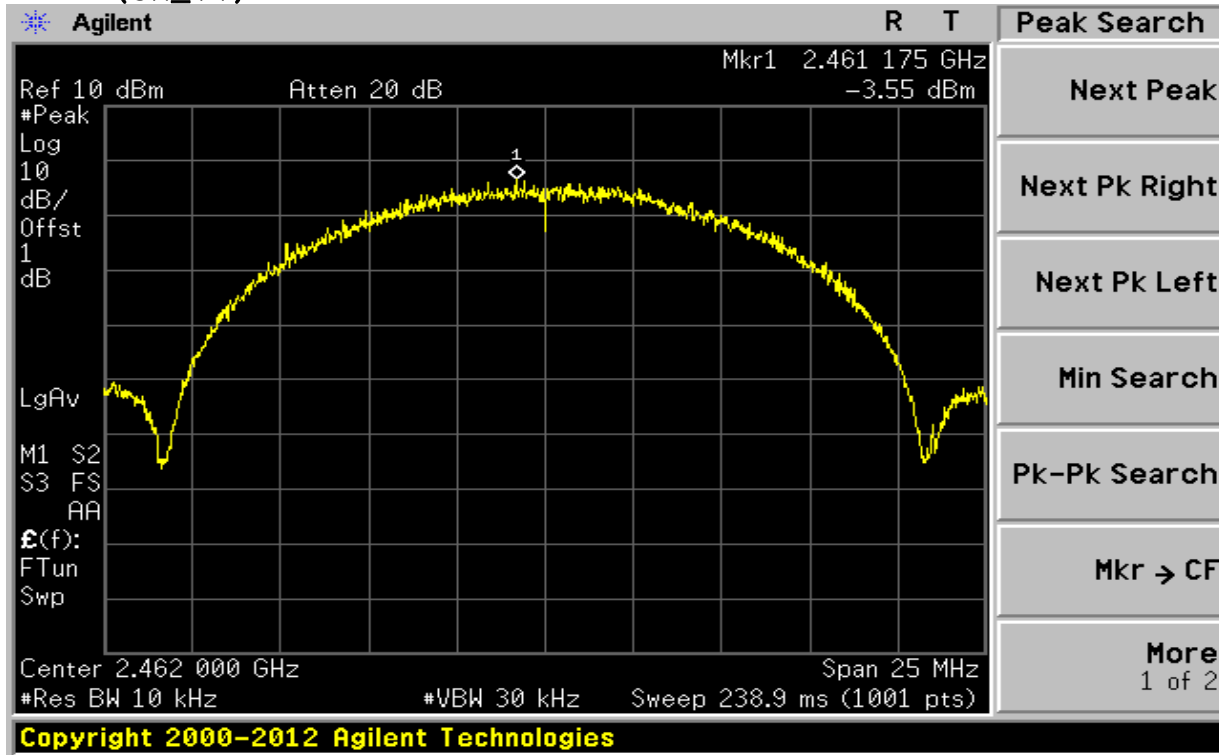

8.4 Trace data – 802.11g mode (ch_1)

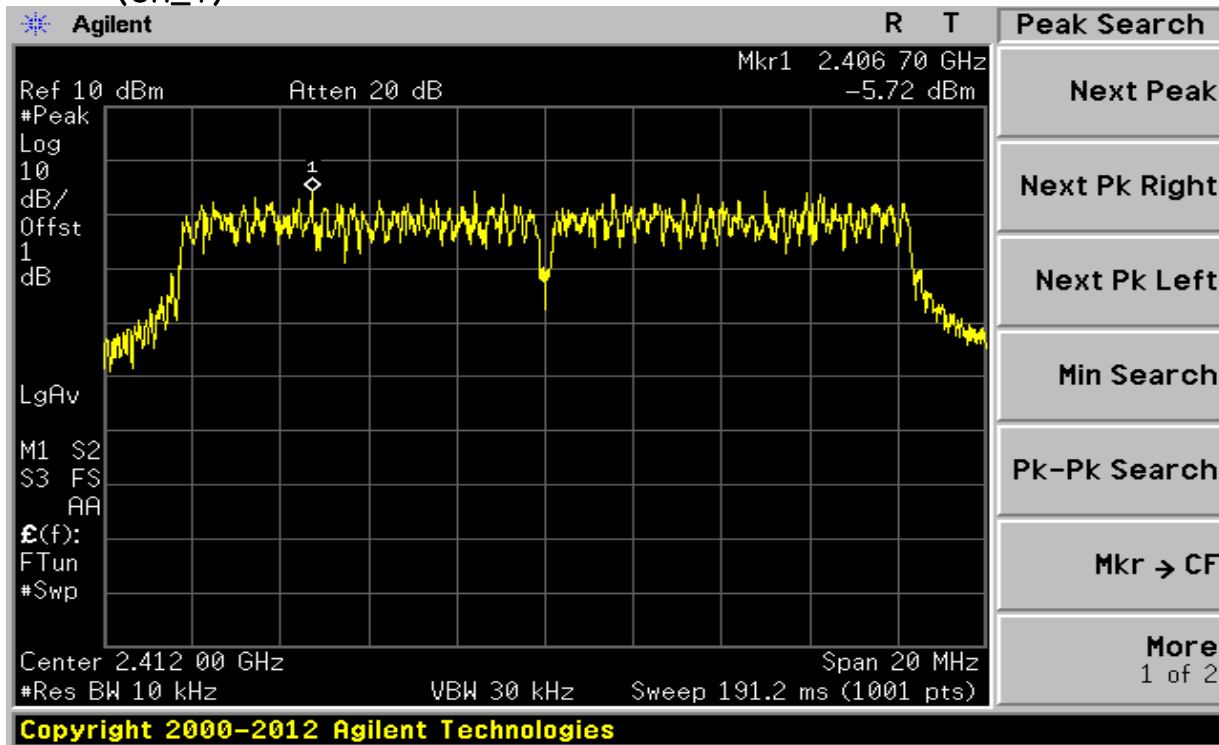

(ch_6)

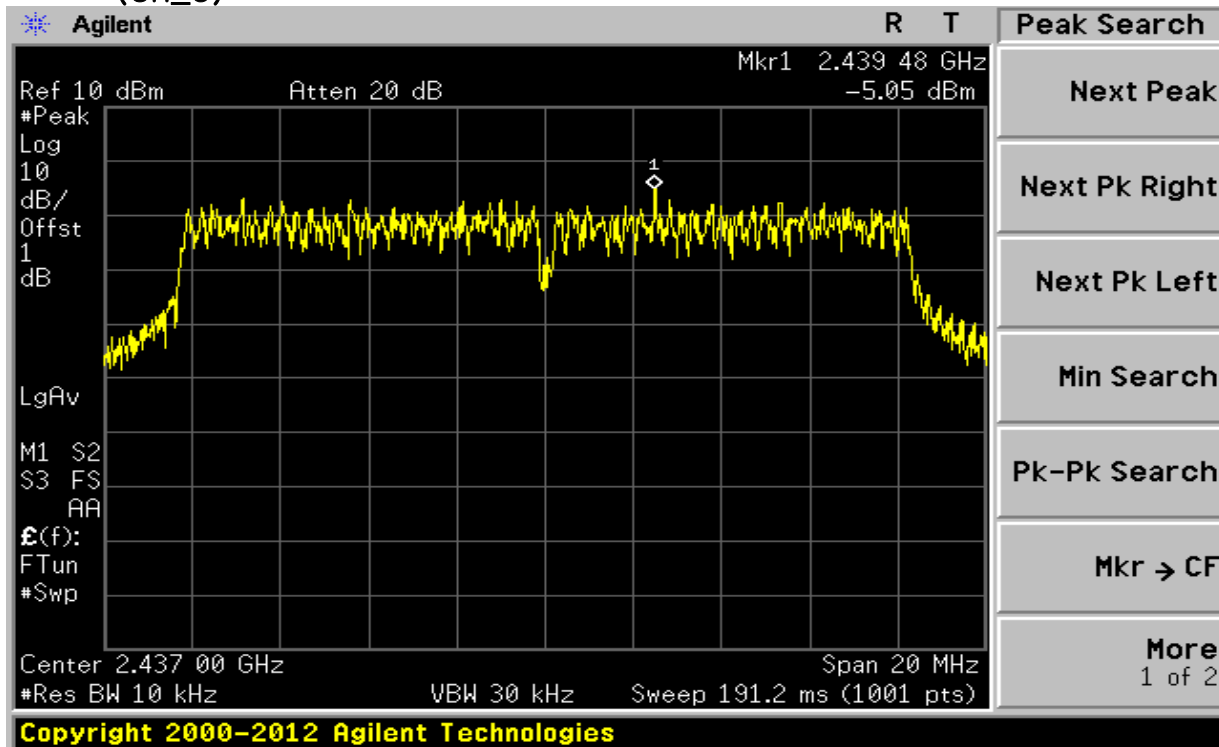

8.4 Trace data – 802.11g mode
(ch_11)

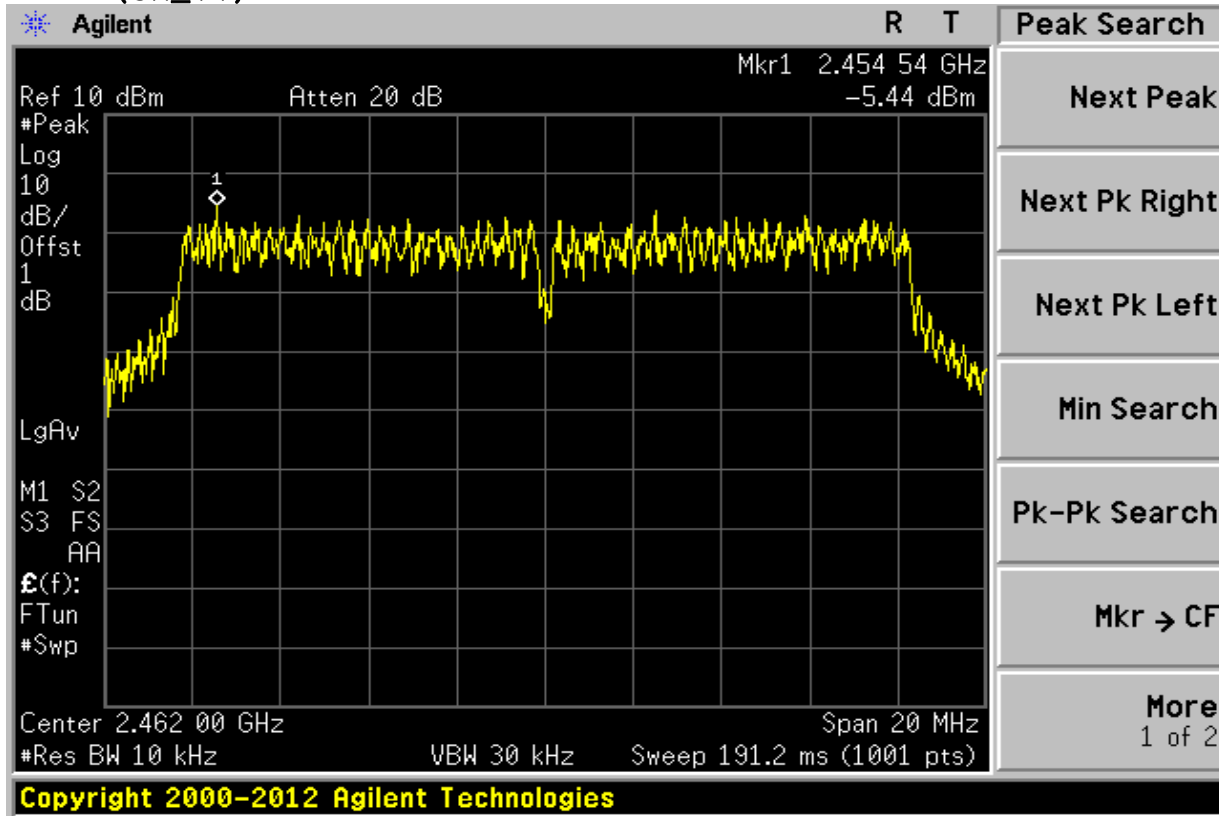

9. Emissions in non-restricted frequency bands

9.1 Test procedure

KDB 558074 D01v05r02 DTS Meas Guidance V05

9.2 Test instruments and measurement setup

The spectrum analyzer is set to as following.

- a) Set instrument center frequency to DTS channel center frequency.
- b) Set the span to ≥ 1.5 times the DTS bandwidth.
- c) Set the RBW = 100 kHz.
- d) Set the VBW $\geq 3 \times$ RBW.
- e) Detector = peak.
- f) Sweep time = auto couple.
- g) Trace mode = max hold.
- h) Allow trace to fully stabilize.
- i) Use the peak marker function to determine the maximum PSD level.

Limits FCC § 15.247

Band Edge&Out of Emission Test Instruments

Description	Model	Serial Number	Cal. Due Date
Spectrum Analyzer	E4440A	US41421291	2-Dec-20
UXA Signal Analyzer	E4440A	US57212216	3-Dec-20
RF Cable	Length: 30 cm		-
-Spectrum Analyzer <=> EUT	Loss: 1.0 dB		-

9.3 Measurement results of band-edge & out of emission – Adapter

EUT	Wlan module	MODEL	C8723RHPS-H
MODE	802.11b, g	ENVIRONMENTAL CONDITION	22.0 °C, 47.0 % R.H.
INPUT POWER	DC 5.0 V		

MODE -802.11b

CHANNEL	Channel Frequency (MHz)	limit	PASS/FAIL
1	2 412	20dBc	PASS
11	2 462	20dBc	PASS

MODE -802.11g

CHANNEL	Channel Frequency (MHz)	limit	PASS/FAIL
1	2 412	20dBc	PASS
11	2 462	20dBc	PASS

9.4 Trace data of band-edge & Out of Emission – 802.11b mode (ch_1)

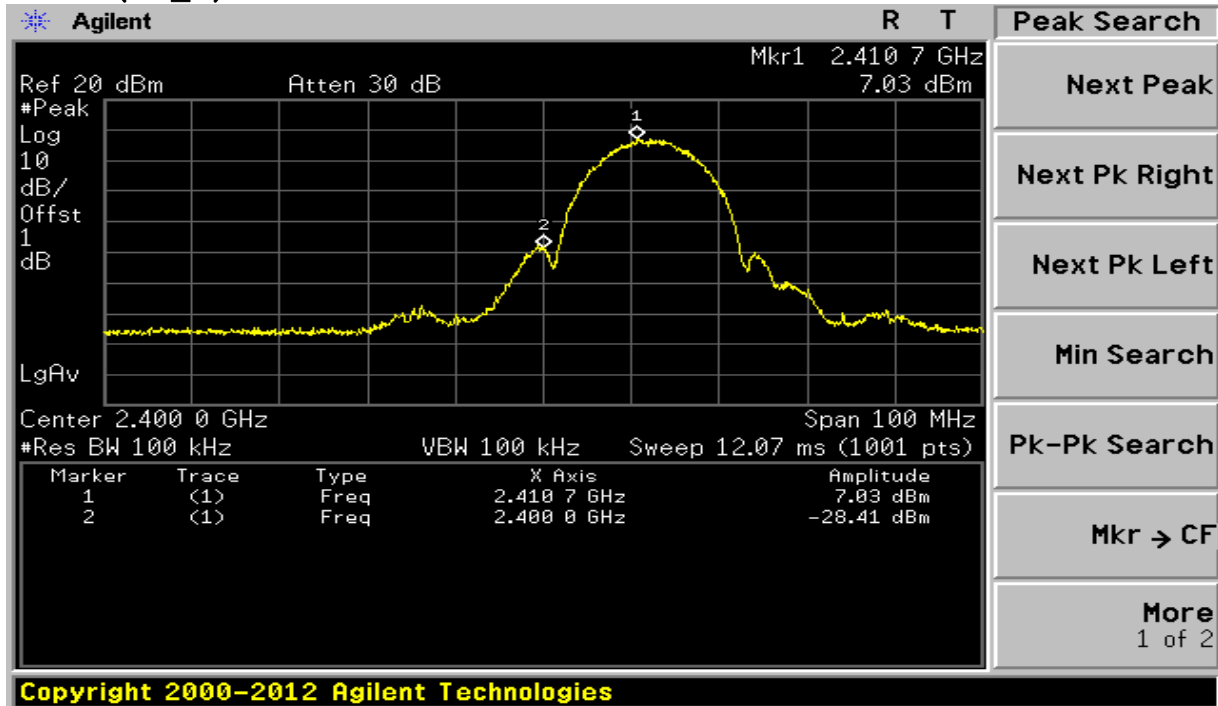

(ch_11)

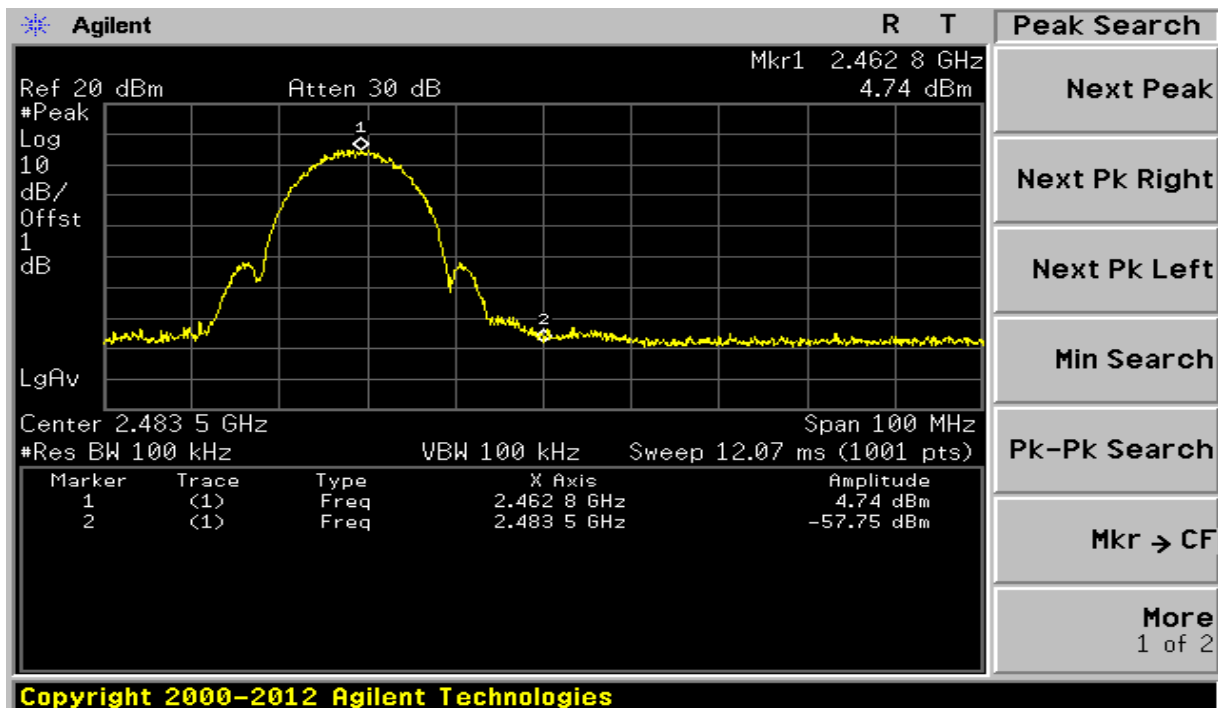

9.4 Trace data of band-edge & Out of Emission – 802.11g mode (ch_1)

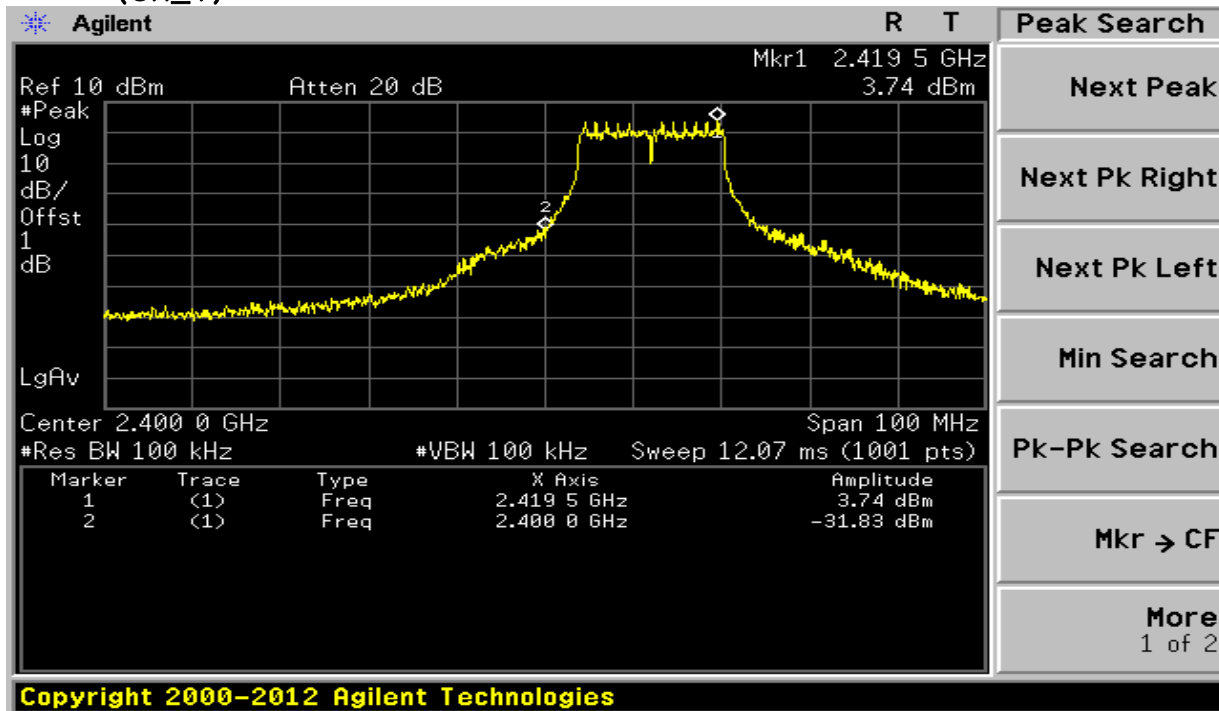

(ch_11)

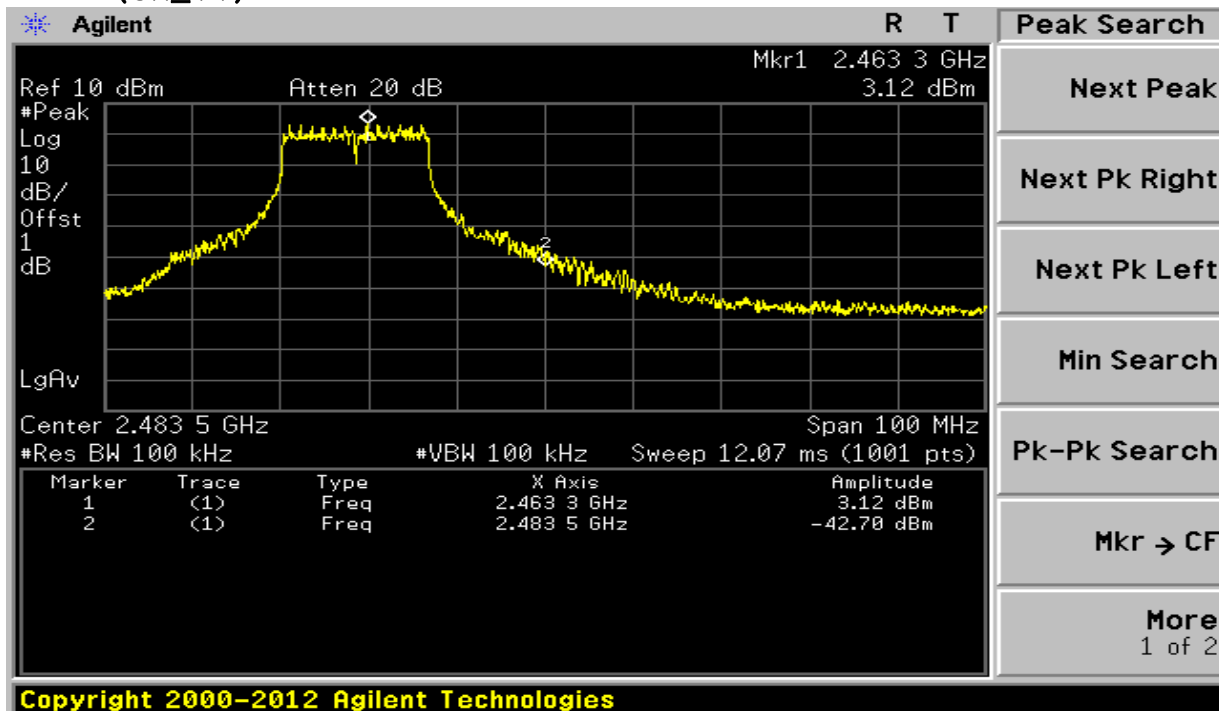

9.4 Trace data of Out of Emission – 802.11b mode (ch_1)

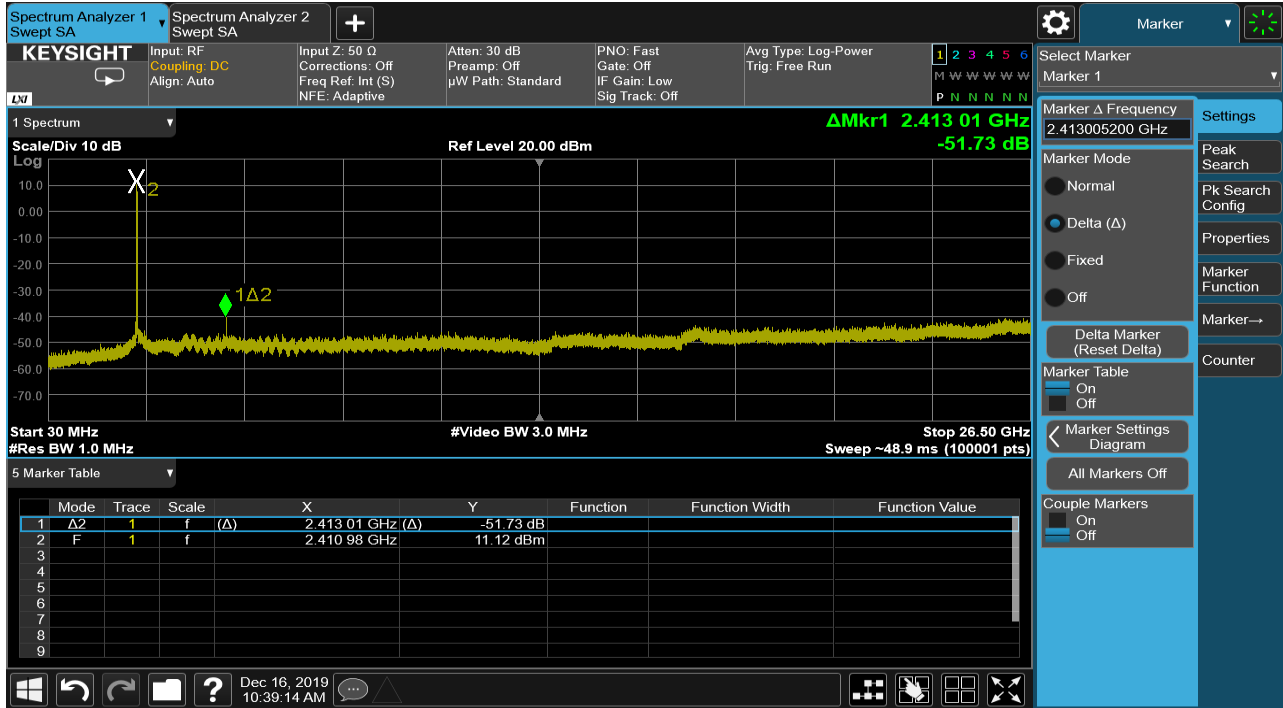

(ch_6)

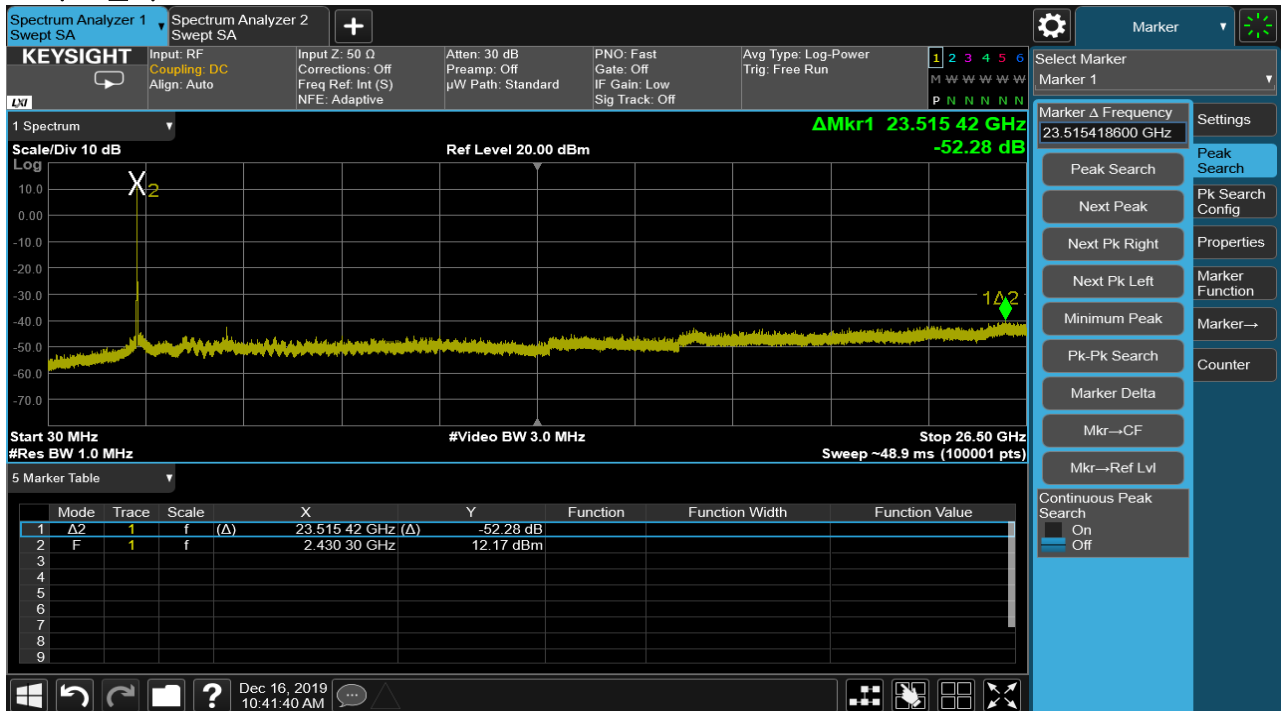

9.4 Trace data of Out of Emission – 802.11b mode (ch_11)

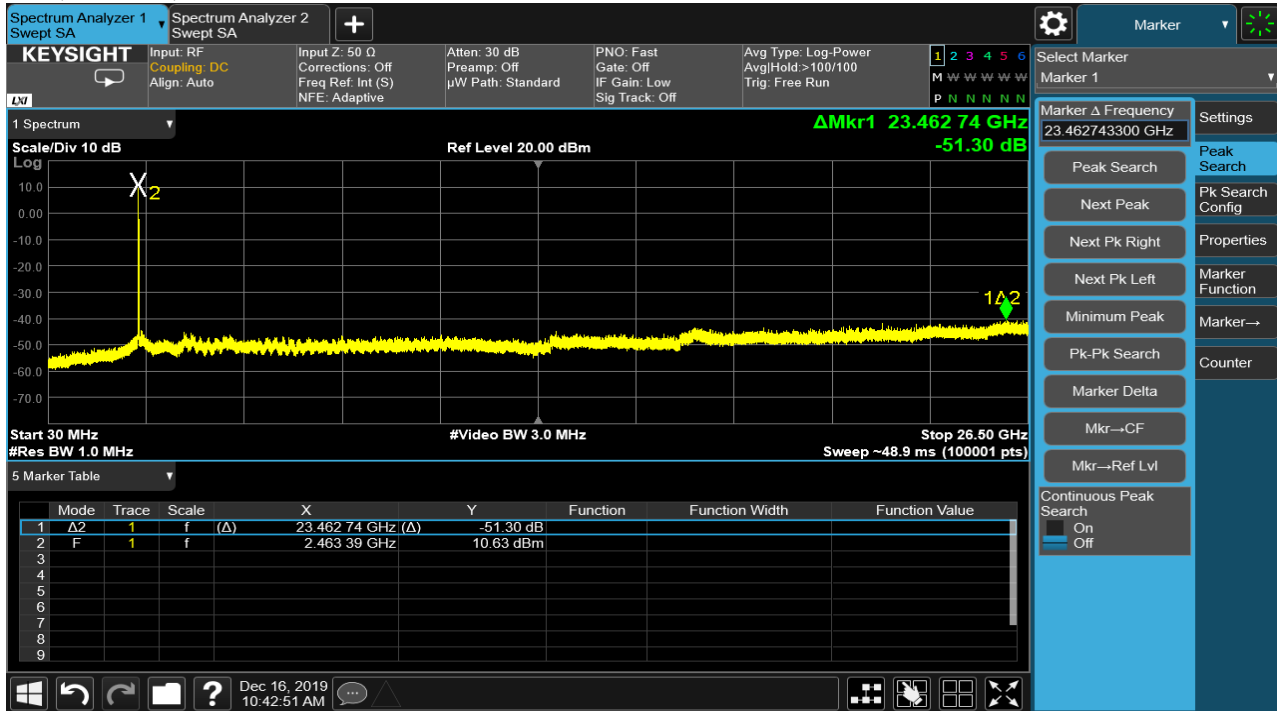

9.4 Trace data of Out of Emission – 802.11g mode (ch_1)

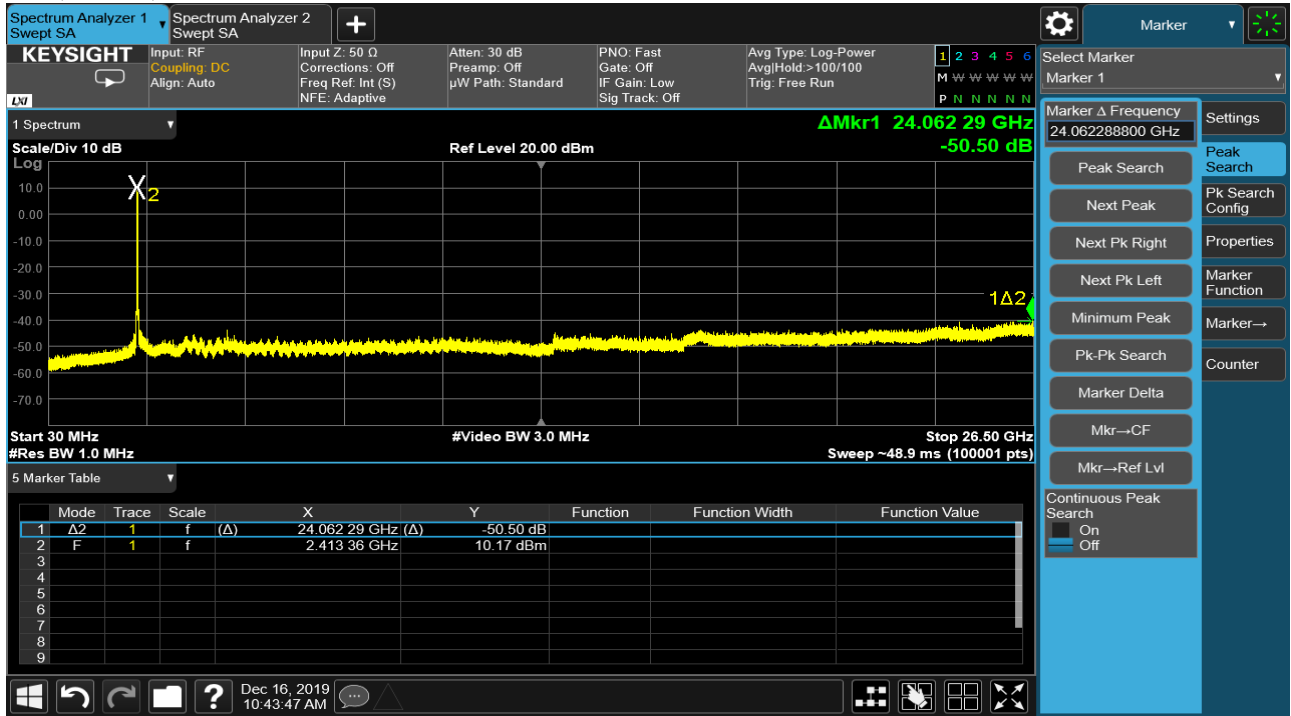

(ch_6)

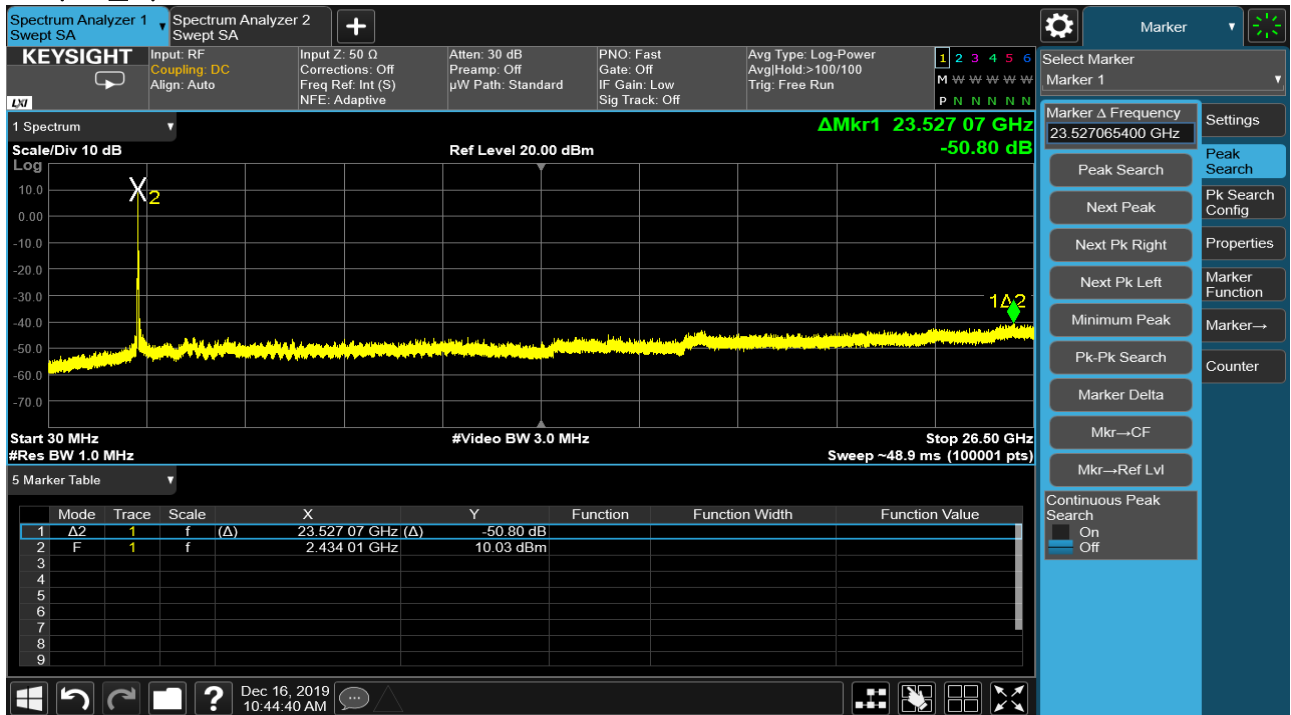

9.4 Trace data of Out of Emission – 802.11g mode (ch_11)

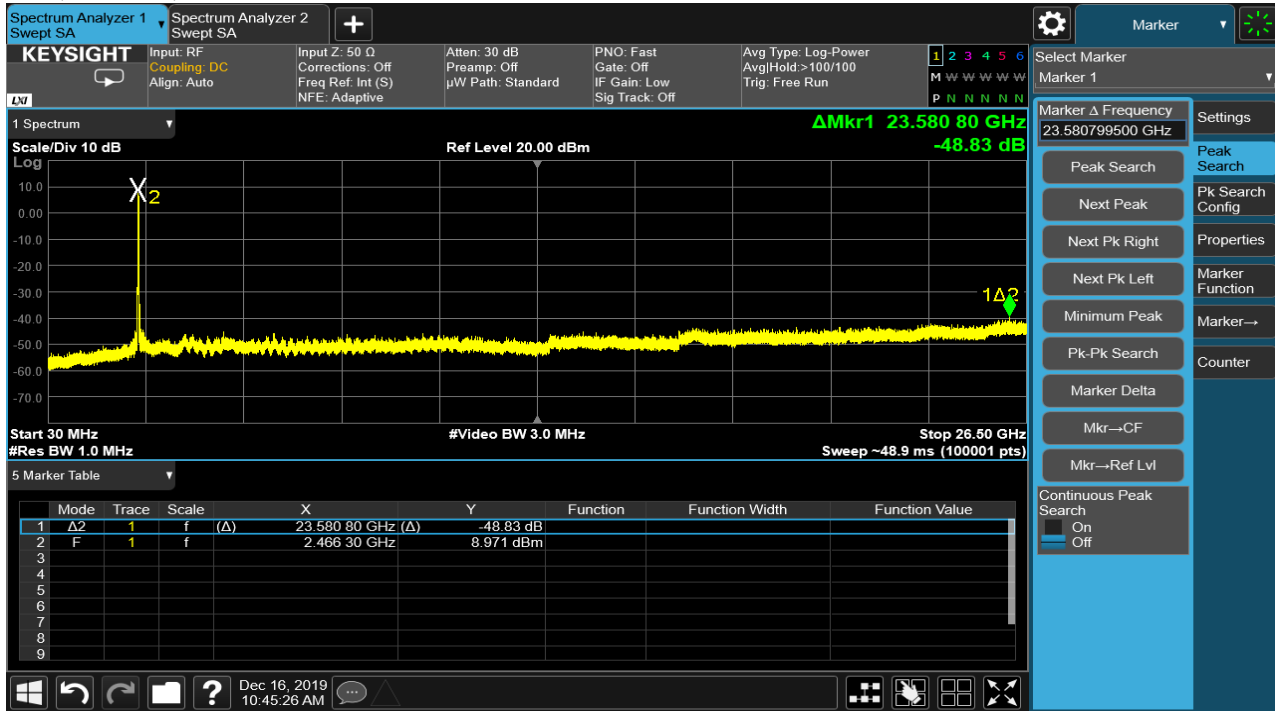

10. Measurement of radiated disturbance

Above 30 MHz Electric Field strength was measured in accordance with FCC PART 15.205, 15.209 . The test setup was made according to ANSI C 63.10 (2013) & KDB 558074 D01v05r02 Semi-anechoic chamber, which allows a 3 m distance measurement. The EUT was placed in the center of styrofoam. turntable. The height of this table was 0.8 m. The measurement was conducted with both horizontal and vertical antenna polarization. The turntable has fully rotated. For further description of the configuration refer to the picture of the test setup.

10.1 Measurement equipments

Equipment Name	Type	Manufacturer	Serial No.	Next Calibration date
EMI TEST Receiver	ESCI7	ROHDE & SCHWARZ	100916	9-Sep-20
Logbicon Antenna	VULB 9168	SCHWARZBECK	9168-193	15-Oct-20
Turn Table	DT3000-2t	Innco System GmbH	N/A	-
Antenna Mast	MA4000-EP	Innco System GmbH	N/A	-
PREAMPLIFIER	8449B	Agilent	3008A00595	9-Sep-20
Horn Antenna	BBHA 9120 D	SCHWARZBECK	469	30-Apr-20
Test Receiver	ESPI7	ROHDE & SCHWARZ	100185	9-Sep-20
Signal Analyzer	FSV40	ROHDE & SCHWARZ	100939	2-Dec-20
Turn Table	DT1500-S	Innco System GmbH	N/A	-
Antenna Mast	MA4000-EP	Innco System GmbH	N/A	-
Horn Antenna	BBHA 9170	SCHWARZBECK	752	1-Nov-20
Antenna Master & Turn table controller	C02000-P	Innco System GmbH	CO2000/642 /28051111/L	-

10.2 Environmental Condition

Below 1 GHz –Test Place : 10 m Semi-anechoic chamber

WLAN 802.11 b,g,n20 Mode

Temperature (°C) : 22.8 °C

Humidity (% R.H.) : 50.9 % R.H.

Above 1 GHz–Test Place : 3 m Semi-anechoic chamber

WLAN 802.11 b,g,n20 Mode

Temperature (°C) : 23.7 °C

Humidity (% R.H.) : 50.1 % R.H.

10.3 Measurement Instrument setting for Radiated Emission

10.3.1 Frequency range below 1 GHz

Detector : Quasi-Peak

10.3.2 Frequency range above 1 GHz

Peak Power Measurement Procedure (KDB 558074 D01v05r02)

- a. RBW : 1 MHz, VBW : 3 MHz
- b. Trace mode = max hold
- c. Detector : Peak
- d. Sweep time = auto

Average Power Measurement Procedures (KDB 558074 D01v05r02)

- a. Set analyzer center frequency to the frequency associated with the emission
- b. RBW : 1 MHz, VBW : 3 MHz
- c. Detector : RMS
- d. Sweep time = auto

* Note

Band	Duty cycle(%)	Ton (ms)	Ton + Toff (ms)	DCF=10*log(1/Duty) (dB)
802.11b	90.5	1.295	1.430	0.43
802.11g	21.6	0.248	1.146	6.57

* This was not applied of duty cycle factor for average value because of measured with the EUT transmitting continuously more than 98 % duty cycle at its maximum power control level.

10.4.1 Test Data (802.11 b)

Test Date : 30-Sep-19

Measurement Distance : 3 m

Frequency (MHz)	Reading (dB μ V)	Position (V/H)	Height (m)	Correction Factor		Result Value		
				Ant Factor (dB)	Cable (dB)	Limit (dB μ V/m)	Result (dB μ V/m)	Margin (dB)
48.00	20.09	V	1.2	13.15	1.03	40.00	34.27	5.73
240.00	29.44	H	1.0	11.30	2.36	46.00	43.10	2.90
480.00	20.32	V	1.2	17.59	3.52	46.00	41.43	4.57
720.00	8.75	H	1.0	21.56	4.42	46.00	34.73	11.27
800.00	11.93	H	1.6	22.55	4.68	46.00	39.16	6.84
960.00	10.65	V	1.4	24.13	5.18	46.00	39.96	6.04
Remark	<p>H : Horizontal, V : Vertical</p> <p>*Checked in all 3 axis and the maximum measured data were reported.(Worst data is Z axis of position)</p> <p>*CL = Cable Loss(In case of below 1 000 MHz)</p> <p>*Result Value = Reading + Ant Factor + Cable loss</p> <p>*The resolution bandwidth and video bandwidth of test receiver/spectrum analyzer is 120 kHz for Quasi-peak detection at frequency below 1 GHz.</p>							

10.4.2 Test Data (802.11 g)

Test Date : 30-Sep-19

Measurement Distance : 3 m

Frequency (MHz)	Reading (dB μ V)	Position (V/H)	Height (m)	Correction Factor		Result Value		
				Ant Factor (dB)	Cable (dB)	Limit (dB μ V/m)	Result (dB μ V/m)	Margin (dB)
202.80	23.77	H	1.2	9.93	2.00	43.50	35.70	7.80
239.90	21.98	H	1.3	11.29	2.36	46.00	35.63	10.37
400.00	20.31	H	1.0	16.00	3.18	46.00	39.49	6.51
480.00	15.19	H	1.0	17.59	3.52	46.00	36.30	9.70
720.00	11.49	V	1.2	21.56	4.42	46.00	37.47	8.53
960.00	8.24	H	1.4	24.13	5.18	46.00	37.55	8.45
Remark	<p>H : Horizontal, V : Vertical</p> <p>*Checked in all 3 axis and the maximum measured data were reported.(Worst data is Z axis of position)</p> <p>*CL = Cable Loss(In case of below 1 000 MHz)</p> <p>*Result Value = Reading + Ant Factor + Cable loss</p> <p>*The resolution bandwidth and video bandwidth of test receiver/spectrum analyzer is 120 kHz for Quasi-peak detection at frequency below 1 GHz.</p>							

10.4-5 Test Data

Test Date : 1-Oct-19

Measurement Distance : 3 m

Frequency (MHz)	Reading (dB μ W)	Position (V/H)	Height (m)	Correction Factor		Duty Cycle Correction(dB)	Result Value		
				Ant Factor (dB)	Cable (dB)		Limit (dB μ W/m)	Result (dB μ W/m)	Margin (dB)
PEAK(RBW: 1 MHz VBW: 3 MHz)									
2390.00	54.97	H	1.5	27.02	-30.00		74.00	51.99	22.01
2390.00	56.13	V	1.6	27.02	-30.00		74.00	53.15	20.85
4824.00	46.50	H	1.5	31.27	-27.10		74.00	50.67	23.33
4824.00	46.32	V	1.6	31.27	-27.10		74.00	50.49	23.51
AV(RBW: 1 MHz VBW: 3 MHz)									
2390.00	44.11	H	1.5	27.02	-30.00	0.49	54.00	41.62	12.38
2390.00	44.16	V	1.6	27.02	-30.00	0.49	54.00	41.67	12.33
4824.00	34.24	H	1.5	31.27	-27.10	0.49	74.00	38.90	35.10
4824.00	34.05	V	1.6	31.27	-27.10	0.49	74.00	38.71	35.29
Remark	<p>H : Horizontal, V : Vertical TEST MODE : 802.11 b - CH 1(2 412 MHz)</p> <p>*The TX signal wasn't detected from 3th harmonics.</p> <p>*Checked in all 3 axis and the maximum measured data were reported.(Worst data is Z axis of position)</p> <p>*Total = Reading Value + Antenna Factor + Cable Loss - Amp Gain + Duty Cycle Correction</p> <p>*This test was radiated up to 26.5 GHz but no noise was measured.</p>								

10.4-6 Test Data

Test Date : 1-Oct-19

Measurement Distance : 3 m

Frequency (MHz)	Reading (dB μ V)	Position (V/H)	Height (m)	Correction Factor		Duty Cycle Correction(dB)	Result Value		
				Ant Factor (dB)	Cable (dB)		Limit (dB μ V/m)	Result (dB μ V/m)	Margin (dB)
PEAK(RBW: 1 MHz VBW: 3 MHz)									
4874.00	46.38	H	1.6	31.36	-27.03	/	74.00	50.71	23.29
4874.00	46.19	V	1.5	31.36	-27.03		74.00	50.52	23.48
AV(RBW: 1 MHz VBW: 3 MHz)									
4874.00	33.96	H	1.6	31.36	-27.03	0.49	54.00	38.78	15.22
4874.00	33.81	V	1.5	31.36	-27.03	0.49	54.00	38.63	15.37
Remark	<p>H : Horizontal, V : Vertical TEST MODE : 802.11 b - CH 6(2 437 MHz)</p> <p>*The TX signal wasn't detected from 3th harmonics. *Checked in all 3 axis and the maximum measured data were reported.(Worst data is Z axis of position) *Total = Reading Value + Antenna Factor + Cable Loss - Amp Gain + Duty Cycle Correction *This test was radiated up to 26.5 GHz but no noise was measured.</p>								

10.4-7 Test Data

Test Date : 1-Oct-19

Measurement Distance : 3 m

Frequency (MHz)	Reading (dB μ W)	Position (V/H)	Height (m)	Correction Factor		Duty Cycle Correction(dB)	Result Value		
				Ant Factor (dB)	Cable (dB)		Limit (dB μ W/m)	Result (dB μ W/m)	Margin (dB)
PEAK(RBW: 1 MHz VBW: 3 MHz)									
2483.50	55.91	H	1.6	27.24	-29.80		74.00	53.35	20.65
2483.50	55.68	V	1.5	27.24	-29.80		74.00	53.12	20.88
4924.00	47.48	H	1.6	31.46	-26.94		74.00	52.00	22.00
4924.00	47.33	V	1.5	31.46	-26.94		74.00	51.85	22.15
AV(RBW: 1 MHz VBW: 3 MHz)									
2483.50	44.75	H	1.6	27.24	-29.80	0.49	54.00	42.68	11.32
2483.50	44.80	V	1.5	27.24	-29.80	0.49	54.00	42.73	11.27
4924.00	36.08	H	1.6	31.46	-26.94	0.49	74.00	41.09	32.91
4924.00	35.95	V	1.5	31.46	-26.94	0.49	74.00	40.96	33.04
Remark	<p>H : Horizontal, V : Vertical TEST MODE : 802.11 b - CH 11(2 462 MHz)</p> <p>*The TX signal wasn't detected from 3th harmonics.</p> <p>*Checked in all 3 axis and the maximum measured data were reported.(Worst data is Z axis of position)</p> <p>*Total = Reading Value + Antenna Factor + Cable Loss - Amp Gain + Duty Cycle Correction</p> <p>*This test was radiated up to 26.5 GHz but no noise was measured.</p>								

10.4-8 Test Data

Test Date : 2-Oct-19

Measurement Distance : 3 m

Frequency (MHz)	Reading (dB μ W)	Position (V/H)	Height (m)	Correction Factor		Duty Cycle Correction(dB)	Result Value		
				Ant Factor (dB)	Cable (dB)		Limit (dB μ W/m)	Result (dB μ W/m)	Margin (dB)
PEAK(RBW: 1 MHz VBW: 3 MHz)									
2390.00	54.46	H	1.6	27.02	-30.00		74.00	51.48	22.52
2390.00	55.24	V	1.6	27.02	-30.00		74.00	52.26	21.74
4824.00	46.40	H	1.5	31.27	-27.10		74.00	50.57	23.43
4824.00	46.31	V	1.6	31.27	-27.10		74.00	50.48	23.52
AV(RBW: 1 MHz VBW: 3 MHz)									
2390.00	37.28	H	1.6	27.02	-30.00	6.55	54.00	40.85	13.15
2390.00	37.38	V	1.6	27.02	-30.00	6.55	54.00	40.95	13.05
4824.00	34.12	H	1.5	31.27	-27.10	6.55	54.00	44.84	9.16
4824.00	34.05	V	1.6	31.27	-27.10	6.55	54.00	44.77	9.23
Remark	<p>H : Horizontal, V : Vertical TEST MODE : 802.11 g - CH 1(2 412 MHz)</p> <p>*The TX signal wasn't detected from 3th harmonics.</p> <p>*Checked in all 3 axis and the maximum measured data were reported.(Worst data is Z axis of position)</p> <p>*Total = Reading Value + Antenna Factor + Cable Loss - Amp Gain + Duty Cycle Correction</p> <p>*This test was radiated up to 26.5 GHz but no noise was measured.</p>								

10.4-9 Test Data

Test Date : 2-Oct-19

Measurement Distance : 3 m

Frequency (MHz)	Reading (dB μ W)	Position (V/H)	Height (m)	Correction Factor		Duty Cycle Correction(dB)	Result Value		
				Ant Factor (dB)	Cable (dB)		Limit (dB μ W/m)	Result (dB μ W/m)	Margin (dB)
PEAK(RBW: 1 MHz VBW: 3 MHz)									
4874.00	49.80	H	1.6	31.36	-27.03		74.00	54.13	19.87
4874.00	49.68	V	1.5	31.36	-27.03		74.00	54.01	19.99
AV(RBW: 1 MHz VBW: 3 MHz)									
4874.00	37.91	H	1.6	31.36	-27.03	0.49	54.00	42.73	11.27
4874.00	37.79	V	1.5	31.36	-27.03	0.49	54.00	42.61	11.39
Remark	<p>H : Horizontal, V : Vertical TEST MODE : 802.11 g - CH 6(2 437 MHz)</p> <p>*The TX signal wasn't detected from 3th harmonics.</p> <p>*Checked in all 3 axis and the maximum measured data were reported.(Worst data is Z axis of position)</p> <p>*Total = Reading Value + Antenna Factor + Cable Loss - Amp Gain + Duty Cycle Correction</p> <p>*This test was radiated up to 26.5 GHz but no noise was measured.</p>								

10.4-10 Test Data

Test Date : 4-Oct-19

Measurement Distance : 3 m

Frequency (MHz)	Reading (dB μ V)	Position (V/H)	Height (m)	Correction Factor		Duty Cycle Correction(dB)	Result Value		
				Ant Factor (dB)	Cable (dB)		Limit (dB μ V/m)	Result (dB μ V/m)	Margin (dB)
PEAK(RBW: 1 MHz VBW: 3 MHz)									
2483.50	56.03	H	1.6	27.02	-30.00		74.00	53.05	20.95
2483.50	55.92	V	1.5	27.02	-30.00		74.00	52.94	21.06
4924.00	42.18	H	1.6	31.27	-27.10		74.00	46.35	27.65
4924.00	42.06	V	1.5	31.27	-27.10		74.00	46.23	27.77
AV(RBW: 1 MHz VBW: 3 MHz)									
2483.50	44.85	H	1.6	27.02	-30.00	6.55	54.00	48.42	5.58
2483.50	45.20	V	1.5	27.02	-30.00	6.55	54.00	48.77	5.23
4924.00	38.71	H	1.6	31.27	-27.10	6.55	54.00	49.43	4.57
4924.00	38.55	V	1.5	31.27	-27.10	6.55	54.00	49.27	4.73
Remark	<p>H : Horizontal, V : Vertical TEST MODE : 802.11g - CH 11(2 462 MHz)</p> <p>*The TX signal wasn't detected from 3th harmonics.</p> <p>*Checked in all 3 axis and the maximum measured data were reported.(Worst data is Z axis of position)</p> <p>*Total = Reading Value + Antenna Factor + Cable Loss - Amp Gain + Duty Cycle Correction</p> <p>*This test was radiated up to 26.5 GHz but no noise was measured.</p>								

10.5 Restricted Band Edges

*802.11b Mode

Band Edges(CH Low)

Detector mode:Peak

Polarity:Horizontal

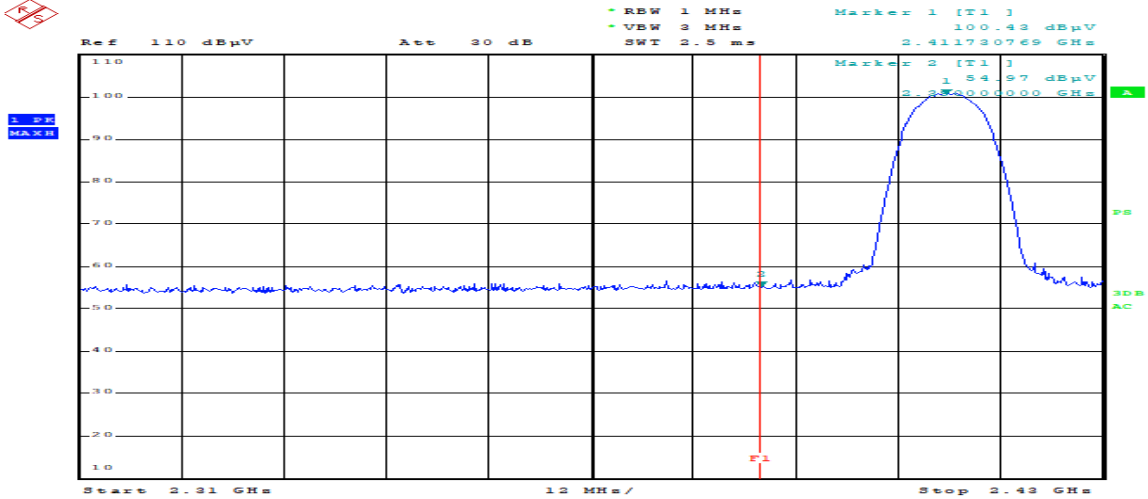

00260_11b_CH1_PEAK_HOR

Detector mode:Average

Polarity:Horizontal

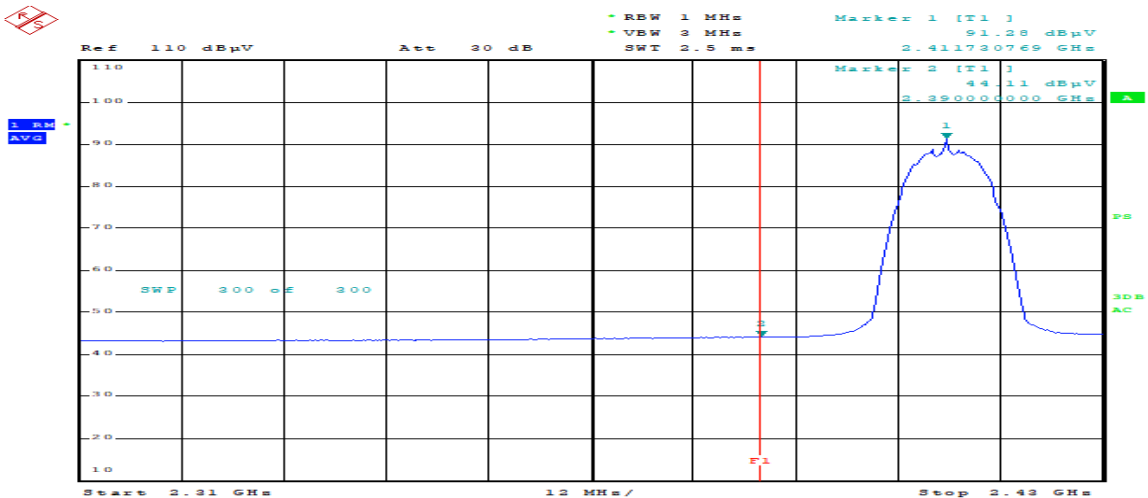

00260_11b_CH1_AV_HOR

Band Edges(CH Low)

Detector mode:Peak

Polarity:Vertical

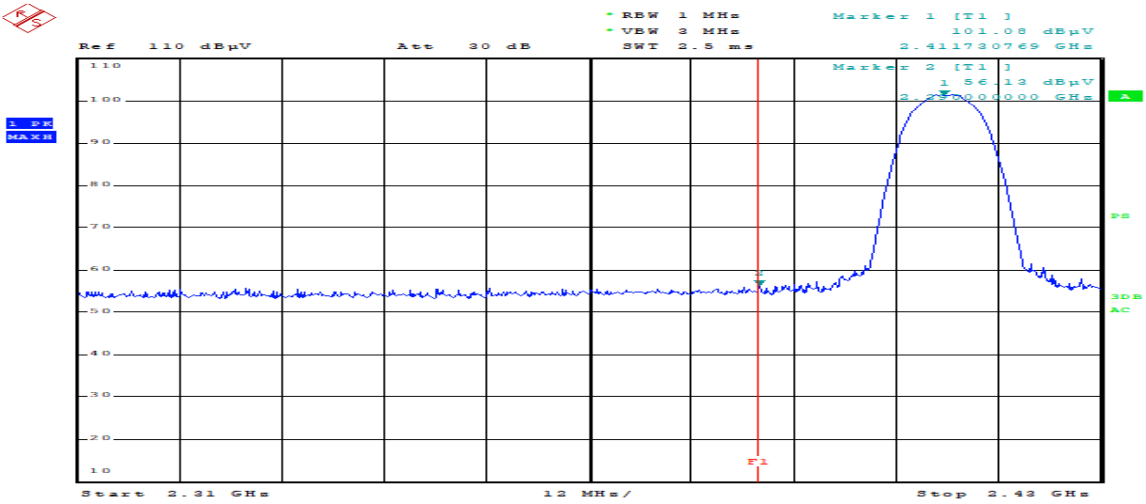

00260_11b_CH1_PEAK_VER

Detector mode:Average

Polarity:Vertical

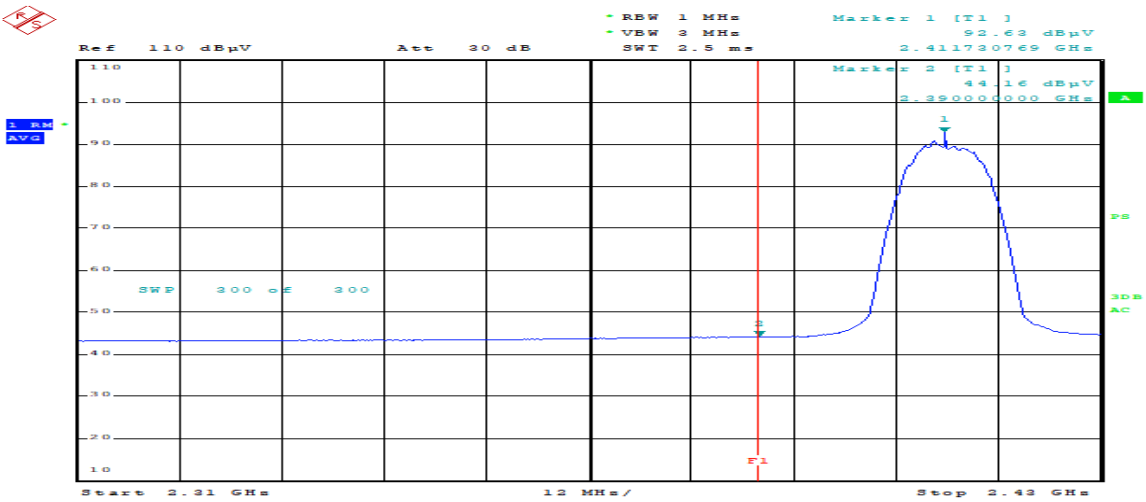

00260_11b_CH1_AV_VER

Band Edges(CH High)

Detector mode:Peak

Polarity:Horizontal

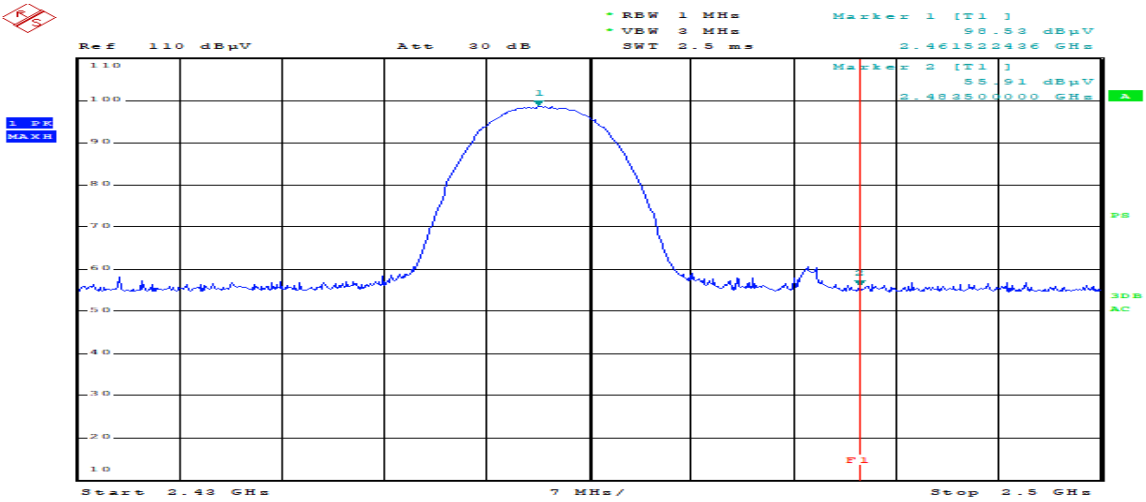

00260_11b_CH11_PEAK_HOR

Detector mode:Average

Polarity:Horizontal

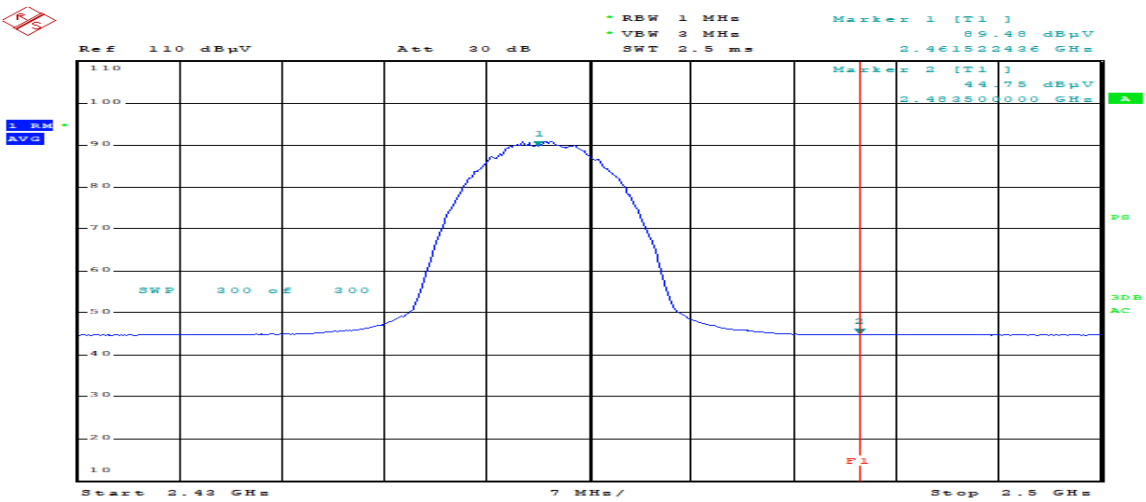

00260_11b_CH11_AV_HOR

Band Edges(CH High)

Detector mode:Peak

Polarity:Vertical

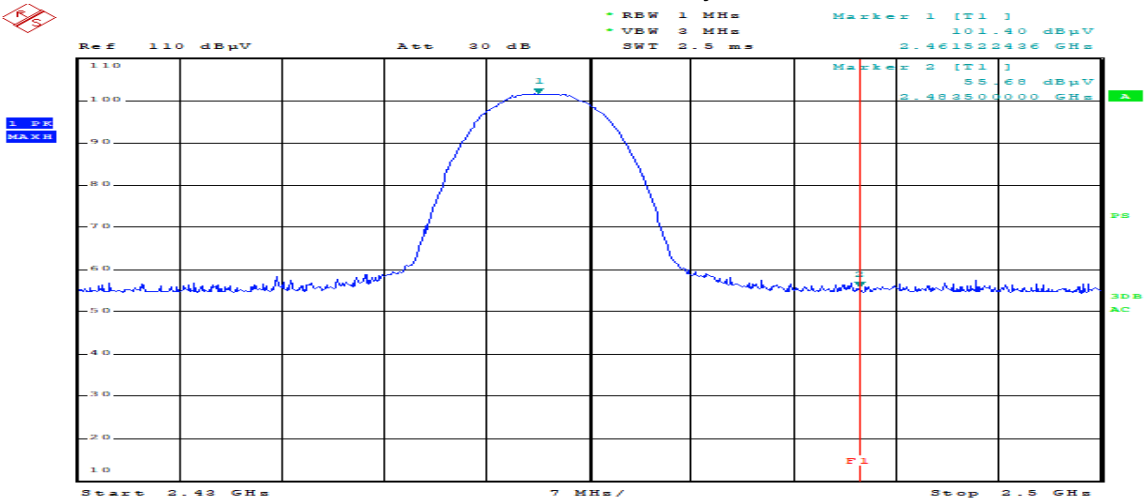

00260_11b_CH11_PEAK_VER

Detector mode:Average

Polarity:Vertical

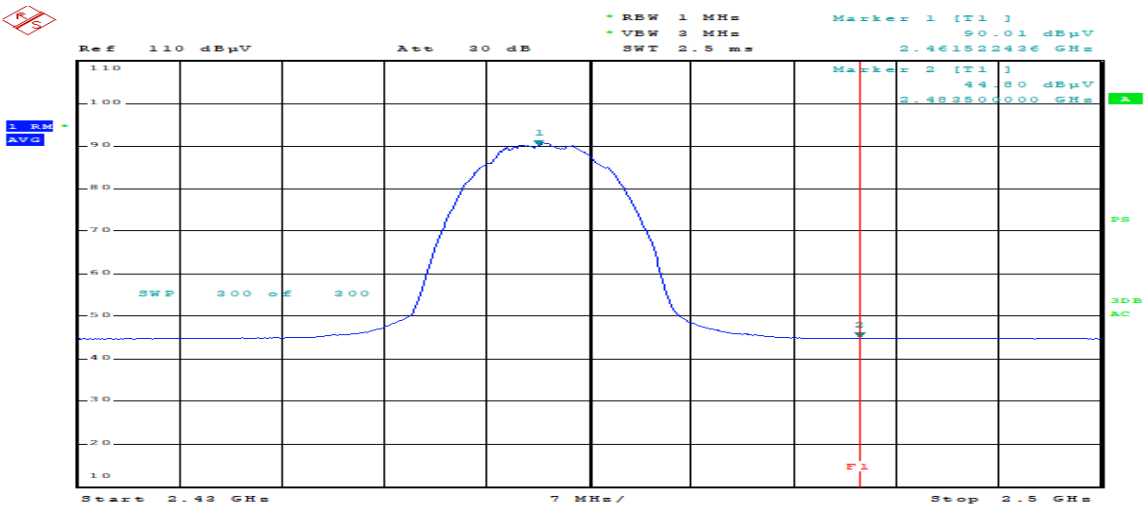

00260_11b_CH11_AV_VER

***802.11g Mode**

Band Edges(CH Low)

Detector mode:Peak

Polarity:Horizontal

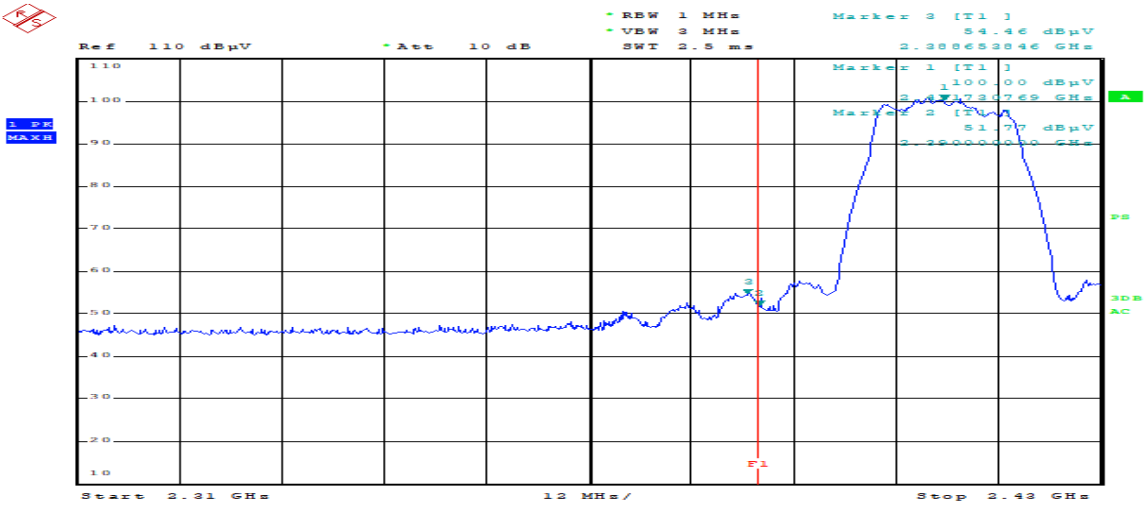

00260_11g_CH1_PEAK_HOR

Detector mode:Average

Polarity:Horizontal

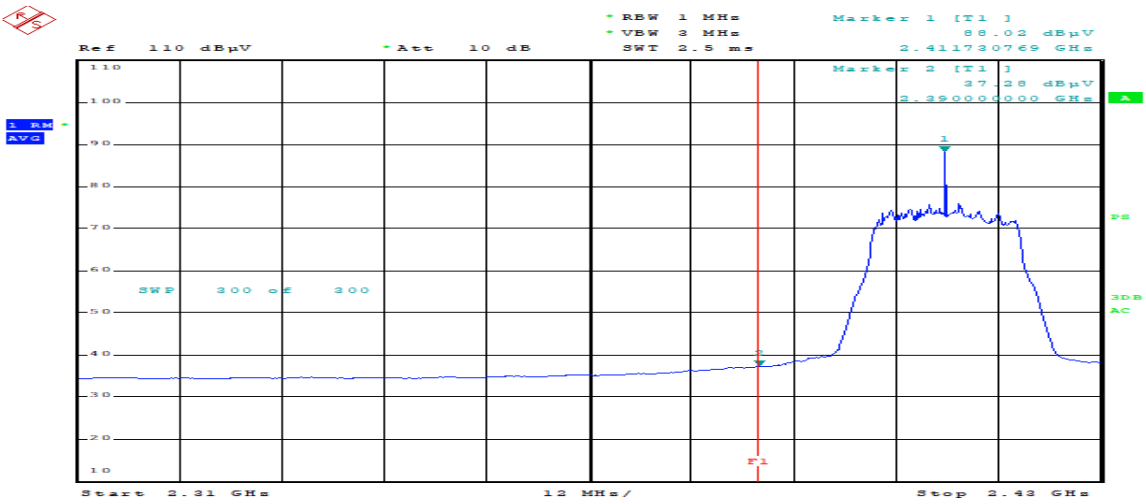

00260_11g_CH1_AV_HOR

Band Edges(CH Low)

Detector mode:Peak

Polarity:Vertical

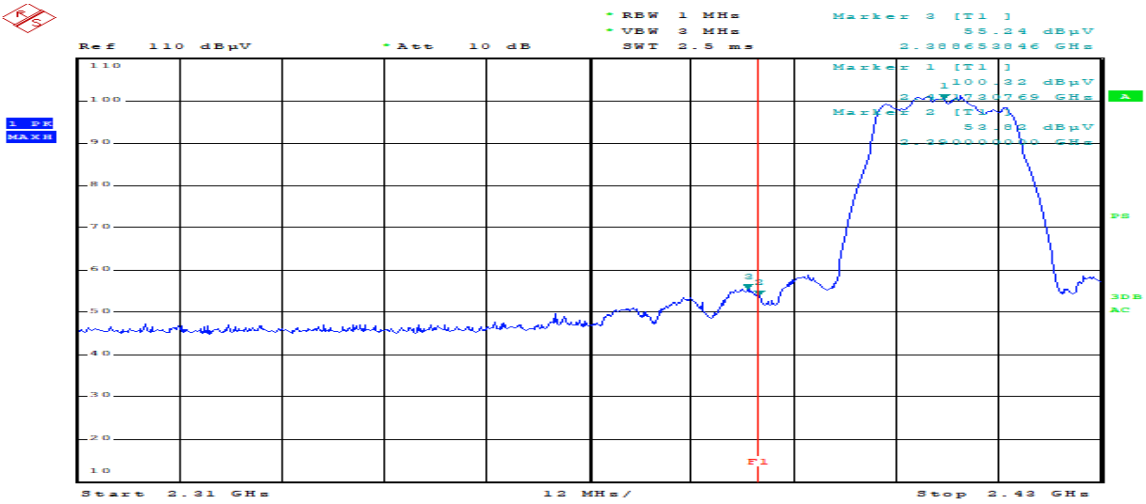

00260_11g_CH1_PEAK_VER

Detector mode:Average

Polarity:Vertical

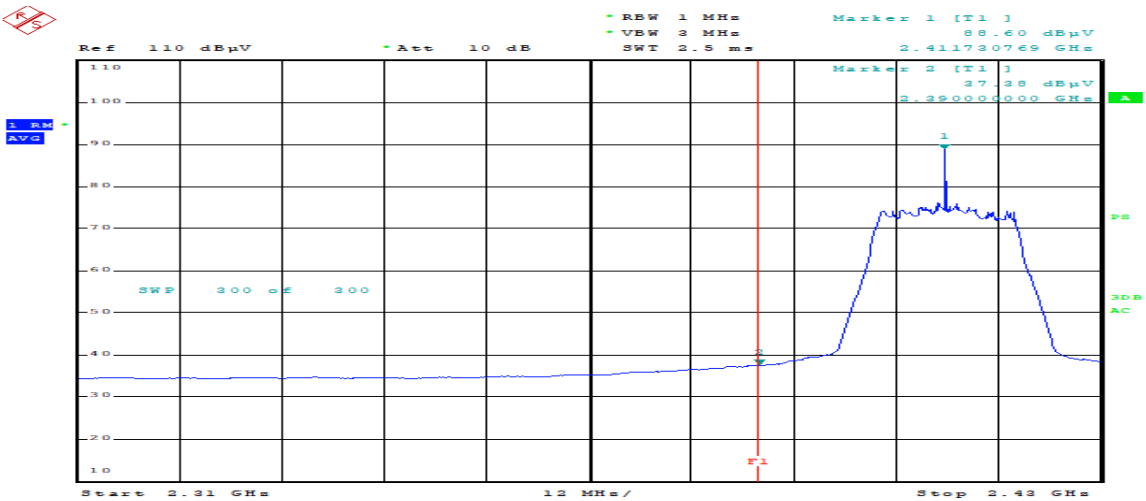

00260_11g_CH1_AV_VER

Band Edges(CH High)

Detector mode:Peak

Polarity:Horizontal

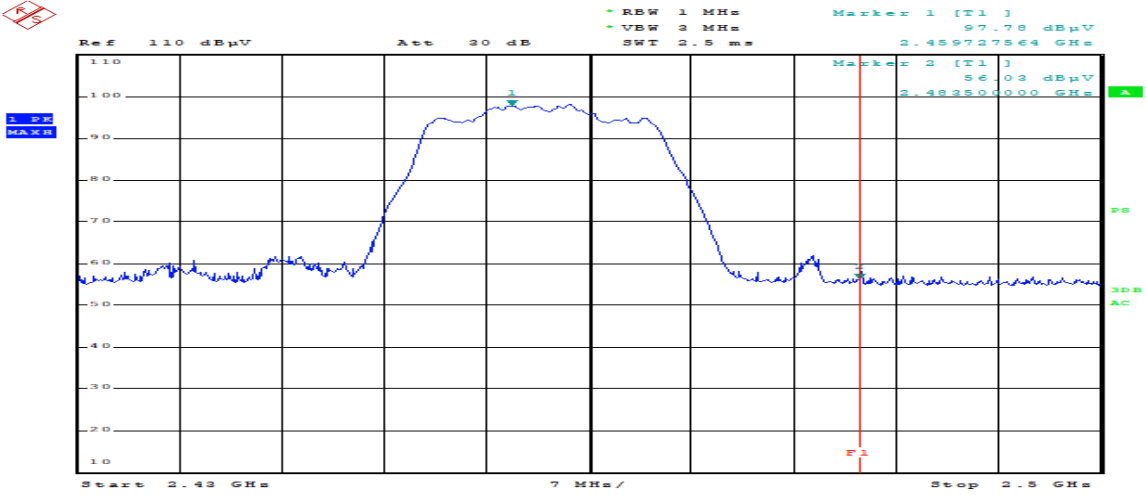

00260_11g_CH11_PEAK_HOR

Detector mode:Average

Polarity:Horizontal

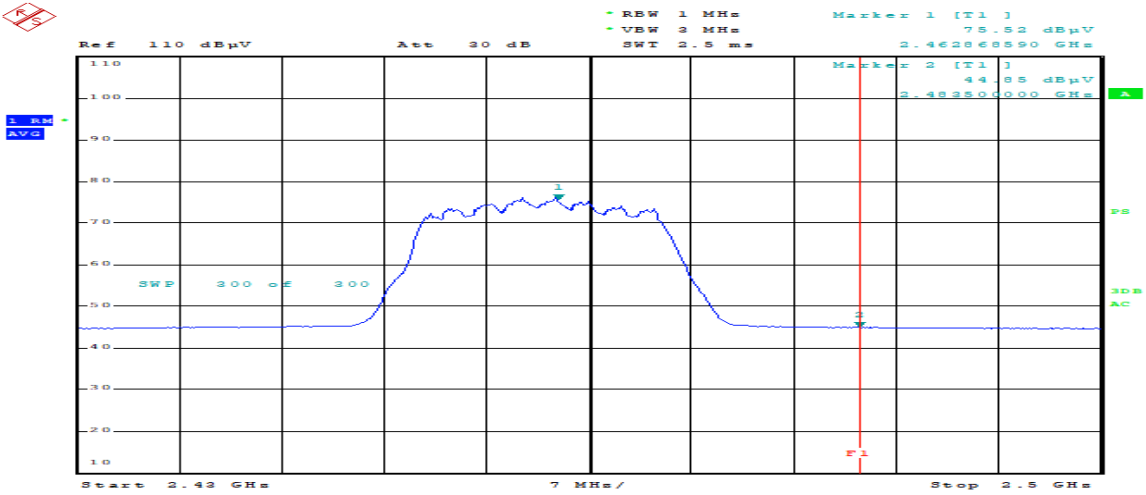

00260_11g_CH11_AV_HOR

Band Edges(CH High)

Detector mode:Peak

Polarity:Vertical

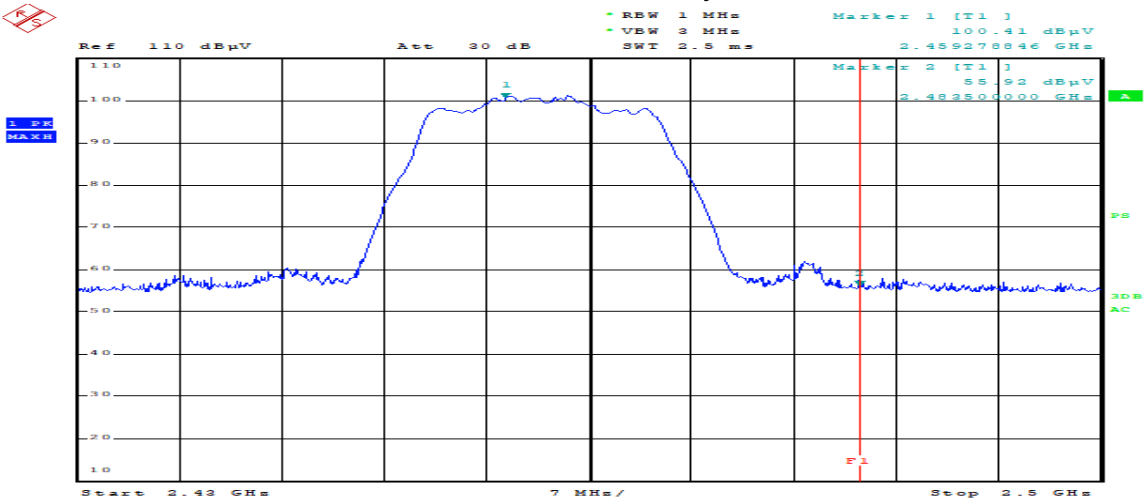

00260_11g_CH11_PEAK_VER

Detector mode:Average

Polarity:Vertical

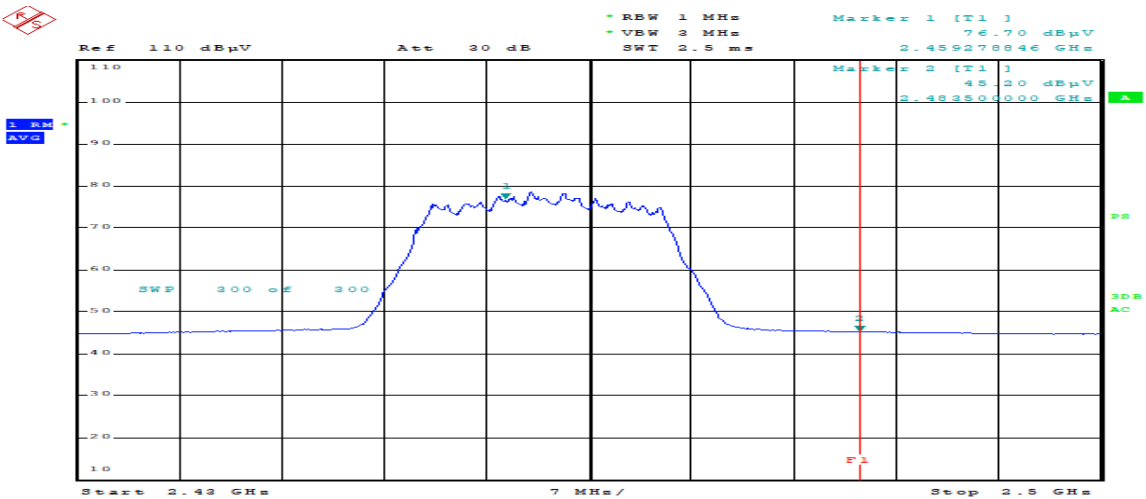

00260_11g_CH11_AV_VER

11. Measurement of conducted disturbance

The continuous disturbance voltage of AC Mains in the frequency from 0.15 MHz to 30 MHz was measured in accordance to FCC PART 15.207. The test setup was made according to ANSI C 63.10 (2009) in a shielded room. The EUT was placed on a non-conductive table at least 0.8 m above the ground plan. A grounded vertical reference plane was positioned in a distance of 0.4 m from the EUT. The distance from the EUT to other metal surfaces was at least 0.8 m. The EUT was only earthen by its power cord through the line impedance stabilizing network. The power cord has been bundled to a length of 1.0 m. The test receiver with Quasi Peak detector complies with CISPR 16.

11.1 Measurement equipments

Equipment Name	Type	Manufacturer	Serial No.	Next Calibration date
TEST RECEIVER	ESPI	Rohde & Schwarz	100005	9-Sep-20
LISN	ESH3-Z5	Rohde & Schwarz	836679/025	9-Sep-20
Pulse Limiter	ESH3Z2	Rohde & Schwarz	NONE	9-Sep-20

11.2 Environmental Condition

Test Place : Shielded Room

Temperature (°C) : 21.4 °C

Humidity (% R.H.) : 43.5 % R.H.

11.3-1 Test Data (802.11 b)

Test Date : 30-Sep-19

Frequency (MHz)	Correction Factor		Line (H/N)	Quasi-peak Value			Average Value		
	Lisn (dB)	Cable (dB)		Limit (dB μ V)	Reading (dB μ V)	Result (dB μ V)	Limit (dB μ V)	Reading (dB μ V)	Result (dB)
0.195	0.16	0.19	H	63.82	45.02	45.37	53.82	27.97	28.32
0.210	0.09	0.20	N	63.21	45.81	46.10	53.21	29.39	29.68
0.261	0.09	0.20	N	61.40	42.77	43.06	51.40	26.48	26.77
0.264	0.16	0.20	H	61.30	41.37	41.73	51.30	26.83	27.19
1.357	0.18	0.29	H	56.00	36.84	37.31	46.00	25.38	25.85
2.428	0.20	0.36	H	56.00	37.16	37.72	46.00	25.18	25.74
Remark	H : Hot Line, N : Neutral Line *Correction Factor = Lisn + Cable *Result = Correction Factor + Reading								

11.3-2 Test Data (802.11 g)

Test Date : 30-Sep-19

Frequency (MHz)	Correction Factor		Line (H/N)	Quasi-peak Value			Average Value		
	Lisn (dB)	Cable (dB)		Limit (dB μ V)	Reading (dB μ V)	Result (dB μ V)	Limit (dB μ V)	Reading (dB μ V)	Result (dB)
0.195	0.16	0.19	H	63.82	44.21	44.56	53.82	27.38	27.73
0.201	0.09	0.20	N	63.57	43.22	43.51	53.57	25.43	25.72
0.264	0.16	0.20	H	61.30	40.85	41.21	51.30	26.65	27.01
1.327	0.18	0.29	H	56.00	35.82	36.29	46.00	25.62	26.09
1.606	0.18	0.31	H	56.00	33.88	34.38	46.00	21.69	22.19
2.428	0.20	0.36	H	56.00	40.41	40.97	46.00	24.53	25.09
Remark	H : Hot Line, N : Neutral Line *Correction Factor = Lisn + Cable *Result = Correction Factor + Reading								

Appendix 1. Special diagram (802.11 b)

* HOT LINE



RBW 9 kHz
MT 1 s
PREAMP OFF

Att 10 dB AUTO

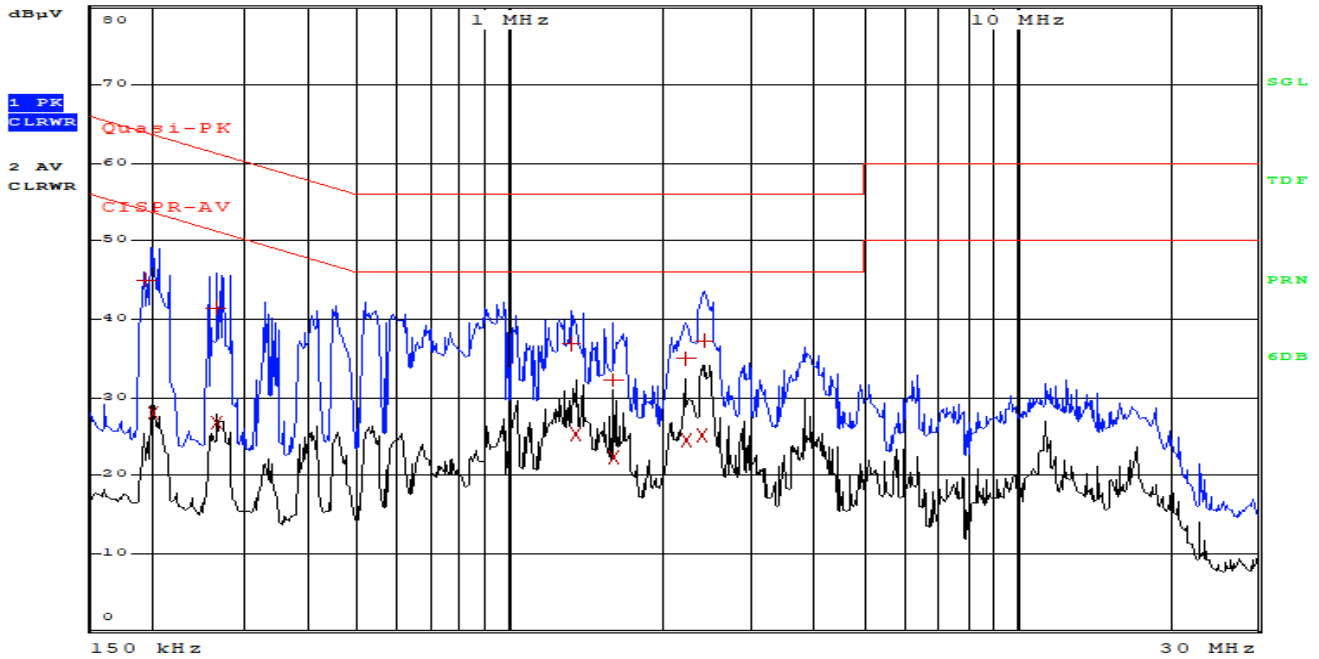

Comment: ESTR-19-00260_H

* NEUTRAL LINE



RBW 9 kHz
MT 1 s
PREAMP OFF

Att 10 dB AUTO

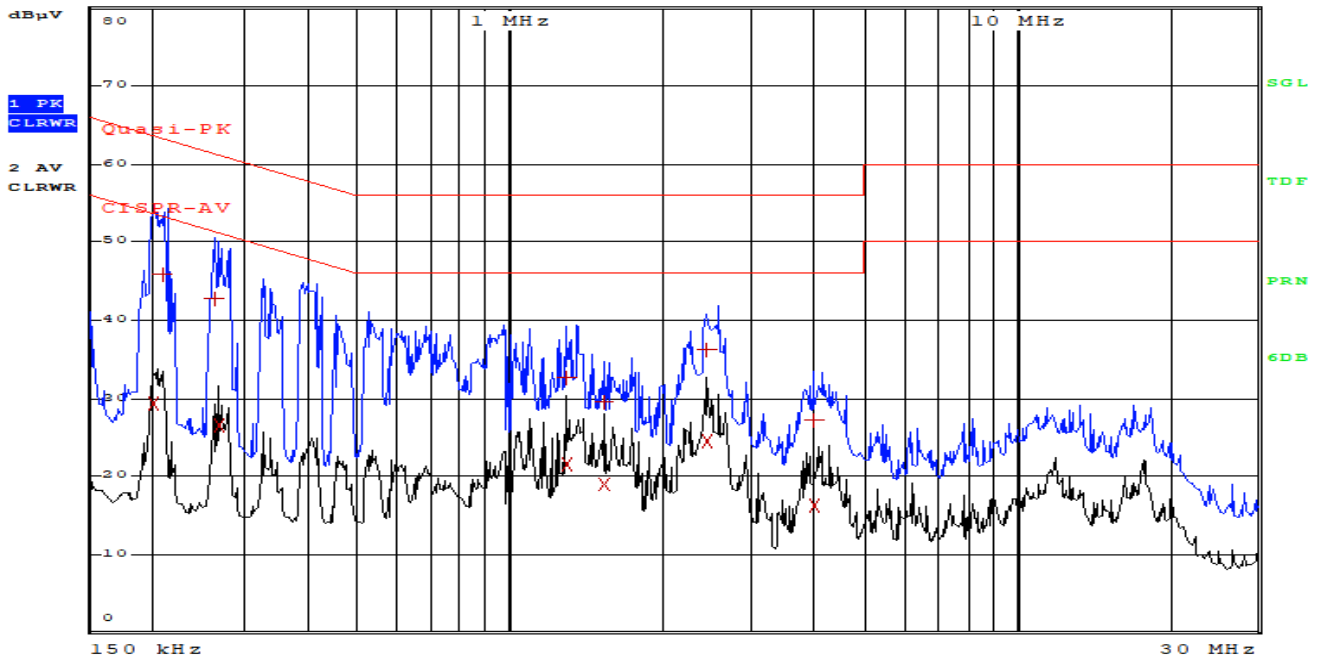

Comment: ESTR-19-00260_N

Appendix 1. Special diagram (802.11 g)

* HOT LINE



RBW 9 kHz

MT 1 s

Att 10 dB AUTO PREAMP OFF

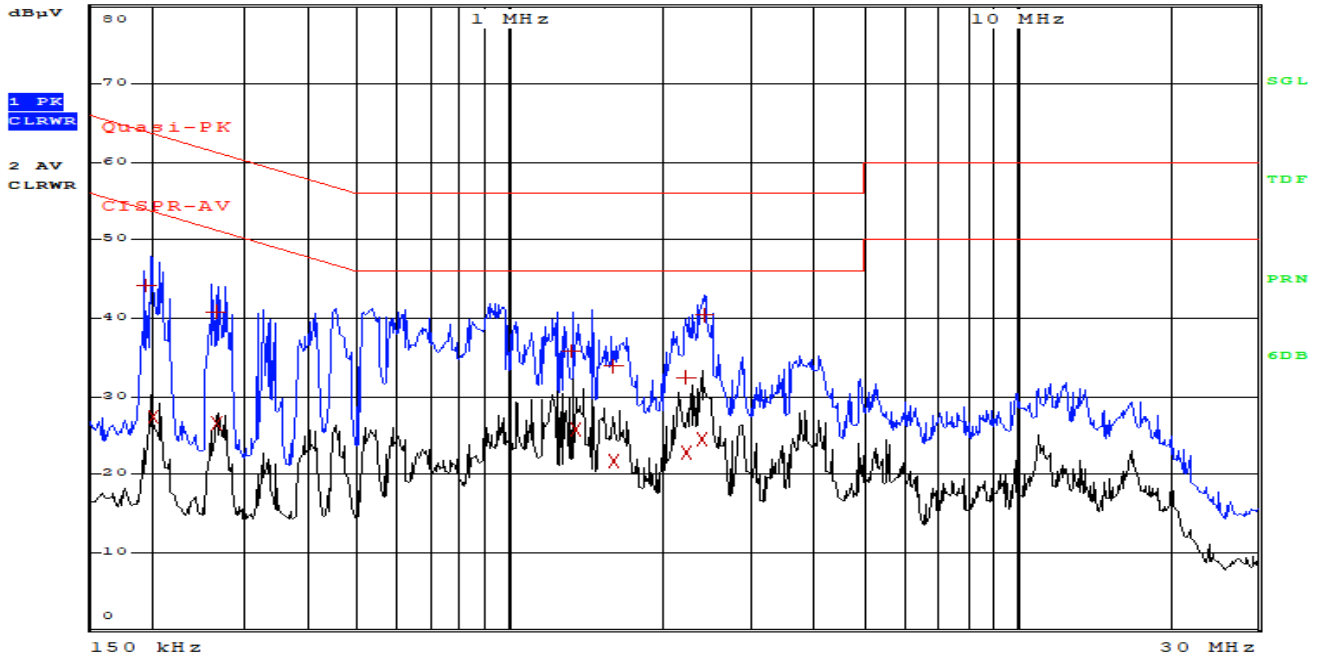

Comment: ESTR-19-00260_H

* NEUTRAL LINE



RBW 9 kHz

MT 1 s

Att 10 dB AUTO PREAMP OFF

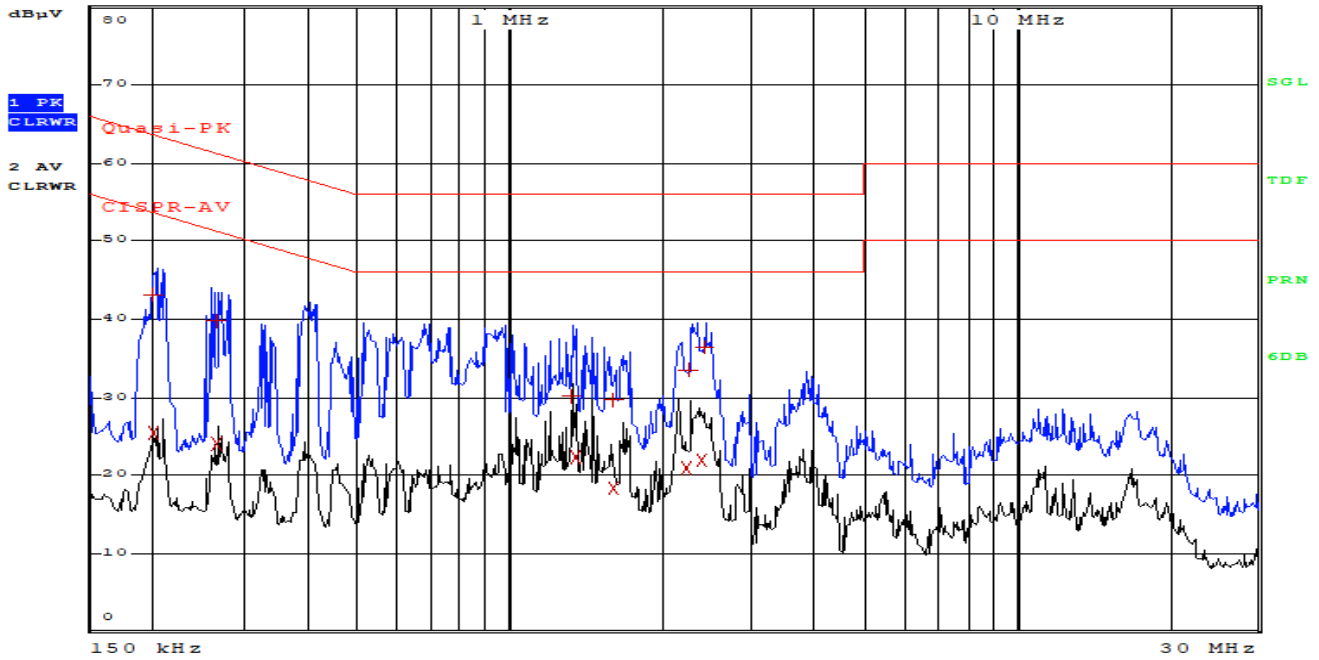

Comment: ESTR-19-00260_N

Appendix 3. Antenna Requirement

1. Antenna Requirement

1.1 Standard Applicable

For intentional device, according to FCC 47 CFR Section 15.203, an intentional radiator shall be designed to ensure that no antenna other than that furnished by the responsible party shall be used with the device.

And according to FCC 47 CFR Section 15.204

1.2 Antenna Connected Construction

The antenna types used in this product are Dual Band Directional antenna . The maximum Gain of this antenna is 2.68 dBi.