

FCC CERTIFICATION TEST REPORT

FOR

Applicant	:	Nissin Industries Ltd.
Address	:	Flat B, 13/F., North point Ind. Bldg., 499 King's Rd., North Point. HK
Equipment under Test	:	Air10s
Model No.	:	Air10s
Trade Mark	:	N/A
FCC ID	:	2AD52AIR10S
Manufacturer	:	NISSIN ELECTRONICS (SHENZHEN) LTD.
Address	:	Building 20, Tong Fu Yu Industrial Zone, Xin Ho, Fu Yong Street, Shenzhen, Guangdong, China

Issued By: Dongguan Dongdian Testing Service Co., Ltd.

Add: No. 17, Zongbu Road 2, Songshan Lake Sci&Tech, Industry Park, Dongguan City,
Guangdong Province, China, 523808

Tel: +86-0769-89201699 **E-mail:** ddt@dgddt.com <http://www.dgddt.com>

TABLE OF CONTENTS

	Test report declares.....	4
1.	Summary of test results	4
2.	General test information	5
2.1.	Description of EUT	5
2.2.	Accessories of EUT.....	5
2.3.	Assistant equipment used for test.....	5
2.4.	Block diagram of EUT configuration for test	5
2.5.	Test environment conditions	6
2.6.	Deviations of test standard	6
2.7.	Test laboratory.....	6
2.8.	Measurement uncertainty	6
3.	Equipment used during test.....	7
4.	20dB Bandwidth.....	8
4.1.	Block diagram of test setup	8
4.2.	Limits	8
4.3.	Test Procedure.....	8
4.4.	Test Result.....	8
4.5.	Original test data	9
5.	Radiated emission	10
5.1.	Block diagram of test setup	10
5.2.	Limit.....	11
5.3.	Test Procedure.....	12
5.4.	Test result	12
6.	Band Edge Compliance.....	17
6.1.	Block diagram of test setup	17
6.2.	Limit.....	17
6.3.	Test Procedure.....	17
6.4.	Test result	17
7.	Power Line Conducted Emission	22
7.1.	Block diagram of test setup	22
7.2.	Power Line Conducted Emission Limits.....	22
7.3.	Test Procedure.....	22
7.4.	Test Result.....	23
8.	Antenna Requirements	24
8.1.	Limit.....	24
8.2.	Result.....	24

TEST REPORT DECLARE

Applicant	:	Nissin Industries Ltd.
Address	:	Flat B, 13/F., North point Ind. Bldg., 499 King's Rd., North Point. HK
Equipment under Test	:	Air10s
Model No.	:	Air10s
Trade mark	:	N/A
Manufacturer	:	NISSIN ELECTRONICS (SHENZHEN) LTD.
Address	:	Building 20, Tong Fu Yu Industrial Zone, Xin Ho, Fu Yong Street, Shenzhen, Guangdong, China

Test Standard Used:

FCC Rules and Regulations Part 15 Subpart C

Test procedure used:

ANSI C63.10:2013

We Declare:

The equipment described above is tested by Dongguan Dongdian Testing Service Co., Ltd. and in the configuration tested the equipment complied with the standards specified above. The test results are contained in this test report and Dongguan Dongdian Testing Service Co., Ltd. is assumed of full responsibility for the accuracy and completeness of these tests.

After test and evaluation, our opinion is that the equipment provided for test compliance with the requirement of the above FCC standards.

Report No:	SK-1688		
Date of Test:	Aug. 09, 2017~Oct. 10, 2017	Date of Report:	Oct. 10, 2017

Prepared By:

Sam Li

Sam Li/Engineer

Approved By:



Kevin Feng/EMC Manager

Note: This report applies to above tested sample only. This report shall not be reproduced in parts without written approval of Dongguan Dongdian Testing Service Co., Ltd.

1. Summary of test results

The EUT have been tested according to the applicable standards as referenced below.		
Description of Test Item	Standard	Results
20dB Bandwidth	FCC Part 15: 15.215 ANSI C63.10:2013	PASS
Radiated Emission	FCC Part 15: 15.209 FCC Part 15: 15.249 ANSI C63.10:2013	PASS
Band Edge Compliance	FCC Part 15: 15.249 ANSI C63.10:2013	PASS
Power Line Conducted Emission	FCC Part 15: 15.207 ANSI C63.10: 2013	N/A

N/A is an abbreviation for Not Applicable.

2. General test information

2.1. Description of EUT

EUT* Name	: Air10s
Model Number	: Air10s
EUT function description	: Please reference user manual of this device
Power supply	: DC 3V from battery (2*”AAA” battery)
Operation frequency	: 2409MHz -2476MHz
Modulation	: GFSK
Data rate	: 2Mbps
Antenna Type	: Integrated PCB Antenna, maximum PK gain: 0dBi
Sample Type	: Series production

Note: EUT is the ab. of equipment under test.

EUT channels and frequencies list:

Channel	Frequency (MHz)
1	2409
2	2419
3	2429
4	2449
5	2459
6	2469
7	2476

2.2. Accessories of EUT

Description of Accessories	Manufacturer	Model number	Serial No.	Other
N/A	N/A	N/A	N/A	N/A

2.3. Assistant equipment used for test

Assistant equipment	Manufacturer	Model number	Serial No.	Other
N/A	N/A	N/A	N/A	N/A

2.4. Block diagram of EUT configuration for test

Tx Mode:



For Tx Mode, A special test firmware was installed in EUT and which can exercise the EUT work in continues RF test mode at specified test channel as below:

Note: New battery is used during all test

Tested mode, channel, information		
Mode	Channel	Frequency (MHz)
GFSK Tx mode	CH1	2409
	CH4	2449
	CH7	2476

2.5. Test environment conditions

During the measurement the environmental conditions were within the listed ranges:

Temperature range:	21-25°C
Humidity range:	40-75%
Pressure range:	86-106kPa

2.6. Deviations of test standard

No Deviation.

2.7. Test laboratory

Dongguan Dongdian Testing Service Co., Ltd

Add: No. 17, Zongbu Road 2, Songshan Lake Sci&Tech, Industry Park, Dongguan City, Guangdong Province, China, 523808 Tel: +86-0769-89201699 <http://www.dgddt.com>

CNAS Accreditation No. L6451; A2LA Accreditation No. 3870.01

Designation Number: CN1182; Test Firm Registration Number: 540522

Industry Canada site registration number: 10288A-1

2.8. Measurement uncertainty

Test Item	Uncertainty
Bandwidth	1.1%
Peak Output Power(Conducted)(Spectrum analyzer)	0.86dB(10 MHz ≤ f < 3.6GHz);
	1.38dB(3.6GHz ≤ f < 8GHz)
Peak Output Power(Conducted)(Power Sensor)	0.74dB
Power Spectral Density	0.74dB(10 MHz ≤ f < 3.6GHz);
	1.38dB(3.6GHz ≤ f < 8GHz)
Conducted spurious emissions	0.86dB(10 MHz ≤ f < 3.6GHz);
	1.40dB(3.6GHz ≤ f < 8GHz)
	1.66dB(8GHz ≤ f < 22GHz)
Uncertainty for radio frequency (RBW<20KHz)	3×10 ⁻⁸
Temperature	0.4°C
Humidity	2%
Uncertainty for Radiation Emission test (30MHz-1GHz)	4.70 dB (Antenna Polarize: V)
	4.84 dB (Antenna Polarize: H)
Uncertainty for Radiation Emission test (1GHz-18GHz)	4.10dB(1-6GHz)
	4.40dB (6GHz-18Gz)
Uncertainty for Power line conduction emission test	3.32dB (150KHz-30MHz)
Note: This uncertainty represents an expanded uncertainty expressed at approximately the 95% confidence level using a coverage factor of k=2.	

3. Equipment used during test

Equipment	Manufacturer	Model No.	Serial No.	Last Cal.	Cal. Interval
RF Connected Test					
Spectrum analyzer	R&S	FSU26	1166.1660.26	Oct. 16, 2016	1Year
Vector Signal Generator	Agilent	E8267D	MY52098743	Oct. 20, 2016	1Year
Vector Signal Generator	Agilent	N5182A	MY48180737	Jun. 16, 2017	1Year
Power Sensor	Agilent	U2021XA	MY55150010	Apr. 18, 2017	1Year
Power Sensor	Agilent	U2021XA	MY55150011	Apr. 19, 2017	1Year
DC Power Source	MATRIS	MPS-3005L-3	D813058W	Oct. 24, 2016	1Year
Attenuator	Mini-Circuits	BW-S10W2	101109	Aug. 18, 2016	1Year
Attenuator	Mini-Circuits	BW-S10W2	101109	Aug. 18, 2017	1Year
RF Cable	Micable	C10-01-01-1	100309	Aug. 18, 2016	1Year
RF Cable	Micable	C10-01-01-1	100309	Aug. 18, 2017	1Year
Test Software	JS Tonscend	JS1120-2	Ver.2.5	N/A	N/A
USB Data acquisition	Agilent	U2531A	TW55043503	N/A	N/A
Auto control Unit	JS Tonscend	JS0806-2	158060010	N/A	N/A
Radiated Emission Test					
EMI Test Receiver	R&S	ESU8	100316	Oct. 16, 2016	1Year
Spectrum analyzer	R&S	FSU26	1166.1660.26	Oct. 16, 2016	1Year
Trilog Broadband Antenna	Schwarzbeck	VULB9163	9163-462	Oct. 27, 2016	1 Year
Active Loop antenna	Schwarzbeck	FMZB-1519	1519-038	Oct. 16, 2016	1 Year
Double Ridged Horn Antenna	R&S	HF907	100276	Oct. 12, 2016	1 Year
Pre-amplifier	A.H.	PAM-0118	360	Oct. 16, 2016	1 Year
RF Cable	HUBSER	CP-X2	W11.03	Oct. 16, 2016	1Year
RF Cable	HUBSER	CP-X1	W12.02	Oct. 16, 2016	1 Year
MI Cable	HUBSER	C10-01-01-1M	1091629	Oct. 16, 2016	1 Year
Test software	Audix	E3	V 6.11111b	N/A	N/A
Power Line Conducted Emissions Test					
Test Receiver	R&S	ESU8	100316	Oct. 16, 2016	1 Year
LISN 1	R&S	ENV216	101109	Oct. 16, 2016	1 Year
LISN 2	R&S	ESH2-Z5	100309	Oct. 16, 2016	1 Year
Pulse Limiter	R&S	ESH3-Z2	101242	Oct. 16, 2016	1 Year
CE Cable 1	HUBSER	ESU8/RF2	W10.01	Oct. 16, 2016	1 Year
Test software	Audix	E3	V 6.11111b	N/A	N/A

4. 20dB Bandwidth

4.1. Block diagram of test setup

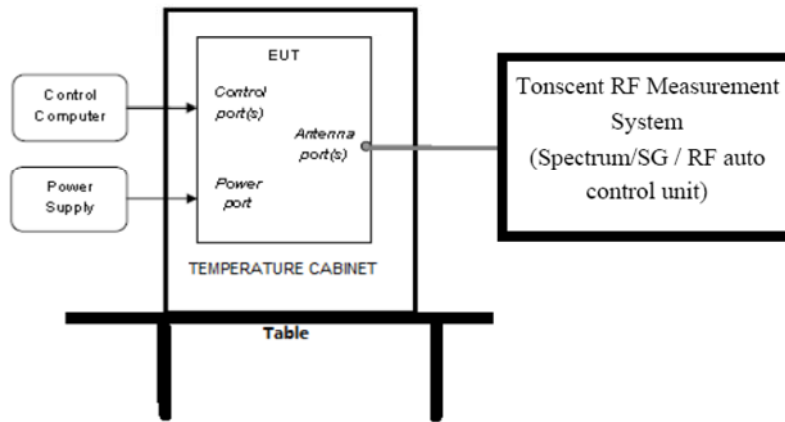

4.2. Limits

Intentional radiators operating under the alternative provisions to the general emission limits, as contained in § 15.217 through 15.257 and in Subpart E of this part, must be designed to ensure that the 20 dB bandwidth of the emission, or whatever bandwidth may otherwise be specified in the specific rule section under which the equipment operates, is contained within the frequency band designated in the rule section under which the equipment is operated.

4.3. Test Procedure

- (1) Connect EUT's antenna output to spectrum analyzer by RF cable.
- (2) Set the spectrum analyzer as follows:

RBW:	100KHz
VBW:	300KHz
Detector Mode:	Peak
Sweep time:	auto
Trace mode	Max hold
- (3) Allow the trace to stabilize, measure the 6dB and 99% bandwidth of signal.

4.4. Test Result

Mode	Freq (MHz)	20dB bandwidth Result (MHz)	Limit (MHz)	Conclusion
GFSK	2409	2.532	/	PASS
	2449	2.532	/	PASS
	2476	3.494	/	PASS

4.5. Original test data

Graphs	
LCH 2409	
MCH 2449	
HCH 2476	

5. Radiated emission

5.1. Block diagram of test setup

In 3m Anechoic Chamber Test Setup Diagram for 9KHz-30MHz

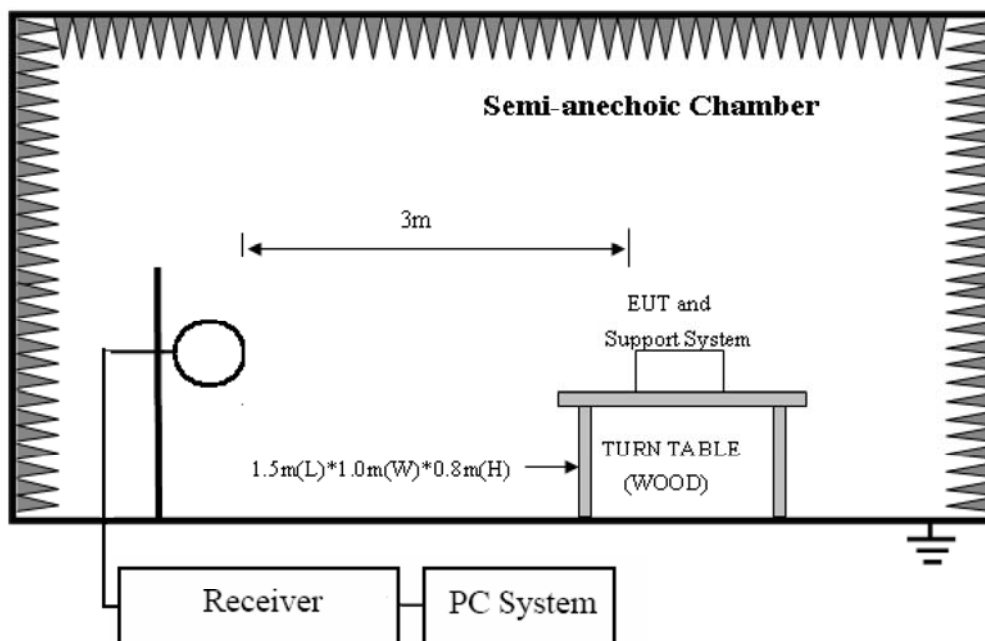

In 3m Anechoic Chamber Test Setup Diagram for 30MHz-1GHz

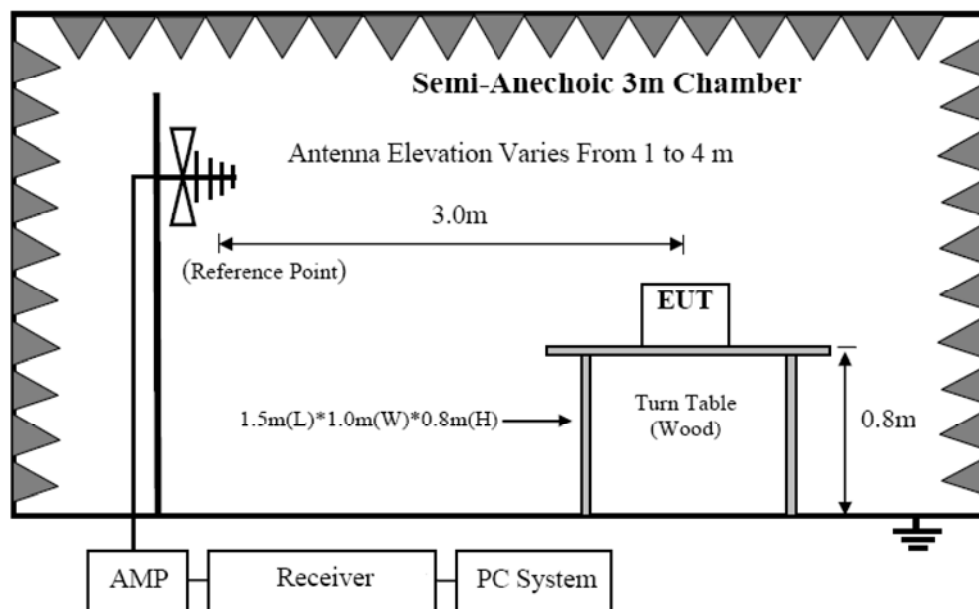

In 3m Anechoic Chamber Test Setup Diagram for frequency above 1GHz

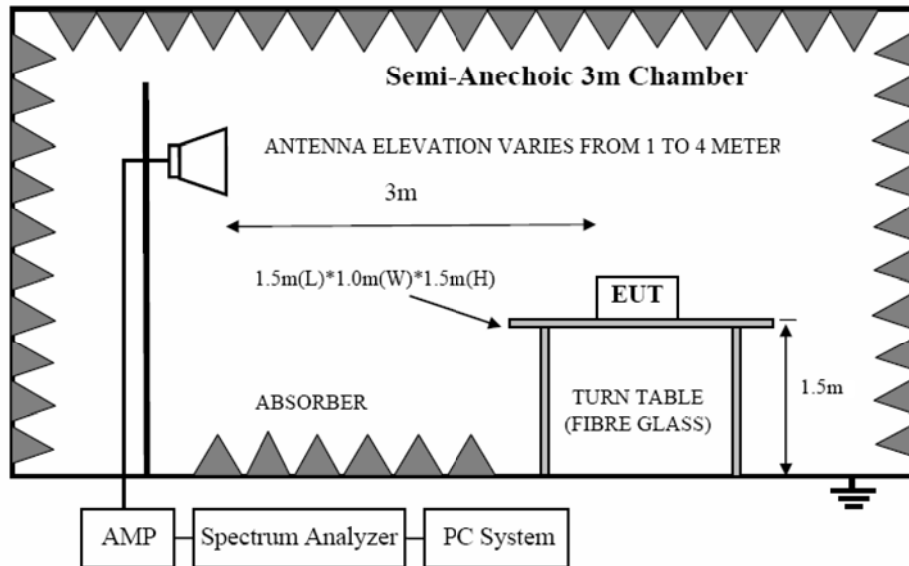

Note: For harmonic emissions test a appropriate high pass filter was inserted in the input port of AMP.

5.2. Limit

FREQUENCY MHz	DISTANCE Meters	FIELD STRENGTHS LIMIT	
		$\mu\text{V}/\text{m}$	$\text{dB}(\mu\text{V})/\text{m}$
30 ~ 88	3	100	40.0
88 ~ 216	3	150	43.5
216 ~ 960	3	200	46.0
960 ~ 1000	3	500	54.0
Above 1000MHz	3	74.0 $\text{dB}(\mu\text{V})/\text{m}$ (Peak) 54.0 $\text{dB}(\mu\text{V})/\text{m}$ (Average)	
Field Strength of Fundamental emission for 2.4GHz-2.4835GHz	3	94.0 $\text{dB}(\mu\text{V})/\text{m}$ (Average) 114.0 $\text{dB}(\mu\text{V})/\text{m}$ (Peak)	
Field Strength of Harmonics	3	74.0 $\text{dB}(\mu\text{V})/\text{m}$ (Peak) 54.0 $\text{dB}(\mu\text{V})/\text{m}$ (Average)	

Remark:

- (1) Emission level $\text{dB}\mu\text{V} = 20 \log$ Emission level $\mu\text{V}/\text{m}$
- (2) The smaller limit shall apply at the cross point between two frequency bands.
- (3) Distance is the distance in meters between the measuring instrument, antenna and the closest point of any part of the device or system.
- (4) The emission limits shown in the above table are based on measurements employing a CISPR quasi-peak detector except for the frequency bands 9-90 kHz, 110-490 kHz and above 1000 MHz. Radiated emission limits in these three bands are based on measurements employing an average detector.

5.3. Test Procedure

- (1) EUT was placed on a non-metallic table, 80 cm above the ground plane inside a semi-anechoic chamber.
- (2) Setup EUT and assistant system according clause 2.3 and 4.2
- (3) Test antenna was located 3m from the EUT on an adjustable mast. Below pre-scan procedure was first performed in order to find prominent radiated emissions.
 - (a) Change work frequency or channel of device if practicable.
 - (b) Change modulation type of device if practicable.
 - (c) Change power supply range from 85% to 115% of the rated supply voltage
 - (d) Rotated EUT though three orthogonal axes to determine the attitude of EUT arrangement produces highest emissions
- (4) Spectrum frequency from 9KHz to 25GHz (tenth harmonic of fundamental frequency) was investigated, and no any obvious emission were detected from 9KHz to 30MHz and 18GHz to 25GHz, so below final test was performed with frequency range from 30MHz to 18GHz.
- (5) For final emissions measurements at each frequency of interest, the EUT were rotated and the antenna height was varied between 1m and 4m in order to maximize the emission. Measurements in both horizontal and vertical polarities were made and the data was recorded. In order to find the maximum emission, the relative positions of equipments and all of the interface cables were changed according to ANSI C63.10 2013 on Radiated Emission test.
- (6) For emissions from 30MHz to 1GHz, Quasi-Peak values were measured with EMI Receiver and the bandwidth of Receiver is 120 KHz.
- (7) For emissions above 1GHz, both Peak and Average level were measured with Spectrum Analyzer, and the RBW is set at 1MHz, VBW is set at 3MHz for Peak measure; RBW is set at 1MHz, VBW is set at 10Hz for Average measure. Peak detector is used for both PK and AV test.
- (8) For fundamental frequency test, set spectrum analyzer's RBW=5MHz, VBW=10MHz. peak detector for PK, RMS detector for AV, Read the Level in spectrum analyzer and record.
- (9) X axis, Y axis, Z axis are tested, and worse setup X axis is reported.

5.4. Test result

PASS. (See below detailed test result)

All the emissions except fundamental emission from 9KHz to 25GHz were comply with 15.209 limit.

Note1: According exploratory test no any obvious emission were detected from 9KHz to 30MHz and 18GHz to 25GHz, so the final test was performed with frequency range from 30MHz to 18GHz and recorded in below.

Note2: For emissions below 1GHz, according exploratory explorer test, when change Tx mode and channel, have no distinct influence on emissions level, so for emissions below 1GHz, the final test was only performed with EUT working in GFSK, Tx 2449MHz mode.

Note3: For emissions above 1GHz. If peak results comply with AV limit, AV Result is deemed to comply with AV limit.

Radiated Emission test (below 1GHz)

TR-4-E-009 Radiated Emission Test Result

Test Site : DDT 3m Chamber 1# Y:\2017 RE1# Report Data\Q17080703-01\RF-FCC30M-13G.EM6
Test Date : 2017-08-17 **Tested By** : Sunny
EUT : Air10s **Model Number** : Air10s
Power Supply : DC 3.0V **Test Mode** : TX mode
Condition : Temp:24.5°C,Humi:55%,
 : Press:100.1kPa **Antenna/Distance** : 2016 VULB9163 1#/3m/HORIZONTAL
Memo :

Data: 14

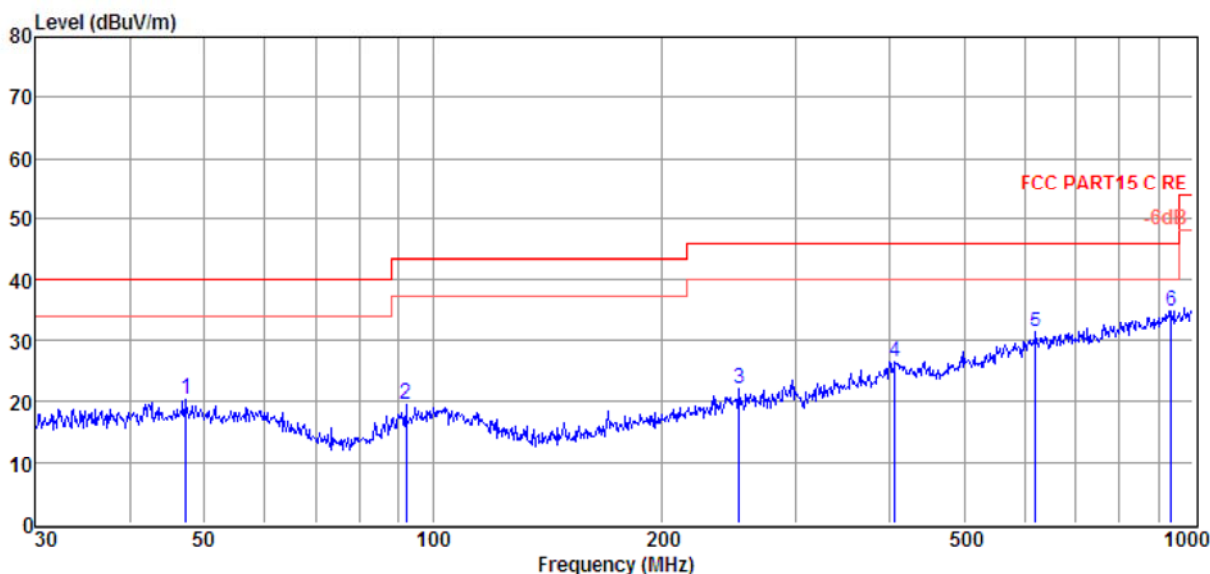

Item (Mark)	Freq. (MHz)	Read Level (dBμV)	Antenna Factor (dB/m)	Cable Loss (dB)	Result Level (dBμV/m)	Limit Line (dBμV/m)	Over Limit (dB)	Detector	Polarization
1	47.33	4.15	12.27	3.86	20.28	40.00	-19.72	Peak	HORIZONTAL
2	92.14	4.09	11.09	4.24	19.42	43.50	-24.08	Peak	HORIZONTAL
3	252.95	4.42	12.30	5.15	21.87	46.00	-24.13	Peak	HORIZONTAL
4	406.09	4.73	15.82	5.82	26.37	46.00	-19.63	Peak	HORIZONTAL
5	620.71	5.31	19.40	6.58	31.29	46.00	-14.71	Peak	HORIZONTAL
6	935.55	4.58	22.87	7.51	34.96	46.00	-11.04	Peak	HORIZONTAL

Note: 1. Result Level = Read Level + Antenna Factor + Cable loss.
 2. If Peak Result complies with QP limit, QP Result is deemed to comply with QP limit.
 3. Test setup: RBW: 120 kHz, VBW: 300 kHz, Sweep time: auto.

TR-4-E-009 Radiated Emission Test Result

Test Site : DDT 3m Chamber 1# Y:\2017 RE1# Report Data\Q17080703-01E\RF-FCC30M-13G.EM6
Test Date : 2017-08-17 **Tested By** : Sunny
EUT : Air10s **Model Number** : Air10s
Power Supply : DC 3.0V **Test Mode** : TX mode
Condition : Temp:24.5°C,Humi:55%,
 : Press:100.1kPa **Antenna/Distance** : 2016 VULB9163 1#/3m/VERTICAL
Memo :

Data: 13

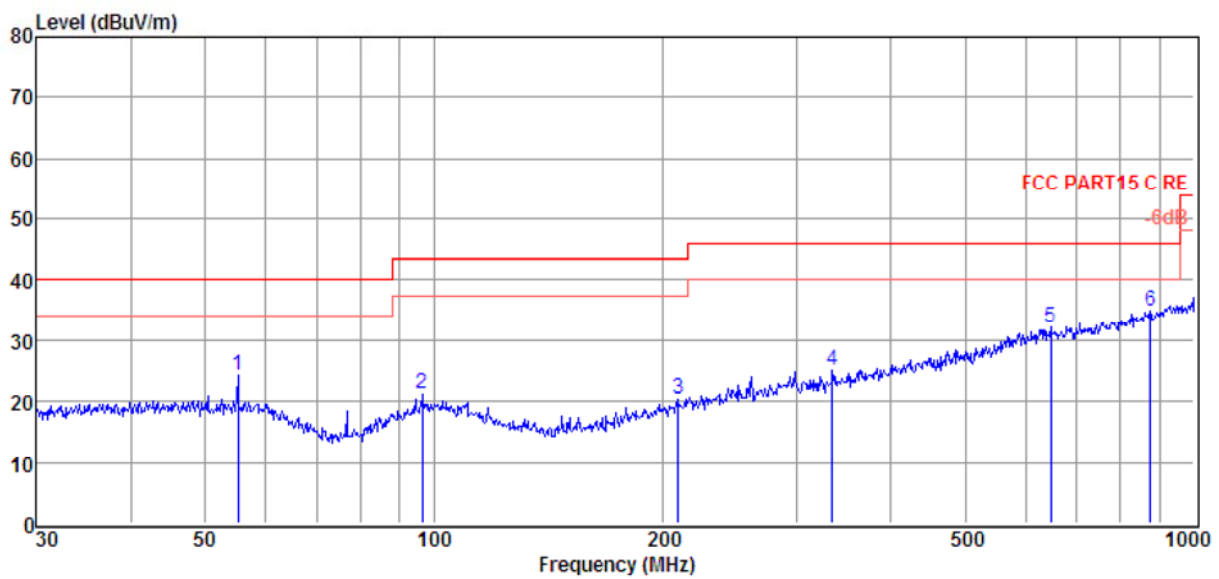

Item (Mark)	Freq. (MHz)	Read Level (dBμV)	Antenna Factor (dB/m)	Cable Loss (dB)	Result Level (dBμV/m)	Limit Line (dBμV/m)	Over Limit (dB)	Detector	Polarization
1	55.22	8.57	11.64	3.93	24.14	40.00	-15.86	Peak	VERTICAL
2	96.44	5.14	11.72	4.27	21.13	43.50	-22.37	Peak	VERTICAL
3	210.05	4.47	10.80	4.95	20.22	43.50	-23.28	Peak	VERTICAL
4	334.86	5.24	14.29	5.53	25.06	46.00	-20.94	Peak	VERTICAL
5	647.39	6.10	19.45	6.66	32.21	46.00	-13.79	Peak	VERTICAL
6	875.25	5.55	22.05	7.35	34.95	46.00	-11.05	Peak	VERTICAL

- Note: 1. Result Level = Read Level + Antenna Factor + Cable loss.
 2. If Peak Result complies with QP limit, QP Result is deemed to comply with QP limit.
 3. Test setup: RBW: 120 kHz, VBW: 300 kHz, Sweep time: auto.

Radiated Emission test (above 1GHz)

Freq. (MHz)	Read level (dB μ V)	Antenna Factor (dB/m)	PRM Factor (dB)	Cable Loss (dB)	Result Level (dB μ V/m)	Limit (dB μ V/ m)	Margi n (dB)	Detector type	Polarization
GFSK Tx mode 2409MHz									
2409.00	95.20	29.83	29.44	6.03	101.62	114.00	-12.38	Peak	HORIZONTAL
2409.00	AV=PK-29.22=101.62-29.22=72.40					94.00	-21.60	Average	HORIZONTAL
4818.00	53.85	33.74	29.32	8.46	66.73	74.00	-7.27	Peak	HORIZONTAL
4818.00	AV=PK-29.22=66.73-29.22=37.51					54.00	-16.49	Average	HORIZONTAL
7227.00	35.90	36.37	30.49	10.60	52.38	74.00	-21.62	Peak	HORIZONTAL
9636.00	42.69	36.51	32.73	12.37	58.84	74.00	-15.16	Peak	HORIZONTAL
9636.00	AV=PK-29.22=58.84-29.22=29.62					54.00	-24.38	Average	HORIZONTAL
12100.00	34.00	37.74	34.87	14.30	51.17	74.00	-22.83	Peak	HORIZONTAL
2409.00	91.20	29.83	29.44	6.03	97.62	114.00	-16.38	Peak	VERTICAL
2409.00	AV=PK-29.22=97.62-29.22=68.40					94.00	-25.60	Average	VERTICAL
4818.00	41.81	33.74	29.32	8.46	54.69	74.00	-19.31	Peak	VERTICAL
4818.00	AV=PK-29.22=54.69-29.22=25.47					54.00	-28.53	Average	VERTICAL
7227.00	36.11	36.37	30.49	10.60	52.59	74.00	-21.41	Peak	VERTICAL
9636.00	46.02	36.51	32.73	12.37	62.17	74.00	-11.83	Peak	VERTICAL
9636.00	AV=PK-29.22=62.17-29.22=32.95					54.00	-21.05	Average	VERTICAL
12016.00	35.95	37.62	34.80	14.24	53.01	74.00	-20.99	Peak	VERTICAL
GFSK Tx mode 2449MHz									
2449.00	96.09	29.97	29.54	6.10	102.62	114.00	-11.38	Peak	HORIZONTAL
2449.00	AV=PK-29.22=102.62-29.22=73.40					94.00	-20.60	Average	HORIZONTAL
4898.00	57.21	33.72	29.33	8.58	70.18	74.00	-3.82	Peak	HORIZONTAL
4898.00	AV=PK-29.22=70.18-29.22=40.96					54.00	-13.04	Average	HORIZONTAL
7347.00	39.09	36.48	30.61	10.72	55.68	74.00	-18.32	Peak	HORIZONTAL
7347.00	AV=PK-29.22=55.68-29.22=26.46					54.00	-27.54	Average	HORIZONTAL
9796.00	40.16	36.70	32.84	12.41	56.43	74.00	-17.57	Peak	HORIZONTAL
9796.00	AV=PK-29.22=56.43-29.22=27.21					54.00	-26.79	Average	HORIZONTAL
2449.00	92.68	29.97	29.54	6.10	99.21	114.00	-14.79	Peak	VERTICAL
2449.00	AV=PK-29.22=99.21-29.22=69.99					94.00	-24.01	Average	VERTICAL
4898.00	48.58	33.72	29.33	8.58	61.55	74.00	-12.45	Peak	VERTICAL
4898.00	AV=PK-29.22=61.55-29.22=32.33					54.00	-21.67	Average	VERTICAL
7347.00	44.89	36.47	30.59	10.72	61.49	74.00	-12.51	Peak	VERTICAL
7347.00	AV=PK-29.22=61.49-29.22=32.27					54.00	-21.73	Average	VERTICAL
9796.00	42.04	36.70	32.84	12.41	58.31	74.00	-15.69	Peak	VERTICAL
9796.00	AV=PK-29.22=58.31-29.22=29.09					54.00	-24.91	Average	VERTICAL
GFSK Tx mode 2476MHz									
2476.00	95.53	30.11	29.69	6.13	102.08	114.00	-11.92	Peak	HORIZONTAL
2476.00	AV=PK-29.22=102.08-29.22=72.86					94.00	-21.14	Average	HORIZONTAL
4952.00	51.54	33.71	29.35	8.63	64.53	74.00	-9.47	Peak	HORIZONTAL
4952.00	AV=PK-29.22=64.53-29.22=35.31					54.00	-18.69	Average	HORIZONTAL
7428.00	38.37	36.56	30.73	10.81	55.01	74.00	-18.99	Peak	HORIZONTAL
7428.00	AV=PK-29.22=55.01-29.22=25.79					54.00	-28.21	Average	HORIZONTAL
9904.00	44.72	36.81	32.88	12.42	61.07	74.00	-12.93	Peak	HORIZONTAL
9904.00	AV=PK-29.22=61.07-29.22=31.85					54.00	-22.15	Average	HORIZONTAL
2476.00	89.60	30.11	29.69	6.13	96.15	114.00	-17.85	Peak	VERTICAL

2476.00	AV=PK-29.22=96.15-29.22=66.93					94.00	-27.07	Average	VERTICAL
4952.00	40.76	33.71	29.35	8.63	53.75	74.00	-20.25	Peak	VERTICAL
7428.00	45.75	36.56	30.73	10.81	62.39	74.00	-11.61	Peak	VERTICAL
7428.00	AV=PK-29.22=62.39-29.22=33.17					54.00	-20.83	Average	VERTICAL
9904.00	45.65	36.81	32.88	12.42	62.00	74.00	-12.00	Peak	VERTICAL
9904.00	AV=PK-29.22=62.00-29.22=32.78					54.00	-21.22	Average	VERTICAL
10960.00	32.65	37.69	33.92	13.45	49.87	74.00	-24.13	Peak	VERTICAL
Result: Pass									

Note: 1. Result Level = Read Level + Antenna Factor + Cable loss - PRM Factor.

2. Average value=Peak value + PDCF, since the PDCF<-20dB, so the Average value is complied with the AV limit.

Average value:	
Calculate Formula:	Average value=Peak value + PDCF
	PDCF=20 log(Duty cycle)
	Duty cycle= T on time / T period
Test data:	Ton time =0.173*5*4=3.46ms
	T period =100ms
	PDCF=-29.22

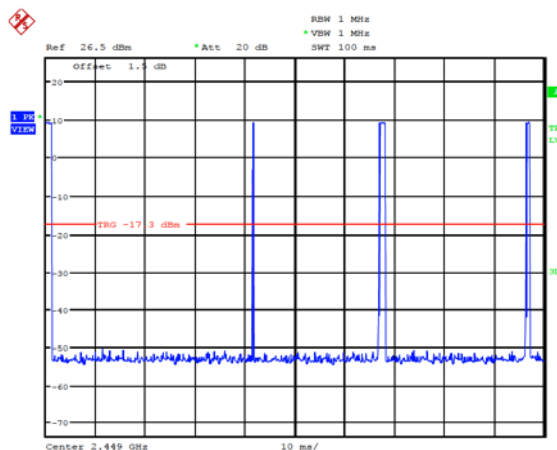
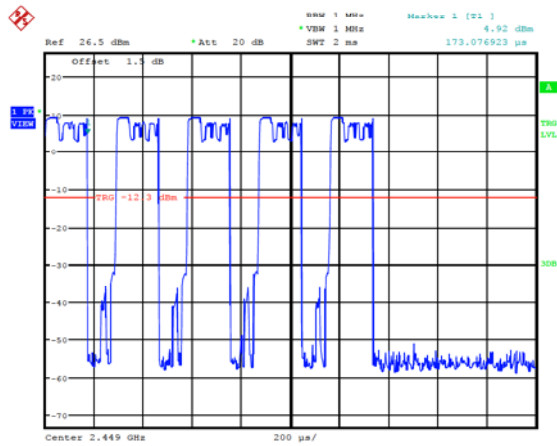

6. Band Edge Compliance

6.1. Block diagram of test setup

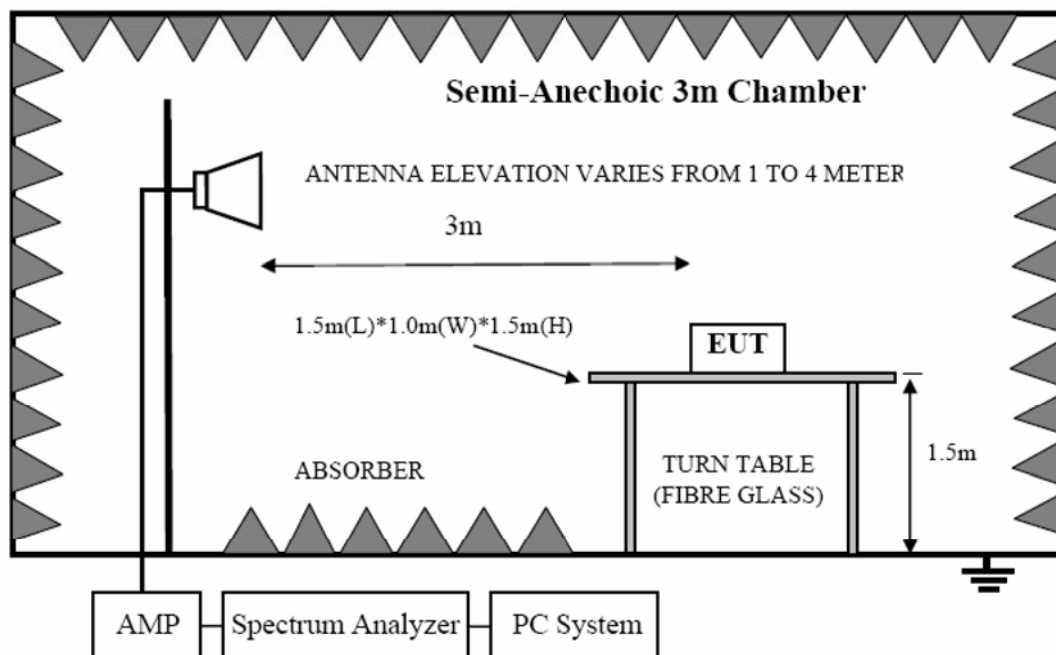

6.2. Limit

All the lower and upper band-edges emissions appearing within 2310MHz to 2390MHz and 2483.5MHz to 2500MHz restricted frequency bands shall not exceed the limits shown in 15.209, all the other emissions outside operation frequency band 2400MHz to 2483.5MHz and 5725MHz to 5850MHz shall be at least 20dB below the fundamental emissions, or comply with 15.209 limits.

6.3. Test Procedure

Same with clause 8.3 except change investigated frequency range from 2310MHz to 2415MHz and 2475MHz to 2500MHz.

Remark: All restriction band have been tested, and only the worse case is shown in report.

6.4. Test result

PASS. (See below detailed test result)

TR-4-E-009 Radiated Emission Test Result

Test Site	: DDT 3m Chamber 1#	Y:\2017 RE1# Report Data\Q17080703-01E\RF-FCC30M-13GEM6
Test Date	: 2017-09-20	Tested By : Sunny
EUT	: Air10s	Model Number : Air10s
Power Supply	: DC 3.0V	Test Mode : 2409MHz Bandedge
Condition	: Temp:24.5°C,Humi:55%, Press:100.1kPa	Antenna/Distance : 2016 HF907/3m/HORIZONTAL
Memo	:	

Data: 107

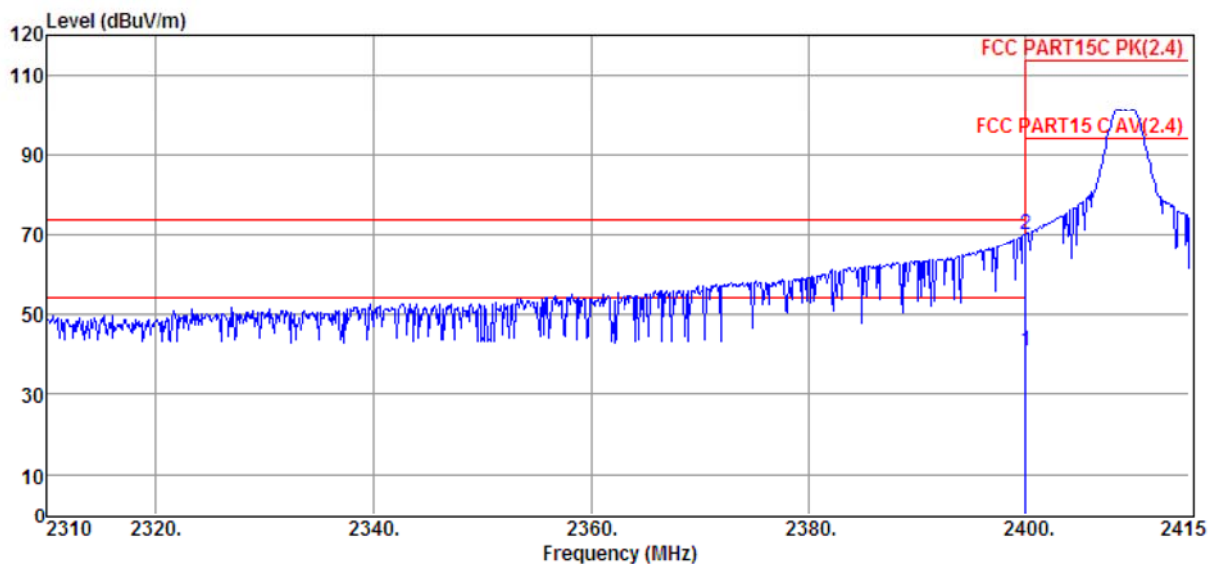

Item (Mark)	Freq. (MHz)	Read Level (dBμV)	Antenna Factor (dB/m)	PRM Factor dB	Cable Loss dB	Result Level (dBμV/m)	Limit Line (dBμV/m)	Over Limit (dB)	Detector	Polarization
1	2400.00					40.95	54.00	-13.05	Average	HORIZONTAL
2	2400.00	63.76	29.82	29.44	6.03	70.17	74.00	-3.83	Peak	HORIZONTAL

- Note: 1. Result Level = Read Level + Antenna Factor + Cable loss - PRM Factor.
 2. If Peak Result complies with AV limit, AV Result is deemed to comply with AV limit.
 3. Test setup: RBW: 1 MHz, VBW: 3 MHz, Sweep time: auto.
 4. AV of 2400.00MHz=PK+PDCF=70.17-29.22=40.95dBuV/m<54dBuV/m

TR-4-E-009 Radiated Emission Test Result

Test Site	: DDT 3m Chamber 1#	Y:\2017 RE1# Report Data\Q17080703-01E\RF-FCC30M-13G.EM6
Test Date	: 2017-09-20	Tested By : Sunny
EUT	: Air10s	Model Number : Air10s
Power Supply	: DC 3.0V	Test Mode : 2409MHz Bandedge
Condition	: Temp:24.5°C,Humi:55%, Press:100.1kPa	Antenna/Distance : 2016 HF907/3m/VERTICAL
Memo	:	

Data: 108

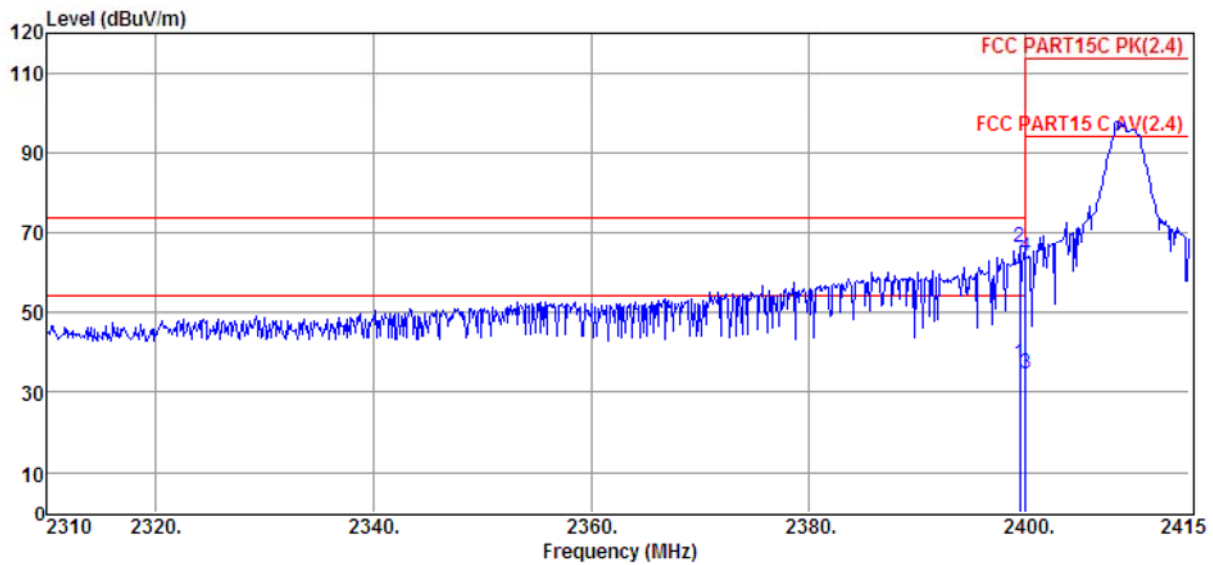

Item (Mark)	Freq. (MHz)	Read Level (dBμV)	Antenna Factor (dB/m)	PRM Factor dB	Cable Loss dB	Result Level (dBμV/m)	Limit Line (dBμV/m)	Over Limit (dB)	Detector	Polarization
1	2399.46					36.97	54.00	-17.03	Average	VERTICAL
2	2399.46	59.79	29.81	29.44	6.03	66.19	74.00	-7.81	Peak	VERTICAL
3	2400.00					34.80	54.00	-19.20	Average	VERTICAL
4	2400.00	57.61	29.82	29.44	6.03	64.02	74.00	-9.98	Peak	VERTICAL

Note: 1. Result Level = Read Level + Antenna Factor + Cable loss - PRM Factor.
 2. If Peak Result complies with AV limit, AV Result is deemed to comply with AV limit.
 3. Test setup: RBW: 1 MHz, VBW: 3 MHz, Sweep time: auto.
 4. AV of 2399.46MHz=PK+PDCF=66.19-29.22=36.97dBuV/m<54dBuV/m
 AV of 2400.00MHz=PK+PDCF=64.02-29.22=34.80dBuV/m<54dBuV/m

TR-4-E-009 Radiated Emission Test Result

Test Site	: DDT 3m Chamber 1#	Y:\2017 RE1# Report Data\Q17080703-01E\RF-FCC30M-13GEM6
Test Date	: 2017-09-20	Tested By : Sunny
EUT	: Air10s	Model Number : Air10s
Power Supply	: DC 3.0V	Test Mode : 2476MHz Bandedge
Condition	: Temp:24.5°C,Humi:55%, Press:100.1kPa	Antenna/Distance : 2016 HF907/3m/HORIZONTAL
Memo	:	

Data: 109

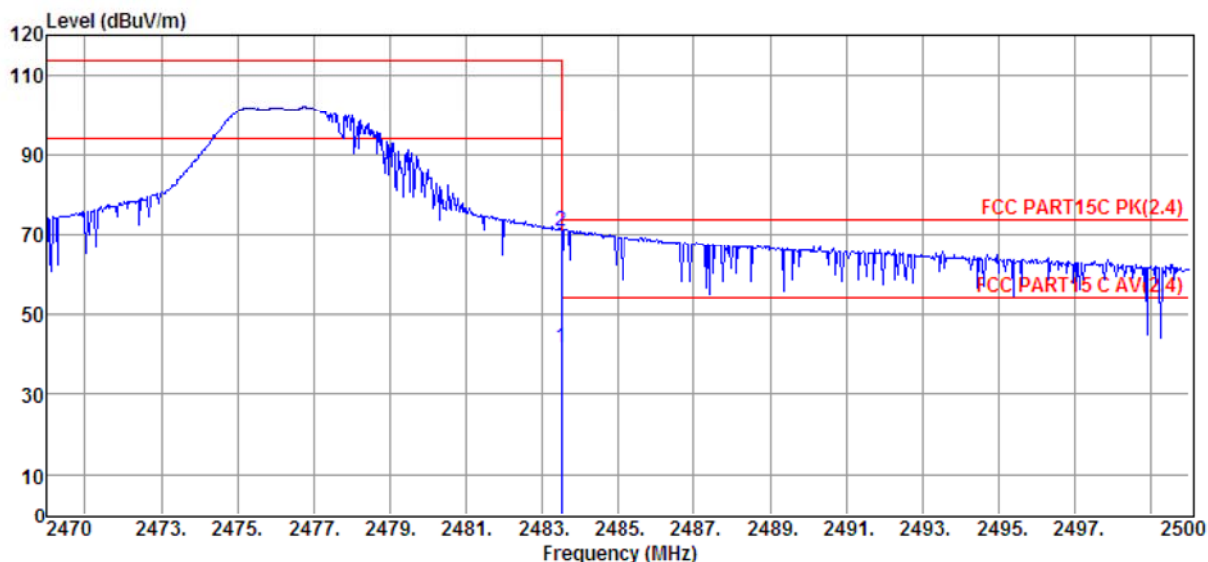

Item (Mark)	Freq. (MHz)	Read Level (dBμV)	Antenna Factor (dB/m)	PRM Factor dB	Cable Loss dB	Result Level (dBμV/m)	Limit Line (dBμV/m)	Over Limit (dB)	Detector	Polarization
1	2483.50					41.83	54.00	-12.17	Average	HORIZONTAL
2	2483.50	64.49	30.14	29.71	6.13	71.05	74.00	-2.95	Peak	HORIZONTAL

- Note: 1. Result Level = Read Level + Antenna Factor + Cable loss - PRM Factor.
 2. If Peak Result complies with AV limit, AV Result is deemed to comply with AV limit.
 3. Test setup: RBW: 1 MHz, VBW: 3 MHz, Sweep time: auto.
 4. AV of 2483.50MHz=PK+PDCF=71.05-29.22=41.83dBuV/m<54dBuV/m

TR-4-E-009 Radiated Emission Test Result

Test Site : DDT 3m Chamber 1# **Y:\2017 RE1# Report Data\Q17080703-01E\RF-FCC30M-13GEM6**
Test Date : 2017-09-20 **Tested By** : Sunny
EUT : Air10s **Model Number** : Air10s
Power Supply : DC 3.0V **Test Mode** : 2476MHz Bandedge
Condition : Temp:24.5°C,Humi:55%,
 Press:100.1kPa **Antenna/Distance** : 2016 HF907/3m/VERTICAL
Memo :

Data: 110

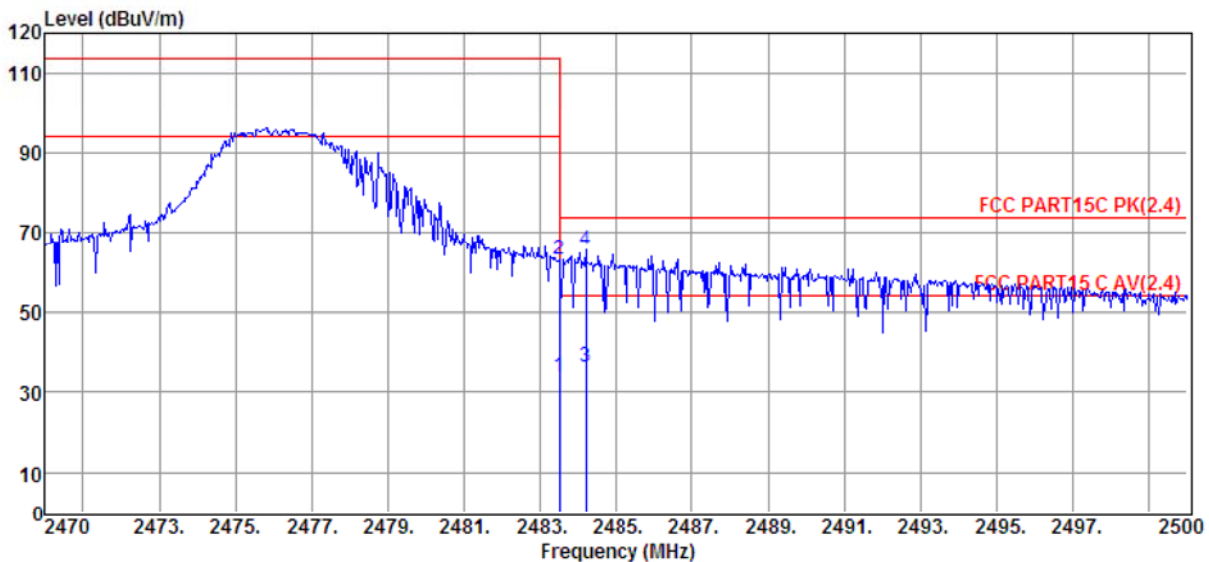

Item (Mark)	Freq. (MHz)	Read Level (dBμV)	Antenna Factor (dB/m)	PRM Factor (dB)	Cable Loss (dB)	Result Level (dBμV/m)	Limit Line (dBμV/m)	Over Limit (dB)	Detector	Polarization
1	2483.50					33.69	54.00	-20.31	Average	VERTICAL
2	2483.50	56.35	30.14	29.71	6.13	62.91	74.00	-11.09	Peak	VERTICAL
3	2484.19					36.24	54.00	-17.76	Average	VERTICAL
4	2484.19	58.90	30.14	29.71	6.13	65.46	74.00	-8.54	Peak	VERTICAL

Note: 1. Result Level = Read Level + Antenna Factor + Cable loss - PRM Factor.
 2. If Peak Result complies with AV limit, AV Result is deemed to comply with AV limit.
 3. Test setup: RBW: 1 MHz, VBW: 3 MHz, Sweep time: auto.
 4. AV of 2483.50MHz=PK+PDCF=62.91-29.22=33.69dBuV/m<54dBuV/m
 AV of 2483.50MHz=PK+PDCF=65.46-29.22=36.24dBuV/m<54dBuV/m

Average value:	
Calculate Formula:	Average value=Peak value + PDCF
	PDCF=20 log(Duty cycle)
	Duty cycle= T on time / T period
Test data:	Ton time =0.173*5*4=3.46ms
	T period =100ms
	PDCF=-29.22

Note: Average value=Peak value + PDCF, since the PDCF<-20dB, so the Average value is complied with the AV limit.

7. Power Line Conducted Emission

7.1. Block diagram of test setup

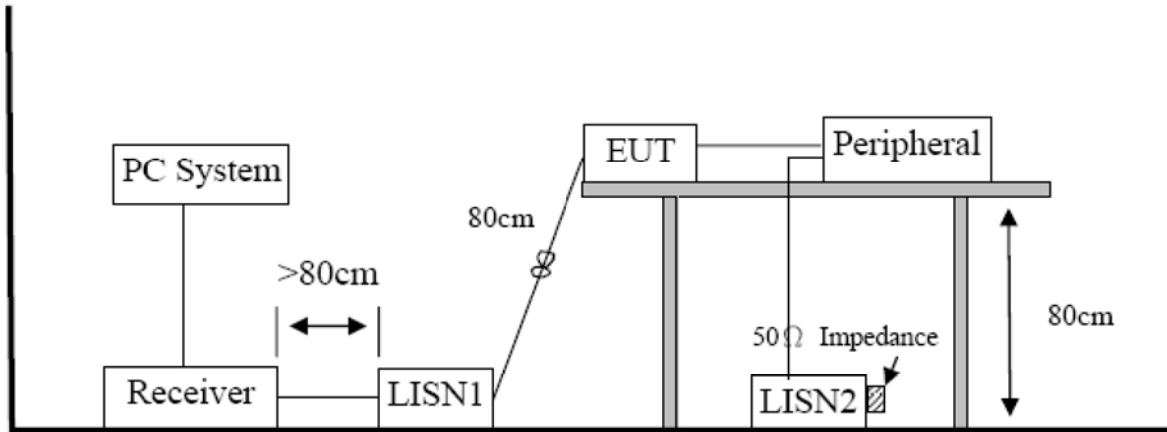

7.2. Power Line Conducted Emission Limits

Frequency	Quasi-Peak Level dB(μ V)	Average Level dB(μ V)
150kHz ~ 500kHz	66 ~ 56*	56 ~ 46*
500kHz ~ 5MHz	56	46
5MHz ~ 30MHz	60	50

Note 1: * Decreasing linearly with logarithm of frequency.

Note 2: The lower limit shall apply at the transition frequencies.

7.3. Test Procedure

The EUT and Support equipment, if needed, were put placed on a non-metallic table, 80cm above the ground plane.

Configuration EUT to simulate typical usage as described in clause 2.4 and test equipment as described in clause 10.2 of this report.

All I/O cables were positioned to simulate typical actual usage as per ANSI C63.10.

All support equipment power received from a second LISN.

Emissions were measured on each current carrying line of the EUT using an EMI Test Receiver connected to the LISN powering the EUT.

The Receiver scanned from 150 kHz to 30MHz for emissions in each of the test modes.

During the above scans, the emissions were maximized by cable manipulation.

The test mode(s) described in clause 2.4 were scanned during the preliminary test.

After the preliminary scan, we found the test mode producing the highest emission level. The EUT configuration and worse cable configuration of the above highest emission levels were recorded

for reference of the final test.

EUT and support equipment were set up on the test bench as per the configuration with highest emission level in the preliminary test.

A scan was taken on both power lines, Neutral and Line, recording at least the six highest emissions.

Emission frequency and amplitude were recorded into a computer in which correction factors were used to calculate the emission level and compare reading to the applicable limit.

The test data of the worst-case condition(s) was recorded.

The bandwidth of test receiver is set at 9 KHz.

7.4. Test Result

Not Applicable, since the EUT is only battery-operated device

8. Antenna Requirements

8.1. Limit

For intentional device, according to FCC 47 CFR Section 15.203, an intentional radiator shall be designed to ensure that no antenna other than that furnished by the responsible party shall be used with the device.

8.2. Result

The antennas used for this product are integral PCB Antenna and that no antenna other than that furnished by the responsible party shall be used with the device, the maximum peak gain of the transmit antenna is only 0dBi.

END OF REPORT