

FCC CERTIFICATION TEST REPORT

FOR

Applicant : Nissin Industries Ltd.

Address : Flat B,13/F.,North point Ind.Bldg.,499 King's Rd., North Point,
HK

Equipment under Test : Radio transmitter for photo flash

Model No. : Air1 for Canon;Air1 for Nikon;Air1 for Sony

Trade Mark : Nissin

FCC ID : 2AD52AIR1

Manufacturer : Nissin Industries Ltd.

Address : Flat B,13/F.,North point Ind.Bldg.,499 King's Rd., North
Point, HK

Issued By: Dongguan Dongdian Testing Service Co., Ltd.

Add: No. 17, Zongbu Road 2, Songshan Lake Sci&Tech, Industry Park, Dongguan City,
Guangdong Province, China, 523808

Tel: +86-0769-22891499 <http://www.dgddt.com>

REPORT

TABLE OF CONTENTS

- Test report declares.....3
- 1. Summary of test results 4
- 2. General test information..... 5
 - 2.1. Description of EUT 5
 - 2.2. Assistant equipment used for test..... 5
 - 2.3. Block diagram of EUT configuration for test 5
 - 2.4. Test environment conditions 6
 - 2.5. Test laboratory..... 6
 - 2.6. Measurement uncertainty 6
- 3. 20dB Bandwidth..... 7
 - 3.1. Test equipment 7
 - 3.2. Block diagram of test setup 7
 - 3.3. Limits 7
 - 3.4. Test Procedure..... 7
 - 3.5. Test Result..... 8
 - 3.6. Original test data 8
- 4. Radiated emission 10
 - 4.1. Test equipment 10
 - 4.2. Block diagram of test setup 10
 - 4.3. Limit 11
 - 4.4. Test Procedure..... 12
 - 4.5. Test result 12
- 5. Band Edge Compliance..... 27
 - 5.1. Test equipment 27
 - 5.2. Block diagram of test setup 27
 - 5.3. Limit 27
 - 5.4. Test Procedure..... 28
 - 5.5. Test result 28
- 6. Antenna Requirements 33
 - 6.1. Limit 33
 - 6.2. Result..... 33

TEST REPORT DECLARE

Applicant : Nissin Industries Ltd.
Address : Flat B,13/F.,North point Ind.Bldg.,499 King's Rd., North Point, HK
Equipment under Test : Radio transmitter for photo flash
Model No. : Air1 for Canon;Air1 for Nikon;Air1 for Sony
Trade Mark : Nissin
FCC ID : 2AD52AIR1
Manufacturer : Nissin Industries Ltd.
Address : Flat B,13/F.,North point Ind.Bldg.,499 King's Rd., North Point, HK

Test Standard Used: FCC Rules and Regulations Part 15 Subpart C: 2014

Test procedure used: ANSI C63.10:2009; ANSI C63.4:2009

We Declare:

The equipment described above is tested by Dongguan Dongdian Testing Service Co., Ltd and in the configuration tested the equipment complied with the standards specified above. The test results are contained in this test report and Dongguan Dongdian Testing Service Co., Ltd is assumed of full responsibility for the accuracy and completeness of these tests.

After test and evaluation, our opinion is that the equipment provided for test compliance with the requirement of the above FCC standards.

Report No.:	DDT-R15Q0123-1R2		
Date of Test:	Jan. 28, 2015	Date of Report:	Feb. 06, 2015

Prepared By:

 Leo Liu/Engineer

Approved By

 Jamy Yu/EMC Manager

Note: This report applies to above tested sample only. This report shall not be reproduced in parts without written approval of Dongguan Dongdian Testing Service Co., Ltd.

1. Summary of test results

EMISSION		
Description of Test Item	Standard	Results
Power Line Conducted Emission Test	FCC Part 15C: 15.207 ANSI C63.10:2009 ANSI C63.4:2009	N/A
Radiated Emission Test	FCC Part 15C: 15.209 FCC Part 15C: 15.249 ANSI C63.10:2009 ANSI C63.4:2009	PASS
Band Edge Compliance Test	FCC Part 15: 15.249 ANSI C63.10:2009	PASS
20dB Bandwidth Test	FCC Part 15: 15.215 ANSI C63.10:2009	PASS
N/A is an abbreviation for Not Applicable.		

2. General test information

2.1. Description of EUT

EUT* Name	:	Radio transmitter for photo flash
Model Number	:	Air1 for Canon;Air1 for Nikon;Air1 for Sony
Difference of model Number	:	Only have difference of connector for diffence digital camerat, all the other characteristic like circuit, PCB layout are exactly same
Trade mark	:	Nissin
EUT function description	:	Please reference user manual of this device
Power supply	:	DC 3V from battery
FCC ID	:	2AD52AIR1
FCC Operation frequency	:	2402MHz -2476MHz
Modulation	:	GFSK
Data rate	:	N/A
Antenna Type	:	Interated PCB antenna, maximum PK gain:0dBi
Date of Receipt	:	Jan.23,2015
Sample Type	:	Series production

Note: EUT is the ab. of equipment under test.

2.2. Assistant equipment used for test

Description of Assistant equipment	Manufacturer	Model number or Type	Other
/	/	/	/

2.3. Block diagram of EUT configuration for test

TX Mode:



For Tx Mode, A special test fireware was installed in EUT and which can exercise the EUT work in continues RF test mode at specified test channel as below:

Tested mode, channel, and data rate information		
Mode	Channel	Frequency(MHz)
GFSK modulated Tx Mode Keeping transmitter mode	CH Low	2402
	CH Middle	2449
	CH High	2476

2.4. Test environment conditions

During the measurement the environmental conditions were within the listed ranges:

Temperature range:	21-25°C
Humidity range:	40-75%
Pressure range:	86-106kPa
Power supply	DC 3V and DC 2.7V, DC 3.3V(+/-10% of normal Power supply)

2.5. Test laboratory

Dongguan Dongdian Testing Service Co., Ltd

Add: No. 17, Zongbu Road 2, Songshan Lake Sci&Tech, Industry Park, Dongguan City, Guangdong Province, China, 523808 Tel: +86-0769-22891499

FCC Registration Number: 270092

2.6. Measurement uncertainty

Test Item	Uncertainty
Uncertainty for Conduction emission test	2.40dB
Uncertainty for Radiation Emission test (150KHz-30MHz)	3.21dB
Uncertainty for Radiation Emission test (30MHz-1GHz)	2.78 dB (Polarize: V)
	3.20 dB (Polarize: H)
Uncertainty for Radiation Emission test (1GHz to 25GHz)	2.08dB(Polarize: V)
	2.56dB (Polarize: H)
Uncertainty for radio frequency	1×10^{-9}
Uncertainty for conducted RF Power	0.65dB

Note: This uncertainty represents an expanded uncertainty expressed at approximately the 95% confidence level using a coverage factor of k=2.

3. 20dB Bandwidth

3.1. Test equipment

Item	Equipment	Manufacturer	Model No.	Serial No.	Last Cal.	Cal. Interval
1	Spectrum analyzer	R&S	FSU	1166.1660.26	2014/11/13	1Y

3.2. Block diagram of test setup



3.3. Limits

Intentional radiators operating under the alternative provisions to the general emission limits, as contained in § 15.217 through 15.257 and in Subpart E of this part, must be designed to ensure that the 20 dB bandwidth of the emission, or whatever bandwidth may otherwise be specified in the specific rule section under which the equipment operates, is contained within the frequency band designated in the rule section under which the equipment is operated.

3.4. Test Procedure

- (1) The EUT's RF signal was coupled to spectrum analyzer by a antenna connected to spectrum analyzer.
- (2) Configure EUT work in Tx mode as stated in clause 2.3.
- (3) The bandwidth of the fundamental frequency was measured by spectrum analyzer with 100 kHz RBW and 300kHz VBW. The 20dB bandwidth is defined as the total spectrum the power of which is higher than peak power minus 20dB.

3.5. Test Result

EUT: Radio transmitter for photo flash					
Mode	Freq (MHz)	Result (MHz)	Limit (MHz)	Margin (MHz)	Conclusion
Tx Mode	2402	3.125	/	/	PASS
	2449	2.308	/	/	PASS
	2476	3.269	/	/	PASS
Test Date : Jan. 28, 2015			Test Engineer : Damon Hu		

3.6. Original test data

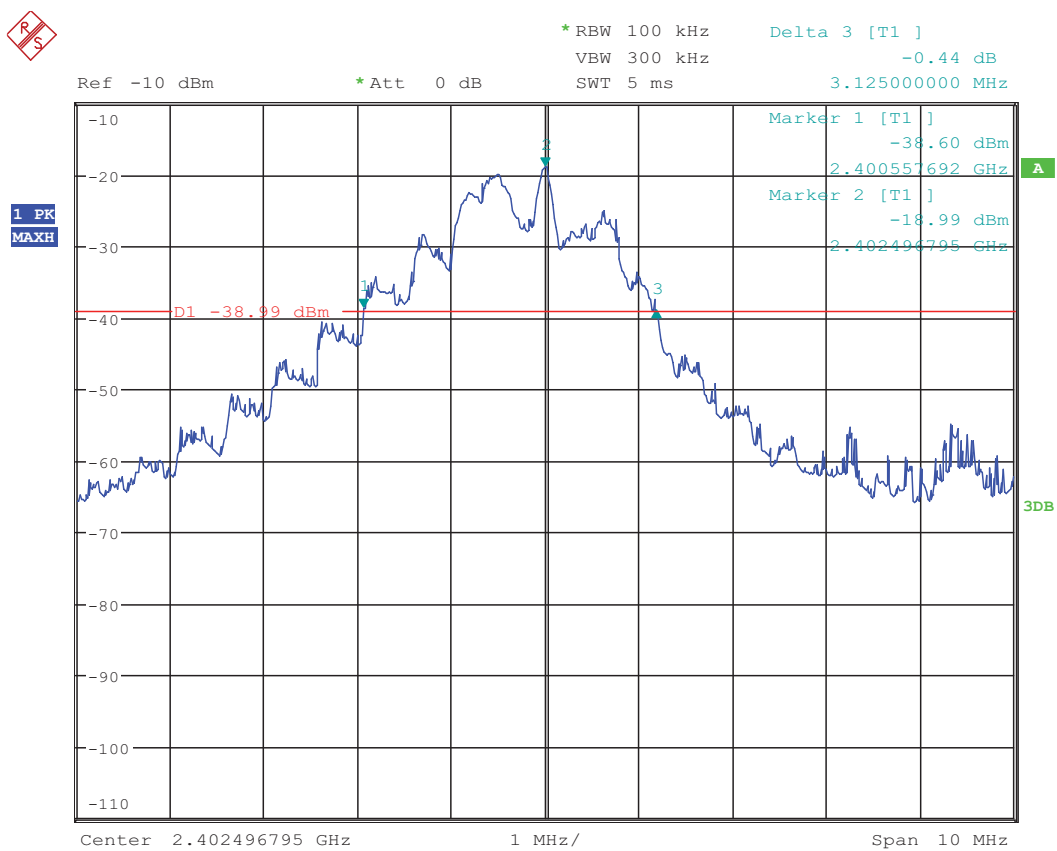

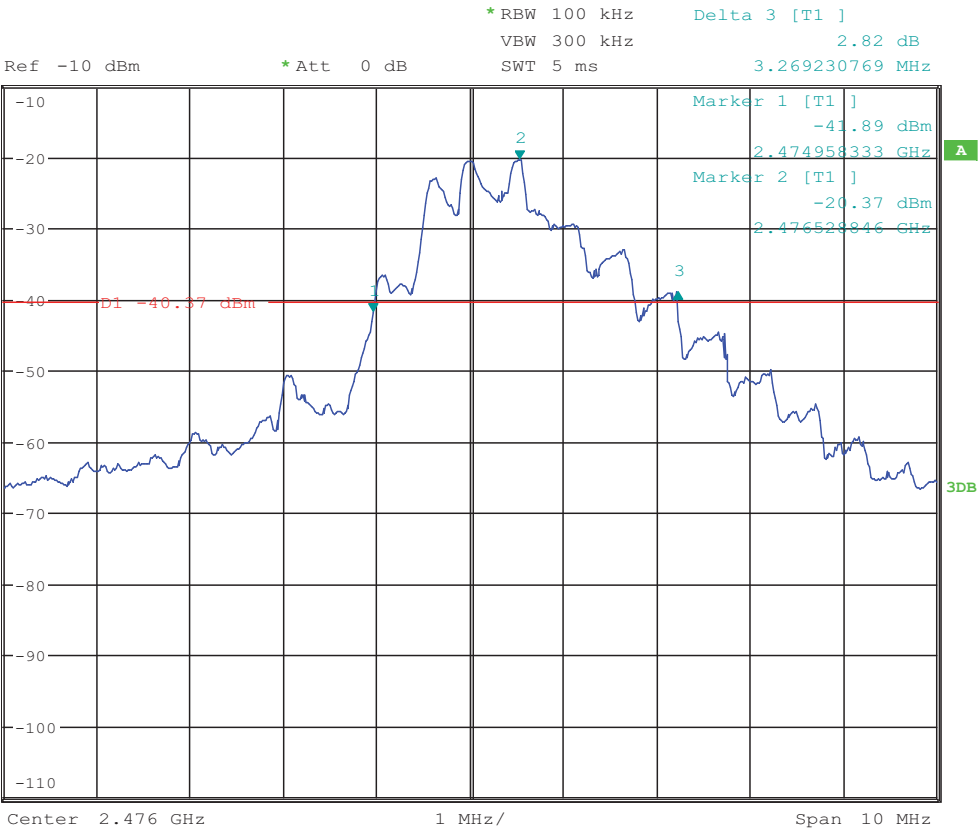
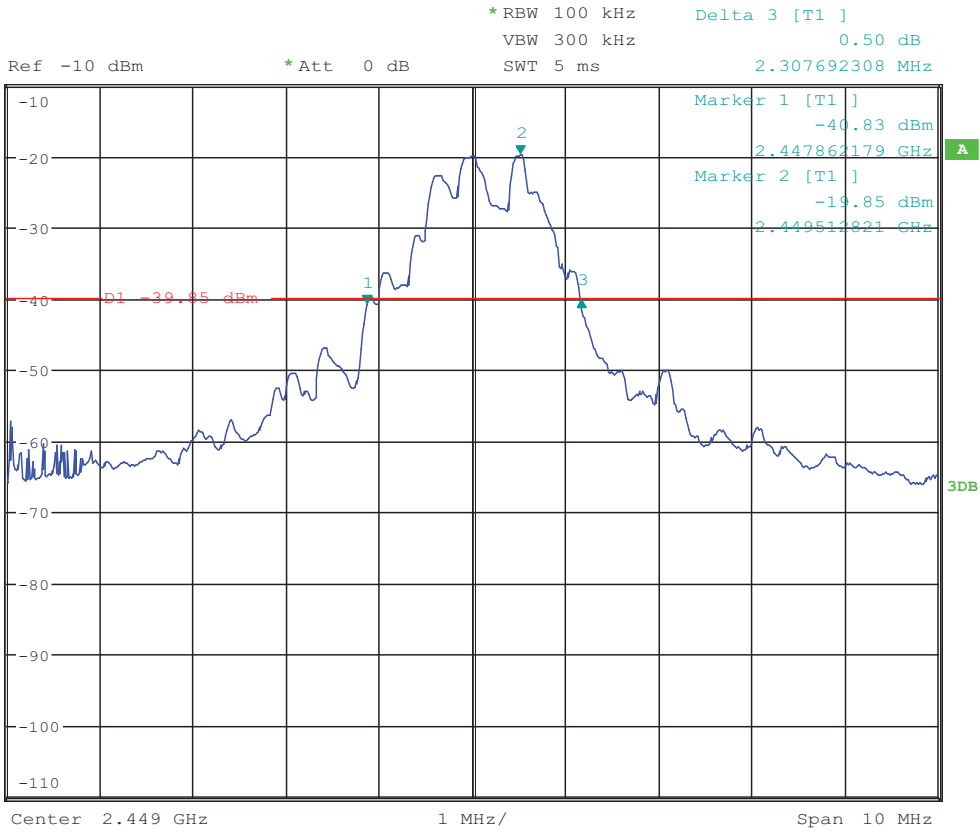

4. Radiated emission

4.1. Test equipment

Item	Equipment	Manufacturer	Model No.	Serial No.	Last Cal.	Cal. Interval
1	EMI Test Receiver	R&S	ESU8	100316	2014/11/13	1Y
2	Spectrum analyzer	R&S	FSU	1166.1660.26	2014/11/13	1Y
3	Loop antenna	TESEQ	HLA6120	20129	2014/11/13	1Y
4	Trilog Broadband Antenna	Schwarzbeck	VULB9163	9163-462	2014/11/13	1Y
5	Double Ridged Horn Antenna	R&S	HF907	100276	2014/11/13	1Y
6	Horn Antenna	EMCO	3116	00060095	2014/11/13	1Y
7	Pre-Amplifier	R&S	SCU-01	10049	2014/11/13	1Y
8	Pre-amplifier	A.H.	PAM0-0118	360	2014/11/13	1Y
9	Pre-amplifier	A.H.	PAM-1840VH	562	2014/11/13	1Y
10	RF Cable	R&S	R01	10403	2014/11/13	1Y
11	RF Cable	R&S	R02	10512	2014/11/13	1Y

4.2. Block diagram of test setup

In 3m Anechoic Chamber Test Setup Diagram for below 1GHz

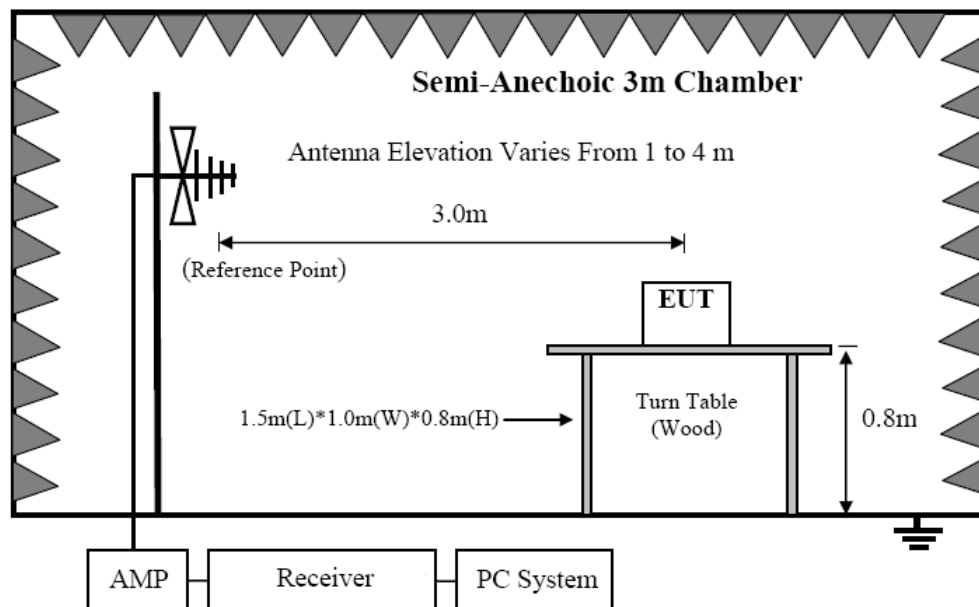

In 3m Anechoic Chamber Test Setup Diagram for frequency above 1GHz

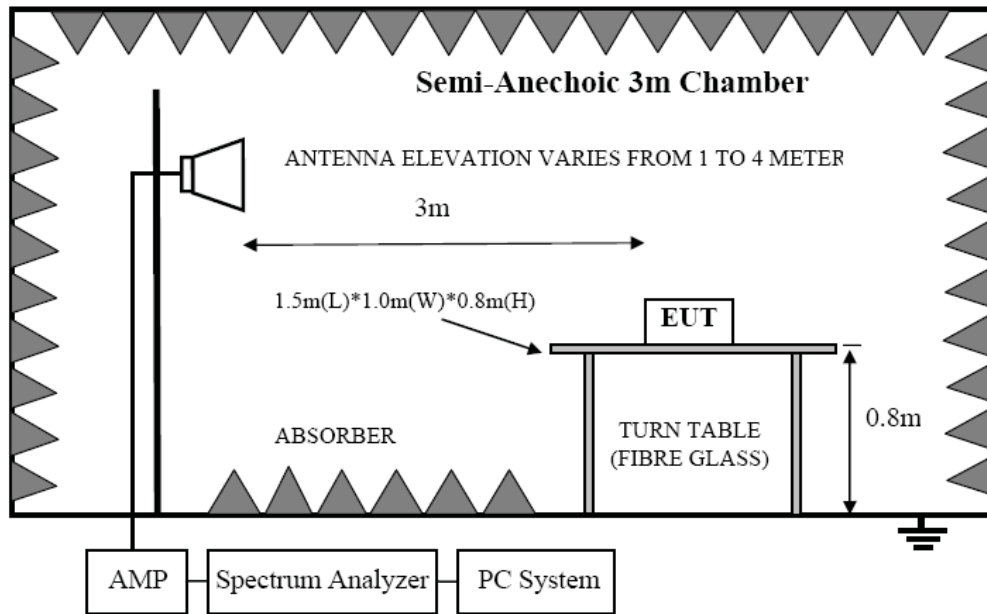

Note: For harmonic emissions test a appropriate high pass filter was inserted in the input port of AMP.

4.3. Limit

FREQUENCY MHz	DISTANCE Meters	FIELD STRENGTHS LIMIT	
		μV/m	dB(μV)/m
30 ~ 88	3	100	40.0
88 ~ 216	3	150	43.5
216 ~ 960	3	200	46.0
960 ~ 1000	3	500	54.0
Above 1000MHz	3	74.0 dB(μV)/m (Peak) 54.0 dB(μV)/m (Average)	
Field Strength of Fundamental emission for 2.4GHz-2.4835GHz	3	94.0 dB(μV)/m (Average) 114.0 dB(μV)/m(Peak)	
Field Strength of Harmonics	3	74.0 dB(μV)/m (Peak) 54.0 dB(μV)/m (Average)	

Remark : (1) Emission level dBμV = 20 log Emission level μV/m

- (2) The smaller limit shall apply at the cross point between two frequency bands.
- (3) Distance is the distance in meters between the measuring instrument, antenna and the closest point of any part of the device or system.
- (4) The emission limits shown in the above table are based on measurements employing a CISPR quasi-peak detector except for the frequency bands 9-90 kHz, 110-490 kHz and above 1000 MHz. Radiated emission limits in these three bands are based on measurements employing an average detector.

4.4. Test Procedure

- (1) EUT was placed on a non-metallic table, 80 cm above the ground plane inside a semi-anechoic chamber.
- (2) Setup EUT and assistant system according clause 2.3 and 4.2
- (3) Test antenna was located 3m from the EUT on an adjustable mast. Below pre-scan procedure was first performed in order to find prominent radiated emissions.
 - (a) Change work frequency or channel of device if practicable.
 - (b) Change modulation type of device if practicable.
 - (c) Change power supply range from 85% to 115% of the rated supply voltage
 - (d) Rotated EUT though three orthogonal axes to determine the attitude of EUT arrangement produces highest emissions
- (4) Spectrum frequency from 9KHz to 25GHz (tenth harmonic of fundamental frequency) was investigated, and no any obvious emission were detected from 9KHz to 30MHz and 18GHz to 25GHz, so below final test was performed with frequency range from 30MHz to 18GHz.
- (5) For final emissions measurements at each frequency of interest, the EUT were rotated and the antenna height was varied between 1m and 4m in order to maximize the emission. Measurements in both horizontal and vertical polarities were made and the data was recorded. In order to find the maximum emission, the relative positions of equipments and all of the interface cables were changed according to ANSI C63.10:2009 on Radiated Emission test.
- (6) For emissions from 30MHz to 1GHz, Quasi-Peak values were measured with EMI Receiver and the bandwidth of Receiver is 120 KHz.
- (7) For emissions above 1GHz, both Peak and Average level were measured with Spectrum Analyzer, and the RBW is set at 1MHz, VBW is set at 3MHz for Peak measure; RBW is set at 1MHz, VBW is set at 10Hz for Average measure. Peak detector is used for both PK and AV test.
- (8) For emissions below 1GHz, according explorer test, when change Tx mode and channel, have no distinct influence on emissions level, so for emissions below 1GHz, the final test was only performed with EUT working in Tx 2402MHz mode.
- (9) According to section 3.5 test result of this report, the EUT's BW (max) =3.67MHz, so set spectrum analyzer's RBW=4MHz, VBW=10MHz. peak detector for PK, RMS detector for AV, Read the Level in spectrum analyzer and record.

4.5. Test result

PASS. (See below detailed test result)

All the emissions except fundamental emission from 9 KHz to 25GHz were comply with 15.209 limit.

TR-4-E-009 Radiated Emission Test Result

Test Site : DDT 3m Chamber **E:\2015 Report Data\15Q0123-1\FCC ID.EM6**
Test Date : 2015-01-28 **Tested By** : Damon
EUT : Radio transmitter for photo flash **Model Number** : Air1 for Canon
Power Supply : DC 3V **Test Mode** : TX mode
Condition : Temp:24.5°C,Humi:55%,
Press:100.1kPa **Antenna/Distance** : 2014 VULB 9163/3m/VERTICAL
Memo :

Data: 1

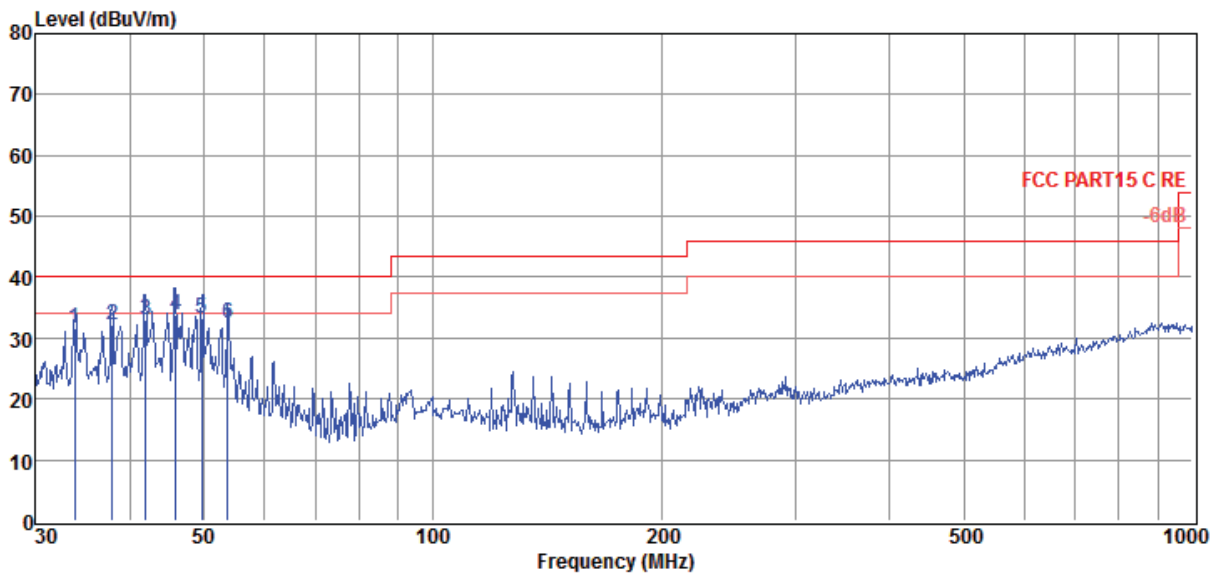

Item (Mark)	Freq (MHz)	Read Level (dBμV)	Antenna Factor (dB/m)	Cable Loss (dB)	Result Level (dBμV/m)	Limit Line (dBμV/m)	Over Limit (dB)	Detector	Polarization
1	33.80	18.34	12.30	0.94	31.58	40.00	-8.42	QP	VERTICAL
2	37.81	17.97	13.15	0.97	32.09	40.00	-7.91	QP	VERTICAL
3	41.86	18.12	14.00	1.01	33.13	40.00	-6.87	QP	VERTICAL
4	45.84	18.10	14.70	1.04	33.84	40.00	-6.16	QP	VERTICAL
5	49.71	17.65	14.50	1.07	33.22	40.00	-6.78	QP	VERTICAL
6	53.69	17.05	14.20	1.09	32.34	40.00	-7.66	QP	VERTICAL

- Note: 1. Result Level = Read Level + Antenna Factor + Cable loss.
 2. If Peak Result complies with QP limit, QP Result is deemed to comply with QP limit.
 3. Test setup: RBW: 120 kHz, VBW: 300 kHz, Sweep time: auto.

TR-4-E-009 Radiated Emission Test Result

Test Site	: DDT 3m Chamber	E:\2015 Report Data\15Q0123-1\FCC ID.EM6
Test Date	: 2015-01-28	Tested By : Damon
EUT	: Radio transmitter for photo flash	Model Number : Air1 for Canon
Power Supply	: DC 3V	Test Mode : TX mode
Condition	: Temp:24.5'C,Humi:55%, Press:100.1kPa	Antenna/Distance : 2014 VULB 9163/3m/HORIZONTAL
Memo	:	

Data: 2

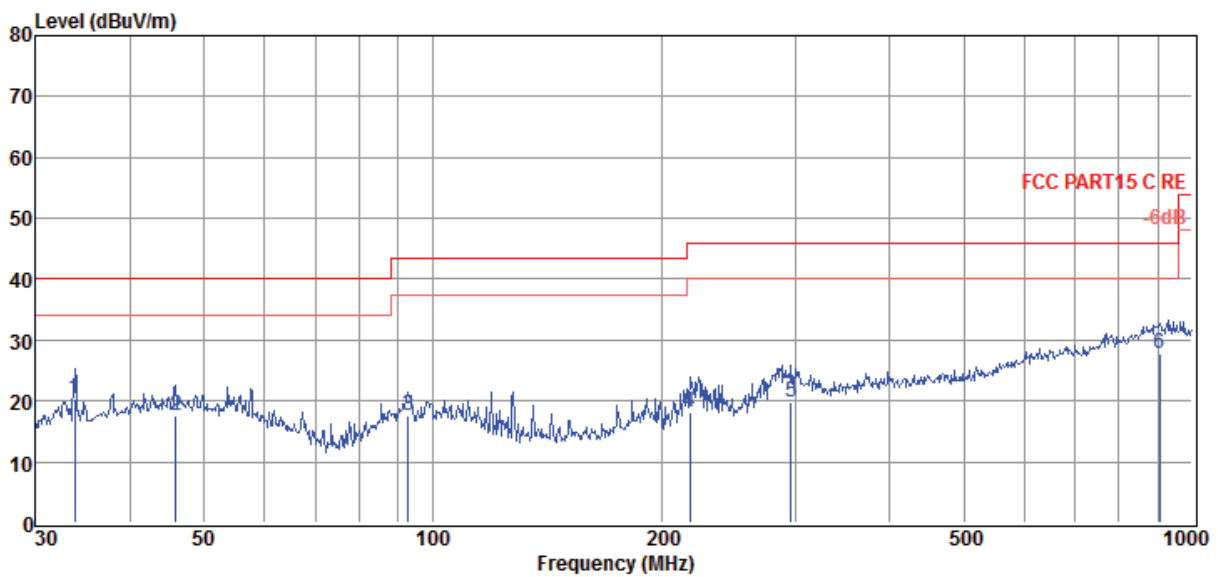

Item (Mark)	Freq (MHz)	Read Level (dBuV)	Antenna Factor (dB/m)	Cable Loss dB	Result Level (dBuV/m)	Limit Line (dBuV/m)	Over Limit (dB)	Detector	Polarization
1	33.80	7.10	12.30	0.94	20.34	40.00	-19.66	QP	HORIZONTAL
2	45.86	1.79	14.70	1.04	17.53	40.00	-22.47	QP	HORIZONTAL
3	92.79	4.27	11.80	1.45	17.52	43.50	-25.98	QP	HORIZONTAL
4	218.31	4.95	10.90	2.20	18.05	46.00	-27.95	QP	HORIZONTAL
5	296.18	3.34	13.83	2.69	19.86	46.00	-26.14	QP	HORIZONTAL
6	906.48	0.62	22.07	4.96	27.65	46.00	-18.35	QP	HORIZONTAL

- Note: 1. Result Level = Read Level + Antenna Factor + Cable loss.
 2. If Peak Result complies with QP limit, QP Result is deemed to comply with QP limit.
 3. Test setup: RBW: 120 kHz, VBW: 300 kHz, Sweep time: auto.

TR-4-E-009 Radiated Emission Test Result

Test Site	: DDT 3m Chamber	E:\2015 Report Data\15Q0123-1\FCC ID.EM6
Test Date	: 2015-01-28	Tested By : Damon
EUT	: Radio transmitter for photo flash	Model Number : Air1 for Canon
Power Supply	: DC 3V	Test Mode : TX 2476MHz
Condition	: Temp:24.5'C,Humi:55%, Press:100.1kPa	Antenna/Distance : 2014 HF907/3m/VERTICAL
Memo	:	

Data: 11

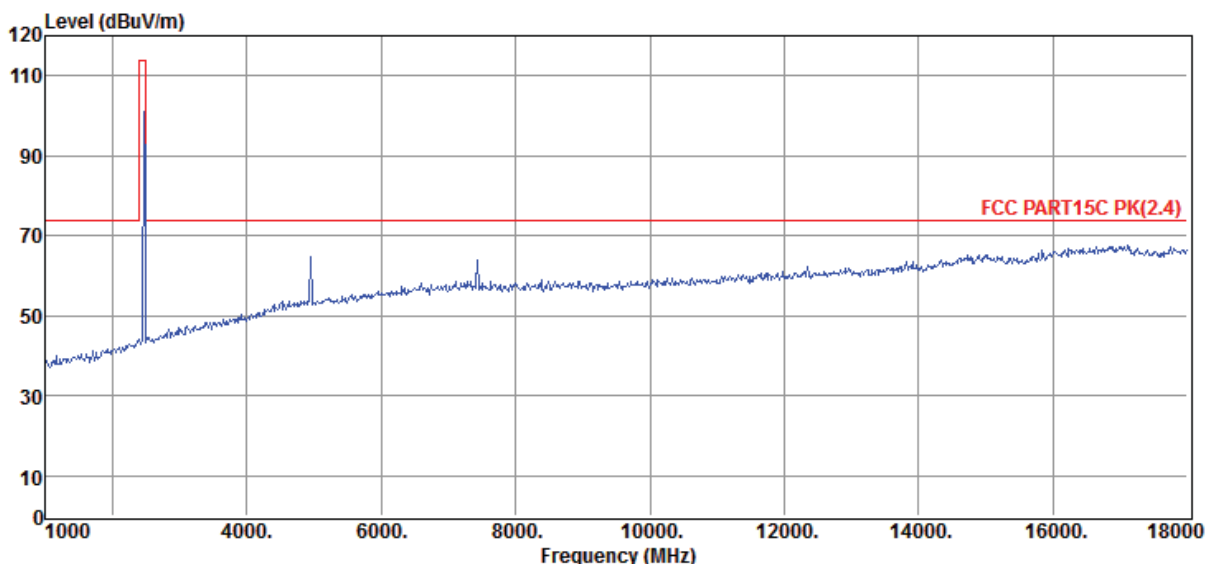

Item	Freq	Read Level	Antenna Factor	PRM Factor	Cable Loss	Result Level	Limit Line	Over Limit	Detector	Polarization
(Mark)	(MHz)	(dBμV)	(dB/m)	dB	dB	(dBμV/m)	(dBμV/m)	(dB)		

- Note: 1. Result Level = Read Level + Antenna Factor + Cable loss - PRM Factor.
 2. If Peak Result complies with AV limit, AV Result is deemed to comply with AV limit.
 3. Test setup: RBW: 1 MHz, VBW: 3 MHz, Sweep time: auto.
 4. For fundamental frequency RBW 4MHz, VBW 10MHz, Peak detector.

TR-4-E-009 Radiated Emission Test Result

Test Site : DDT 3m Chamber	E:\2015 Report Data\15Q0123-1\FCC ID.EM6
Test Date : 2015-01-28	Tested By : Damon
EUT : Radio transmitter for photo flash	Model Number : Air1 for Canon
Power Supply : DC 3V	Test Mode : TX 2476MHz
Condition : Temp:24.5'C,Humi:55%, Press:100.1kPa	Antenna/Distance : 2014 HF907/3m/VERTICAL
Memo :	

Data: 12

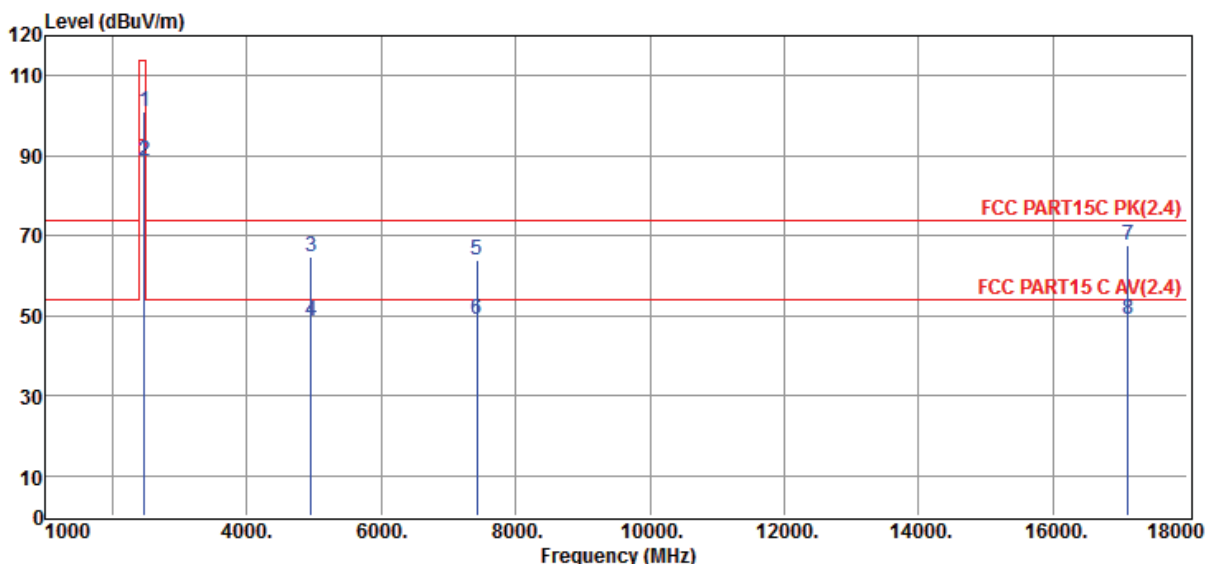

Item (Mark)	Freq (MHz)	Read Level (dBμV)	Antenna Factor (dB/m)	PRM Factor dB	Cable Loss dB	Result Level (dBμV/m)	Limit Line (dBμV/m)	Over Limit (dB)	Detector	Polarization
1	2476.00	92.66	30.25	30.25	8.45	101.11	114.00	-12.89	Peak	VERTICAL
2	2476.00	80.23	30.25	30.25	8.45	88.68	94.00	-5.32	Average	VERTICAL
3	4952.00	46.24	35.62	29.04	12.02	64.84	74.00	-9.16	Peak	VERTICAL
4	4952.00	30.26	35.62	29.04	12.02	48.86	54.00	-5.14	Average	VERTICAL
5	7428.00	41.17	37.36	30.03	15.46	63.96	74.00	-10.04	Peak	VERTICAL
6	7428.00	26.46	37.36	30.03	15.46	49.25	54.00	-4.75	Average	VERTICAL
7	17116.00	35.92	43.41	37.15	25.47	67.65	74.00	-6.35	Peak	VERTICAL
8	17116.00	17.54	43.41	37.15	25.47	49.27	54.00	-4.73	Average	VERTICAL

- Note: 1. Result Level = Read Level + Antenna Factor + Cable loss - PRM Factor.
 2. If Peak Result complies with AV limit, AV Result is deemed to comply with AV limit.
 3. Test setup: RBW: 1 MHz, VBW: 3 MHz, Sweep time: auto.
 4. For fundamental frequency RBW 4MHz, VBW 10MHz, Peak detector.

TR-4-E-009 Radiated Emission Test Result

Test Site	: DDT 3m Chamber	E:\2015 Report Data\15Q0123-1\FCC ID.EM6
Test Date	: 2015-01-28	Tested By : Damon
EUT	: Radio transmitter for photo flash	Model Number : Air1 for Canon
Power Supply	: DC 3V	Test Mode : TX 2476MHz
Condition	: Temp:24.5'C,Humi:55%, Press:100.1kPa	Antenna/Distance : 2014 HF907/3m/HORIZONTAL
Memo	:	

Data: 13

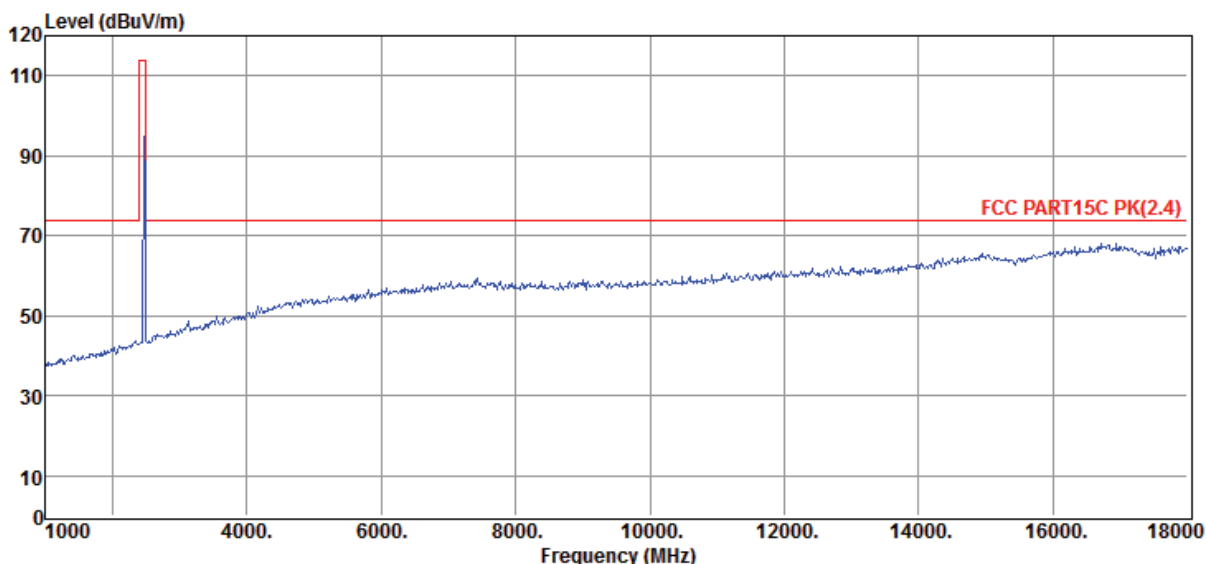

Item	Freq	Read Level	Antenna Factor	PRM Factor	Cable Loss	Result Level	Limit Line	Over Limit	Detector	Polarization
(Mark)	(MHz)	(dBμV)	(dB/m)	dB	dB	(dBμV/m)	(dBμV/m)	(dB)		

- Note: 1. Result Level = Read Level + Antenna Factor + Cable loss - PRM Factor.
 2. If Peak Result complies with AV limit, AV Result is deemed to comply with AV limit.
 3. Test setup: RBW: 1 MHz, VBW: 3 MHz, Sweep time: auto.
 4. For fundamental frequency RBW 4MHz, VBW 10MHz, Peak detector.

TR-4-E-009 Radiated Emission Test Result

Test Site : DDT 3m Chamber **E:\2015 Report Data\15Q0123-1\FCC ID.EM6**
Test Date : 2015-01-28 **Tested By** : Damon
EUT : Radio transmitter for photo flash **Model Number** : Air1 for Canon
Power Supply : DC 3V **Test Mode** : TX 2476MHz
Condition : Temp:24.5'C,Humi:55%,
 Press:100.1kPa **Antenna/Distance** : 2014 HF907/3m/HORIZONTAL
Memo :

Data: 14

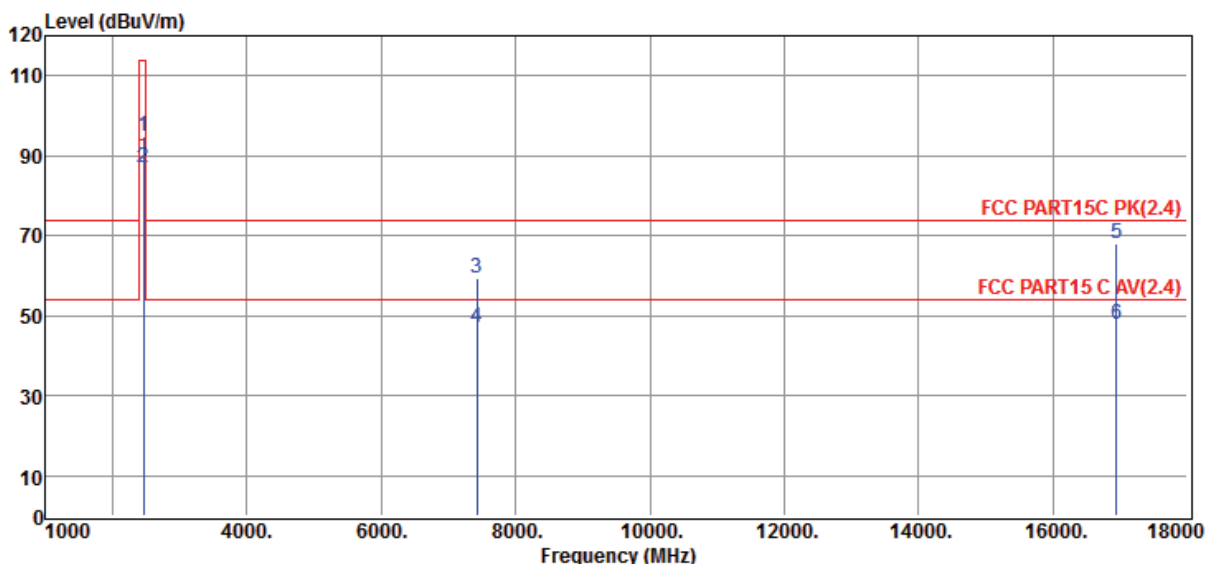

Item (Mark)	Freq (MHz)	Read Level (dBμV)	Antenna Factor (dB/m)	PRM Factor (dB)	Cable Loss (dB)	Result Level (dBμV/m)	Limit Line (dBμV/m)	Over Limit (dB)	Detector	Polarization
1	2476.00	86.41	30.20	30.25	8.45	94.81	114.00	-19.19	Peak	HORIZONTAL
2	2476.00	78.52	30.20	30.25	8.45	86.92	94.00	-7.08	Average	HORIZONTAL
3	7426.00	36.64	37.36	30.03	15.46	59.43	74.00	-14.57	Peak	HORIZONTAL
4	7426.00	24.42	37.36	30.03	15.46	47.21	54.00	-6.79	Average	HORIZONTAL
5	16946.00	35.85	43.61	36.95	25.60	68.11	74.00	-5.89	Peak	HORIZONTAL
6	16946.00	15.47	43.61	36.95	25.60	47.73	54.00	-6.27	Average	HORIZONTAL

- Note: 1. Result Level = Read Level + Antenna Factor + Cable loss - PRM Factor.
 2. If Peak Result complies with AV limit, AV Result is deemed to comply with AV limit.
 3. Test setup: RBW: 1 MHz, VBW: 3 MHz, Sweep time: auto.
 4. For fundamental frequency RBW 4MHz, VBW 10MHz, Peak detector.

TR-4-E-009 Radiated Emission Test Result

Test Site	: DDT 3m Chamber	E:\2015 Report Data\15Q0123-1\FCC ID.EM6
Test Date	: 2015-01-28	Tested By : Damon
EUT	: Radio transmitter for photo flash	Model Number : Air1 for Canon
Power Supply	: DC 3V	Test Mode : TX 2402MHz
Condition	: Temp:24.5'C,Humi:55%, Press:100.1kPa	Antenna/Distance : 2014 HF907/3m/VERTICAL
Memo	:	

Data: 15

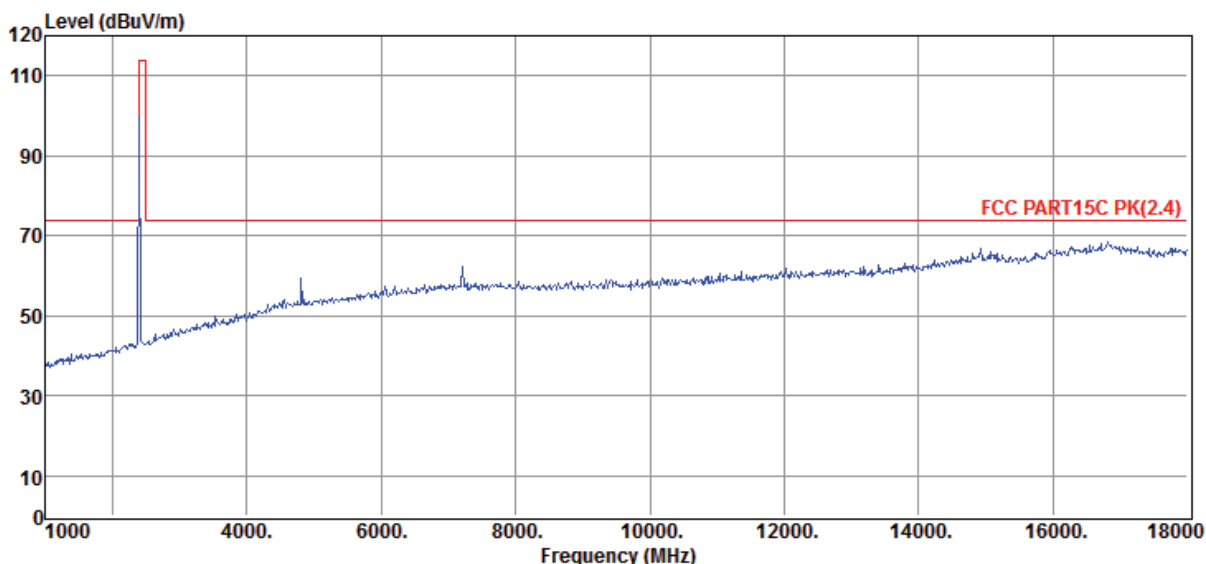

Item	Freq	Read Level	Antenna Factor	PRM Factor	Cable Loss	Result Level	Limit Line	Over Limit	Detector	Polarization
(Mark)	(MHz)	(dBμV)	(dB/m)	dB	dB	(dBμV/m)	(dBμV/m)	(dB)		
	2402	115				115	75	40		

- Note: 1. Result Level = Read Level + Antenna Factor + Cable loss - PRM Factor.
 2. If Peak Result complies with AV limit, AV Result is deemed to comply with AV limit.
 3. Test setup: RBW: 1 MHz, VBW: 3 MHz, Sweep time: auto.
 4. For fundamental frequency RBW 4MHz, VBW 10MHz, Peak detector.

TR-4-E-009 Radiated Emission Test Result

Test Site : DDT 3m Chamber **E:\2015 Report Data\15Q0123-1\FCC ID.EM6**
Test Date : 2015-01-28 **Tested By** : Damon
EUT : Radio transmitter for photo flash **Model Number** : Air1 for Canon
Power Supply : DC 3V **Test Mode** : TX 2402MHz
Condition : Temp:24.5'C,Humi:55%,
 Press:100.1kPa **Antenna/Distance** : 2014 HF907/3m/VERTICAL
Memo :

Data: 16

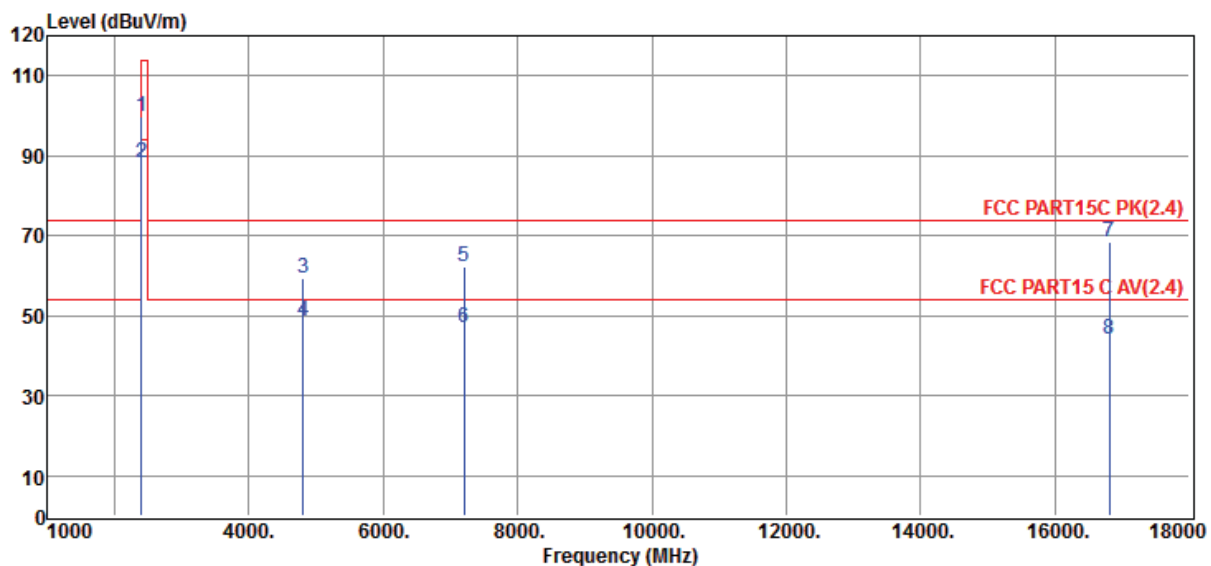

Item (Mark)	Freq (MHz)	Read Level (dB μ V)	Antenna Factor (dB/m)	PRM Factor dB	Cable Loss dB	Result Level (dB μ V/m)	Limit Line (dB μ V/m)	Over Limit (dB)	Detector	Polarization
1	2402.00	91.71	29.99	30.21	8.35	99.84	114.00	-14.16	Peak	VERTICAL
2	2402.00	80.20	29.99	30.21	8.35	88.33	94.00	-5.67	Average	VERTICAL
3	4804.00	41.21	35.40	29.13	12.07	59.55	74.00	-14.45	Peak	VERTICAL
4	4804.00	30.27	35.40	29.13	12.07	48.61	54.00	-5.39	Average	VERTICAL
5	7206.00	39.55	37.22	29.68	15.18	62.27	74.00	-11.73	Peak	VERTICAL
6	7206.00	24.19	37.22	29.68	15.18	46.91	54.00	-7.09	Average	VERTICAL
7	16810.00	36.77	43.64	36.85	25.00	68.56	74.00	-5.44	Peak	VERTICAL
8	16810.00	12.47	43.64	36.85	25.00	44.26	54.00	-9.74	Average	VERTICAL

- Note: 1. Result Level = Read Level + Antenna Factor + Cable loss - PRM Factor.
 2. If Peak Result complies with AV limit, AV Result is deemed to comply with AV limit.
 3. Test setup: RBW: 1 MHz, VBW: 3 MHz, Sweep time: auto.
 4. For fundamental frequency RBW 4MHz, VBW 10MHz, Peak detector.

TR-4-E-009 Radiated Emission Test Result

Test Site	: DDT 3m Chamber	E:\2015 Report Data\15Q0123-1\FCC ID.EM6
Test Date	: 2015-01-28	Tested By : Damon
EUT	: Radio transmitter for photo flash	Model Number : Air1 for Canon
Power Supply	: DC 3V	Test Mode : TX 2402MHz
Condition	: Temp:24.5'C,Humi:55%, Press:100.1kPa	Antenna/Distance : 2014 HF907/3m/HORIZONTAL
Memo	:	

Data: 17

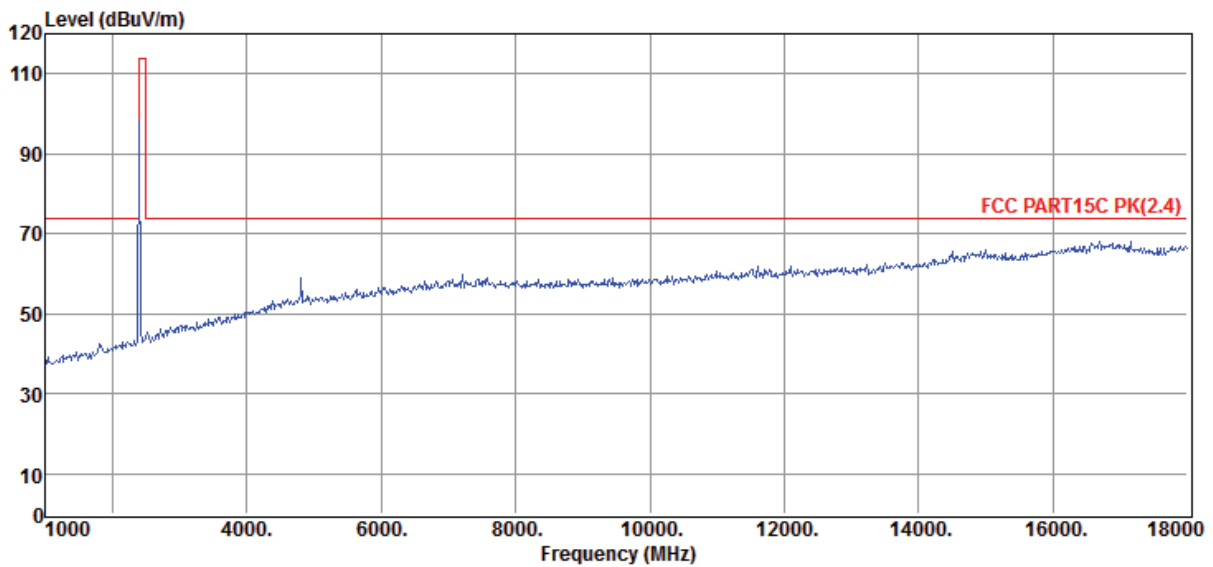

Item	Freq	Read Level	Antenna Factor	PRM Factor	Cable Loss	Result Level	Limit Line	Over Limit	Detector	Polarization
(Mark)	(MHz)	(dBμV)	(dB/m)	dB	dB	(dBμV/m)	(dBμV/m)	(dB)		

- Note: 1. Result Level = Read Level + Antenna Factor + Cable loss - PRM Factor.
 2. If Peak Result complies with AV limit, AV Result is deemed to comply with AV limit.
 3. Test setup: RBW: 1 MHz, VBW: 3 MHz, Sweep time: auto.
 4. For fundamental frequency RBW 4MHz, VBW 10MHz, Peak detector.

TR-4-E-009 Radiated Emission Test Result

Test Site : DDT 3m Chamber **E:\2015 Report Data\15Q0123-1\FCC ID.EM6**
Test Date : 2015-01-28 **Tested By** : Damon
EUT : Radio transmitter for photo flash **Model Number** : Air1 for Canon
Power Supply : DC 3V **Test Mode** : TX 2402MHz
Condition : Temp:24.5'C,Humi:55%,
 Press:100.1kPa **Antenna/Distance** : 2014 HF907/3m/HORIZONTAL
Memo :

Data: 18

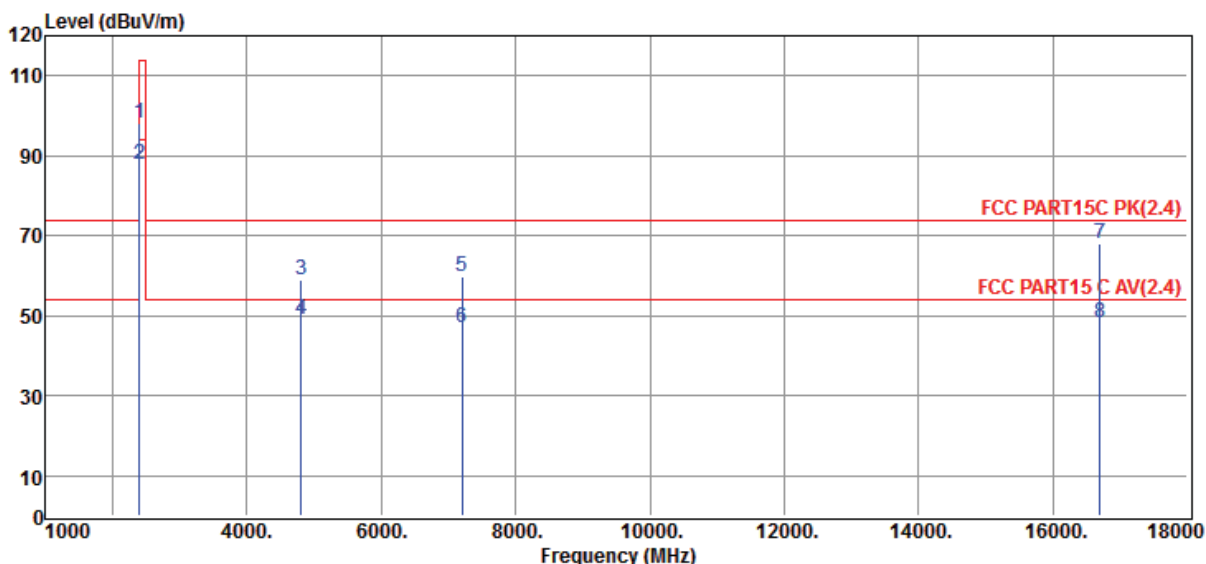

Item (Mark)	Freq (MHz)	Read Level (dBμV)	Antenna Factor (dB/m)	PRM Factor dB	Cable Loss dB	Result Level (dBμV/m)	Limit Line (dBμV/m)	Over Limit (dB)	Detector	Polarization
1	2402.00	89.92	29.99	30.21	8.35	98.05	114.00	-15.95	Peak	HORIZONTAL
2	2402.00	79.66	29.99	30.21	8.35	87.79	94.00	-6.21	Average	HORIZONTAL
3	4804.00	40.75	35.40	29.13	12.07	59.09	74.00	-14.91	Peak	HORIZONTAL
4	4804.00	30.57	35.40	29.13	12.07	48.91	54.00	-5.09	Average	HORIZONTAL
5	7206.00	37.15	37.22	29.68	15.18	59.87	74.00	-14.13	Peak	HORIZONTAL
6	7206.00	24.35	37.22	29.68	15.18	47.07	54.00	-6.93	Average	HORIZONTAL
7	16691.00	35.95	43.66	36.76	25.00	67.85	74.00	-6.15	Peak	HORIZONTAL
8	16691.00	16.49	43.66	36.76	25.00	48.39	54.00	-5.61	Average	HORIZONTAL

- Note: 1. Result Level = Read Level + Antenna Factor + Cable loss - PRM Factor.
 2. If Peak Result complies with AV limit, AV Result is deemed to comply with AV limit.
 3. Test setup: RBW: 1 MHz, VBW: 3 MHz, Sweep time: auto.
 4. For fundamental frequency RBW 4MHz, VBW 10MHz, Peak detector.

TR-4-E-009 Radiated Emission Test Result

Test Site	: DDT 3m Chamber	E:\2015 Report Data\15Q0123-1\FCC ID.EM6
Test Date	: 2015-01-28	Tested By : Damon
EUT	: Radio transmitter for photo flash	Model Number : Air1 for Canon
Power Supply	: DC 3V	Test Mode : TX 2449MHz
Condition	: Temp:24.5'C,Humi:55%, Press:100.1kPa	Antenna/Distance : 2014 HF907/3m/HORIZONTAL
Memo	:	

Data: 19

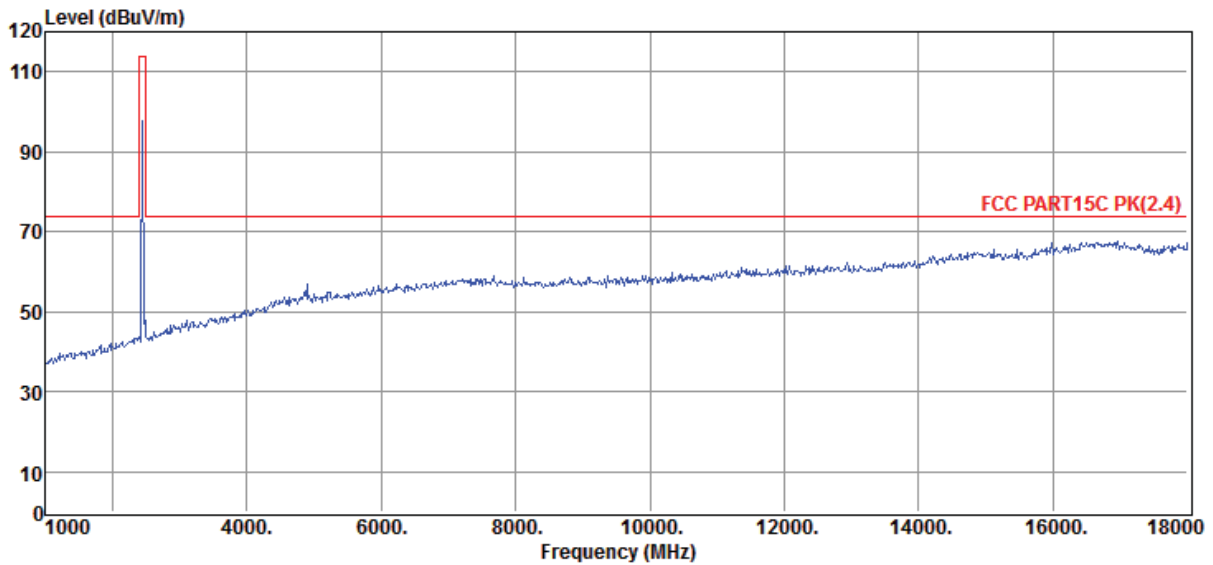

Item	Freq	Read Level	Antenna Factor	PRM Factor	Cable Loss	Result Level	Limit Line	Over Limit	Detector	Polarization
(Mark)	(MHz)	(dBμV)	(dB/m)	dB	dB	(dBμV/m)	(dBμV/m)	(dB)		

- Note: 1. Result Level = Read Level + Antenna Factor + Cable loss - PRM Factor.
 2. If Peak Result complies with AV limit, AV Result is deemed to comply with AV limit.
 3. Test setup: RBW: 1 MHz, VBW: 3 MHz, Sweep time: auto.
 4. For fundamental frequency RBW 4MHz, VBW 10MHz, Peak detector.

TR-4-E-009 Radiated Emission Test Result

Test Site : DDT 3m Chamber E:\2015 Report Data\15Q0123-1\FCC ID.EM6
Test Date : 2015-01-28 **Tested By** : Damon
EUT : Radio transmitter for photo flash **Model Number** : Air1 for Canon
Power Supply : DC 3V **Test Mode** : TX 2449MHz
Condition : Temp:24.5'C,Humi:55%,
 Press:100.1kPa **Antenna/Distance** : 2014 HF907/3m/HORIZONTAL
Memo :

Data: 20

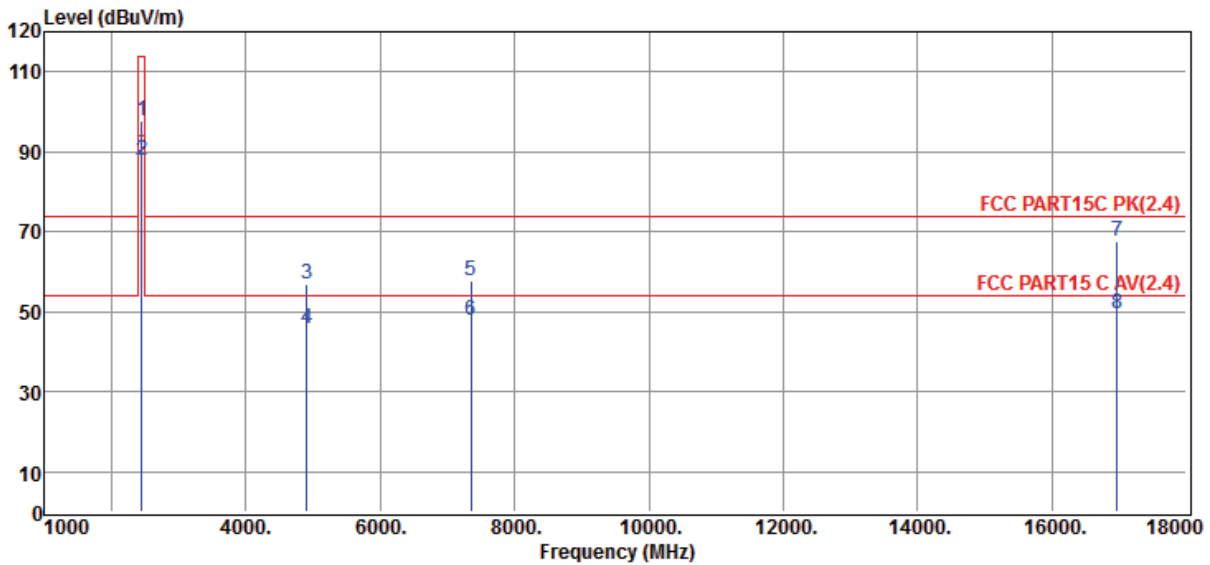

Item (Mark)	Freq (MHz)	Read Level (dBμV)	Antenna Factor (dB/m)	PRM Factor dB	Cable Loss dB	Result Level (dBμV/m)	Limit Line (dBμV/m)	Over Limit (dB)	Detector	Polarization
1	2449.00	89.41	30.14	30.23	8.45	97.77	114.00	-16.23	Peak	HORIZONTAL
2	2449.00	79.53	30.14	30.23	8.45	87.89	94.00	-6.11	Average	HORIZONTAL
3	4898.00	38.45	35.53	29.08	12.04	56.94	74.00	-17.06	Peak	HORIZONTAL
4	4898.00	27.15	35.53	29.08	12.04	45.64	54.00	-8.36	Average	HORIZONTAL
5	7347.00	34.90	37.31	29.88	15.46	57.79	74.00	-16.21	Peak	HORIZONTAL
6	7347.00	24.82	37.31	29.88	15.46	47.71	54.00	-6.29	Average	HORIZONTAL
7	16963.00	35.21	43.61	36.99	25.60	67.43	74.00	-6.57	Peak	HORIZONTAL
8	16963.00	17.12	43.61	36.99	25.60	49.34	54.00	-4.66	Average	HORIZONTAL

- Note: 1. Result Level = Read Level + Antenna Factor + Cable loss - PRM Factor.
 2. If Peak Result complies with AV limit, AV Result is deemed to comply with AV limit.
 3. Test setup: RBW: 1 MHz, VBW: 3 MHz, Sweep time: auto.
 4. For fundamental frequency RBW 4MHz, VBW 10MHz, Peak detector.

TR-4-E-009 Radiated Emission Test Result

Test Site	: DDT 3m Chamber	E:\2015 Report Data\15Q0123-1\FCC ID.EM6
Test Date	: 2015-01-28	Tested By : Damon
EUT	: Radio transmitter for photo flash	Model Number : Air1 for Canon
Power Supply	: DC 3V	Test Mode : TX 2449MHz
Condition	: Temp:24.5'C,Humi:55%, Press:100.1kPa	Antenna/Distance : 2014 HF907/3m/VERTICAL
Memo	:	

Data: 21

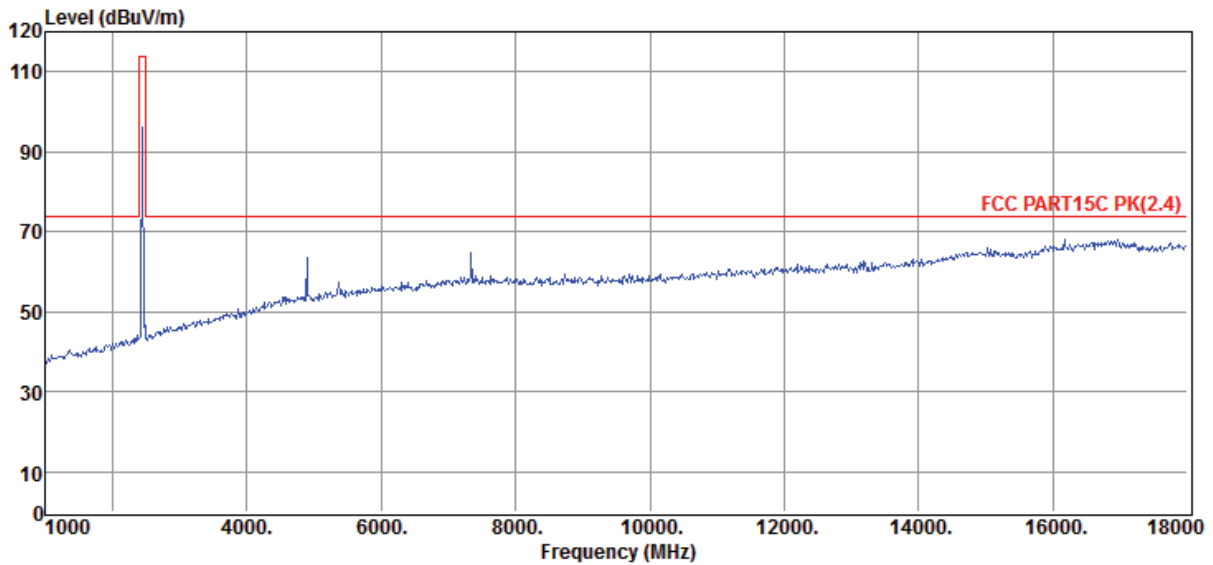

Item	Freq	Read Level	Antenna Factor	PRM Factor	Cable Loss	Result Level	Limit Line	Over Limit	Detector	Polarization
(Mark)	(MHz)	(dBμV)	(dB/m)	dB	dB	(dBμV/m)	(dBμV/m)	(dB)		

- Note: 1. Result Level = Read Level + Antenna Factor + Cable loss - PRM Factor.
 2. If Peak Result complies with AV limit, AV Result is deemed to comply with AV limit.
 3. Test setup: RBW: 1 MHz, VBW: 3 MHz, Sweep time: auto.
 4. For fundamental frequency RBW 4MHz, VBW 10MHz, Peak detector.

TR-4-E-009 Radiated Emission Test Result

Test Site : DDT 3m Chamber E:\2015 Report Data\15Q0123-1\FCC ID.EM6
Test Date : 2015-01-28 **Tested By** : Damon
EUT : Radio transmitter for photo flash **Model Number** : Air1 for Canon
Power Supply : DC 3V **Test Mode** : TX 2449MHz
Condition : Temp:24.5'C,Humi:55%,
 Press:100.1kPa **Antenna/Distance** : 2014 HF907/3m/VERTICAL
Memo :

Data: 22

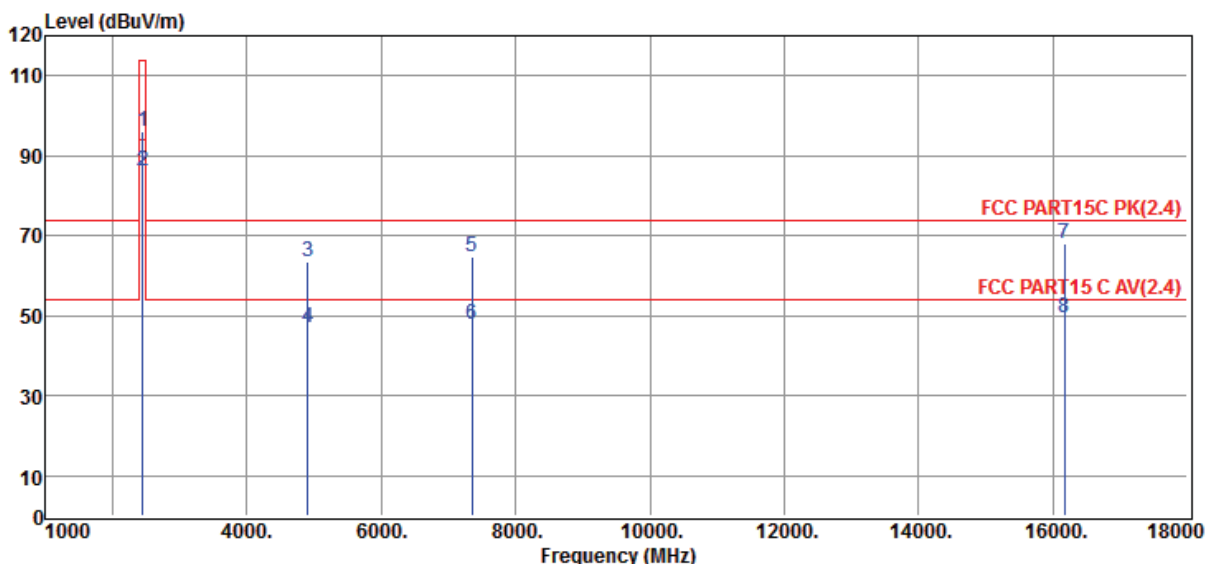

Item (Mark)	Freq (MHz)	Read Level (dBμV)	Antenna Factor (dB/m)	PRM Factor dB	Cable Loss dB	Result Level (dBμV/m)	Limit Line (dBμV/m)	Over Limit (dB)	Detector	Polarization
1	2449.00	87.90	30.14	30.23	8.45	96.26	114.00	-17.74	Peak	VERTICAL
2	2449.00	77.68	30.14	30.23	8.45	86.04	94.00	-7.96	Average	VERTICAL
3	4898.00	45.09	35.53	29.08	12.04	63.58	74.00	-10.42	Peak	VERTICAL
4	4898.00	28.53	35.53	29.08	12.04	47.02	54.00	-6.98	Average	VERTICAL
5	7347.00	41.78	37.31	29.88	15.46	64.67	74.00	-9.33	Peak	VERTICAL
6	7347.00	24.77	37.31	29.88	15.46	47.66	54.00	-6.34	Average	VERTICAL
7	16164.00	37.03	43.30	36.52	24.20	68.01	74.00	-5.99	Peak	VERTICAL
8	16164.00	18.69	43.30	36.52	24.20	49.67	54.00	-4.33	Average	VERTICAL

- Note: 1. Result Level = Read Level + Antenna Factor + Cable loss - PRM Factor.
 2. If Peak Result complies with AV limit, AV Result is deemed to comply with AV limit.
 3. Test setup: RBW: 1 MHz, VBW: 3 MHz, Sweep time: auto.
 4. For fundamental frequency RBW 4MHz, VBW 10MHz, Peak detector.

5. Band Edge Compliance

5.1. Test equipment

Item	Equipment	Manufacturer	Model No.	Serial No.	Last Cal.	Cal. Interval
1	EMI Test Receiver	R&S	ESU8	100316	2014/11/13	1Y
2	Spectrum analyzer	R&S	FSU	1166.1660.26	2014/11/13	1Y
3	Trilog Broadband Antenna	Schwarzbeck	VULB9163	9163-462	2014/11/13	1Y
4	Double Ridged Horn Antenna	R&S	HF907	100276	2014/11/13	1Y
5	Pre-Amplifier	R&S	SCU-01	10049	2014/11/13	1Y
6	Pre-amplifier	A.H.	PAM0-0118	360	2014/11/13	1Y
7	RF Cable	R&S	R01	10403	2014/11/13	1Y
8	RF Cable	R&S	R02	10512	2014/11/13	1Y

5.2. Block diagram of test setup

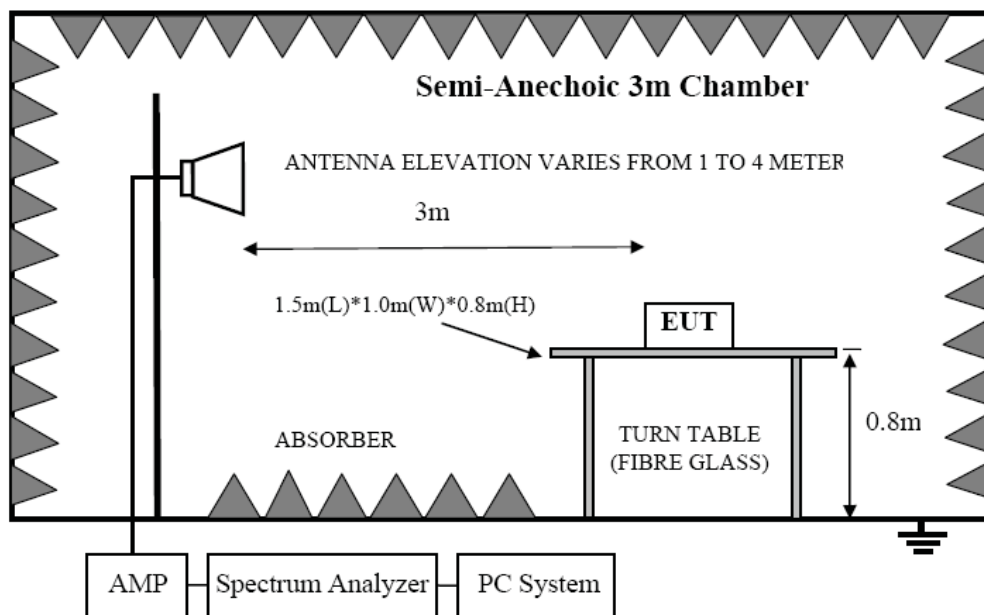

5.3. Limit

All emissions outside operation frequency band 2400MHz to 2483.5MHz shall be comply with 15.209 limits.

5.4. Test Procedure

Same with clause 4.4 except change investigated frequency range from 2310MHz to 2410MHz and 2475MHz to 2500MHz. All bands have been tested, only worse case is reported.

5.5. Test result

PASS. (See below detailed test result)

TR-4-E-009 Radiated Emission Test Result

Test Site	: DDT 3m Chamber	E:\2015 Report Data\15Q0123-1\FCC ID.EM6
Test Date	: 2015-01-28	Tested By : Damon
EUT	: Radio transmitter for photo flash	Model Number : Air1 for Canon
Power Supply	: DC 3V	Test Mode : TX 2402MHz
Condition	: Temp:24.5'C,Humi:55%, Press:100.1kPa	Antenna/Distance : 2014 HF907/3m/VERTICAL
Memo	:	

Data: 3

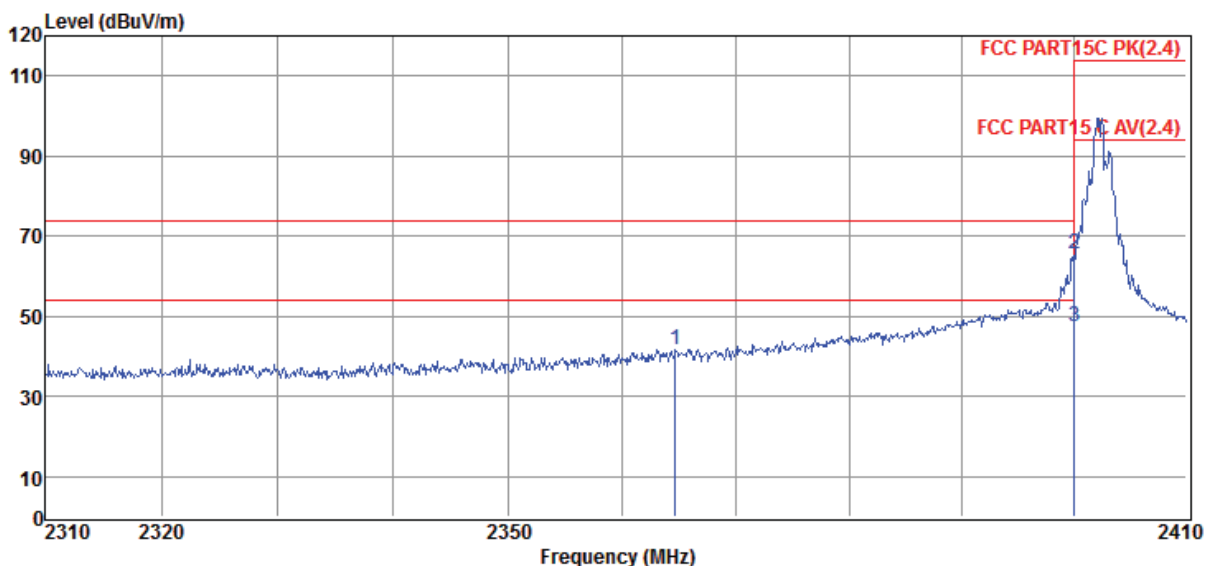

Item (Mark)	Freq (MHz)	Read Level (dBμV)	Antenna Factor (dB/m)	PRM Factor dB	Cable Loss dB	Result Level (dBμV/m)	Limit Line (dBμV/m)	Over Limit (dB)	Detector	Polarization
1	2364.68	33.70	29.89	30.19	8.30	41.70	74.00	-32.30	Peak	VERTICAL
2	2400.00	57.60	29.99	30.21	8.35	65.73	74.00	-8.27	Peak	VERTICAL
3	2400.00	39.36	29.99	30.21	8.35	47.49	54.00	-6.51	Average	VERTICAL

- Note: 1. Result Level = Read Level + Antenna Factor + Cable loss - PRM Factor.
 2. If Peak Result complies with AV limit, AV Result is deemed to comply with AV limit.
 3. Test setup: RBW: 1 MHz, VBW: 3 MHz, Sweep time: auto.
 4. For fundamental frequency RBW 4MHz, VBW 10MHz, Peak detector.

TR-4-E-009 Radiated Emission Test Result

Test Site	: DDT 3m Chamber	E:\2015 Report Data\15Q0123-1\FCC ID.EM6
Test Date	: 2015-01-28	Tested By : Damon
EUT	: Radio transmitter for photo flash	Model Number : Air1 for Canon
Power Supply	: DC 3V	Test Mode : TX 2402MHz
Condition	: Temp:24.5'C,Humi:55%, Press:100.1kPa	Antenna/Distance : 2014 HF907/3m/HORIZONTAL
Memo	:	

Data: 4

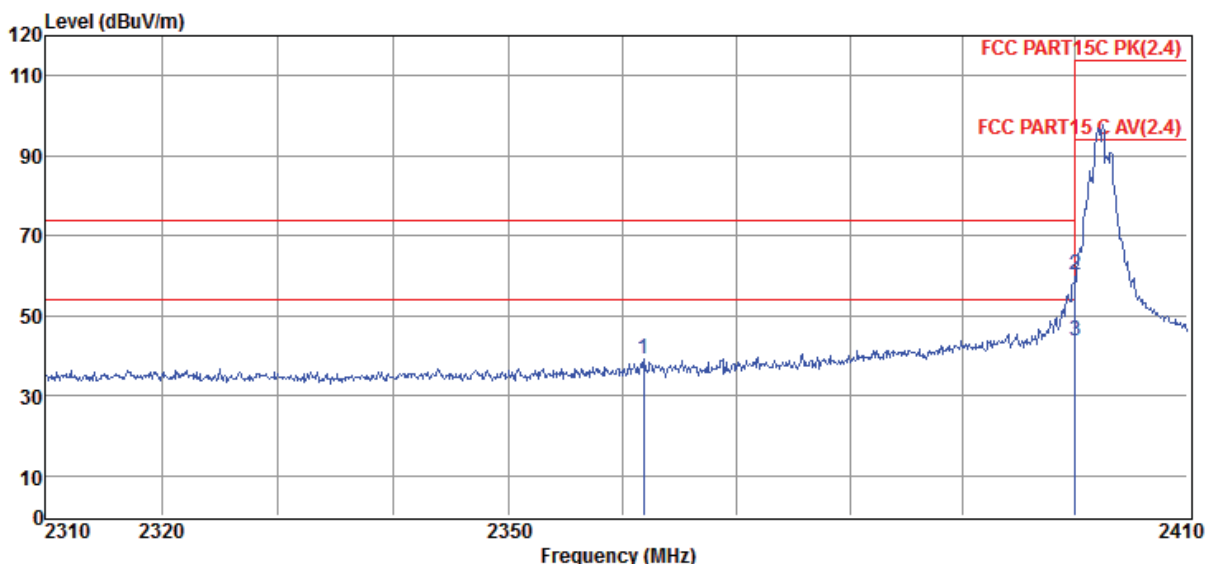

Item (Mark)	Freq (MHz)	Read Level (dBμV)	Antenna Factor (dB/m)	PRM Factor dB	Cable Loss dB	Result Level (dBμV/m)	Limit Line (dBμV/m)	Over Limit (dB)	Detector	Polarization
1	2361.87	31.10	29.89	30.19	8.30	39.10	74.00	-34.90	Peak	HORIZONTAL
2	2400.00	52.09	29.99	30.21	8.35	60.22	74.00	-13.78	Peak	HORIZONTAL
3	2400.00	35.61	29.99	30.21	8.35	43.74	54.00	-10.26	Average	HORIZONTAL

- Note: 1. Result Level = Read Level + Antenna Factor + Cable loss - PRM Factor.
 2. If Peak Result complies with AV limit, AV Result is deemed to comply with AV limit.
 3. Test setup: RBW: 1 MHz, VBW: 3 MHz, Sweep time: auto.
 4. For fundamental frequency RBW 4MHz, VBW 10MHz, Peak detector.

TR-4-E-009 Radiated Emission Test Result

Test Site	: DDT 3m Chamber	E:\2015 Report Data\15Q0123-1\FCC ID.EM6
Test Date	: 2015-01-28	Tested By : Damon
EUT	: Radio transmitter for photo flash	Model Number : Air1 for Canon
Power Supply	: DC 3V	Test Mode : TX 2476MHz
Condition	: Temp:24.5'C,Humi:55%, Press:100.1kPa	Antenna/Distance : 2014 HF907/3m/HORIZONTAL
Memo	:	

Data: 5

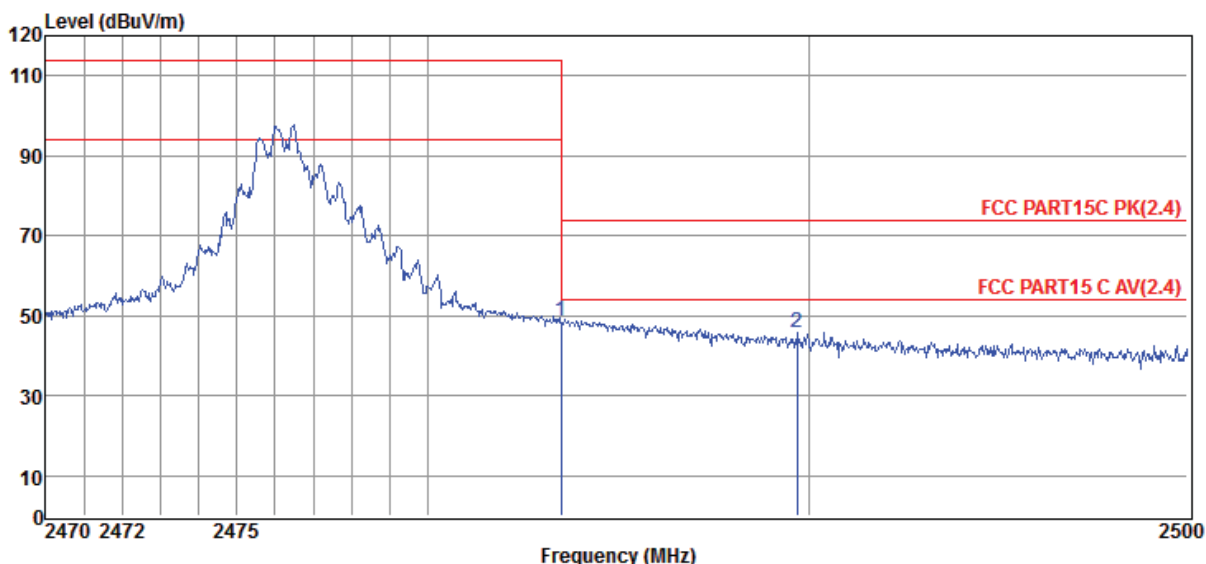

Item (Mark)	Freq (MHz)	Read Level (dBμV)	Antenna Factor (dB/m)	PRM Factor dB	Cable Loss dB	Result Level (dBμV/m)	Limit Line (dBμV/m)	Over Limit (dB)	Detector	Polarization
1	2483.50	40.34	30.25	30.25	8.50	48.84	74.00	-25.16	Peak	HORIZONTAL
2	2489.70	37.10	30.30	30.25	8.50	45.65	74.00	-28.35	Peak	HORIZONTAL

- Note: 1. Result Level = Read Level + Antenna Factor + Cable loss - PRM Factor.
 2. If Peak Result complies with AV limit, AV Result is deemed to comply with AV limit.
 3. Test setup: RBW: 1 MHz, VBW: 3 MHz, Sweep time: auto.
 4. For fundamental frequency RBW 4MHz, VBW 10MHz, Peak detector.

TR-4-E-009 Radiated Emission Test Result

Test Site	: DDT 3m Chamber	E:\2015 Report Data\15Q0123-1\FCC ID.EM6
Test Date	: 2015-01-28	Tested By : Damon
EUT	: Radio transmitter for photo flash	Model Number : Air1 for Canon
Power Supply	: DC 3V	Test Mode : TX 2476MHz
Condition	: Temp:24.5'C,Humi:55%, Press:100.1kPa	Antenna/Distance : 2014 HF907/3m/VERTICAL
Memo	:	

Data: 6

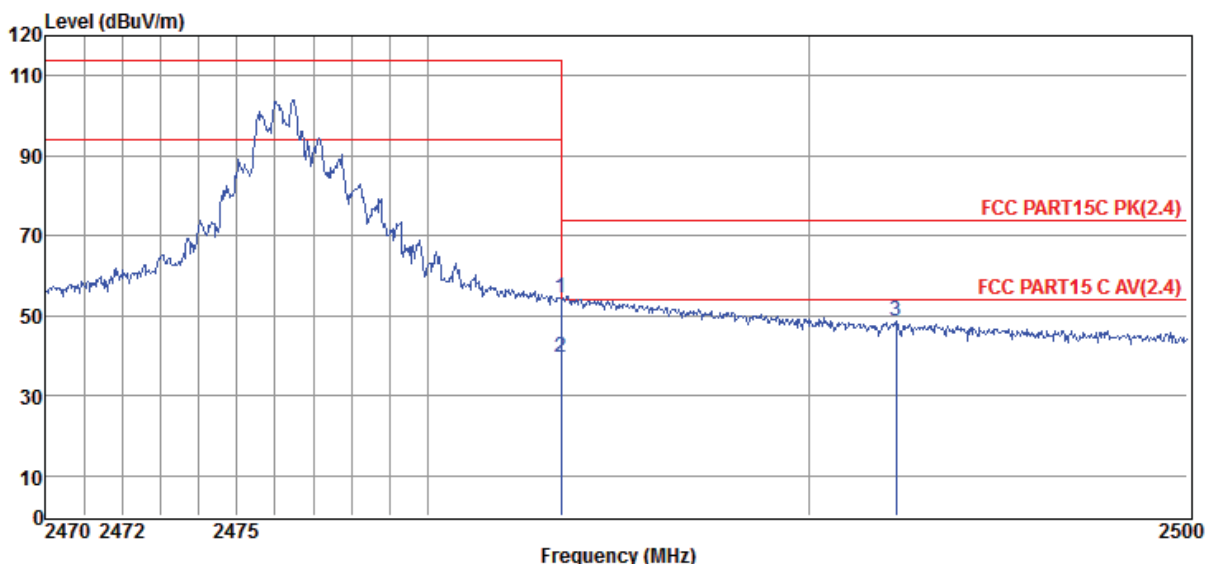

Item (Mark)	Freq (MHz)	Read Level (dBμV)	Antenna Factor (dB/m)	PRM Factor dB	Cable Loss dB	Result Level (dBμV/m)	Limit Line (dBμV/m)	Over Limit (dB)	Detector	Polarization
1	2483.50	45.96	30.25	30.25	8.50	54.46	74.00	-19.54	Peak	VERTICAL
2	2483.50	31.00	30.25	30.25	8.50	39.50	54.00	-14.50	Average	VERTICAL
3	2492.32	39.95	30.30	30.25	8.50	48.50	74.00	-25.50	Peak	VERTICAL

- Note: 1. Result Level = Read Level + Antenna Factor + Cable loss - PRM Factor.
 2. If Peak Result complies with AV limit, AV Result is deemed to comply with AV limit.
 3. Test setup: RBW: 1 MHz, VBW: 3 MHz, Sweep time: auto.
 4. For fundamental frequency RBW 4MHz, VBW 10MHz, Peak detector.

6. Antenna Requirements

6.1. Limit

For intentional device, according to FCC 47 CFR Section 15.203, an intentional radiator shall be designed to ensure that no antenna other than that furnished by the responsible party shall be used with the device.

6.2. Result

The antennas used for this product are integral PCB Antenna and that no antenna other than that furnished by the responsible party shall be used with the device, the maximum peak gain of the transmit antenna is only 0dBi.

END OF REPORT