

## Radiated Emission Test (below 1GHz, for GPE048G-180150-D) TR-4-E-009 Radiated Emission Test Result

<b>Test Date:</b> 2023-02-27	<b>Tested By:</b> Liaowanrong
<b>EUT:</b> COMPLETE CONTENT CREATION STUDIO	<b>Model Number:</b> DLZ CREATOR
<b>Test Mode:</b> TX Mode	<b>Power Supply:</b> AC 120V/60HZ
<b>Condition:</b> Temp:24.2°C;Humi:50.8%	<b>Test Site:</b> DDT 3# Chamber
<b>File Path:</b> d:\ts\2022 report data\Q22021607-2E DLZ CREATOR\FCC BELOW 1G\20230227-195639_H	
<b>Memo:</b> BT	

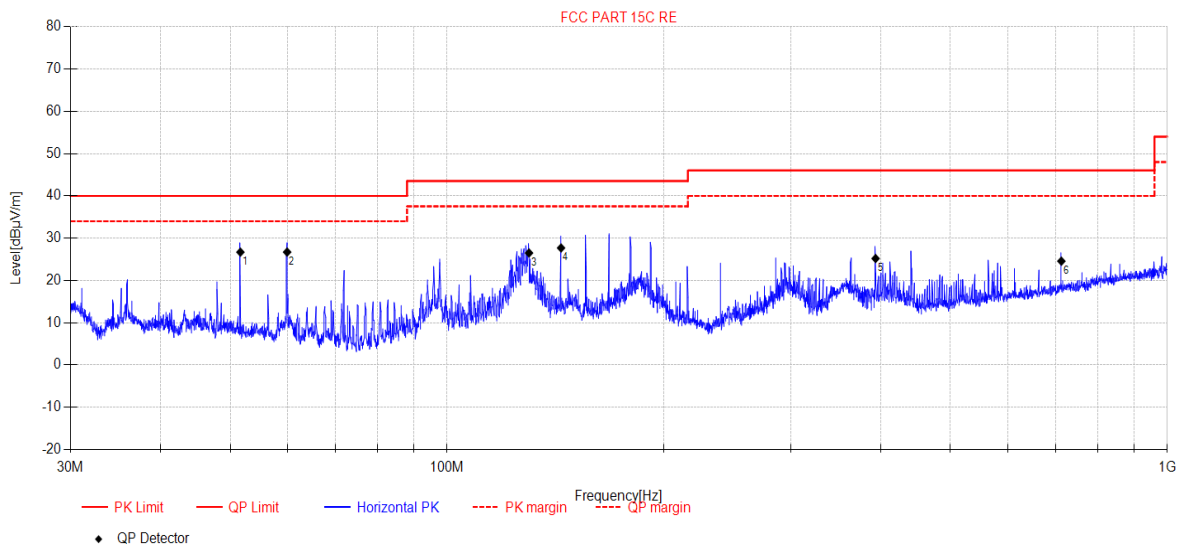

Final Data List										
NO.	Freq. [MHz]	Reading [dBµV/m]	Antenna Factor [dB]	Cable Loss [dB]	AMP [dB]	Result [dBµV/m]	Limit [dBµV/m]	Margin [dB]	Detector	Polarity
1	51.66	45.11	13.03	0.83	-32.28	26.69	40.00	13.31	QP	Horizontal
2	59.98	46.15	11.90	0.93	-32.27	26.71	40.00	13.29	QP	Horizontal
3	129.98	49.42	7.70	1.58	-32.20	26.50	43.50	17.00	QP	Horizontal
4	143.99	50.81	7.40	1.66	-32.19	27.68	43.50	15.82	QP	Horizontal
5	393.55	39.45	15.27	2.83	-32.36	25.19	46.00	20.81	QP	Horizontal
6	712.72	33.34	20.20	3.87	-32.85	24.56	46.00	21.44	QP	Horizontal

**Note:**

1. Result Level = Reading + Cable loss + Antenna Factor + AMP
2. If Peak Result complies with QP limit, QP Result is deemed to comply with QP limit.
3. Test setup: RBW: 120 kHz, VBW: 300 kHz, Sweep time: auto.

# TR-4-E-009 Radiated Emission Test Result

**Test Date:** 2023-02-27  
**EUT:** COMPLETE CONTENT CREATION STUDIO  
**Test Mode:** TX Mode  
**Condition:** Temp:24.2°C;Humi:50.8%  
**File Path:** d:\ts\2022 report data\Q22021607-2E DLZ CREATOR\FCC BELOW 1G\20230227-195724\_V  
**Memo:** BT

**Tested By:** Liaowanrong  
**Model Number:** DLZ CREATOR  
**Power Supply:** AC 120V/60HZ  
**Test Site:** DDT 3# Chamber

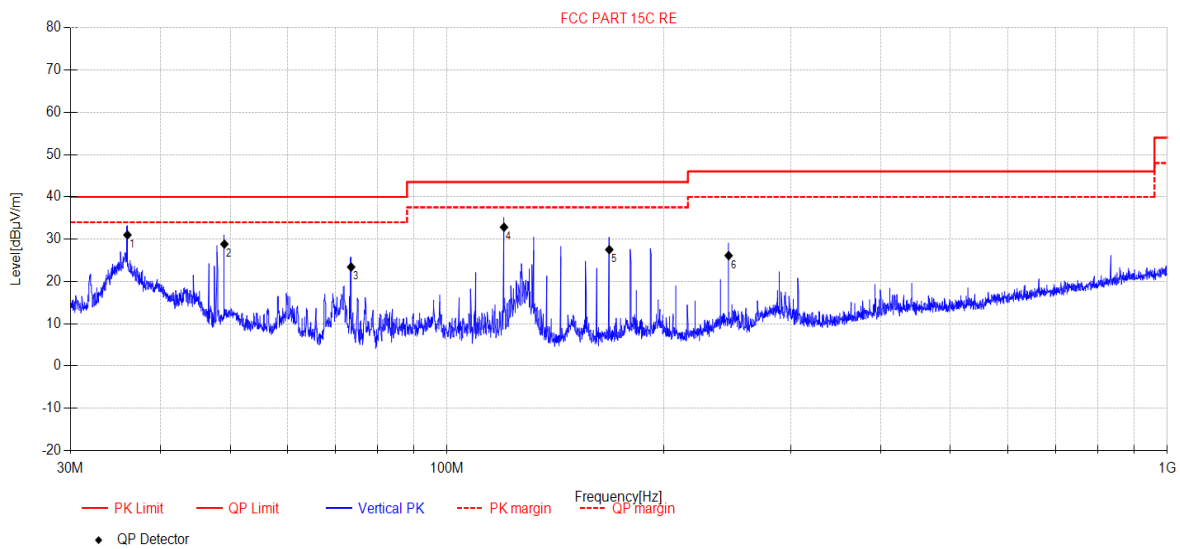

Final Data List										
NO.	Freq. [MHz]	Reading [dBuV/m]	Antenna Factor [dB]	Cable Loss [dB]	AMP [dB]	Result [dBuV/m]	Limit [dBuV/m]	Margin [dB]	Detector	Polarity
1	36.00	51.42	11.20	0.67	-32.29	31.00	40.00	9.00	QP	Vertical
2	49.08	47.12	13.19	0.80	-32.28	28.83	40.00	11.17	QP	Vertical
3	73.60	47.16	7.42	1.09	-32.26	23.41	40.00	16.59	QP	Vertical
4	119.99	54.83	8.70	1.52	-32.22	32.83	43.50	10.67	QP	Vertical
5	168.00	49.53	8.40	1.81	-32.22	27.52	43.50	15.98	QP	Vertical
6	246.02	43.89	12.22	2.20	-32.20	26.11	46.00	19.89	QP	Vertical

**Note:**

1. Result Level = Reading + Cable loss + Antenna Factor + AMP
2. If Peak Result complies with QP limit, QP Result is deemed to comply with QP limit.
3. Test setup: RBW: 120 kHz, VBW: 300 kHz, Sweep time: auto.

**Radiated Emission Test (below 1GHz, for GME36E-180150FDR)**

# TR-4-E-009 Radiated Emission Test Result

**Test Date:** 2023-03-04 **Tested By:** Liaowanrong  
**EUT:** COMPLETE CONTENT CREATION STUDIO **Model Number:** DLZ CREATOR  
**Test Mode:** TX Mode **Power Supply:** AC 120V/60HZ  
**Condition:** Temp:23.2°C;Humi:51.8% **Test Site:** DDT 3# Chamber  
**File Path:** d:\ts\2022 report data\Q22021607-2E DLZ CREATOR \FCC BELOW 1G\20230304-110213\_H  
**Memo:** BT

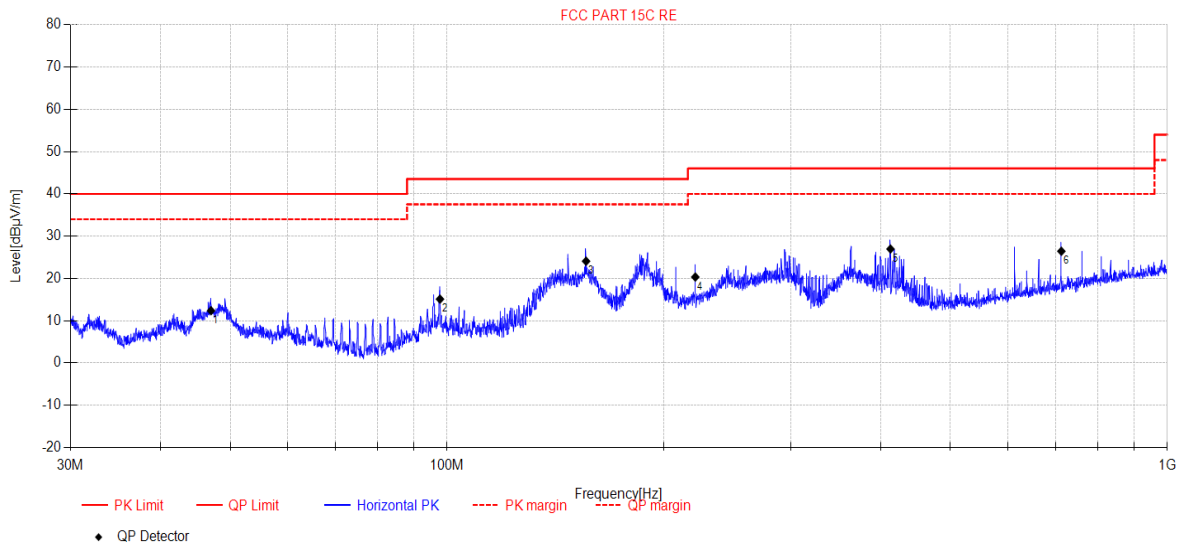

Final Data List										
NO.	Freq. [MHz]	Reading [dBµV/m]	Antenna Factor [dB]	Cable Loss [dB]	AMP [dB]	Result [dBµV/m]	Limit [dBµV/m]	Margin [dB]	Detector	Polarity
1	47.02	30.67	13.20	0.78	-32.28	12.37	40.00	27.63	QP	Horizontal
2	97.78	35.3	10.68	1.37	-32.24	15.11	43.50	28.39	QP	Horizontal
3	155.97	46.72	7.80	1.74	-32.19	24.07	43.50	19.43	QP	Horizontal
4	221.15	39.19	11.25	2.09	-32.20	20.33	46.00	25.67	QP	Horizontal
5	412.76	40.84	15.60	2.90	-32.38	26.96	46.00	19.04	QP	Horizontal
6	712.72	35.22	20.20	3.87	-32.85	26.44	46.00	19.56	QP	Horizontal

**Note:**

1. Result Level = Reading + Cable loss + Antenna Factor + AMP
2. If Peak Result complies with QP limit, QP Result is deemed to comply with QP limit.
3. Test setup: RBW: 120 kHz, VBW: 300 kHz, Sweep time: auto.

# TR-4-E-009 Radiated Emission Test Result

**Test Date:** 2023-03-04 **Tested By:** Liaowanrong  
**EUT:** COMPLETE CONTENT CREATION STUDIO **Model Number:** DLZ CREATOR  
**Test Mode:** TX Mode **Power Supply:** AC 120V/60HZ  
**Condition:** Temp:23.2°C;Humi:51.8% **Test Site:** DDT 3# Chamber  
**File Path:** d:\ts\2022 report data\Q22021607-2E DLZ CREATOR \FCC BELOW 1G\20230304-110258\_V  
**Memo:** BT

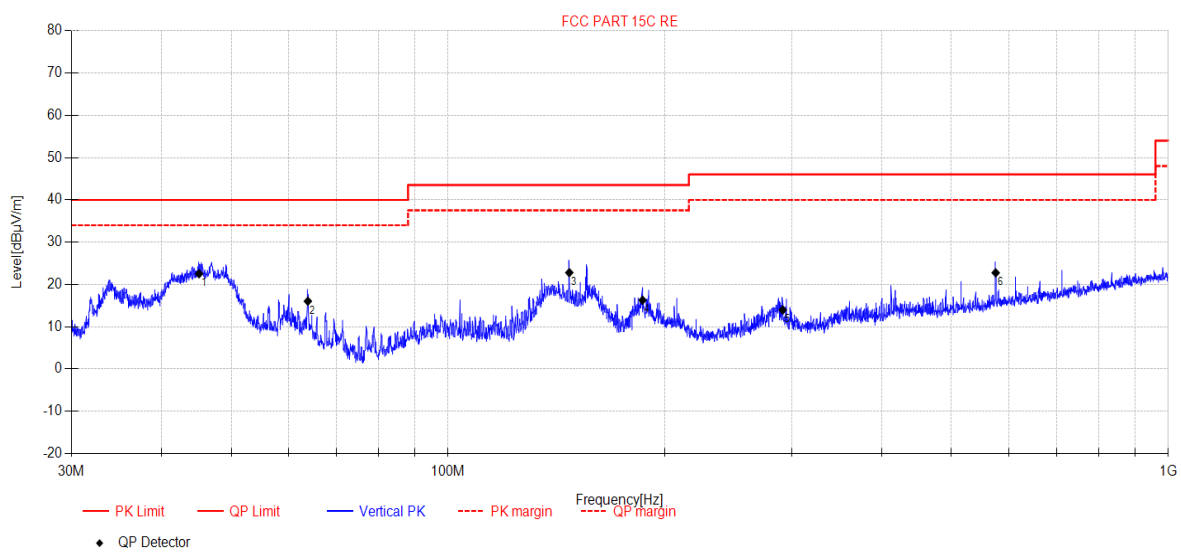

Final Data List										
NO.	Freq. [MHz]	Reading [dBμV/m]	Antenna Factor [dB]	Cable Loss [dB]	AMP [dB]	Result [dBμV/m]	Limit [dBμV/m]	Margin [dB]	Detector	Polarity
1	45.12	41.04	13.01	0.76	-32.28	22.53	40.00	17.47	QP	Vertical
2	63.88	36.42	10.92	0.97	-32.27	16.04	40.00	23.96	QP	Vertical
3	147.36	45.86	7.44	1.68	-32.18	22.80	43.50	20.70	QP	Vertical
4	186.24	36.79	9.82	1.92	-32.25	16.28	43.50	27.22	QP	Vertical
5	291.52	30.84	13.03	2.40	-32.30	13.97	46.00	32.03	QP	Vertical
6	575.90	33.77	18.22	3.44	-32.67	22.76	46.00	23.24	QP	Vertical

**Note:**

1. Result Level = Reading + Cable loss + Antenna Factor + AMP
2. If Peak Result complies with QP limit, QP Result is deemed to comply with QP limit.
3. Test setup: RBW: 120 kHz, VBW: 300 kHz, Sweep time: auto.

Radiated Emission test (above 1GHz)

TR-4-E-009 Radiated Emission Test Result

Test Date: 2022-11-02 Tested By: James Gan  
 EUT: COMPLETE CONTENT CREATION STUDIO Model Number: DLZ CREATOR  
 Test Mode: TX Mode Power Supply: AC 120V/60HZ  
 Condition: Temp:24.2°C;Humi:50.8%;Press:100.3kPa Test Site: DDT 3# Chamber  
 File Path: d:\ts\2022 report data\Q22021607-2E DLZ CREATOR\FCC ABOVE 1G\7  
 Memo: 3DH5 2402 Power:4

Test Graph

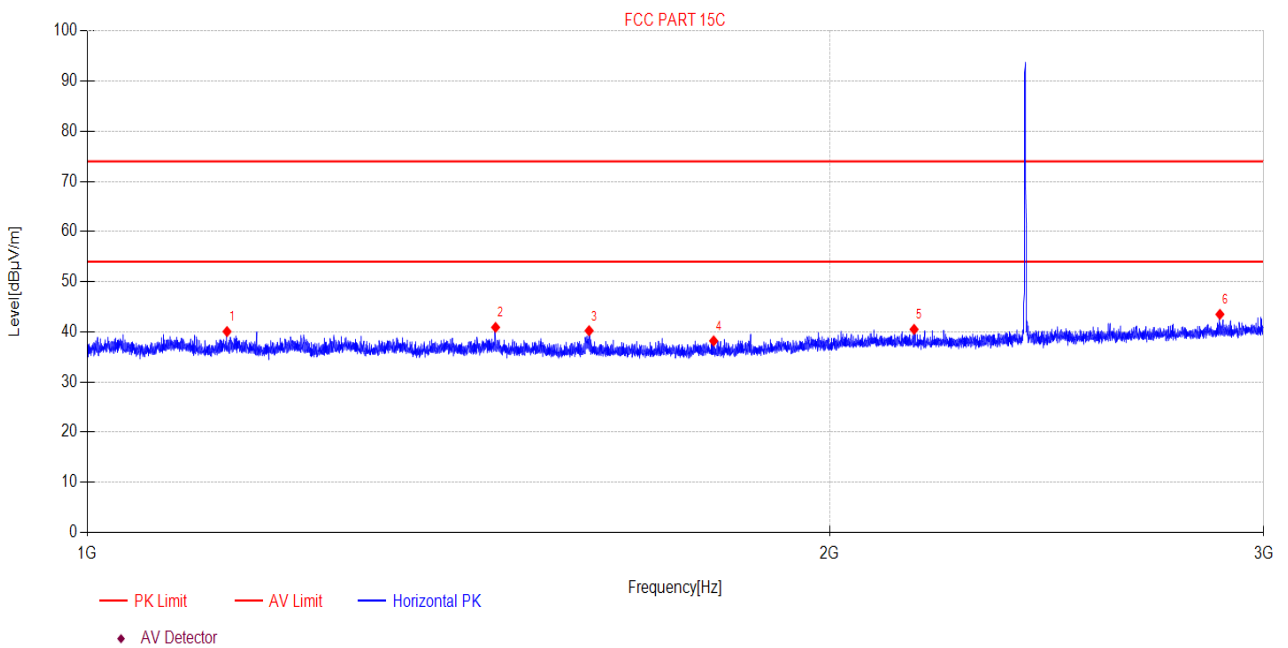

Suspected Data List								
NO.	Freq. [MHz]	Reading [dBµV]	Factor [dB]	Level [dBµV/m]	Limit [dBµV/m]	Margin [dB]	Detector	Polarity
1	1139.40	50.96	-10.90	40.06	74.00	33.94	PK	Horizontal
2	1464.17	52.11	-11.21	40.90	74.00	33.10	PK	Horizontal
3	1597.79	51.72	-11.49	40.23	74.00	33.77	PK	Horizontal
4	1794.91	49.78	-11.58	38.20	74.00	35.80	PK	Horizontal
5	2164.39	50.53	-10.03	40.50	74.00	33.50	PK	Horizontal
6	2879.88	51.80	-8.30	43.50	74.00	30.50	PK	Horizontal

Note:

1. Level = Reading + Factor.
2. If Peak Result complies with AV limit, AV Result is deemed to comply with AV limit.
3. Test setup: RBW: 1 MHz, VBW: 3 MHz, Sweep time: auto.

# TR-4-E-009 Radiated Emission Test Result

**Test Date:** 2022-11-02      **Tested By:** James Gan  
**EUT:** COMPLETE CONTENT CREATION STUDIO      **Model Number:** DLZ CREATOR  
**Test Mode:** TX Mode      **Power Supply:** AC 120V/60HZ  
**Condition:** Temp:24.2°C;Humi:50.8%;Press:100.3kPa      **Test Site:** DDT 3# Chamber  
**File Path:** d:\ts\2022 report data\Q22021607-2E DLZ CREATOR\FCC ABOVE 1G\8  
**Memo:** 3DH5 2402 Power:4

## Test Graph

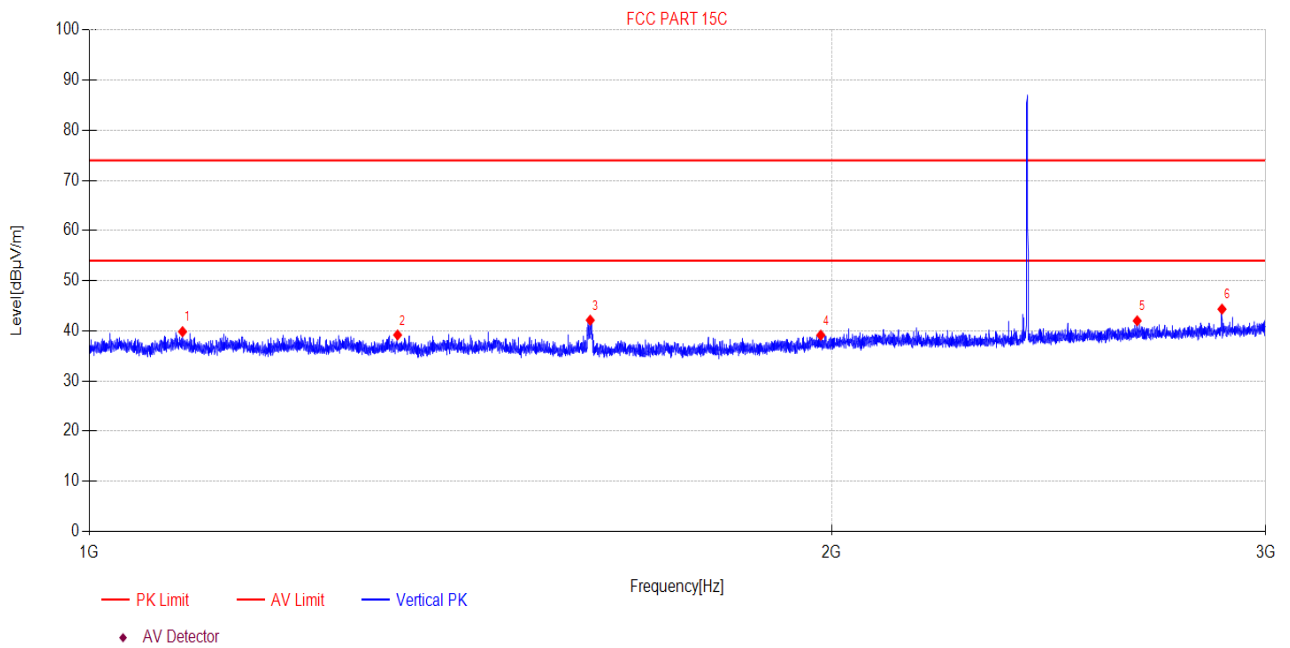

Suspected Data List								
NO.	Freq. [MHz]	Reading [dBµV]	Factor [dB]	Level [dBµV/m]	Limit [dBµV/m]	Margin [dB]	Detector	Polarity
1	1091.02	50.78	-10.94	39.84	74.00	34.16	PK	Vertical
2	1333.65	50.24	-11.06	39.18	74.00	34.82	PK	Vertical
3	1596.56	53.62	-11.49	42.13	74.00	31.87	PK	Vertical
4	1980.12	49.94	-10.79	39.15	74.00	34.85	PK	Vertical
5	2660.88	50.95	-8.94	42.01	74.00	31.99	PK	Vertical
6	2880.19	52.63	-8.30	44.33	74.00	29.67	PK	Vertical

**Note:**

1. Level = Reading + Factor.
2. If Peak Result complies with AV limit, AV Result is deemed to comply with AV limit.
3. Test setup: RBW: 1 MHz, VBW: 3 MHz, Sweep time: auto.

# TR-4-E-009 Radiated Emission Test Result

**Test Date:** 2022-11-02      **Tested By:** James Gan  
**EUT:** COMPLETE CONTENT CREATION STUDIO      **Model Number:** DLZ CREATOR  
**Test Mode:** TX Mode      **Power Supply:** AC 120V/60HZ  
**Condition:** Temp:24.2°C;Humi:50.8%;Press:100.3kPa      **Test Site:** DDT 3# Chamber  
**File Path:** d:\ts\2022 report data\Q22021607-2E DLZ CREATOR\FCC ABOVE 1G\1  
**Memo:** 3DH5 2402 Power:4

## Test Graph

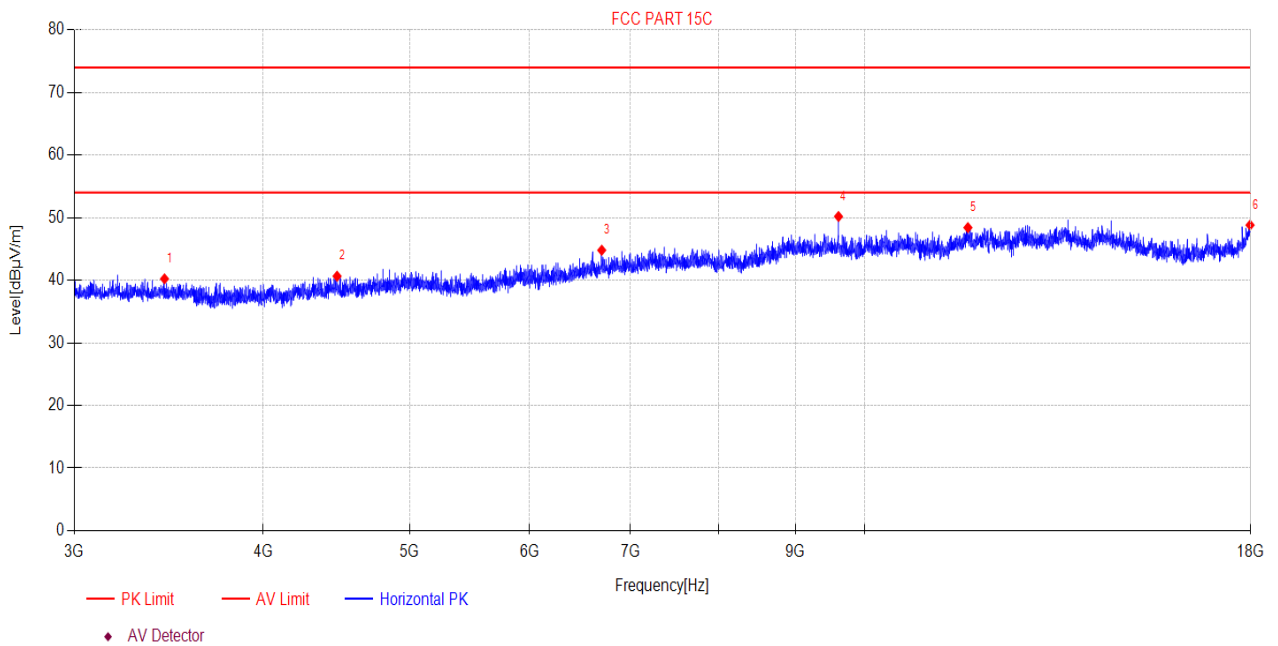

Suspected Data List								
NO.	Freq. [MHz]	Reading [dBµV]	Factor [dB]	Level [dBµV/m]	Limit [dBµV/m]	Margin [dB]	Detector	Polarity
1	3441.91	48.61	-8.38	40.23	74.00	33.77	PK	Horizontal
2	4476.54	47.04	-6.39	40.65	74.00	33.35	PK	Horizontal
3	6698.99	46.29	-1.49	44.80	74.00	29.20	PK	Horizontal
4	9608.06	47.68	2.51	50.19	74.00	23.81	PK	Horizontal
5	11701.02	44.12	4.29	48.41	74.00	25.59	PK	Horizontal
6	17983.88	40.22	8.60	48.82	74.00	25.18	PK	Horizontal

**Note:**

1. Level = Reading + Factor.
2. If Peak Result complies with AV limit, AV Result is deemed to comply with AV limit.
3. Test setup: RBW: 1 MHz, VBW: 3 MHz, Sweep time: auto.

# TR-4-E-009 Radiated Emission Test Result

**Test Date:** 2022-11-02      **Tested By:** James Gan  
**EUT:** COMPLETE CONTENT CREATION STUDIO      **Model Number:** DLZ CREATOR  
**Test Mode:** TX Mode      **Power Supply:** AC 120V/60HZ  
**Condition:** Temp:24.2°C;Humi:50.8%;Press:100.3kPa      **Test Site:** DDT 3# Chamber  
**File Path:** d:\ts\2022 report data\Q22021607-2E DLZ CREATOR\FCC ABOVE 1G\2  
**Memo:** 3DH5 2402 Power:4

## Test Graph

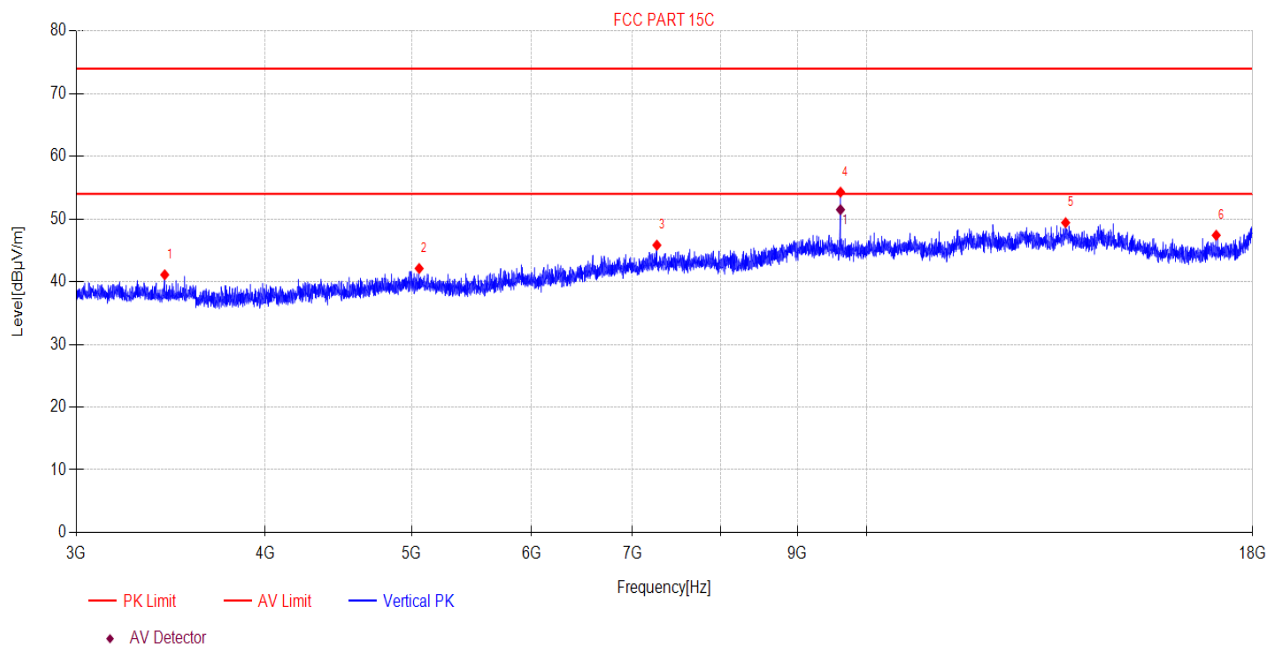

Suspected Data List								
NO.	Freq. [MHz]	Reading [dBµV]	Factor [dB]	Level [dBµV/m]	Limit [dBµV/m]	Margin [dB]	Detector	Polarity
1	3432.67	49.49	-8.38	41.11	74.00	32.89	PK	Vertical
2	5057.43	46.87	-4.76	42.11	74.00	31.89	PK	Vertical
3	7264.04	46.53	-0.70	45.83	74.00	28.17	PK	Vertical
4	9608.06	51.77	2.51	54.28	74.00	19.72	PK	Vertical
5	13538.13	43.68	5.74	49.42	74.00	24.58	PK	Vertical
6	17027.55	42.22	5.19	47.41	74.00	26.59	PK	Vertical

Final Data List								
NO.	Freq. [MHz]	Reading [dBµV]	Factor [dB]	Level [dBµV/m]	Limit [dBµV/m]	Margin [dB]	Detector	Polarity
1	9608.06	48.98	2.51	51.49	54.00	2.51	AV	Vertical



# TR-4-E-009 Radiated Emission Test Result

**Test Date:** 2022-11-02 **Tested By:** James Gan  
**EUT:** COMPLETE CONTENT CREATION STUDIO **Model Number:** DLZ CREATOR  
**Test Mode:** TX Mode **Power Supply:** AC 120V/60HZ  
**Condition:** Temp:24.2°C;Humi:50.8%;Press:100.3kPa **Test Site:** DDT 3# Chamber  
**File Path:** d:\ts\2022 report data\Q22021607-2E DLZ CREATOR\FCC ABOVE 1G\9  
**Memo:** 3DH5 2441 Power:4

## Test Graph

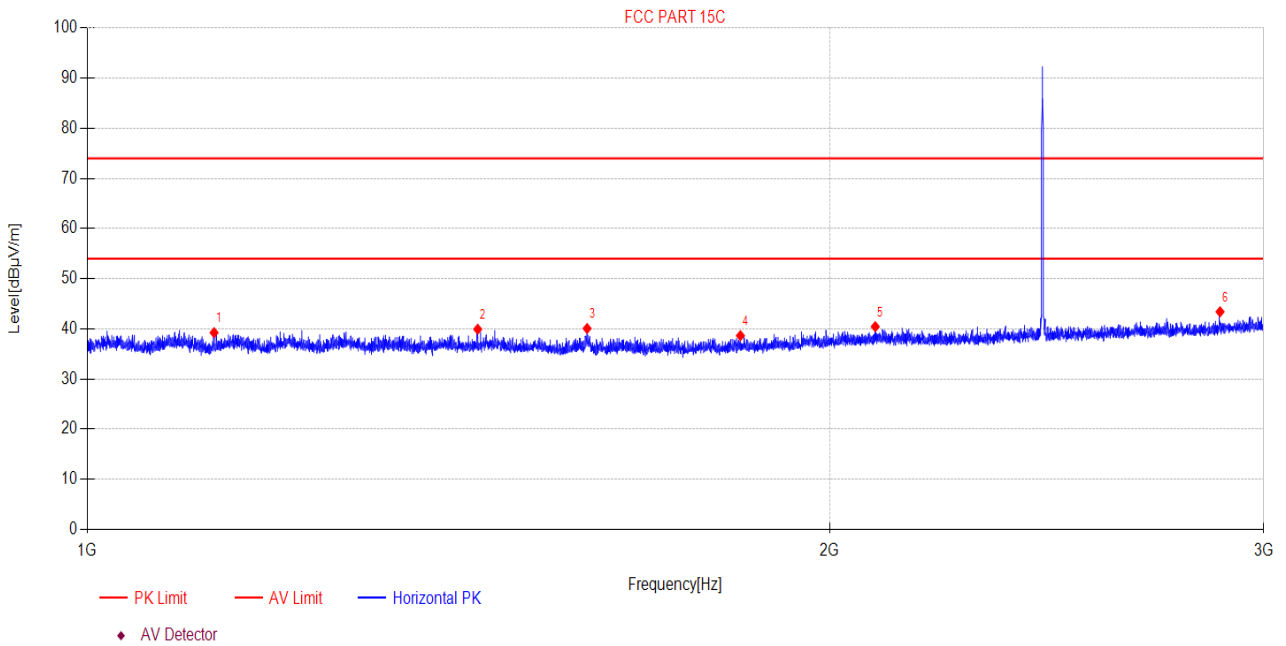

Suspected Data List								
NO.	Freq. [MHz]	Reading [dBμV]	Factor [dB]	Level [dBμV/m]	Limit [dBμV/m]	Margin [dB]	Detector	Polarity
1	1125.72	50.17	-10.92	39.25	74.00	34.75	PK	Horizontal
2	1439.93	51.09	-11.15	39.94	74.00	34.06	PK	Horizontal
3	1594.81	51.56	-11.49	40.07	74.00	33.93	PK	Horizontal
4	1840.43	50.18	-11.53	38.65	74.00	35.35	PK	Horizontal
5	2087.33	50.63	-10.19	40.44	74.00	33.56	PK	Horizontal
6	2880.19	51.71	-8.30	43.41	74.00	30.59	PK	Horizontal

**Note:**

1. Level = Reading + Factor.
2. If Peak Result complies with AV limit, AV Result is deemed to comply with AV limit.
3. Test setup: RBW: 1 MHz, VBW: 3 MHz, Sweep time: auto.

# TR-4-E-009 Radiated Emission Test Result

**Test Date:** 2022-11-02      **Tested By:** James Gan  
**EUT:** COMPLETE CONTENT CREATION STUDIO      **Model Number:** DLZ CREATOR  
**Test Mode:** TX Mode      **Power Supply:** AC 120V/60HZ  
**Condition:** Temp:24.2°C;Humi:50.8%;Press:100.3kPa      **Test Site:** DDT 3# Chamber  
**File Path:** d:\ts\2022 report data\Q22021607-2E DLZ CREATOR\FCC ABOVE 1G\10  
**Memo:** 3DH5 2441 Power:4

## Test Graph

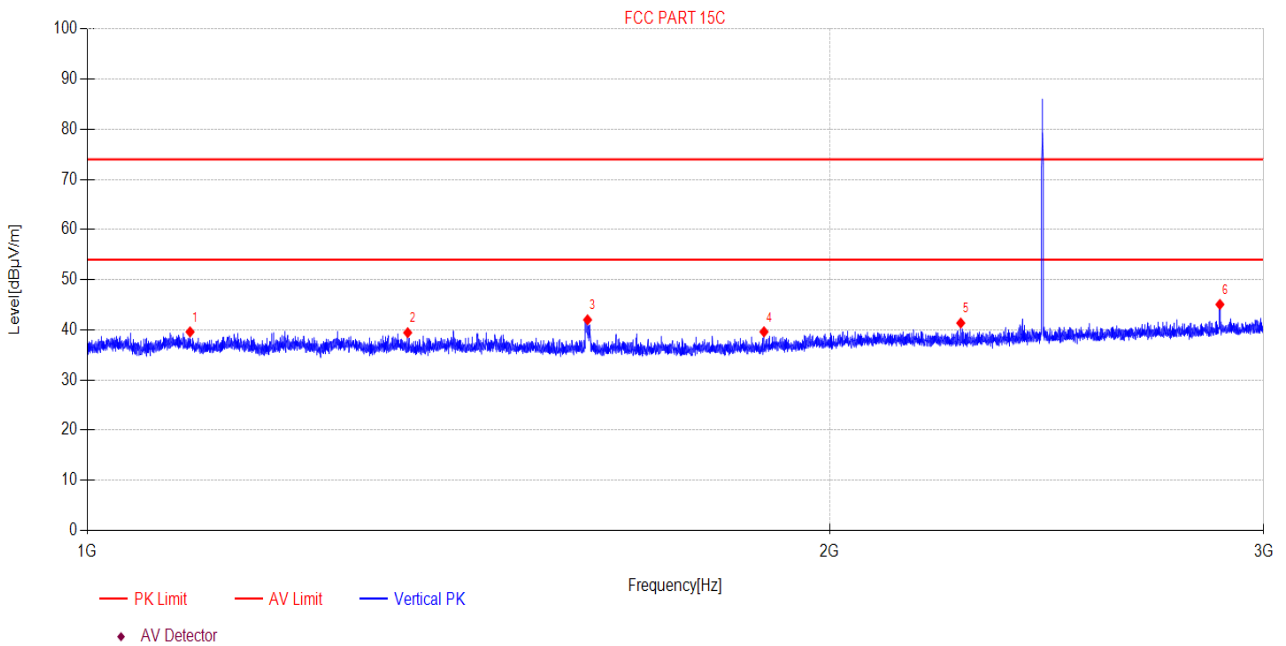

Suspected Data List								
NO.	Freq. [MHz]	Reading [dBµV]	Factor [dB]	Level [dBµV/m]	Limit [dBµV/m]	Margin [dB]	Detector	Polarity
1	1100.77	50.55	-10.95	39.60	74.00	34.40	PK	Vertical
2	1348.82	50.51	-11.07	39.44	74.00	34.56	PK	Vertical
3	1595.51	53.49	-11.49	42.00	74.00	32.00	PK	Vertical
4	1881.31	50.96	-11.35	39.61	74.00	34.39	PK	Vertical
5	2260.87	51.28	-9.91	41.37	74.00	32.63	PK	Vertical
6	2879.88	53.37	-8.30	45.07	74.00	28.93	PK	Vertical

**Note:**

1. Level = Reading + Factor.
2. If Peak Result complies with AV limit, AV Result is deemed to comply with AV limit.
3. Test setup: RBW: 1 MHz, VBW: 3 MHz, Sweep time: auto.

# TR-4-E-009 Radiated Emission Test Result

**Test Date:** 2022-11-02      **Tested By:** James Gan  
**EUT:** COMPLETE CONTENT CREATION STUDIO      **Model Number:** DLZ CREATOR  
**Test Mode:** TX Mode      **Power Supply:** AC 120V/60HZ  
**Condition:** Temp:24.2°C;Humi:50.8%;Press:100.3kPa      **Test Site:** DDT 3# Chamber  
**File Path:** d:\ts\2022 report data\Q22021607-2E DLZ CREATOR\FCC ABOVE 1G\11  
**Memo:** 3DH5 2441 Power:4

## Test Graph

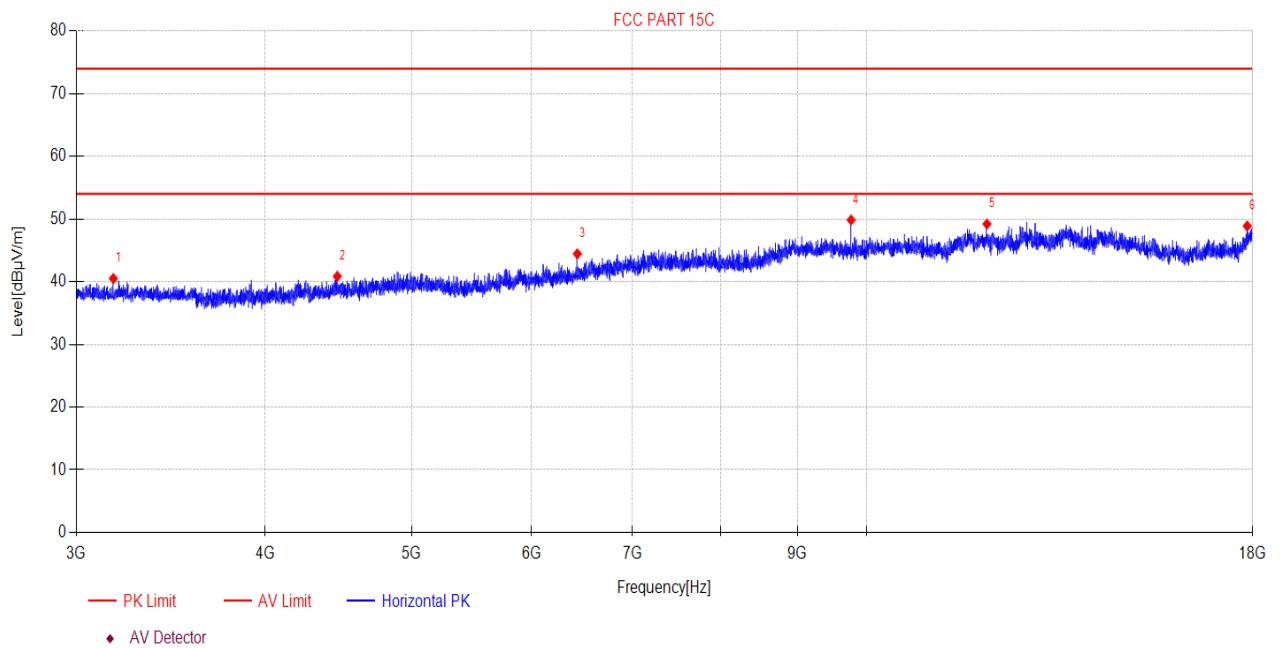

Suspected Data List								
NO.	Freq. [MHz]	Reading [dBµV]	Factor [dB]	Level [dBµV/m]	Limit [dBµV/m]	Margin [dB]	Detector	Polarity
1	3174.17	48.66	-8.15	40.51	74.00	33.49	PK	Horizontal
2	4464.53	47.27	-6.41	40.86	74.00	33.14	PK	Horizontal
3	6435.47	46.86	-2.42	44.44	74.00	29.56	PK	Horizontal
4	9764.24	47.57	2.28	49.85	74.00	24.15	PK	Horizontal
5	12008.97	44.22	4.99	49.21	74.00	24.79	PK	Horizontal
6	17852.27	41.15	7.73	48.88	74.00	25.12	PK	Horizontal

**Note:**

1. Level = Reading + Factor.
2. If Peak Result complies with AV limit, AV Result is deemed to comply with AV limit.
3. Test setup: RBW: 1 MHz, VBW: 3 MHz, Sweep time: auto.

# TR-4-E-009 Radiated Emission Test Result

**Test Date:** 2022-11-02      **Tested By:** James Gan  
**EUT:** COMPLETE CONTENT CREATION STUDIO      **Model Number:** DLZ CREATOR  
**Test Mode:** TX Mode      **Power Supply:** AC 120V/60HZ  
**Condition:** Temp:24.2°C;Humi:50.8%;Press:100.3kPa      **Test Site:** DDT 3# Chamber  
**File Path:** d:\ts\2022 report data\Q22021607-2E DLZ CREATOR\FCC ABOVE 1G\12  
**Memo:** 3DH5 2441 Power:4

## Test Graph

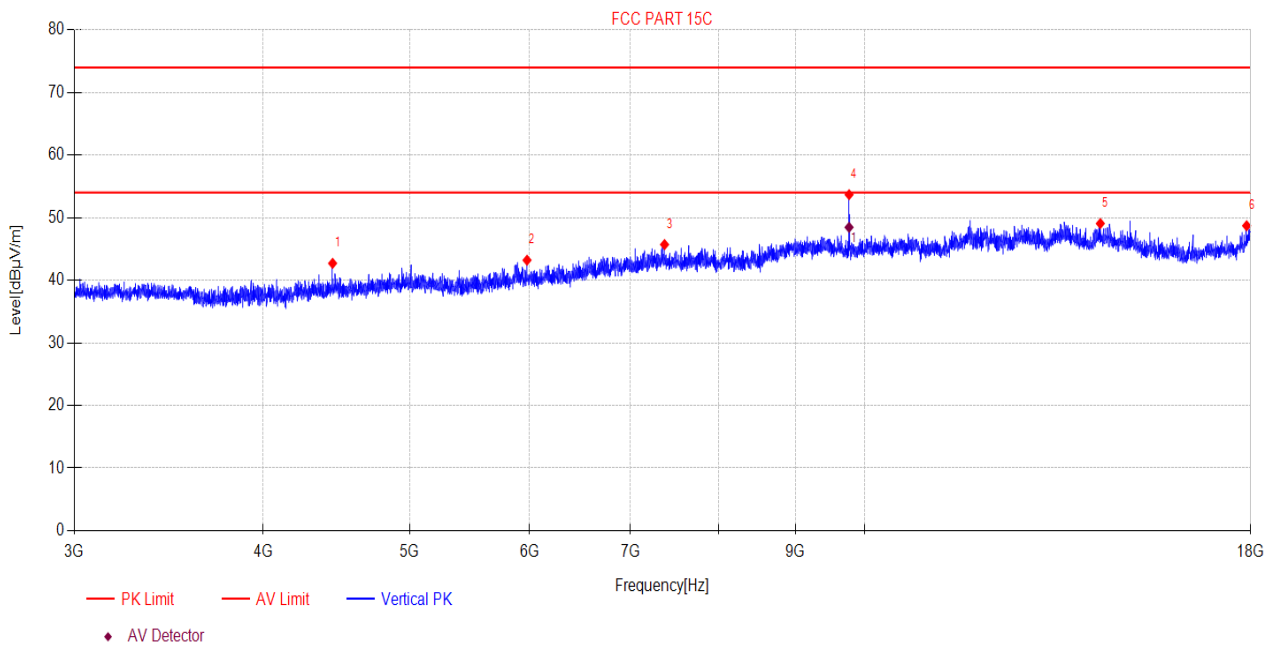

Suspected Data List								
NO.	Freq. [MHz]	Reading [dBµV]	Factor [dB]	Level [dBµV/m]	Limit [dBµV/m]	Margin [dB]	Detector	Polarity
1	4446.17	49.16	-6.45	42.71	74.00	31.29	PK	Vertical
2	5978.63	46.34	-3.13	43.21	74.00	30.79	PK	Vertical
3	7371.54	46.39	-0.68	45.71	74.00	28.29	PK	Vertical
4	9764.24	51.40	2.28	53.68	74.00	20.32	PK	Vertical
5	14316.43	42.86	6.21	49.07	74.00	24.93	PK	Vertical
6	17890.69	40.70	8.01	48.71	74.00	25.29	PK	Vertical

Final Data List								
NO.	Freq. [MHz]	Reading [dBµV]	Factor [dB]	Level [dBµV/m]	Limit [dBµV/m]	Margin [dB]	Detector	Polarity
1	9764.24	46.18	2.28	48.46	54.00	5.54	AV	Vertical

Note:

1. Level = Reading + Factor.
2. If Peak Result complies with AV limit, AV Result is deemed to comply with AV limit.
3. Test setup: RBW: 1 MHz, VBW: 3 MHz, Sweep time: auto.

# TR-4-E-009 Radiated Emission Test Result

**Test Date:** 2022-11-02      **Tested By:** James Gan  
**EUT:** COMPLETE CONTENT CREATION STUDIO      **Model Number:** DLZ CREATOR  
**Test Mode:** TX Mode      **Power Supply:** AC 120V/60HZ  
**Condition:** Temp:24.2°C;Humi:50.8%;Press:100.3kPa      **Test Site:** DDT 3# Chamber  
**File Path:** d:\ts\2022 report data\Q22021607-2E DLZ CREATOR\FCC ABOVE 1G\5  
**Memo:** 3DH5 2480 Power:4

## Test Graph

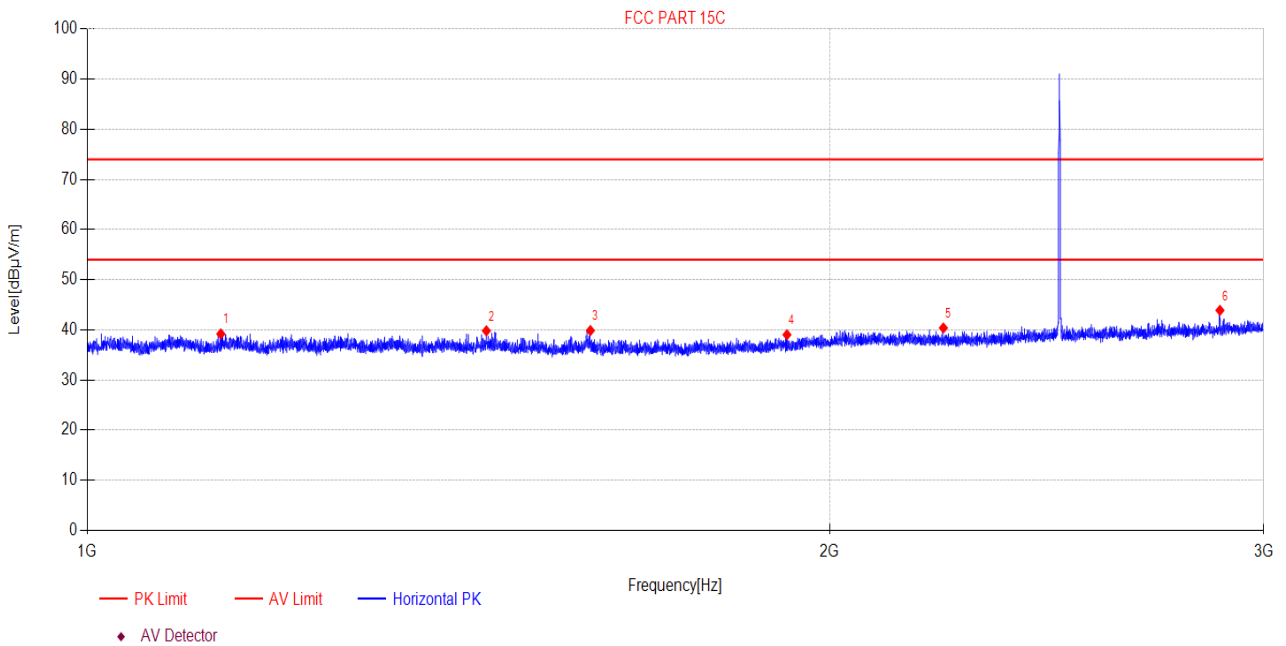

Suspected Data List								
NO.	Freq. [MHz]	Reading [dBµV]	Factor [dB]	Level [dBµV/m]	Limit [dBµV/m]	Margin [dB]	Detector	Polarity
1	1132.79	50.11	-10.91	39.20	74.00	34.80	PK	Horizontal
2	1451.68	50.97	-11.16	39.81	74.00	34.19	PK	Horizontal
3	1599.72	51.36	-11.49	39.87	74.00	34.13	PK	Horizontal
4	1922.04	50.17	-11.15	39.02	74.00	34.98	PK	Horizontal
5	2224.41	50.35	-9.97	40.38	74.00	33.62	PK	Horizontal
6	2879.88	52.19	-8.30	43.89	74.00	30.11	PK	Horizontal

**Note:**

1. Level = Reading + Factor.
2. If Peak Result complies with AV limit, AV Result is deemed to comply with AV limit.
3. Test setup: RBW: 1 MHz, VBW: 3 MHz, Sweep time: auto.

# TR-4-E-009 Radiated Emission Test Result

**Test Date:** 2022-11-02 **Tested By:** James Gan  
**EUT:** COMPLETE CONTENT CREATION STUDIO **Model Number:** DLZ CREATOR  
**Test Mode:** TX Mode **Power Supply:** AC 120V/60HZ  
**Condition:** Temp:24.2°C;Humi:50.8%;Press:100.3kPa **Test Site:** DDT 3# Chamber  
**File Path:** d:\ts\2022 report data\Q22021607-2E DLZ CREATOR\FCC ABOVE 1G\6  
**Memo:** 3DH5 2480 Power:4

## Test Graph

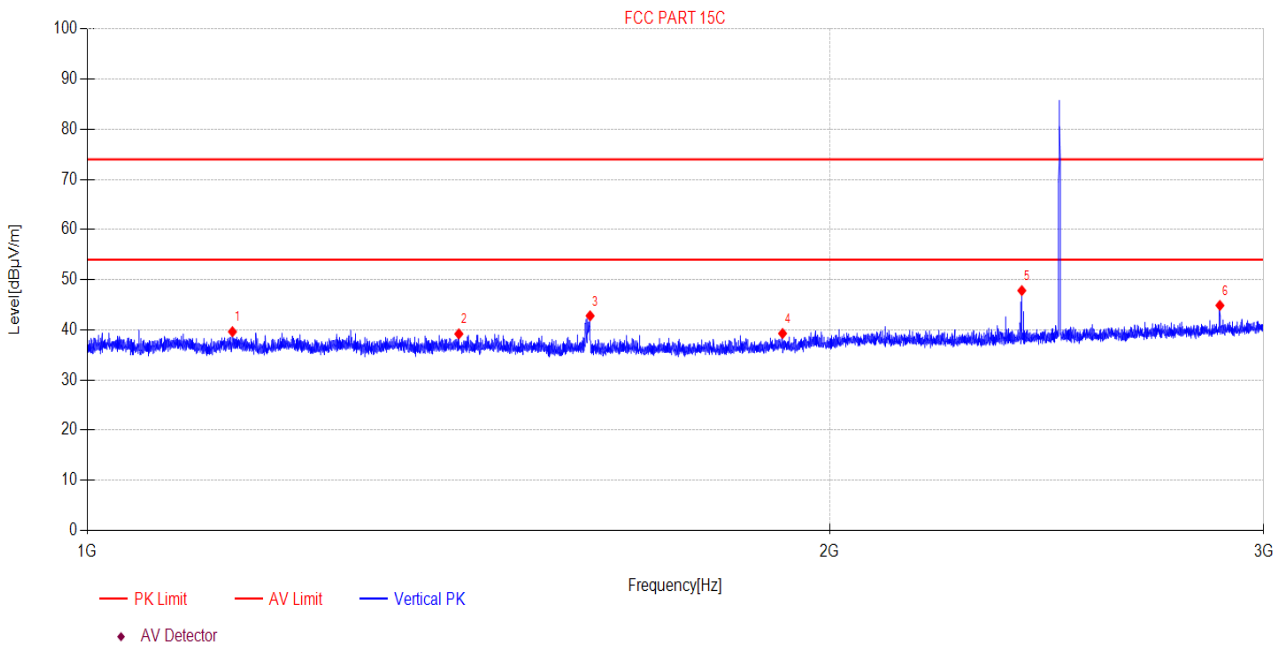

Suspected Data List								
NO.	Freq. [MHz]	Reading [dBµV]	Factor [dB]	Level [dBµV/m]	Limit [dBµV/m]	Margin [dB]	Detector	Polarity
1	1145.17	50.53	-10.90	39.63	74.00	34.37	PK	Vertical
2	1414.84	50.33	-11.13	39.20	74.00	34.80	PK	Vertical
3	1599.37	54.29	-11.49	42.80	74.00	31.20	PK	Vertical
4	1914.25	50.47	-11.19	39.28	74.00	34.72	PK	Vertical
5	2393.51	57.54	-9.71	47.83	74.00	26.17	PK	Vertical
6	2879.88	53.17	-8.30	44.87	74.00	29.13	PK	Vertical

**Note:**

1. Level = Reading + Factor.
2. If Peak Result complies with AV limit, AV Result is deemed to comply with AV limit.
3. Test setup: RBW: 1 MHz, VBW: 3 MHz, Sweep time: auto.

# TR-4-E-009 Radiated Emission Test Result

**Test Date:** 2022-11-02 **Tested By:** James Gan  
**EUT:** COMPLETE CONTENT CREATION STUDIO **Model Number:** DLZ CREATOR  
**Test Mode:** TX Mode **Power Supply:** AC 120V/60HZ  
**Condition:** Temp:24.2°C;Humi:50.8%;Press:100.3kPa **Test Site:** DDT 3# Chamber  
**File Path:** d:\ts\2022 report data\Q22021607-2E DLZ CREATOR\FCC ABOVE 1G\3  
**Memo:** 3DH5 2480 Power:4

## Test Graph

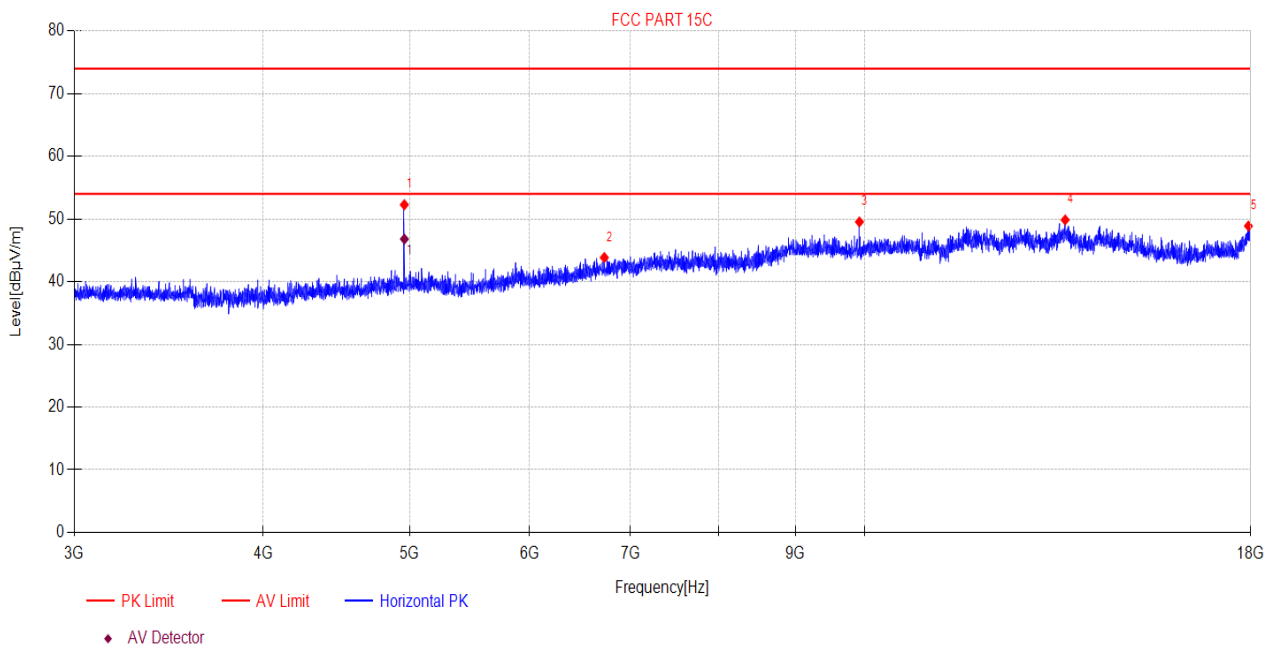

Suspected Data List								
NO.	Freq. [MHz]	Reading [dBµV]	Factor [dB]	Level [dBµV/m]	Limit [dBµV/m]	Margin [dB]	Detector	Polarity
1	4960.00	57.19	-4.91	52.28	74.00	21.72	PK	Horizontal
2	6725.45	45.35	-1.49	43.86	74.00	30.14	PK	Horizontal
3	9919.40	47.37	2.17	49.54	74.00	24.46	PK	Horizontal
4	13569.70	44.10	5.76	49.86	74.00	24.14	PK	Horizontal
5	17938.83	40.57	8.32	48.89	74.00	25.11	PK	Horizontal

Final Data List								
NO.	Freq. [MHz]	Reading [dBµV]	Factor [dB]	Level [dBµV/m]	Limit [dBµV/m]	Margin [dB]	Detector	Polarity
1	4960.00	51.71	-4.91	46.80	54.00	7.20	AV	Horizontal

Note:

- Level = Reading + Factor.
- If Peak Result complies with AV limit, AV Result is deemed to comply with AV limit.
- Test setup: RBW: 1 MHz, VBW: 3 MHz, Sweep time: auto.

# TR-4-E-009 Radiated Emission Test Result

**Test Date:** 2022-11-02      **Tested By:** James Gan  
**EUT:** COMPLETE CONTENT CREATION STUDIO      **Model Number:** DLZ CREATOR  
**Test Mode:** TX Mode      **Power Supply:** AC 120V/60HZ  
**Condition:** Temp:24.2°C;Humi:50.8%;Press:100.3kPa      **Test Site:** DDT 3# Chamber  
**File Path:** d:\ts\2022 report data\Q22021607-2E DLZ CREATOR\FCC ABOVE 1G\4  
**Memo:** 3DH5 2480 Power:4

## Test Graph

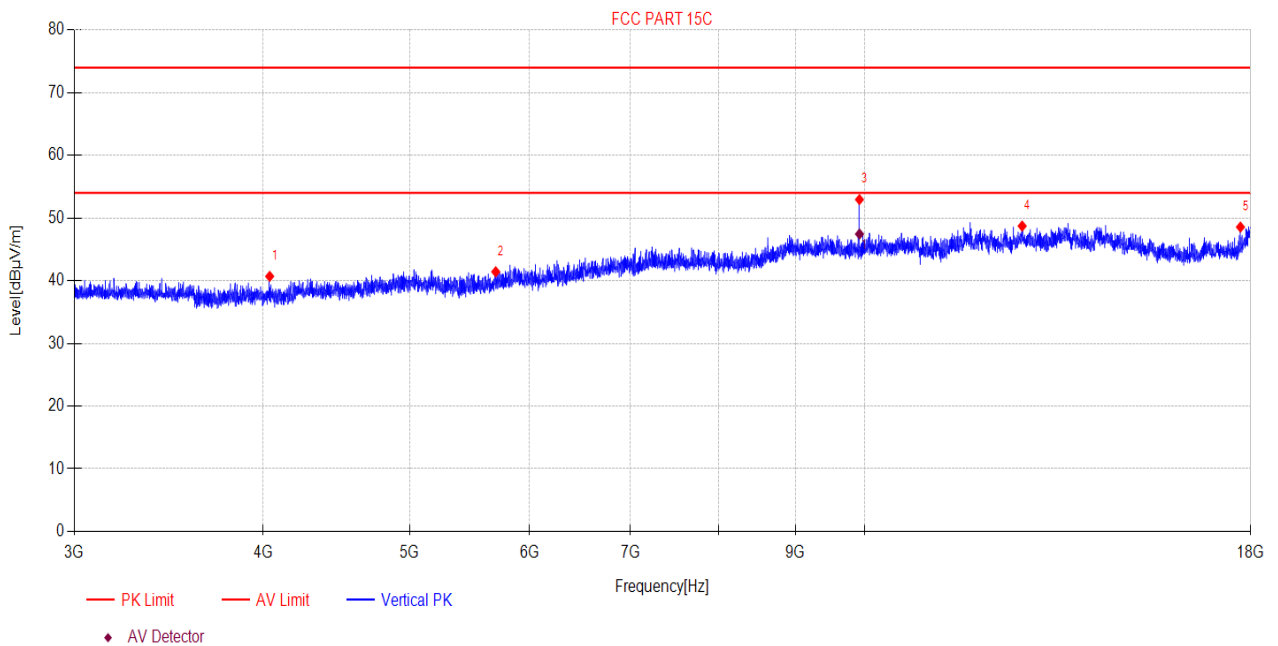

Suspected Data List								
NO.	Freq. [MHz]	Reading [dBµV]	Factor [dB]	Level [dBµV/m]	Limit [dBµV/m]	Margin [dB]	Detector	Polarity
1	4039.79	48.06	-7.36	40.70	74.00	33.30	PK	Vertical
2	5700.40	45.31	-3.88	41.43	74.00	32.57	PK	Vertical
3	9920.00	50.77	2.17	52.94	74.00	21.06	PK	Vertical
4	12708.46	43.73	4.99	48.72	74.00	25.28	PK	Vertical
5	17721.61	41.77	6.79	48.56	74.00	25.44	PK	Vertical

Final Data List								
NO.	Freq. [MHz]	Reading [dBµV]	Factor [dB]	Level [dBµV/m]	Limit [dBµV/m]	Margin [dB]	Detector	Polarity
1	9920.00	45.28	2.17	47.45	54.00	6.55	AV	Vertical

**Note:**

- Level = Reading + Factor.
- If Peak Result complies with AV limit, AV Result is deemed to comply with AV limit.
- Test setup: RBW: 1 MHz, VBW: 3 MHz, Sweep time: auto.



## 11. RF Conducted Spurious Emissions

### 11.1. Block diagram of test setup

Same as section 4.1

### 11.2. Limits

In any 100 kHz bandwidth outside the frequency bands in which the spread spectrum intentional radiator is operating, the radio frequency power that is produced by the intentional radiator shall be at least 20 dB below that in the 100 kHz bandwidth within the band that contains the highest level of the desired power.

### 11.3. Test procedure

(1) Connect EUT's antenna output to spectrum analyzer by RF cable.

(2) Establish a reference level by using the following procedure:

Center frequency	Test frequency
RBW:	100 kHz
VBW:	300 kHz
Span	Wide enough to capture the peak level of the in-band emission
Detector Mode:	Peak
Sweep time:	auto
Trace mode	Max hold

(3) Allow the trace to stabilize, use the peak marker function to determine the maximum peak power level to establish the reference level.

(4) Set the spectrum analyzer as follows:

RBW:	100 kHz
VBW:	300 kHz
Span	Encompass frequency range to be measured
Number of measurement points	$\geq \text{span}/\text{RBW}$
Detector Mode:	Peak
Sweep time:	auto
Trace mode	Max hold

(5) Allow the trace to stabilize, use the peak marker function to determine the maximum amplitude of all unwanted emissions outside of the authorized frequency band.

### 11.4. Test result

Mode	Frequency (MHz)	Verdict
GFSK	Hopping off 2402	Pass
	Hopping off 2441	Pass
	Hopping off 2480	Pass
$\pi/4$ -DQPSK	Hopping off 2402	Pass
	Hopping off 2441	Pass
	Hopping off 2480	Pass
8DPSK	Hopping off 2402	Pass
	Hopping off 2441	Pass
	Hopping off 2480	Pass

### 11.5. Original test data

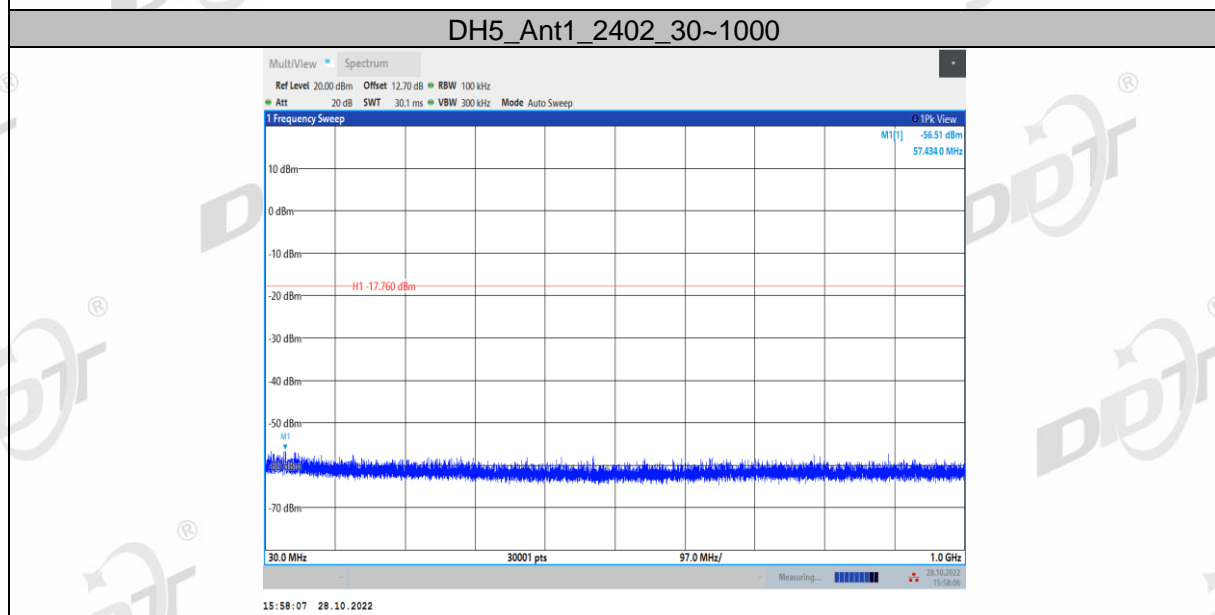
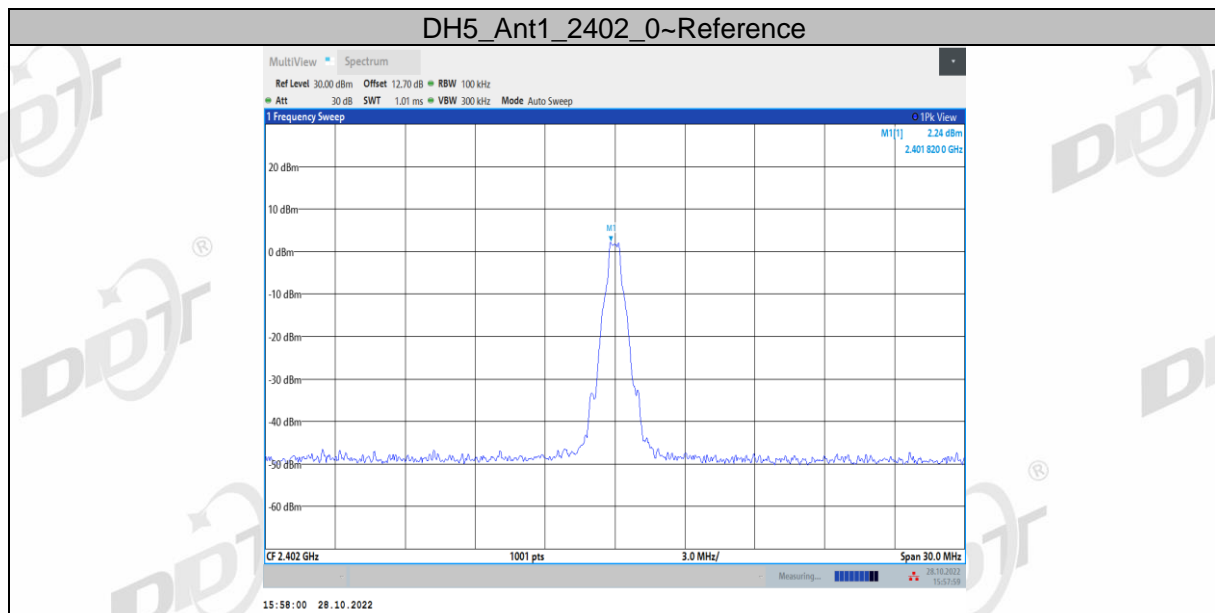

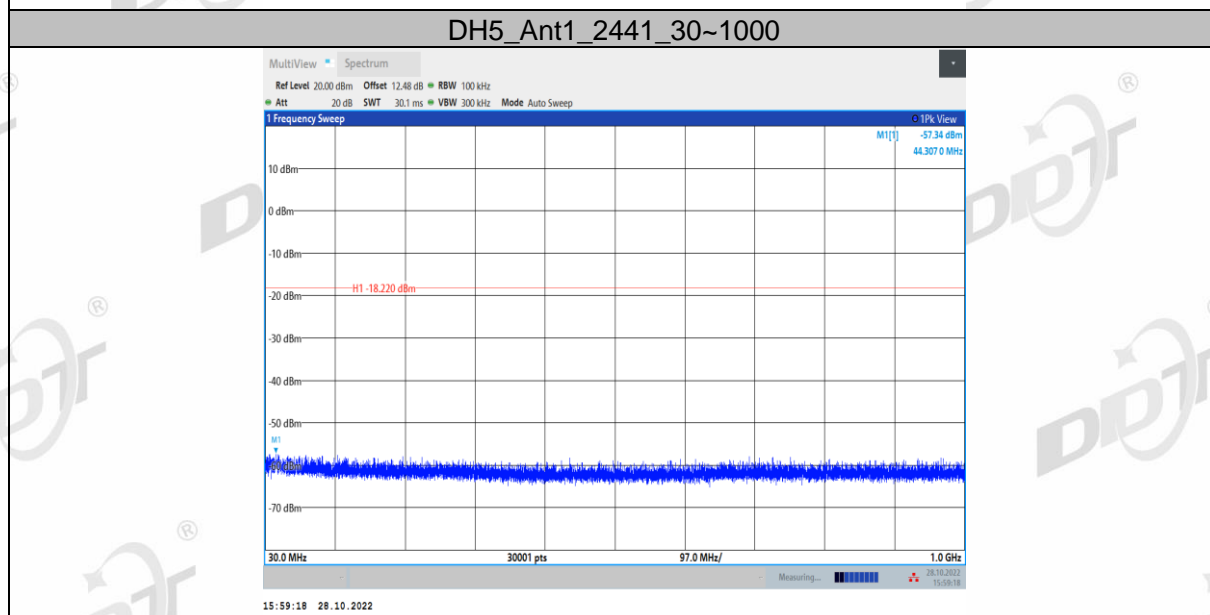
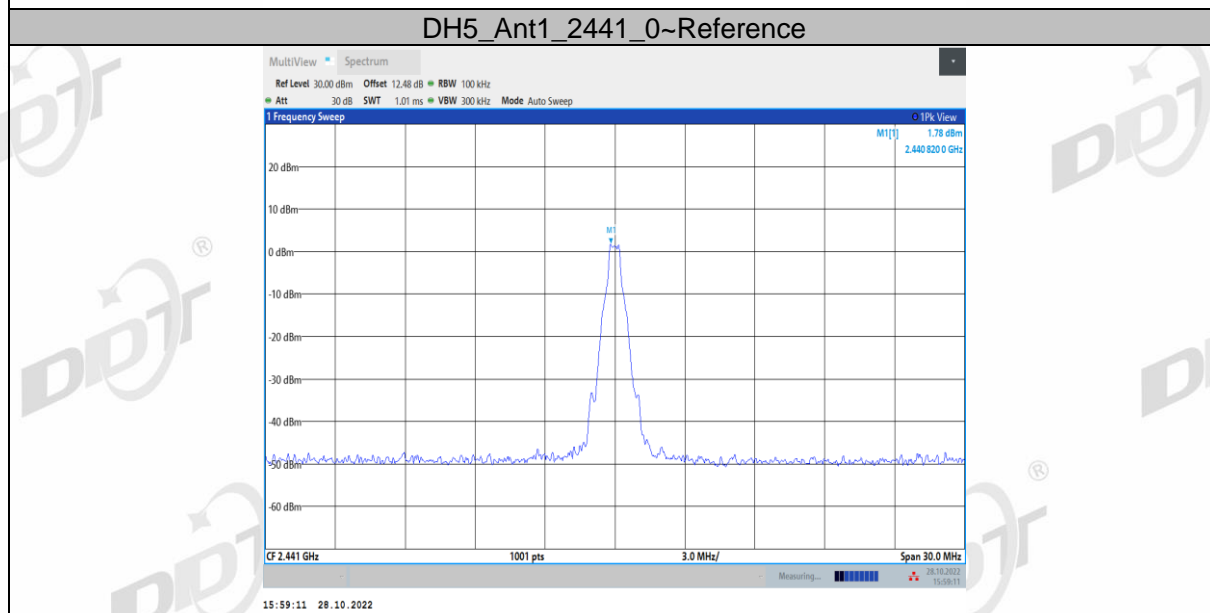
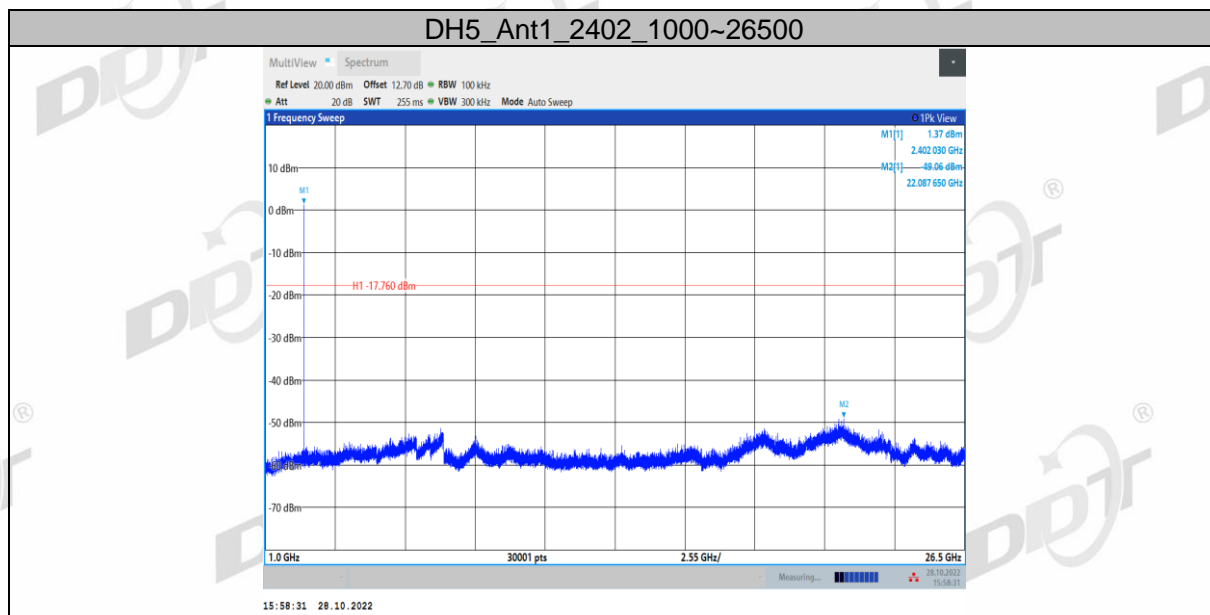

### DH5\_Ant1\_2441\_1000~26500

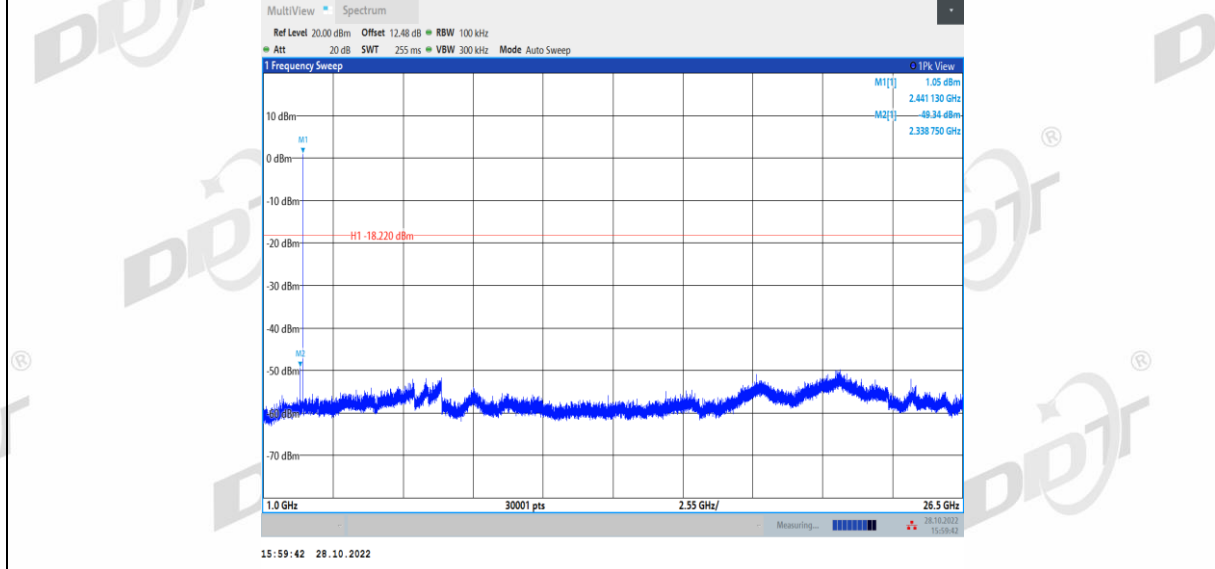

### DH5\_Ant1\_2480\_0~Reference

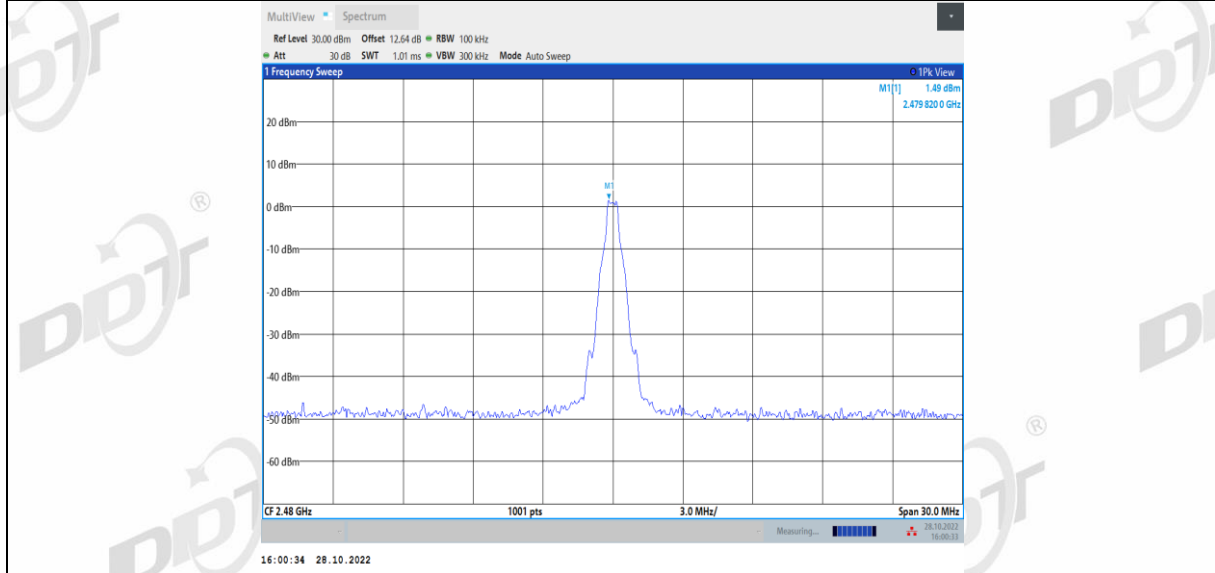

### DH5\_Ant1\_2480\_30~1000

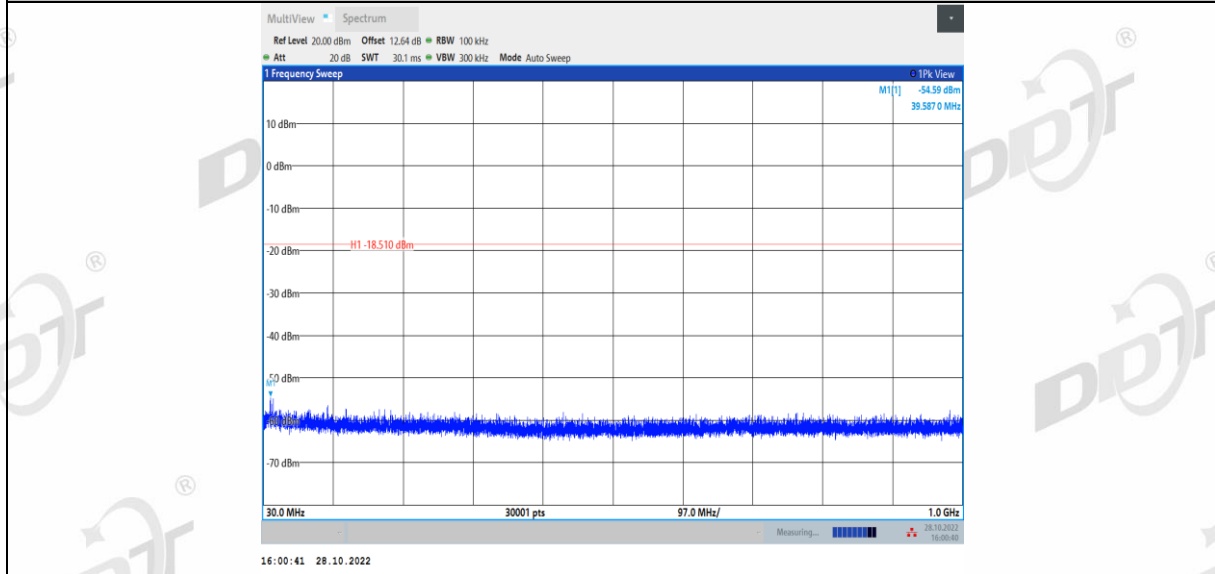

### DH5\_Ant1\_2480\_1000~26500

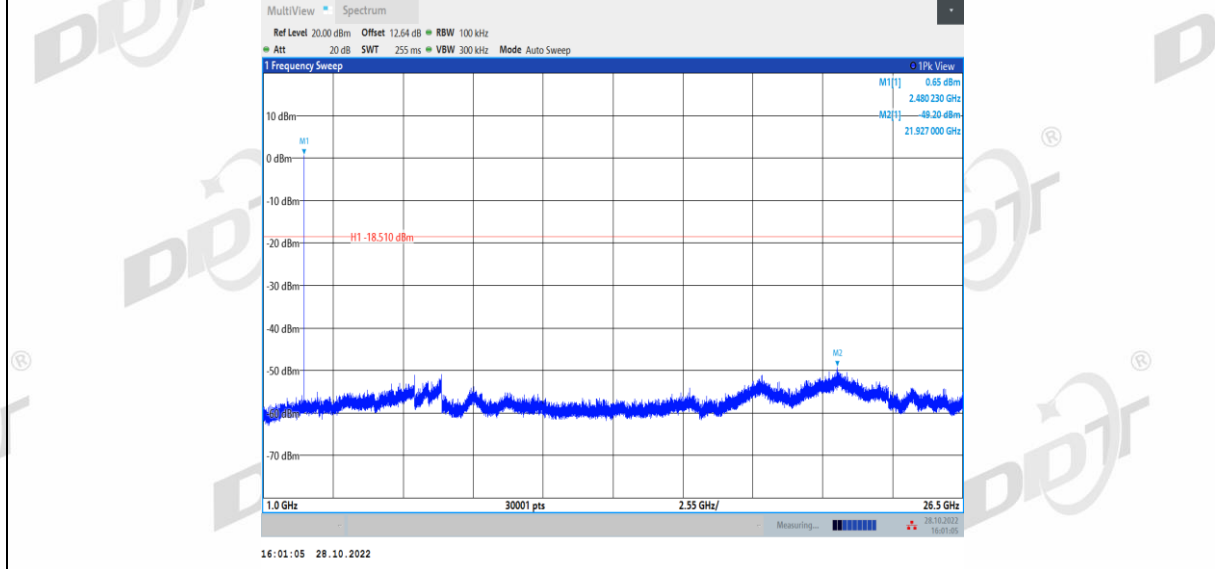

### 2DH5\_Ant1\_2402\_0~Reference

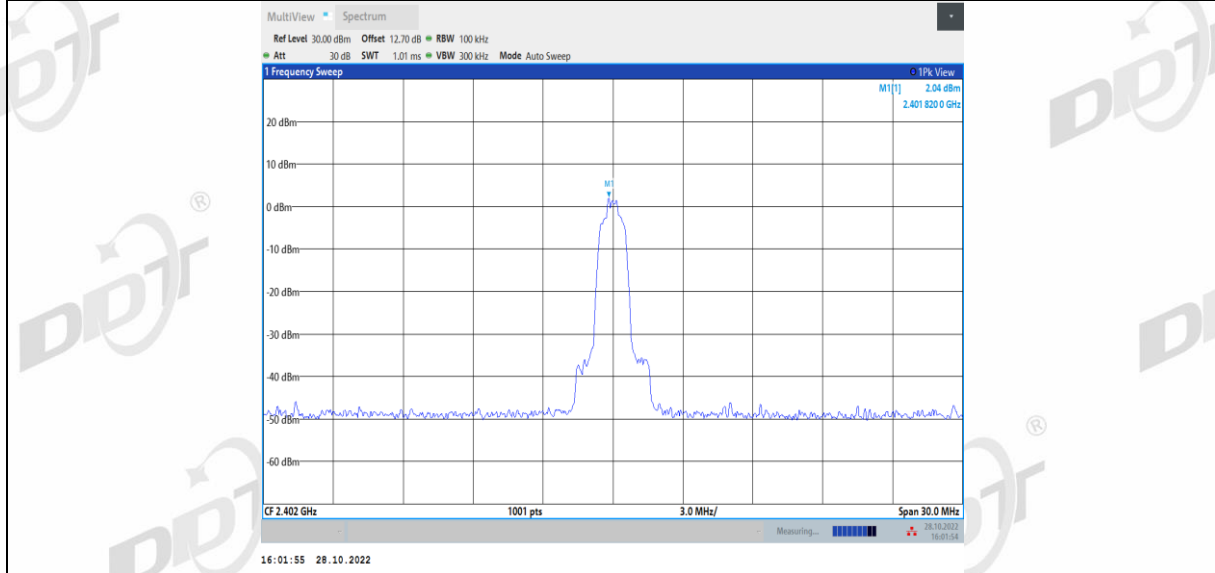

### 2DH5\_Ant1\_2402\_30~1000

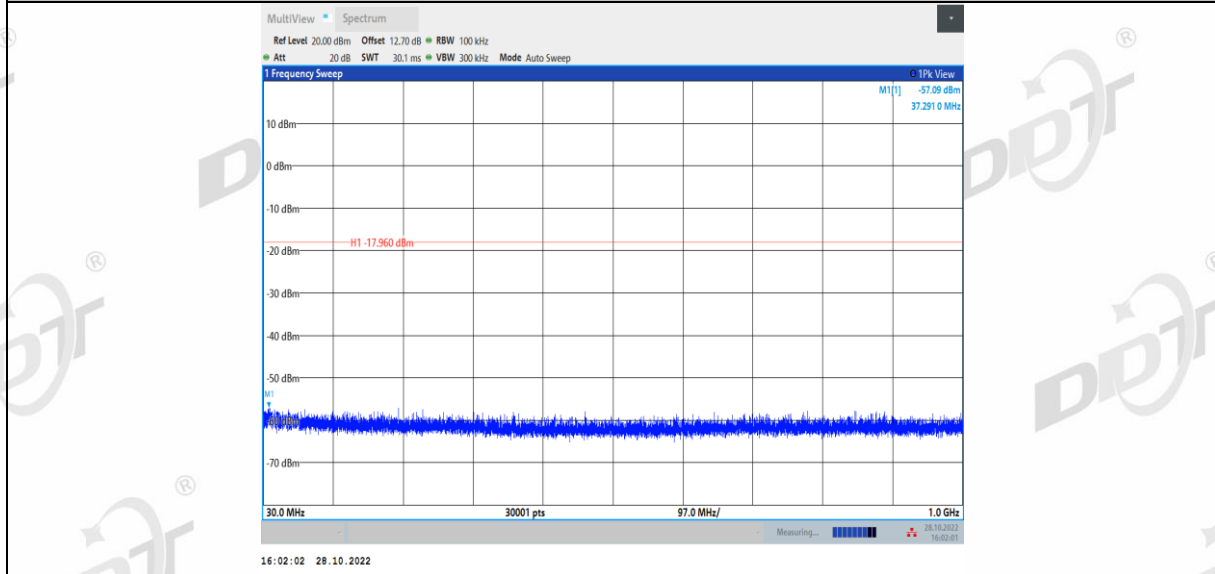

### 2DH5\_Ant1\_2402\_1000~26500

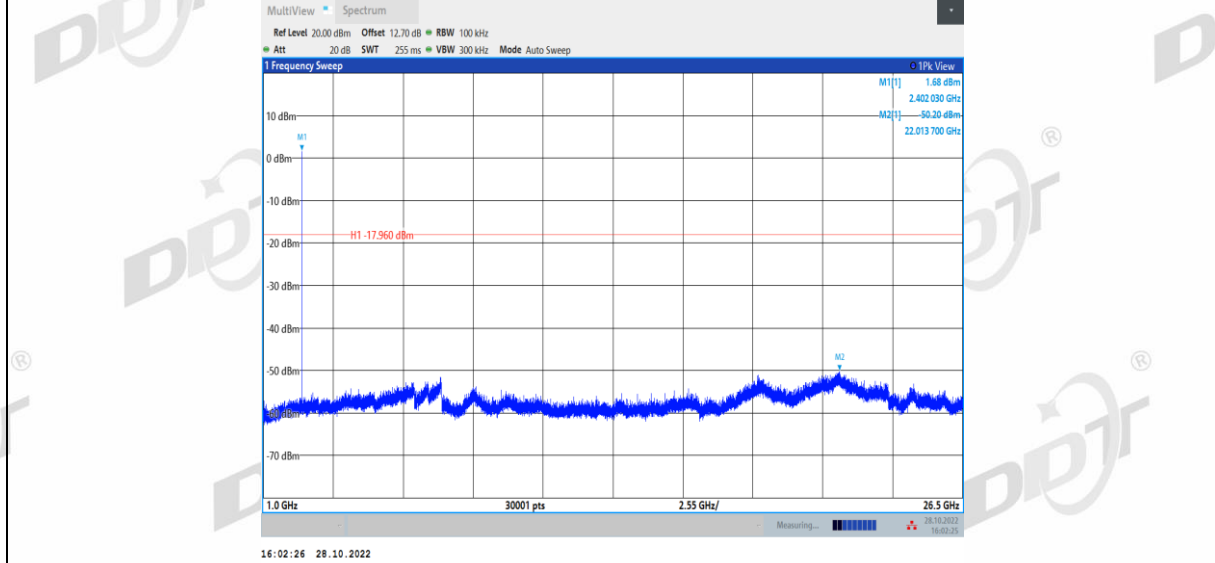

### 2DH5\_Ant1\_2441\_0~Reference

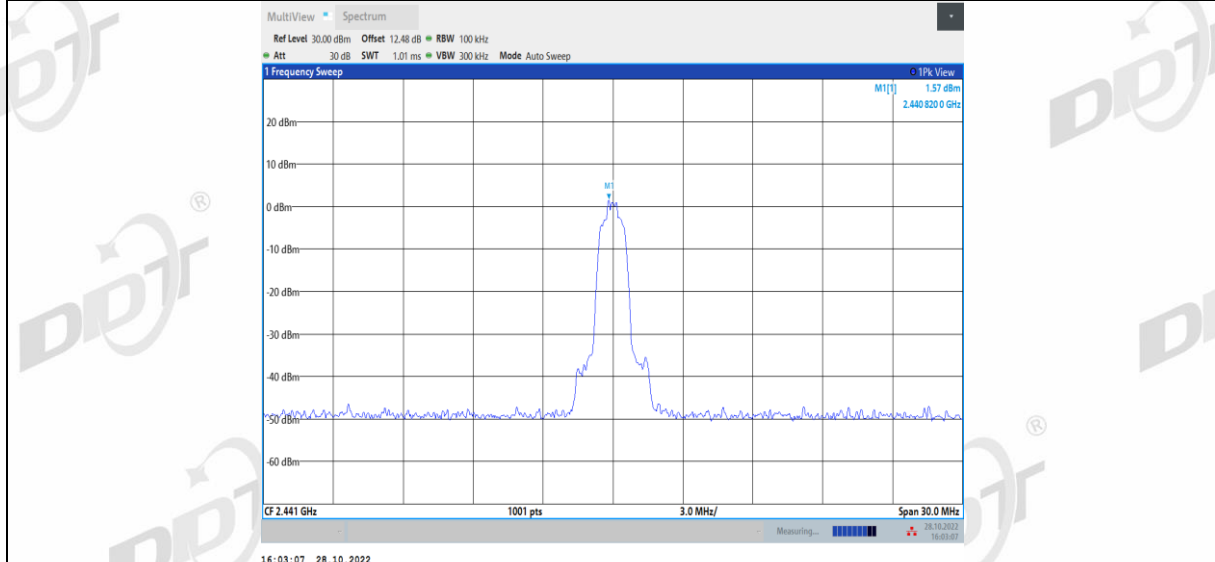

### 2DH5\_Ant1\_2441\_30~1000

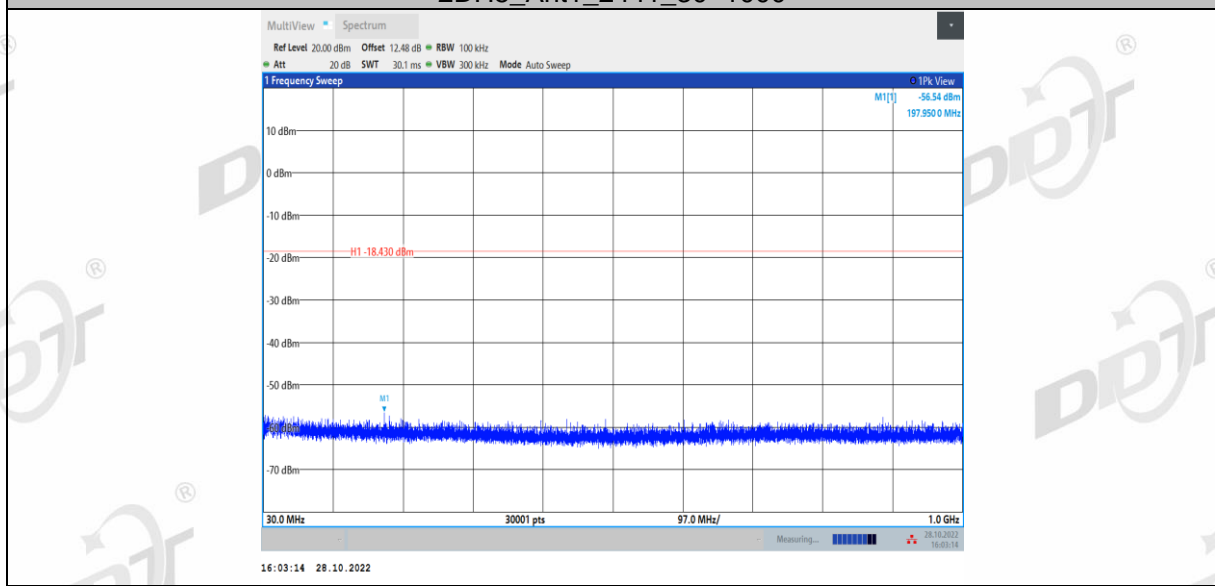

### 2DH5\_Ant1\_2441\_1000~26500

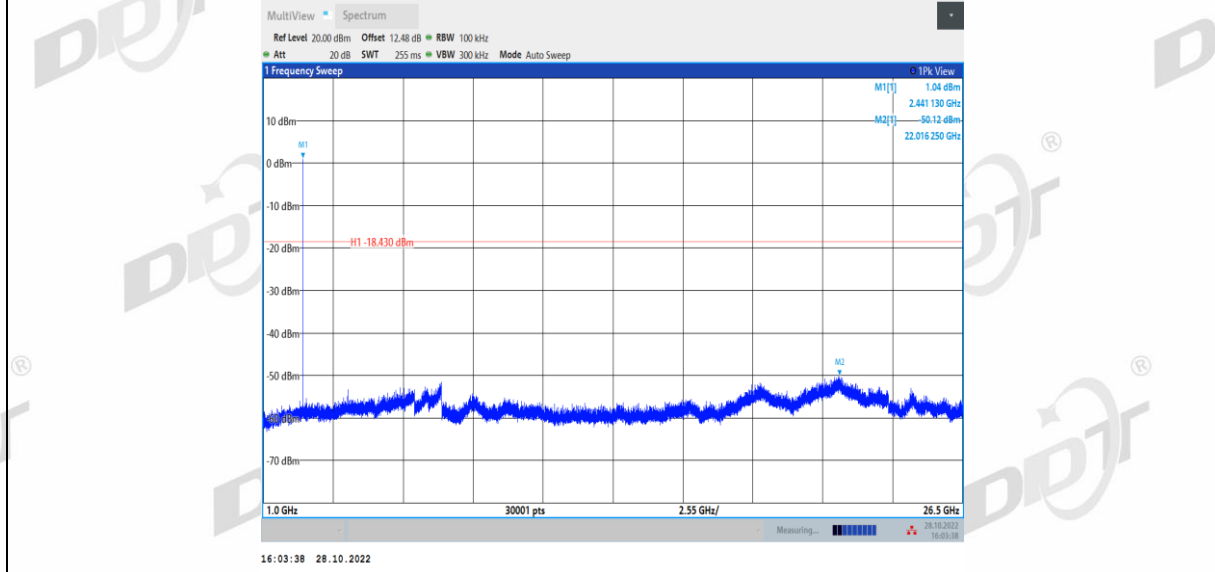

### 2DH5\_Ant1\_2480\_0~Reference

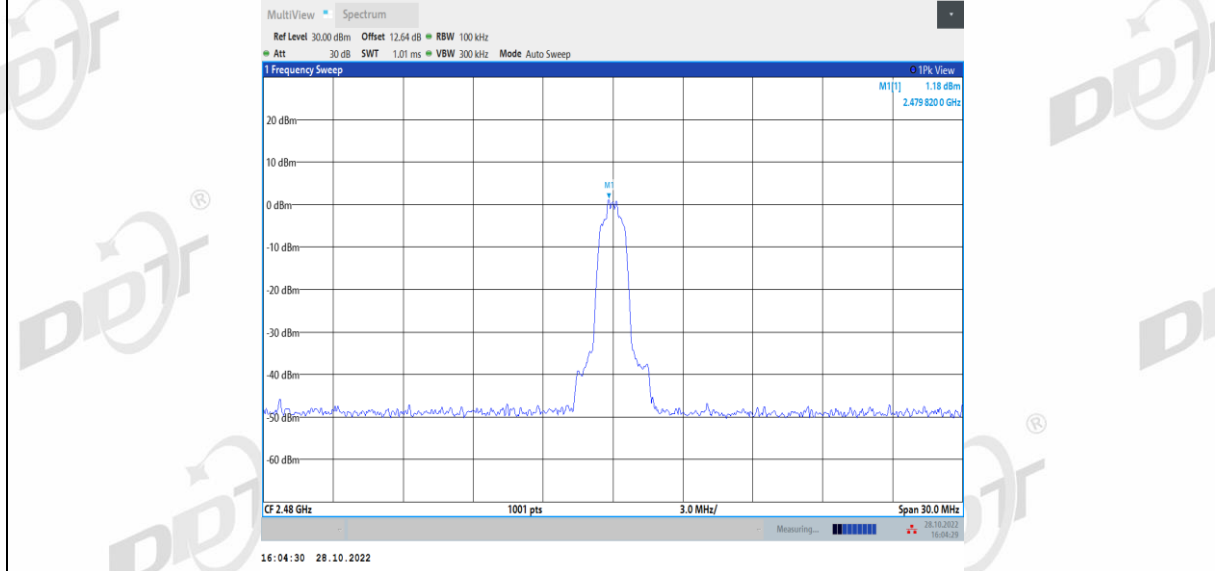

### 2DH5\_Ant1\_2480\_30~1000

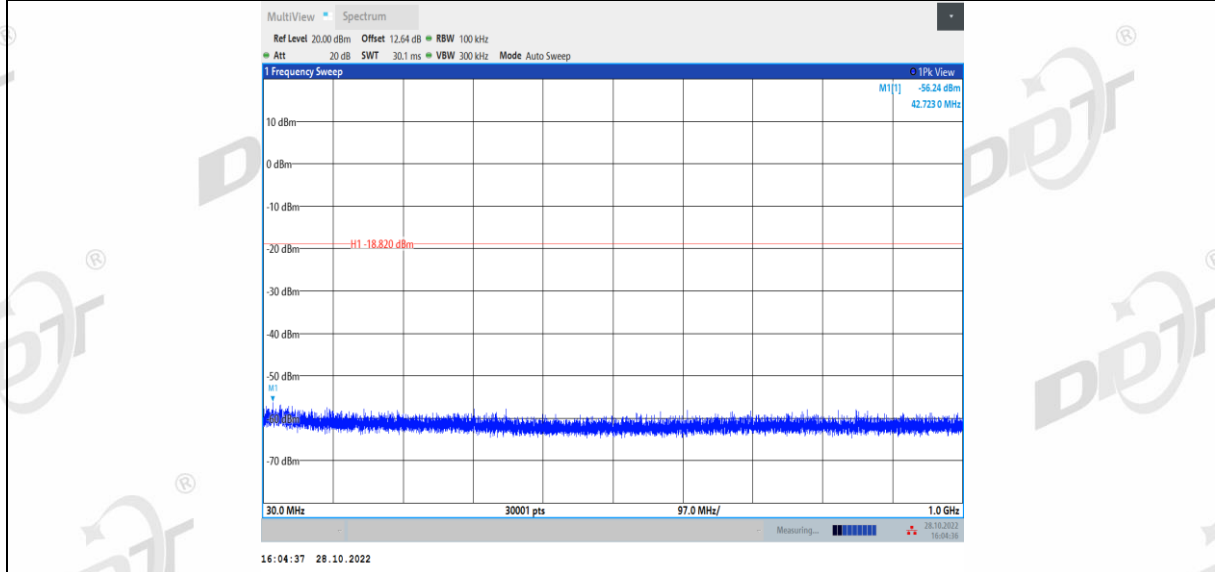

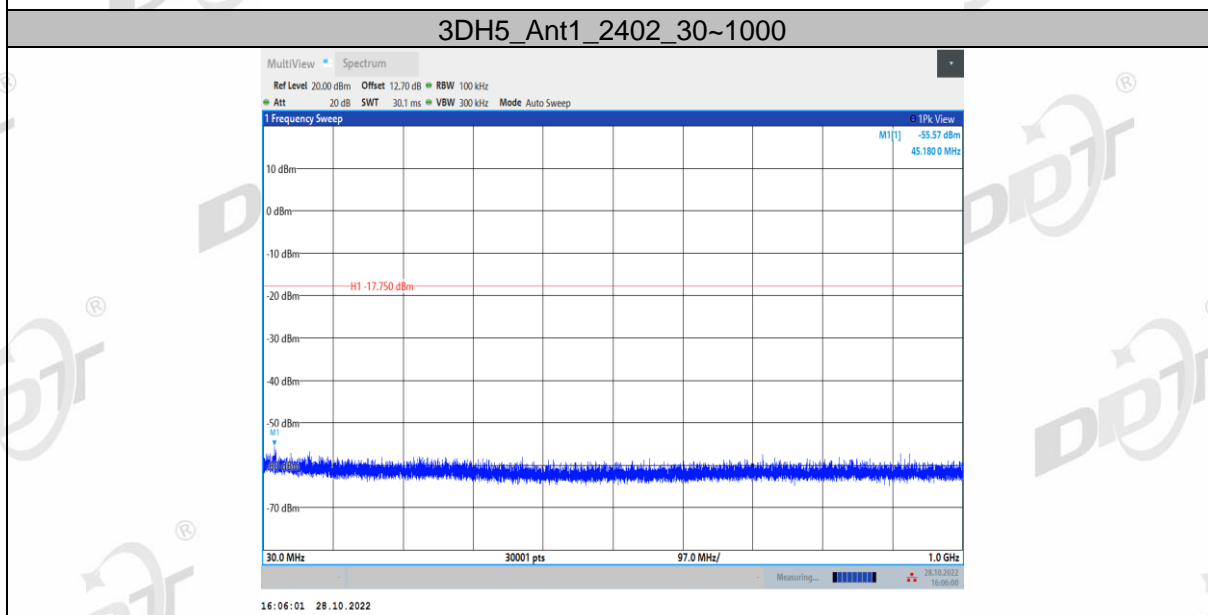
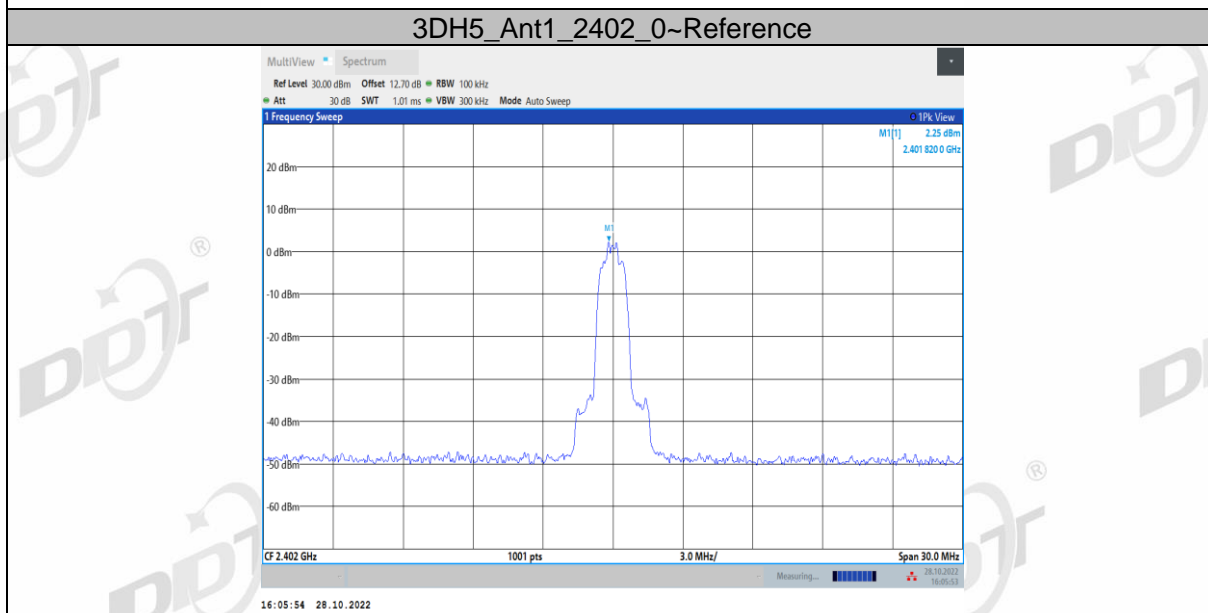
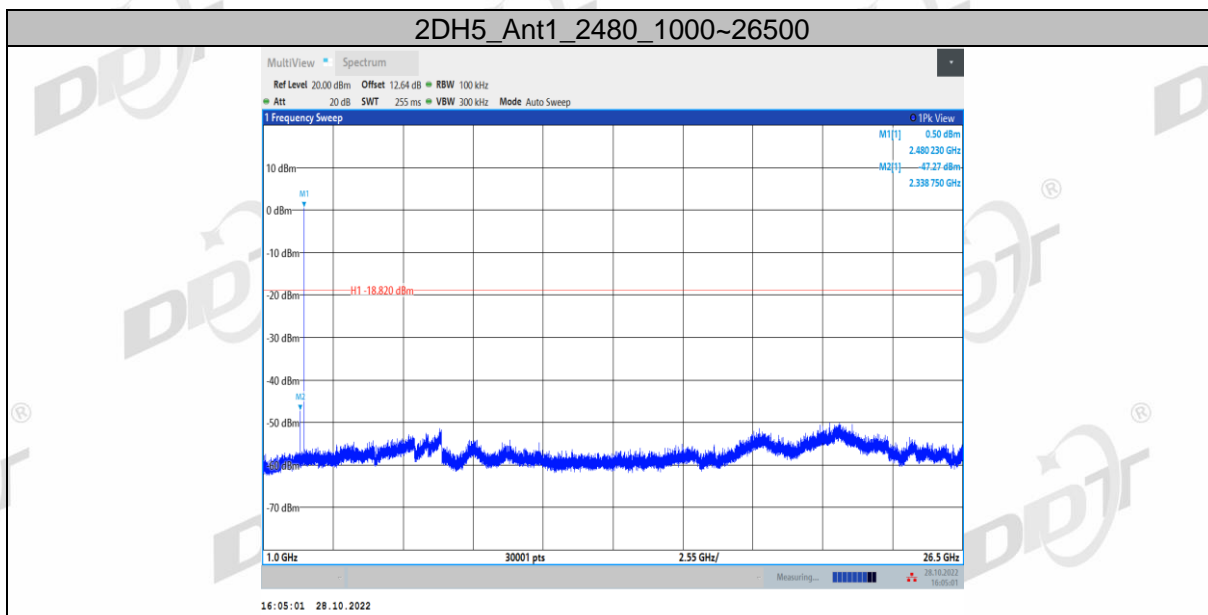



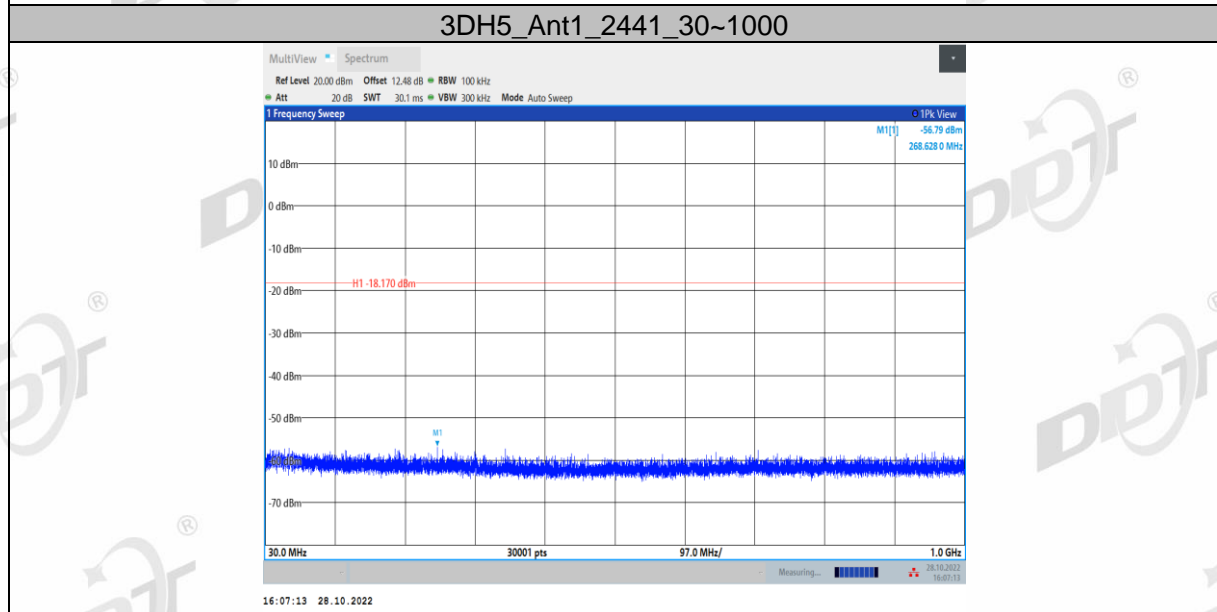
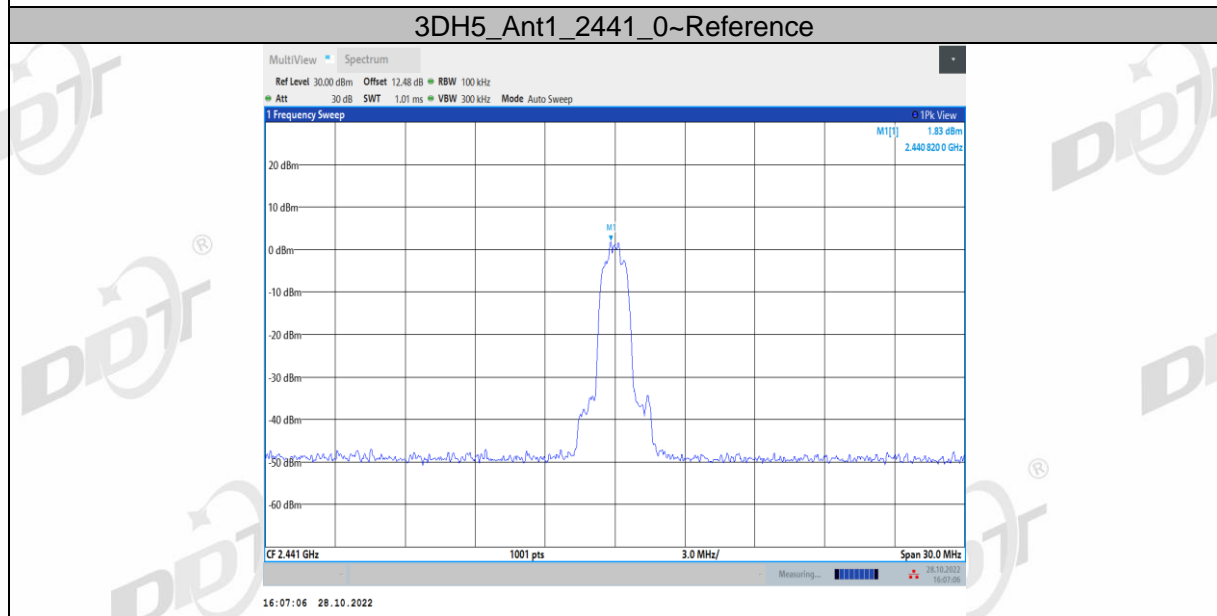
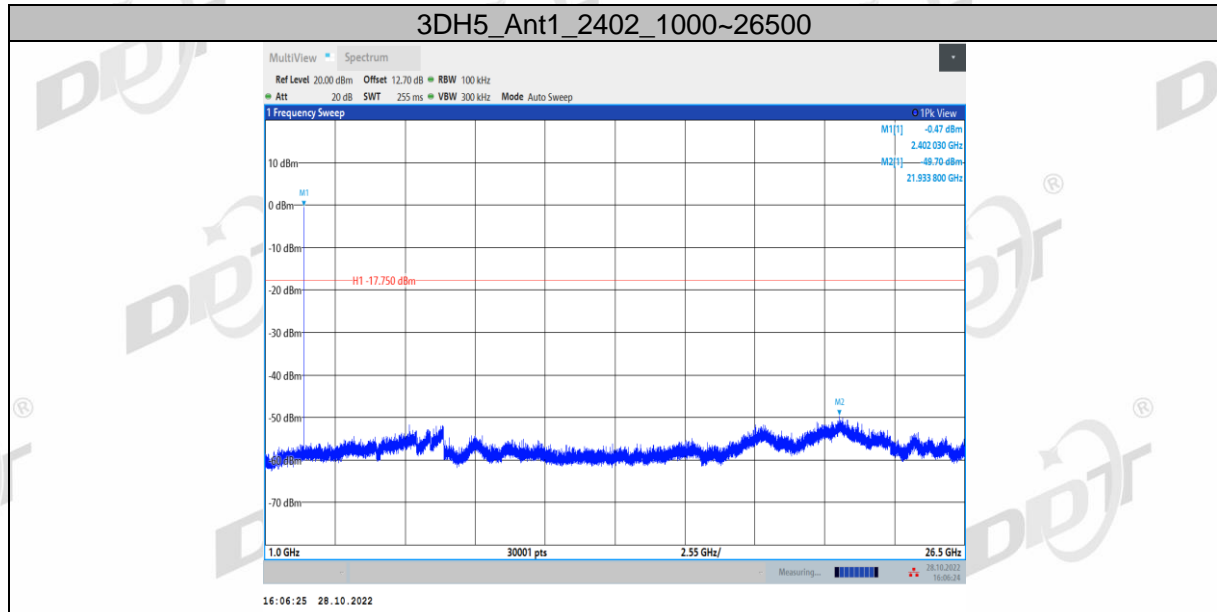

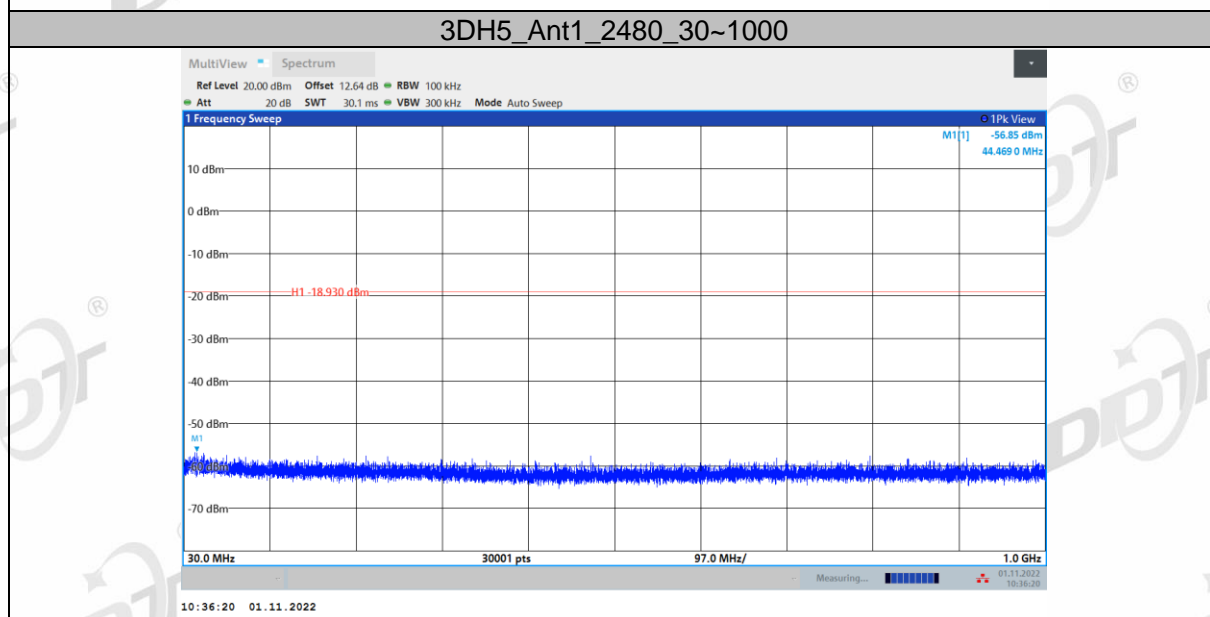
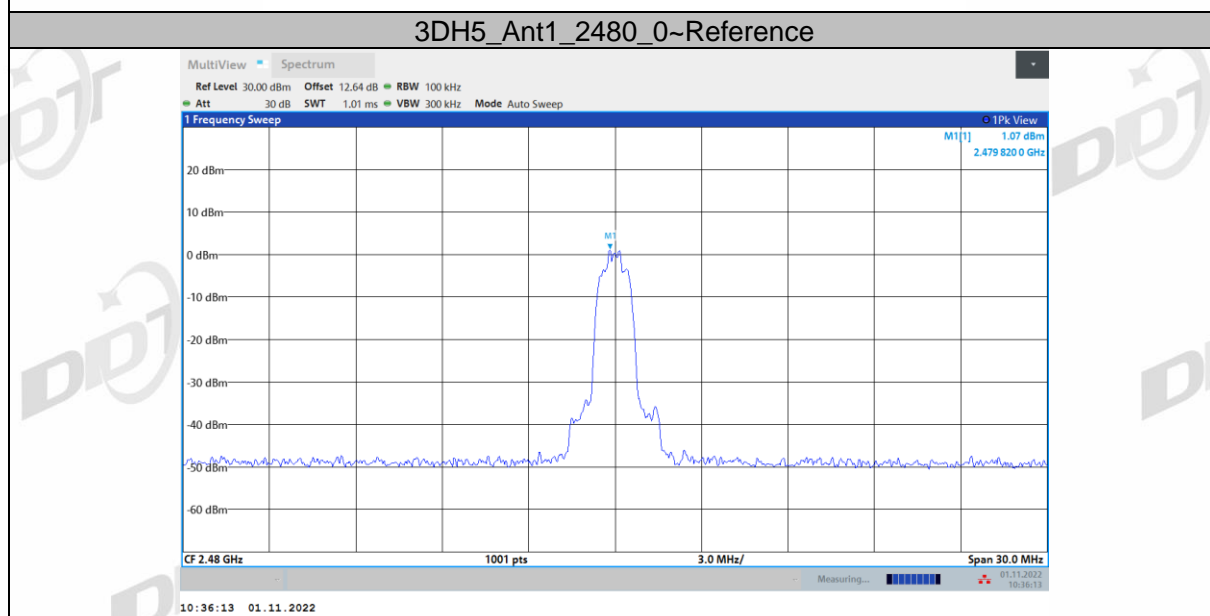
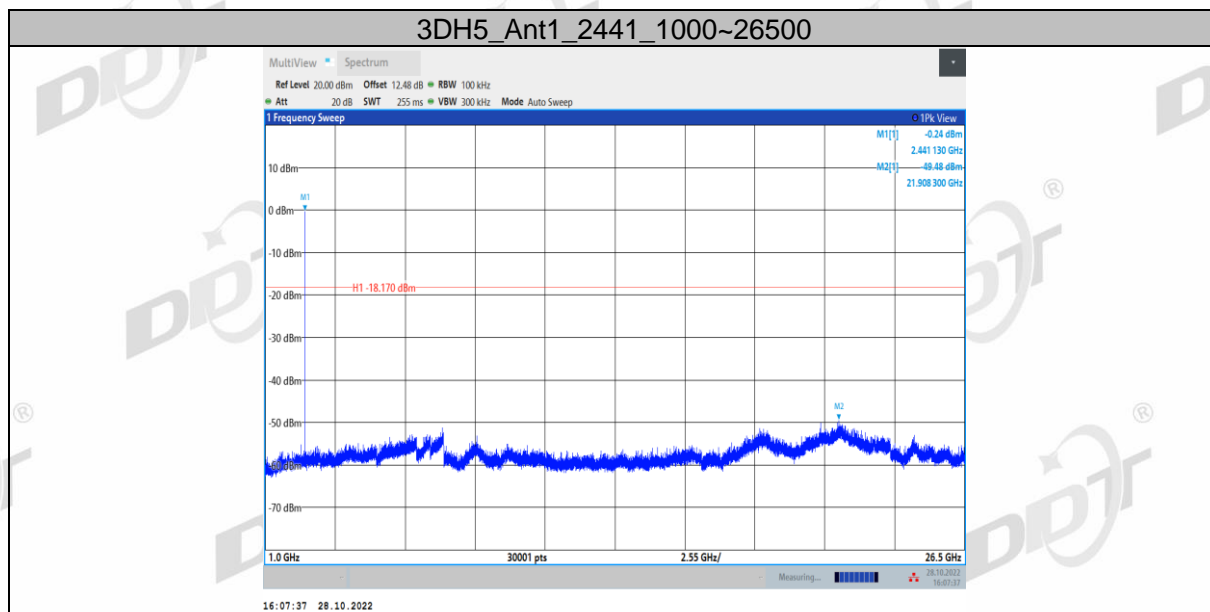

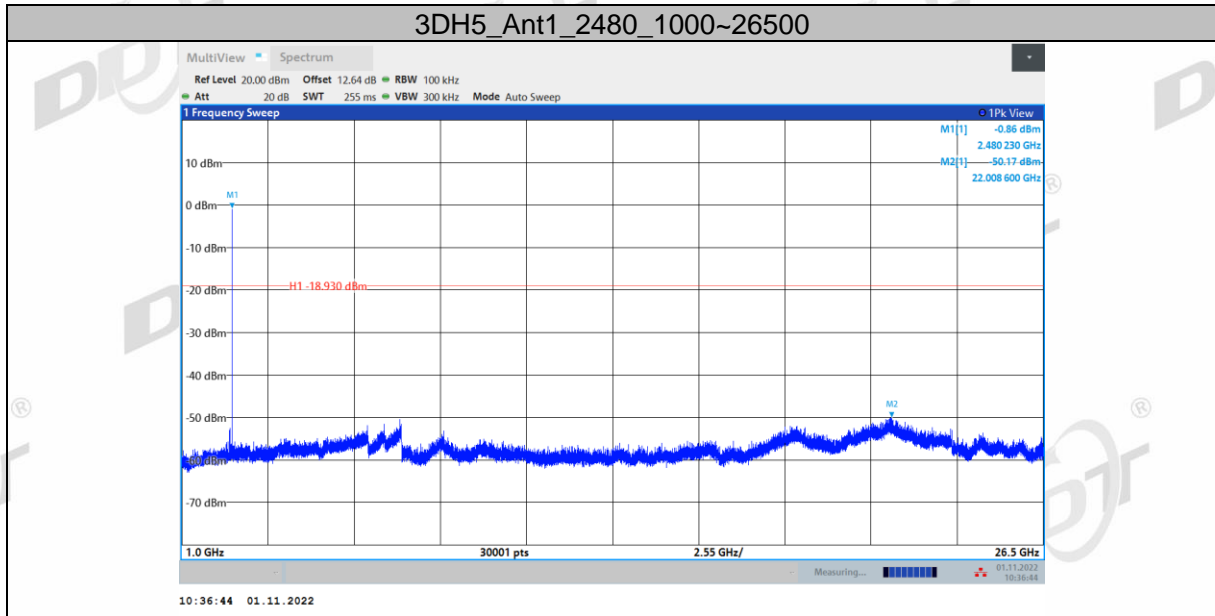

## 12. Band Edge Compliance (Radiated Method)

### 12.1. Block diagram of test setup

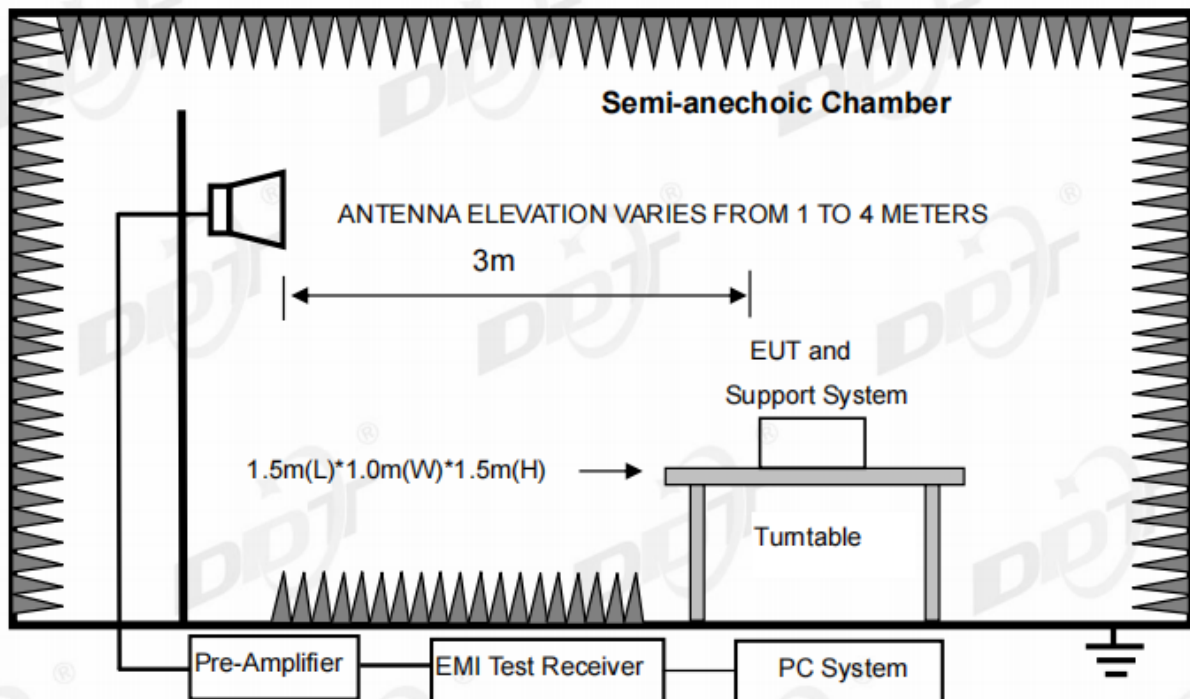

### 12.2. Limit

All restriction band should comply with 15.209, other emission should be at least 20dB below the fundamental.

### 12.3. Test procedure

Same with clause 10.3 except change investigated frequency range from 2310 MHz to 2410 MHz and 2475 MHz to 2500 MHz.

Remark: All restriction band have been tested, and only the worst case is shown in report.

### 12.4. Test result

Pass. (See below detailed test result)

Remark: hopping on and hopping off mode all have been test, hopping off mode is worse and reported only in this report.

# TR-4-E-009 Radiated Emission Test Result

**Test Date:** 2022-11-03 **Tested By:** James Gan  
**EUT:** COMPLETE CONTENT CREATION STUDIO **Model Number:** DLZ CREATOR  
**Test Mode:** TX Mode **Power Supply:** DC 18V  
**Condition:** Temp:24.2°C;Humi:50.8%;Press:100.3kPa **Test Site:** DDT 3# Chamber  
**File Path:** d:\ts\2022 report data\Q22021607-2E DLZ CREATOR\FCC ABOVE 1G\25  
**Memo:** DH5 2402 Power:4

## Test Graph

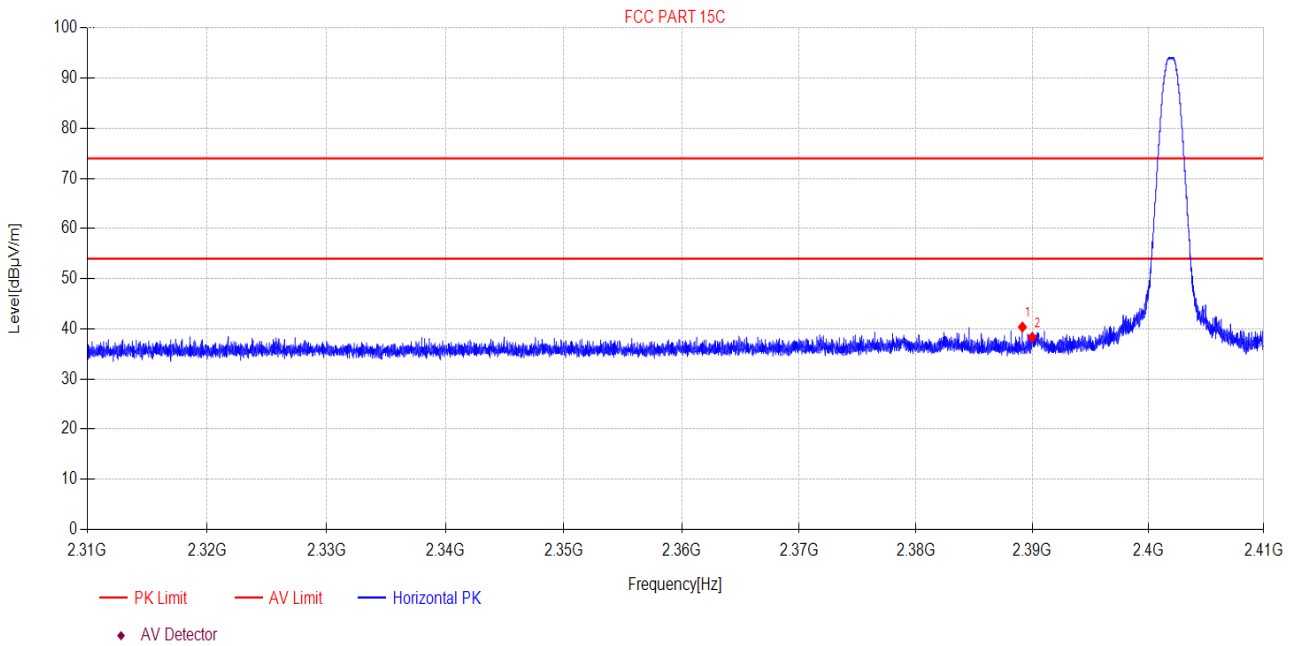

Suspected Data List								
NO.	Freq. [MHz]	Reading [dBµV]	Factor [dB]	Level [dBµV/m]	Limit [dBµV/m]	Margin [dB]	Detector	Polarity
1	2389.14	50.08	-9.72	40.36	74.00	33.64	PK	Horizontal
2	2390.00	48.02	-9.72	38.30	74.00	35.70	PK	Horizontal

**Note:**

1. Level = Reading + Factor.
2. If Peak Result complies with AV limit, AV Result is deemed to comply with AV limit.
3. Test setup: RBW: 1 MHz, VBW: 3 MHz, Sweep time: auto.

# TR-4-E-009 Radiated Emission Test Result

**Test Date:** 2022-11-03      **Tested By:** James Gan  
**EUT:** COMPLETE CONTENT CREATION STUDIO      **Model Number:** DLZ CREATOR  
**Test Mode:** TX Mode      **Power Supply:** DC 18V  
**Condition:** Temp:24.2°C;Humi:50.8%;Press:100.3kPa      **Test Site:** DDT 3# Chamber  
**File Path:** d:\ts\2022 report data\Q22021607-2E DLZ CREATOR\FCC ABOVE 1G\26  
**Memo:** DH5 2402 Power:4

## Test Graph

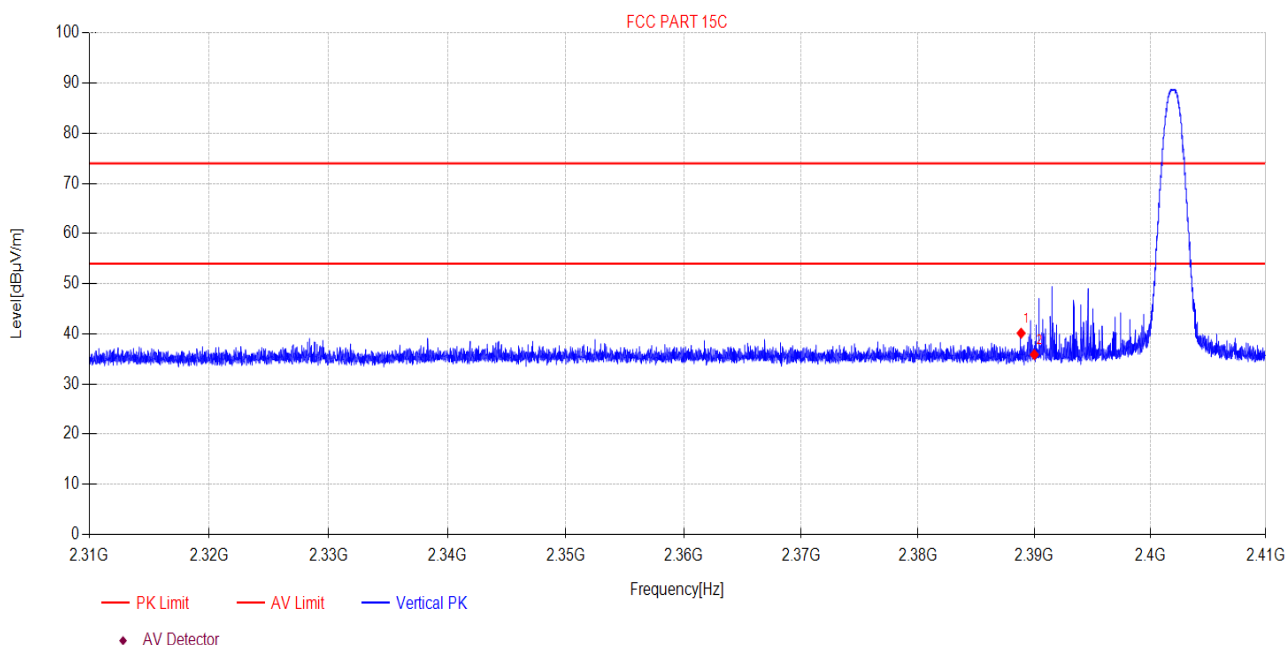

Suspected Data List								
NO.	Freq. [MHz]	Reading [dBµV]	Factor [dB]	Level [dBµV/m]	Limit [dBµV/m]	Margin [dB]	Detector	Polarity
1	2388.86	49.86	-9.72	40.14	74.00	33.86	PK	Vertical
2	2390.00	45.59	-9.72	35.87	74.00	38.13	PK	Vertical

**Note:**

1. Level = Reading + Factor.
2. If Peak Result complies with AV limit, AV Result is deemed to comply with AV limit.
3. Test setup: RBW: 1 MHz, VBW: 3 MHz, Sweep time: auto.

# TR-4-E-009 Radiated Emission Test Result

**Test Date:** 2022-11-03      **Tested By:** James Gan  
**EUT:** COMPLETE CONTENT CREATION STUDIO      **Model Number:** DLZ CREATOR  
**Test Mode:** TX Mode      **Power Supply:** DC 18V  
**Condition:** Temp:24.2°C;Humi:50.8%;Press:100.3kPa      **Test Site:** DDT 3# Chamber  
**File Path:** d:\ts\2022 report data\Q22021607-2E DLZ CREATOR\FCC ABOVE 1G\27  
**Memo:** 2DH5 2402 Power:4

## Test Graph

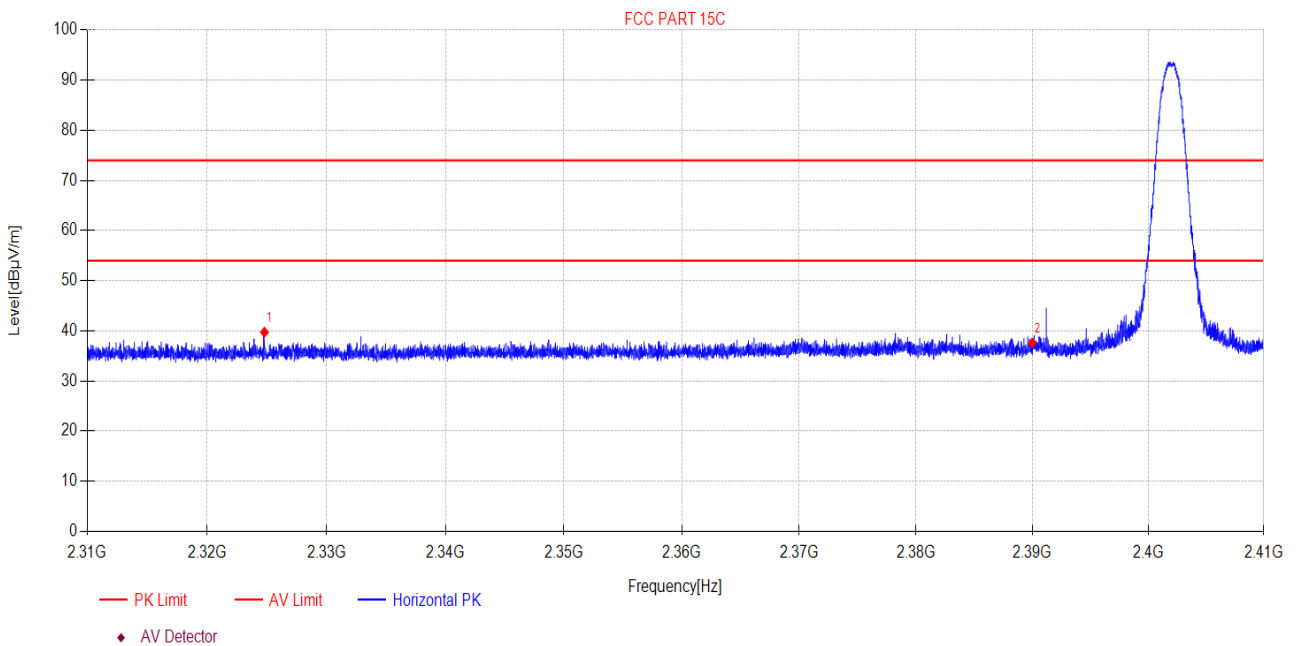

Suspected Data List								
NO.	Freq. [MHz]	Reading [dBµV]	Factor [dB]	Level [dBµV/m]	Limit [dBµV/m]	Margin [dB]	Detector	Polarity
1	2324.79	49.58	-9.85	39.73	74.00	34.27	PK	Horizontal
2	2390.00	47.29	-9.72	37.57	74.00	36.43	PK	Horizontal

**Note:**

1. Level = Reading + Factor.
2. If Peak Result complies with AV limit, AV Result is deemed to comply with AV limit.
3. Test setup: RBW: 1 MHz, VBW: 3 MHz, Sweep time: auto.

# TR-4-E-009 Radiated Emission Test Result

**Test Date:** 2022-11-03      **Tested By:** James Gan  
**EUT:** COMPLETE CONTENT CREATION STUDIO      **Model Number:** DLZ CREATOR  
**Test Mode:** TX Mode      **Power Supply:** DC 18V  
**Condition:** Temp:24.2°C;Humi:50.8%;Press:100.3kPa      **Test Site:** DDT 3# Chamber  
**File Path:** d:\ts\2022 report data\Q22021607-2E DLZ CREATOR\FCC ABOVE 1G\28  
**Memo:** 2DH5 2402 Power:4

## Test Graph

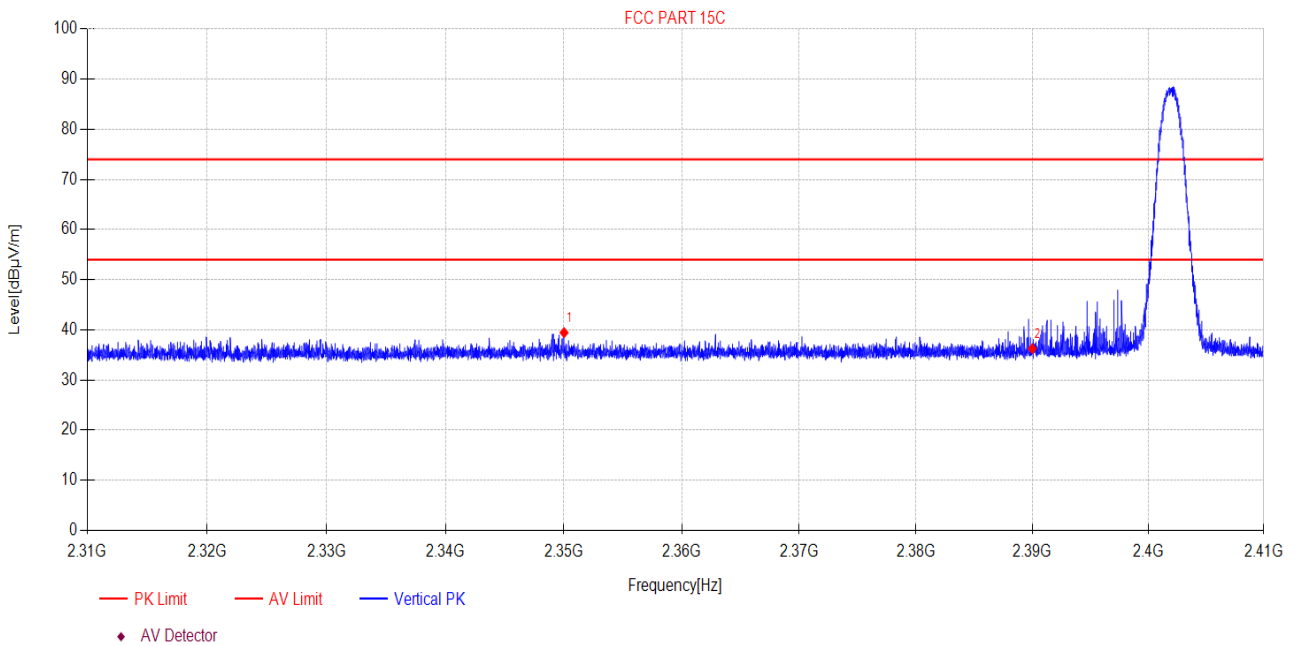

Suspected Data List								
NO.	Freq. [MHz]	Reading [dBµV]	Factor [dB]	Level [dBµV/m]	Limit [dBµV/m]	Margin [dB]	Detector	Polarity
1	2350.02	49.25	-9.80	39.45	74.00	34.55	PK	Vertical
2	2390.00	45.96	-9.72	36.24	74.00	37.76	PK	Vertical

**Note:**

1. Level = Reading + Factor.
2. If Peak Result complies with AV limit, AV Result is deemed to comply with AV limit.
3. Test setup: RBW: 1 MHz, VBW: 3 MHz, Sweep time: auto.



# TR-4-E-009 Radiated Emission Test Result

**Test Date:** 2022-11-03 **Tested By:** James Gan  
**EUT:** COMPLETE CONTENT CREATION STUDIO **Model Number:** DLZ CREATOR  
**Test Mode:** TX Mode **Power Supply:** DC 18V  
**Condition:** Temp:24.2°C;Humi:50.8%;Press:100.3kPa **Test Site:** DDT 3# Chamber  
**File Path:** d:\ts\2022 report data\Q22021607-2E DLZ CREATOR\FCC ABOVE 1G\29  
**Memo:** 3DH5 2402 Power:4

## Test Graph

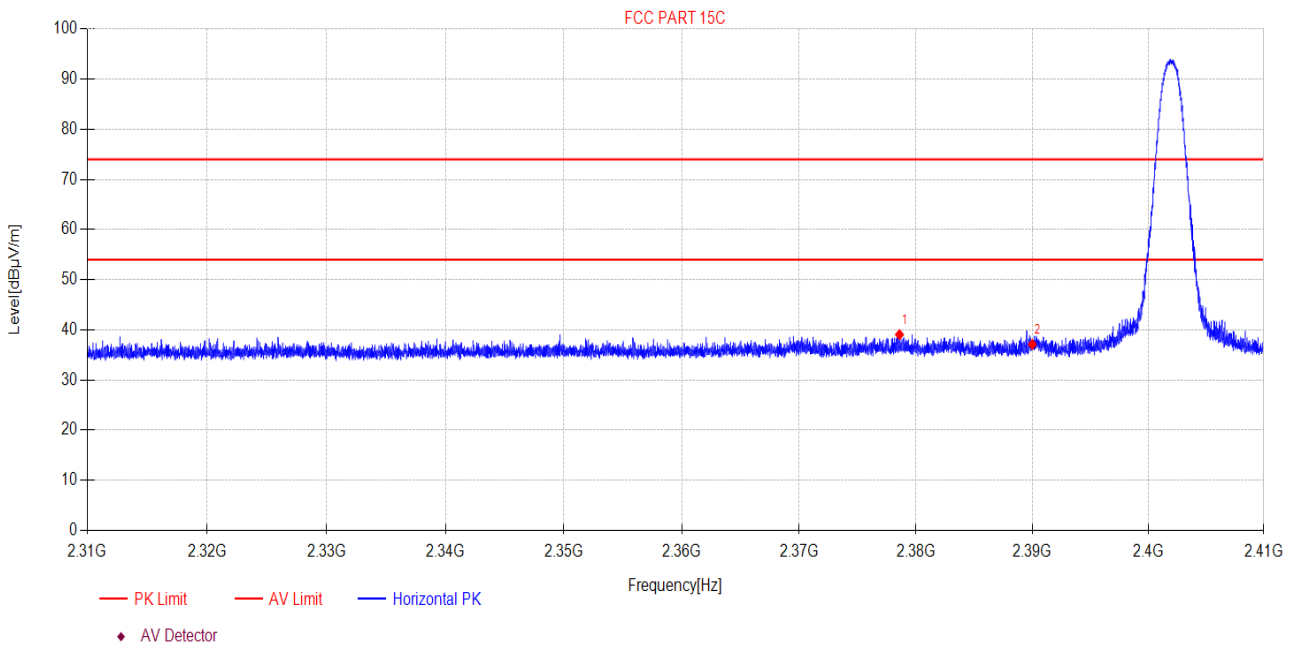

Suspected Data List								
NO.	Freq. [MHz]	Reading [dBµV]	Factor [dB]	Level [dBµV/m]	Limit [dBµV/m]	Margin [dB]	Detector	Polarity
1	2378.59	48.80	-9.74	39.06	74.00	34.94	PK	Horizontal
2	2390.00	46.83	-9.72	37.11	74.00	36.89	PK	Horizontal

**Note:**

1. Level = Reading + Factor.
2. If Peak Result complies with AV limit, AV Result is deemed to comply with AV limit.
3. Test setup: RBW: 1 MHz, VBW: 3 MHz, Sweep time: auto.

# TR-4-E-009 Radiated Emission Test Result

**Test Date:** 2022-11-03      **Tested By:** James Gan  
**EUT:** COMPLETE CONTENT CREATION STUDIO      **Model Number:** DLZ CREATOR  
**Test Mode:** TX Mode      **Power Supply:** DC 18V  
**Condition:** Temp:24.2°C;Humi:50.8%;Press:100.3kPa      **Test Site:** DDT 3# Chamber  
**File Path:** d:\ts\2022 report data\Q22021607-2E DLZ CREATOR\FCC ABOVE 1G\30  
**Memo:** 3DH5 2402 Power:4

## Test Graph

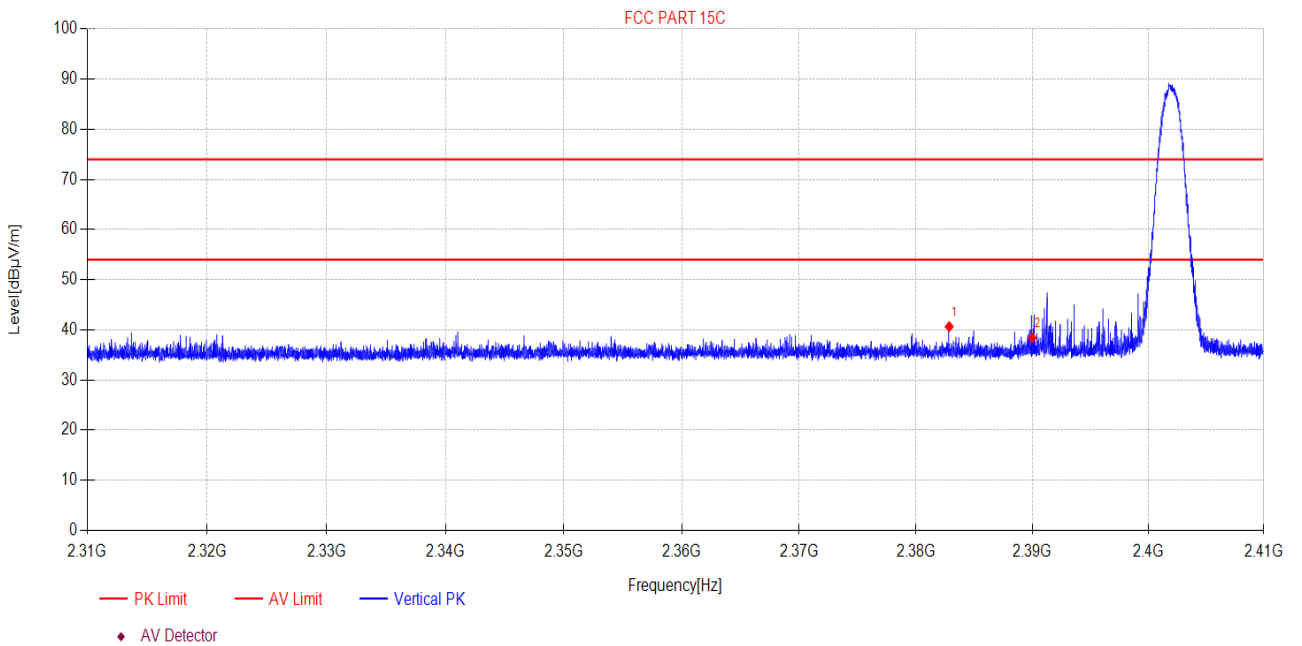

Suspected Data List								
NO.	Freq. [MHz]	Reading [dBµV]	Factor [dB]	Level [dBµV/m]	Limit [dBµV/m]	Margin [dB]	Detector	Polarity
1	2382.85	50.38	-9.73	40.65	74.00	33.35	PK	Vertical
2	2390.00	48.15	-9.72	38.43	74.00	35.57	PK	Vertical

**Note:**

1. Level = Reading + Factor.
2. If Peak Result complies with AV limit, AV Result is deemed to comply with AV limit.
3. Test setup: RBW: 1 MHz, VBW: 3 MHz, Sweep time: auto.

# TR-4-E-009 Radiated Emission Test Result

**Test Date:** 2022-11-03      **Tested By:** James Gan  
**EUT:** COMPLETE CONTENT CREATION STUDIO      **Model Number:** DLZ CREATOR  
**Test Mode:** TX Mode      **Power Supply:** DC 18V  
**Condition:** Temp:24.2°C;Humi:50.8%;Press:100.3kPa      **Test Site:** DDT 3# Chamber  
**File Path:** d:\ts\2022 report data\Q22021607-2E DLZ CREATOR\FCC ABOVE 1G\31  
**Memo:** DH5 2480 Power:4

## Test Graph

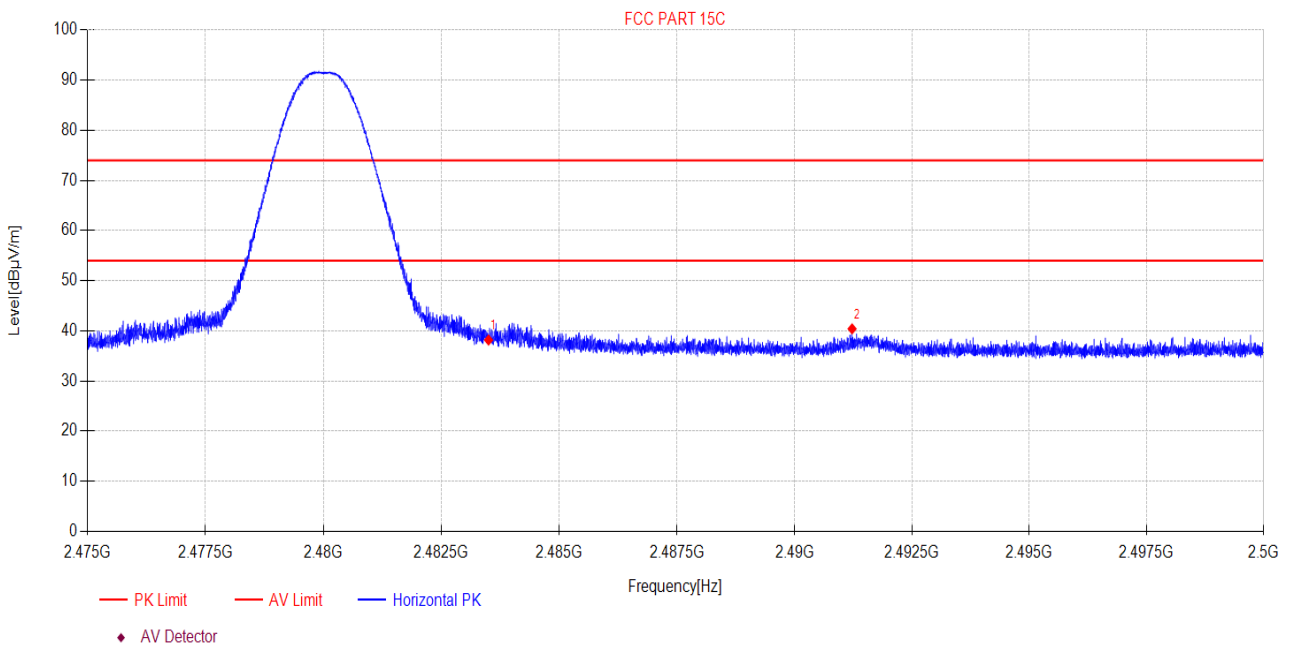

Suspected Data List								
NO.	Freq. [MHz]	Reading [dBµV]	Factor [dB]	Level [dBµV/m]	Limit [dBµV/m]	Margin [dB]	Detector	Polarity
1	2483.50	47.63	-9.46	38.17	74.00	35.83	PK	Horizontal
2	2491.23	49.83	-9.43	40.40	74.00	33.60	PK	Horizontal

**Note:**

1. Level = Reading + Factor.
2. If Peak Result complies with AV limit, AV Result is deemed to comply with AV limit.
3. Test setup: RBW: 1 MHz, VBW: 3 MHz, Sweep time: auto.

# TR-4-E-009 Radiated Emission Test Result

**Test Date:** 2022-11-03 **Tested By:** James Gan  
**EUT:** COMPLETE CONTENT CREATION STUDIO **Model Number:** DLZ CREATOR  
**Test Mode:** TX Mode **Power Supply:** DC 18V  
**Condition:** Temp:24.2°C;Humi:50.8%;Press:100.3kPa **Test Site:** DDT 3# Chamber  
**File Path:** d:\ts\2022 report data\Q22021607-2E DLZ CREATOR\FCC ABOVE 1G\32  
**Memo:** DH5 2480 Power:4

## Test Graph

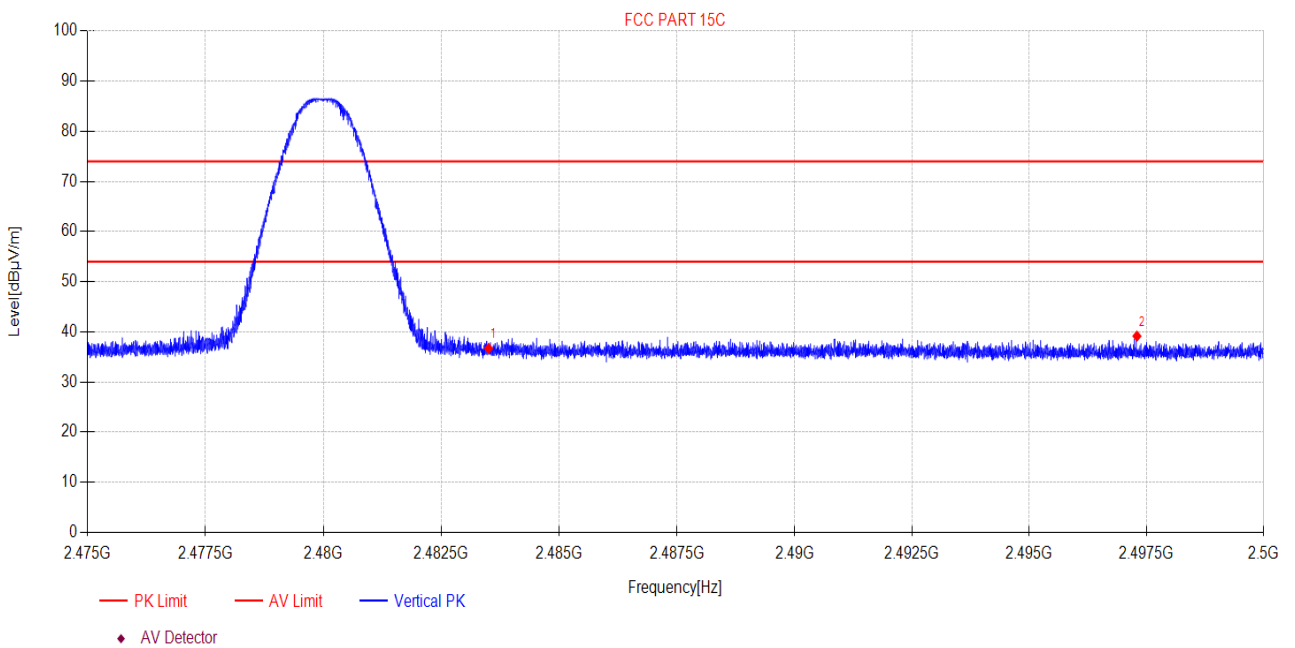

Suspected Data List								
NO.	Freq. [MHz]	Reading [dBµV]	Factor [dB]	Level [dBµV/m]	Limit [dBµV/m]	Margin [dB]	Detector	Polarity
1	2483.50	46.16	-9.46	36.70	74.00	37.30	PK	Vertical
2	2497.30	48.55	-9.40	39.15	74.00	34.85	PK	Vertical

**Note:**

1. Level = Reading + Factor.
2. If Peak Result complies with AV limit, AV Result is deemed to comply with AV limit.
3. Test setup: RBW: 1 MHz, VBW: 3 MHz, Sweep time: auto.

# TR-4-E-009 Radiated Emission Test Result

**Test Date:** 2022-11-03 **Tested By:** James Gan  
**EUT:** COMPLETE CONTENT CREATION STUDIO **Model Number:** DLZ CREATOR  
**Test Mode:** TX Mode **Power Supply:** DC 18V  
**Condition:** Temp:24.2°C;Humi:50.8%;Press:100.3kPa **Test Site:** DDT 3# Chamber  
**File Path:** d:\ts\2022 report data\Q22021607-2E DLZ CREATOR\FCC ABOVE 1G\33  
**Memo:** 2DH5 2480 Power:4

## Test Graph

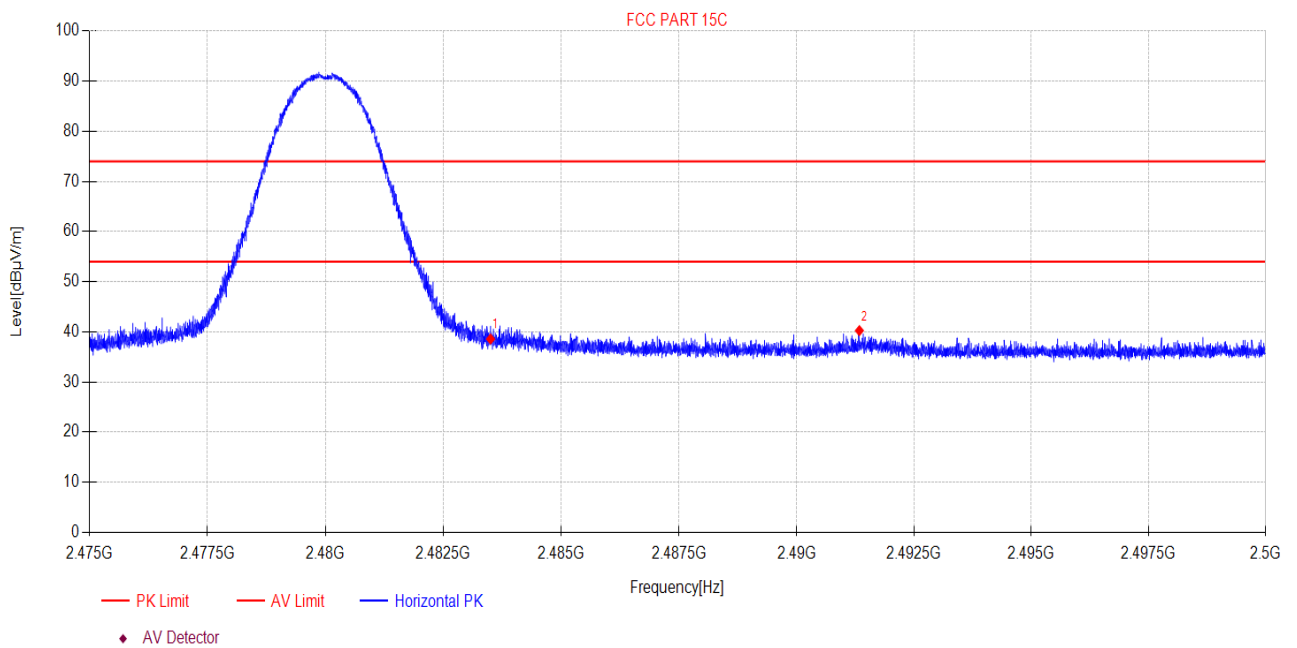

Suspected Data List								
NO.	Freq. [MHz]	Reading [dBµV]	Factor [dB]	Level [dBµV/m]	Limit [dBµV/m]	Margin [dB]	Detector	Polarity
1	2483.50	48.03	-9.46	38.57	74.00	35.43	PK	Horizontal
2	2491.34	49.67	-9.42	40.25	74.00	33.75	PK	Horizontal

**Note:**

1. Level = Reading + Factor.
2. If Peak Result complies with AV limit, AV Result is deemed to comply with AV limit.
3. Test setup: RBW: 1 MHz, VBW: 3 MHz, Sweep time: auto.

# TR-4-E-009 Radiated Emission Test Result

**Test Date:** 2022-11-03      **Tested By:** James Gan  
**EUT:** COMPLETE CONTENT CREATION STUDIO      **Model Number:** DLZ CREATOR  
**Test Mode:** TX Mode      **Power Supply:** DC 18V  
**Condition:** Temp:24.2°C;Humi:50.8%;Press:100.3kPa      **Test Site:** DDT 3# Chamber  
**File Path:** d:\ts\2022 report data\Q22021607-2E DLZ CREATOR\FCC ABOVE 1G\34  
**Memo:** 2DH5 2480 Power:4

## Test Graph

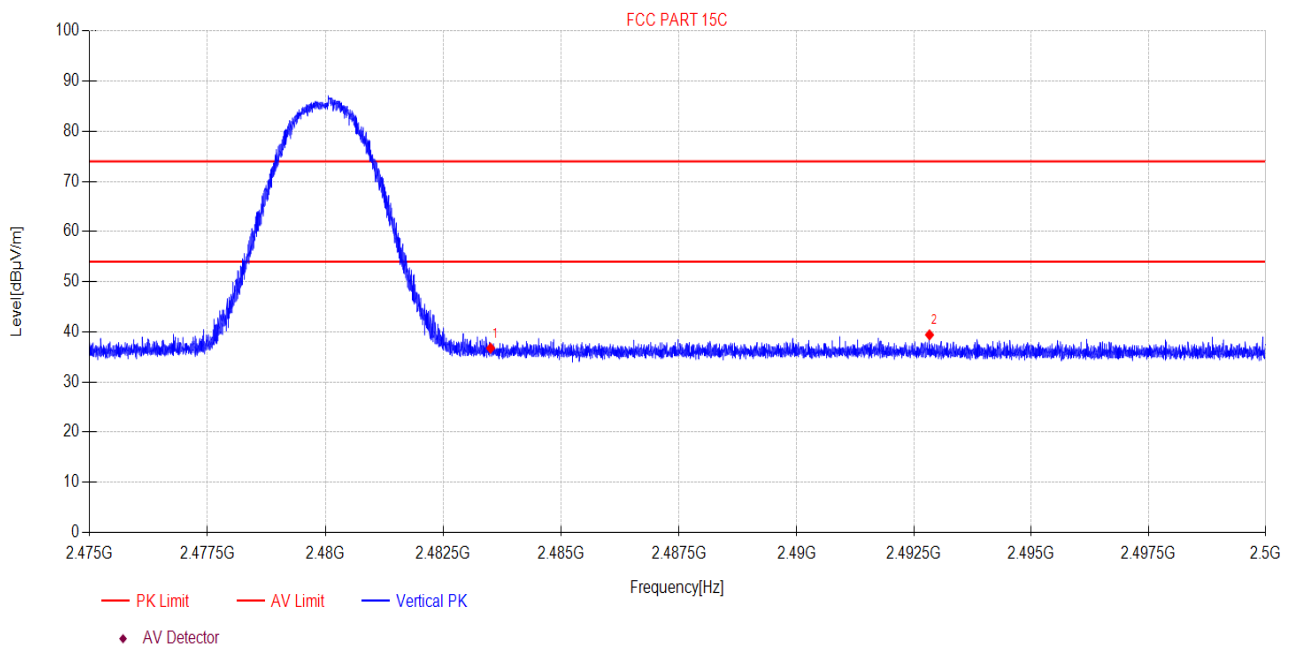

Suspected Data List								
NO.	Freq. [MHz]	Reading [dBµV]	Factor [dB]	Level [dBµV/m]	Limit [dBµV/m]	Margin [dB]	Detector	Polarity
1	2483.50	46.21	-9.46	36.75	74.00	37.25	PK	Vertical
2	2492.83	48.83	-9.42	39.41	74.00	34.59	PK	Vertical

**Note:**

1. Level = Reading + Factor.
2. If Peak Result complies with AV limit, AV Result is deemed to comply with AV limit.
3. Test setup: RBW: 1 MHz, VBW: 3 MHz, Sweep time: auto.

# TR-4-E-009 Radiated Emission Test Result

**Test Date:** 2022-11-03      **Tested By:** James Gan  
**EUT:** COMPLETE CONTENT CREATION STUDIO      **Model Number:** DLZ CREATOR  
**Test Mode:** TX Mode      **Power Supply:** DC 18V  
**Condition:** Temp:24.2°C;Humi:50.8%;Press:100.3kPa      **Test Site:** DDT 3# Chamber  
**File Path:** d:\ts\2022 report data\Q22021607-2E DLZ CREATOR\FCC ABOVE 1G\35  
**Memo:** 3DH5 2480 Power:4

## Test Graph

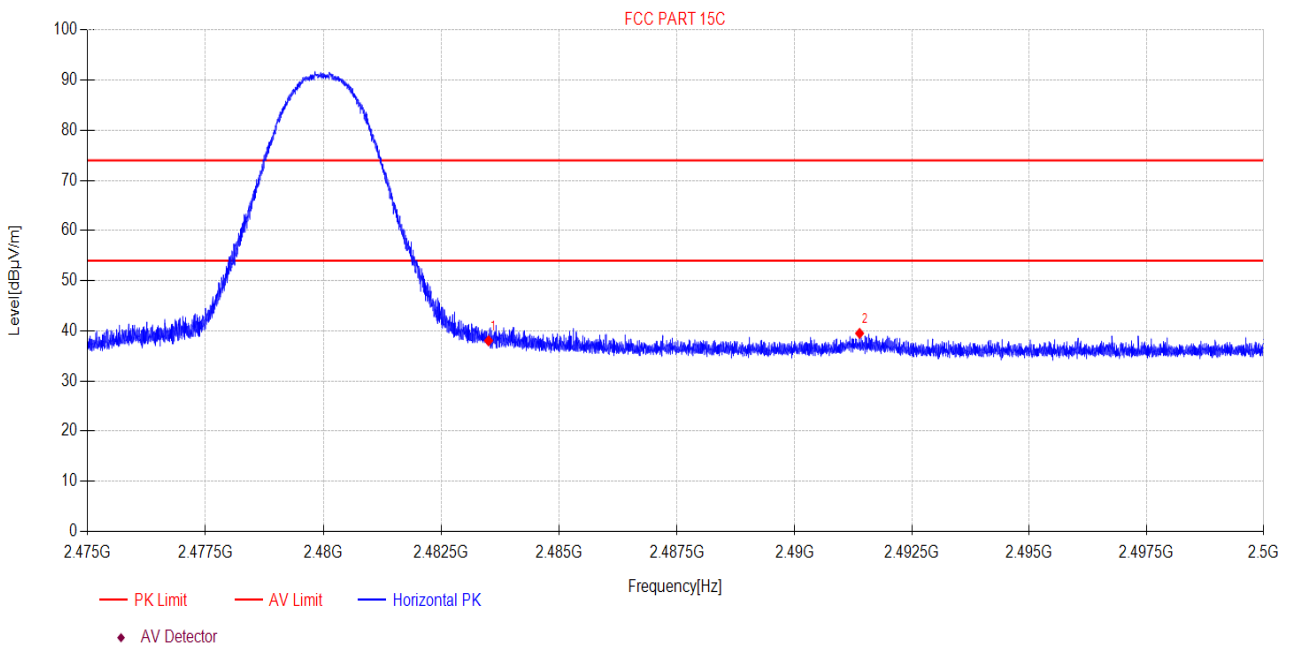

Suspected Data List								
NO.	Freq. [MHz]	Reading [dBµV]	Factor [dB]	Level [dBµV/m]	Limit [dBµV/m]	Margin [dB]	Detector	Polarity
1	2483.50	47.49	-9.46	38.03	74.00	35.97	PK	Horizontal
2	2491.39	48.92	-9.42	39.50	74.00	34.50	PK	Horizontal

**Note:**

1. Level = Reading + Factor.
2. If Peak Result complies with AV limit, AV Result is deemed to comply with AV limit.
3. Test setup: RBW: 1 MHz, VBW: 3 MHz, Sweep time: auto.

# TR-4-E-009 Radiated Emission Test Result

**Test Date:** 2022-11-03      **Tested By:** James Gan  
**EUT:** COMPLETE CONTENT CREATION STUDIO      **Model Number:** DLZ CREATOR  
**Test Mode:** TX Mode      **Power Supply:** DC 18V  
**Condition:** Temp:24.2°C;Humi:50.8%;Press:100.3kPa      **Test Site:** DDT 3# Chamber  
**File Path:** d:\ts\2022 report data\Q22021607-2E DLZ CREATOR\FCC ABOVE 1G\36  
**Memo:** 3DH5 2480 Power:4

## Test Graph

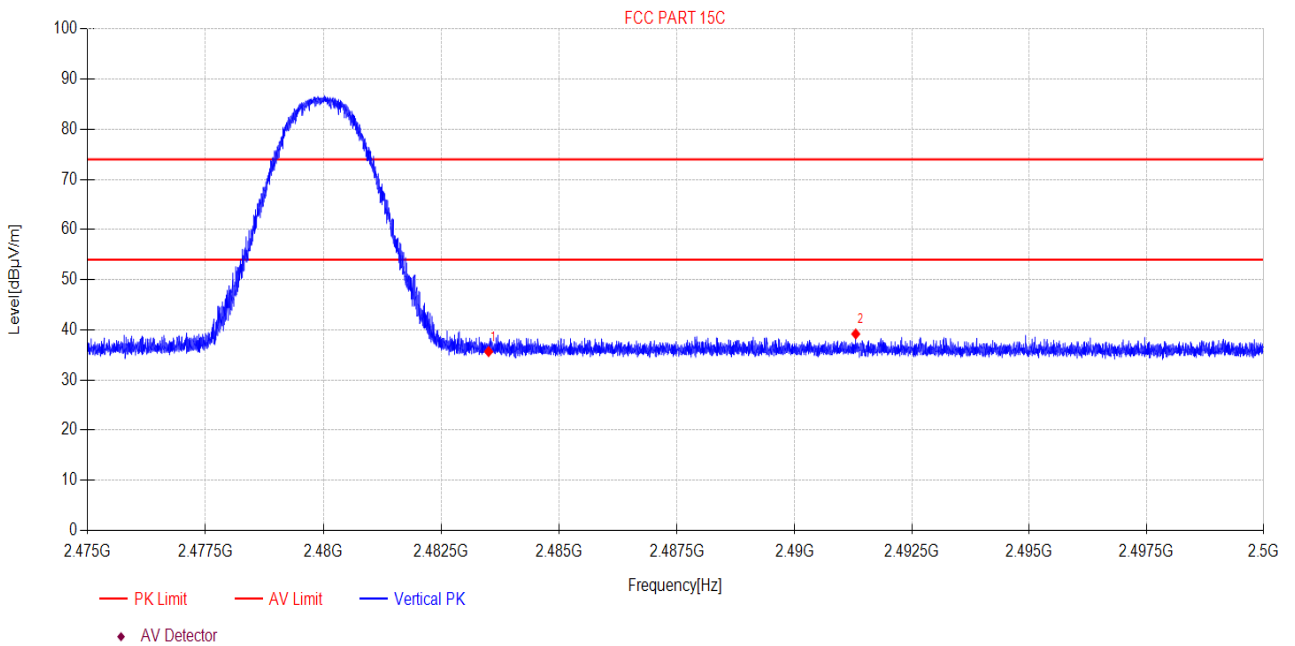

Suspected Data List								
NO.	Freq. [MHz]	Reading [dBµV]	Factor [dB]	Level [dBµV/m]	Limit [dBµV/m]	Margin [dB]	Detector	Polarity
1	2483.50	45.13	-9.46	35.67	74.00	38.33	PK	Vertical
2	2491.30	48.61	-9.42	39.19	74.00	34.81	PK	Vertical

**Note:**

1. Level = Reading + Factor.
2. If Peak Result complies with AV limit, AV Result is deemed to comply with AV limit.
3. Test setup: RBW: 1 MHz, VBW: 3 MHz, Sweep time: auto.



## 13. Power Line Conducted Emission

### 13.1. Block diagram of test setup

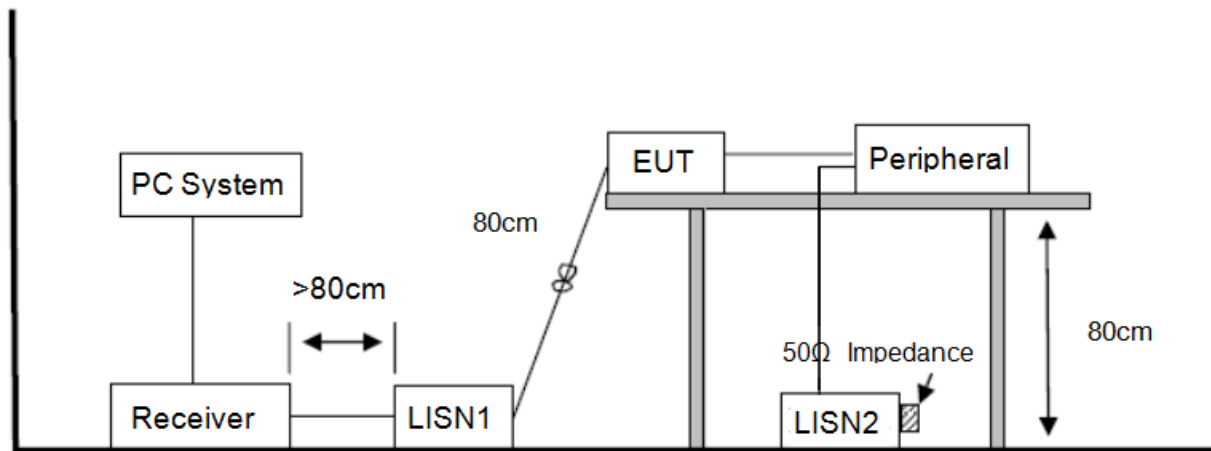

### 13.2. Power line conducted emission limits

Frequency	Quasi-Peak Level dB( $\mu$ V)	Average Level dB( $\mu$ V)
150 kHz ~ 500 kHz	66 ~ 56*	56 ~ 46*
500 kHz ~ 5 MHz	56	46
5 MHz ~ 30 MHz	60	50

Note 1: \* Decreasing linearly with logarithm of frequency.

Note 2: The lower limit shall apply at the transition frequencies.

### 13.3. Test procedure

The EUT and Support equipment, if needed, were put placed on a non-metallic table, 80cm above the ground plane.

Configuration EUT to simulate typical usage as described in clause 2.4 and test setup as described in clause 13.1 of this report.

All I/O cables were positioned to simulate typical actual usage as per ANSI C63.10.

All support equipment power received from a second LISN.

Emissions were measured on each current carrying line of the EUT using an EMI Test Receiver connected to the LISN powering the EUT.

The Receiver scanned from 150 kHz to 30MHz for emissions in each of the test modes.

During the above scans, the emissions were maximized by cable manipulation.

The test mode(s) described in clause 2.4 were scanned during the preliminary test.

After the preliminary scan, we found the test mode producing the highest emission level.

The EUT configuration and worse cable configuration of the above highest emission levels were

recorded for reference of the final test.

EUT and support equipment were set up on the test bench as per the configuration with highest emission level in the preliminary test.

A scan was taken on both power lines, Neutral and Line, recording at least the six highest emissions.

Emission frequency and amplitude were recorded into a computer in which correction factors were used to calculate the emission level and compare reading to the applicable limit.

The test data of the worst-case condition(s) was recorded.

The bandwidth of test receiver is set at 9 kHz.

### 13.4. Test result

Pass. (See below detailed test result)

Note1: All emissions not reported below are too low against the prescribed limits.

Note2: "----" means Peak detection; "-----" means Average detection.

Note3: Pre-test AC conducted emission at both voltage AC 120V/60Hz and AC 240V/50Hz, recorded worst case.

Note4: There are two different modes of switching power adapters for this product, which will be shipped randomly with either one. Both models were tested and are recorded the worst case of each adapter in this report.

# GPE048G-180150-D: TR-4-E-010 Conducted Emission Test Result

**Test Site** : DDT 1# Shield Room

D:\2023 CE report data\Q22021607-2E DLZ  
CREATOR\FCC.EM6

**Test Date** : 2023-02-27

**Tested By** : Bairong

**EUT** : COMPLETECONTENTCREATIONSTUDIO

**Model Number** : DLZCREATOR

**Power Supply** : AC 120V/60Hz

**Test Mode** : TX

**Condition** : TEMP:23.6°C, RH:52.1%

**LISN** : 2022 1# ENV216/NEUTRAL

**Memo** : BT

Data: 2

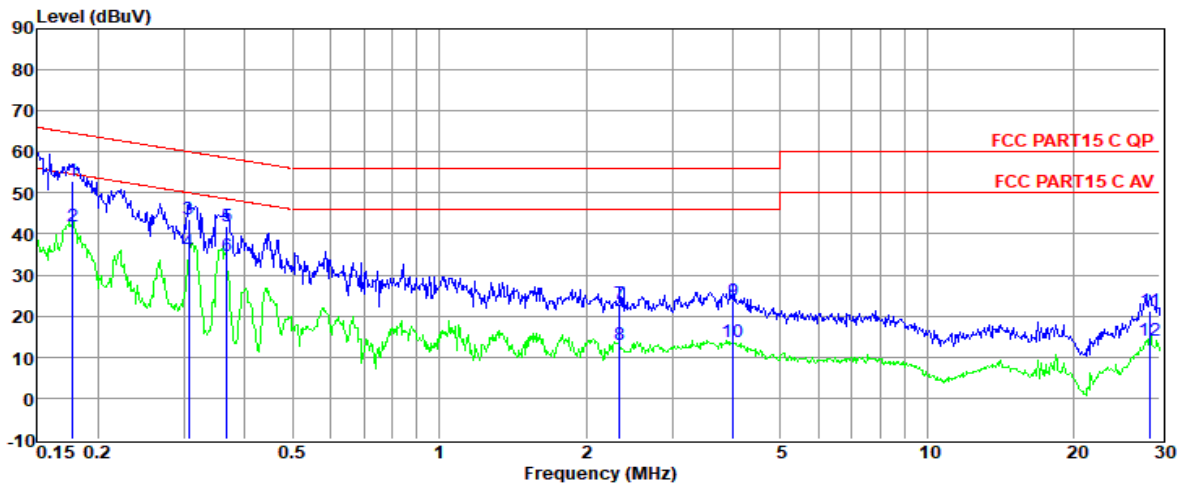

Item (Mark)	Freq. (MHz)	Read Level (dBuV)	LISN Factor (dB)	Cable Loss (dB)	Pulse Limiter Factor (dB)	Result Level (dBuV)	Limit Line (dBuV)	Over Limit (dB)	Detector	Phase
1	0.18	33.19	9.86	0.01	9.92	52.98	64.59	-11.61	QP	NEUTRAL
2	0.18	22.19	9.86	0.01	9.92	41.98	54.59	-12.61	Average	NEUTRAL
3	0.31	23.80	9.76	0.01	9.91	43.48	60.06	-16.58	QP	NEUTRAL
4	0.31	15.97	9.76	0.01	9.91	35.65	50.06	-14.41	Average	NEUTRAL
5	0.37	22.15	9.70	0.01	9.91	41.77	58.56	-16.79	QP	NEUTRAL
6	0.37	15.15	9.70	0.01	9.91	34.77	48.56	-13.79	Average	NEUTRAL
7	2.35	3.42	9.70	0.04	9.90	23.06	56.00	-32.94	QP	NEUTRAL
8	2.35	-6.78	9.70	0.04	9.90	12.86	46.00	-33.14	Average	NEUTRAL
9	4.01	4.05	9.70	0.05	9.91	23.71	56.00	-32.29	QP	NEUTRAL
10	4.01	-5.94	9.70	0.05	9.91	13.72	46.00	-32.28	Average	NEUTRAL
11	28.60	1.16	9.80	0.16	10.00	21.12	60.00	-38.88	QP	NEUTRAL
12	28.60	-5.87	9.80	0.16	10.00	14.09	50.00	-35.91	Average	NEUTRAL

Note:

1. Result Level = Read Level + LISN Factor + Pulse Limiter Factor + Cable loss.
2. If QP Result complies with AV limit, AV Result is deemed to comply with AV limit.
3. Test setup: RBW: 200 Hz (9 kHz—150 kHz), 9 kHz (150 kHz—30 MHz).
4. Step size: 80Hz (0.009MHz-0.15MHz), 4 kHz (0.15MHz-30MHz), Scan time: auto.

# TR-4-E-010 Conducted Emission Test Result

<b>Test Site</b>	: DDT 1# Shield Room	D:\2023 CE report data\Q22021607-2E DLZ CREATOR\FCC.EM6
<b>Test Date</b>	: 2023-02-27	<b>Tested By</b> : Bairong
<b>EUT</b>	: COMPLETECONTENTCREATIONSTUDIO	<b>Model Number</b> : DLZCREATOR
<b>Power Supply</b>	: AC 120V/60Hz	<b>Test Mode</b> : TX
<b>Condition</b>	: TEMP:23.6°C, RH:52.1%	<b>LISN</b> : 2022 1# ENV216/LINE
<b>Memo</b>	: BT	

Data: 4

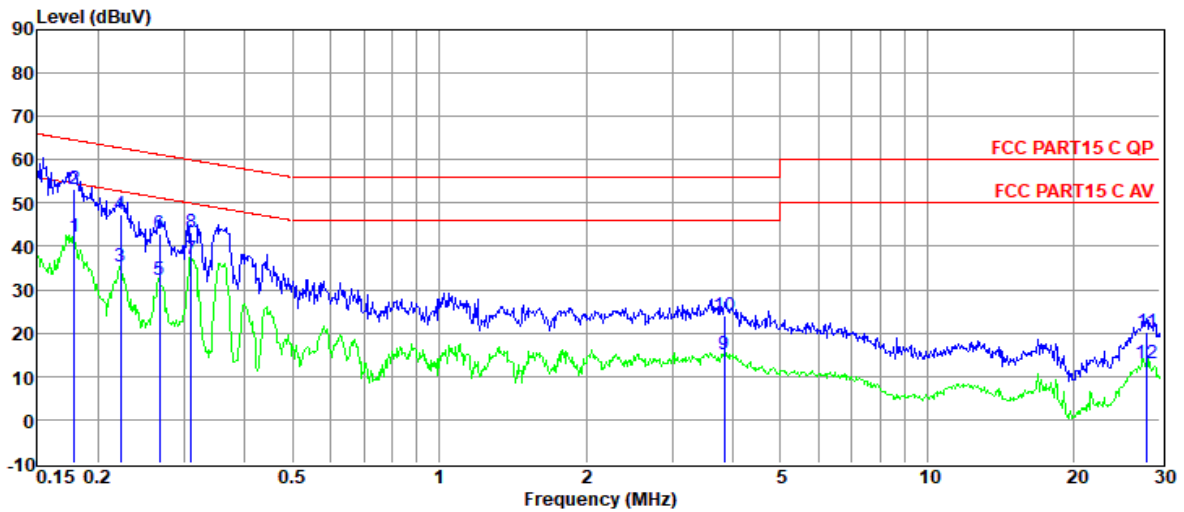

Item (Mark)	Freq. (MHz)	Read Level (dBμV)	LISN Factor (dB)	Cable Loss (dB)	Pulse Limiter Factor (dB)	Result Level (dBμV)	Limit Line (dBμV)	Over Limit (dB)	Detector	Phase
1	0.18	22.48	9.72	0.01	9.92	42.13	64.55	-22.42	QP	LINE
2	0.18	33.42	9.72	0.01	9.92	53.07	54.55	-1.48	Average	LINE
3	0.22	15.63	9.79	0.01	9.90	35.33	62.74	-27.41	QP	LINE
4	0.22	27.66	9.79	0.01	9.90	47.36	52.74	-5.38	Average	LINE
5	0.27	12.65	9.77	0.01	9.91	32.34	61.20	-28.86	QP	LINE
6	0.27	23.39	9.77	0.01	9.91	43.08	51.20	-8.12	Average	LINE
7	0.31	17.48	9.75	0.01	9.91	37.15	59.97	-22.82	QP	LINE
8	0.31	23.45	9.75	0.01	9.91	43.12	49.97	-6.85	Average	LINE
9	3.84	-4.35	9.51	0.05	9.91	15.12	56.00	-40.88	QP	LINE
10	3.84	4.69	9.51	0.05	9.91	24.16	46.00	-21.84	Average	LINE
11	28.15	0.38	9.67	0.16	10.00	20.21	60.00	-39.79	QP	LINE
12	28.15	-6.64	9.67	0.16	10.00	13.19	50.00	-36.81	Average	LINE

Note:

1. Result Level = Read Level + LISN Factor + Pulse Limiter Factor + Cable loss.
2. If QP Result complies with AV limit, AV Result is deemed to comply with AV limit.
3. Test setup: RBW: 200 Hz (9 kHz—150 kHz), 9 kHz (150 kHz—30 MHz).
4. Step size: 80Hz (0.009MHz-0.15MHz), 4 kHz (0.15MHz-30MHz), Scan time: auto.

# GME36E-180150FDR: TR-4-E-010 Conducted Emission Test Result

**Test Site** : DDT 1# Shield Room

D:\2023 CE report data\Q22021607-2E DLZ  
CREATOR\FCC.EM6

**Test Date** : 2023-03-07

**Tested By** : Bairong

**EUT** : COMPLETECONTENTCREATIONSTUDIO

**Model Number** : DLZCREATOR

**Power Supply** : AC 120V/60Hz

**Test Mode** : TX

**Condition** : TEMP:23.6°C, RH:52.1%

**LISN** : 2022 1# ENV216/NEUTRAL

**Memo** : BT

Data: 6

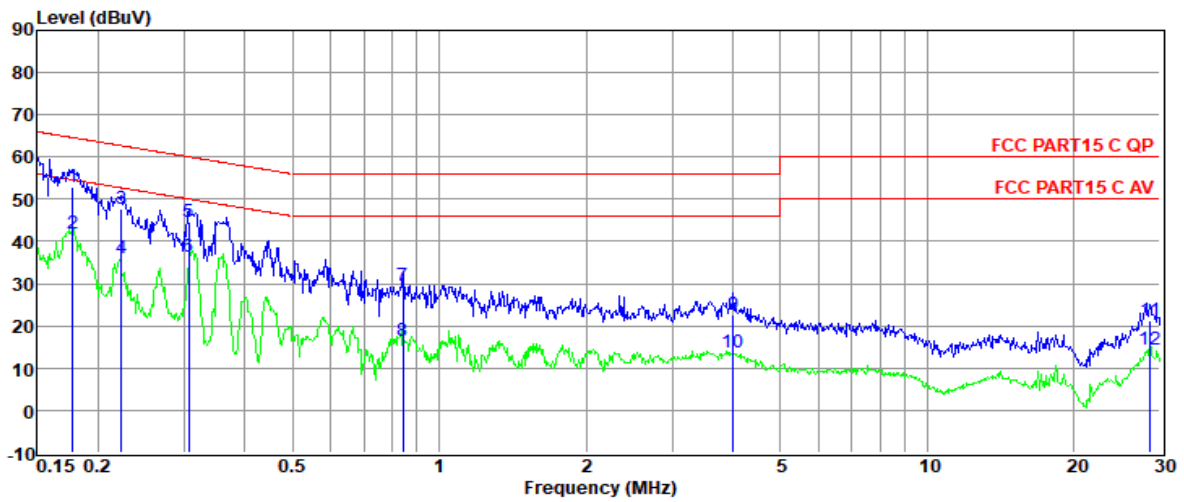

Item (Mark)	Freq. (MHz)	Read Level (dBμV)	LISN Factor (dB)	Cable Loss (dB)	Pulse Limiter Factor (dB)	Result Level (dBμV)	Limit Line (dBμV)	Over Limit (dB)	Detector	Phase
1	0.18	33.19	9.86	0.01	9.92	52.98	64.59	-11.61	QP	NEUTRAL
2	0.18	22.19	9.86	0.01	9.92	41.98	54.59	-12.61	Average	NEUTRAL
3	0.22	28.02	9.86	0.01	9.90	47.79	62.70	-14.91	QP	NEUTRAL
4	0.22	16.11	9.86	0.01	9.90	35.88	52.70	-16.82	Average	NEUTRAL
5	0.31	24.80	9.76	0.01	9.91	44.48	60.06	-15.58	QP	NEUTRAL
6	0.31	16.70	9.76	0.01	9.91	36.38	50.06	-13.68	Average	NEUTRAL
7	0.84	9.85	9.75	0.02	9.91	29.53	56.00	-26.47	QP	NEUTRAL
8	0.84	-3.18	9.75	0.02	9.91	16.50	46.00	-29.50	Average	NEUTRAL
9	4.01	3.05	9.70	0.05	9.91	22.71	56.00	-33.29	QP	NEUTRAL
10	4.01	-5.94	9.70	0.05	9.91	13.72	46.00	-32.28	Average	NEUTRAL
11	28.60	1.16	9.80	0.16	10.00	21.12	60.00	-38.88	QP	NEUTRAL
12	28.60	-5.70	9.80	0.16	10.00	14.26	50.00	-35.74	Average	NEUTRAL

Note:

1. Result Level = Read Level + LISN Factor + Pulse Limiter Factor + Cable loss.
2. If QP Result complies with AV limit, AV Result is deemed to comply with AV limit.
3. Test setup: RBW: 200 Hz (9 kHz—150 kHz), 9 kHz (150 kHz—30 MHz).
4. Step size: 80Hz (0.009MHz-0.15MHz), 4 kHz (0.15MHz-30MHz), Scan time: auto.

# TR-4-E-010 Conducted Emission Test Result

<b>Test Site</b>	: DDT 1# Shield Room	D:\2023 CE report data\Q22021607-2E DLZ CREATOR\FCC.EM6
<b>Test Date</b>	: 2023-03-07	<b>Tested By</b> : Bairong
<b>EUT</b>	: COMPLETECONTENTCREATIONSTUDIO	<b>Model Number</b> : DLZCREATOR
<b>Power Supply</b>	: AC 120V/60Hz	<b>Test Mode</b> : TX
<b>Condition</b>	: TEMP:23.6°C, RH:52.1%	<b>LISN</b> : 2022 1# ENV216/LINE
<b>Memo</b>	: BT	

Data: 8

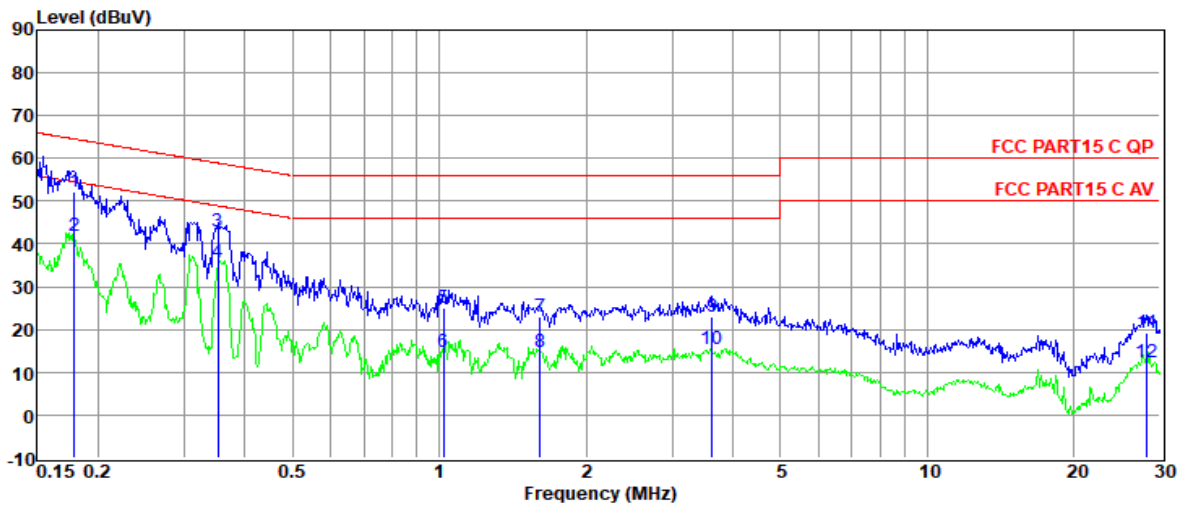

Item (Mark)	Freq. (MHz)	Read Level (dBμV)	LISN Factor (dB)	Cable Loss (dB)	Pulse Limiter Factor (dB)	Result Level (dBμV)	Limit Line (dBμV)	Over Limit (dB)	Detector	Phase
1	0.18	32.48	9.72	0.01	9.92	52.13	64.55	-12.42	QP	LINE
2	0.18	22.20	9.72	0.01	9.92	41.85	54.55	-12.70	Average	LINE
3	0.35	23.34	9.74	0.01	9.91	43.00	58.91	-15.91	QP	LINE
4	0.35	15.90	9.74	0.01	9.91	35.56	48.91	-13.35	Average	LINE
5	1.02	5.76	9.50	0.02	9.91	25.19	56.00	-30.81	QP	LINE
6	1.02	-4.80	9.50	0.02	9.91	14.63	46.00	-31.37	Average	LINE
7	1.61	3.33	9.57	0.03	9.90	22.83	56.00	-33.17	QP	LINE
8	1.61	-4.70	9.57	0.03	9.90	14.80	46.00	-31.20	Average	LINE
9	3.62	3.36	9.51	0.04	9.91	22.82	56.00	-33.18	QP	LINE
10	3.62	-4.02	9.51	0.04	9.91	15.44	46.00	-30.56	Average	LINE
11	28.15	-0.62	9.67	0.16	10.00	19.21	60.00	-40.79	QP	LINE
12	28.15	-7.34	9.67	0.16	10.00	12.49	50.00	-37.51	Average	LINE

Note:

1. Result Level = Read Level + LISN Factor + Pulse Limiter Factor + Cable loss.
2. If QP Result complies with AV limit, AV Result is deemed to comply with AV limit.
3. Test setup: RBW: 200 Hz (9 kHz—150 kHz), 9 kHz (150 kHz—30 MHz).
4. Step size: 80Hz (0.009MHz-0.15MHz), 4 kHz (0.15MHz-30MHz), Scan time: auto.

## 14. Antenna Requirements

### 14.1. Limit

For intentional device, according to FCC 47 CFR Section 15.203, an intentional radiator shall be designed to ensure that no antenna other than that furnished by the responsible party shall be used with the device. And according to FCC 47 CFR Section 15.247 (b), if transmitting antennas of directional gain greater than 6dBi are used, the power shall be reduced by the amount in dB that the directional gain of the antenna exceeds 6dBi.

For intentional device, according to RSS-Gen issue 5 section 6.8.

The applicant for equipment certification shall provide a list of all antenna types that may be used with the transmitter, where applicable (i.e. for transmitters with detachable antenna), indicating the maximum permissible antenna gain (in dBi) and the required impedance for each antenna.

The test report shall demonstrate the compliance of the transmitter with the limit for maximum equivalent isotropically radiated power (e.i.r.p.) specified in the applicable RSS, when the transmitter is equipped with any antenna type, selected from this list.

### 14.2. Result

The antenna used for this product is FPBC antenna and that no antenna other than that furnished by the responsible party shall be used with the device, the maximum peak gain of the transmit antenna is 2.51 dBi.

## 16. Photos of the EUT

Please refer to appendix I.

**END OF REPORT**