

FCC Part 15C&RSS-247 TEST REPORT

FCC ID: 2AD4XCR8SBBT

IC: 12714A-CR8SBBT

Product : CREATIVE REFERENCE SUBWOOFER
WITH BLUETOOTH
Model Name : CR8SBT
Brand : 
Report No. : NCT24028374

Prepared for

LOUD AUDIO, LLC

19820 North Creek Parkway, #201, Bothell, Washington 98011-8227, United States

Prepared by

Shenzhen NCT Testing Technology Co., Ltd.

**A101&2F B2, Fuqiao 6th Area, Xintian Community, Fuhai Street, Baoan District,
Shenzhen, People's Republic of China**

TEL: 400-8868-419

FAX: 86-755-27790922

1 TEST RESULT CERTIFICATION

Applicant's name : LOUD AUDIO, LLC
Address : 19820 North Creek Parkway, #201, Bothell, Washington 98011-8227, United States
Manufacture's name : LOUD AUDIO, LLC
Address : 19820 North Creek Parkway, #201, Bothell, Washington 98011-8227, United States
Product name : CREATIVE REFERENCE SUBWOOFER WITH BLUETOOTH
Model name : CR8SBT
Additional model : N/A
Standards : FCC CFR47 Part 15 Section 15.247
RSS-247 Issue 3: August 2023
Test procedure : ANSI C63.10:2013
RSS-GEN, Issue 5: March 2019
Test Date : Jun. 19, 2024 to Jul. 16, 2024
Date of Issue : Jun. 17, 2024
Test Result : Pass

This device described above has been tested by NCT, and the test results show that the equipment under test (EUT) is in compliance with the FCC requirements. And it is applicable only to the tested sample identified in the report.

This report shall not be reproduced except in full, without the written approval of NCT, this document may be altered or revised by NCT, personal only, and shall be noted in the revision of the document.

Test Engineer:

Keven Wu

Keven Wu / Engineer

Technical Manager:

Henry Wang

Henry Wang / Manager



Contents

	Page
1 TEST RESULT CERTIFICATION	2
2 TEST SUMMARY	5
3 TEST FACILITY	6
4 GENERAL INFORMATION	7
4.1 GENERAL DESCRIPTION OF E.U.T.	7
4.2 CHANNEL LIST	8
4.3 TEST SETUP CONFIGURATION	9
4.4 TEST MODE	9
5 EQUIPMENT DURING TEST	10
5.1 EQUIPMENTS LIST	10
5.2 MEASUREMENT UNCERTAINTY	12
5.3 DESCRIPTION OF SUPPORT UNITS	12
6 CONDUCTED EMISSION	13
6.1 E.U.T. OPERATION	13
6.2 EUT SETUP	13
6.3 TEST SET-UP (BLOCK DIAGRAM OF CONFIGURATION)	14
6.4 MEASUREMENT PROCEDURE:	14
6.5 CONDUCTED EMISSION LIMIT	14
6.6 MEASUREMENT DESCRIPTION	14
6.7 CONDUCTED EMISSION TEST RESULT	14
7 RADIATED SPURIOUS EMISSIONS	17
7.1 EUT OPERATION	17
7.2 TEST SETUP	18
7.3 SPECTRUM ANALYZER SETUP	19
7.4 TEST PROCEDURE	20
7.5 SUMMARY OF TEST RESULTS	21
8 MAXIMUM PEAK OUTPUT POWER TEST	28
8.1 TEST STANDARD AND LIMIT	28
8.2 TEST SETUP	28

8.3 TEST PROCEDURE	28
8.4 TEST DATA	28
9 20DB OCCUPY BANDWIDTH & 99% OCB TEST	32
9.1 TEST STANDARD	32
9.2 TEST SETUP	32
9.3 TEST PROCEDURE	32
9.4 TEST DATA	32
10 CARRIER FREQUENCY SEPARATION TEST	36
10.1 TEST STANDARD AND LIMIT	36
10.2 TEST SETUP	36
10.3 TEST PROCEDURE	36
10.4 TEST DATA	36
11 NUMBER OF HOPPING CHANNEL TEST	38
11.1 TEST STANDARD AND LIMIT	38
11.2 TEST SETUP	38
11.3 TEST PROCEDURE	38
11.4 TEST DATA	39
12 DWELL TIME TEST	41
12.1 TEST STANDARD AND LIMIT	41
12.2 TEST SETUP	41
12.3 TEST PROCEDURE	41
12.4 TEST DATA	42
13 100KHZ BANDWIDTH OF FREQUENCY BAND EDGE REQUIREMENT	46
13.1 TEST STANDARD AND LIMIT	46
13.2 TEST SETUP	46
13.3 TEST PROCEDURE	46
13.4 TEST DATA	47
14 ANTENNA REQUIREMENT	52
14.1 TEST STANDARD AND REQUIREMENT	52
14.2 ANTENNA CONNECTED CONSTRUCTION	52
15 APPENDIX I -- TEST SETUP PHOTOGRAPH	53
16 APPENDIX II -- EUT PHOTOGRAPH	54

2 Test Summary

Test Items	Test Requirement	Result
Radiated Spurious Emissions and Restricted Bandedge	15.205(a) 15.209 15.247(d) RSS-Gen.6.13 RSS-Gen.8.10	PASS
Conducted Unwanted emissions and Band edge	15.247(d) 15.205(a) RSS-247 5.5	PASS
Conduct Emission	15.207 RSS-Gen 8.8	PASS
20dB Bandwidth & 99% OCB	15.247(a)(1) RSS-247.5.1(2) RSS-Gen.6.7	PASS
Maximum Peak Output Power	15.247(b)(1) RSS-247.5.4(4)	PASS
Frequency Separation	15.247(a)(1) RSS-247.5.1(4)	PASS
Number of Hopping Frequency	15.247(a)(1)(iii)RSS-247.5.1(4)	PASS
Dwell time	15.247(a)(1)(iii)RSS-247.5.1(5)	PASS
Antenna Requirement	15.203 RSS-Gen 6.8	PASS

Remark:

1. "N/A" denotes test is not applicable in this Test Report.

3 TEST FACILITY

Site Description

EMC Lab. : Accredited by CNAS, 2022-09-27

The certificate is valid until 2028.01.07

The Laboratory has been assessed and proved to be in compliance with CNAS-CL01:2006 (identical to ISO/IEC 17025:2017)

The Certificate Registration Number is L8251

Designation Number: CN1347

Test Firm Registration Number: 894804

Accredited by A2LA, June 14, 2023

The Certificate Registration Number is 6837.01

Accredited by Industry Canada, November 09, 2018

The Conformity Assessment Body Identifier is CN0150

Company Number: 30806

Name of Firm : Shenzhen NCT Testing Technology Co., Ltd.

Site Location : A101&2F B2, Fuqiao 6th Area, Xintian Community, Fuhai Street, Baoan District, Shenzhen, People's Republic of China

4 General Information

4.1 General Description of E.U.T.

Product Name	:	CREATIVE REFERENCE SUBWOOFER WITH BLUETOOTH
Model Name	:	CR8SBT
Sample ID	:	240617044
Sample(s) Status:	:	Engineer sample
Additional model	:	N/A
Model difference	:	N/A
Operating frequency	:	2402-2480MHz
Numbers of Channel	:	79 channels
Antenna Type	:	PCB Antenna
Antenna Gain	:	0.32dBi
Type of Modulation	:	GFSK, $\pi/4$ DQPSK, 8DPSK
Power supply	:	100V~240V 50-60Hz 150W
Hardware Version	:	A00
Software Version	:	V11
Remark: the Antenna gain is provided by customer from Antenna spec. and the laboratory will not be responsible for the accumulated calculation results which covers the information provided by the applicant.		

4.2 Channel List

The EUT has been tested under its typical operating condition. Pre-defined engineering program for regulatory testing used to control the EUT for staying in continuous transmitting. Only the worst case data were reported.

The EUT has been associated with peripherals pursuant to ANSI C63.10-2013 and configuration operated in a manner tended to maximize its emission characteristics in a typical application. Frequency range investigated: radiation (9 KHz to the 10th harmonics of the highest fundamental frequency or to 40 GHz, whichever is lower).

The EUT has been tested under TX operating condition.

This EUT is a FHSS system, were conducted to determine the final configuration from all possible combinations. We use software control the EUT, Let EUT hopping on and transmit with highest power, all the modes GFSK, $\pi/4$ DQPSK, 8DPSK have been tested. 79 Channels are provided by EUT. The 3 channels of lower, medium and higher were chosen for test.

Channel List:

Channel	Frequency (MHz)	Channel	Frequency (MHz)	Channel	Frequency (MHz)	Channel	Frequency (MHz)
0	2402	1	2403	2	2404	3	2405
4	2406	5	2407	6	2408	7	2409
8	2410	9	2411	10	2412	11	2413
12	2414	13	2415	14	2416	15	2417
16	2418	17	2419	18	2420	19	2421
20	2422	21	2423	22	2424	23	2425
24	2426	25	2427	26	2428	27	2429
28	2430	29	2431	30	2432	31	2433
32	2434	33	2435	34	2436	35	2437
36	2438	37	2439	38	2440	39	2441
40	2442	41	2443	42	2444	43	2445
44	2446	45	2447	46	2448	47	2449
48	2450	49	2451	50	2452	51	2453
52	2454	53	2455	54	2456	55	2457
56	2458	57	2459	58	2460	59	2461
60	2462	61	2463	62	2464	63	2465
64	2466	65	2467	66	2468	67	2469
68	2470	69	2471	70	2472	71	2473
72	2474	73	2475	74	2476	75	2477
76	2478	77	2479	78	2480	-	-

Channel	Frequency(MHz)
0	2402
39	2441
78	2480

4.3 Test Setup Configuration

Conducted Emission

AC Line



Radiated Emission

AC Line



Conducted Spurious

AC Line



4.4 Test Mode

Transmitting mode	Keep the EUT in continuously transmitting mode.
Remark: During the test, the test voltage was tuned from 85% to 115% of the nominal rated supply voltage, and found that the worst case was under the nominal rated supply condition. So the report just shows that condition's data.	

Test Software	FCC_Test_Tools V2.24.exe
Power level setup	≤ 10dBm

5 Equipment During Test

5.1 Equipments List

Conducted emission Test Equipment

Name	Model No.	Serial No.	Manufacturer	Date of Cal.	Due Date
944 Shielded Room	944 Room	/	EMToni	2022/5/31	2025/5/30
EMI Test Receiver	ESPI	101604	Rohde & Schwarz	2024/6/17	2025/6/16
LISN	ENV 216	102796	Rohde & Schwarz	2024/6/17	2025/6/16
LISN	VN1-13S	004023	CRANAGE	2024/6/17	2025/6/16
Cable	RG223-1500MM	NA	RG	2024/6/17	2025/6/16

Radiated emission & Radio Frequency Test Equipment

Name	Model No.	Serial No.	Manufacturer	Date of Cal.	Due Date
966 Shielded Room	966 Room	/	EMToni	2022/5/31	2025/5/30
EMI Test Receiver	ESCI	101178	Rohde & Schwarz	2024/6/17	2025/6/16
Spectrum Analyze (10Hz-26.5GHz)	N9020A	MY50510202	Agilent	2024/6/17	2025/6/16
Amplifi (30MHz-1GHz)	BBV 9743 B	00374	SCHNARZBECK	2023/3/19	2025/3/18
Bilog Antenna (30MHz-1GHz)	VULB9162	00473	SCHNARZBECK	2023/3/19	2025/3/18
Horn antenna (1GHz-18GHz)	BBHA 9120 D	02622	SCHNARZBECK	2024/6/17	2025/6/16
Pream plifier (1GHz-18GHz)	BBV 9718D	0024	SCHNARZBECK	2024/6/17	2025/6/16
Spectrum Analyze (1GHz-40GHz)	FSV 40	100952	Rohde & Schwarz	2024/6/17	2025/6/16
Pream plifier (18GHz-40GHz)	BBV 9721	0056	SCHNWARZBEC K	2023/3/19	2025/3/18
Pream plifier (15GHz-40GHz)	BBV 9718D	0024	SCHNARZBECK	2024/6/17	2025/6/16
Broadband Antenna (15GHz-40GHz)	SAS-574	588	A.H.System	2024/6/17	2025/6/16

Loop Antenna (9KHz-30MHz)	FMZB1519B	014	SCHNARZBECK	2024/6/17	2025/6/16
Amplifier (9KHz-30MHz)	CVP 9222 C	00109	SCHNARZBECK	2024/6/17	2025/6/16
MXG Signal Analyzer	N9020A	101178	RS	2024/6/17	2025/6/16
MXG Vector Signal Generator	N5182A	MY50510202	Agilent	2024/6/17	2025/6/16
MXG Analog Signal Generator	N5181A	00374	SCHWARZBECK	2024/6/17	2025/6/16
Power Sensor	TR1029-2	00473	SCHNARZBECK	2024/6/17	2025/6/16
RF Swith	TR1029-1	02622	SCHNARZBECK	2024/6/17	2025/6/16
Cable	DA800-4000MM	NA	DA	2024/6/17	2025/6/16
Cable	DA800-11000MM	NA	DA	2024/6/17	2025/6/16

Other

Item	Name	Manufacturer	Model	Software version
1	EMC Conduction Test System	AUDIX	e3	6.120718
2	EMC radiation test system	AUDIX	e3	6.120718
3	RF test system	TACHOY	RFTest	V1.0.0
4	RF communication test system	TACHOY	RFTest	V1.0.0

5.2 Measurement Uncertainty

Parameter	Uncertainty
RF output power, conducted	±1.0dB
Power Spectral Density, conducted	±2.2dB
Radio Frequency	± 1 x 10 ⁻⁶
Bandwidth	± 1.5 x 10 ⁻⁶
Time	±2%
Duty Cycle	±2%
Temperature	±1°C
Humidity	±5%
DC and low frequency voltages	±3%
Conducted Emissions (150kHz~30MHz)	±3.64dB
Radiated Emission(30MHz~1GHz)	±5.03dB
Radiated Emission(1GHz~25GHz)	±4.74dB

5.3 Description of Support Units

The EUT has been tested as an independent unit together with other necessary accessories or support units. The following support units or accessories were used to form a representative test configuration during the tests.

Item	Equipment	Mfr/Brand	Model/Type No.	Series No.	Note
E-1	CREATIVE REFERENCE SUBWOOFER WITH BLUETOOTH		CR8SBT	N/A	EUT
E-2	Notebook	lenovo	B40-80	MP07F6JD	Auxiliary

Note:

- (1) The support equipment was authorized by Declaration of Confirmation.
- (2) For detachable type I/O cable should be specified the length in cm in 『Length』 column.

6 Conducted Emission

Test Requirement: : FCC CFR 47 Part 15 Section 15.207& RSS-Gen [8.8]
Test Method: : ANSI C63.10:2013
Test Result: : PASS
Frequency Range: : 150kHz to 30MHz
Class/Severity: : Class B
Detector: : Peak for pre-scan (9kHz Resolution Bandwidth)

6.1 E.U.T. Operation

Operating Environment :

Temperature: : 23.2°C
Humidity: : 51 % RH
Atmospheric Pressure: : 101.12 kPa
Test Voltage : AC 120V/60Hz

6.2 EUT Setup

The conducted emission tests were performed using the setup accordance with the ANSI C63.10: 2013

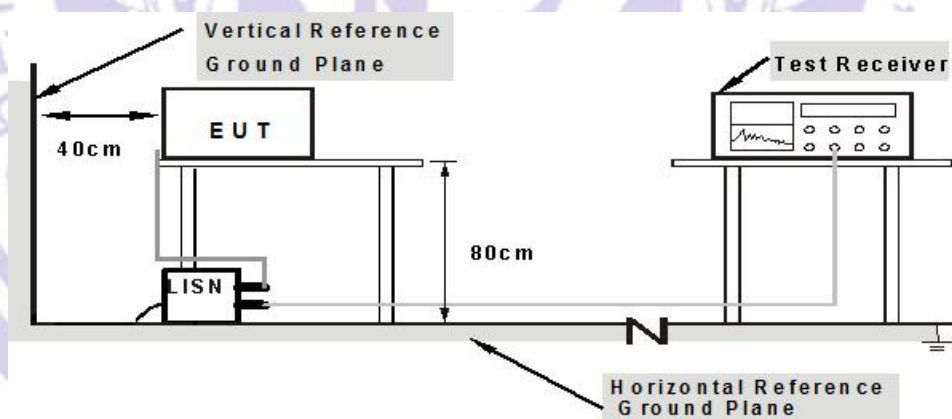

**Note: 1.Support units were connected to second LISN.
2.Both of LISNs (AMN) are 80 cm from EUT and at least 80 from other units and other metal planes**

6.3 Test SET-UP (Block Diagram of Configuration)

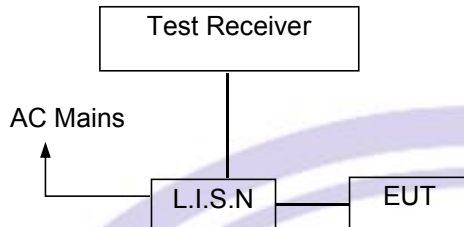

6.4 Measurement Procedure:

1. The EUT was placed on a table, which is 0.8m above ground plane.
2. Maximum procedure was performed on the six highest emissions to ensure EUT compliance.
3. Repeat above procedures until all frequency measured was complete.

6.5 Conducted Emission Limit

Conducted Emission

Frequency(MHz)	Quasi-peak	Average
0.15-0.5	66-56	56-46
0.5-5.0	56	46
5.0-30.0	60	50

Note:

1. The lower limit shall apply at the transition frequencies
2. The limit decreases in line with the logarithm of the frequency in the range of 0.15 to 0.50MHz.

6.6 Measurement Description

The maximised peak emissions from the EUT was scanned and measured for both the Live and Neutral Lines. Quasi-peak & average measurements were performed if peak emissions were within 6dB of the average limit line.

6.7 Conducted Emission Test Result

Pass

Conducted emission at both 120V & 240V is assessed, and emission at 120V represents the worst case. All the modulation modes were tested the data of the worst mode (8DPSK) are recorded in the following pages and the others modulation methods do not exceed the limits.

Channel:	Low	Phase :	L
Model:	CR8SBT		

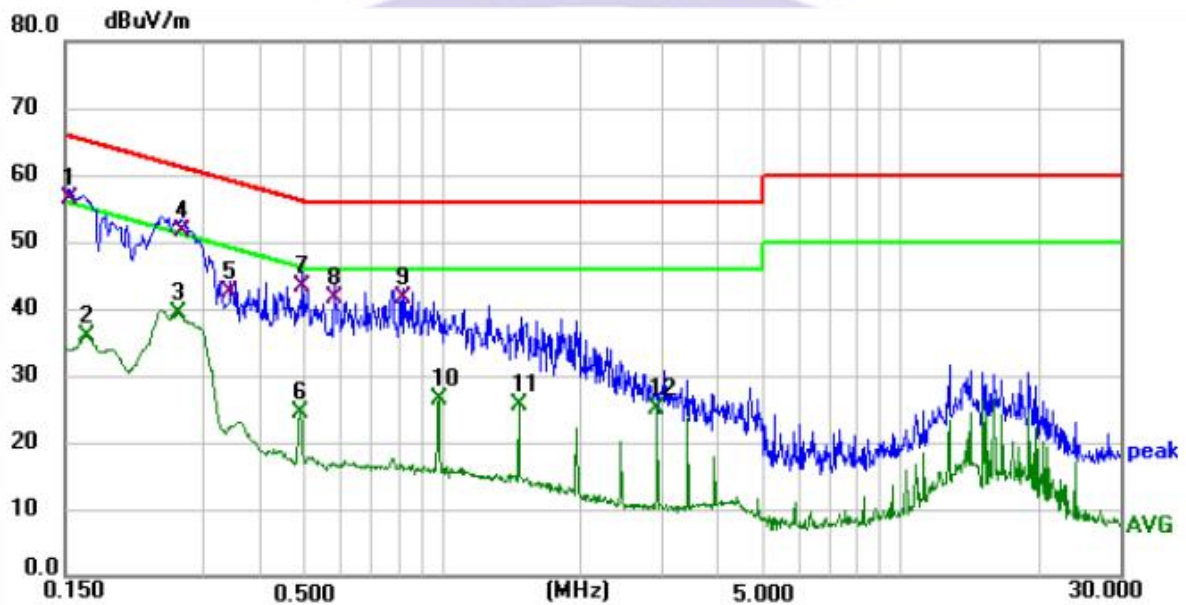

No.	Frequency (MHz)	Reading (dBuV)	Factor (dB)	Level (dBuV/m)	Limit (dBuV/m)	Margin (dB)	Detector	P/F
1 *	0.153	46.00	10.32	56.32	65.84	-9.52	QP	P
2	0.168	25.44	10.34	35.78	55.06	-19.28	AVG	P
3	0.264	29.08	10.30	39.38	51.30	-11.92	AVG	P
4	0.270	41.17	10.30	51.47	61.12	-9.65	QP	P
5	0.345	32.29	10.24	42.53	59.08	-16.55	QP	P
6	0.489	14.21	10.10	24.31	46.18	-21.87	AVG	P
7	0.495	33.06	10.10	43.16	56.08	-12.92	QP	P
8	0.581	31.35	10.17	41.52	56.00	-14.48	QP	P
9	0.824	31.17	10.40	41.57	56.00	-14.43	QP	P
10	0.982	15.91	10.56	26.47	46.00	-19.53	AVG	P
11	1.468	15.12	10.53	25.65	46.00	-20.35	AVG	P
12	2.935	14.46	10.52	24.98	46.00	-21.02	AVG	P

Channel:	Low	Phase :	N
Model:	CR8SBT		

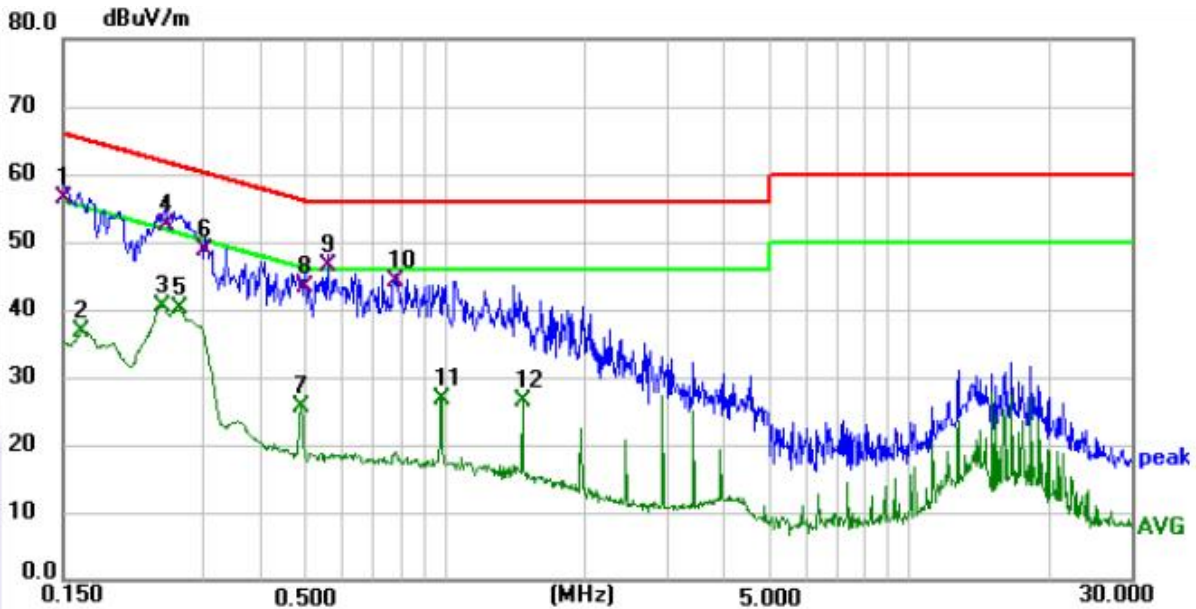

No.	Frequency (MHz)	Reading (dBuV)	Factor (dB)	Level (dBuV/m)	Limit (dBuV/m)	Margin (dB)	Detector	P/F
1	0.150	46.00	10.32	56.32	66.00	-9.68	QP	P
2	0.165	26.50	10.33	36.83	55.21	-18.38	AVG	P
3	0.246	30.12	10.32	40.44	51.89	-11.45	AVG	P
4 *	0.249	42.09	10.32	52.41	61.79	-9.38	QP	P
5	0.267	29.75	10.30	40.05	51.21	-11.16	AVG	P
6	0.303	38.36	10.27	48.63	60.16	-11.53	QP	P
7	0.489	15.38	10.10	25.48	46.18	-20.70	AVG	P
8	0.498	33.27	10.09	43.36	56.03	-12.67	QP	P
9	0.558	36.43	10.14	46.57	56.00	-9.43	QP	P
10	0.783	33.76	10.36	44.12	56.00	-11.88	QP	P
11	0.982	16.29	10.56	26.85	46.00	-19.15	AVG	P
12	1.468	16.04	10.53	26.57	46.00	-19.43	AVG	P

Notes:

1. An initial pre-scan was performed on the line and neutral lines with peak detector.
2. Quasi-Peak and Average measurement were performed at the frequencies with maximized peak emission.
3. Measurement Level = Reading level + Correct Factor

7 Radiated Spurious Emissions

Test Requirement : FCC CFR47 Part 15 Section 15.209 & 15.247& RSS-247 [5.5]
 Test Method : ANSI C63.10:2013
 Test Result : PASS
 Measurement Distance : 3m
 Limit : See the follow table

Frequency (MHz)	Field Strength		Field Strength Limit at 3m Measurement Dist	
	uV/m	Distance (m)	uV/m	dBuV/m
0.009 ~ 0.490	2400/F(kHz)	300	10000 * 2400/F(kHz)	20log ^{(2400/F(kHz))} + 80
0.490 ~ 1.705	24000/F(kHz)	30	100 * 24000/F(kHz)	20log ^{(24000/F(kHz))} + 40
1.705 ~ 30	30	30	100 * 30	20log ⁽³⁰⁾ + 40
30 ~ 88	100	3	100	20log ⁽¹⁰⁰⁾
88 ~ 216	150	3	150	20log ⁽¹⁵⁰⁾
216 ~ 960	200	3	200	20log ⁽²⁰⁰⁾
Above 960	500	3	500	20log ⁽⁵⁰⁰⁾

7.1 EUT Operation

Operating Environment :

Temperature : 24.5 °C
 Humidity : 55.5% RH
 Atmospheric Pressure : 101.3kPa
 Test Voltage : AC 120V60Hz

7.2 Test Setup

The radiated emission tests were performed in the 3m Semi- Anechoic Chamber test site

The test setup for emission measurement below 30MHz.

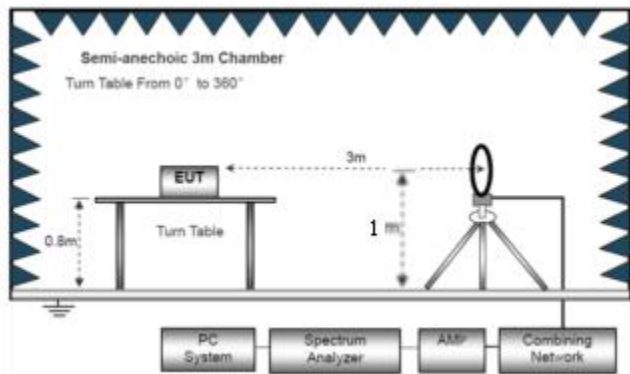

The test setup for emission measurement from 30 MHz to 1 GHz.

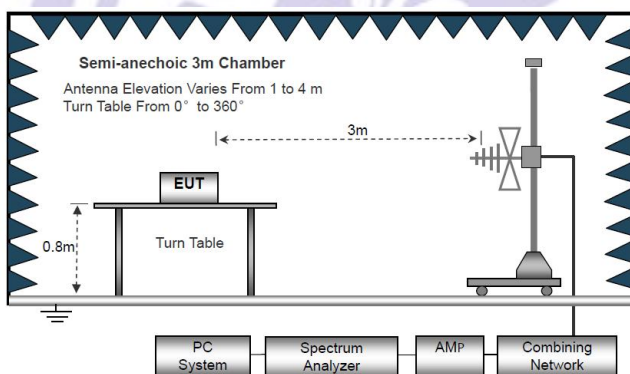

The test setup for emission measurement above 1 GHz.

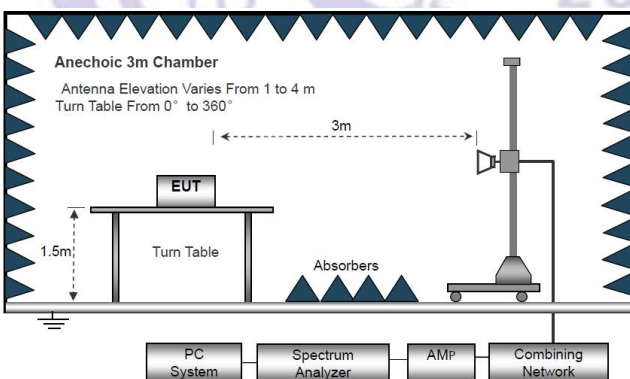

7.3 Spectrum Analyzer Setup

Spectrum Parameter	Setting
Attenuation	Auto
Start Frequency	1000 MHz
Stop Frequency	10th carrier harmonic
RB / VB (emission in restricted band)	1 MHz / 1 MHz for Peak, 1 MHz / 10Hz for Average

Receiver Parameter	Setting
Attenuation	Auto
Start ~ Stop Frequency	9kHz~150kHz / RB 200Hz for QP
Start ~ Stop Frequency	150kHz~30MHz / RB 9kHz for QP
Start ~ Stop Frequency	30MHz~1000MHz / RB 120kHz for QP

7.4 Test Procedure

1. The testing follows the guidelines in Spurious Radiated Emissions of ANSI C63.10-2013.
2. Below 1000MHz, The EUT was placed on a turn table which is 0.8m above ground plane. And above 1000MHz, The EUT was placed on a styrofoam table which is 1.5m above ground plane.
3. The EUT was set 3 meters from the interference receiving antenna, which was mounted on the top of a variable height antenna tower.
4. For each suspected emission, the EUT was arranged to its worst case and then tune the Antenna tower (From 1m to 4m) and turntable (from 0 degree to 360 degree) to find the maximum reading. A pre-amp and a high pass filter are used for the test in order to get better signal level to comply with the guidelines.
5. Set to the maximum power setting and enable the EUT transmit continuously.
6. Final measurement (Above 1GHz): The frequency range will be divided into different sub ranges depending of the frequency range of the used horn antenna. The EMI Receiver set to peak and average mode and a resolution bandwidth of 1MHz. The measurement will be performed in horizontal and vertical polarization of the measuring antenna and while rotating the EUT in its vertical axis in the range of 0 degree to 360 degree in order to have the antenna inside the cone of radiation.
7. Test Procedure of measurement (For Above 1GHz):
 - 1) Monitor the frequency range at horizontal polarization and move the antenna over all sides of the EUT(if necessary move the EUT to another orthogonal axis).
 - 2) Change the antenna polarization and repeat 1) with vertical polarization.
 - 3) Make a hardcopy of the spectrum.
 - 4) Measure the frequency of the detected emissions with a lower span and resolution bandwidth to increase the accuracy and note the frequency value.
 - 5) Change the analyser mode to Clear/ Write and found the cone of emission.
 - 6) Rotate and move the EUT, so that the measuring distance can be enlarged to 3m and the antenna will be still inside the cone of emission.
 - 7) Measure the level of the detected frequency with the correct resolution bandwidth, with the antenna polarization and azimuth and the peak and average detector, which causes the maximum emission.
 - 8) Repeat steps 1) to 7) for the next antenna spot if the EUT is larger than the antenna beamwidth.
7. The radiation measurements are tested under 3-axes(X,Y,Z) position(X denotes lying on the table, Y denotes side stand and Z denotes vertical stand), After pre-test, It was found that the worse radiation emission was get at the X position. So the data shown was the X position only.

7.5 Summary of Test Results

Test Frequency: 9KHz-30MHz

Freq. (MHz)	Ant.Pol. H/V	Emission Level (dBuV/m)	Limit 3m (dBuV/m)	Over (dB)
--	--	--	--	>20

Note:

The amplitude of spurious emission that is attenuated by more than 20dB below the permissible limit has no need to be reported.

Distance extrapolation factor = $40 \log(\text{Specific distance} / \text{test distance})$ (dB);
Limit line = Specific limits (dBuV) + distance extrapolation factor.

Test Frequency: 30MHz ~ 1GHz

Please refer to the following test plots, Low Channel (2402MHz) Worst case 8DPSK for record:

Model:	CR8SBT
--------	--------

Test plot for Horizontal

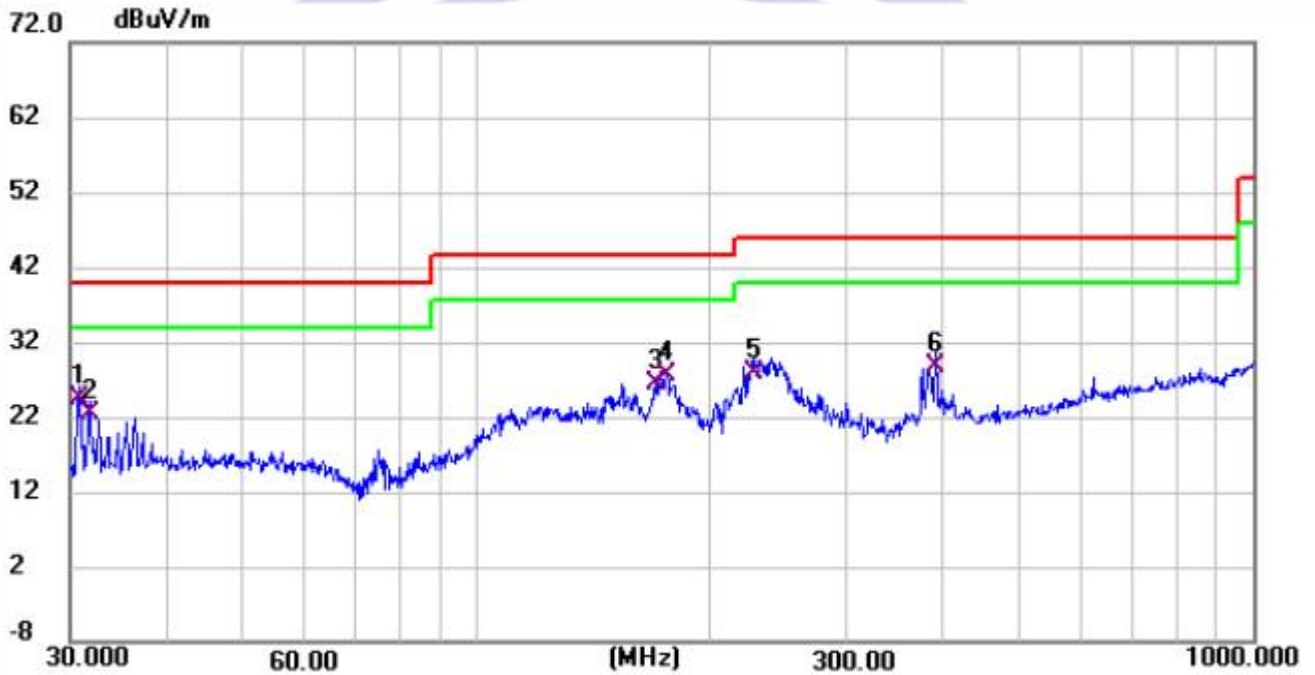

No.	Frequency (MHz)	Reading (dBuV)	Factor (dB/m)	Level (dBuV/m)	Limit (dBuV/m)	Margin (dB)	Detector
1 *	30.962	13.60	10.76	24.36	40.00	-15.64	QP
2	31.843	11.37	10.94	22.31	40.00	-17.69	QP
3	170.195	9.89	16.50	26.39	43.50	-17.11	QP
4	175.652	11.30	16.21	27.51	43.50	-15.99	QP
5	227.691	16.59	11.34	27.93	46.00	-18.07	QP
6	390.723	12.05	16.60	28.65	46.00	-17.35	QP

Remark: Emission Level = Reading + Factor

Model:	CR8SBT
--------	--------

Test plot for Vertical



No.	Frequency (MHz)	Reading (dBuV)	Factor (dB/m)	Level (dBuV/m)	Limit (dBuV/m)	Margin (dB)	Detector
1 *	34.036	11.43	11.83	23.26	40.00	-16.74	QP
2	46.178	8.53	13.98	22.51	40.00	-17.49	QP
3	109.796	3.94	16.41	20.35	43.50	-23.15	QP
4	176.888	5.64	15.83	21.47	43.50	-22.03	QP
5	381.249	7.53	13.86	21.39	46.00	-24.61	QP
6	948.761	3.92	24.02	27.94	46.00	-18.06	QP

Remark: Emission Level = Reading + Factor

Test Frequency 1GHz-25GHz

Bluetooth (GFSK, $\pi/4$ DQPSK, 8DPSK) mode have been tested, and the worst result(8DPSK) was report as below

Polar (H/V)	Frequency	Meter Reading	Pre- amplifier	Cable Loss	Antenna Factor	Emission Level	Limits	Margin	Detector Type
	(MHz)	(dBuV)	(dB)	(dB)	(dB)	(dBuV/m)	(dBuV/m)	(dB)	
Low Channel:2402MHz									
V	4804.00	50.70	34.12	5.03	32.39	54.00	74	-20.00	Pk
V	4804.00	40.09	34.12	5.03	32.39	43.39	54	-10.61	AV
V	7206.00	42.58	32.54	6.29	35.86	52.19	74	-21.81	Pk
V	7206.00	32.59	32.54	6.29	35.86	42.20	54	-11.80	AV
V	9608.00	40.76	32.98	7.55	38.4	53.73	74	-20.27	Pk
V	9608.00	29.44	32.98	7.55	38.4	42.41	54	-11.59	AV
V	12010.00	37.58	32.09	8.93	39	53.42	74	-20.58	Pk
V	12010.00	27.68	32.09	8.93	39	43.52	54	-10.48	AV
H	4804.00	51.29	34.12	5.03	32.39	54.59	74	-19.41	Pk
H	4804.00	40.52	34.12	5.03	32.39	43.82	54	-10.18	AV
H	7206.00	42.26	32.54	6.29	35.86	51.87	74	-22.13	Pk
H	7206.00	33.53	32.54	6.29	35.86	43.14	54	-10.86	AV
H	9608.00	40.94	32.98	7.55	38.4	53.91	74	-20.09	Pk
H	9608.00	31.67	32.98	7.55	38.4	44.64	54	-9.36	AV
H	12010.00	40.04	32.09	8.93	39	55.88	74	-18.12	Pk
H	12010.00	30.43	32.09	8.93	39	46.27	54	-7.73	AV

Polar (H/V)	Frequency	Meter Reading	Pre- amplifier	Cable Loss	Antenna Factor	Emission Level	Limits	Margin	Detector Type
	(MHz)	(dBuV)	(dB)	(dB)	(dB)	(dBuV/m)	(dBuV/m)	(dB)	
Middle Channel:2441MHz									
V	4882	51.39	34.07	5.09	32.59	55.00	74	-19.00	Pk
V	4882	41.23	34.07	5.09	32.59	44.84	54	-9.16	AV
V	7323	41.63	32.63	6.34	35.96	51.30	74	-22.70	Pk
V	7323	31.16	32.63	6.34	35.96	40.83	54	-13.17	AV
V	9764	41.71	32.92	7.59	38.4	54.78	74	-19.22	Pk
V	9764	32.45	32.92	7.59	38.4	45.52	54	-8.48	AV
V	12205	39.08	31.96	8.88	39.04	55.04	74	-18.96	Pk
V	12205	30.04	31.96	8.88	39.04	46.00	54	-8.00	AV
H	4882	50.33	34.07	5.09	32.59	53.94	74	-20.06	Pk
H	4882	41.74	34.07	5.09	32.59	45.35	54	-8.65	AV
H	7323	42.20	32.63	6.34	35.96	51.87	74	-22.13	Pk
H	7323	34.21	32.63	6.34	35.96	43.88	54	-10.12	AV
H	9764	42.05	32.92	7.59	38.4	55.12	74	-18.88	Pk
H	9764	30.63	32.92	7.59	38.4	43.70	54	-10.30	AV
H	12205	39.08	31.96	8.88	39.04	55.04	74	-18.96	Pk
H	12205	29.58	31.96	8.88	39.04	45.54	54	-8.46	AV

Polar (H/V)	Frequency	Meter Reading	Pre- amplifier	Cable Loss	Antenna Factor	Emission Level	Limits	Margin	Detector Type
	(MHz)	(dBuV)	(dB)	(dB)	(dB)	(dBuV/m)	(dBuV/m)	(dB)	
High Channel:2480MHz									
V	4960	50.74	34.02	5.15	32.8	54.67	74	-19.33	Pk
V	4960	39.44	34.02	5.15	32.8	43.37	54	-10.63	AV
V	7440	41.67	32.71	6.4	36.05	51.41	74	-22.59	Pk
V	7440	33.43	32.71	6.4	36.05	43.17	54	-10.83	AV
V	9920	42.66	32.86	7.62	38.4	55.82	74	-18.18	Pk
V	9920	31.69	32.86	7.62	38.4	44.85	54	-9.15	AV
V	12400	39.67	31.82	8.84	39.08	55.77	74	-18.23	Pk
V	12400	29.11	31.82	8.84	39.08	45.21	54	-8.79	AV
H	4960	50.35	34.02	5.15	32.8	54.28	74	-19.72	Pk
H	4960	41.46	34.02	5.15	32.8	45.39	54	-8.61	AV
H	7440	43.97	32.71	6.4	36.05	53.71	74	-20.29	Pk
H	7440	33.71	32.71	6.4	36.05	43.45	54	-10.55	AV
H	9920	41.35	32.86	7.62	38.4	54.51	74	-19.49	Pk
H	9920	30.77	32.86	7.62	38.4	43.93	54	-10.07	AV
H	12400	39.02	31.82	8.84	39.08	55.12	74	-18.88	Pk
H	12400	28.41	31.82	8.84	39.08	44.51	54	-9.49	AV

Note: 1. The testing has been conformed to 10*2480MHz=24800MHz.

2. All other emissions more than 30dB below the limit.

3. Factor = Antenna Factor + Cable Loss – Pre-amplifier.

Emission Level = Reading + Factor

Margin=Emission Level-Limit

Spurious Emission in Restricted Band 2310-2390MHz and 2483.5-2500MHz

Bluetooth (GFSK, $\pi/4$ DQPSK, 8DPSK)mode have been tested, and the worst result(8DPSK) was report as below

	Polar (H/V)	Frequency (MHz)	Meter Reading (dBuV)	Pre-amplifier (dB)	Cable Loss (dB)	Antenna Factor (dB/m)	Emission level (dBuV/m)	Limit (dBuV/m)	Detector Type	Result
8DPSK	Low Channel: 2402MHz									
	H	2390.00	55.48	35.17	3.48	27.49	51.28	74.00	PK	PASS
	H	2390.00	46.00	35.17	3.48	27.49	41.80	54.00	AV	PASS
	H	2400.00	55.45	35.16	3.49	27.52	51.30	74.00	PK	PASS
	H	2400.00	46.23	35.16	3.49	27.52	42.08	54.00	AV	PASS
	V	2390.00	57.13	35.17	3.48	27.49	52.93	74.00	PK	PASS
	V	2390.00	47.42	35.17	3.48	27.49	43.22	54.00	AV	PASS
	V	2400.00	56.73	35.16	3.49	27.52	52.58	74.00	PK	PASS
	V	2400.00	46.45	35.16	3.49	27.52	42.30	54.00	AV	PASS
	High Channel: 2480MHz									
	H	2483.50	55.56	35.11	3.56	27.75	51.76	74.00	PK	PASS
	H	2483.50	46.34	35.11	3.56	27.75	42.54	54.00	AV	PASS
	H	2500.00	57.08	35.1	3.57	27.8	53.35	74.00	PK	PASS
	H	2500.00	47.39	35.1	3.57	27.8	43.66	54.00	AV	PASS
	V	2483.50	56.23	35.11	3.56	27.75	52.43	74.00	PK	PASS
	V	2483.50	55.74	35.11	3.56	27.75	51.94	54.00	AV	PASS
V	2500.00	55.75	35.1	3.57	27.8	52.02	74.00	PK	PASS	
V	2500.00	45.78	35.1	3.57	27.8	42.05	54.00	AV	PASS	

Remark:

1. Emission Level = Meter Reading + Antenna Factor + Cable Loss – Pre-amplifier, Margin= Emission Level - Limit

8 Maximum Peak Output Power Test

8.1 Test Standard and Limit

Test Standard	FCC Part15 C Section 15.247 (b)(1) & RSS-247.5.4(4)
Test Limit	For frequency hopping systems operating in the 2400-2483.5 MHz band employing at least 75 non-overlapping hopping channels, and all frequency hopping systems in the 5725-5850 MHz band: 1 watt. For all other frequency hopping systems in the 2400-2483.5 MHz band: 0.125 watts.

8.2 Test Setup

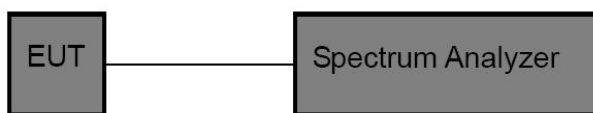

8.3 Test Procedure

1. The EUT was directly connected to the spectrum analyzer and antenna output port as show in the block diagram above,
2. Spectrum Setting:
 - RBW > the 20 dB bandwidth of the emission being measured
 - Span = approximately 5 times the 20 dB bandwidth, centered on a hopping channel
 - VBW \geq RBW
 - Sweep = auto
 - Detector function = peak
 - Trace = max hold

8.4 Test Data

Modulation	Packet Type	Channel	Peak Output Power (dBm)	Peak Output Power (mW)	Max. Avg. Power (dBm)	Limit (dBm)	Result
GFSK	DH1	0	7.737	5.939	None	30	PASS
		39	7.266	5.328	None		PASS
		78	7.164	5.205	None		PASS
$\pi/4$ DQPSK	2-DH1	0	7.990	6.295	None	20.97	PASS
		39	7.477	5.594	None		PASS
		78	7.371	5.459	None		PASS
8DPSK	3-DH1	0	8.113	6.476	None		PASS
		39	7.535	5.669	None		PASS
		78	7.501	5.625	None		PASS

Modulation	Packet Type	Channel	Peak Output Power (dBm)	Peak Power Limit (dBm)	ISED EIRP (dBm)	ISED EIRP Limit (dBm)	Max. Avg. Power (dBm)	Result
GFSK	DH1	0	7.737	≤ 30	8.057	36.02	None	PASS
		39	7.266	≤ 30	7.586	36.02	None	PASS
		78	7.164	≤ 30	7.484	36.02	None	PASS
$\pi/4$ DQPSK	2-DH1	0	7.990	≤ 20.97	8.310	36.02	None	PASS
		39	7.477	≤ 20.97	7.797	36.02	None	PASS
		78	7.371	≤ 20.97	7.691	36.02	None	PASS
8DPSK	3-DH1	0	8.113	≤ 20.97	8.433	36.02	None	PASS
		39	7.535	≤ 20.97	7.855	36.02	None	PASS
		78	7.501	≤ 20.97	7.821	36.02	None	PASS

Test plots

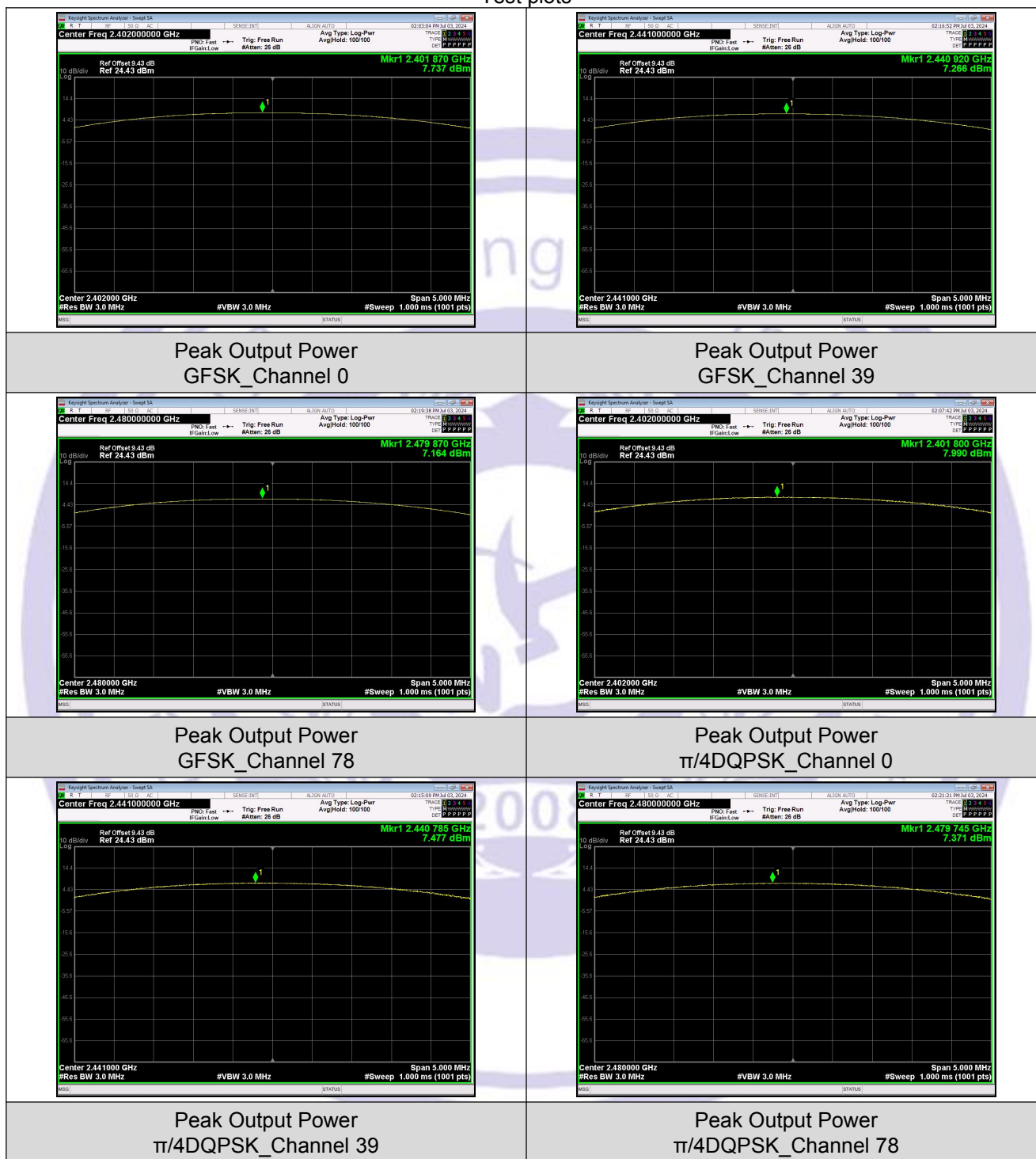

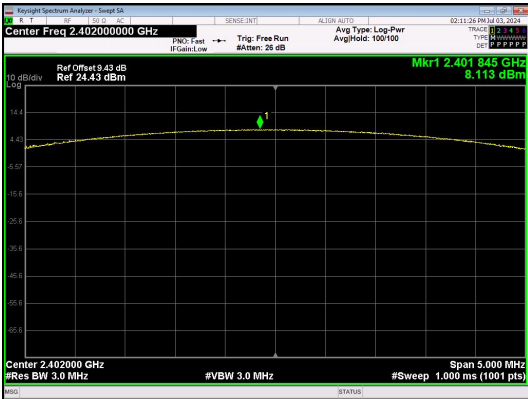

Peak Output Power
8DPSK_Channel 0

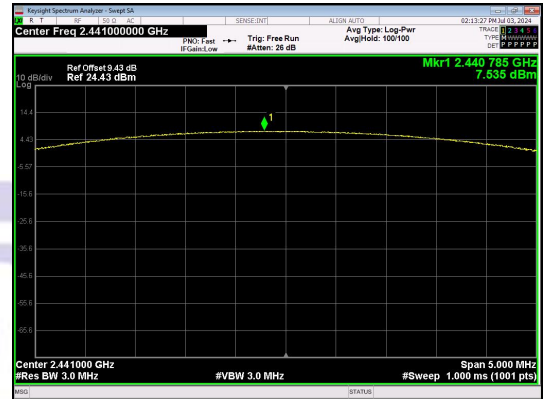

Peak Output Power
8DPSK_Channel 39

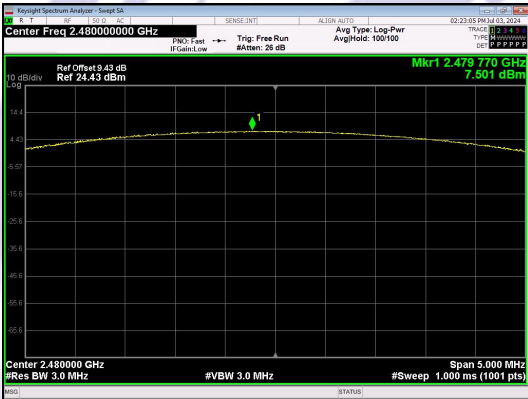

Peak Output Power
8DPSK_Channel 78

9 20DB Occupy Bandwidth & 99% OCB Test

9.1 Test Standard

Test Standard	FCC Part15 C Section 15.247 (a)(1) & RSS-247.5.1(2) RSS-Gen 6.7
---------------	---

9.2 Test Setup

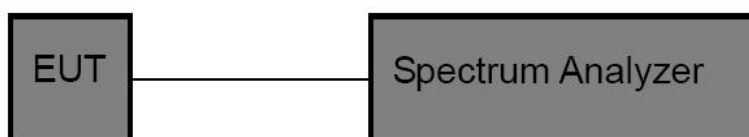

9.3 Test Procedure

Using the following spectrum analyzer settings:

1. Span= approximately 2 to 3 times the 20dB bandwidth, centered on a hopping channel.
2. Set the RBW = 30 kHz.
3. Set the VBW = 91 kHz.
4. Sweep time = auto couple.
5. Detector function = peak.
6. Trace mode = max hold.
7. Allow trace to fully stabilize.

9.4 Test Data

Mode	Test channel	20dB Emission Bandwidth (MHz)	99% Bandwidth (MHz)	Result
GFSK	Lowest	0.9992	0.88696	Pass
	Middle	0.9862	0.90947	
	Highest	0.9954	0.90451	
π /4DQPSK	Lowest	1.253	1.1941	Pass
	Middle	1.259	1.1913	
	Highest	1.267	1.1903	
8-DPSK	Lowest	1.226	1.1682	Pass
	Middle	1.240	1.1717	
	Highest	1.244	1.1805	

Test plots 20dB Emission Bandwidth

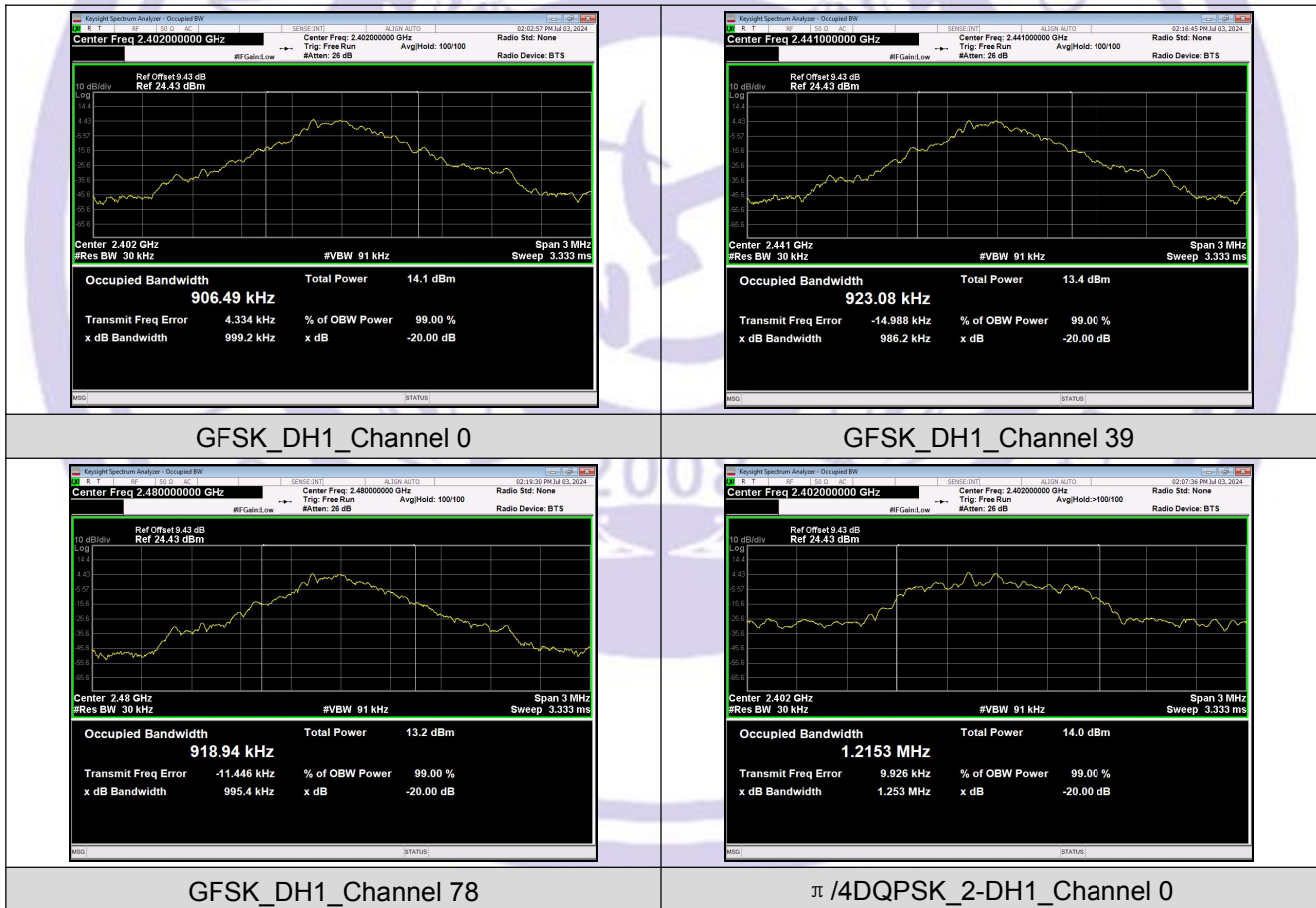

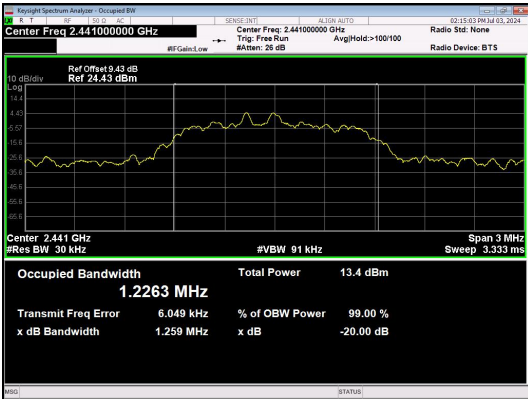

π /4DQPSK_2-DH1_Channel 39

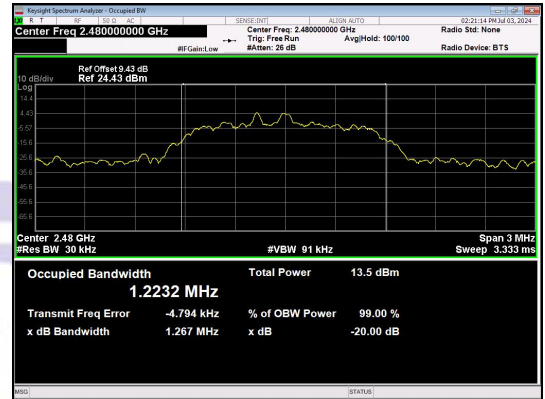

π /4DQPSK_2-DH1_Channel 78

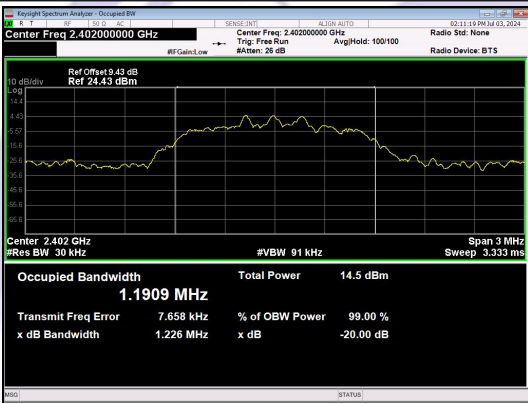

8DPSK_3-DH1_Channel 0

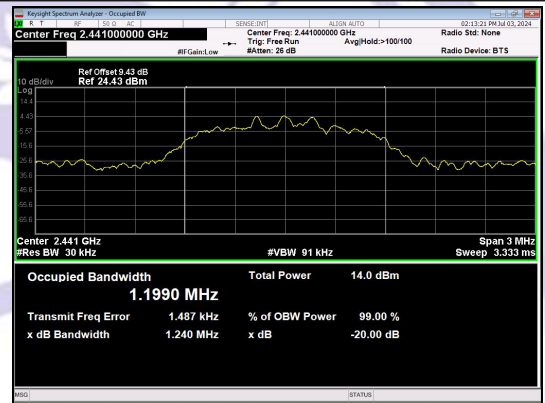

8DPSK_3-DH1_Channel 39

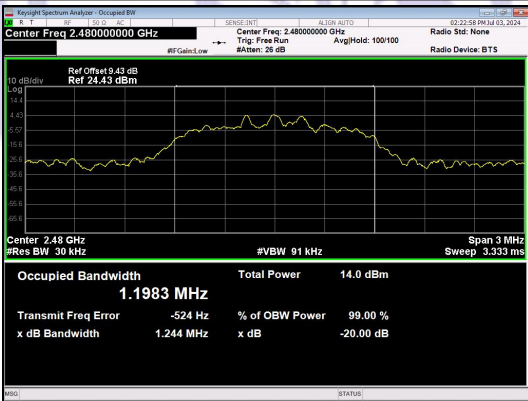

8DPSK_3-DH1_Channel 78

99% Bandwidth

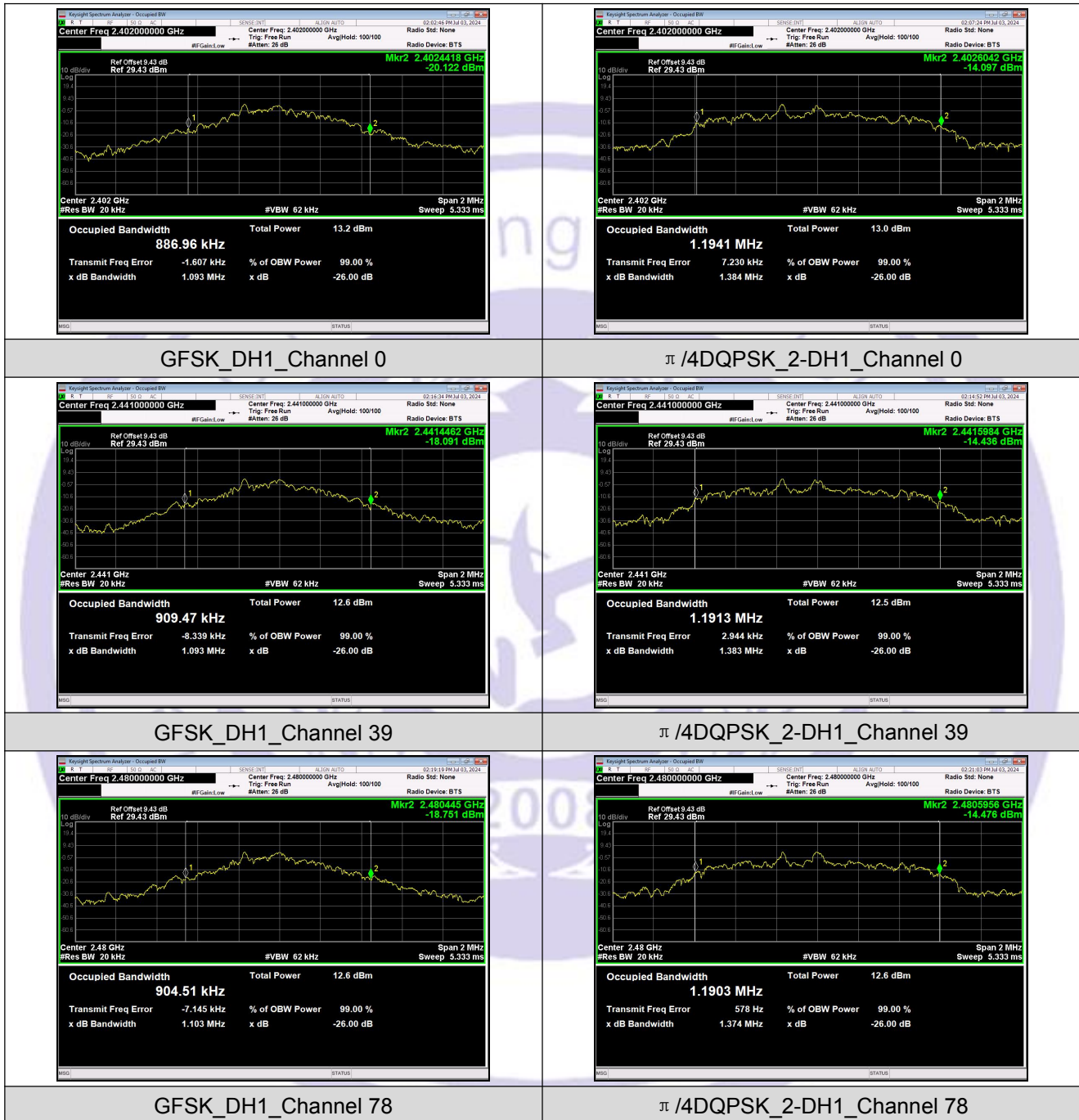

10 Carrier Frequency Separation Test

10.1 Test Standard and Limit

Test Standard	FCC Part15 C Section 15.247 (a)(1) & RSS-247.5.1(4)
Test Limit	GFSK: 20dB bandwidth π /4DQPSK & 8DPSK: 0.025MHz or 2/3 of the 20dB bandwidth (whichever is greater)

10.2 Test Setup

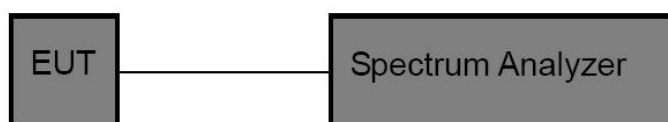

10.3 Test Procedure

The EUT must have its hopping function enabled. Using the following spectrum analyzer settings:

1. Span= Wide enough to capture the peaks of two adjacent channels
2. Set the RBW = 100 kHz.
3. Set the VBW = 300 kHz.
4. Sweep time = auto couple.
5. Detector function = peak.
6. Trace mode = max hold.
7. Allow trace to fully stabilize.

10.4 Test Data

Modulation	Separation (MHz)	Limit(MHz)	Result
GFSK	1.0114	0.999	PASS
π /4DQPSK	1.0003	0.839	PASS
8-DPSK	0.9955	0.827	PASS

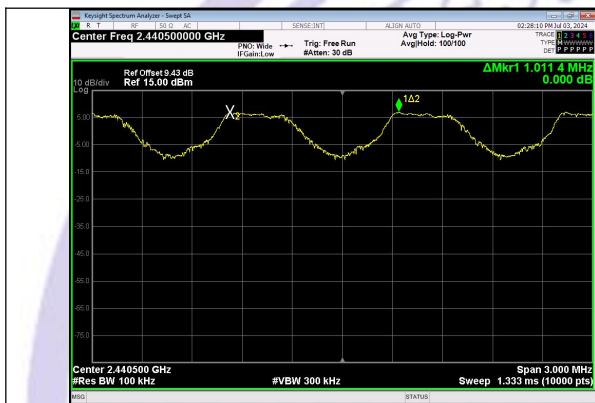

GFSK



π /4DQPSK

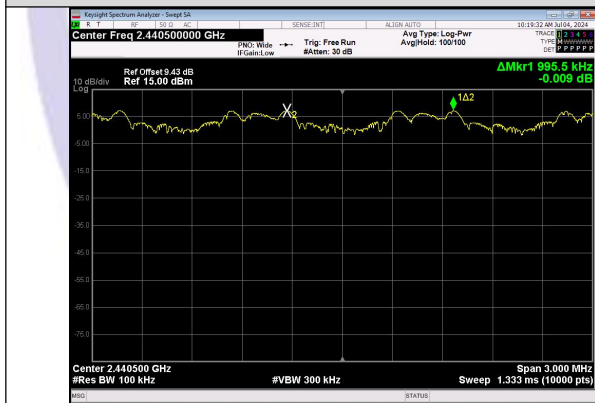

8DPSK

Void

11 Number of Hopping Channel Test

11.1 Test Standard and Limit

Test Standard	FCC Part15 C Section 15.247 (a)(1) & RSS-247.5.1(4)
Test Limit	≥15 channels

11.2 Test Setup

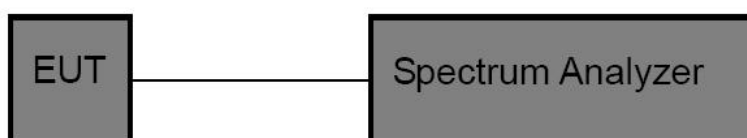

11.3 Test Procedure

The EUT must have its hopping function enabled. Using the following spectrum analyzer setting:

1. Span= the frequency band of operation
2. Set the RBW = 100kHz.
3. Set the VBW = 300kHz.
4. Sweep time = auto couple.
5. Detector function = peak.
6. Trace mode = max hold.
7. Allow trace to fully stabilize.

11.4 Test Data

Mode	Frequency (MHz)	Packet Type	Num of Hopping Frequencies		Verdict
			ANT1	Limit	
GFSK	HOPP	DH1	79	>=15	Pass
Pi/4DQPSK	HOPP	2DH1	79	>=15	Pass
8DPSK	HOPP	3DH1	79	>=15	Pass

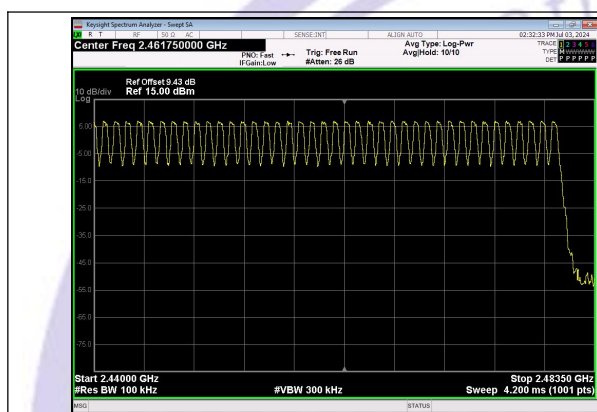

High End Spectrum Channel Hopping Plot
GFSK

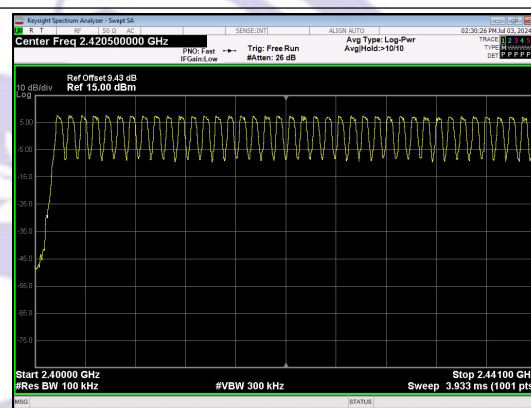

Low End Spectrum Channel Hopping Plot
GFSK

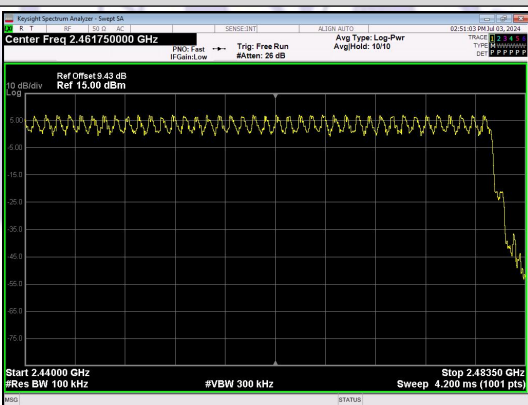

High End Spectrum Channel Hopping Plot
 $\pi/4$ DQPSK

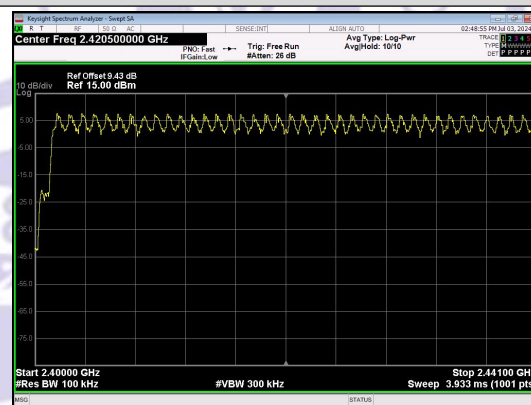

Low End Spectrum Channel Hopping Plot
 $\pi/4$ DQPSK



12 Dwell Time Test

12.1 Test Standard and Limit

Test Standard	FCC Part15 C Section 15.247 (a)(1) & RSS-247.5.1(4)
Test Limit	0.4 sec

12.2 Test Setup



12.3 Test Procedure

The EUT must have its hopping function enabled. Use the following spectrum analyzer settings:

1. Span= zero span, centered on a hopping channel
2. Set the RBW = 1 MHz.
3. Set the VBW = 3 MHz.
4. Sweep time = as necessary to capture the entire dwell time per hopping channel.
5. Detector function = peak.
6. Trace mode = max hold.
7. Allow trace to fully stabilize.

12.4 Test Data

Modulation	Packet	Channel	Pulse Width (ms)	Number of Pulses in 31.6 seconds	Dwell Time (ms)	Limit (ms)	Result
GFSK	DH5	CH0 (2402MHz)	2.880	106	305.28	< 400	PASS
	DH5	CH39 (2441MHz)	2.864	107	306.45		PASS
	DH5	CH78 (2480MHz)	2.864	107	306.45		PASS
$\pi/4$ DQPSK	2-DH5	CH0 (2402MHz)	2.880	107	308.16		PASS
	2-DH5	CH39 (2441MHz)	2.880	107	308.16		PASS
	2-DH5	CH78 (2480MHz)	2.880	107	308.16		PASS
8DPSK	3-DH5	CH0 (2402MHz)	2.880	106	305.28		PASS
	3-DH5	CH39 (2441MHz)	2.880	107	308.16		PASS
	3-DH5	CH78 (2480MHz)	2.880	108	311.04		PASS

Test Plots

