



In Collaboration with
s p e a g
CALIBRATION LABORATORY

Add: No.51 Xueyuan Road, Haidian District, Beijing, 100191, China
Tel: +86-10-62304633-2079 Fax: +86-10-62304633-2504
E-mail: cttl@chinattl.com http://www.chinattl.cn

Appendix (Additional assessments outside the scope of CNAS L0570)

Antenna Parameters with Head TSL

Impedance, transformed to feed point	52.0Ω+ 5.94jΩ
Return Loss	- 24.3dB

Antenna Parameters with Body TSL

Impedance, transformed to feed point	48.7Ω+ 6.25jΩ
Return Loss	- 23.8dB

General Antenna Parameters and Design

Electrical Delay (one direction)	1.257 ns
----------------------------------	----------

After long term use with 100W radiated power, only a slight warming of the dipole near the feedpoint can be measured.

The dipole is made of standard semirigid coaxial cable. The center conductor of the feeding line is directly connected to the second arm of the dipole. The antenna is therefore short-circuited for DC-signals. On some of the dipoles, small end caps are added to the dipole arms in order to improve matching when loaded according to the position as explained in the "Measurement Conditions" paragraph. The SAR data are not affected by this change. The overall dipole length is still according to the Standard. No excessive force must be applied to the dipole arms, because they might bend or the soldered connections near the feedpoint may be damaged.

Additional EUT Data

Manufactured by	SPEAG
-----------------	-------



In Collaboration with
s p e a g
CALIBRATION LABORATORY

Add: No.51 Xueyuan Road, Haidian District, Beijing, 100191, China
Tel: +86-10-62304633-2079 Fax: +86-10-62304633-2504
E-mail: cttl@chinattl.com http://www.chinattl.cn

DASY5 Validation Report for Head TSL

Date: 03.21.2017

Test Laboratory: CTTL, Beijing, China

DUT: Dipole 2450 MHz; Type: D2450V2; Serial: D2450V2 - SN: 952

Communication System: UID 0, CW; Frequency: 2450 MHz; Duty Cycle: 1:1

Medium parameters used: $f = 2450$ MHz; $\sigma = 1.768$ S/m; $\epsilon_r = 39.02$; $\rho = 1000$ kg/m³

Phantom section: Right Section

Measurement Standard: DASY5 (IEEE/IEC/ANSI C63.19-2007)

DASY5 Configuration:

- Probe: EX3DV4 - SN3617; ConvF(7.74, 7.74, 7.74); Calibrated: 1/23/2017;
- Sensor-Surface: 1.4mm (Mechanical Surface Detection)
- Electronics: DAE4 Sn777; Calibrated: 8/22/2016
- Phantom: Triple Flat Phantom 5.1C; Type: QD 000 P51 CA; Serial: 1161/1
- Measurement SW: DASY52, Version 52.8 (8); SEMCAD X Version 14.6.10 (7372)

Dipole Calibration/Zoom Scan (7x7x7) (7x7x7)/Cube 0: Measurement grid: dx=5mm, dy=5mm, dz=5mm

Reference Value = 104.6 V/m; Power Drift = 0.02 dB

Peak SAR (extrapolated) = 27.0 W/kg

SAR(1 g) = 13 W/kg; SAR(10 g) = 6.04 W/kg

Maximum value of SAR (measured) = 21.7 W/kg

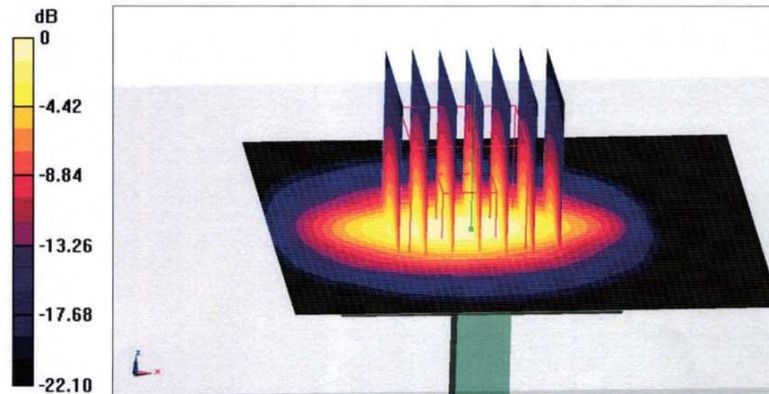
**0 dB = 21.7 W/kg = 13.36 dBW/kg**



In Collaboration with
s p e a g
CALIBRATION LABORATORY

Add: No.51 Xueyuan Road, Haidian District, Beijing, 100191, China
Tel: +86-10-62304633-2079 Fax: +86-10-62304633-2504
E-mail: cttl@chinattl.com http://www.chinattl.cn

Impedance Measurement Plot for Head TSL

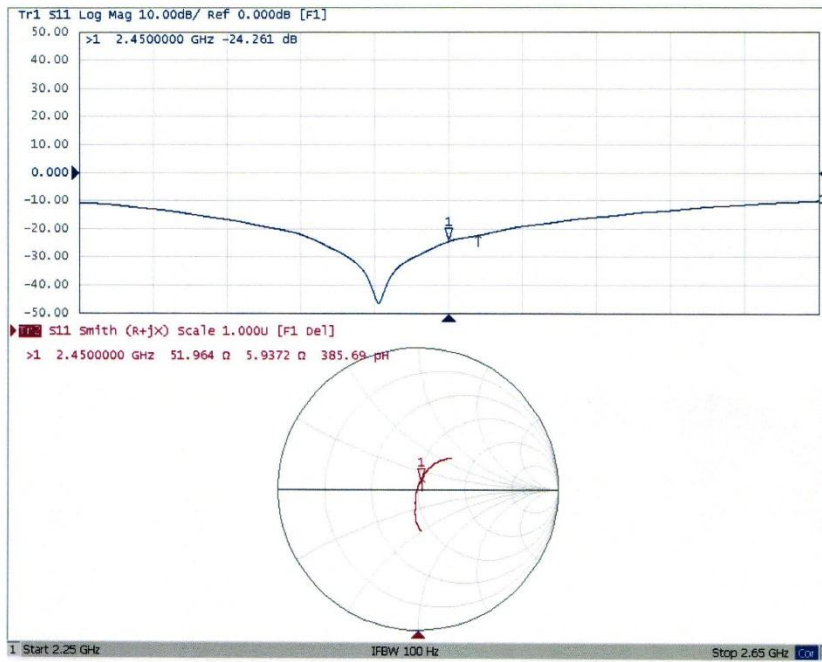



In Collaboration with
s p e a g
CALIBRATION LABORATORY

Add: No.51 Xueyuan Road, Haidian District, Beijing, 100191, China
Tel: +86-10-62304633-2079 Fax: +86-10-62304633-2504
E-mail: cttl@chinattl.com http://www.chinattl.cn

DASY5 Validation Report for Body TSL

Date: 03.21.2017

Test Laboratory: CTTL, Beijing, China

DUT: Dipole 2450 MHz; Type: D2450V2; Serial: D2450V2 - SN: 952

Communication System: UID 0, CW; Frequency: 2450 MHz; Duty Cycle: 1:1

Medium parameters used: $f = 2450$ MHz; $\sigma = 1.931$ S/m; $\epsilon_r = 52.27$; $\rho = 1000$ kg/m³

Phantom section: Center Section

Measurement Standard: DASY5 (IEEE/IEC/ANSI C63.19-2007)

DASY5 Configuration:

- Probe: EX3DV4 - SN3617; ConvF(7.8, 7.8, 7.8); Calibrated: 1/23/2017;
- Sensor-Surface: 1.4mm (Mechanical Surface Detection)
- Electronics: DAE4 Sn777; Calibrated: 8/22/2016
- Phantom: Triple Flat Phantom 5.1C; Type: QD 000 P51 CA; Serial: 1161/1
- Measurement SW: DASY52, Version 52.8 (8); SEMCAD X Version 14.6.10 (7372)

Dipole Calibration/Zoom Scan (7x7x7) (7x7x7)/Cube 0: Measurement grid: dx=5mm, dy=5mm, dz=5mm

Reference Value = 96.07 V/m; Power Drift = -0.04 dB

Peak SAR (extrapolated) = 26.4 W/kg

SAR(1 g) = 12.6 W/kg; SAR(10 g) = 5.82 W/kg

Maximum value of SAR (measured) = 20.9 W/kg

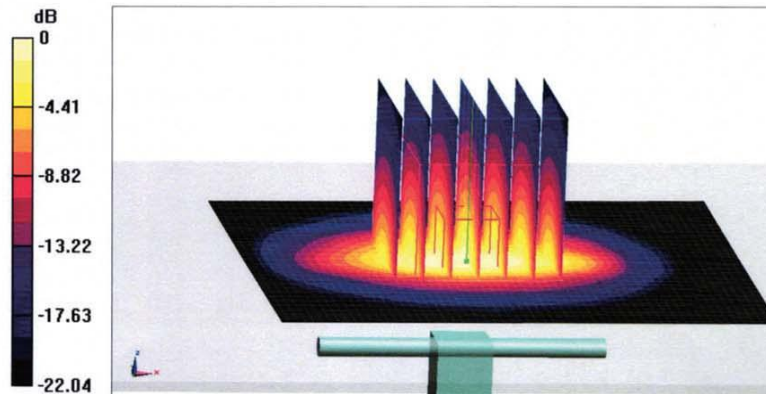

0 dB = 20.9 W/kg = 13.20 dBW/kg





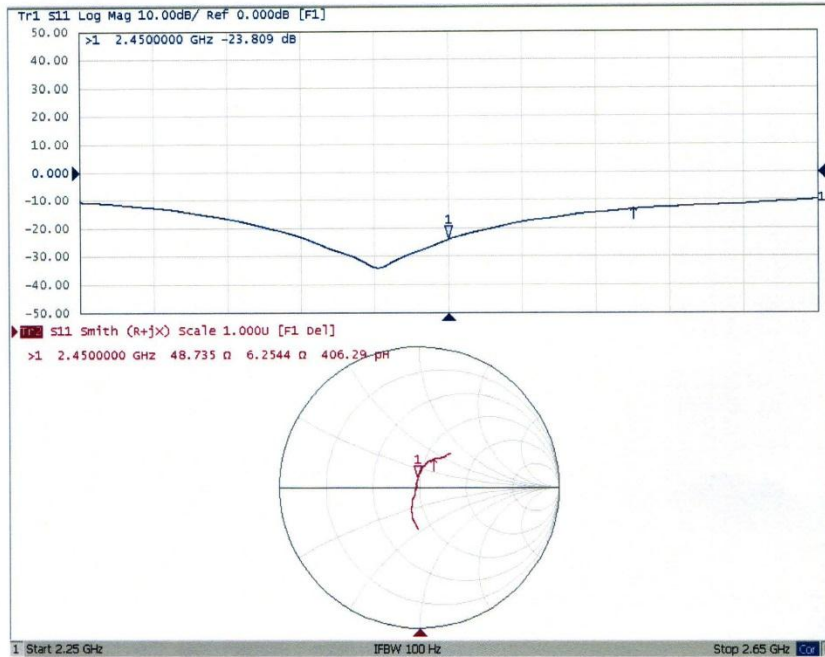

In Collaboration with
s p e a g
CALIBRATION LABORATORY

Add: No.51 Xueyuan Road, Haidian District, Beijing, 100191, China
Tel: +86-10-62304633-2079 Fax: +86-10-62304633-2504
E-mail: cttl@chinattl.com http://www.chinattl.cn

Impedance Measurement Plot for Body TSL



F.4 DASy Dipole Measurement Report

<p><i>SAR Dipole</i></p> <p>Performance Measurement Report</p>	<p>ISSUED BY Shenzhen BALUN Technology Co., Ltd. </p> <p>FOR Validation Dipoles</p>
	
<p>Tested by:  (Engineer)</p> <p>Approved by:  (Chief Engineer)</p>	<p>Report No.: LW-SZ1830061-701 EUT Type: SAR Validation Dipole Model Name: D2450V2</p> <p>Brand Name: Speag</p> <p>Test Conclusion: Pass Test Date: Mar. 16, 2018 Date of Issue: Mar. 18, 2018</p>

NOTE: This test report can be duplicated completely for the legal use with the approval of the applicant; it shall not be reproduced except in full, without the written approval of Shenzhen BALUN Technology Co., Ltd. BALUN Laboratory. Any objections should be raised within thirty days from the date of issue. To validate the report, please contact us.



1 GENERAL INFORMATION

1.1 Introduction

This document contains a summary of the requirements set forth by the IEEE 1528, FCC KDB 865664 D01 for reference dipoles used for SAR measurement system validations. Instead of the typical annual calibration recommended by measurement standards, the reference dipoles were demonstrated that the SAR target, impedance and return loss have remain stable, so the longer calibration interval is acceptable.

1.2 General Description for Equipment under Test (EUT)

EUT Type	DASY 52 Reference Dipoles
Manufacturer	Speag

Parameter	EUT 1
Model	D2450V2
Frequency	2450 MHz
Serial Number	SN 952
Product Condition (New/ Used)	Used
Last Cal. Date	2017/03/21
Current meas. Date	2018/03/16



1.3 Test Equipment List

Description	Manufacturer	Model	Serial No.	Cal. Date	Cal. Due
PC	Dell	N/A	N/A	N/A	N/A
E-Field Probe	Speag	ES3DV3	SN: 3110	2017/08/02	2018/08/01
Data Acquisition Electronics	Speag	DAE4	SN: 685	2017/08/02	2018/08/01
Signal Generator	R&S	SMBV100A	260592	2017/06/12	2018/06/11
Power Meter	Agilent	E4419B	GB40201833	2017/11/02	2018/11/01
Power Sensor	Agilent	E9300A	MY41498012	2017/11/02	2018/11/01
Power Sensor	Agilent	E9300A	MY41499891	2017/11/02	2018/11/01
Power Amplifier	SATIMO	6552B	22374	2017/06/12	2018/06/11
Network Analyzer	R&S	ZVL-6	101380	2017/06/12	2018/06/11
Thermometer	Elitech	RC-4HC	N/A	2017/11/13	2018/11/12
Dielectric Probe Kit	SATIMO	SCLMP	SN 25/13 OCPG56	N/A	N/A
Phantom1	Speag	SAM	SN: 1859	N/A	N/A
Phantom2	Speag	SAM	SN: 1857	N/A	N/A
Attenuator	COM-MW	ZA-S1-31	1305003187	N/A	N/A
Directional coupler	AA-MCS	AAMCS-UDC	000272	N/A	N/A



1.4 EUT Photos





2 SIMULATING LIQUID VERIFICATION

Liquid Type	Fre. (MHz)	Meas. Conductivity (σ) (S/m)	Meas. Permittivity (ϵ)	Target Conductivity (σ) (S/m)	Target Permittivity (ϵ)	Conductivity Tolerance (%)	Permittivity Tolerance (%)
Head	2450	1.84	38.94	1.80	39.20	2.22	-0.66
Body	2450	1.93	50.88	1.95	52.70	-1.03	-3.45



3 DIPOLE IMPEDANCE AND RETURN LOSS

The dipoles are designed to have low return loss when presented against a flat phantom at the specified distance. A Vector Network Analyser was used to perform a return loss measurement on the specific dipole when in the measurement location against the phantom and the distance was specified by the manufacturer with a special, low loss and low relative permittivity spacer.

The impedance was measured at the SMA-connector with the network analyser.

The measurement of verification with return loss should not deviate by more than 20% and minimum of 20 dB of the return loss, and the impedance (real or imaginary parts) should not deviate by more than 5 Ohms from the previous measurement using network analyzer.

Note:

The "Previous Meas." in the following table refer to dipoles or other equivalent RF sources calibration reports.



3.1 D2450V2

RETURN LOSS AND IMPEDANCE IN HEAD LIQUID

Meas. Results	Current Meas.	Previous Meas.	Max. Deviation
Return Loss (dB)	-28.271	-24.261	16.5%
Impedance	49.7 Ω + 1.669 jΩ	52.0 Ω + 5.937 jΩ	4.268Ω (Imaginary part)

Return Loss

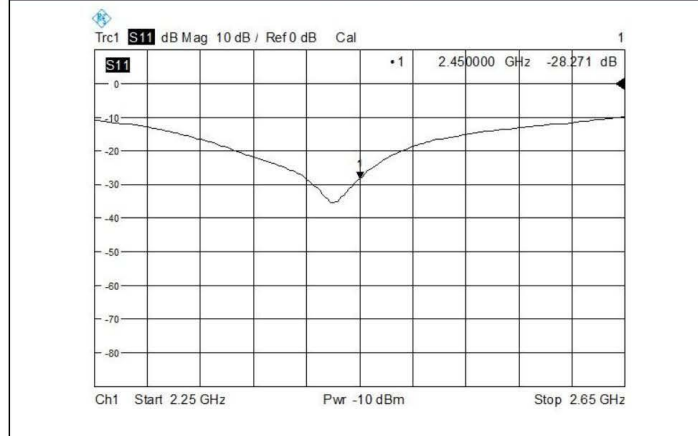

Impedance

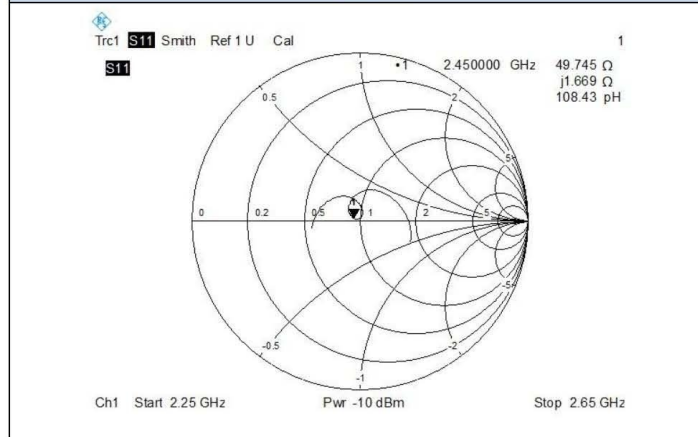



RETURN LOSS AND IMPEDANCE IN BODY LIQUID

Meas. Results	Current Meas.	Previous Meas.	Max. Deviation
Return Loss (dB)	-27.205	-23.809	14.3%
Impedance	46.8 Ω + 1.658 jΩ	48.7 Ω +6.254 jΩ	4.596Ω (Imaginary part)

Return Loss

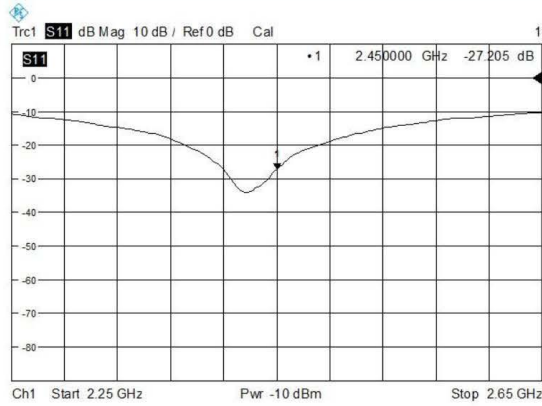

+Impedance

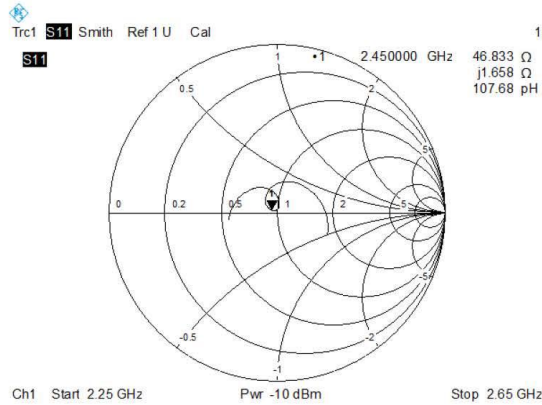



4 VALIDATION MEASUREMENT

The IEEE Std. 1528, FCC KDBs and CEI/IEC 62209 standards state that the system validation measurements must be performed using a reference dipole meeting the fore mentioned return loss and mechanical dimension requirements. The validation measurement must be performed against a liquid filled flat phantom, with the phantom constructed as outlined in the fore mentioned standards. Per the standards, the dipole shall be positioned below the bottom of the phantom, with the dipole length centered and parallel to the longest dimension of the flat phantom, with the top surface of the dipole at the described distance from the bottom surface of the phantom.

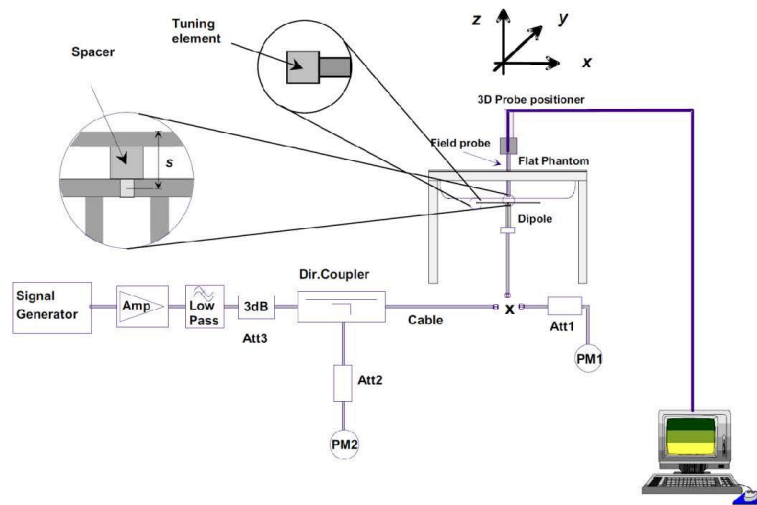



4.1 Dipole SAR Validation Measurement Result

Freq. (MHz)	Liquid Type	Power (mW)	1 g Measured SAR (W/kg)	Normalized SAR (W/kg)	10 g Measured SAR (W/kg)	Normalized SAR (W/kg)	1 g Targeted SAR (W/kg)	Tolerance (%)	10 g Targeted SAR (W/kg)	Tolerance (%)
2450	Head	100	5.390	54.39	2.380	23.80	52.40	2.86	24.00	-0.83
	Body	100	5.310	53.10	2.290	22.90	52.40	1.34	24.00	-4.58



4.2 D2450V2

4.2.1 Dipole 2450 MHz Validation Measurement for Head Tissue

Dipole 2450 MHz; Type: D2450V2; Serial: D2450V2-SN: 952

Date/Time: 03/16/2018

Communication System Band: CD2450 (2450.0 MHz); Frequency: 2450 MHz; Duty Cycle: 1:1

Medium parameters used: $f = 2450$ MHz; $\sigma = 1.84$ S/m; $\epsilon_r = 38.94$; $\rho = 1000$ kg/m³

Phantom section: Flat Section

Ambient Temperature: 22.5 Liquid Temperature: 21.3

DASY5 Configuration:

- Probe: ES3DV3 - SN3110; ConvF(4.4, 4.4, 4.4);
- Sensor-Surface: 4mm (Mechanical Surface Detection)
- Electronics: DAE4 Sn685;
- Phantom: SAM (30deg probe tilt) with CRP v5.0 Right 1857; Type: QD000P40CD; Serial: TP1857
- Measurement SW: DASY52, Version 52.8 (8); SEMCAD X Version 14.6.10 (7331)

Dipole validation measurement for Head Tissue/Pin= 100mW ,d=10mm /Zoom

Scan (7x7x7)/Cube 0: Measurement grid: dx=5mm, dy=5mm, dz=5mm

Reference Value = 54.28 V/m; Power Drift = 0.07 dB

Peak SAR (extrapolated) = 11.8 W/kg

SAR(1 g) = 5.39 W/kg; SAR(10 g) = 2.38 W/kg

Maximum value of SAR (measured) = 6.21 W/kg

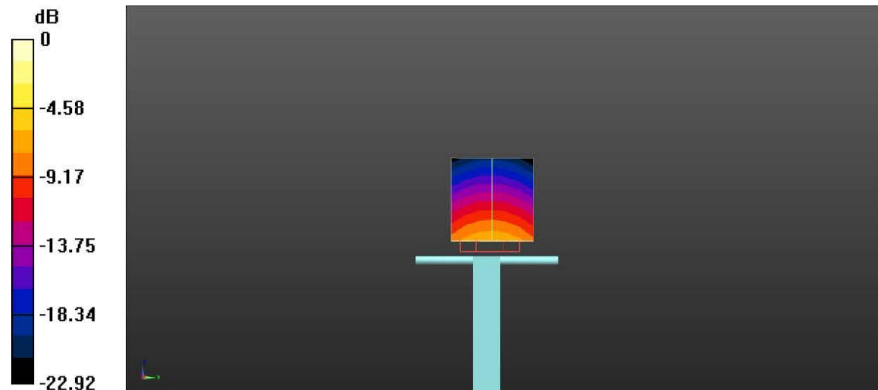

0 dB = 6.21 W/kg



4.2.2 Dipole 2450 MHz Validation Measurement for Body Tissue

Dipole 2450 MHz; Type: D2450V2; Serial: D2450V2-SN: 952

Date/Time: 03/16/2018

Communication System Band: D2450 (2450.0 MHz); Frequency: 2450 MHz; Duty Cycle: 1:1

Medium parameters used: $f = 2450$ MHz; $\sigma = 1.93$ S/m; $\epsilon_r = 50.88$; $\rho = 1000$ kg/m³

Phantom section: Flat Section

Ambient Temperature: 22.5 Liquid Temperature: 21.3

DASY5 Configuration:

- Probe: ES3DV3 - SN3110; ConvF(4.23, 4.23, 4.23);
- Sensor-Surface: 4mm (Mechanical Surface Detection)
- Electronics: DAE4 Sn685;
- Phantom: SAM (30deg probe tilt) with CRP v5.0 on left 1859; Type: QD000P40CD; Serial: TP1859
- Measurement SW: DASY52, Version 52.8 (8); SEMCAD X Version 14.6.10 (7331)

Dipole validation measurement for Body Tissue/Pin= 100mW ,d=10mm /Zoom

Scan (7x7x7)/Cube 0: Measurement grid: dx=5mm, dy=5mm, dz=5mm

Reference Value = 49.11 V/m; Power Drift = -0.04 dB

Peak SAR (extrapolated) = 10.9 W/kg

SAR(1 g) = 5.31 W/kg; SAR(10 g) = 2.29 W/kg

Maximum value of SAR (measured) = 5.92 W/kg

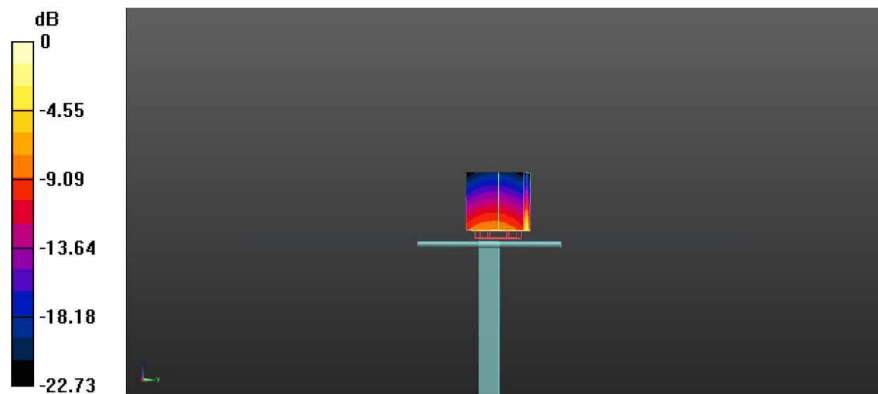

0 dB = 5.92 W/kg

--END OF REPORT--

--END OF REPORT--