

APPLICATION CERTIFICATION FCC Part 15C
On Behalf of
CLEVER BRIGHT INTERNATIONAL (H.K.) LTD.

Chroma Beats Color Changing LED Speaker
Model No.: CB-335115, CB-335121, CB-335122, 74378

FCC ID: 2AD42-CB-335115

Prepared for : CLEVER BRIGHT INTERNATIONAL (H.K.) LTD.
Address : Rm 1701, Zhuoyue Building, Fuhua Yi Rd. Futian
Central Zone, Shenzhen, China

Prepared by : ACCURATE TECHNOLOGY CO., LTD
Address : F1, Bldg. A, Chan Yuan New Material Port, Keyuan
Rd. Science & Industry Park, Nan Shan, Shenzhen,
Guangdong P.R. China

Tel: (0755) 26503290
Fax: (0755) 26503396

Report No. : ATE20162567
Date of Test : December 7-19, 2016
Date of Report : December 28, 2016

TABLE OF CONTENTS

Description	Page
Test Report Certification	
1. GENERAL INFORMATION	5
1.1. Description of Device (EUT).....	5
1.2. Channel List.....	5
1.3. Accessory and Auxiliary Equipment.....	6
1.4. Description of Test Facility	7
1.5. Measurement Uncertainty.....	7
2. MEASURING DEVICE AND TEST EQUIPMENT	8
3. OPERATION OF EUT DURING TESTING	9
3.1. Operating Mode.....	9
3.2. Configuration and peripherals	9
4. TEST PROCEDURES AND RESULTS	10
5. 20DB BANDWIDTH TEST.....	11
5.1. Block Diagram of Test Setup.....	11
5.2. The Requirement For Section 15.247(a)(1).....	11
5.3. EUT Configuration on Measurement	11
5.4. Operating Condition of EUT	11
5.5. Test Procedure	11
5.6. Test Result	12
6. CARRIER FREQUENCY SEPARATION TEST.....	15
6.1. Block Diagram of Test Setup.....	15
6.2. The Requirement For Section 15.247(a)(1).....	15
6.3. EUT Configuration on Measurement	15
6.4. Operating Condition of EUT	15
6.5. Test Procedure	16
6.6. Test Result	16
7. NUMBER OF HOPPING FREQUENCY TEST	19
7.1. Block Diagram of Test Setup.....	19
7.2. The Requirement For Section 15.247(a)(1)(iii).....	19
7.3. EUT Configuration on Measurement	19
7.4. Operating Condition of EUT	19
7.5. Test Procedure	19
7.6. Test Result	20
8. DWELL TIME TEST	21
8.1. Block Diagram of Test Setup.....	21
8.2. The Requirement For Section 15.247(a)(1)(iii).....	21
8.3. EUT Configuration on Measurement	21
8.4. Operating Condition of EUT	21
8.5. Test Procedure	21
8.6. Test Result	22
9. MAXIMUM PEAK OUTPUT POWER TEST	27
9.1. Block Diagram of Test Setup.....	27
9.2. The Requirement For Section 15.247(b)(1).....	27
9.3. EUT Configuration on Measurement	27
9.4. Operating Condition of EUT	27

9.5.	Test Procedure	27
9.6.	Test Result	28
10.	RADIATED EMISSION TEST	30
10.1.	Block Diagram of Test Setup.....	30
10.2.	The Limit For Section 15.247(d)	31
10.3.	Restricted bands of operation	32
10.4.	Configuration of EUT on Measurement	32
10.5.	Test Procedure	33
10.6.	The Field Strength of Radiation Emission Measurement Results	33
11.	BAND EDGE COMPLIANCE TEST	46
11.1.	Block Diagram of Test Setup.....	46
11.2.	The Requirement For Section 15.247(d)	46
11.3.	EUT Configuration on Measurement	46
11.4.	Operating Condition of EUT	46
11.5.	Test Procedure	47
11.6.	Test Result	47
12.	AC POWER LINE CONDUCTED EMISSION FOR FCC PART 15 SECTION 15.207(A) ..	56
12.1.	Block Diagram of Test Setup.....	56
12.2.	Power Line Conducted Emission Measurement Limits.....	56
12.3.	Configuration of EUT on Measurement	56
12.4.	Operating Condition of EUT	56
12.5.	Test Procedure	57
12.6.	Power Line Conducted Emission Measurement Results	57
13.	ANTENNA REQUIREMENT.....	64
13.1.	The Requirement	64
13.2.	Antenna Construction	64
14.	PHOTOGRAPHS.....	65
14.1.	Photo of Power Line Conducted Emission Measurement	65
14.2.	Photo of Radiation Emission Measurement.....	65
14.3.	Photo of EUT	67

Test Report Certification

Applicant : CLEVER BRIGHT INTERNATIONAL (H.K.) LTD.
Manufacturer : CLEVER BRIGHT INTERNATIONAL (H.K.) LTD.
EUT Description : Chroma Beats Color Changing LED Speaker
Model No. : CB-335115, CB-335121, CB-335122, 74378
Trade Mark : N/A

Measurement Procedure Used:

FCC Rules and Regulations Part 15 Subpart C Section 15.247: 2016
ANSI C63.10: 2013

The device described above is tested by ACCURATE TECHNOLOGY CO. LTD to determine the maximum emission levels emanating from the device. The maximum emission levels are compared to the FCC Part 15 Subpart C Section 15.247 limits. The measurement results are contained in this test report and ACCURATE TECHNOLOGY CO. LTD is assumed full responsibility for the accuracy and completeness of these measurements. Also, this report shows that the Equipment Under Test (EUT) is to be technically compliant with the FCC requirements.

This report applies to above tested sample only. This report shall not be reproduced in part without written approval of ACCURATE TECHNOLOGY CO. LTD.

Date of Test : December 7-19, 2016
Date of Report: December 28, 2016

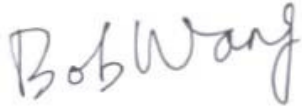
Prepared by : 
(Bob Wang, Engineer)

Approved & Authorized Signer : 
(Sean Liu, Manager)

1. GENERAL INFORMATION

1.1. Description of Device (EUT)

EUT	:	Chroma Beats Color Changing LED Speaker
Model Number	:	CB-335115, CB-335121, CB-335122, 74378 (Note: We hereby state that these models are identical in interior structure, electrical circuits and components, and just model names are different for the marketing requirement. Therefore only model CB-335115 is tested for EMC tests.)
Trade Mark	:	N/A
Bluetooth version	:	BT 2.1
Frequency Range	:	2402MHz-2480MHz
Number of Channels	:	79
Antenna Gain	:	0dBi
Antenna type	:	Integral Antenna
Power Supply	:	DC 3.7V & DC 5V(Power by USB port)
Modulation mode	:	GFSK
Applicant	:	CLEVER BRIGHT INTERNATIONAL (H.K.) LTD.
Address	:	Rm 1701, Zhuoyue Building, Fuhua Yi Rd. Futian Central Zone, Shenzhen, China
Manufacuter	:	CLEVER BRIGHT INTERNATIONAL (H.K.) LTD.
Address	:	Rm 1701, Zhuoyue Building, Fuhua Yi Rd. Futian Central Zone, Shenzhen, China
Date of sample received	:	December 5, 2016
Date of Test	:	December 7-19, 2016

1.2. Channel List

2402 2403 2404 2405 2406 2407 2408 2409 2410
2411 2412 2413 2414 2415 2416 2417 2418 2419
2420 2421 2422 2423 2424 2425 2426 2427 2428
2429 2430 2431 2432 2433 2434 2435 2436 2437
2438 2439 2440 2441 2442 2443 2444 2445 2446
2447 2448 2449 2450 2451 2452 2453 2454 2455
2456 2457 2458 2459 2460 2461 2462 2463 2464
2465 2466 2467 2468 2469 2470 2471 2472 2473
2474 2475 2476 2477 2478 2479 2480 (MHz)

1.3. Accessory and Auxiliary Equipment

PC : Manufacturer: DELL
M/N: DMC
S/N: HZXLM1

1.4. Description of Test Facility

EMC Lab	:	Accredited by TUV Rheinland Shenzhen
		Listed by FCC The Registration Number is 752051
		Listed by Industry Canada The Registration Number is 5077A-2
		Accredited by China National Accreditation Committee for Laboratories The Certificate Registration Number is L3193
Name of Firm	:	ACCURATE TECHNOLOGY CO. LTD
Site Location	:	F1, Bldg. A, Changyuan New Material Port, Keyuan Rd. Science & Industry Park, Nanshan, Shenzhen, Guangdong P.R. China

1.5. Measurement Uncertainty

Conducted Emission Expanded Uncertainty	=	2.23dB, k=2
Radiated emission expanded uncertainty (9kHz-30MHz)	=	3.08dB, k=2
Radiated emission expanded uncertainty (30MHz-1000MHz)	=	4.42dB, k=2
Radiated emission expanded uncertainty (Above 1GHz)	=	4.06dB, k=2

2. MEASURING DEVICE AND TEST EQUIPMENT

Table 1: List of Test and Measurement Equipment

Kind of equipment	Manufacturer	Type	S/N	Calibrated dates	Calibrated until
EMI Test Receiver	Rohde&Schwarz	ESCS30	100307	Jan. 9, 2016	Jan. 09, 2017
EMI Test Receiver	Rohde&Schwarz	ESPI3	101526/003	Jan. 9, 2016	Jan. 09, 2017
Spectrum Analyzer	Agilent	E7405A	MY45115511	Jan. 9, 2016	Jan. 09, 2017
Pre-Amplifier	Rohde&Schwarz	CBLU118354 0-01	3791	Jan. 9, 2016	Jan. 09, 2017
Loop Antenna	Schwarzbeck	FMZB1516	1516131	Jan. 14, 2016	Jan. 13, 2017
Bilog Antenna	Schwarzbeck	VULB9163	9163-323	Jan. 14, 2016	Jan. 13, 2017
Horn Antenna	Schwarzbeck	BBHA9120D	9120D-655	Jan. 14, 2016	Jan. 12, 2017
Horn Antenna	Schwarzbeck	BBHA9170	9170-359	Jan. 14, 2016	Jan. 13, 2017
LISN	Rohde&Schwarz	ESH3-Z5	100305	Jan. 9, 2016	Jan. 09, 2017
LISN	Schwarzbeck	NSLK8126	8126431	Jan. 9, 2016	Jan. 09, 2017
Highpass Filter	Wainwright Instruments	WHKX3.6/18 G-10SS	N/A	Jan. 9, 2016	Jan. 09, 2017
Band Reject Filter	Wainwright Instruments	WRCG2400/2 485-2375/2510 -60/11SS	N/A	Jan. 9, 2016	Jan. 09, 2017

3. OPERATION OF EUT DURING TESTING

3.1. Operating Mode

The mode is used: Transmitting mode

Low Channel: 2402MHz

Middle Channel: 2441MHz

High Channel: 2480MHz

Hopping

3.2. Configuration and peripherals

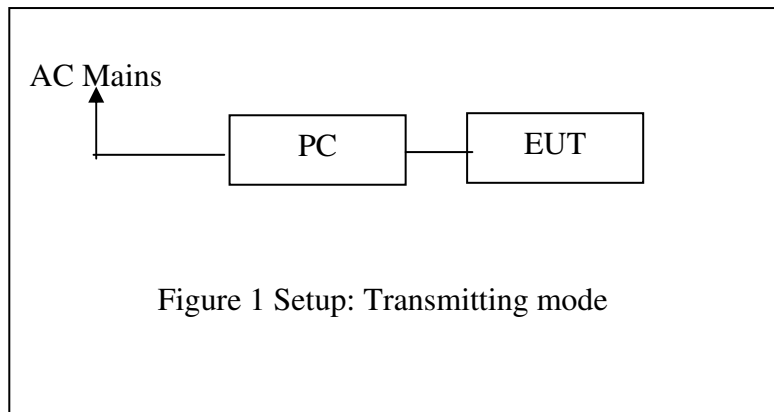

(EUT: Chroma Beats Color Changing LED Speaker)

4. TEST PROCEDURES AND RESULTS

FCC Rules	Description of Test	Result
Section 15.207	Conducted Emission Test	Compliant
Section 15.247(a)(1)	20dB Bandwidth Test	Compliant
Section 15.247(a)(1)	Carrier Frequency Separation Test	Compliant
Section 15.247(a)(1)(iii)	Number Of Hopping Frequency Test	Compliant
Section 15.247(a)(1)(iii)	Dwell Time Test	Compliant
Section 15.247(b)(1)	Maximum Peak Output Power Test	Compliant
Section 15.247(d) Section 15.209	Radiated Emission Test	Compliant
Section 15.247(d)	Band Edge Compliance Test	Compliant
Section 15.203	Antenna Requirement	Compliant

5. 20DB BANDWIDTH TEST

5.1. Block Diagram of Test Setup



(EUT: Chroma Beats Color Changing LED Speaker)

5.2. The Requirement For Section 15.247(a)(1)

Section 15.247(a)(1): Frequency hopping systems shall have hopping channel carrier frequencies separated by a minimum of 25 kHz or the 20 dB bandwidth of the hopping channel, whichever is greater.

5.3. EUT Configuration on Measurement

The equipment are installed on the emission measurement to meet the commission requirements and operating regulations in a manner which tends to maximize its emission characteristics in normal application.

5.4. Operating Condition of EUT

5.4.1. Setup the EUT and simulator as shown as Section 5.1.

5.4.2. Turn on the power of all equipment.

5.4.3. Let the EUT work in TX (Hopping off) modes measure it. The transmit frequency are 2402-2480MHz. We select 2402MHz, 2441MHz, and 2480MHz TX frequency to transmit.

5.5. Test Procedure

5.5.1. The transmitter output was connected to the spectrum analyzer through a low loss cable.

5.5.2. Set RBW of spectrum analyzer to 30 kHz and VBW to 100 kHz.

5.5.3. The 20dB bandwidth is defined as the total spectrum the power of which is higher than peak power minus 20dB.

5.6. Test Result

Channel	Frequency(MHz)	20dB Bandwidth(MHz)	Result
Low	2402	0.808	Pass
Middle	2441	0.808	Pass
High	2480	0.844	Pass

The spectrum analyzer plots are attached as below.

GFSK Mode

Low channel

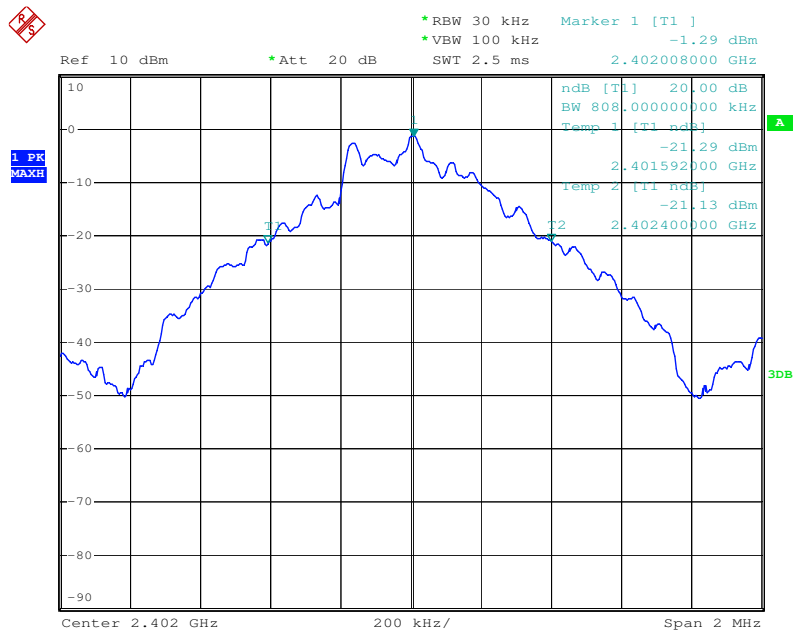

Middle channel

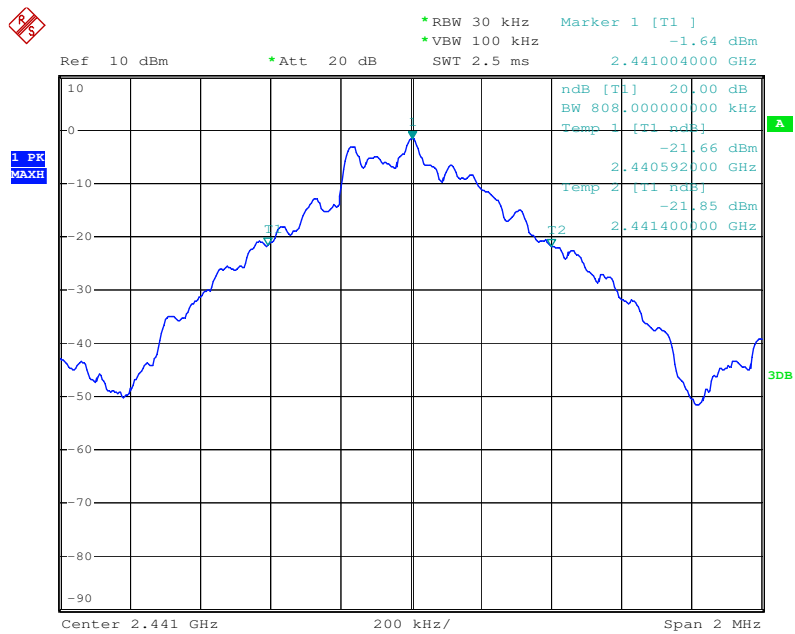

High channel

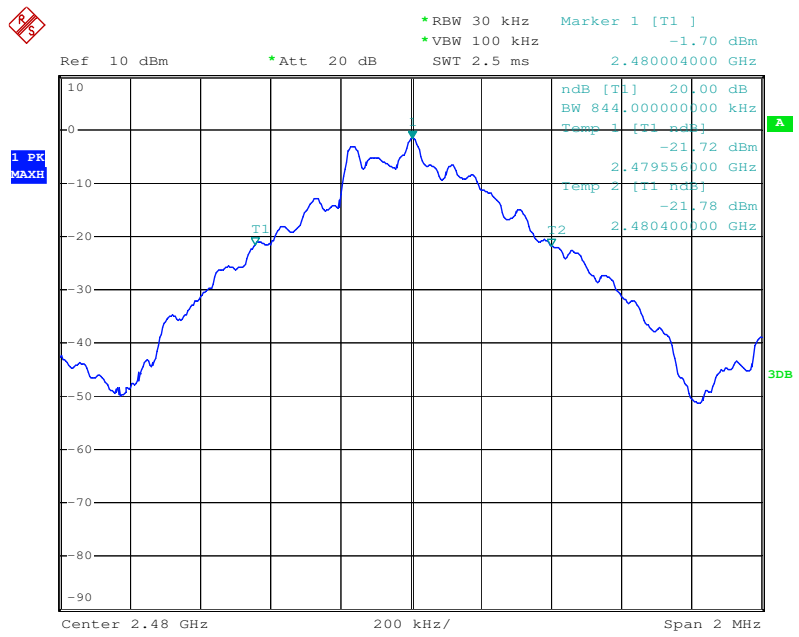

6. CARRIER FREQUENCY SEPARATION TEST

6.1. Block Diagram of Test Setup



(EUT: Chroma Beats Color Changing LED Speaker)

6.2. The Requirement For Section 15.247(a)(1)

Section 15.247(a)(1): Frequency hopping systems shall have hopping channel carrier frequencies separated by a minimum of 25 kHz or the 20 dB bandwidth of the hopping channel, whichever is greater. Alternatively, frequency hopping systems operating in the 2400-2483.5 MHz band may have hopping channel carrier frequencies that are separated by 25 kHz or two-thirds of the 20 dB bandwidth of the hopping channel, whichever is greater, provided the systems operate with an output power no greater than 125 mW. The system shall hop to channel frequencies that are selected at the system hopping rate from a pseudorandomly ordered list of hopping frequencies. Each frequency must be used equally on the average by each transmitter. The system receivers shall have input bandwidths that match the hopping channel bandwidths of their corresponding transmitters and shall shift frequencies in synchronization with the transmitted signals.

6.3. EUT Configuration on Measurement

The equipment are installed on the emission measurement to meet the commission requirements and operating regulations in a manner which tends to maximize its emission characteristics in normal application.

6.4. Operating Condition of EUT

6.4.1. Setup the EUT and simulator as shown as Section 6.1.

6.4.2. Turn on the power of all equipment.

6.4.3. Let the EUT work in TX (Hopping on) modes measure it. The transmit frequency are 2402-2480MHz. We select 2402MHz, 2441MHz, and 2480MHz TX frequency to transmit.

6.5. Test Procedure

6.5.1. The transmitter output was connected to the spectrum analyzer through a low loss cable.

6.5.2. Set RBW of spectrum analyzer to 30 kHz and VBW to 100 kHz. Adjust Span to 2 MHz.

6.5.3. Set the adjacent channel of the EUT maxhold another trace.

6.5.4. Measurement the channel separation

6.6. Test Result

Channel	Frequency (MHz)	Channel Separation(MHz)	Limit (MHz)	Result
Low	2402	1.000	25KHz or 20dB bandwidth	PASS
	2403			
Middle	2440	1.000	25KHz or 20dB bandwidth	PASS
	2441			
High	2479	1.000	25KHz or 20dB bandwidth	PASS
	2480			

The spectrum analyzer plots are attached as below.

Low channel

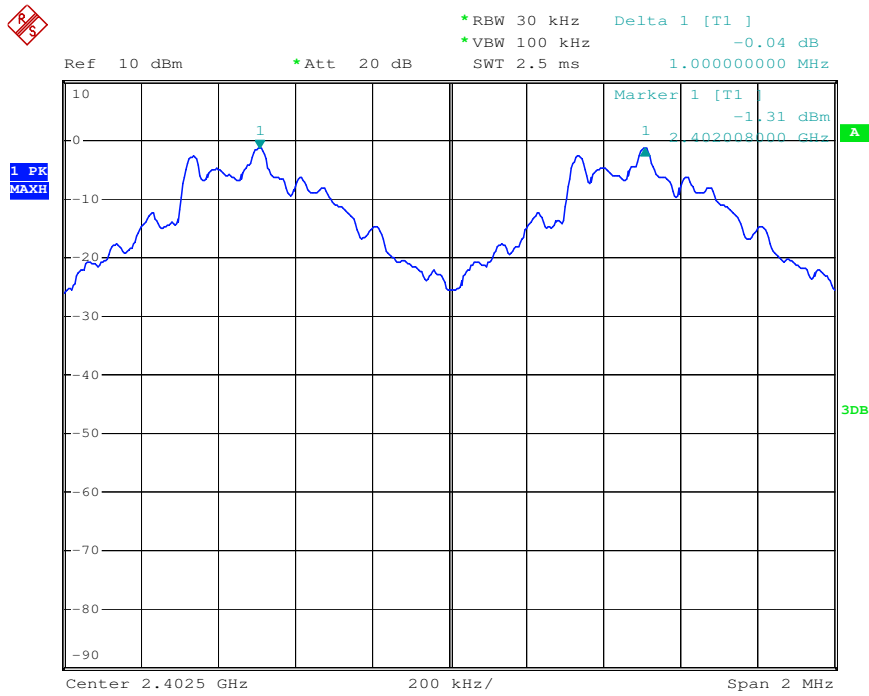

Middle channel

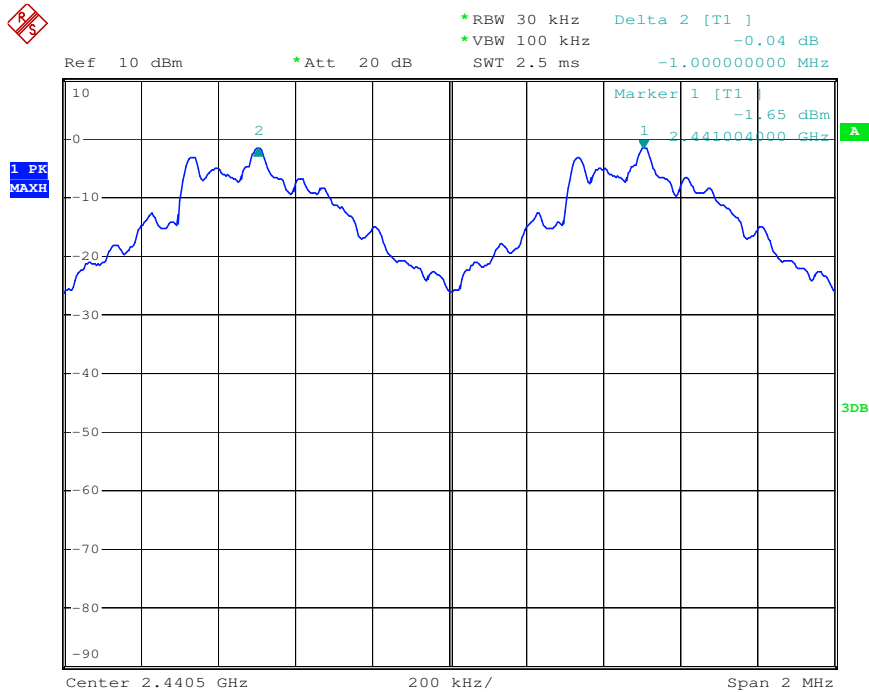

High channel

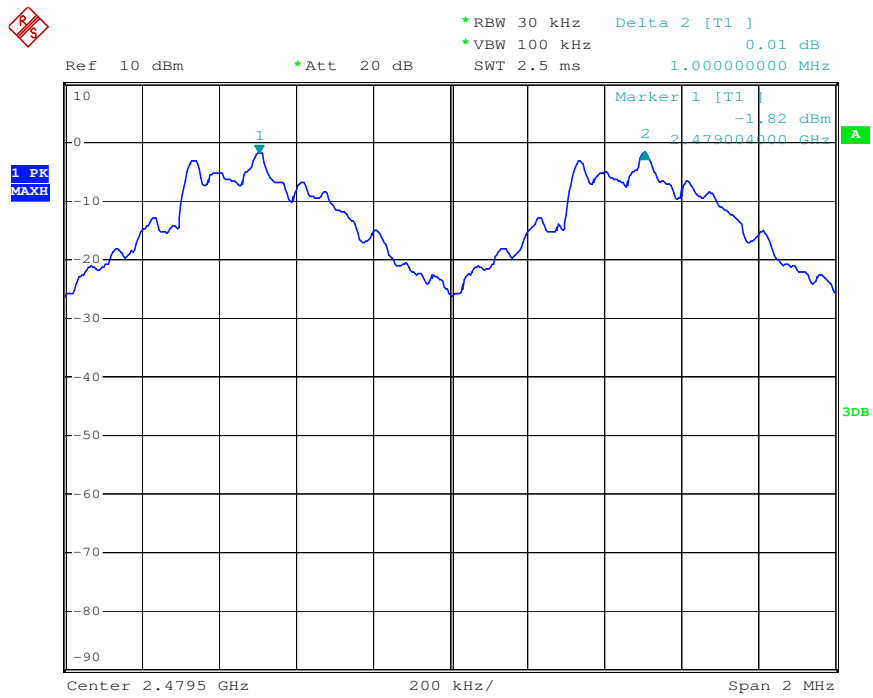

7. NUMBER OF HOPPING FREQUENCY TEST

7.1. Block Diagram of Test Setup

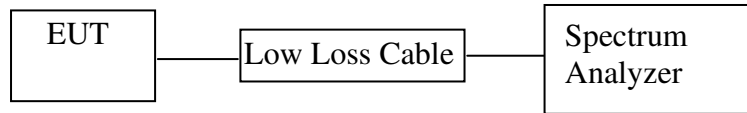

(EUT: Chroma Beats Color Changing LED Speaker)

7.2. The Requirement For Section 15.247(a)(1)(iii)

Section 15.247(a)(1)(iii): Frequency hopping systems in the 2400-2483.5 MHz band shall use at least 15 channels.

7.3. EUT Configuration on Measurement

The equipment are installed on the emission measurement to meet the commission requirements and operating regulations in a manner which tends to maximize its emission characteristics in normal application.

7.4. Operating Condition of EUT

7.4.1. Setup the EUT and simulator as shown as Section 7.1.

7.4.2. Turn on the power of all equipment.

7.4.3. Let the EUT work in TX (Hopping on) modes measure it.

7.5. Test Procedure

7.5.1. The transmitter output was connected to the spectrum analyzer through a low loss cable.

7.5.2. Set the spectrum analyzer as Span=83.5MHz, RBW=100 kHz, VBW=300 kHz.

7.5.3. Max hold, view and count how many channel in the band.

7.6. Test Result

Total number of hopping channel	Measurement result(CH)	Limit(CH)
	79	≥ 15

The spectrum analyzer plots are attached as below.

Number of hopping channels

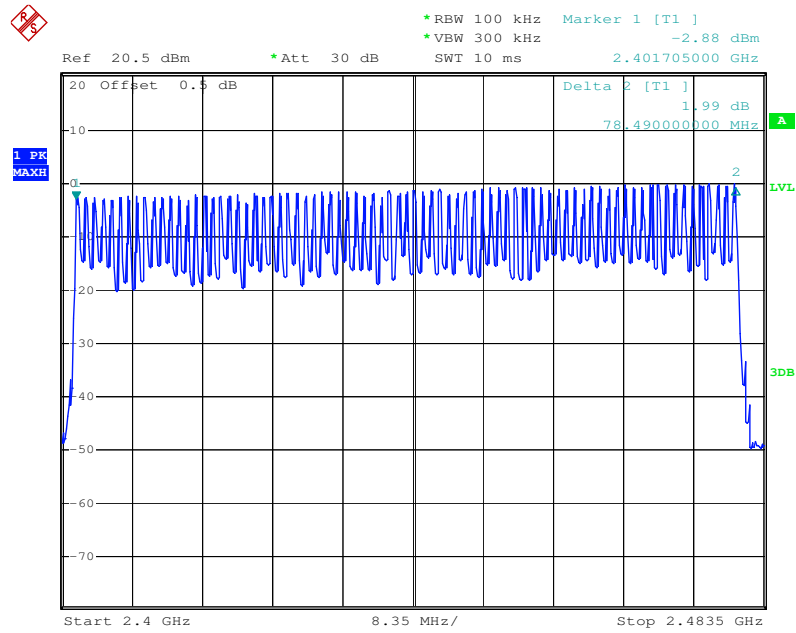

8. DWELL TIME TEST

8.1. Block Diagram of Test Setup

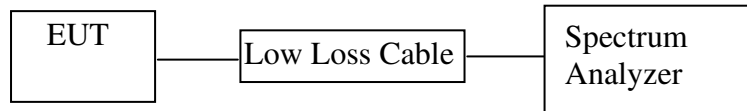

(EUT: Chroma Beats Color Changing LED Speaker)

8.2. The Requirement For Section 15.247(a)(1)(iii)

Section 15.247(a)(1)(iii): Frequency hopping systems in the 2400-2483.5 MHz band shall use at least 15 channels. The average time of occupancy on any channel shall not be greater than 0.4 seconds within a period of 0.4 seconds multiplied by the number of hopping channels employed. Frequency hopping systems may avoid or suppress transmissions on a particular hopping frequency provided that a minimum of 15 channels are used.

8.3. EUT Configuration on Measurement

The equipment are installed on the emission measurement to meet the commission requirements and operating regulations in a manner which tends to maximize its emission characteristics in normal application.

8.4. Operating Condition of EUT

8.4.1. Setup the EUT and simulator as shown as Section 8.1.

8.4.2. Turn on the power of all equipment.

8.4.3. Let the EUT work in TX (Hopping on) modes measure it. The transmit frequency are 2402-2480MHz. We select 2402MHz, 2441MHz, and 2480MHz TX frequency to transmit.

8.5. Test Procedure

8.5.1. The transmitter output was connected to the spectrum analyzer through a low loss cable.

8.5.2. Set center frequency of spectrum analyzer = operating frequency.

8.5.3. Set the spectrum analyzer as RBW=1MHz, VBW=3MHz, Span=0Hz, Adjust Sweep=5ms, 10ms, 15ms. Get the pulse time.

8.5.4.Repeat above procedures until all frequency measured were complete.

8.6.Test Result

Mode	Channel Frequency (MHz)	Pulse Time (ms)	Dwell Time (ms)	Limit (ms)
DH1	2402	0.530	169.60	400
	2441	0.530	169.60	400
	2480	0.530	169.60	400
A period transmit time = $0.4 \times 79 = 31.6$ Dwell time = pulse time $\times (1600/(2*79)) \times 31.6$				
DH3	2402	1.790	286.40	400
	2441	1.800	288.00	400
	2480	1.790	286.40	400
A period transmit time = $0.4 \times 79 = 31.6$ Dwell time = pulse time $\times (1600/(4*79)) \times 31.6$				
DH5	2402	3.070	327.47	400
	2441	3.070	327.47	400
	2480	3.070	327.47	400
A period transmit time = $0.4 \times 79 = 31.6$ Dwell time = pulse time $\times (1600/(6*79)) \times 31.6$				

The spectrum analyzer plots are attached as below.

GFSK Mode

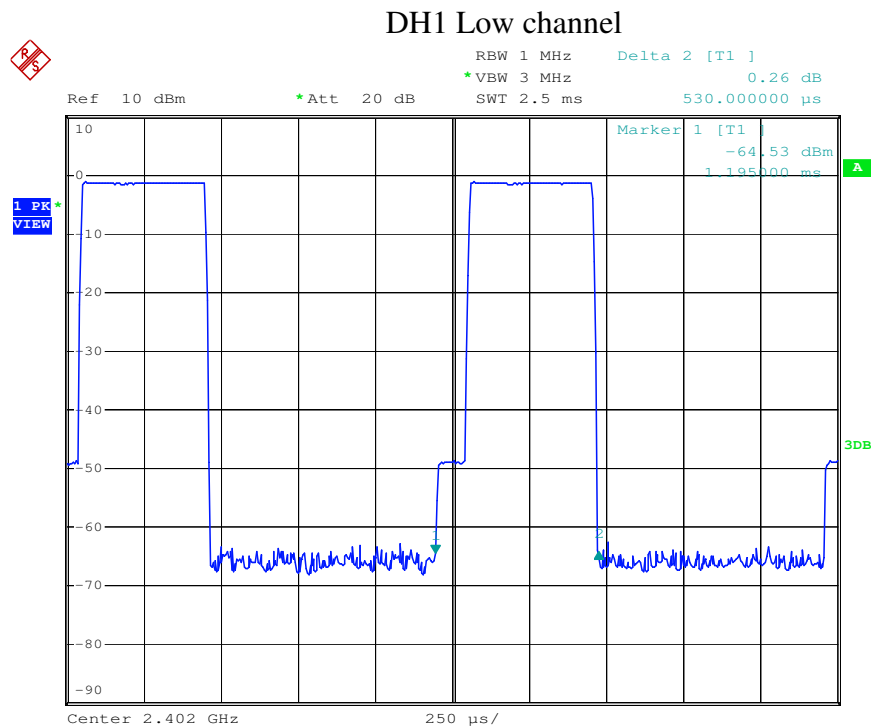

DH1 Middle channel

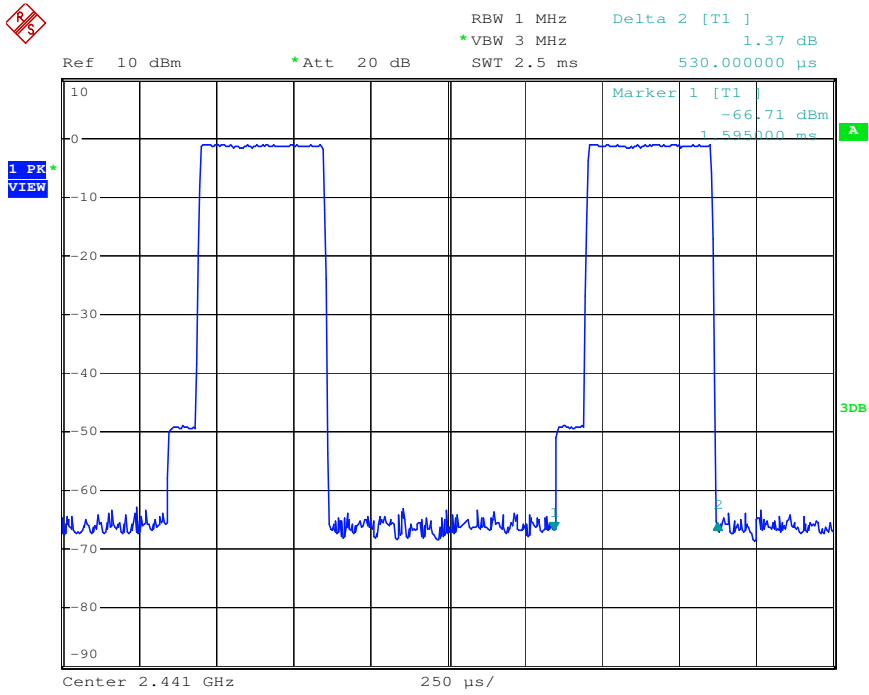

DH1 High channel

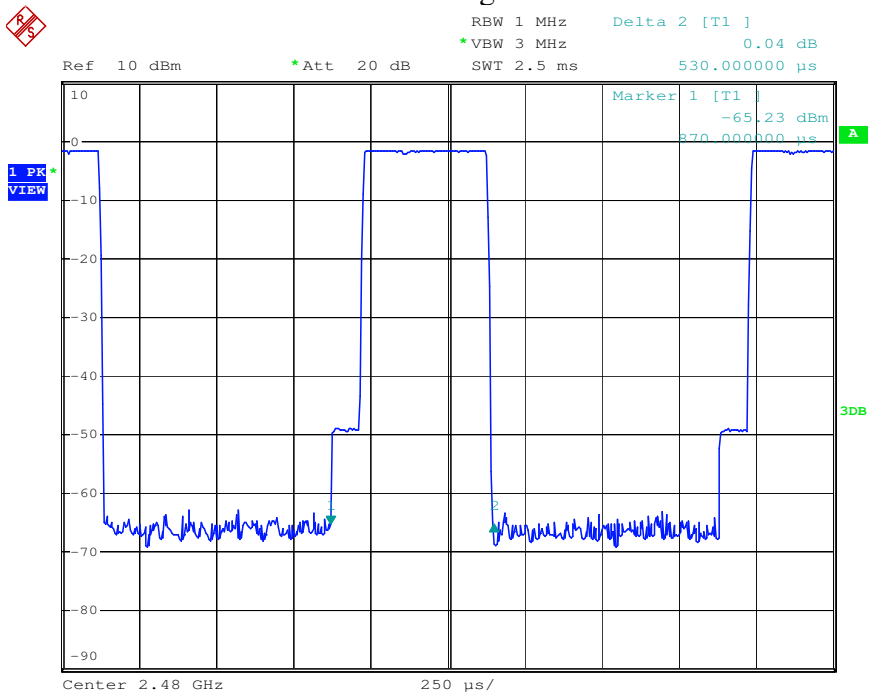

DH3 Low channel

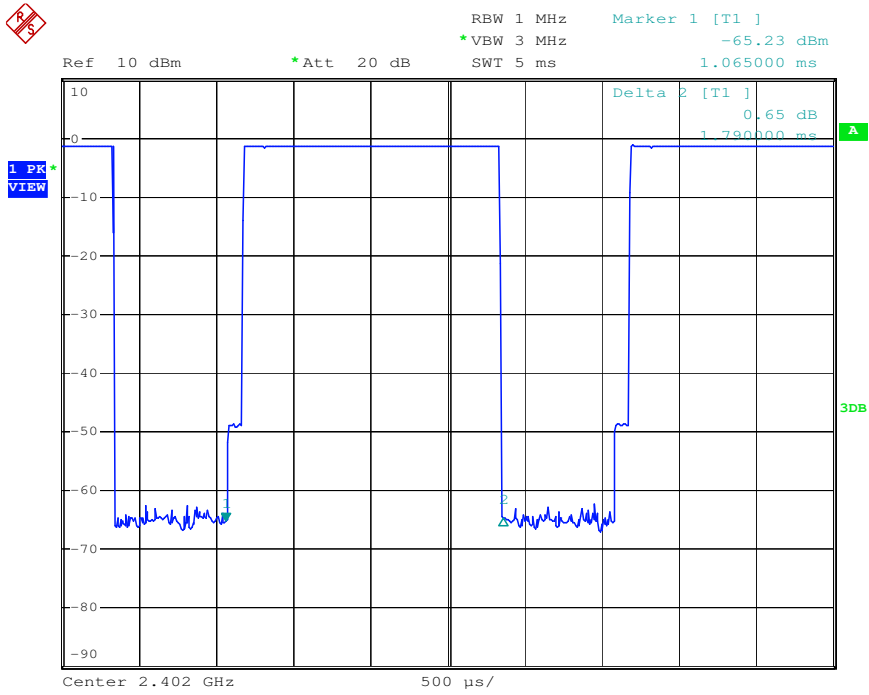

DH3 Middle channel

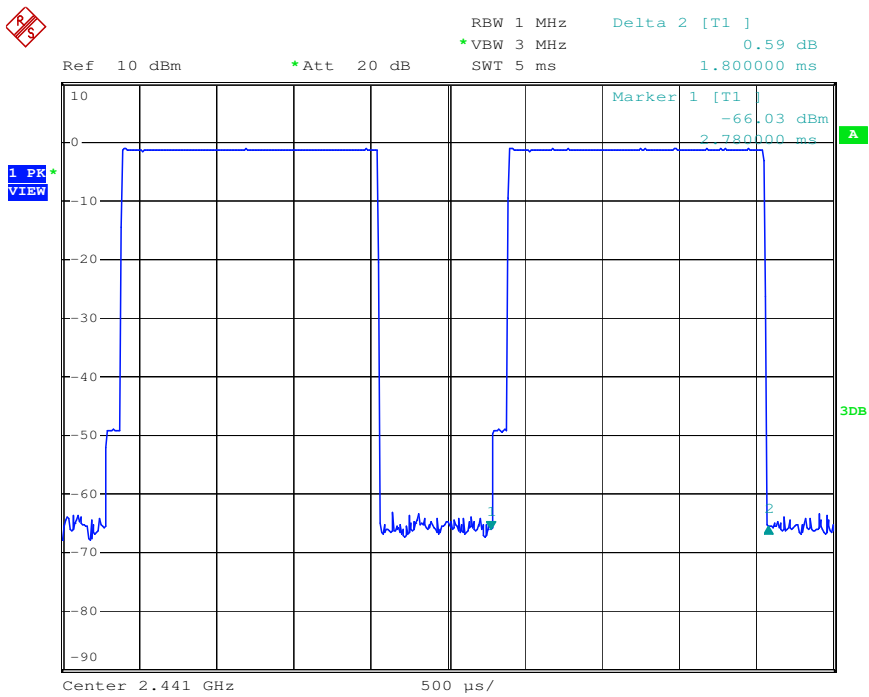

DH3 High channel

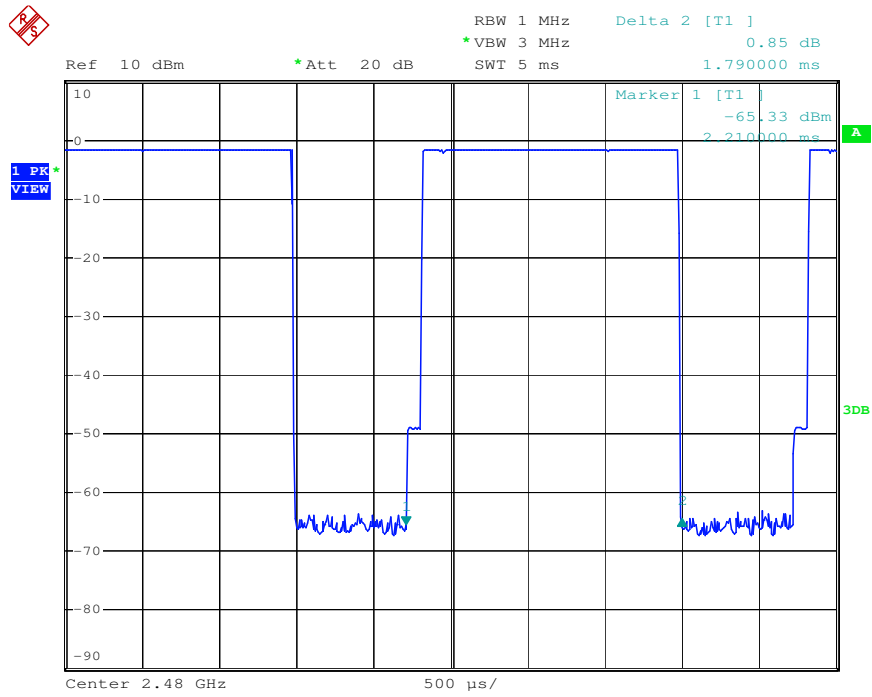

DH5 Low channel

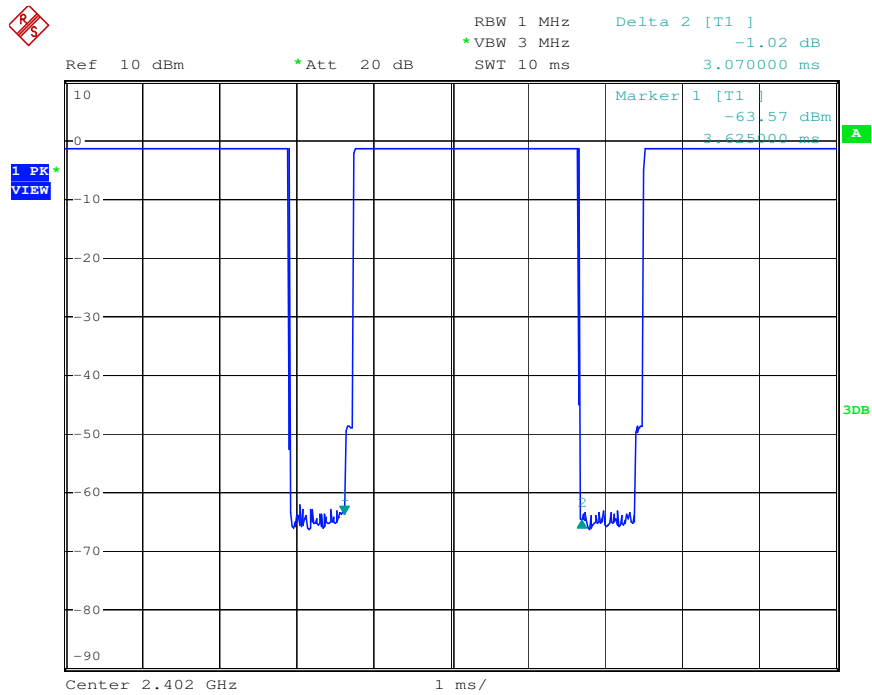

DH5 Middle channel

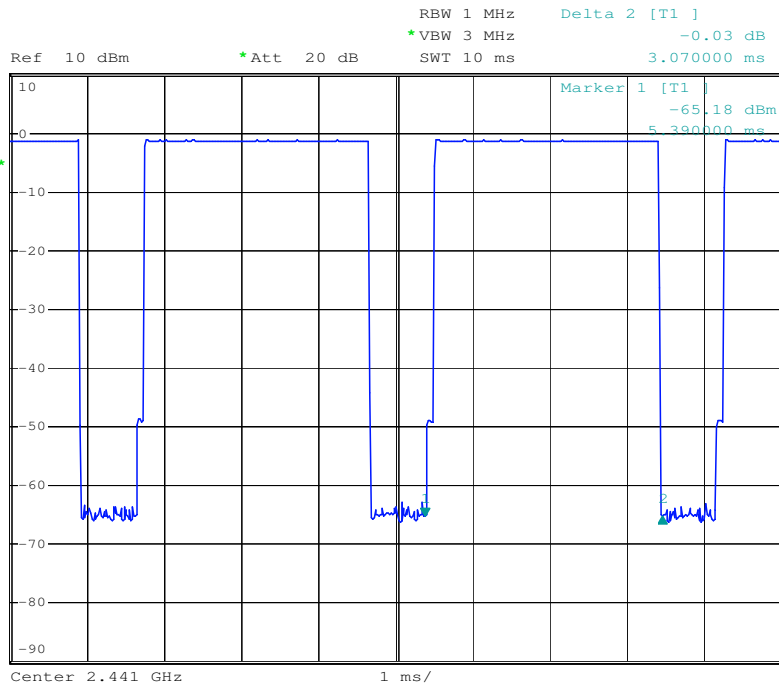

DH5 High channel

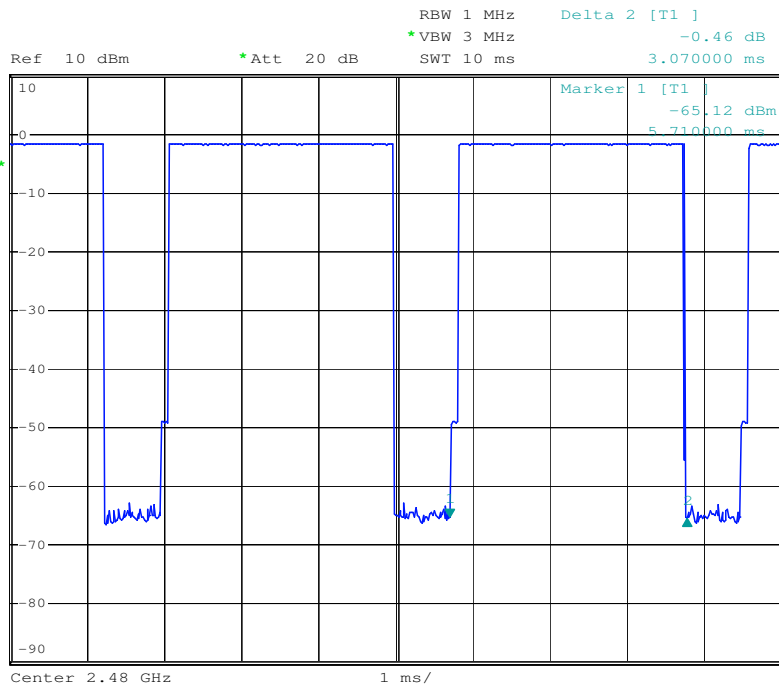

9. MAXIMUM PEAK OUTPUT POWER TEST

9.1. Block Diagram of Test Setup

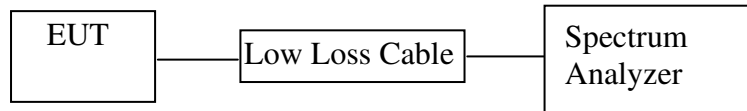

(EUT: Chroma Beats Color Changing LED Speaker)

9.2. The Requirement For Section 15.247(b)(1)

Section 15.247(b)(1): For frequency hopping systems operating in the 2400-2483.5 MHz band employing at least 75 non-overlapping hopping channels, and all frequency hopping systems in the 5725-5850 MHz band: 1 watt. For all other frequency hopping systems in the 2400-2483.5 MHz band: 0.125 watts.

9.3. EUT Configuration on Measurement

The equipment are installed on the emission Measurement to meet the commission requirements and operating regulations in a manner which tends to maximize its emission characteristics in normal application.

9.4. Operating Condition of EUT

9.4.1. Setup the EUT and simulator as shown as Section 9.1.

9.4.2. Turn on the power of all equipment.

9.4.3. Let the EUT work in TX (Hopping off) modes measure it. The transmit frequency are 2402-2480MHz. We select 2402MHz, 2441MHz, and 2480MHz TX frequency to transmit.

9.5. Test Procedure

9.5.1. The transmitter output was connected to the spectrum analyzer through a low loss cable.

9.5.2. Set RBW of spectrum analyzer to 1MHz and VBW to 3MHz for GFSK mode

9.5.3. Set RBW of spectrum analyzer to 3MHz and VBW to 10MHz for other mode

9.5.4. Measurement the maximum peak output power.

9.6. Test Result

Channel	Frequency (MHz)	Peak Output Power (dBm/W)	Limits dBm / W
Low	2402	-0.66/0.0009	30 / 1.0
Middle	2441	-0.19/0.0010	30 / 1.0
High	2480	0.03/0.0011	30 / 1.0

The spectrum analyzer plots are attached as below.

GFSK Mode

Low channel

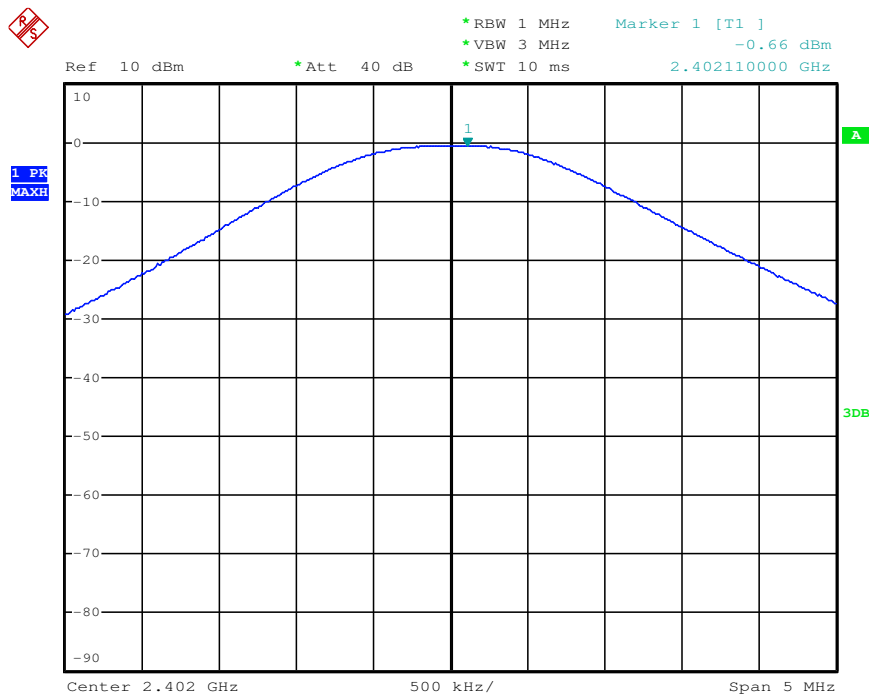

Middle channel

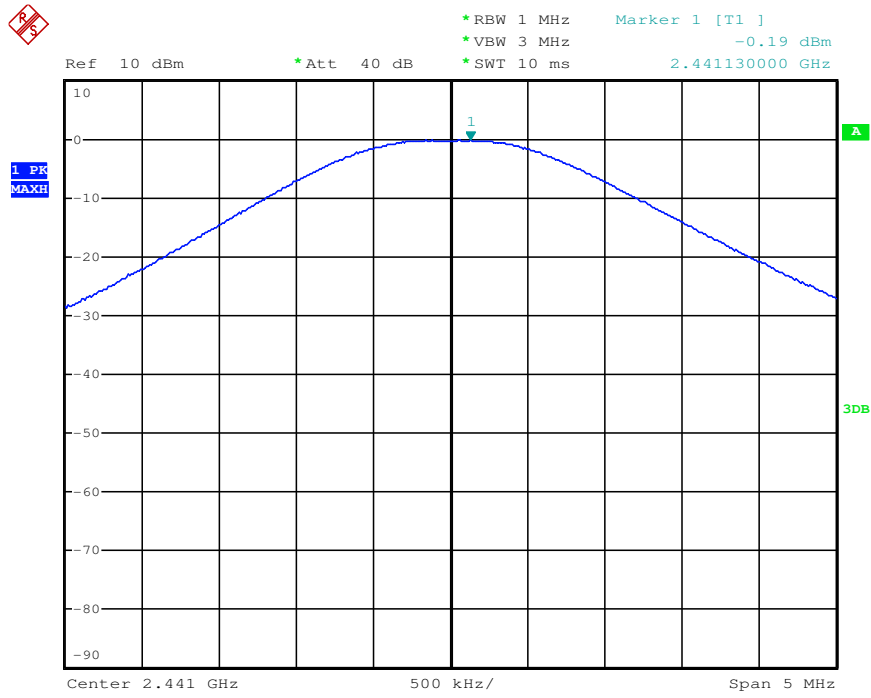

High channel

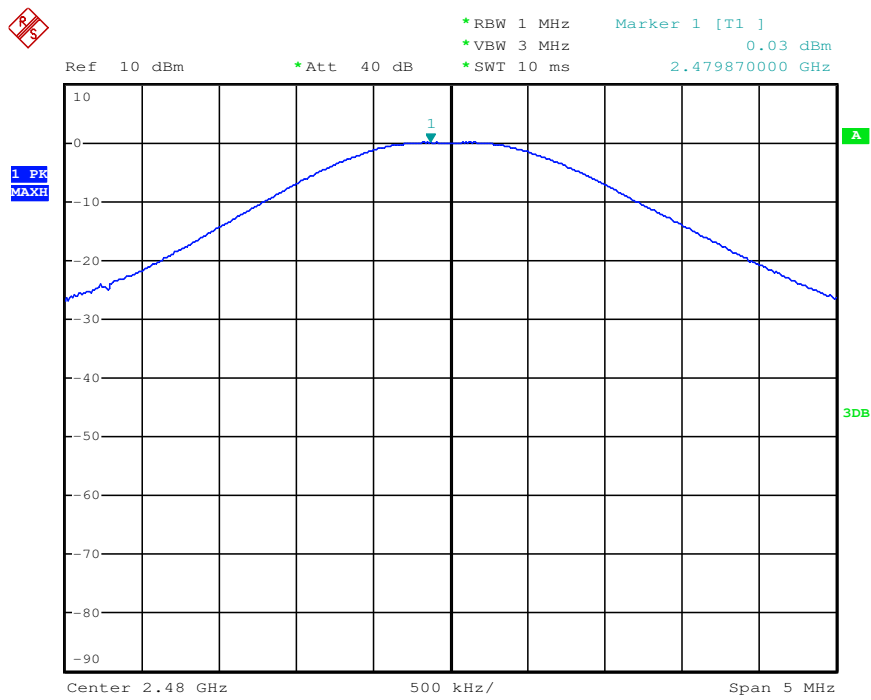

10. RADIATED EMISSION TEST

10.1. Block Diagram of Test Setup

10.1.1. Block diagram of connection between the EUT and peripherals

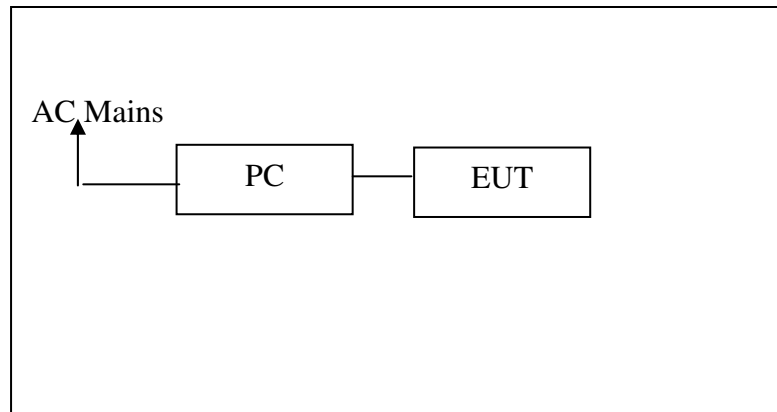

Setup: Transmitting mode

10.1.2. Semi-Anechoic Chamber Test Setup Diagram

Below 30MHz

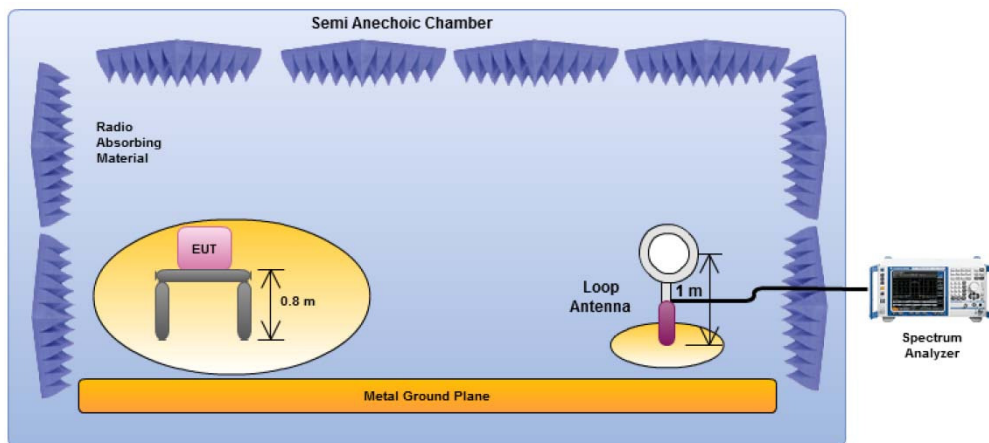

30MHz-1GHz

ANTENNA ELEVATION VARIES FROM 1 TO 4 METERS

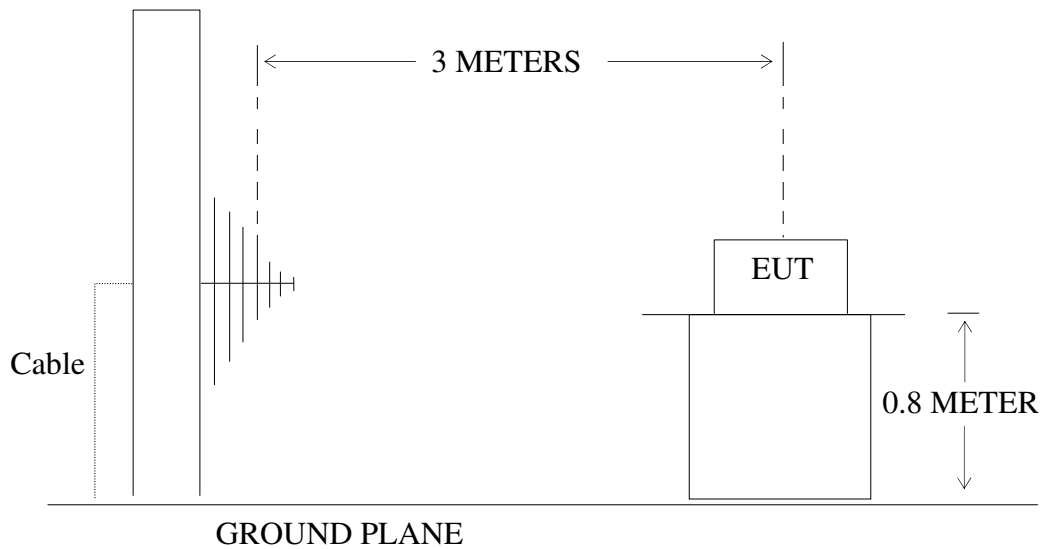

Above 1GHz

ANTENNA ELEVATION VARIES FROM 1 TO 4 METERS

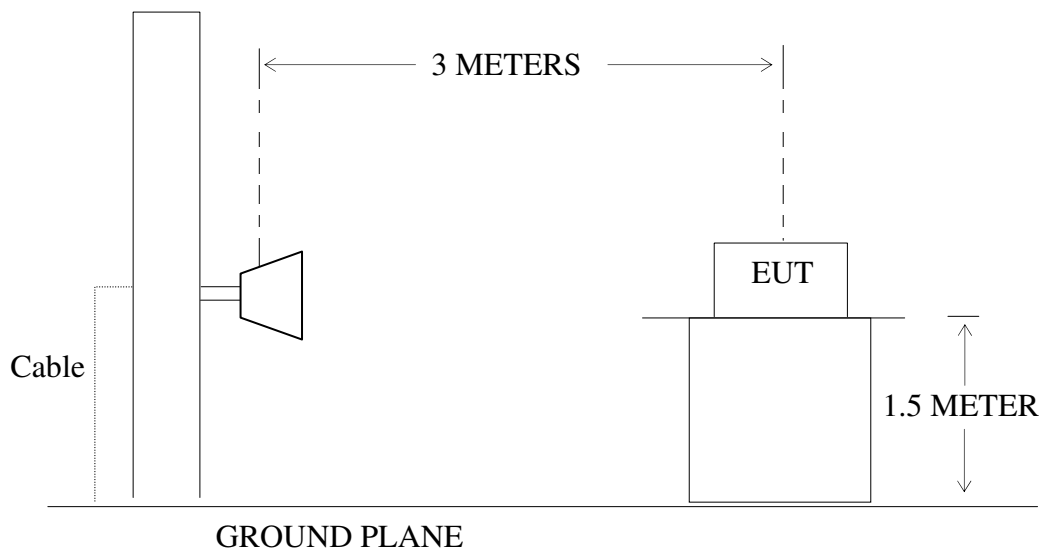

10.2.The Limit For Section 15.247(d)

Section 15.247(d): In any 100 kHz bandwidth outside the frequency band in which the spread spectrum or digitally modulated intentional radiator is operating, the radio frequency power that is produced by the intentional radiator shall be at least 20 dB below that in the 100 kHz bandwidth within the band that contains the highest level of the desired power, based on either an RF conducted or a radiated measurement, provided the transmitter demonstrates compliance with the peak conducted power limits. If the transmitter complies with the conducted power limits based on the use of RMS averaging over a time interval, as permitted under paragraph (b)(3) of this section, the attenuation

required under this paragraph shall be 30 dB instead of 20 dB. Attenuation below the general limits specified in Section 15.209(a) is not required. In addition, radiated emissions which fall in the restricted bands, as defined in Section 15.205(a), must also comply with the radiated emission limits specified in Section 15.209(a).

10.3.Restricted bands of operation

10.3.1.FCC Part 15.205 Restricted bands of operation

(a) Except as shown in paragraph (d) of this section, Only spurious emissions are permitted in any of the frequency bands listed below:

MHz	MHz	MHz	GHz
0.090-0.110	16.42-16.423	399.9-410	4.5-5.15
¹ 0.495-0.505	16.69475-16.69525	608-614	5.35-5.46
2.1735-2.1905	16.80425-16.80475	960-1240	7.25-7.75
4.125-4.128	25.5-25.67	1300-1427	8.025-8.5
4.17725-4.17775	37.5-38.25	1435-1626.5	9.0-9.2
4.20725-4.20775	73-74.6	1645.5-1646.5	9.3-9.5
6.215-6.218	74.8-75.2	1660-1710	10.6-12.7
6.26775-6.26825	108-121.94	1718.8-1722.2	13.25-13.4
6.31175-6.31225	123-138	2200-2300	14.47-14.5
8.291-8.294	149.9-150.05	2310-2390	15.35-16.2
8.362-8.366	156.52475-156.52525	2483.5-2500	17.7-21.4
8.37625-8.38675	156.7-156.9	2690-2900	22.01-23.12
8.41425-8.41475	162.0125-167.17	3260-3267	23.6-24.0
12.29-12.293	167.72-173.2	3332-3339	31.2-31.8
12.51975-12.52025	240-285	3345.8-3358	36.43-36.5
12.57675-12.57725	322-335.4	3600-4400	(²)
13.36-13.41			

¹Until February 1, 1999, this restricted band shall be 0.490-0.510

²Above 38.6

(b) Except as provided in paragraphs (d) and (e), the field strength of emission appearing within these frequency bands shall not exceed the limits shown in Section 15.209. At frequencies equal to or less than 1000MHz, Compliance with the limits in Section 15.209 shall be demonstrated using measurement instrumentation employing a CISPR quasi-peak detector. Above 1000MHz, compliance with the emission limits in Section 15.209 shall be demonstrated based on the average value of the measured emissions. The provisions in Section 15.35 apply to these measurements.

10.4.Configuration of EUT on Measurement

The equipment is installed on Radiated Emission Measurement to meet the commission requirements and operating regulations in a manner which tends to maximize its emission characteristics in normal application.

10.5. Test Procedure

The EUT and its simulators are placed on a turntable, which is 0.1 meter high above ground (Below 1GHz). The EUT and its simulators are placed on a turntable, which is 0.1 meter high above ground (Above 1GHz). The turntable can rotate 360 degrees to determine the position of the maximum emission level. EUT is set 3.0 meters away from the receiving antenna, which is mounted on an antenna tower. The antenna can be moved up and down between 1.0 meter and 4 meters to find out the maximum emission level. Broadband antenna (calibrated bi-log antenna) is used as receiving antenna. Both horizontal and vertical polarizations of the antenna are set on measurement. In order to find the maximum emission levels, all of the EUT location must be manipulated according to ANSI C63.10:2013 on radiated emission measurement. The EUT was tested in 3 orthogonal planes.

During the radiated emission test, the spectrum analyzer was set with the following configurations:

1. The resolution bandwidth and video bandwidth of test receiver/spectrum analyzer is 120kHz for Quasi-peak at frequency below 1GHz.
2. The resolution bandwidth of test receiver/spectrum analyzer is 1MHz and video bandwidth is 3MHz for peak measurement with peak detector at frequency above 1GHz.
3. The resolution bandwidth of test receiver/spectrum analyzer is 1MHz and video bandwidth is 10Hz for Average measurement with peak detection at frequency above 1GHz.
4. All modes of operation were investigated and the worst-case emissions are reported.

10.6. The Field Strength of Radiation Emission Measurement Results

Note: The test frequency is from 30MHz to 25GHz, The 18-25GHz emissions are not reported, because the levels are too low against the limit.

Below 1GHz



ACCURATE TECHNOLOGY CO., LTD.

F1,Bldg,A,Changyuan New Material Port Keyuan Rd,
Science & Industry Park,Nanshan Shenzhen,P.R.China

Site: 1# Chamber
Tel:+86-0755-26503290
Fax:+86-0755-26503396

Job No.: DING1 #83	Polarization: Horizontal
Standard: FCC Class B 3M Radiated	Power Source: DC 5V
Test item: Radiation Test	Date: 2016/12/15
Temp.(C)/Hum.(%) 25 C / 55 %	Time: 16:58:32
EUT: Chroma Beats Color Changing LED Speaker	Engineer Signature: DING
Mode: TX 2402MHz	Distance: 3m
Model: CB-335115	
Manufacturer: CLEVER BRIGHT	

Note: Report NO:ATE20162567

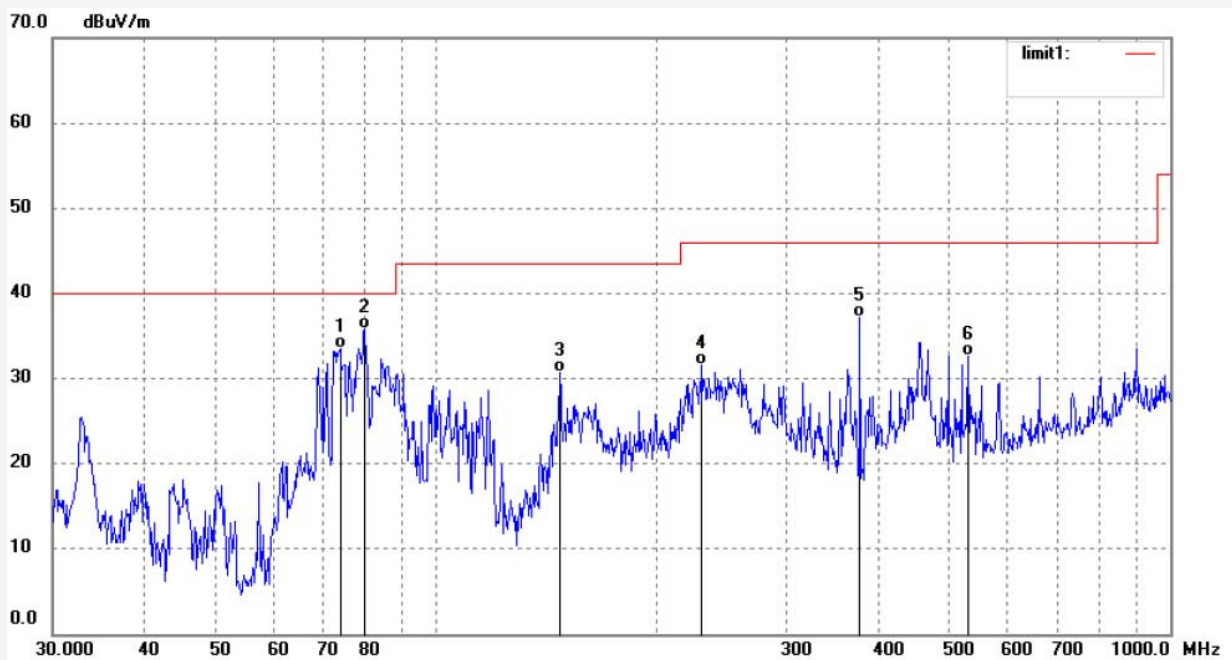

No.	Freq. (MHz)	Reading (dBuV/m)	Factor (dB)	Result (dBuV/m)	Limit (dBuV/m)	Margin (dB)	Detector	Height (cm)	Degree (deg.)	Remark
1	74.0092	55.73	-22.26	33.47	40.00	-6.53	QP			
2	79.9569	57.71	-22.00	35.71	40.00	-4.29	QP			
3	147.3558	53.09	-22.36	30.73	43.50	-12.77	QP			
4	230.2295	49.84	-18.28	31.56	46.00	-14.44	QP			
5	377.8480	50.49	-13.26	37.23	46.00	-8.77	QP			
6	531.2910	42.85	-10.15	32.70	46.00	-13.30	QP			



ACCURATE TECHNOLOGY CO., LTD.

 F1,Bldg.A,Changyuan New Material Port Keyuan Rd,
 Science & Industry Park,Nanshan Shenzhen,P.R.China

 Site: 1# Chamber
 Tel:+86-0755-26503290
 Fax:+86-0755-26503396

Job No.: DING1 #84	Polarization: Vertical
Standard: FCC Class B 3M Radiated	Power Source: DC 5V
Test item: Radiation Test	Date: 2016/12/15
Temp.(C)/Hum.(%) 25 C / 55 %	Time: 16:59:35
EUT: Chroma Beats Color Changing LED Speaker	Engineer Signature: DING
Mode: TX 2402MHz	Distance: 3m
Model: CB-335115	
Manufacturer: CLEVER BRIGHT	

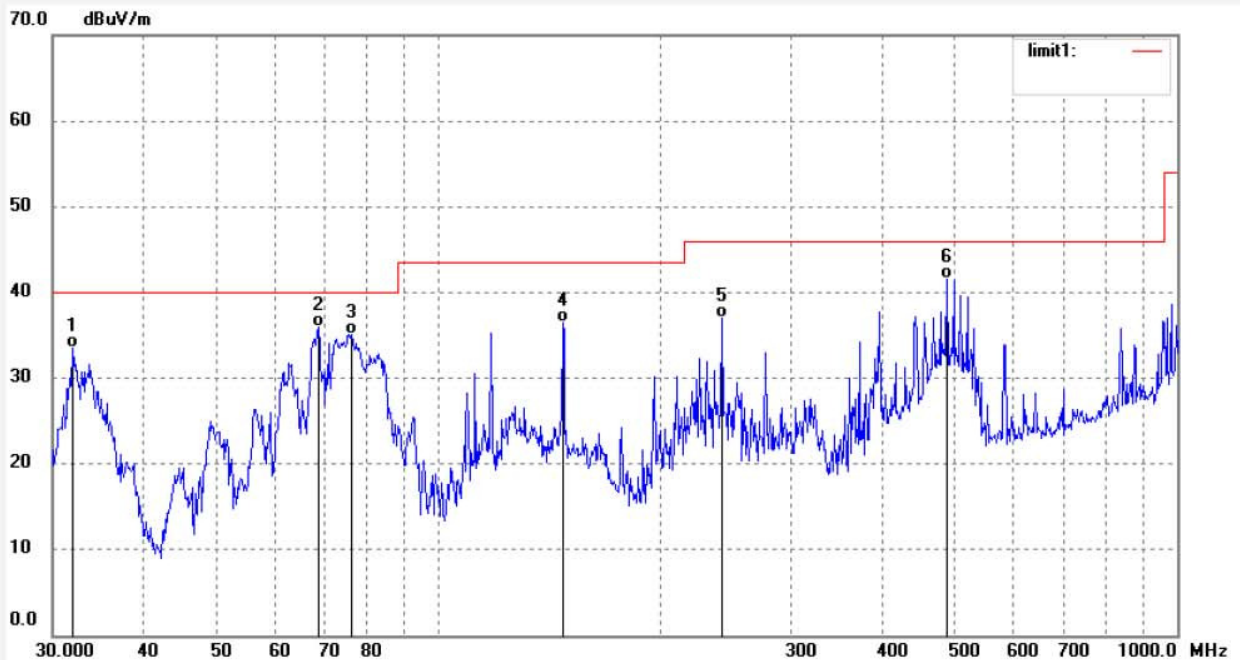
Note: Report NO:ATE20162567



No.	Freq. (MHz)	Reading (dBuV/m)	Factor (dB)	Result (dBuV/m)	Limit (dBuV/m)	Margin (dB)	Detector	Height (cm)	Degree (deg.)	Remark
1	31.9586	48.77	-15.19	33.58	40.00	-6.42	QP			
2	68.7450	58.00	-22.03	35.97	40.00	-4.03	QP			
3	76.1188	57.41	-22.24	35.17	40.00	-4.83	QP			
4	147.3558	58.84	-22.36	36.48	43.50	-7.02	QP			
5	241.8377	55.25	-18.17	37.08	46.00	-8.92	QP			
6	488.3263	52.69	-11.08	41.61	46.00	-4.39	QP			

Job No.: DING1 #85

Standard: FCC Class B 3M Radiated

Test item: Radiation Test

Temp.(C)/Hum.(%) 25 C / 55 %

EUT: Chroma Beats Color Changing LED Speaker

Mode: TX 2441MHz

Model: CB-335115

Manufacturer: CLEVER BRIGHT

Polarization: Vertical

Power Source: DC 5V

Date: 2016/12/15

Time: 17:00:02

Engineer Signature: DING

Distance: 3m

Note: Report NO:ATE20162567

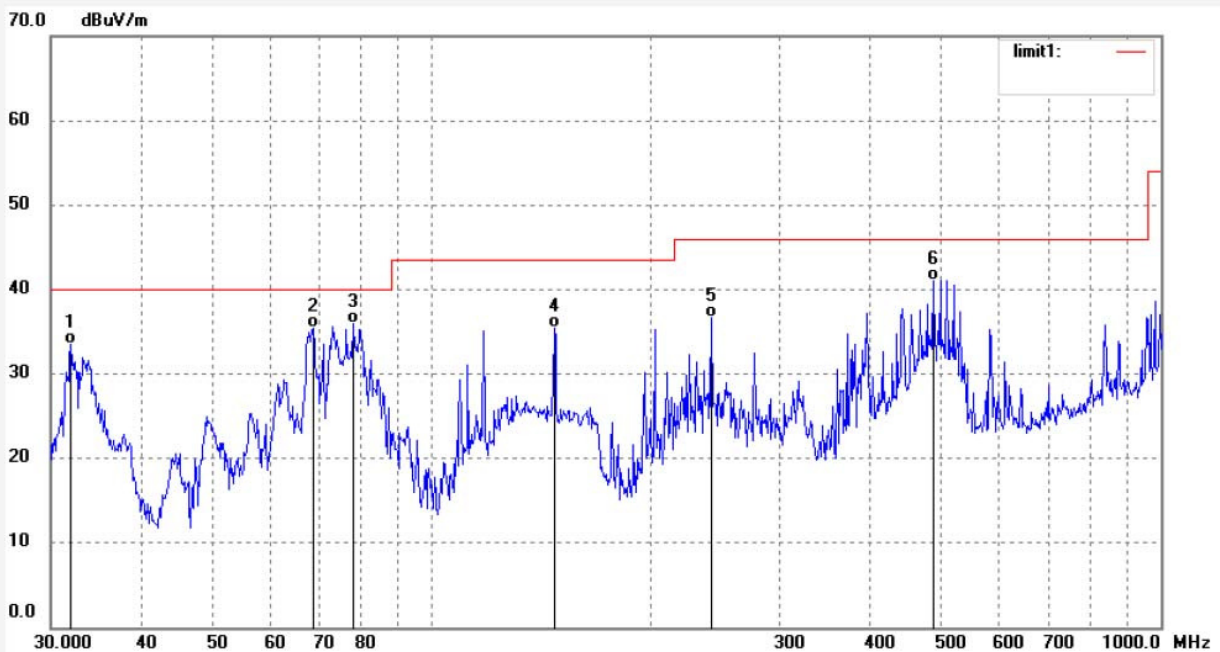

No.	Freq. (MHz)	Reading (dBuV/m)	Factor (dB)	Result (dBuV/m)	Limit (dBuV/m)	Margin (dB)	Detector	Height (cm)	Degree (deg.)	Remark
1	31.9586	48.73	-15.19	33.54	40.00	-6.46	QP			
2	68.7450	57.50	-22.03	35.47	40.00	-4.53	QP			
3	78.0143	58.13	-22.12	36.01	40.00	-3.99	QP			
4	147.3558	57.84	-22.36	35.48	43.50	-8.02	QP			
5	241.8377	54.75	-18.17	36.58	46.00	-9.42	QP			
6	488.3263	52.19	-11.08	41.11	46.00	-4.89	QP			



ACCURATE TECHNOLOGY CO., LTD.

F1,Bldg,A,Changyuan New Material Port Keyuan Rd,
Science & Industry Park,Nanshan Shenzhen,P.R.China

Site: 1# Chamber

Tel:+86-0755-26503290

Fax:+86-0755-26503396

Job No.: DING1 #86	Polarization: Horizontal
Standard: FCC Class B 3M Radiated	Power Source: DC 5V
Test item: Radiation Test	Date: 2016/12/15
Temp.(C)/Hum.(%) 25 C / 55 %	Time: 17:01:12
EUT: Chroma Beats Color Changing LED Speaker	Engineer Signature: DING
Mode: TX 2441MHz	Distance: 3m
Model: CB-335115	
Manufacturer: CLEVER BRIGHT	

Note: Report NO:ATE20162567

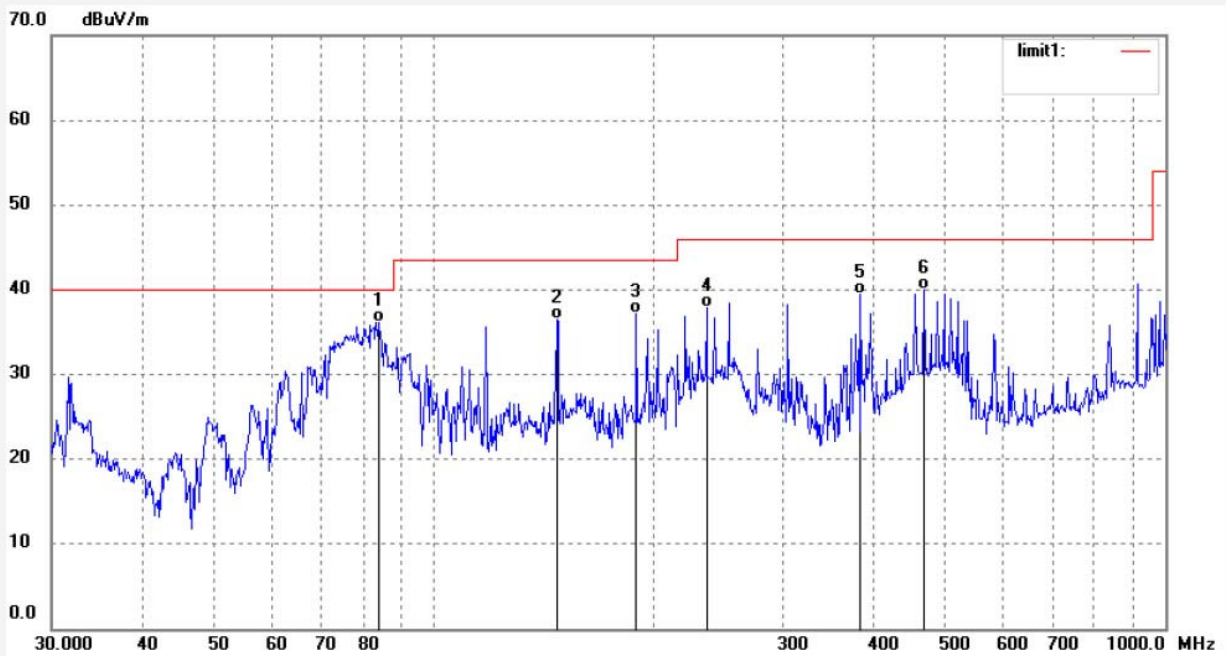

No.	Freq. (MHz)	Reading (dBuV/m)	Factor (dB)	Result (dBuV/m)	Limit (dBuV/m)	Margin (dB)	Detector	Height (cm)	Degree (deg.)	Remark
1	83.9882	58.20	-21.98	36.22	40.00	-3.78	QP			
2	147.3557	58.84	-22.36	36.48	43.50	-7.02	QP			
3	189.1074	56.71	-19.49	37.22	43.50	-6.28	QP			
4	235.9619	56.05	-18.23	37.82	46.00	-8.18	QP			
5	383.1960	52.60	-13.21	39.39	46.00	-6.61	QP			
6	468.1650	51.42	-11.40	40.02	46.00	-5.98	QP			



ACCURATE TECHNOLOGY CO., LTD.

F1,Bldg,A,Changyuan New Material Port Keyuan Rd,
Science & Industry Park,Nanshan Shenzhen,P.R.China

Site: 1# Chamber
Tel:+86-0755-26503290
Fax:+86-0755-26503396

Job No.: DING1 #87	Polarization: Horizontal
Standard: FCC Class B 3M Radiated	Power Source: DC 5V
Test item: Radiation Test	Date: 2016/12/15
Temp.(C)/Hum.(%) 25 C / 55 %	Time: 17:01:29
EUT: Chroma Beats Color Changing LED Speaker	Engineer Signature: DING
Mode: TX 2480MHz	Distance: 3m
Model: CB-335115	
Manufacturer: CLEVER BRIGHT	

Note: Report NO:ATE20162567

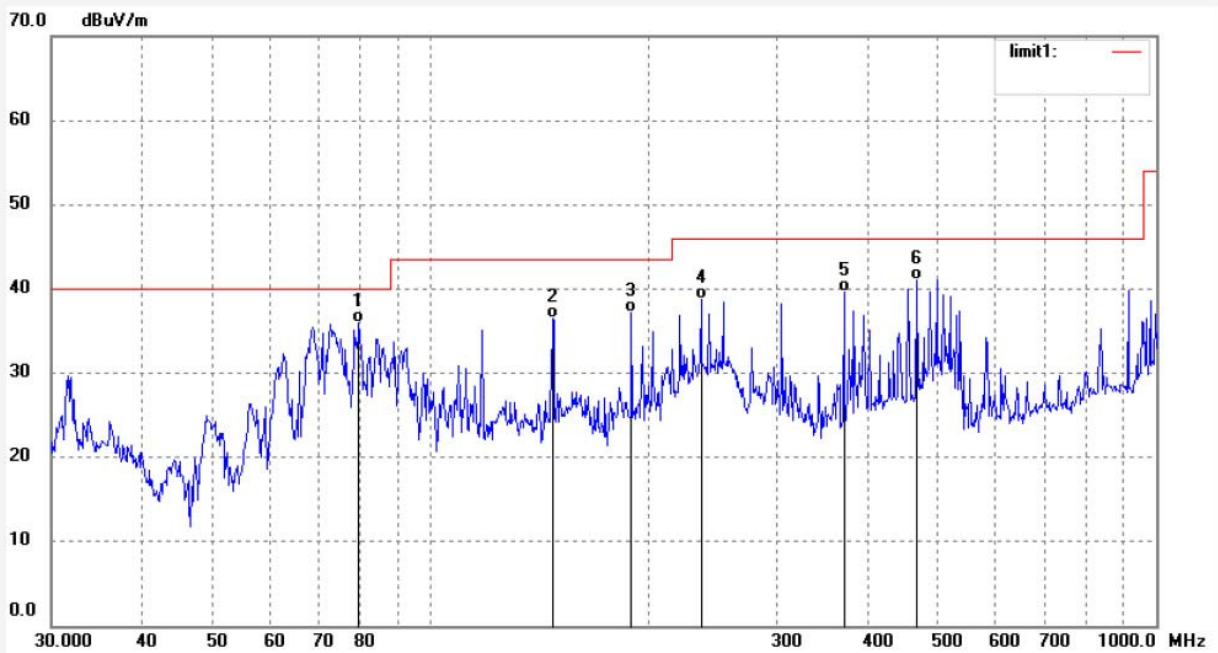

No.	Freq. (MHz)	Reading (dBuV/m)	Factor (dB)	Result (dBuV/m)	Limit (dBuV/m)	Margin (dB)	Detector	Height (cm)	Degree (deg.)	Remark
1	79.6764	57.99	-22.02	35.97	40.00	-4.03	QP			
2	147.3557	58.84	-22.36	36.48	43.50	-7.02	QP			
3	189.1074	56.71	-19.49	37.22	43.50	-6.28	QP			
4	235.9619	57.05	-18.23	38.82	46.00	-7.18	QP			
5	371.2678	52.99	-13.33	39.66	46.00	-6.34	QP			
6	468.1650	52.42	-11.40	41.02	46.00	-4.98	QP			



ACCURATE TECHNOLOGY CO., LTD.

F1,Bldg.A,Changyuan New Material Port Keyuan Rd,
Science & Industry Park,Nanshan Shenzhen,P.R.China

Site: 1# Chamber

Tel:+86-0755-26503290

Fax:+86-0755-26503396

Job No.: DING1 #88

Standard: FCC Class B 3M Radiated

Test item: Radiation Test

Temp.(C)/Hum.(%) 25 C / 55 %

EUT: Chroma Beats Color Changing LED Speaker

Mode: TX 2480MHz

Model: CB-335115

Manufacturer: CLEVER BRIGHT

Polarization: Vertical

Power Source: DC 5V

Date: 2016/12/15

Time: 17:02:39

Engineer Signature: DING

Distance: 3m

Note: Report NO:ATE20162567

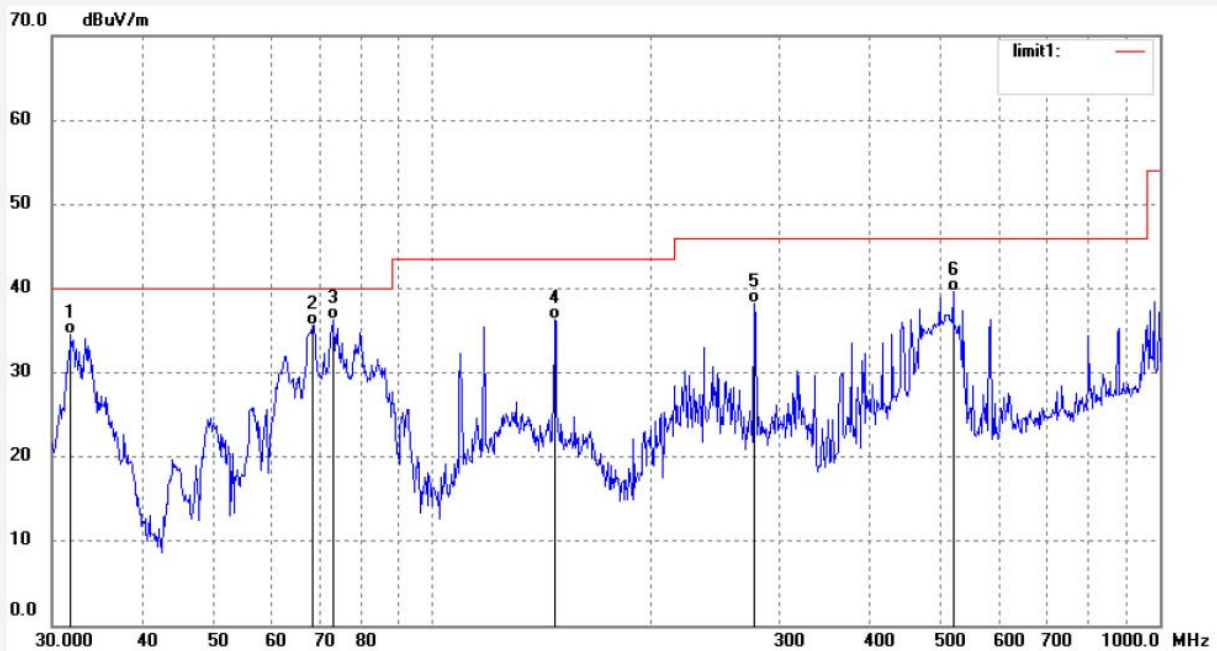

No.	Freq. (MHz)	Reading (dBuV/m)	Factor (dB)	Result (dBuV/m)	Limit (dBuV/m)	Margin (dB)	Detector	Height (cm)	Degree (deg.)	Remark
1	31.8463	49.66	-15.16	34.50	40.00	-5.50	QP			
2	68.5036	57.60	-22.02	35.58	40.00	-4.42	QP			
3	72.9762	58.55	-22.21	36.34	40.00	-3.66	QP			
4	147.3558	58.60	-22.36	36.24	43.50	-7.26	QP			
5	277.3546	55.06	-16.77	38.29	46.00	-7.71	QP			
6	520.2078	50.07	-10.41	39.66	46.00	-6.34	QP			

Above 1GHz



ACCURATE TECHNOLOGY CO., LTD.

F1,Bldg,A,Changyuan New Material Port Keyuan Rd,
Science & Industry Park,Nanshan Shenzhen,P.R.China

Site: 1# Chamber
Tel:+86-0755-26503290
Fax:+86-0755-26503396

Job No.: DING #96	Polarization: Horizontal
Standard: FCC PK	Power Source: DC 5V
Test item: Radiation Test	Date: 16/12/14/
Temp.(C)/Hum.(%) 25 C / 55 %	Time: 16:53:32
EUT: Chroma Beats Color Changing LED Speaker	Engineer Signature: DING
Mode: TX 2402MHz	Distance: 3m
Model: CB-335115	
Manufacturer: CLEVER BRIGHT	

Note: Report NO.:ATE20162567

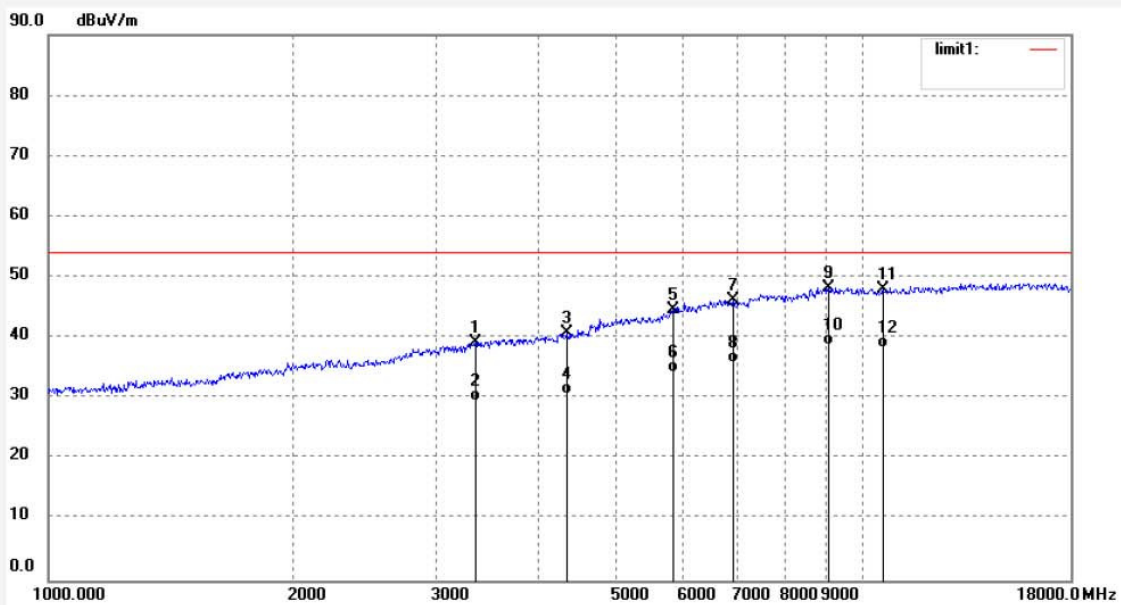

No.	Freq. (MHz)	Reading (dBuV/m)	Factor (dB)	Result (dBuV/m)	Limit (dBuV/m)	Margin (dB)	Detector	Height (cm)	Degree (deg.)	Remark
1	3346.651	43.25	-3.99	39.26	74.00	-34.74	peak			
2	3346.651	33.50	-3.99	29.51	54.00	-24.49	AVG			
3	4336.279	42.28	-1.49	40.79	74.00	-33.21	peak			
4	4336.279	32.14	-1.49	30.65	54.00	-23.35	AVG			
5	5852.234	41.68	2.97	44.65	74.00	-29.35	peak			
6	5852.234	31.29	2.97	34.26	54.00	-19.74	AVG			
7	6928.524	40.68	5.46	46.14	74.00	-27.86	peak			
8	6928.524	30.40	5.46	35.86	54.00	-18.14	AVG			
9	9082.470	39.14	9.04	48.18	74.00	-25.82	peak			
10	9082.470	29.84	9.04	38.88	54.00	-15.12	AVG			
11	10597.475	38.20	9.75	47.95	74.00	-26.05	peak			
12	10597.475	28.69	9.75	38.44	54.00	-15.56	AVG			

Note: Average measurement with peak detection at No.2

Job No.: DING #97	Polarization: Vertical
Standard: FCC PK	Power Source: DC 5V
Test item: Radiation Test	Date: 16/12/14/
Temp.(C)/Hum.(%) 25 C / 55 %	Time: 16:55:20
EUT: Chroma Beats Color Changing LED Speaker	Engineer Signature: DING
Mode: TX 2402MHz	Distance: 3m
Model: CB-335115	
Manufacturer: CLEVER BRIGHT	

Note: Report NO.:ATE20162567

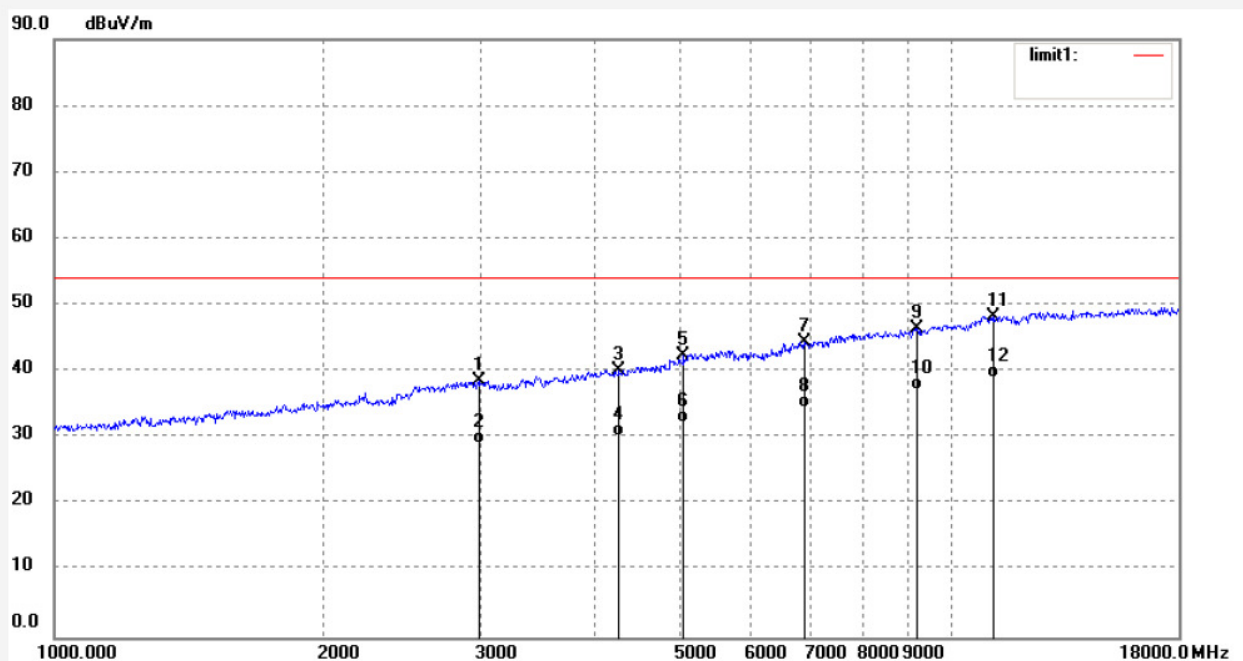

No.	Freq. (MHz)	Reading (dBuV/m)	Factor (dB)	Result (dBuV/m)	Limit (dBuV/m)	Margin (dB)	Detector	Height (cm)	Degree (deg.)	Remark
1	2978.829	44.02	-5.35	38.67	74.00	-35.33	peak			
2	2978.829	34.60	-5.35	29.25	54.00	-24.75	AVG			
3	4273.626	41.66	-1.49	40.17	74.00	-33.83	peak			
4	4273.626	31.74	-1.49	30.25	54.00	-23.75	AVG			
5	5044.887	40.96	1.39	42.35	74.00	-31.65	peak			
6	5044.887	30.85	1.39	32.24	54.00	-21.76	AVG			
7	6868.285	39.17	5.34	44.51	74.00	-29.49	peak			
8	6868.285	29.29	5.34	34.63	54.00	-19.37	AVG			
9	9188.835	37.25	9.22	46.47	74.00	-27.53	peak			
10	9188.835	27.94	9.22	37.16	54.00	-16.84	AVG			
11	11200.070	37.36	10.98	48.34	74.00	-25.66	peak			
12	11200.070	28.10	10.98	39.08	54.00	-14.92	AVG			

Note: Average measurement with peak detection at No.2

Job No.: DING #98

Standard: FCC PK

Test item: Radiation Test

Temp.(C)/Hum.(%) 25 C / 55 %

EUT: Chroma Beats Color Changing LED Speaker

Mode: TX 2441MHz

Model: CB-335115

Manufacturer: CLEVER BRIGHT

Polarization: Vertical

Power Source: DC 5V

Date: 16/12/14/

Time: 16:46:34

Engineer Signature: DING

Distance: 3m

Note: Report NO.:ATE20162567

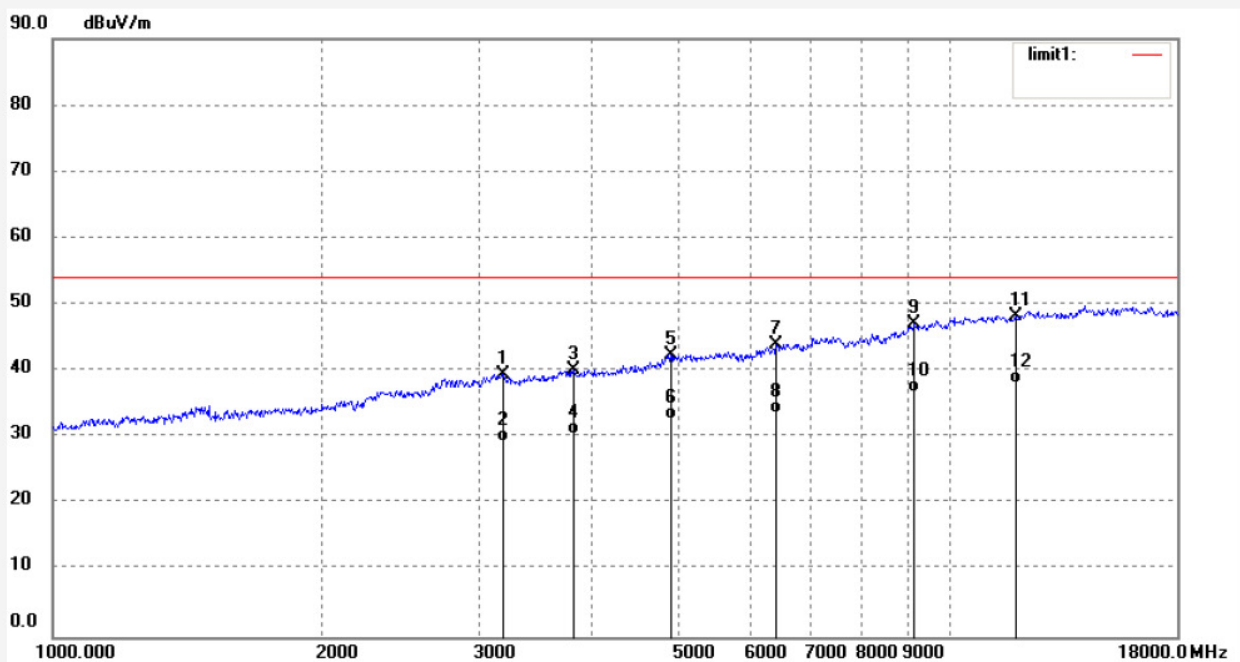

No.	Freq. (MHz)	Reading (dBuV/m)	Factor (dB)	Result (dBuV/m)	Limit (dBuV/m)	Margin (dB)	Detector	Height (cm)	Degree (deg.)	Remark
1	3185.080	43.84	-4.28	39.56	74.00	-34.44	peak			
2	3185.080	33.71	-4.28	29.43	54.00	-24.57	AVG			
3	3815.011	42.01	-1.94	40.07	74.00	-33.93	peak			
4	3815.011	32.40	-1.94	30.46	54.00	-23.54	AVG			
5	4900.160	41.30	1.06	42.36	74.00	-31.64	peak			
6	4900.160	31.59	1.06	32.65	54.00	-21.35	AVG			
7	6423.527	39.48	4.45	43.93	74.00	-30.07	peak			
8	6423.527	29.18	4.45	33.63	54.00	-20.37	AVG			
9	9162.128	37.86	9.17	47.03	74.00	-26.97	peak			
10	9162.128	27.64	9.17	36.81	54.00	-17.19	AVG			
11	11906.038	35.76	12.58	48.34	74.00	-25.66	peak			
12	11906.038	25.61	12.58	38.19	54.00	-15.81	AVG			

Note: Average measurement with peak detection at No.2

Job No.: DING #99

Standard: FCC PK

Test item: Radiation Test

Temp.(C)/Hum.(%) 25 C / 55 %

EUT: Chroma Beats Color Changing LED Speaker

Mode: TX 2441MHz

Model: CB-335115

Manufacturer: CLEVER BRIGHT

Polarization: Horizontal

Power Source: DC 5V

Date: 16/12/14/

Time: 16:49:14

Engineer Signature: DING

Distance: 3m

Note: Report NO.:ATE20162567

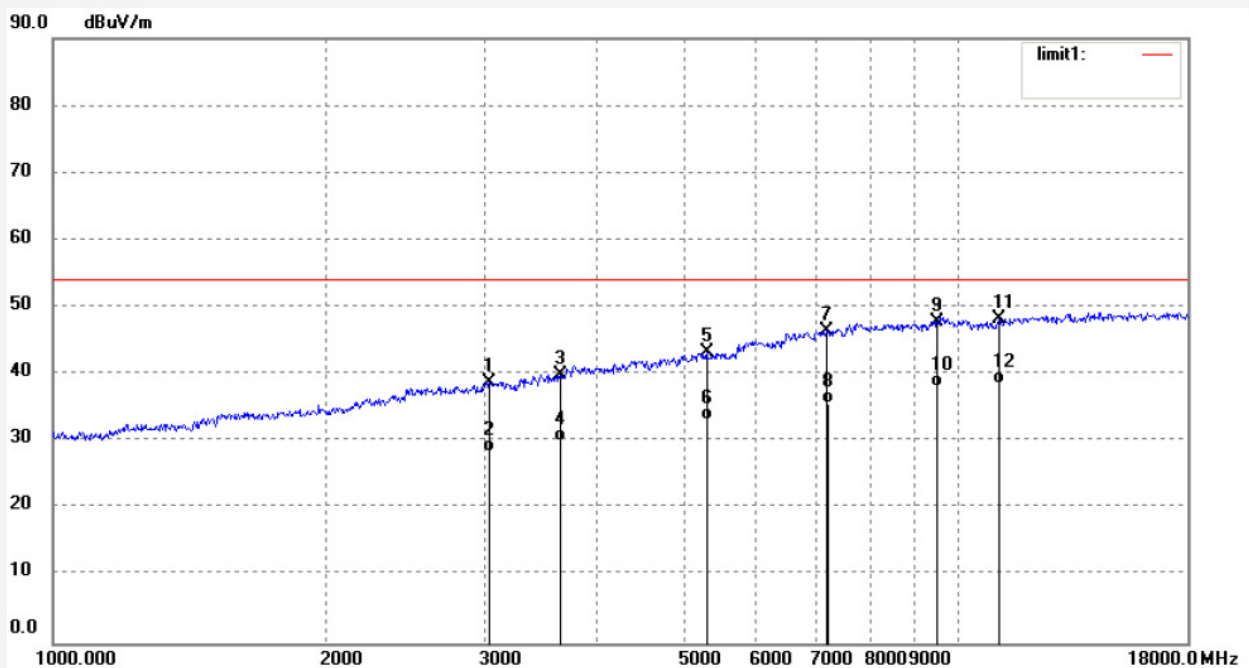

No.	Freq. (MHz)	Reading (dBuV/m)	Factor (dB)	Result (dBuV/m)	Limit (dBuV/m)	Margin (dB)	Detector	Height (cm)	Degree (deg.)	Remark
1	3040.145	43.81	-4.93	38.88	74.00	-35.12	peak			
2	3040.145	33.50	-4.93	28.57	54.00	-25.43	AVG			
3	3641.412	42.40	-2.47	39.93	74.00	-34.07	peak			
4	3641.412	32.48	-2.47	30.01	54.00	-23.99	AVG			
5	5285.395	41.41	1.79	43.20	74.00	-30.80	peak			
6	5285.395	31.42	1.79	33.21	54.00	-20.79	AVG			
7	7174.806	41.91	4.50	46.41	74.00	-27.59	peak			
8	7174.806	31.24	4.50	35.74	54.00	-18.26	AVG			
9	9515.463	37.30	10.60	47.90	74.00	-26.10	peak			
10	9515.463	27.64	10.60	38.24	54.00	-15.76	AVG			
11	11135.058	37.48	10.86	48.34	74.00	-25.66	peak			
12	11135.058	27.79	10.86	38.65	54.00	-15.35	AVG			

Note: Average measurement with peak detection at No.2

Job No.: DING #100

Standard: FCC PK

Test item: Radiation Test

Temp.(C)/Hum.(%) 25 C / 55 %

EUT: Chroma Beats Color Changing LED Speaker

Mode: TX 2480MHz

Model: CB-335115

Manufacturer: CLEVER BRIGHT

Polarization: Horizontal

Power Source: DC 5V

Date: 16/12/14/

Time: 16:41:11

Engineer Signature: DING

Distance: 3m

Note: Report NO.:ATE20162567

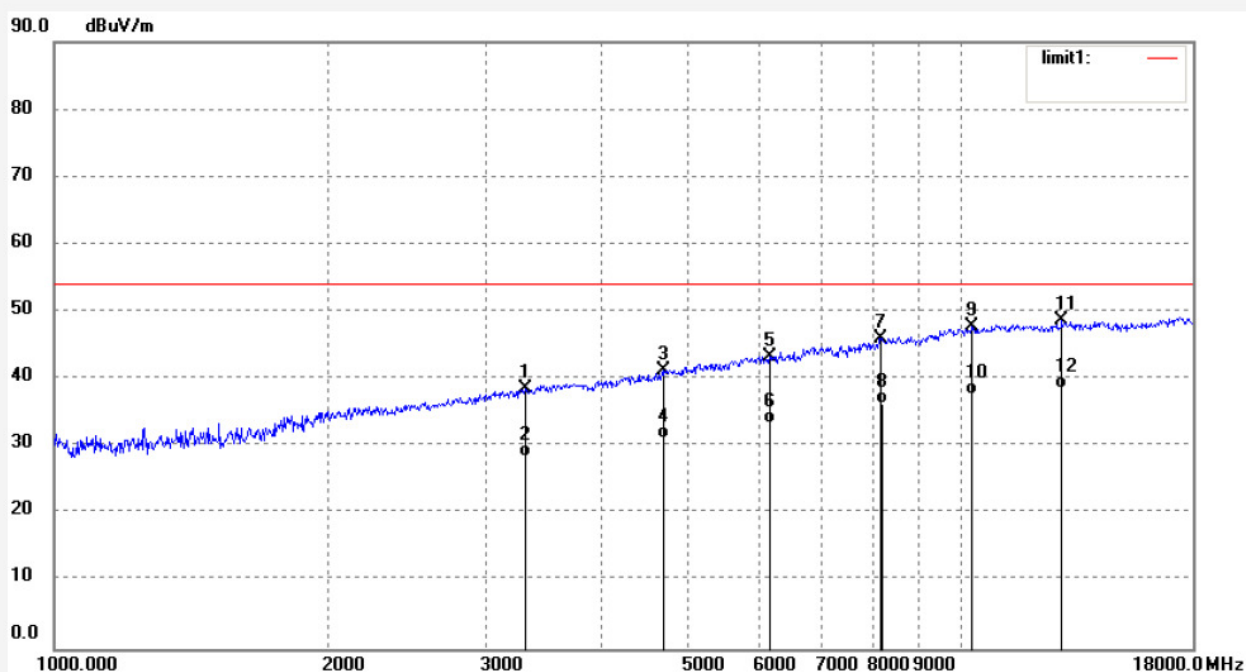

No.	Freq. (MHz)	Reading (dBuV/m)	Factor (dB)	Result (dBuV/m)	Limit (dBuV/m)	Margin (dB)	Detector	Height (cm)	Degree (deg.)	Remark
1	3307.912	42.71	-4.21	38.50	74.00	-35.50	peak			
2	3307.912	32.58	-4.21	28.37	54.00	-25.63	AVG			
3	4690.816	41.55	-0.24	41.31	74.00	-32.69	peak			
4	4690.816	31.49	-0.24	31.25	54.00	-22.75	AVG			
5	6149.102	39.74	3.56	43.30	74.00	-30.70	peak			
6	6149.102	29.84	3.56	33.40	54.00	-20.60	AVG			
7	8155.141	37.39	8.63	46.02	74.00	-27.98	peak			
8	8155.141	27.64	8.63	36.27	54.00	-17.73	AVG			
9	10293.456	37.47	10.28	47.75	74.00	-26.25	peak			
10	10293.456	27.39	10.28	37.67	54.00	-16.33	AVG			
11	12917.030	2.59	46.07	48.66	74.00	-25.34	peak			
12	12917.030	-7.48	46.07	38.59	54.00	-15.41	AVG			

Note: Average measurement with peak detection at No.2

Job No.: DING #101	Polarization: Vertical
Standard: FCC PK	Power Source: DC 5V
Test item: Radiation Test	Date: 16/12/14/
Temp.(C)/Hum.(%) 25 C / 55 %	Time: 16:44:12
EUT: Chroma Beats Color Changing LED Speaker	Engineer Signature: DING
Mode: TX 2480MHz	Distance: 3m
Model: CB-335115	
Manufacturer: CLEVER BRIGHT	

Note: Report NO.:ATE20162567

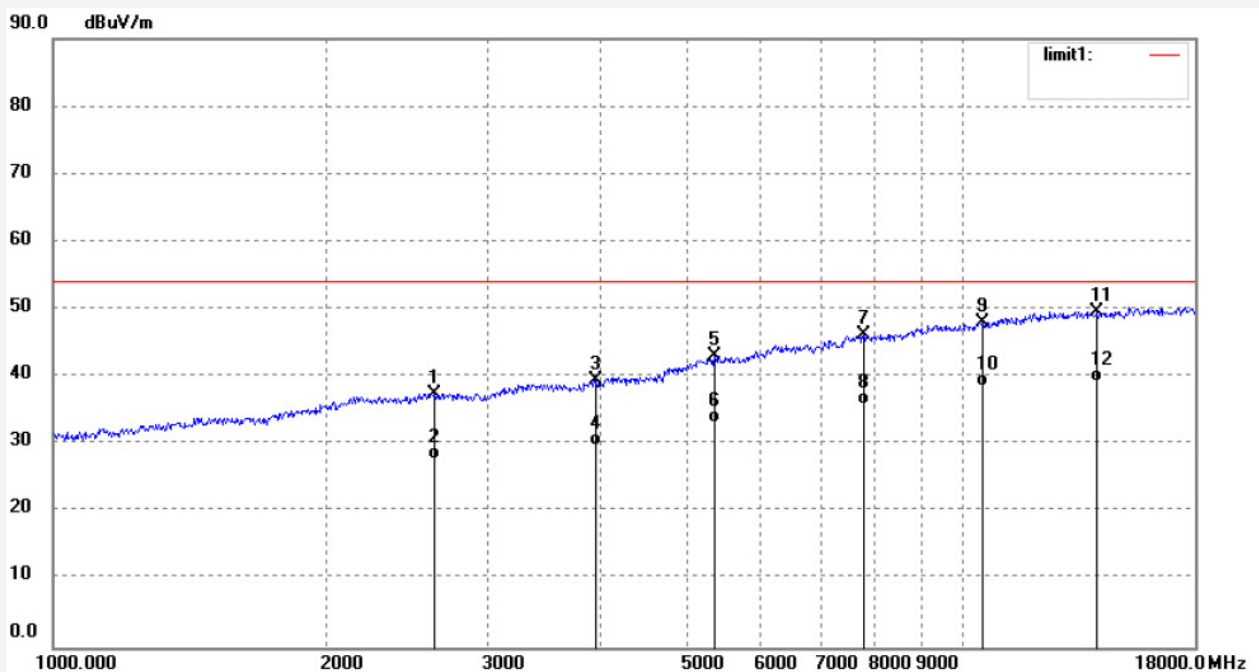

No.	Freq. (MHz)	Reading (dBuV/m)	Factor (dB)	Result (dBuV/m)	Limit (dBuV/m)	Margin (dB)	Detector	Height (cm)	Degree (deg.)	Remark
1	2620.741	44.30	-6.73	37.57	74.00	-36.43	peak			
2	2620.741	34.50	-6.73	27.77	54.00	-26.23	AVG			
3	3950.620	41.12	-1.54	39.58	74.00	-34.42	peak			
4	3950.620	31.26	-1.54	29.72	54.00	-24.28	AVG			
5	5331.750	41.29	1.76	43.05	74.00	-30.95	peak			
6	5331.750	31.50	1.76	33.26	54.00	-20.74	AVG			
7	7784.049	39.63	6.54	46.17	74.00	-27.83	peak			
8	7784.049	29.36	6.54	35.90	54.00	-18.10	AVG			
9	10505.339	38.25	9.89	48.14	74.00	-25.86	peak			
10	10505.339	28.75	9.89	38.64	54.00	-15.36	AVG			
11	14054.720	1.44	48.18	49.62	74.00	-24.38	peak			
12	14054.720	-8.94	48.18	39.24	54.00	-14.76	AVG			

Note: Average measurement with peak detection at No.2

11. BAND EDGE COMPLIANCE TEST

11.1. Block Diagram of Test Setup

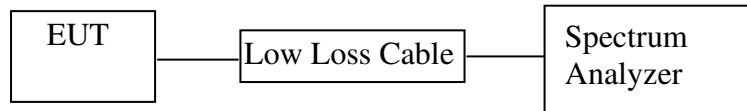

(EUT: Chroma Beats Color Changing LED Speaker)

11.2. The Requirement For Section 15.247(d)

Section 15.247(d): In any 100 kHz bandwidth outside the frequency band in which the spread spectrum or digitally modulated intentional radiator is operating, the radio frequency power that is produced by the intentional radiator shall be at least 20 dB below that in the 100 kHz bandwidth within the band that contains the highest level of the desired power, based on either an RF conducted or a radiated measurement, provided the transmitter demonstrates compliance with the peak conducted power limits. If the transmitter complies with the conducted power limits based on the use of RMS averaging over a time interval, as permitted under paragraph (b)(3) of this section, the attenuation required under this paragraph shall be 30 dB instead of 20 dB. Attenuation below the general limits specified in Section 15.209(a) is not required. In addition, radiated emissions which fall in the restricted bands, as defined in Section 15.205(a), must also comply with the radiated emission limits specified in Section 15.209(a).

11.3. EUT Configuration on Measurement

The equipment are installed on the emission Measurement to meet the commission requirements and operating regulations in a manner which tends to maximize its emission characteristics in normal application.

11.4. Operating Condition of EUT

11.4.1. Setup the EUT and simulator as shown as Section 11.1.

11.4.2. Turn on the power of all equipment.

11.4.3. Let the EUT work in TX (Hopping off, Hopping on) modes measure it. The transmit frequency are 2402-2480MHz. We select 2402MHz, 2480MHz TX frequency to transmit.

11.5. Test Procedure

11.5.1. The transmitter output was connected to the spectrum analyzer via a low loss cable.

11.5.2. Set RBW of spectrum analyzer to 100 kHz and VBW to 300 kHz with convenient frequency span including 100 kHz bandwidth from band edge.

11.5.3. The band edges was measured and recorded.

11.6. Test Result

Frequency (MHz)	Result of Band Edge (dBc)	Limit of Band Edge (dBc)
2399.880	44.49	> 20dBc
2486.860	48.55	> 20dBc

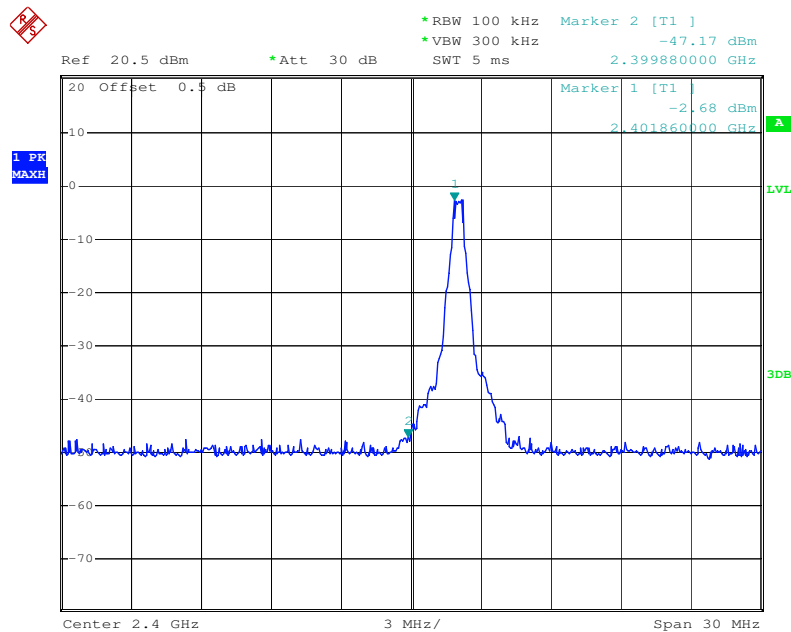

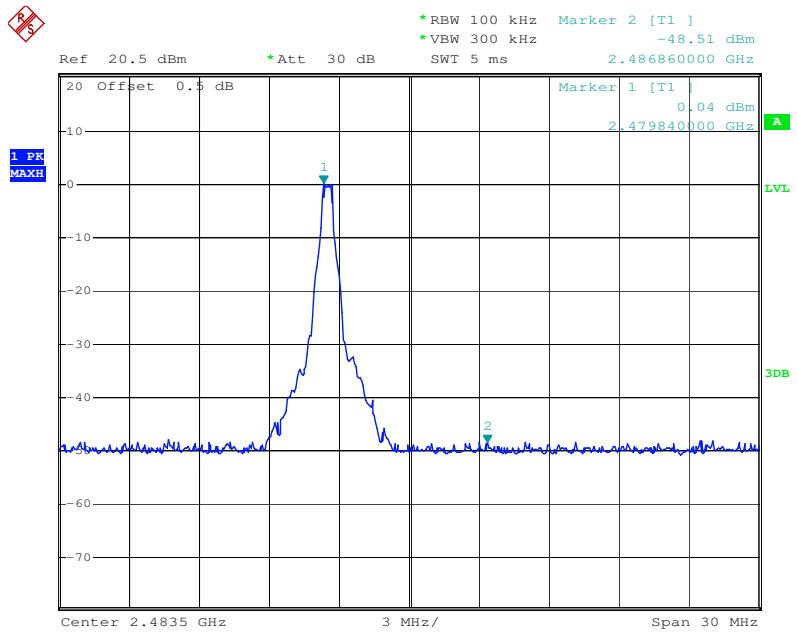

Radiated Band Edge Result

Note:

1. Emissions attenuated more than 20 dB below the permissible value are not reported.
2. The field strength is calculated by adding the antenna factor, high pass filter loss(if used) and cable loss, and subtracting the amplifier gain(if any)from the measured reading. The basic equation calculation is as follows:

Result = Reading + Corrected Factor

3. Display the measurement of peak values.

Test Procedure:

The EUT and its simulators are placed on a turntable, which is 0.1 meter high above ground(Above 1GHz). The turntable can rotate 360 degrees to determine the position of the maximum emission level. EUT is set 3.0 meters away from the receiving antenna, which is mounted on an antenna tower. The antenna can be moved up and down between 1.0 meter and 4 meters to find out the maximum emission level. Broadband antenna (calibrated bi-log antenna) is used as receiving antenna. Both horizontal and vertical polarizations of the antenna are set on measurement. In order to find the maximum emission levels, all of the EUT location must be manipulated according to ANSI C63.10:2013 on radiated emission measurement. The EUT was tested in 3 orthogonal planes.

Let the EUT work in TX (Hopping off, Hopping on) modes measure it.

We select 2402MHz, 2480MHz TX frequency to transmit(Hopping off mode).

We select 2402-2480MHz TX frequency to transmit(Hopping on mode).

During the radiated emission test, the spectrum analyzer was set with the following configurations:

- 1.The resolution bandwidth of test receiver/spectrum analyzer is 1MHz and video bandwidth is 3MHz for peak measurement with peak detector at frequency above 1GHz.
- 2.The resolution bandwidth of test receiver/spectrum analyzer is 1MHz and video bandwidth is 10Hz for Average measurement with peak detection at frequency above 1GHz.
- 3.All modes of operation were investigated and the worst-case emissions are reported.

Non-hopping mode

ACCURATE TECHNOLOGY CO., LTD.

 F1,Bldg.A,Changyuan New Material Port Keyuan Rd,
 Science & Industry Park,Nanshan Shenzhen,P.R.China

Site: 1# Chamber

Tel:+86-0755-26503290

Fax:+86-0755-26503396

Job No.: DING1 #79	Polarization: Horizontal
Standard: FCC PK	Power Source: DC 5V
Test item: Radiation Test	Date: 2016/12/15
Temp.(C)/Hum.(%) 25 C / 55 %	Time: 16:39:56
EUT: Chroma Beats Color Changing LED Speaker	Engineer Signature: DING
Mode: TX 2402MHz	Distance: 3m
Model: CB-335115	
Manufacturer: CLEVER BRIGHT	

Note: Report NO:ATE20162567

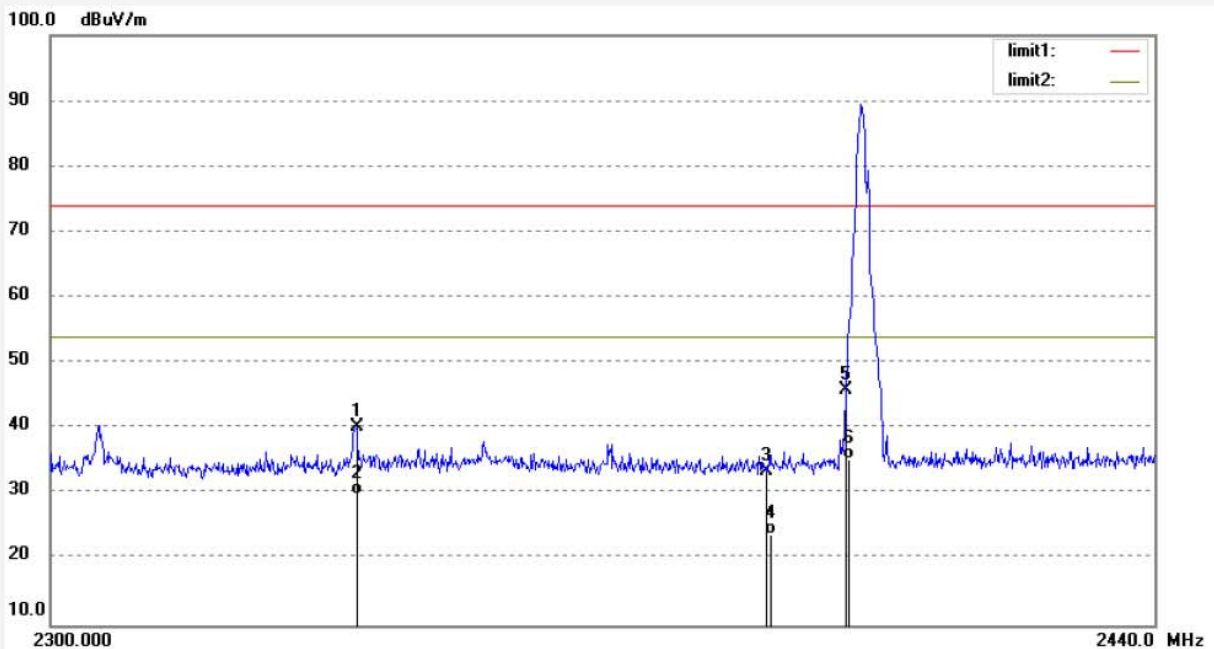

No.	Freq. (MHz)	Reading (dBuV/m)	Factor (dB)	Result (dBuV/m)	Limit (dBuV/m)	Margin (dB)	Detector	Height (cm)	Degree (deg.)	Remark
1	2338.032	46.62	-6.26	40.36	74.00	-33.64	peak			
2	2338.032	36.27	-6.26	30.01	54.00	-23.99	AVG			
3	2390.000	39.37	-5.89	33.48	74.00	-40.52	peak			
4	2390.000	29.64	-5.89	23.75	54.00	-30.25	AVG			
5	2400.000	51.63	-5.80	45.83	74.00	-28.17	peak			
6	2400.000	41.09	-5.80	35.29	54.00	-18.71	AVG			

Note: Average measurement with peak detection at No.2&4



ACCURATE TECHNOLOGY CO., LTD.

F1,Bldg,A,Changyuan New Material Port Keyuan Rd,
Science & Industry Park,Nanshan Shenzhen,P.R.China

Site: 1# Chamber

Tel:+86-0755-26503290

Fax:+86-0755-26503396

Job No.: DING1 #80

Standard: FCC PK

Test item: Radiation Test

Temp.(C)/Hum.(%) 25 C / 55 %

EUT: Chroma Beats Color Changing LED Speaker

Mode: TX 2402MHz

Model: CB-335115

Manufacturer: CLEVER BRIGHT

Polarization: Vertical

Power Source: DC 5V

Date: 2016/12/15

Time: 16:40:56

Engineer Signature: DING

Distance: 3m

Note: Report NO:ATE20162567

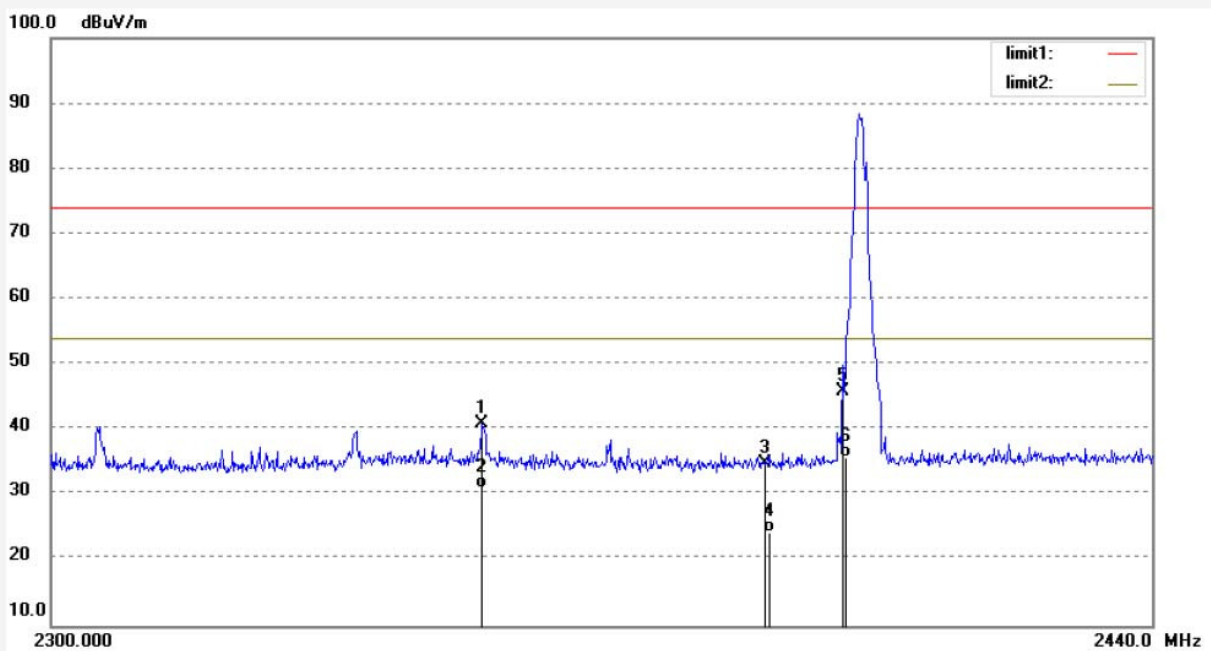

No.	Freq. (MHz)	Reading (dBuV/m)	Factor (dB)	Result (dBuV/m)	Limit (dBuV/m)	Margin (dB)	Detector	Height (cm)	Degree (deg.)	Remark
1	2353.866	47.08	-6.21	40.87	74.00	-33.13	peak			
2	2353.866	37.28	-6.21	31.07	54.00	-22.93	AVG			
3	2390.000	40.67	-5.89	34.78	74.00	-39.22	peak			
4	2390.000	30.15	-5.89	24.26	54.00	-29.74	AVG			
5	2400.000	51.63	-5.80	45.83	74.00	-28.17	peak			
6	2400.000	41.67	-5.80	35.87	54.00	-18.13	AVG			

Note: Average measurement with peak detection at No.2&4



ACCURATE TECHNOLOGY CO., LTD.

F1,Bldg,A,Changyuan New Material Port Keyuan Rd,
Science & Industry Park,Nanshan Shenzhen,P.R.China

Site: 1# Chamber
Tel:+86-0755-26503290
Fax:+86-0755-26503396

Job No.: DING1 #78	Polarization: Horizontal
Standard: FCC PK	Power Source: DC 5V
Test item: Radiation Test	Date: 2016/12/15
Temp.(C)/Hum.(%) 25 C / 55 %	Time: 16:38:25
EUT: Chroma Beats Color Changing LED Speaker	Engineer Signature: DING
Mode: TX 2480MHz	Distance: 3m
Model: CB-335115	
Manufacturer: CLEVER BRIGHT	

Note: Report NO:ATE20162567

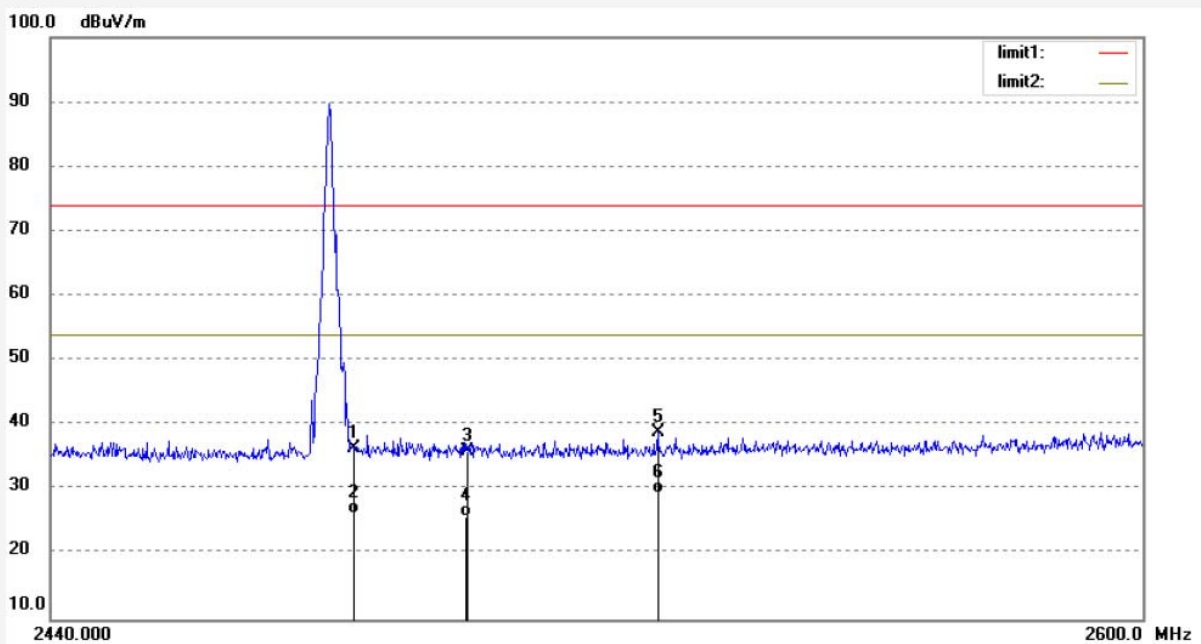

No.	Freq. (MHz)	Reading (dBuV/m)	Factor (dB)	Result (dBuV/m)	Limit (dBuV/m)	Margin (dB)	Detector	Height (cm)	Degree (deg.)	Remark
1	2483.500	41.90	-5.51	36.39	74.00	-37.61	peak			
2	2483.500	31.76	-5.51	26.25	54.00	-27.75	AVG			
3	2500.000	41.59	-5.50	36.09	74.00	-37.91	peak			
4	2500.000	31.44	-5.50	25.94	54.00	-28.06	AVG			
5	2527.722	44.06	-5.23	38.83	74.00	-35.17	peak			
6	2527.722	34.68	-5.23	29.45	54.00	-24.55	AVG			

Note: Average measurement with peak detection at No.2&4



ACCURATE TECHNOLOGY CO., LTD.

F1,Bldg,A,Changyuan New Material Port Keyuan Rd,
Science & Industry Park,Nanshan Shenzhen,P.R.China

Site: 1# Chamber
Tel:+86-0755-26503290
Fax:+86-0755-26503396

Job No.: DING1 #77	Polarization: Vertical
Standard: FCC PK	Power Source: DC 5V
Test item: Radiation Test	Date: 2016/12/15
Temp.(C)/Hum.(%) 25 C / 55 %	Time: 16:37:11
EUT: Chroma Beats Color Changing LED Speaker	Engineer Signature: DING
Mode: TX 2480MHz	Distance: 3m
Model: CB-335115	
Manufacturer: CLEVER BRIGHT	

Note: Report NO:ATE20162567

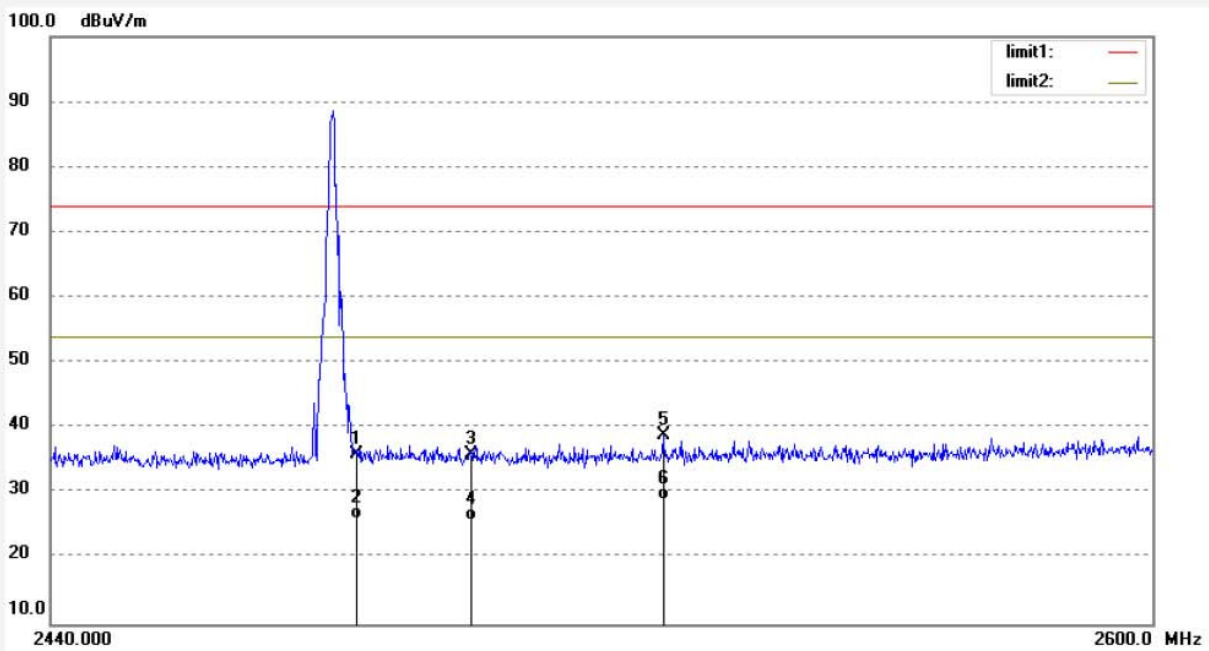

No.	Freq. (MHz)	Reading (dBuV/m)	Factor (dB)	Result (dBuV/m)	Limit (dBuV/m)	Margin (dB)	Detector	Height (cm)	Degree (deg.)	Remark
1	2483.500	41.49	-5.51	35.98	74.00	-38.02	peak			
2	2483.500	31.59	-5.51	26.08	54.00	-27.92	AVG			
3	2500.000	41.59	-5.50	36.09	74.00	-37.91	peak			
4	2500.000	31.47	-5.50	25.97	54.00	-28.03	AVG			
5	2527.722	44.06	-5.23	38.83	74.00	-35.17	peak			
6	2527.722	34.18	-5.23	28.95	54.00	-25.05	AVG			

Note: Average measurement with peak detection at No.2&4

Hopping mode



ACCURATE TECHNOLOGY CO., LTD.

F1,Bldg,A,Changyuan New Material Port Keyuan Rd,
Science & Industry Park,Nanshan Shenzhen,P.R.China

Site: 1# Chamber
Tel:+86-0755-26503290
Fax:+86-0755-26503396

Job No.: DING1 #81

Standard: FCC PK

Test item: Radiation Test

Temp.(C)/Hum.(%) 25 C / 55 %

EUT: Chroma Beats Color Changing LED Speaker

Mode: HOPPING

Model: CB-335115

Manufacturer: CLEVER BRIGHT

Polarization: Vertical

Power Source: DC 5V

Date: 2016/12/15

Time: 16:46:50

Engineer Signature: DING

Distance: 3m

Note: Report NO:ATE20162567

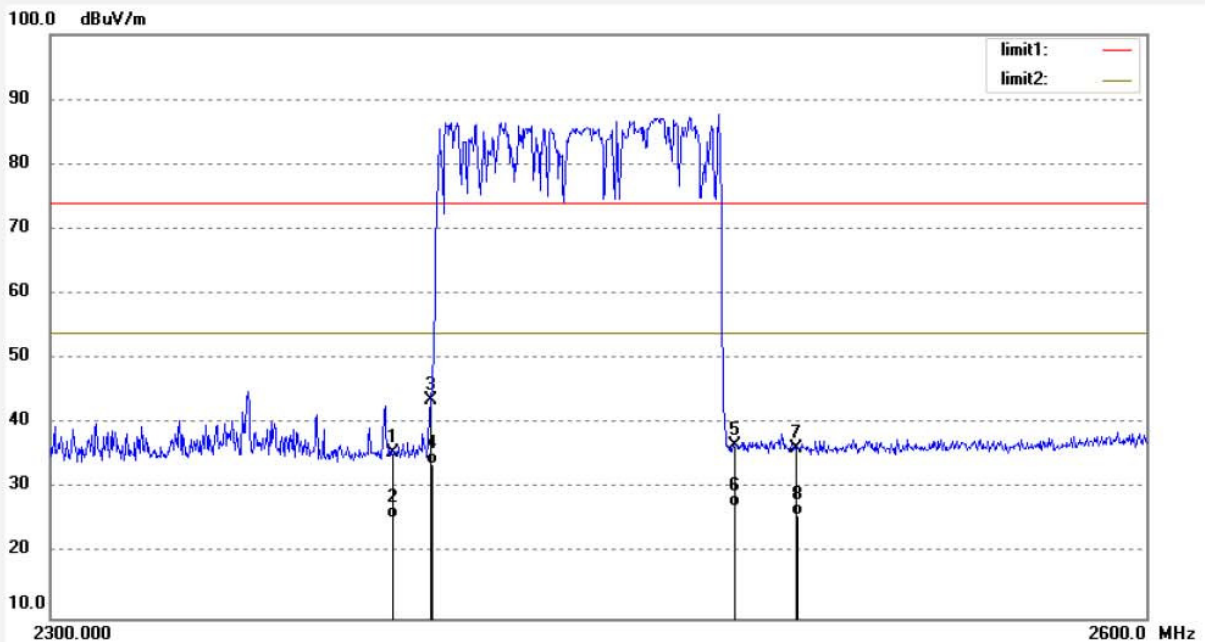

No.	Freq. (MHz)	Reading (dBuV/m)	Factor (dB)	Result (dBuV/m)	Limit (dBuV/m)	Margin (dB)	Detector	Height (cm)	Degree (deg.)	Remark
1	2390.000	41.44	-5.89	35.55	74.00	-38.45	peak			
2	2390.000	31.26	-5.89	25.37	54.00	-28.63	AVG			
3	2400.000	49.35	-5.80	43.55	74.00	-30.45	peak			
4	2400.000	39.54	-5.80	33.74	54.00	-20.26	AVG			
5	2483.500	42.12	-5.51	36.61	74.00	-37.39	peak			
6	2483.500	32.67	-5.51	27.16	54.00	-26.84	AVG			
7	2500.000	41.66	-5.50	36.16	74.00	-37.84	peak			
8	2500.000	31.43	-5.50	25.93	54.00	-28.07	AVG			

Note: Average measurement with peak detection at No.2, 4, 6, 8

Job No.: DING1 #82

Standard: FCC PK

Test item: Radiation Test

Temp.(C)/Hum.(%) 25 C / 55 %

EUT: Chroma Beats Color Changing LED Speaker

Mode: HOPPING

Model: CB-335115

Manufacturer: CLEVER BRIGHT

Polarization: Vertical

Power Source: DC 5V

Date: 2016/12/15

Time: 16:49:08

Engineer Signature: DING

Distance: 3m

Note: Report NO:ATE20162567

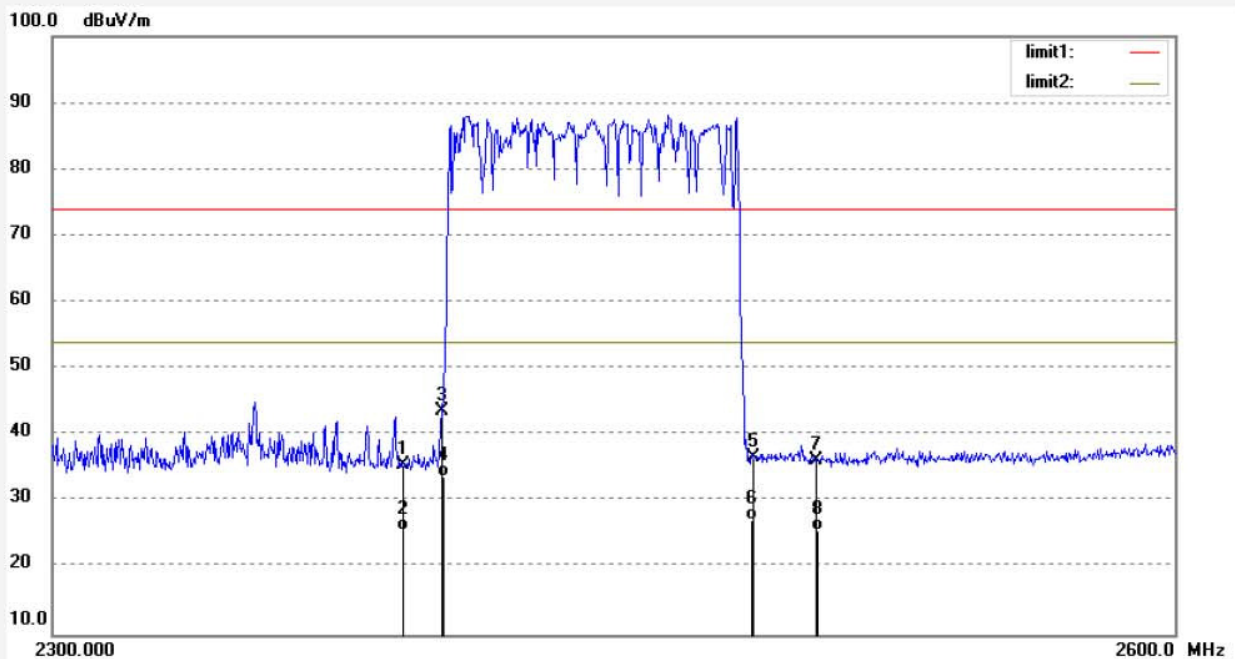

No.	Freq. (MHz)	Reading (dBuV/m)	Factor (dB)	Result (dBuV/m)	Limit (dBuV/m)	Margin (dB)	Detector	Height (cm)	Degree (deg.)	Remark
1	2390.000	41.44	-5.89	35.55	74.00	-38.45	peak			
2	2390.000	31.52	-5.89	25.63	54.00	-28.37	AVG			
3	2400.000	49.35	-5.80	43.55	74.00	-30.45	peak			
4	2400.000	39.54	-5.80	33.74	54.00	-20.26	AVG			
5	2483.500	42.12	-5.51	36.61	74.00	-37.39	peak			
6	2483.500	32.77	-5.51	27.26	54.00	-26.74	AVG			
7	2500.000	41.66	-5.50	36.16	74.00	-37.84	peak			
8	2500.000	31.06	-5.50	25.56	54.00	-28.44	AVG			

Note: Average measurement with peak detection at No.2, 4, 6, 8

12.AC POWER LINE CONDUCTED EMISSION FOR FCC PART

15 SECTION 15.207(A)

12.1.Block Diagram of Test Setup

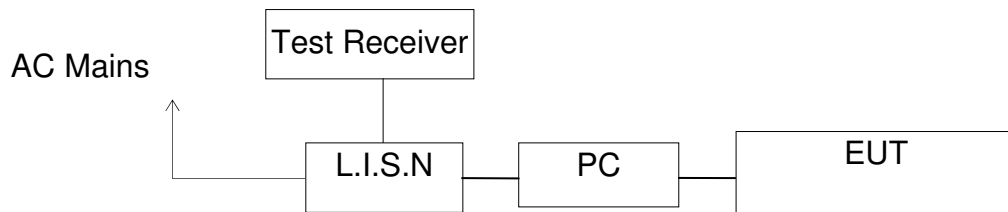

(EUT: Chroma Beats Color Changing LED Speaker)

12.2.Power Line Conducted Emission Measurement Limits

Frequency (MHz)	Limit dB(μV)	
	Quasi-peak Level	Average Level
0.15 - 0.50	66.0 – 56.0 *	56.0 – 46.0 *
0.50 - 5.00	56.0	46.0
5.00 - 30.00	60.0	50.0

NOTE1: The lower limit shall apply at the transition frequencies.
 NOTE2: The limit decreases linearly with the logarithm of the frequency in the range 0.15MHz to 0.50MHz.

12.3.Configuration of EUT on Measurement

The following equipments are installed on Power Line Conducted Emission Measurement to meet the commission requirement and operating regulations in a manner, which tends to maximize its emission characteristics in a normal application.

12.4.Operating Condition of EUT

12.4.1.Setup the EUT and simulator as shown as Section 5.1.

12.4.2.Turn on the power of all equipment.

12.4.3.Let the EUT work in test mode and measure it.

12.5. Test Procedure

The EUT is put on the plane 0.1m high above the ground by insulating support and is connected to the power mains through a line impedance stabilization network (L.I.S.N.). This provides a 50ohm coupling impedance for the EUT system. Please refer the block diagram of the test setup and photographs. Both sides of AC lines are checked to find out the maximum conducted emission. In order to find the maximum emission levels, the relative positions of equipment and all of the interface cables shall be changed according to ANSI C63.4: 2014 on Conducted Emission Measurement.

The bandwidth of test receiver (R & S ESCS30) is set at 9kHz.

The frequency range from 150kHz to 30MHz is checked.

12.6. Power Line Conducted Emission Measurement Results

PASS.

The frequency range from 150kHz to 30MHz is checked.

Test mode : Charging (AC 120V/60Hz)								
EUT mode : CB-335115								
MEASUREMENT RESULT: "CB-1207004_fin"								
2016-12-7 17:29								
Frequency MHz	Level dBµV	Transd dB	Limit dBµV	Margin dB	Detector	Line	PE	
0.180000	55.80	10.8	64.49	8.69	QP	N	GND	
0.485000	38.20	11.0	56.25	18.05	QP	N	GND	
2.110000	34.30	11.3	56	21.7	QP	N	GND	
3.410000	34.70	11.4	60	21.3	QP	N	GND	
5.270000	31.90	11.4	60	28.1	QP	N	GND	
17.525000	28.10	11.7	60	31.9	QP	N	GND	
MEASUREMENT RESULT: "CB-1207004_fin2"								
2016-12-7 17:29								
Frequency MHz	Level dBµV	Transd dB	Limit dBµV	Margin dB	Detector	Line	PE	
0.180000	37.50	10.8	54.49	16.99	AV	N	GND	
0.440000	26.00	11.0	47.06	21.06	AV	N	GND	
2.090000	25.70	11.3	46	20.3	AV	N	GND	
2.950000	27.50	11.3	46	18.5	AV	N	GND	
5.290000	26.00	11.4	50	24.0	AV	N	GND	
18.975000	21.40	11.7	50	28.6	AV	N	GND	
MEASUREMENT RESULT: "CB-1207003_fin"								
2016-12-7 17:27								
Frequency MHz	Level dBµV	Transd dB	Limit dBµV	Margin dB	Detector	Line	PE	
0.170000	59.00	10.8	64.96	5.96	QP	L1	GND	
0.545000	38.40	11.0	56	17.6	QP	L1	GND	
2.110000	34.00	11.3	56	22.0	QP	L1	GND	
3.110000	35.60	11.3	60	20.4	QP	L1	GND	
5.290000	30.40	11.4	60	29.6	QP	L1	GND	
18.225000	30.40	11.7		29.6	QP	L1	GND	
MEASUREMENT RESULT: "CB-1207003_fin2"								
2016-12-7 17:27								
Frequency MHz	Level dBµV	Transd dB	Limit dBµV	Margin dB	Detector	Line	PE	
0.175000	41.30	10.8	54.72	13.42	AV	L1	GND	
0.540000	24.00	11.0	46	22.0	AV	L1	GND	
2.030000	25.20	11.3	46	20.8	AV	L1	GND	
3.400000	26.10	11.4	46	19.9	AV	L1	GND	
5.410000	23.60	11.5	50	26.4	AV	L1	GND	
18.950000	22.90	11.7	50	27.1	AV	L1	GND	

Test mode : Charging (AC 240V/60Hz) EUT mode : CB-335115								
MEASUREMENT RESULT: "CB-1207001_fin"								
2016-12-7 17:23								
Frequency	Level	Transd	Limit	Margin	Detector	Line	PE	
MHz	dBµV	dB	dBµV	dB				
0.165000	62.20	10.8	65.21	3.01	QP	N	GND	
0.535000	41.00	11.0	56	15.0	QP	N	GND	
1.800000	32.60	11.2	56	23.4	QP	N	GND	
3.020000	37.90	11.3	56	18.1	QP	N	GND	
5.620000	33.00	11.5	60	27.0	QP	N	GND	
18.975000	30.00	11.7	60	30.0	QP	N	GND	
MEASUREMENT RESULT: "CB-1207001_fin2"								
2016-12-7 17:23								
Frequency	Level	Transd	Limit	Margin	Detector	Line	PE	
MHz	dBµV	dB	dBµV	dB				
0.165000	47.60	10.8	55.21	7.61	AV	N	GND	
0.530000	31.00	11.0	46	15.0	AV	N	GND	
1.970000	29.20	11.3	46	16.8	AV	N	GND	
2.940000	29.20	11.3	46	16.8	AV	N	GND	
5.460000	27.30	11.5	50	22.7	AV	N	GND	
19.325000	20.80	11.7	50	29.2	AV	N	GND	
MEASUREMENT RESULT: "CB-1207002_fin"								
2016-12-7 17:25								
Frequency	Level	Transd	Limit	Margin	Detector	Line	PE	
MHz	dBµV	dB	dBµV	dB				
0.160000	62.50	10.8	65.46	2.96	QP	L1	GND	
0.515000	39.70	11.0	56	16.3	QP	L1	GND	
2.020000	36.20	11.3	56	19.8	QP	L1	GND	
2.810000	36.50	11.3	56	19.5	QP	L1	GND	
5.410000	32.40	11.5	60	27.6	QP	L1	GND	
20.000000	27.00	11.7	60	33.0	QP	L1	GND	
MEASUREMENT RESULT: "CB-1207002_fin2"								
2016-12-7 17:25								
Frequency	Level	Transd	Limit	Margin	Detector	Line	PE	
MHz	dBµV	dB	dBµV	dB				
0.160000	46.30	10.8	55.46	9.16	AV	L1	GND	
0.540000	31.90	11.0	46	14.1	AV	L1	GND	
2.020000	29.20	11.3	46	16.8	AV	L1	GND	
2.710000	29.80	11.3	46	16.2	AV	L1	GND	
5.340000	26.10	11.5	50	23.9	AV	L1	GND	
23.750000	21.20	11.7	50	28.8	AV	L1	GND	

Emissions attenuated more than 20 dB below the permissible value are not reported.

The spectral diagrams are attached as below.

ACCURATE TECHNOLOGY CO., LTD

CONDUCTED EMISSION STANDARD FCC PART 15B

EUT: Chroma Beats Color Changing LED Speaker M/N:CB-335115
 Manufacturer: CLEVER BRIGHT
 Operating Condition: Charging
 Test Site: 2#Shielding Room
 Operator: DING
 Test Specification: N 120V/60Hz
 Comment: Report NO.: ATE20162567
 Start of Test: 2016-12-7 / 17:28:18

SCAN TABLE: "V 150K-30MHz fin"

Short Description: _SUB_STD_VTERM2 1.70
 Start Stop Step Detector Meas. IF Transducer
 Frequency Frequency Width Time Bandw.
 150.0 kHz 30.0 MHz 4.5 kHz QuasiPeak 1.0 s 9 kHz NSLK8126 2008
 Average

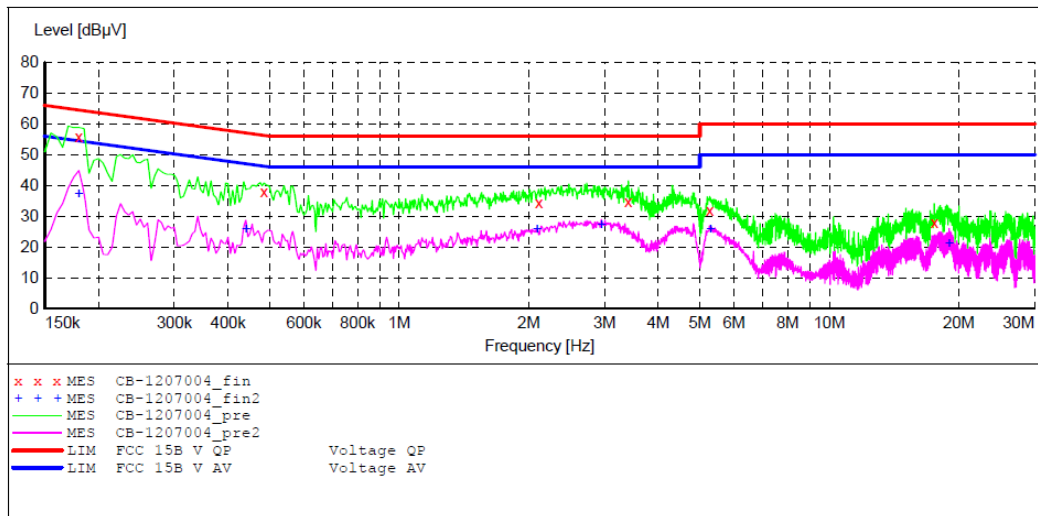

MEASUREMENT RESULT: "CB-1207004_fin"

2016-12-7 17:29

Frequency MHz	Level dBµV	Transd dB	Limit dBµV	Margin dB	Detector	Line	PE
0.180000	55.80	10.8	64.49	8.69	QP	N	GND
0.485000	38.20	11.0	56.25	18.05	QP	N	GND
2.110000	34.30	11.3	60	21.7	QP	N	GND
3.410000	34.70	11.4	60	21.3	QP	N	GND
5.270000	31.90	11.4	60	28.1	QP	N	GND
17.525000	28.10	11.7	60	31.9	QP	N	GND

MEASUREMENT RESULT: "CB-1207004_fin2"

2016-12-7 17:29

Frequency MHz	Level dBµV	Transd dB	Limit dBµV	Margin dB	Detector	Line	PE
0.180000	37.50	10.8	54.49	16.99	AV	N	GND
0.440000	26.00	11.0	47.06	21.06	AV	N	GND
2.090000	25.70	11.3	46	20.3	AV	N	GND
2.950000	27.50	11.3	46	18.5	AV	N	GND
5.290000	26.00	11.4	50	24.0	AV	N	GND
18.975000	21.40	11.7	50	28.6	AV	N	GND

ACCURATE TECHNOLOGY CO.,LTD

CONDUCTED EMISSION STANDARD FCC PART 15B

EUT: Chroma Beats Color Changing LED Speaker M/N:CB-335115
 Manufacturer: CLEVER BRIGHT
 Operating Condition: Charging
 Test Site: 2#Shielding Room
 Operator: DING
 Test Specification: L 120V/60Hz
 Comment: Report NO.: ATE20162567
 Start of Test: 2016-12-7 / 17:26:35

SCAN TABLE: "V 150K-30MHz fin"

Short Description:		_SUB_STD_VTERM2 1.70					
Start	Stop	Step	Detector	Meas. Time	IF Bandw.	Transducer	
150.0 kHz	30.0 MHz	4.5 kHz	QuasiPeak	1.0 s	9 kHz	NSLK8126 2008	
			Average				

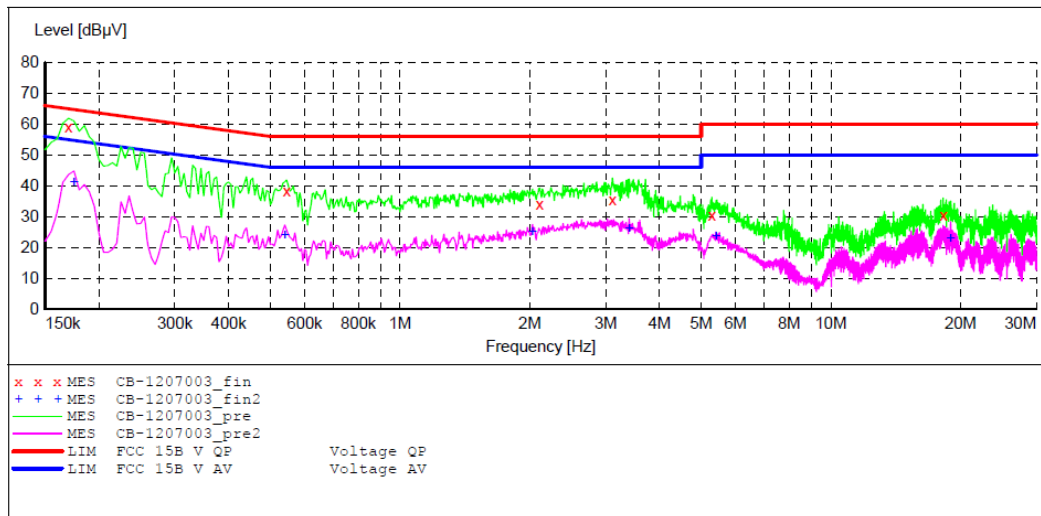

MEASUREMENT RESULT: "CB-1207003_fin"

2016-12-7 17:27

Frequency MHz	Level dBµV	Transd dB	Limit dBµV	Margin dB	Detector	Line	PE
0.170000	59.00	10.8	64.96	5.96	QP	L1	GND
0.545000	38.40	11.0	56	17.6	QP	L1	GND
2.110000	34.00	11.3	56	22.0	QP	L1	GND
3.110000	35.60	11.3	60	20.4	QP	L1	GND
5.290000	30.40	11.4	60	29.6	QP	L1	GND
18.225000	30.40	11.7		29.6	QP	L1	GND

MEASUREMENT RESULT: "CB-1207003_fin2"

2016-12-7 17:27

Frequency MHz	Level dBµV	Transd dB	Limit dBµV	Margin dB	Detector	Line	PE
0.175000	41.30	10.8	54.72	13.42	AV	L1	GND
0.540000	24.00	11.0	46	22.0	AV	L1	GND
2.030000	25.20	11.3	46	20.8	AV	L1	GND
3.400000	26.10	11.4	46	19.9	AV	L1	GND
5.410000	23.60	11.5	50	26.4	AV	L1	GND
18.950000	22.90	11.7	50	27.1	AV	L1	GND

ACCURATE TECHNOLOGY CO., LTD

CONDUCTED EMISSION STANDARD FCC PART 15B

EUT: Chroma Beats Color Changing LED Speaker M/N:CB-335115
 Manufacturer: CLEVER BRIGHT
 Operating Condition: Charging
 Test Site: 2#Shielding Room
 Operator: DING
 Test Specification: N 240V/60Hz
 Comment: Report NO.: ATE20162567
 Start of Test: 2016-12-7 / 17:22:27

SCAN TABLE: "V 150K-30MHz fin"

Short Description: _SUB_STD_VTERM2 1.70
 Start Stop Step Detector Meas. IF Transducer
 Frequency Frequency Width Time Bandw.
 150.0 kHz 30.0 MHz 4.5 kHz QuasiPeak 1.0 s 9 kHz NSLK8126 2008
 Average

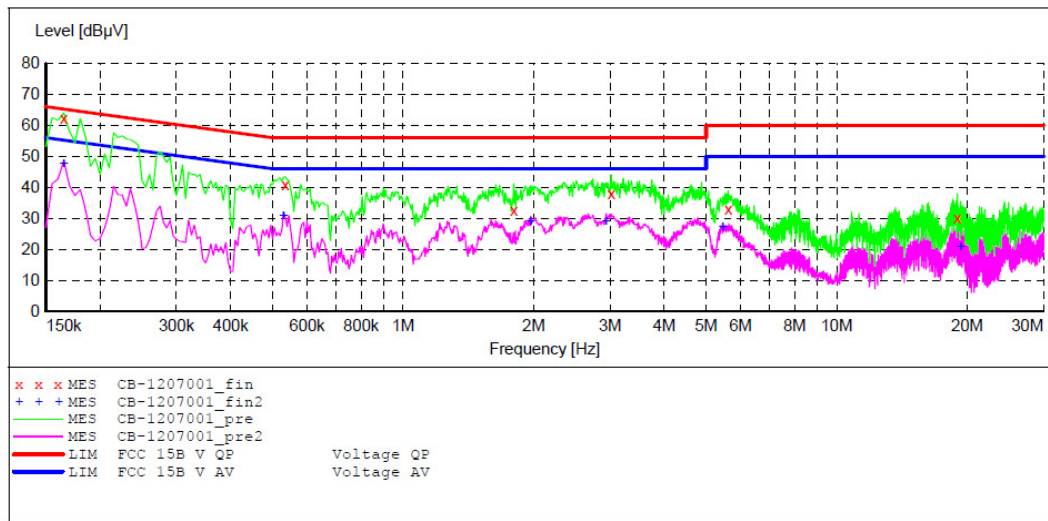

MEASUREMENT RESULT: "CB-1207001_fin"

2016-12-7 17:23

Frequency MHz	Level dBµV	Transd dB	Limit dBµV	Margin dB	Detector	Line	PE
0.165000	62.20	10.8	65.21	3.01	QP	N	GND
0.535000	41.00	11.0	56	15.0	QP	N	GND
1.800000	32.60	11.2	56	23.4	QP	N	GND
3.020000	37.90	11.3	56	18.1	QP	N	GND
5.620000	33.00	11.5	60	27.0	QP	N	GND
18.975000	30.00	11.7	60	30.0	QP	N	GND

MEASUREMENT RESULT: "CB-1207001_fin2"

2016-12-7 17:23

Frequency MHz	Level dBµV	Transd dB	Limit dBµV	Margin dB	Detector	Line	PE
0.165000	47.60	10.8	55.21	7.61	AV	N	GND
0.530000	31.00	11.0	46	15.0	AV	N	GND
1.970000	29.20	11.3	46	16.8	AV	N	GND
2.940000	29.20	11.3	46	16.8	AV	N	GND
5.460000	27.30	11.5	50	22.7	AV	N	GND
19.325000	20.80	11.7	50	29.2	AV	N	GND

ACCURATE TECHNOLOGY CO., LTD

CONDUCTED EMISSION STANDARD FCC PART 15B

EUT: Chroma Beats Color Changing LED Speaker M/N:CB-335115
 Manufacturer: CLEVER BRIGHT
 Operating Condition: Charging
 Test Site: 2#Shielding Room
 Operator: DING
 Test Specification: L 240V/60Hz
 Comment: Report NO.: ATE20162567
 Start of Test: 2016-12-7 / 17:23:51

SCAN TABLE: "V 150K-30MHZ fin"

Short Description: _SUB_STD_VTERM2 1.70
 Start Stop Step Detector Meas. IF Transducer
 Frequency Frequency Width Time Bandw.
 150.0 kHz 30.0 MHz 4.5 kHz QuasiPeak 1.0 s 9 kHz NSLK8126 2008
 Average

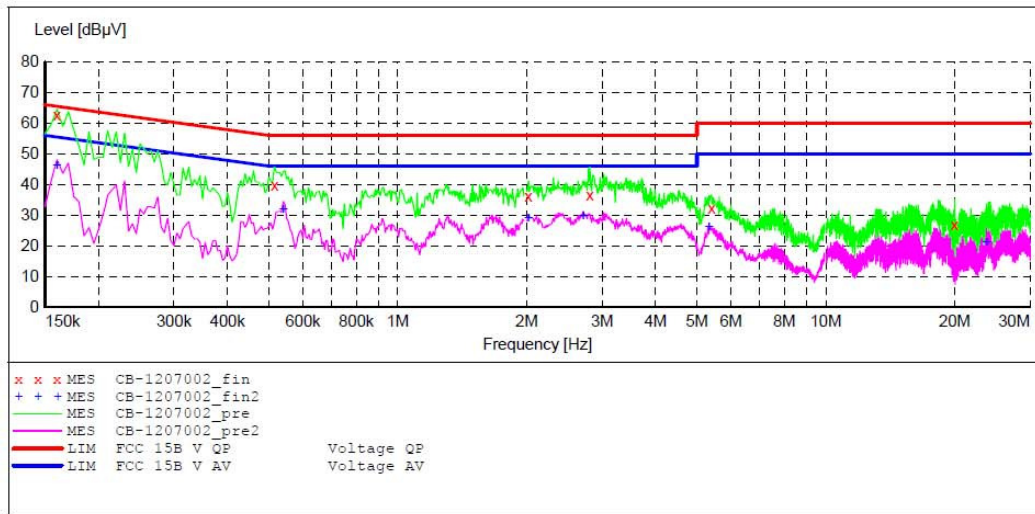

MEASUREMENT RESULT: "CB-1207002_fin"

2016-12-7 17:25

Frequency MHz	Level dBuV	Transd dB	Limit dBuV	Margin dB	Detector	Line	PE
0.160000	62.50	10.8	65.46	2.96	QP	L1	GND
0.515000	39.70	11.0	56	16.3	QP	L1	GND
2.020000	36.20	11.3	56	19.8	QP	L1	GND
2.810000	36.50	11.3	56	19.5	QP	L1	GND
5.410000	32.40	11.5	60	27.6	QP	L1	GND
20.000000	27.00	11.7	60	33.0	QP	L1	GND

MEASUREMENT RESULT: "CB-1207002_fin2"

2016-12-7 17:25

Frequency MHz	Level dBuV	Transd dB	Limit dBuV	Margin dB	Detector	Line	PE
0.160000	46.30	10.8	55.46	9.16	AV	L1	GND
0.540000	31.90	11.0	46	14.1	AV	L1	GND
2.020000	29.20	11.3	46	16.8	AV	L1	GND
2.710000	29.80	11.3	46	16.2	AV	L1	GND
5.340000	26.10	11.5	50	23.9	AV	L1	GND
23.750000	21.20	11.7	50	28.8	AV	L1	GND

13.ANTENNA REQUIREMENT

13.1.The Requirement

According to Section 15.203, an intentional radiator shall be designed to ensure that no antenna other than that furnished by the responsible party shall be used with the device.

13.2.Antenna Construction

Device is equipped with permanent attached antenna, which isn't displaced by other antenna. The Antenna gain of EUT is 0dBi. Therefore, the equipment complies with the antenna requirement of Section 15.203.

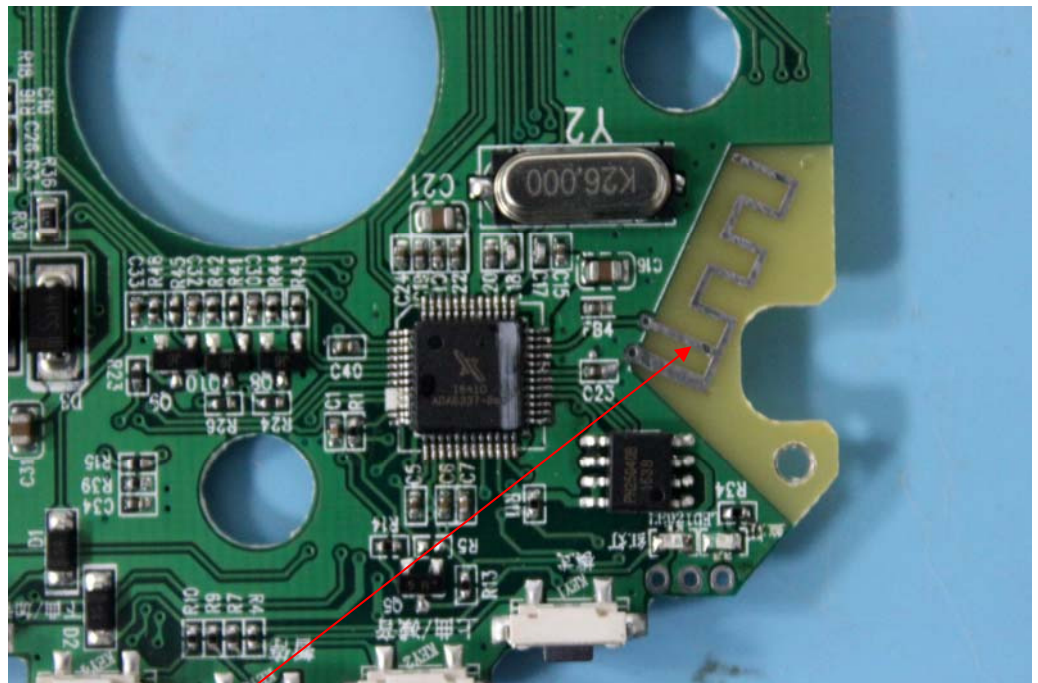

Antenna

14.PHOTOGRAPHS

14.1.Photo of Power Line Conducted Emission Measurement



14.2.Photo of Radiation Emission Measurement

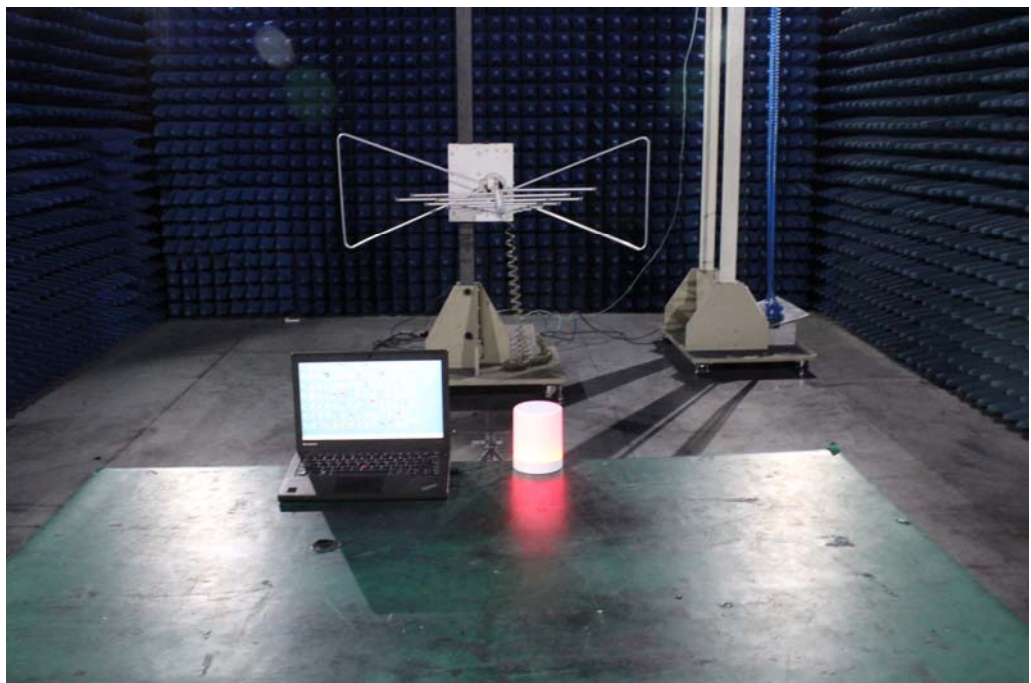

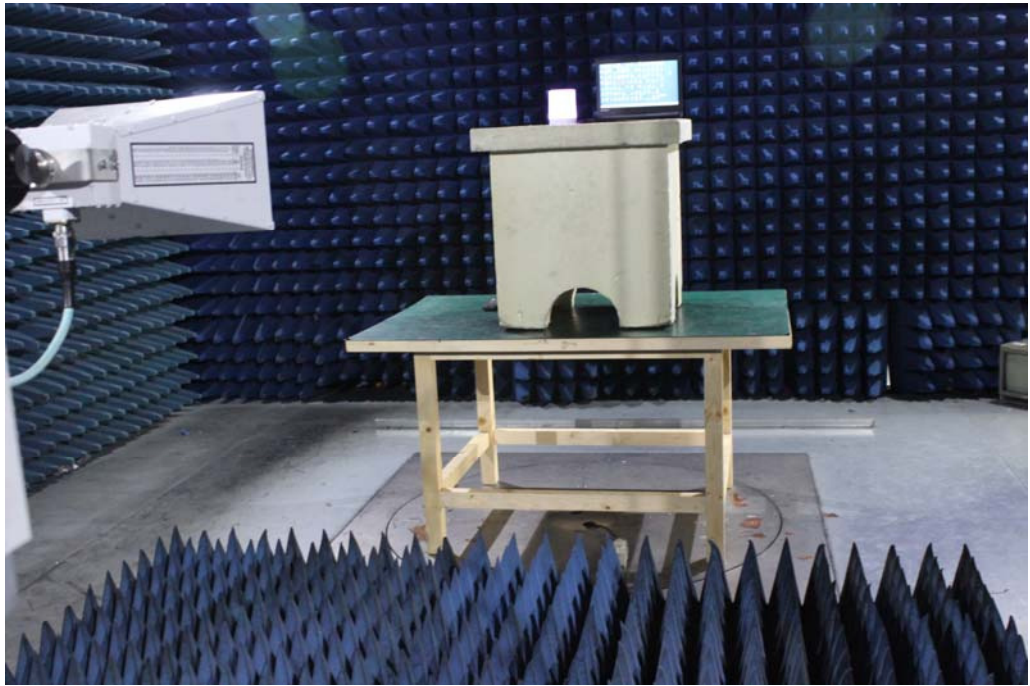

14.3.Photo of EUT







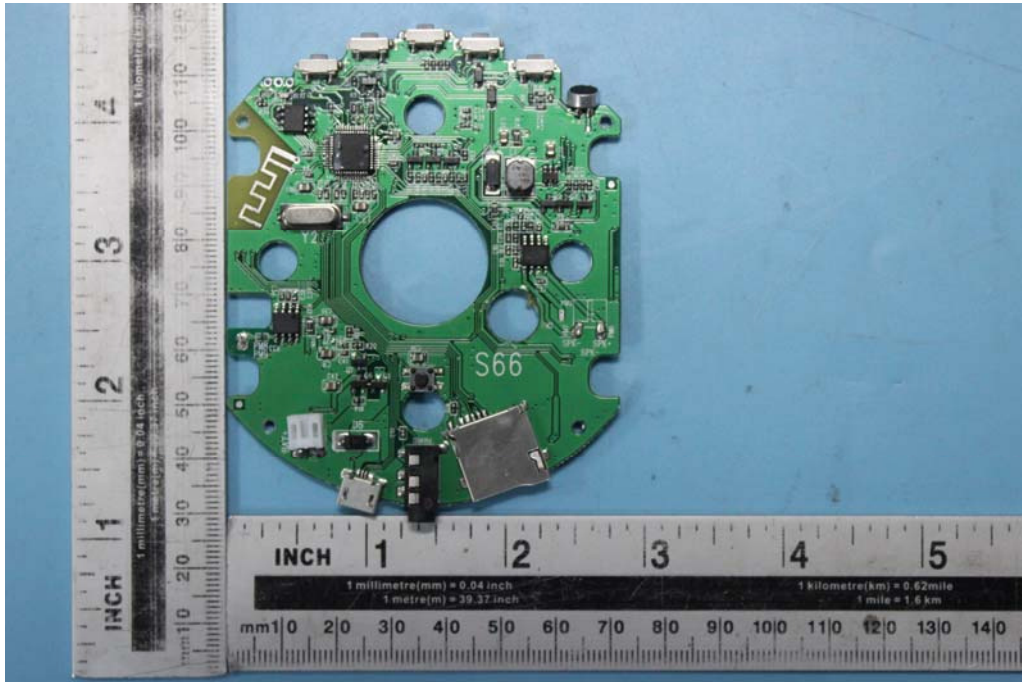
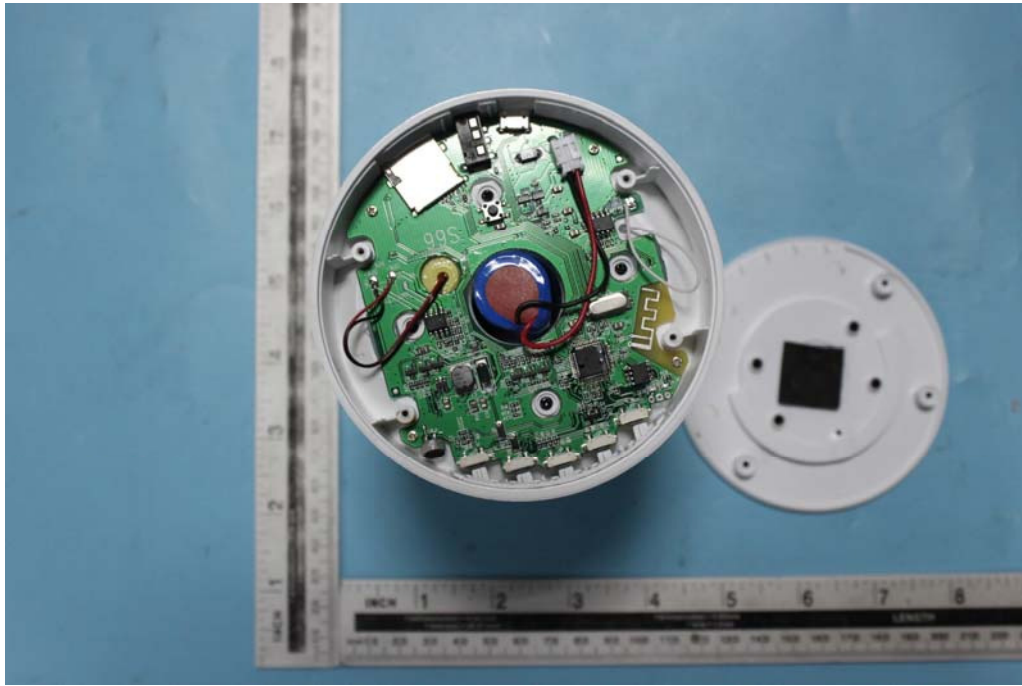

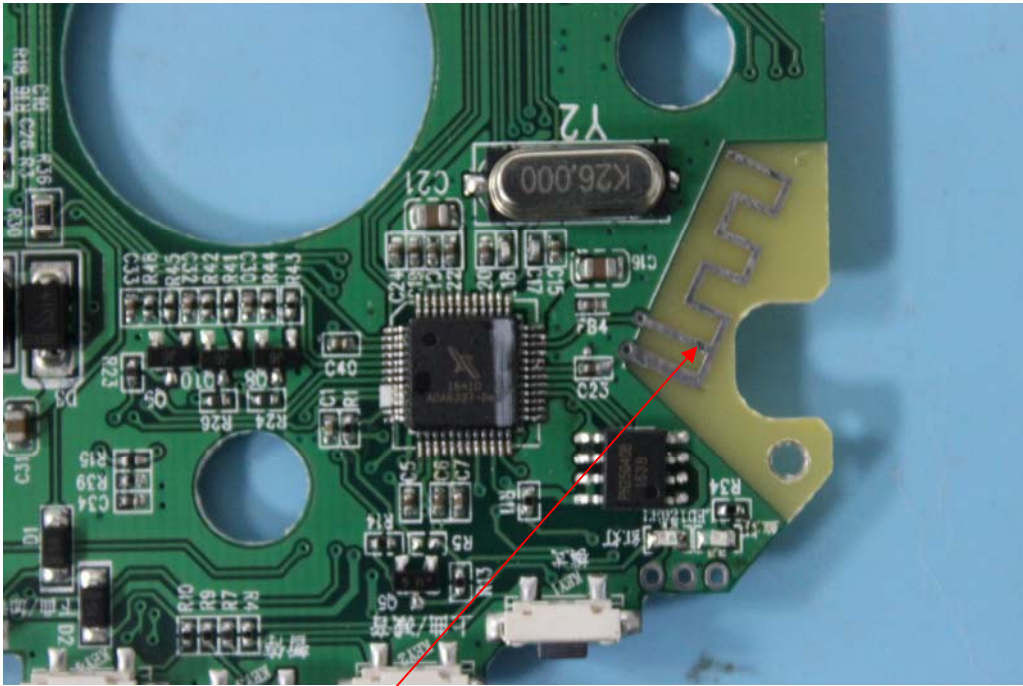
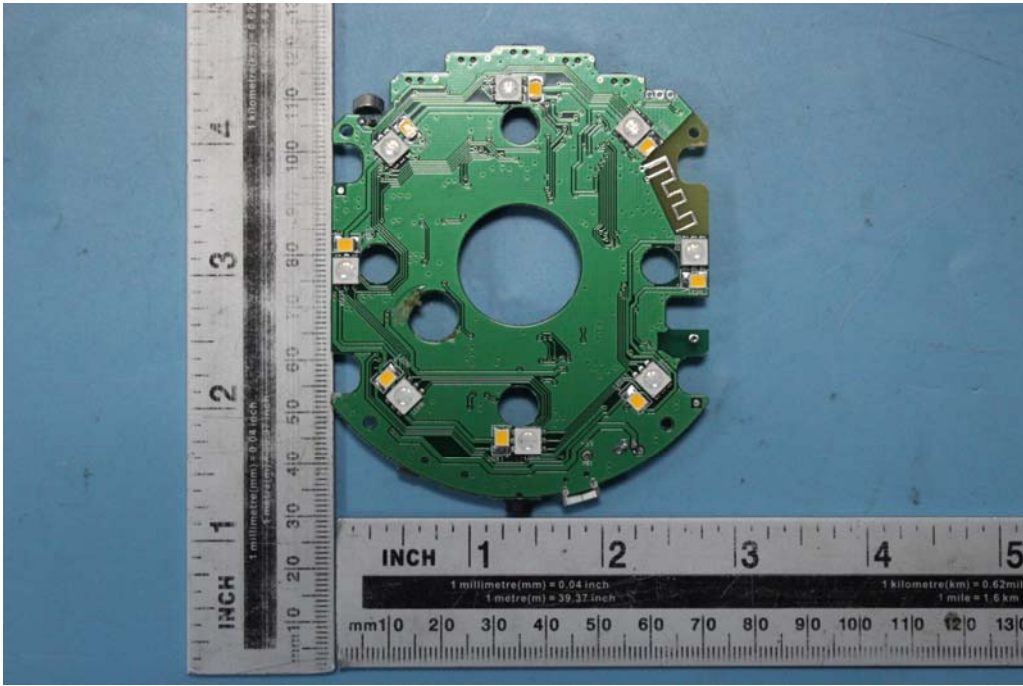

Antenna