

APPLICATION CERTIFICATION FCC Part 15C
On Behalf of
CLEVER BRIGHT INTERNATIONAL (H.K.) LTD.

LED Power Pulse Speaker-blk box

Model No.: CB-335072B, 74309, CB-335089L,
CB-335090, CB-335050, CB-335091

FCC ID: 2AD42-CB-335072B

Prepared for : CLEVER BRIGHT INTERNATIONAL (H.K.) LTD.
Address : Rm 1701, Zhuoyue Building, Fuhua Yi Rd., Futian Central Zone,
Shenzhen, P.R.China.

Prepared by : ACCURATE TECHNOLOGY CO., LTD
Address : F1, Bldg. A&D, Chan Yuan New Material Port, Keyuan Rd.
Science & Industry Park, Nan Shan, Shenzhen, Guangdong P.R.
China

Tel: (0755) 26503290
Fax: (0755) 26503396

Report No. : ATE20170488
Date of Test : Apr. 13, 2017-Apr. 18, 2017
Date of Report : Apr. 19, 2017

TABLE OF CONTENTS

Description	Page
Test Report Certification	
1. GENERAL INFORMATION	5
1.1. Description of Device (EUT).....	5
1.2. Carrier Frequency of Channels	6
1.3. Special Accessory and Auxiliary Equipment	7
1.4. Description of Test Facility	7
1.5. Measurement Uncertainty	7
2. MEASURING DEVICE AND TEST EQUIPMENT	8
3. OPERATION OF EUT DURING TESTING	9
3.1. Operating Mode	9
3.2. Configuration and peripherals	9
4. TEST PROCEDURES AND RESULTS	10
5. POWER LINE CONDUCTED MEASUREMENT	11
5.1. Block Diagram of Test Setup.....	11
5.2. Power Line Conducted Emission Measurement Limits.....	11
5.3. Configuration of EUT on Measurement	11
5.4. Operating Condition of EUT	11
5.5. Test Procedure	12
5.6. Power Line Conducted Emission Measurement Results	12
6. 6DB BANDWIDTH MEASUREMENT	15
6.1. Block Diagram of Test Setup.....	15
6.2. The Requirement For Section 15.247(a)(2)	15
6.3. EUT Configuration on Measurement	15
6.4. Operating Condition of EUT	15
6.5. Test Procedure	15
6.6. Test Result	16
7. MAXIMUM PEAK OUTPUT POWER	18
7.1. Block Diagram of Test Setup.....	18
7.2. The Requirement For Section 15.247(b)(3).....	18
7.3. EUT Configuration on Measurement	18
7.4. Operating Condition of EUT	18
7.5. Test Procedure	18
7.6. Test Result	19
8. POWER SPECTRAL DENSITY MEASUREMENT.....	21
8.1. Block Diagram of Test Setup.....	21
8.2. The Requirement For Section 15.247(e).....	21
8.3. EUT Configuration on Measurement	21
8.4. Operating Condition of EUT	21
8.5. Test Procedure	22
8.6. Test Result	23
9. BAND EDGE COMPLIANCE TEST	25
9.1. Block Diagram of Test Setup.....	25
9.2. The Requirement For Section 15.247(d)	25
9.3. EUT Configuration on Measurement	25
9.4. Operating Condition of EUT	25

9.5.	Test Procedure	26
9.6.	Test Result	26
10.	RADIATED SPURIOUS EMISSION TEST	32
10.1.	Block Diagram of Test Setup.....	32
10.2.	The Limit For Section 15.247(d)	33
10.3.	Restricted bands of operation	34
10.4.	Configuration of EUT on Measurement	34
10.5.	Operating Condition of EUT	35
10.6.	Test Procedure	35
10.7.	The Field Strength of Radiation Emission Measurement Results	35
11.	ANTENNA REQUIREMENT.....	48
11.1.	The Requirement	48
11.2.	Antenna Construction	48

Test Report Certification

Applicant : CLEVER BRIGHT INTERNATIONAL (H.K.) LTD.
Manufacturer : CLEVER BRIGHT INTERNATIONAL (H.K.) LTD.
EUT Description : LED Power Pulse Speaker-blk box
Model No. : CB-335072B, 74309, CB-335089L, CB-335090,
CB-335050, CB-335091
Note: these models are identical in schematic, structure and critical components
except for model name. So we prepare CB-335072B for test only.)
Trade Name : N/A

Measurement Procedure Used:

FCC Rules and Regulations Part 15 Subpart C Section 15.247: 2016
ANSI C63.10: 2013

The EUT was tested according to DTS test procedure of Apr 05, 2017 KDB558074 D01 DTS Meas Guidance v04 for compliance to FCC 47CFR 15.247 requirements

The device described above is tested by ACCURATE TECHNOLOGY CO. LTD to determine the maximum emission levels emanating from the device. The maximum emission levels are compared to the FCC Part 15 Subpart C Section 15.247 limits. The measurement results are contained in this test report and ACCURATE TECHNOLOGY CO. LTD is assumed full responsibility for the accuracy and completeness of these measurements. Also, this report shows that the Equipment Under Test (EUT) is to be technically compliant with the FCC requirements.

This report applies to above tested sample only. This report shall not be reproduced in part without written approval of ACCURATE TECHNOLOGY CO. LTD.

Date of Test : Apr. 13, 2017-Apr. 18, 2017
Date of Report: Apr. 19, 2017

Prepared by :



(Tim. Liang, Engineer)

Approved & Authorized Signer :

(Sean Liu, Manager)

1. GENERAL INFORMATION

1.1. Description of Device (EUT)

EUT	:	LED Power Pulse Speaker-blk box
Model Number	:	CB-335072B, 74309, CB-335089L, CB-335090, CB-335050, CB-335091
Bluetooth version	:	BT V4.2 LE
Frequency Range	:	2402MHz-2480MHz
Number of Channels	:	40
Antenna Gain	:	0dBi
Antenna type	:	PCB Antenna
Power Supply	:	DC 3.7V(powered by battery) Or DC 5V(powered by USB port)
Modulation mode	:	GFSK
Applicant Address	:	CLEVER BRIGHT INTERNATIONAL (H.K.) LTD Rm 1701, Zhuoyue Building, Fuhua Yi Rd., Futian Central Zone, Shenzhen, P.R.China.
Manufacturer Address	:	CLEVER BRIGHT INTERNATIONAL (H.K.) LTD Rm 1701, Zhuoyue Building, Fuhua Yi Rd., Futian Central Zone, Shenzhen, P.R.China.
Date of sample received	:	Apr. 13, 2017
Date of Test	:	Apr. 13-Apr. 18, 2017

1.2. Carrier Frequency of Channels

Channel	Frequency (MHz)	Channel	Frequency (MHz)	Channel	Frequency (MHz)	Channel	Frequency (MHz)
0	2402	10	2422	20	2442	30	2462
1	2404	11	2424	21	2444	31	2464
2	2406	12	2426	22	2446	32	2466
3	2408	13	2428	23	2448	33	2468
4	2410	14	2430	24	2450	34	2470
5	2412	15	2432	25	2452	35	2472
6	2414	16	2434	26	2454	36	2474
7	2416	17	2436	27	2456	37	2476
8	2418	18	2438	28	2458	38	2478
9	2420	19	2440	29	2460	39	2480

1.3.Special Accessory and Auxiliary Equipment

AC/DC Power Adapter: Model: MX12X6-0502000VU
(provided by laboratory) INPUT: 100-120V 60Hz 0.35A
OUTPUT: 5V/1A

1.4.Description of Test Facility

EMC Lab : Accredited by TUV Rheinland Shenzhen

Listed by FCC
The Registration Number is 752051

Listed by Industry Canada
The Registration Number is 5077A-2

Accredited by China National Accreditation Committee
for Laboratories
The Certificate Registration Number is L3193

Name of Firm : ACCURATE TECHNOLOGY CO. LTD
Site Location : F1, Bldg. A, Changyuan New Material Port, Keyuan Rd.
Science & Industry Park, Nanshan, Shenzhen, Guangdong
P.R. China

1.5.Measurement Uncertainty

Conducted Emission Expanded Uncertainty = 2.23dB, k=2

Radiated emission expanded uncertainty = 3.08dB, k=2
(9kHz-30MHz)

Radiated emission expanded uncertainty = 4.42dB, k=2
(30MHz-1000MHz)

Radiated emission expanded uncertainty = 4.06dB, k=2
(Above 1GHz)

2. MEASURING DEVICE AND TEST EQUIPMENT

Table 1: List of Test and Measurement Equipment

Kind of equipment	Manufacturer	Type	S/N	Calibrated dates	Calibrated until
EMI Test Receiver	Rohde&Schwarz	ESCS30	100307	Jan. 07, 2017	1 Year
EMI Test Receiver	Rohde&Schwarz	ESPI3	101526/003	Jan. 07, 2017	1 Year
Spectrum Analyzer	Agilent	E7405A	MY45115511	Jan. 07, 2017	1 Year
Pre-Amplifier	Rohde&Schwarz	CBLU118354 0-01	3791	Jan. 07, 2017	1 Year
Loop Antenna	Schwarzbeck	FMZB1516	1516131	Jan. 13, 2017	1 Year
Bilog Antenna	Schwarzbeck	VULB9163	9163-323	Jan. 13, 2017	1 Year
Horn Antenna	Schwarzbeck	BBHA9120D	9120D-655	Jan. 13, 2017	1 Year
Horn Antenna	Schwarzbeck	BBHA9170	9170-359	Jan. 13, 2017	1 Year
LISN	Rohde&Schwarz	ESH3-Z5	100305	Jan. 07, 2017	1 Year
LISN	Schwarzbeck	NSLK8126	8126431	Jan. 07, 2017	1 Year
Highpass Filter	Wainwright Instruments	WHKX3.6/18 G-10SS	N/A	Jan. 07, 2017	1 Year
Band Reject Filter	Wainwright Instruments	WRCG2400/2 485-2375/2510 -60/11SS	N/A	Jan. 07, 2017	1 Year

3. OPERATION OF EUT DURING TESTING

3.1. Operating Mode

The mode is used: **BLE Transmitting mode**

Low Channel: 2402MHz

Middle Channel: 2440MHz

High Channel: 2480MHz

3.2. Configuration and peripherals

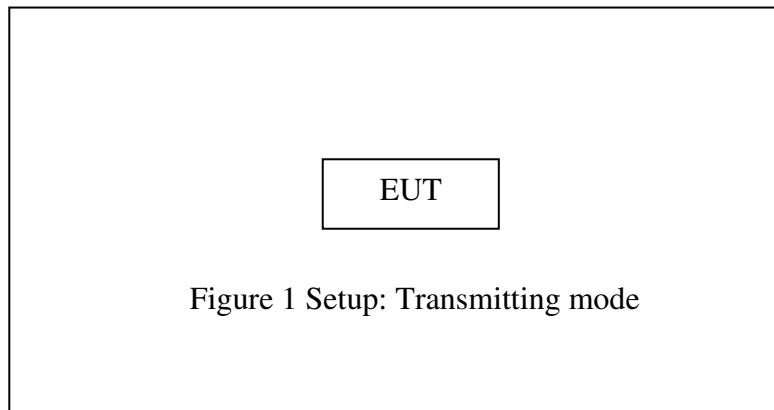

4. TEST PROCEDURES AND RESULTS

FCC Rules	Description of Test	Result
Section 15.247(a)(2)	6dB Bandwidth Test	Compliant
Section 15.247(e)	Power Spectral Density Test	Compliant
Section 15.247(b)(3)	Maximum Peak Output Power Test	Compliant
Section 15.247(d)	Band Edge Compliance Test	Compliant
Section 15.247(d) Section 15.209	Radiated Spurious Emission Test	Compliant
Section 15.247(d)	Conducted Spurious Emission Test	Compliant
Section 15.207	AC Power Line Conducted Emission Test	Compliant
Section 15.203	Antenna Requirement	Compliant

5. POWER LINE CONDUCTED MEASUREMENT

5.1. Block Diagram of Test Setup

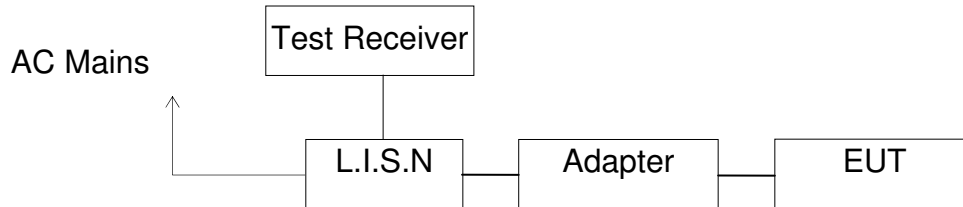

(EUT: LED Power Pulse Speaker-blk box)

5.2. Power Line Conducted Emission Measurement Limits

Frequency (MHz)	Limit dB(μV)	
	Quasi-peak Level	Average Level
0.15 - 0.50	66.0 – 56.0 *	56.0 – 46.0 *
0.50 - 5.00	56.0	46.0
5.00 - 30.00	60.0	50.0

NOTE1: The lower limit shall apply at the transition frequencies.
 NOTE2: The limit decreases linearly with the logarithm of the frequency in the range 0.15MHz to 0.50MHz.

5.3. Configuration of EUT on Measurement

The following equipments are installed on Power Line Conducted Emission Measurement to meet the commission requirement and operating regulations in a manner, which tends to maximize its emission characteristics in a normal application.

5.4. Operating Condition of EUT

- 5.4.1. Setup the EUT and simulator as shown as Section 5.1.
- 5.4.2. Turn on the power of all equipment.
- 5.4.3. Let the EUT work in test mode and measure it.

5.5. Test Procedure

The EUT is put on the plane 0.8 m high above the ground by insulating support and is connected to the power mains through a line impedance stabilization network (L.I.S.N.). This provides a 50ohm coupling impedance for the EUT system. Please refer the block diagram of the test setup and photographs. Both sides of AC lines are checked to find out the maximum conducted emission. In order to find the maximum emission levels, the relative positions of equipment and all of the interface cables shall be changed according to ANSI C63.10: 2013 on Conducted Emission Measurement.

The bandwidth of test receiver (R & S ESCS30) is set at 9kHz.

The frequency range from 150kHz to 30MHz is checked.

5.6. Power Line Conducted Emission Measurement Results

PASS.

The frequency range from 150kHz to 30MHz is checked.

Emissions attenuated more than 20 dB below the permissible value are not reported.

The spectral diagrams are attached as below.

ACCURATE TECHNOLOGY CO., LTD

CONDUCTED EMISSION STANDARD FCC PART 15B

EUT: LED Power Pulse Speaker-blk box M/N:CB-335072B
 Manufacturer: CLEVER BRIGHT
 Operating Condition: BT operation
 Test Site: 1#Shielding Room
 Operator: DING
 Test Specification: L 120V/60Hz
 Comment: Report NO.:ATE20170488
 Start of Test: 4/18/2017 / 5:13:10PM

SCAN TABLE: "V 9K-30MHz fin"

Start Frequency	Stop Frequency	Step Width	Detector	Meas. Time	IF Bandw.	Transducer
9.0 kHz	150.0 kHz	100.0 Hz	QuasiPeak	1.0 s	200 Hz	NSLK8126 2008
150.0 kHz	30.0 MHz	5.0 kHz	Average	1.0 s	9 kHz	NSLK8126 2008

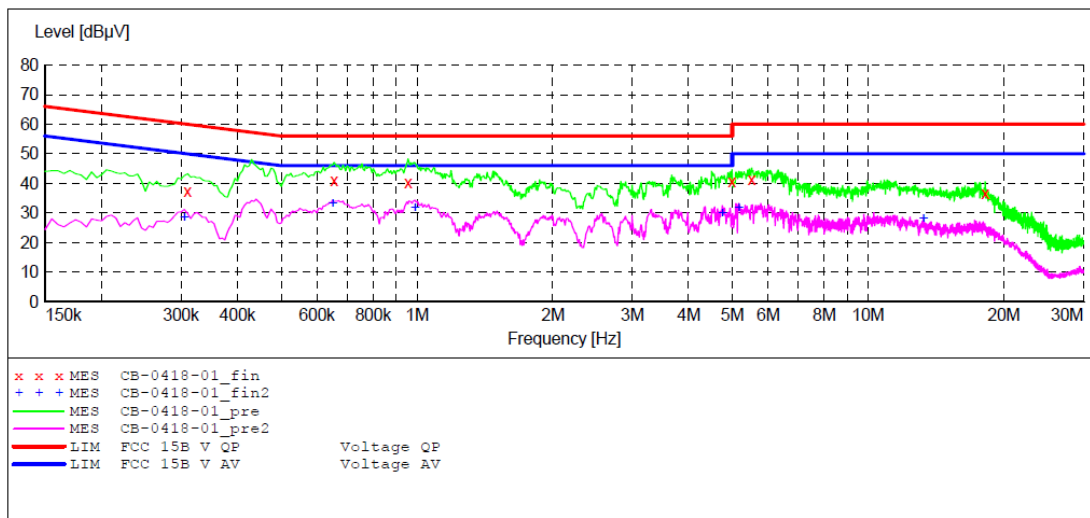

MEASUREMENT RESULT: "CB-0418-01_fin"

4/18/2017 5:17PM

Frequency MHz	Level dBµV	Transd dB	Limit dBµV	Margin dB	Detector	Line	PE
0.310000	37.40	10.6	60	22.6	QP	L1	GND
0.655000	41.10	10.8	56	14.9	QP	L1	GND
0.955000	40.30	10.8	56	15.7	QP	L1	GND
4.990000	40.50	11.2	56	15.5	QP	L1	GND
5.520000	41.20	11.2	60	18.8	QP	L1	GND
18.175000	36.60	11.4	60	23.4	QP	L1	GND

MEASUREMENT RESULT: "CB-0418-01_fin2"

4/18/2017 5:17PM

Frequency MHz	Level dBµV	Transd dB	Limit dBµV	Margin dB	Detector	Line	PE
0.305000	28.70	10.6	50.1	21.4	AV	L1	GND
0.650000	33.40	10.8	46	12.6	AV	L1	GND
0.990000	31.70	10.8	46	14.3	AV	L1	GND
4.750000	30.00	11.1	46	16.0	AV	L1	GND
5.170000	31.80	11.2	50	18.2	AV	L1	GND
13.270000	28.10	11.3	50	21.9	AV	L1	GND

ACCURATE TECHNOLOGY CO., LTD

CONDUCTED EMISSION STANDARD FCC PART 15B

EUT: LED Power Pulse Speaker-blk box M/N:CB-335072B
 Manufacturer: CLEVER BRIGHT
 Operating Condition: BT operation
 Test Site: 1#Shielding Room
 Operator: DING
 Test Specification: N 120V/60Hz
 Comment: Report NO.:ATE20170488
 Start of Test: 4/18/2017 / 5:18:16PM

SCAN TABLE: "V 9K-30MHz fin"

Start Frequency	Stop Frequency	Step Width	Detector	Meas. Time	IF Bandw.	Transducer
9.0 kHz	150.0 kHz	100.0 Hz	QuasiPeak	1.0 s	200 Hz	NSLK8126 2008
150.0 kHz	30.0 MHz	5.0 kHz	QuasiPeak	1.0 s	9 kHz	NSLK8126 2008

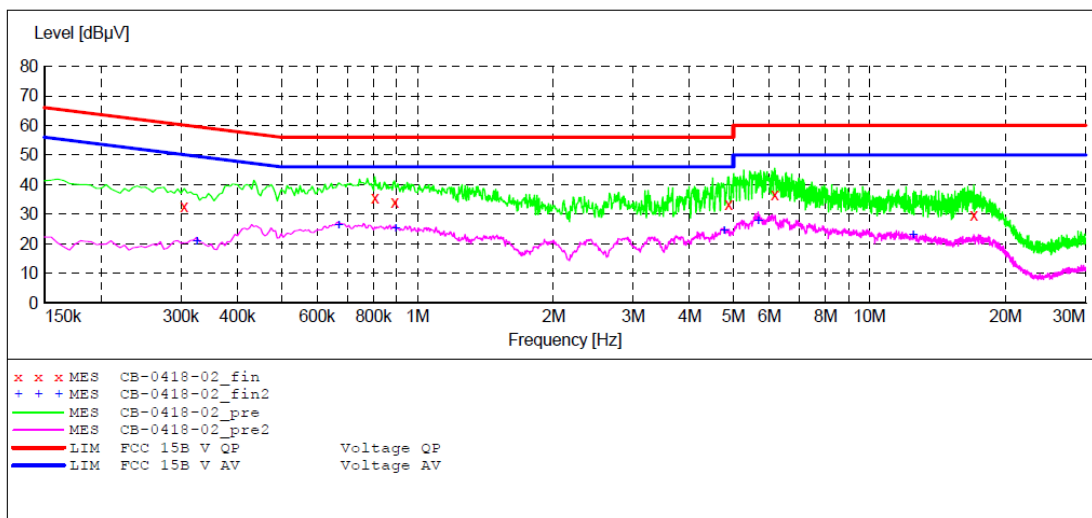

MEASUREMENT RESULT: "CB-0418-02_fin"

4/18/2017 5:21PM

Frequency MHz	Level dBµV	Transd dB	Limit dBµV	Margin dB	Detector	Line	PE
0.305000	32.70	10.6	60.1	27.4	QP	N	GND
0.805000	35.60	10.8	56	20.4	QP	N	GND
0.890000	34.20	10.8	56	21.8	QP	N	GND
4.880000	33.50	11.1	56	22.5	QP	N	GND
6.170000	36.50	11.2	60	23.5	QP	N	GND
17.005000	29.70	11.4	60	30.3	QP	N	GND

MEASUREMENT RESULT: "CB-0418-02_fin2"

4/18/2017 5:21PM

Frequency MHz	Level dBµV	Transd dB	Limit dBµV	Margin dB	Detector	Line	PE
0.325000	21.10	10.6	49.6	28.5	AV	N	GND
0.670000	26.30	10.8	46	19.7	AV	N	GND
0.895000	25.30	10.8	46	20.7	AV	N	GND
4.770000	24.40	11.1	46	21.6	AV	N	GND
5.670000	28.00	11.2	50	22.0	AV	N	GND
12.475000	23.20	11.3	50	26.8	AV	N	GND

6. 6DB BANDWIDTH MEASUREMENT

6.1. Block Diagram of Test Setup

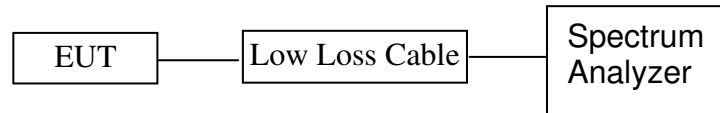

(EUT: LED Power Pulse Speaker-blk box)

6.2. The Requirement For Section 15.247(a)(2)

Section 15.247(a)(2): Systems using digital modulation techniques may operate in the 902-928MHz, 2400-2483.5MHz, and 5725-5850MHz bands. The minimum 6 dB bandwidth shall be at least 500 kHz.

6.3. EUT Configuration on Measurement

The equipment is installed on the emission measurement to meet the commission requirements and operating regulations in a manner which tends to maximize its emission characteristics in normal application.

6.4. Operating Condition of EUT

6.4.1. Setup the EUT and simulator as shown as Section 6.1.

6.4.2. Turn on the power of all equipment.

6.4.3. Let the EUT work in TX modes measure it. The transmit frequency are 2402-2480MHz. We select 2402MHz, 2440MHz, and 2480MHz TX frequency to transmit.

6.5. Test Procedure

6.5.1. The transmitter output was connected to the spectrum analyzer through a low loss cable.

6.5.2. Set RBW of spectrum analyzer to 100 kHz and VBW to 300 kHz.

6.5.3. The 6dB bandwidth is defined as the total spectrum the power of which is higher than peak power minus 6dB.

6.6. Test Result

Channel	Frequency (MHz)	6 dB Bandwidth (MHz)	Minimum Limit(MHz)	PASS/FAIL
0	2402	0.678	0.5	PASS
19	2440	0.672	0.5	PASS
39	2480	0.660	0.5	PASS

The spectrum analyzer plots are attached as below.

channel 0

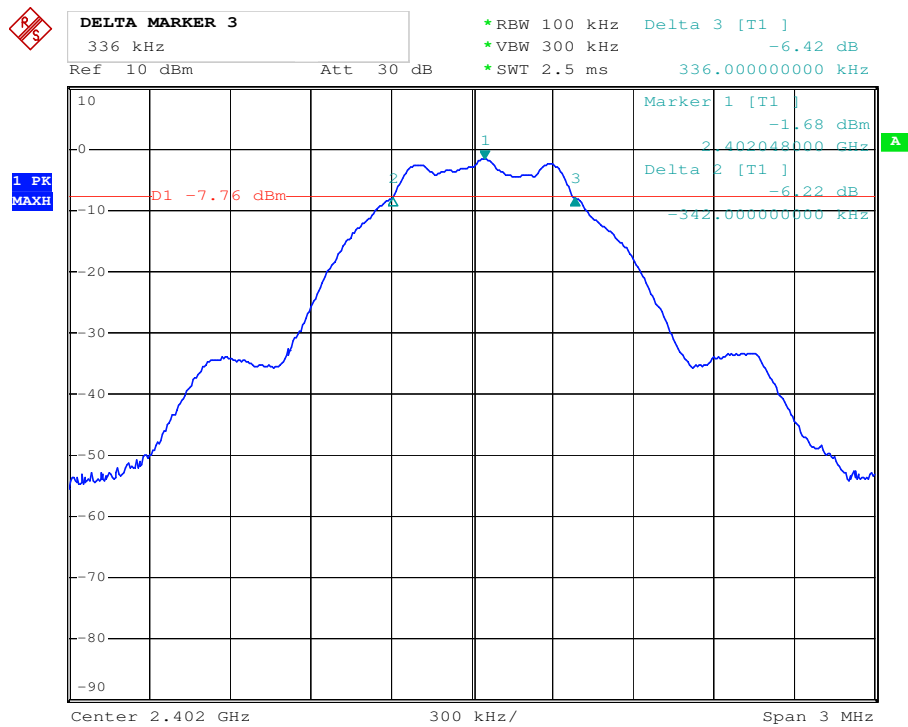

channel 19

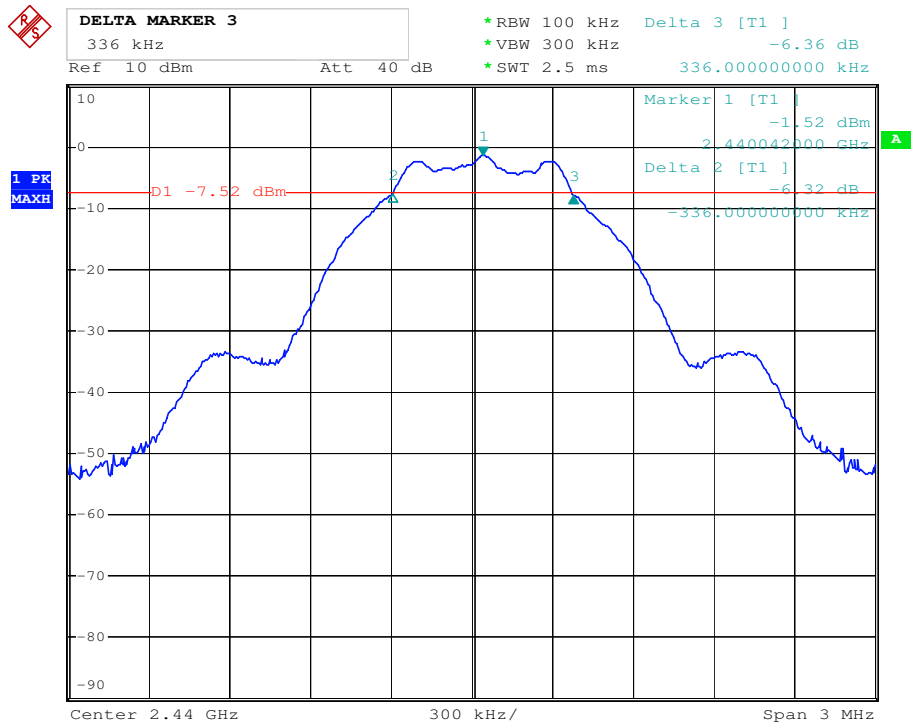

channel 39

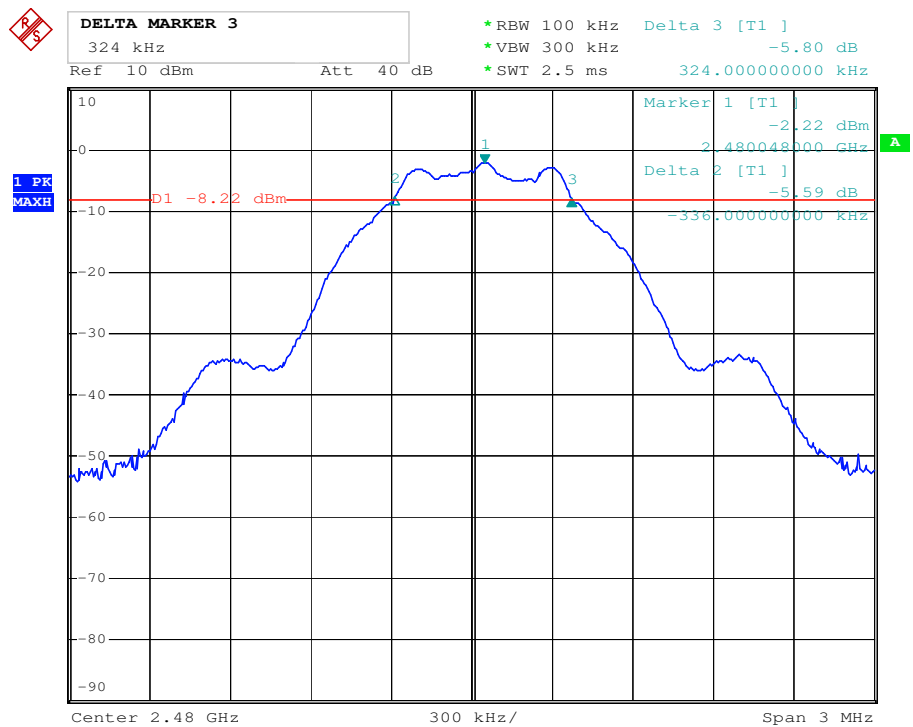

7. MAXIMUM PEAK OUTPUT POWER

7.1. Block Diagram of Test Setup

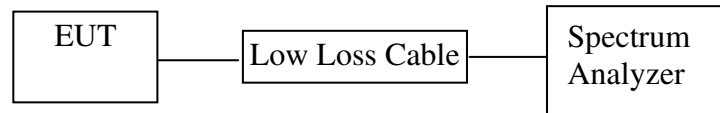

(EUT: LED Power Pulse Speaker-blk box)

7.2. The Requirement For Section 15.247(b)(3)

Section 15.247(b)(3): For systems using digital modulation in the 902-928MHz, 2400-2483.5MHz, and 5725-5850MHz bands: 1 Watt.

7.3. EUT Configuration on Measurement

The equipment are installed on the emission Measurement to meet the commission requirements and operating regulations in a manner which tends to maximize its emission characteristics in normal application.

7.4. Operating Condition of EUT

7.4.1. Setup the EUT and simulator as shown as Section 7.1.

7.4.2. Turn on the power of all equipment.

7.4.3. Let the EUT work in TX modes measure it. The transmit frequency are 2402-2480MHz. We select 2402MHz, 2440MHz, and 2480MHz TX frequency to transmit.

7.5. Test Procedure

7.5.1. The transmitter output was connected to the spectrum analyzer through a low loss cable.

7.5.2. Set RBW of spectrum analyzer to 1 MHz and VBW to 3MHz.

7.5.3. Measurement the maximum peak output power.

7.6. Test Result

Channel	Frequency (MHz)	Peak Power Output (dBm)	Peak Power Limit (dBm)	Pass / Fail
0	2402	-0.01	30	PASS
19	2440	-1.38	30	PASS
39	2480	-2.21	30	PASS

The spectrum analyzer plots are attached as below.

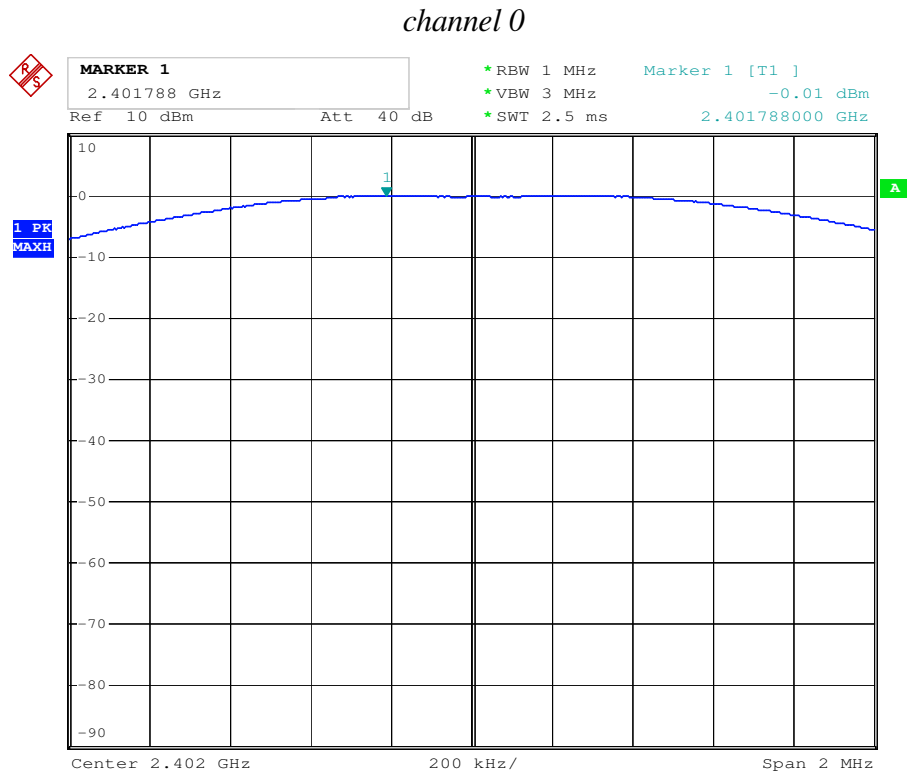

channel 19

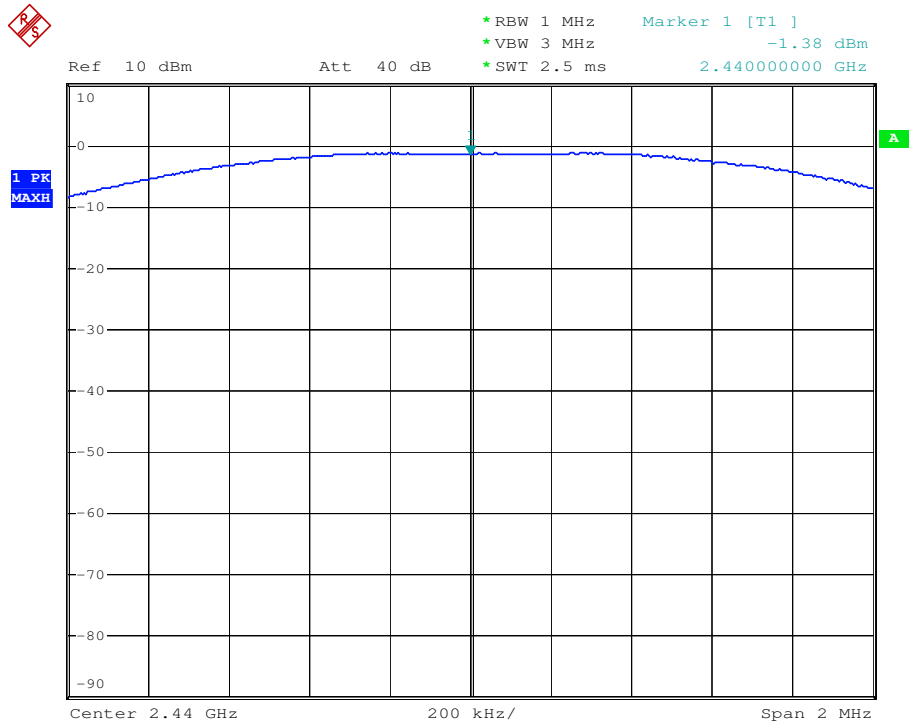

channel 39

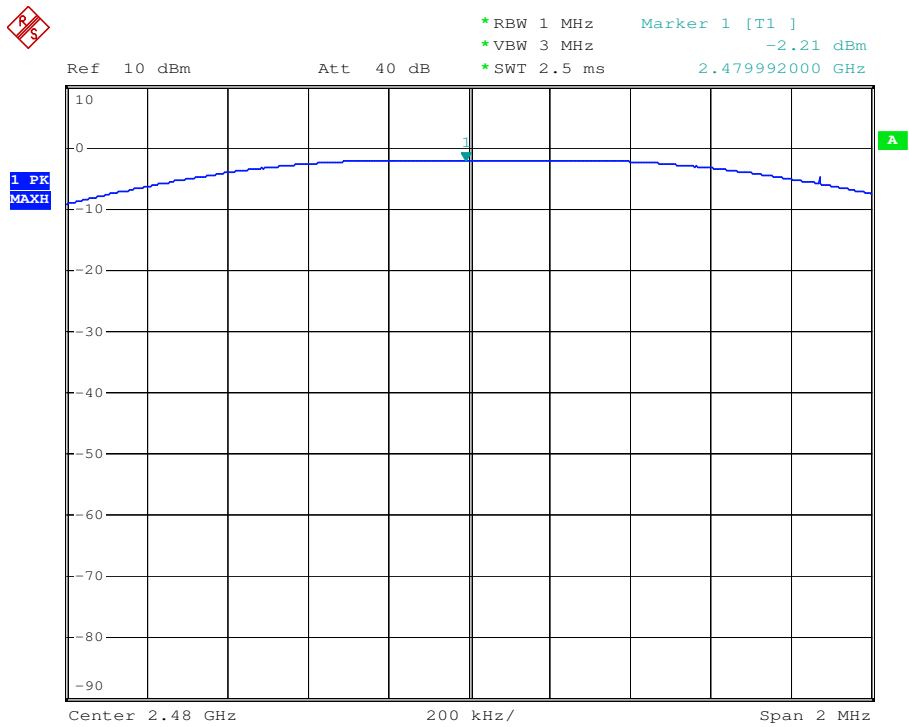

8. POWER SPECTRAL DENSITY MEASUREMENT

8.1. Block Diagram of Test Setup

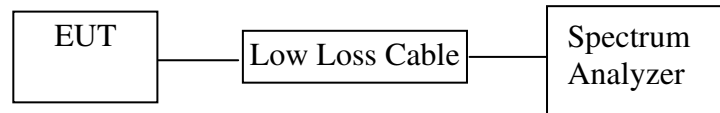

(EUT: LED Power Pulse Speaker-blk box)

8.2. The Requirement For Section 15.247(e)

Section 15.247(e): For digitally modulated systems, the power spectral density conducted from the intentional radiator to the antenna shall not be greater than 8 dBm in any 3 kHz band during any time interval of continuous transmission.

8.3. EUT Configuration on Measurement

The equipment are installed on the emission Measurement to meet the commission requirements and operating regulations in a manner which tends to maximize its emission characteristics in normal application.

8.4. Operating Condition of EUT

8.4.1. Setup the EUT and simulator as shown as Section 8.1.

8.4.2. Turn on the power of all equipment.

8.4.3. Let the EUT work in TX modes measure it. The transmit frequency are 2402-2480MHz. We select 2402MHz, 2440MHz, and 2480MHz TX frequency to transmit.

8.5. Test Procedure

8.5.1. The transmitter output was connected to the spectrum analyzer through a low loss cable.

8.5.2. Measurement Procedure PKPSD:

8.5.3. This procedure must be used if maximum peak conducted output power was used to demonstrate compliance to the fundamental output power limit, and is optional if the maximum (average) conducted output power was used to demonstrate compliance.

1. Set analyzer center frequency to DTS channel center frequency.
2. Set the span to 1.5 times the DTS channel bandwidth.
3. Set the RBW to: $3 \text{ kHz} \leq \text{RBW} \leq 100 \text{ kHz}$.
4. Set the VBW $\geq 3 \times \text{RBW}$.
5. Detector = peak.
6. Sweep time = auto couple.
7. Trace mode = max hold.
8. Allow trace to fully stabilize.
9. Use the peak marker function to determine the maximum amplitude level.
10. If measured value exceeds limit, reduce RBW (no less than 3kHz) and repeat.

8.5.4. Measurement the maximum power spectral density.

8.6. Test Result

CHANNEL NUMBER	FREQUENCY (MHz)	PSD (dBm/3KHz)	LIMIT (dBm/3KHz)	PASS/FAIL
0	2402	-16.23	8	PASS
19	2440	-16.53	8	PASS
39	2480	-17.04	8	PASS

The spectrum analyzer plots are attached as below.

channel 0

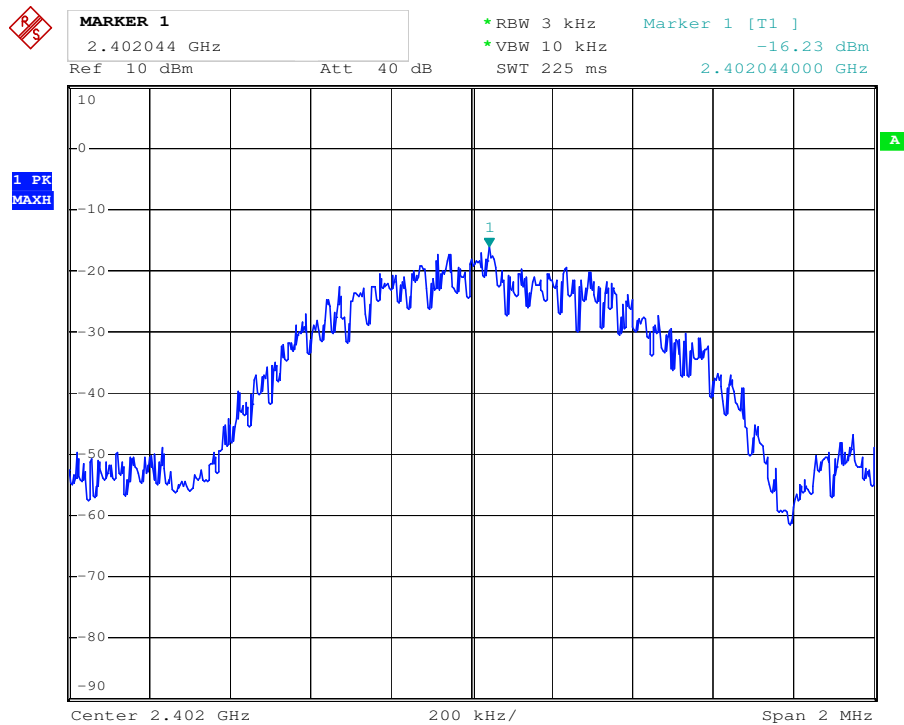

channel 19

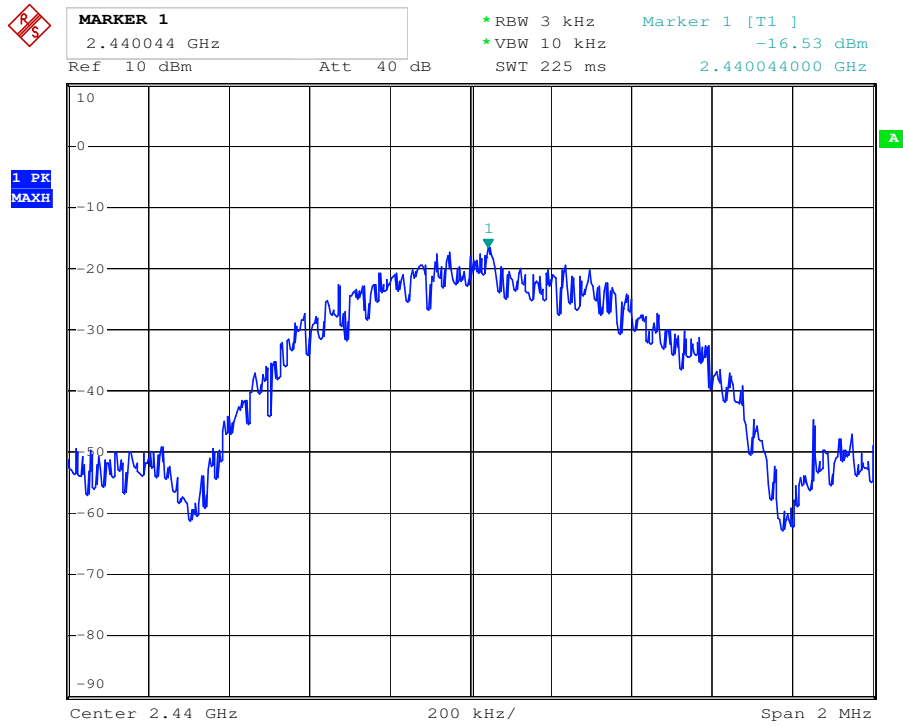

channel 39

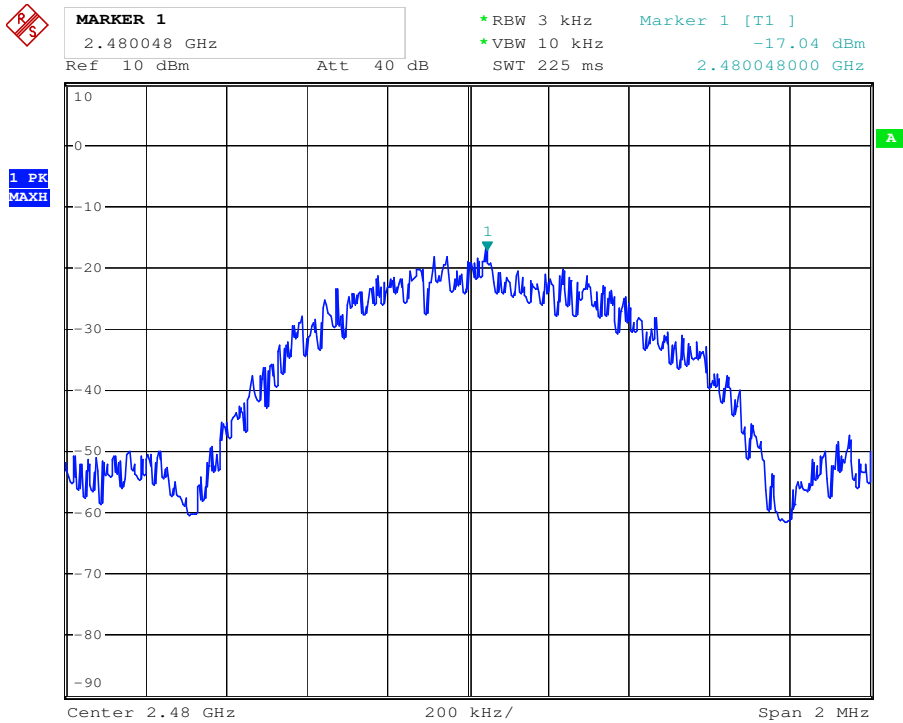

9. BAND EDGE COMPLIANCE TEST

9.1. Block Diagram of Test Setup

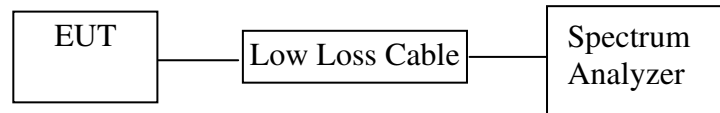

(EUT: LED Power Pulse Speaker-blk box)

9.2. The Requirement For Section 15.247(d)

Section 15.247(d): In any 100 kHz bandwidth outside the frequency band in which the spread spectrum or digitally modulated intentional radiator is operating, the radio frequency power that is produced by the intentional radiator shall be at least 20 dB below that in the 100 kHz bandwidth within the band that contains the highest level of the desired power, based on either an RF conducted or a radiated measurement, provided the transmitter demonstrates compliance with the peak conducted power limits. If the transmitter complies with the conducted power limits based on the use of RMS averaging over a time interval, as permitted under paragraph (b)(3) of this section, the attenuation required under this paragraph shall be 30 dB instead of 20 dB. Attenuation below the general limits specified in Section 15.209(a) is not required. In addition, radiated emissions which fall in the restricted bands, as defined in Section 15.205(a), must also comply with the radiated emission limits specified in Section 15.209(a).

9.3. EUT Configuration on Measurement

The equipment are installed on the emission Measurement to meet the commission requirements and operating regulations in a manner which tends to maximize its emission characteristics in normal application.

9.4. Operating Condition of EUT

9.4.1. Setup the EUT and simulator as shown as Section 9.1.

9.4.2. Turn on the power of all equipment.

9.4.3. Let the EUT work in TX modes measure it. The transmit frequency are 2402-2480MHz. We select 2402MHz, 2480MHz TX frequency to transmit.

9.5. Test Procedure

Conducted Band Edge:

9.5.1. The transmitter output was connected to the spectrum analyzer via a low loss cable.

9.5.2. Set RBW of spectrum analyzer to 100 kHz and VBW to 300 kHz.

9.5.3. Radiate Band Edge:

9.5.4. The EUT is placed on a turntable, which is 1.5m above the ground plane and worked at highest radiated power.

9.5.5. The turntable was rotated for 360 degrees to determine the position of maximum emission level.

9.5.6. EUT is set 3m away from the receiving antenna, which is varied from 1m to 4m to find out the highest emission.

9.5.7. Set the spectrum analyzer in the following setting in order to capture the lower and upper band-edges of the emission:

9.5.8. RBW=1MHz, VBW=1MHz

9.5.9. The band edges was measured and recorded.

9.6. Test Result

Pass

Channel	Frequency	Delta peak to band emission	Limit(dBc)
0	2.4GHz	52.61	20
39	2.4835GHz	52.31	20

channel 0

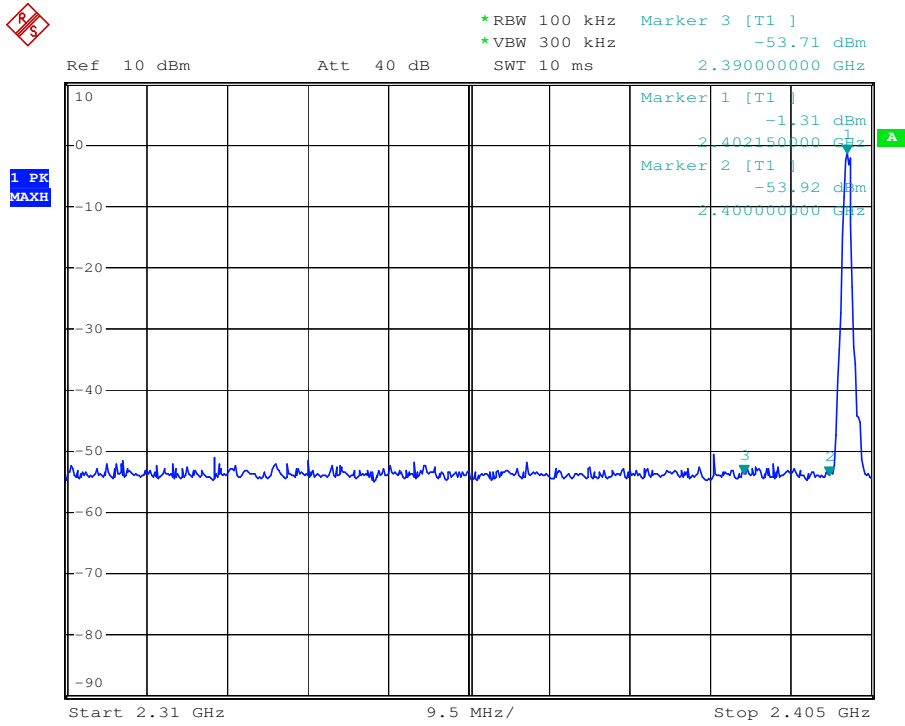

channel 39

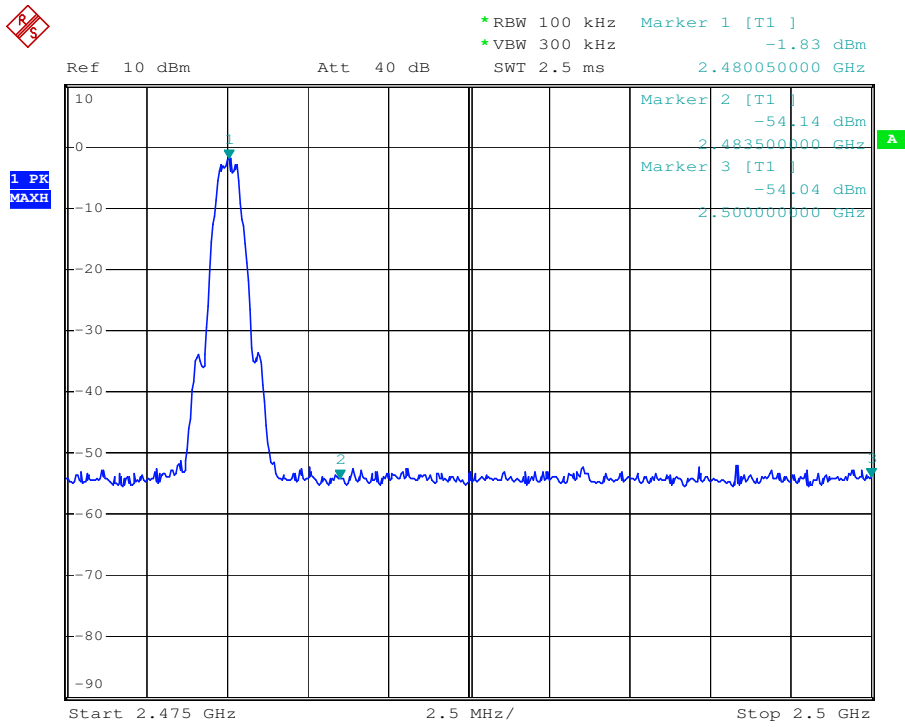

Radiated Band Edge Result

ACCURATE TECHNOLOGY CO., LTD.

 F1,Bldg,A,Changyuan New Material Port Keyuan Rd,
 Science & Industry Park,Nanshan Shenzhen,P.R.China

Site: 1# Chamber

Tel:+86-0755-26503290

Fax:+86-0755-26503396

Job No.: DING #310	Polarization: Horizontal
Standard: FCC PK	Power Source: DC 3.7V
Test item: Radiation Test	Date: 17/04/17/
Temp.(C)/Hum.(%) 25 C / 55 %	Time: 9/21/20
EUT: LED Power Pulse Speaker-blk box	Engineer Signature: DING
Mode: TX 2402MHz	Distance: 3m
Model: CB-335072B	
Manufacturer: CLEVER BRIGHT	

Note: Report NO.:ATE20170488

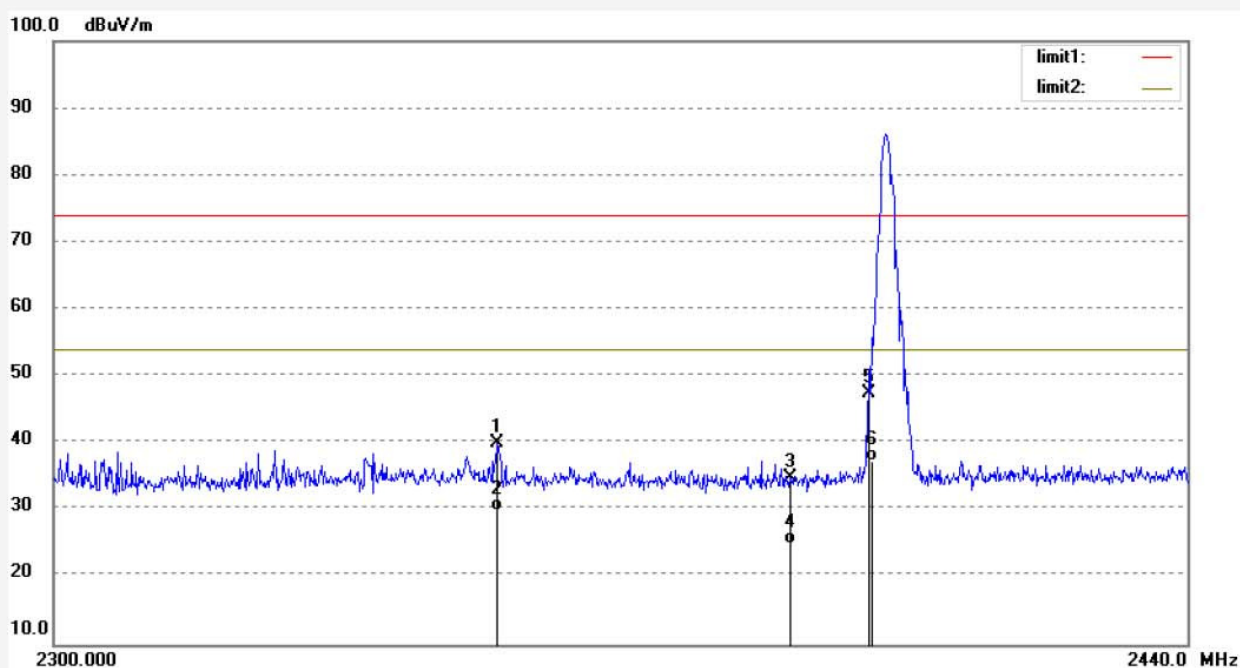

No.	Freq. (MHz)	Reading (dBuV/m)	Factor (dB)	Result (dBuV/m)	Limit (dBuV/m)	Margin (dB)	Detector	Height (cm)	Degree (deg.)	Remark
1	2353.866	46.27	-6.21	40.06	74.00	-33.94	peak			
2	2353.866	36.19	-6.21	29.98	54.00	-24.02	AVG			
3	2390.000	40.72	-5.89	34.83	74.00	-39.17	peak			
4	2390.000	30.86	-5.89	24.97	54.00	-29.03	AVG			
5	2400.000	53.20	-5.80	47.40	74.00	-26.60	peak			
6	2400.000	43.08	-5.80	37.28	54.00	-16.72	AVG			

Job No.: DING #311	Polarization: Vertical
Standard: FCC PK	Power Source: DC 3.7V
Test item: Radiation Test	Date: 17/04/17/
Temp.(C)/Hum.(%) 25 C / 55 %	Time: 9/22/02
EUT: LED Power Pulse Speaker-blk box	Engineer Signature: DING
Mode: TX 2402MHz	Distance: 3m
Model: CB-335072B	
Manufacturer: CLEVER BRIGHT	

Note: Report NO.:ATE20170488

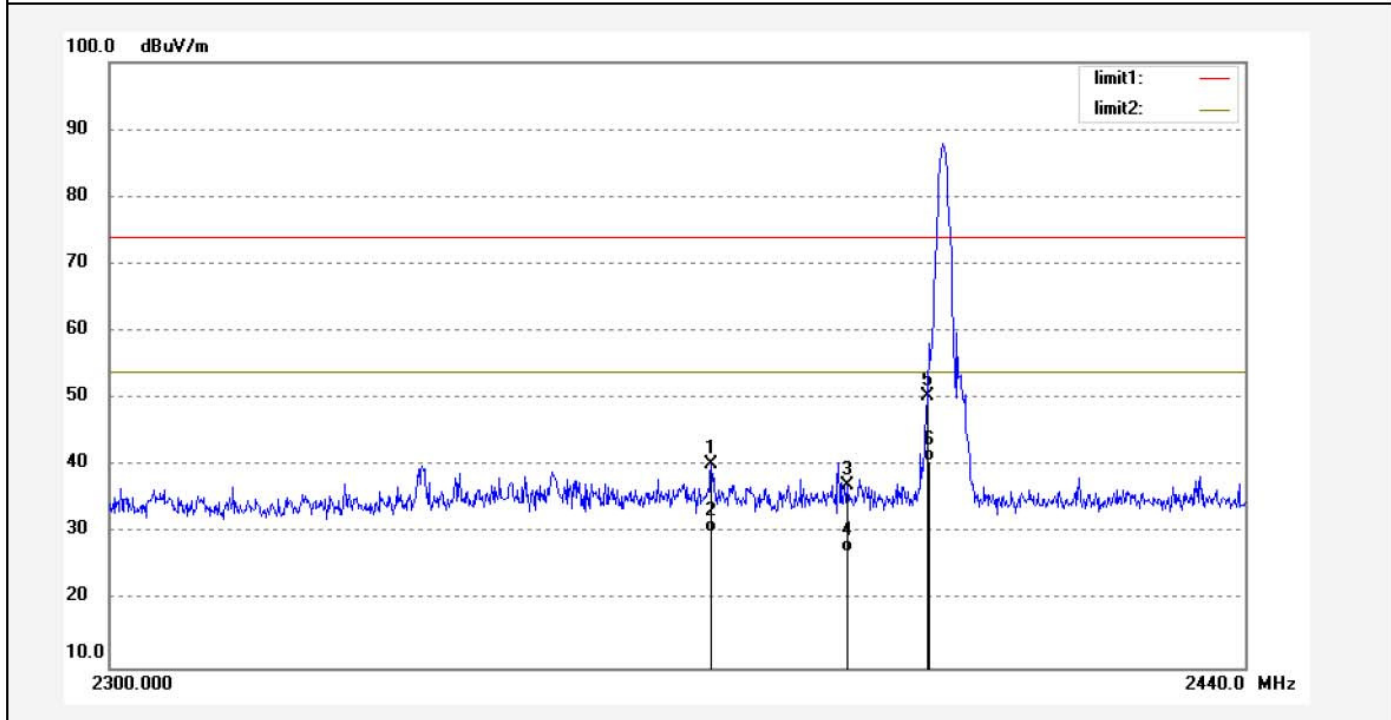

No.	Freq. (MHz)	Reading (dBuV/m)	Factor (dB)	Result (dBuV/m)	Limit (dBuV/m)	Margin (dB)	Detector	Height (cm)	Degree (deg.)	Remark
1	2373.177	46.30	-6.04	40.26	74.00	-33.74	peak			
2	2373.177	36.24	-6.04	30.20	54.00	-23.80	AVG			
3	2390.000	43.01	-5.89	37.12	74.00	-36.88	peak			
4	2390.000	33.06	-5.89	27.17	54.00	-26.83	AVG			
5	2400.000	56.14	-5.80	50.34	74.00	-23.66	peak			
6	2400.000	46.57	-5.80	40.77	54.00	-13.23	AVG			

Job No.: DING #309 Standard: FCC PK Test item: Radiation Test Temp.(C)/Hum.(%) 25 C / 55 % EUT: LED Power Pulse Speaker-blk box Mode: TX 2480MHz Model: CB-335072B Manufacturer: CLEVER BRIGHT	Polarization: Horizontal Power Source: DC 3.7V Date: 17/04/17/ Time: 9/19/52 Engineer Signature: DING Distance: 3m
----------------------------------------------------------------------------------------------------------------------------------------------------------------------------------------------------------------------	-----------------------------------------------------------------------------------------------------------------------------------

Note: Report NO.:ATE20170488

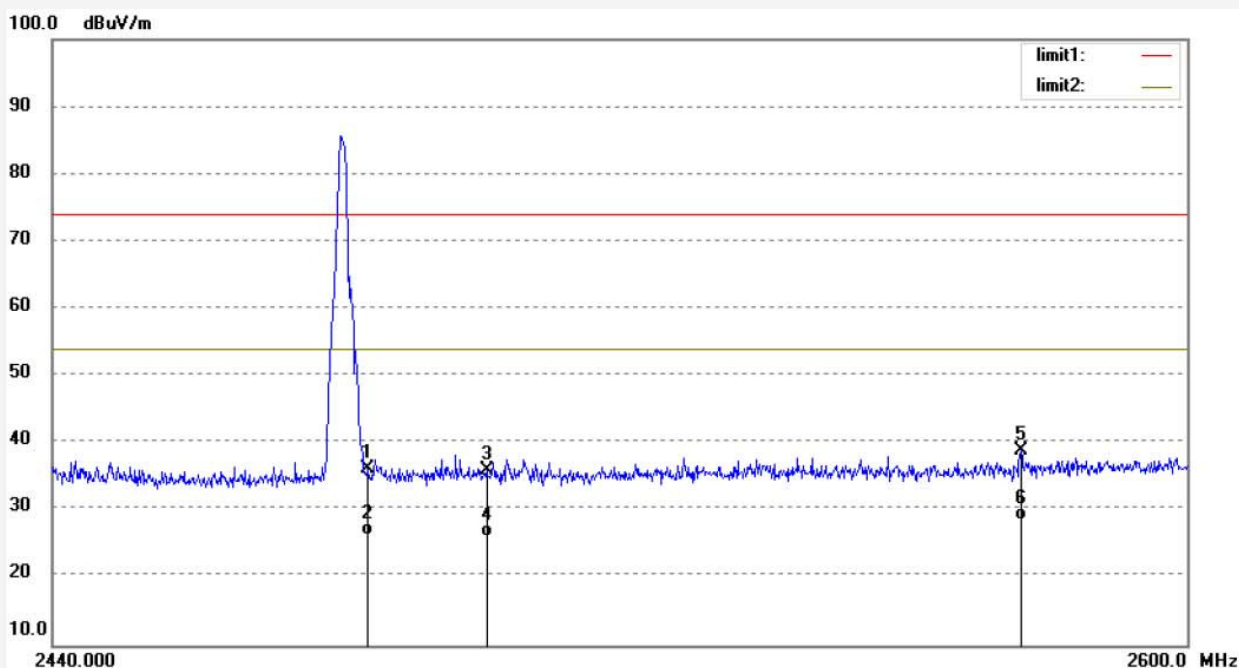

No.	Freq. (MHz)	Reading (dBuV/m)	Factor (dB)	Result (dBuV/m)	Limit (dBuV/m)	Margin (dB)	Detector	Height (cm)	Degree (deg.)	Remark
1	2483.500	41.70	-5.51	36.19	74.00	-37.81	peak			
2	2483.500	31.75	-5.51	26.24	54.00	-27.76	AVG			
3	2500.000	41.57	-5.50	36.07	74.00	-37.93	peak			
4	2500.000	31.59	-5.50	26.09	54.00	-27.91	AVG			
5	2575.954	43.74	-4.83	38.91	74.00	-35.09	peak			
6	2575.954	33.49	-4.83	28.66	54.00	-25.34	AVG			

Job No.: DING #308	Polarization: Vertical
Standard: FCC PK	Power Source: DC 3.7V
Test item: Radiation Test	Date: 17/04/17/
Temp.(C)/Hum.(%) 25 C / 55 %	Time: 9/18/58
EUT: LED Power Pulse Speaker-blk box	Engineer Signature: DING
Mode: TX 2480MHz	Distance: 3m
Model: CB-335072B	
Manufacturer: CLEVER BRIGHT	

Note: Report NO.:ATE20170488

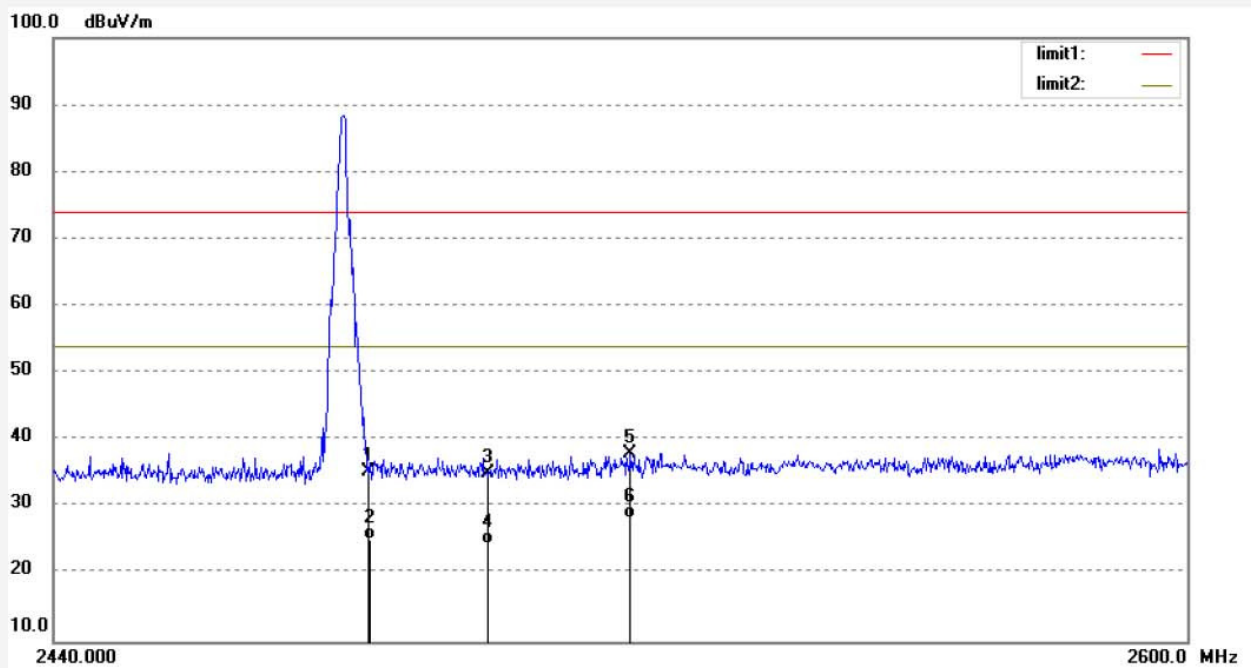

No.	Freq. (MHz)	Reading (dBuV/m)	Factor (dB)	Result (dBuV/m)	Limit (dBuV/m)	Margin (dB)	Detector	Height (cm)	Degree (deg.)	Remark
1	2483.500	40.84	-5.51	35.33	74.00	-38.67	peak			
2	2483.500	30.76	-5.51	25.25	54.00	-28.75	AVG			
3	2500.000	40.62	-5.50	35.12	74.00	-38.88	peak			
4	2500.000	29.94	-5.50	24.44	54.00	-29.56	AVG			
5	2520.173	43.33	-5.30	38.03	74.00	-35.97	peak			
6	2520.173	33.59	-5.30	28.29	54.00	-25.71	AVG			

Note:

1. Emissions attenuated more than 20 dB below the permissible value are not reported.
2. The field strength is calculated by adding the antenna factor, high pass filter loss(if used) and cable loss, and subtracting the amplifier gain(if any)from the measured reading. The basic equation calculation is as follows:

$$\text{Result} = \text{Reading} + \text{Corrected Factor}$$

10. RADIATED SPURIOUS EMISSION TEST

10.1. Block Diagram of Test Setup

10.1.1. Block diagram of connection between the EUT and peripherals

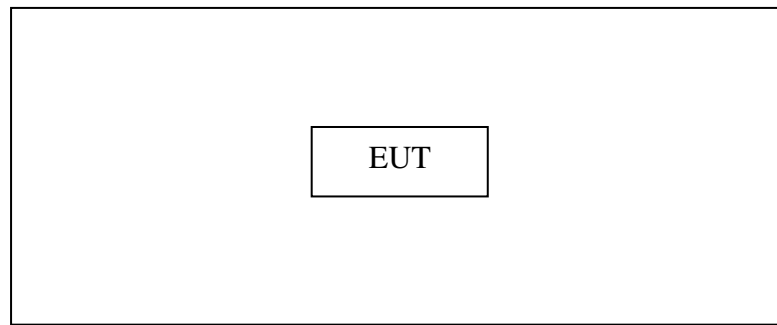

Setup: Transmitting mode

(EUT: LED Power Pulse Speaker-blk box)

10.1.2. Semi-Anechoic Chamber Test Setup Diagram

(A) Radiated Emission Test Set-Up, Frequency below 30MHz

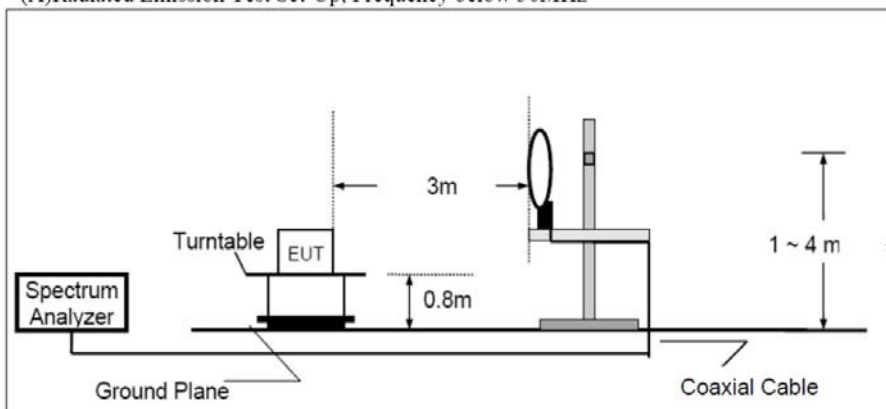

(B) Radiated Emission Test Set-Up, Frequency 30-1000MHz

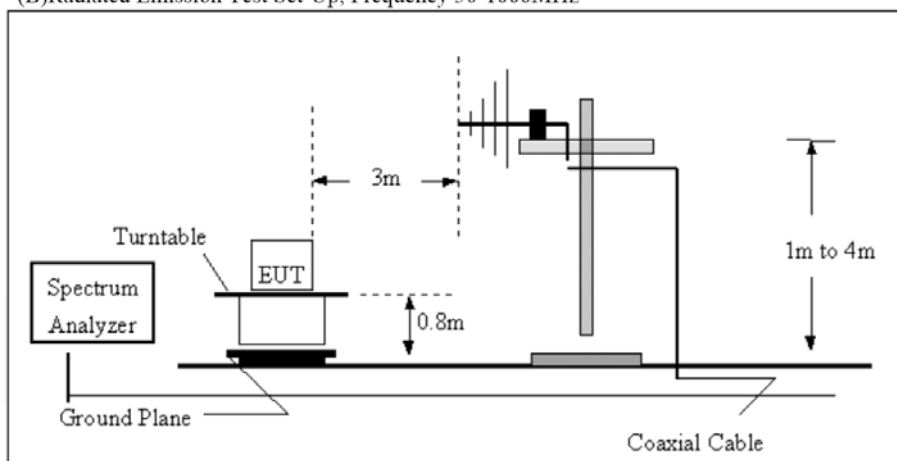

(C) Radiated Emission Test Set-Up, Frequency above 1GHz

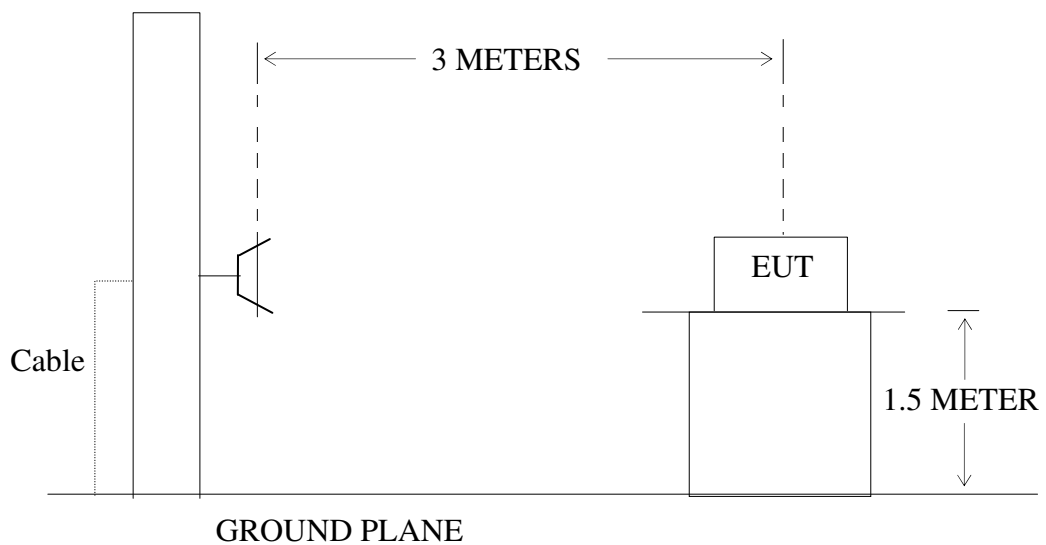

10.2. The Limit For Section 15.247(d)

Section 15.247(d): In any 100 kHz bandwidth outside the frequency band in which the spread spectrum or digitally modulated intentional radiator is operating, the radio frequency power that is produced by the intentional radiator shall be at least 20 dB below that in the 100 kHz bandwidth within the band that contains the highest level of the desired power, based on either an RF conducted or a radiated measurement, provided the transmitter demonstrates compliance with the peak conducted power limits. If the transmitter complies with the conducted power limits based on the use of RMS averaging over a time interval, as permitted under paragraph (b)(3) of this section, the attenuation required under this paragraph shall be 30 dB instead of 20 dB. Attenuation below the general limits specified in Section 15.209(a) is not required. In addition, radiated emissions which fall in the restricted bands, as defined in Section 15.205(a), must also comply with the radiated emission limits specified in Section 15.209(a).

10.3.Restricted bands of operation

10.3.1.FCC Part 15.205 Restricted bands of operation

(a) Except as shown in paragraph (d) of this section, Only spurious emissions are permitted in any of the frequency bands listed below:

MHz	MHz	MHz	GHz
0.090-0.110	16.42-16.423	399.9-410	4.5-5.15
¹ 0.495-0.505	16.69475-16.69525	608-614	5.35-5.46
2.1735-2.1905	16.80425-16.80475	960-1240	7.25-7.75
4.125-4.128	25.5-25.67	1300-1427	8.025-8.5
4.17725-4.17775	37.5-38.25	1435-1626.5	9.0-9.2
4.20725-4.20775	73-74.6	1645.5-1646.5	9.3-9.5
6.215-6.218	74.8-75.2	1660-1710	10.6-12.7
6.26775-6.26825	108-121.94	1718.8-1722.2	13.25-13.4
6.31175-6.31225	123-138	2200-2300	14.47-14.5
8.291-8.294	149.9-150.05	2310-2390	15.35-16.2
8.362-8.366	156.52475-156.52525	2483.5-2500	17.7-21.4
8.37625-8.38675	156.7-156.9	2690-2900	22.01-23.12
8.41425-8.41475	162.0125-167.17	3260-3267	23.6-24.0
12.29-12.293	167.72-173.2	3332-3339	31.2-31.8
12.51975-12.52025	240-285	3345.8-3358	36.43-36.5
12.57675-12.57725	322-335.4	3600-4400	(²)
13.36-13.41			

¹Until February 1, 1999, this restricted band shall be 0.490-0.510

²Above 38.6

(b) Except as provided in paragraphs (d) and (e), the field strength of emission appearing within these frequency bands shall not exceed the limits shown in Section 15.209. At frequencies equal to or less than 1000MHz, Compliance with the limits in Section 15.209 shall be demonstrated using measurement instrumentation employing a CISPR quasi-peak detector. Above 1000MHz, compliance with the emission limits in Section 15.209 shall be demonstrated based on the average value of the measured emissions. The provisions in Section 15.35 apply to these measurements.

10.4.Configuration of EUT on Measurement

The equipment are installed on Radiated Emission Measurement to meet the commission requirements and operating regulations in a manner which tends to maximize its emission characteristics in normal application.

10.5. Operating Condition of EUT

10.5.1. Setup the EUT and simulator as shown as Section 10.1.

10.5.2. Turn on the power of all equipment.

10.5.3. Let the EUT work in TX modes measure it. The transmit frequency are 2402-2480MHz. We select 2402MHz, 2440MHz, and 2480MHz TX frequency to transmit.

10.6. Test Procedure

The EUT and its simulators are placed on a turntable, which is 0.8 meter high above ground (Below 1GHz). The EUT and its simulators are placed on a turntable, which is 1.5 meter high above ground (Above 1GHz). The turntable can rotate 360 degrees to determine the position of the maximum emission level. EUT is set 3.0 meters away from the receiving antenna, which is mounted on an antenna tower. The antenna can be moved up and down between 1.0 meter and 4 meters to find out the maximum emission level. Broadband antenna (calibrated bi-log antenna) is used as receiving antenna. Both horizontal and vertical polarizations of the antenna are set on measurement. In order to find the maximum emission levels, all of the EUT location must be manipulated according to ANSI C63.10:2013 on radiated emission measurement. The EUT was tested in 3 orthogonal planes.

The bandwidth of test receiver is set at 9 kHz in below 30MHz. and set at 120 kHz in 30-1000MHz, and 1MHz in above 1000MHz.

The frequency range from 9 kHz to 25GHz is checked.

The final measurement in band 9-90 kHz, 110-490 kHz and above 1000MHz is performed with Average detector. Except those frequency bands mention above, the final measurement for frequencies below 1000MHz is performed with Quasi Peak detector.

The field strength is calculated by adding the antenna factor, and cable loss, and subtracting the amplifier gain from the measured reading. The basic equation calculation is as follows:

Result = Reading + Corrected Factor

Where Corrected Factor = Antenna Factor + Cable Loss – Amplifier Gain

10.7. The Field Strength of Radiation Emission Measurement Results

PASS.

Note: 1. Emissions attenuated more than 20 dB below the permissible value are not reported.

2. *: Denotes restricted band of operation.

3. The radiation emissions from 9kHz-30MHz and 18-25GHz are not reported, because the test values lower than the limits of 20dB.

Below 1GHz

ACCURATE TECHNOLOGY CO., LTD.

 F1,Bldg,A,Changyuan New Material Port Keyuan Rd,
 Science & Industry Park,Nanshan Shenzhen,P.R.China

Site: 1# Chamber

Tel:+86-0755-26503290

Fax:+86-0755-26503396

Job No.: ding1 #19

Standard: FCC Class B 3M Radiated

Test item: Radiation Test

Temp.(C)/Hum.(%) 25 C / 55 %

EUT: LED Power Pulse Speaker-blk box

Mode: TX 2402MHz

Model: CB-335072B

Manufacturer: CLEVER BRIGHT

Polarization: Horizontal

Power Source: DC 3.7V

Date: 17/04/18/

Time: 9/17/05

Engineer Signature: DING

Distance: 3m

Note: Report NO:ATE20170488

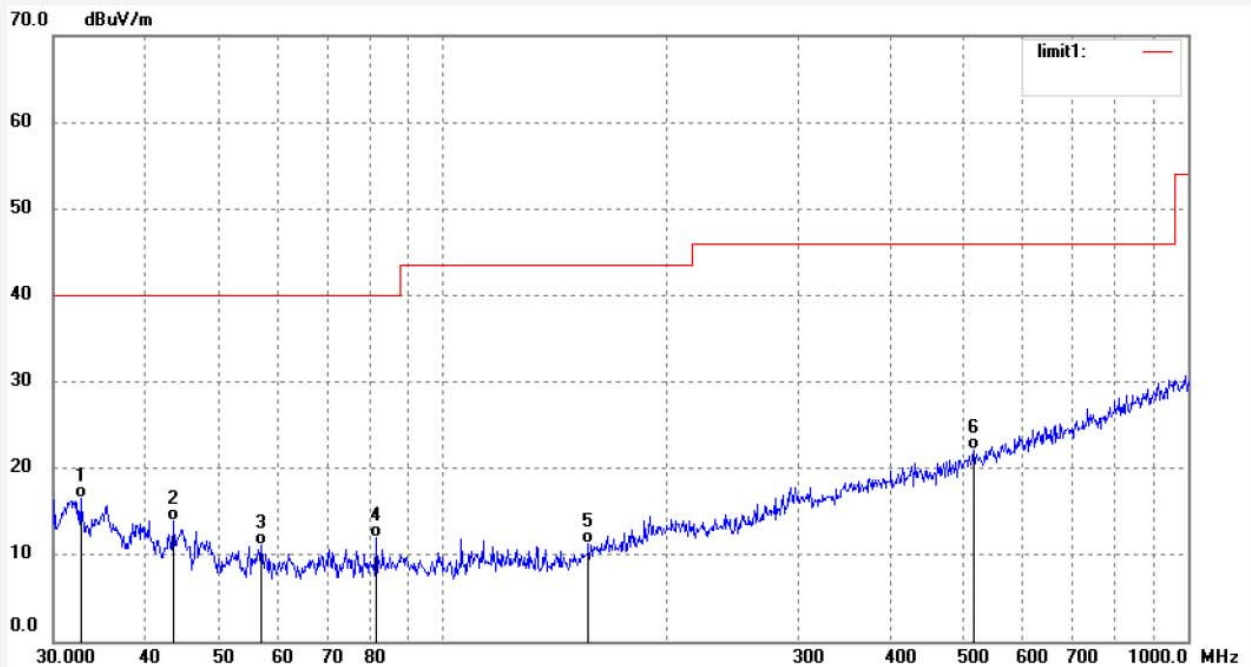

No.	Freq. (MHz)	Reading (dBuV/m)	Factor (dB)	Result (dBuV/m)	Limit (dBuV/m)	Margin (dB)	Detector	Height (cm)	Degree (deg.)	Remark
1	32.6394	31.85	-15.36	16.49	40.00	-23.51	QP			
2	43.5380	32.57	-18.67	13.90	40.00	-26.10	QP			
3	57.0645	32.77	-21.69	11.08	40.00	-28.92	QP			
4	81.3739	34.06	-21.99	12.07	40.00	-27.93	QP			
5	156.9764	32.98	-21.71	11.27	43.50	-32.23	QP			
6	516.5651	32.56	-10.50	22.06	46.00	-23.94	QP			

Job No.: ding1 #20	Polarization: Vertical
Standard: FCC Class B 3M Radiated	Power Source: DC 3.7V
Test item: Radiation Test	Date: 17/04/18/
Temp.(C)/Hum.(%) 25 C / 55 %	Time: 9/17/20
EUT: LED Power Pulse Speaker-blk box	Engineer Signature: DING
Mode: TX 2402MHz	Distance: 3m
Model: CB-335072B	
Manufacturer: CLEVER BRIGHT	

Note: Report NO:ATE20170488

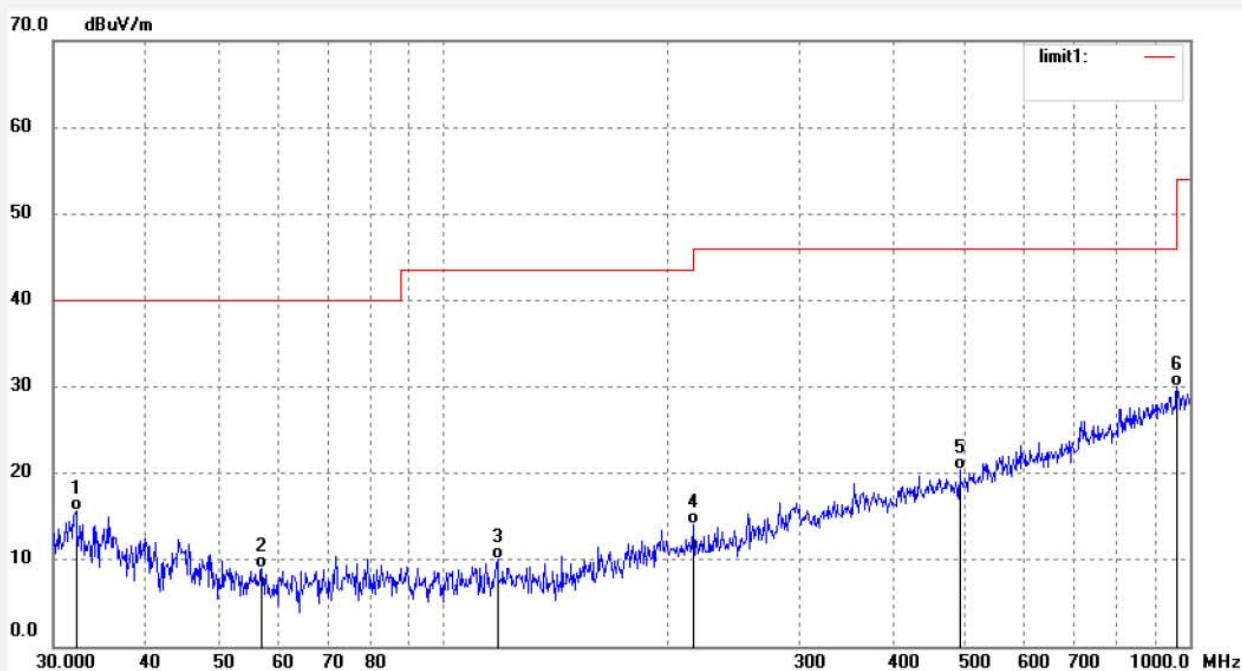

No.	Freq. (MHz)	Reading (dBuV/m)	Factor (dB)	Result (dBuV/m)	Limit (dBuV/m)	Margin (dB)	Detector	Height (cm)	Degree (deg.)	Remark
1	32.1839	30.92	-15.24	15.68	40.00	-24.32	QP			
2	57.0645	30.67	-21.69	8.98	40.00	-31.02	QP			
3	118.0956	31.94	-21.89	10.05	43.50	-33.45	QP			
4	216.1196	32.52	-18.41	14.11	46.00	-31.89	QP			
5	491.7699	31.38	-11.04	20.34	46.00	-25.66	QP			
6	962.0878	31.14	-1.18	29.96	54.00	-24.04	QP			

Job No.: ding1 #22

Standard: FCC Class B 3M Radiated

Test item: Radiation Test

Temp.(C)/Hum.(%) 25 C / 55 %

EUT: LED Power Pulse Speaker-blk box

Mode: TX 2440MHz

Model: CB-335072B

Manufacturer: CLEVER BRIGHT

Polarization: Horizontal

Power Source: DC 3.7V

Date: 17/04/18/

Time: 9/17/52

Engineer Signature: DING

Distance: 3m

Note: Report NO:ATE20170488

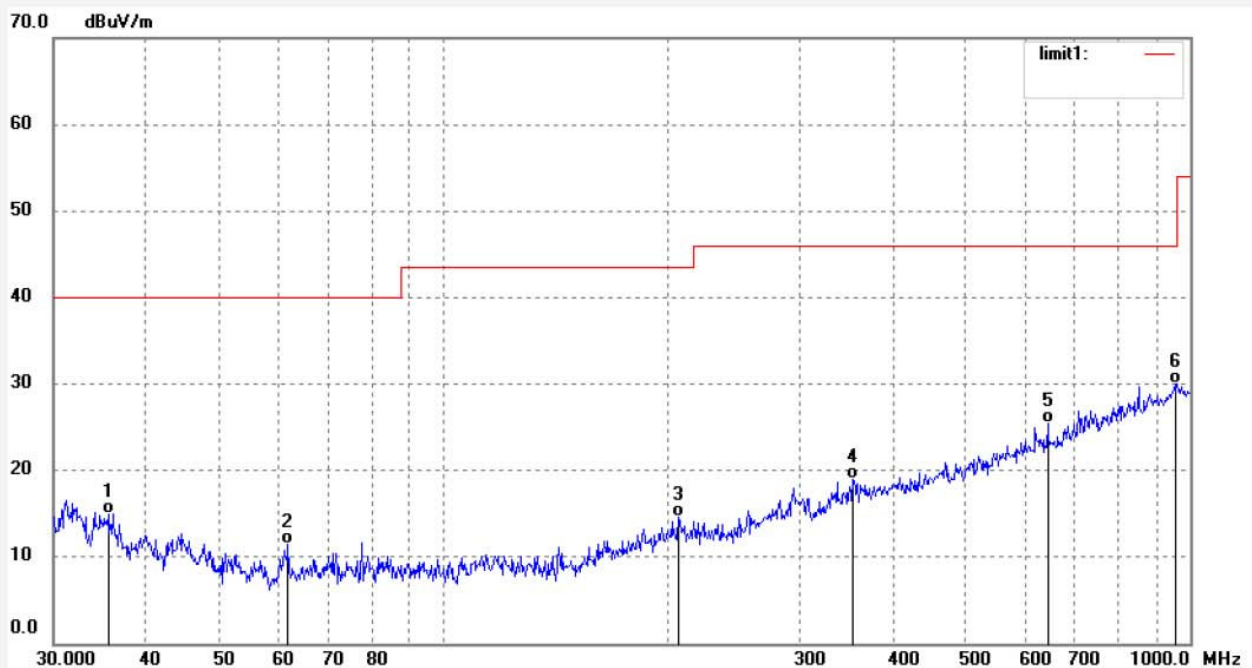

No.	Freq. (MHz)	Reading (dBuV/m)	Factor (dB)	Result (dBuV/m)	Limit (dBuV/m)	Margin (dB)	Detector	Height (cm)	Degree (deg.)	Remark
1	35.5112	31.06	-16.16	14.90	40.00	-25.10	QP			
2	61.8676	33.24	-21.84	11.40	40.00	-28.60	QP			
3	206.4701	33.12	-18.47	14.65	43.50	-28.85	QP			
4	353.4471	32.68	-13.68	19.00	46.00	-27.00	QP			
5	644.5530	32.87	-7.46	25.41	46.00	-20.59	QP			
6	955.3509	31.34	-1.34	30.00	46.00	-16.00	QP			

Job No.: ding1 #21	Polarization: Vertical
Standard: FCC Class B 3M Radiated	Power Source: DC 3.7V
Test item: Radiation Test	Date: 17/04/18/
Temp.(C)/Hum.(%) 25 C / 55 %	Time: 9/17/31
EUT: LED Power Pulse Speaker-blk box	Engineer Signature: DING
Mode: TX 2440MHz	Distance: 3m
Model: CB-335072B	
Manufacturer: CLEVER BRIGHT	

Note: Report NO:ATE20170488

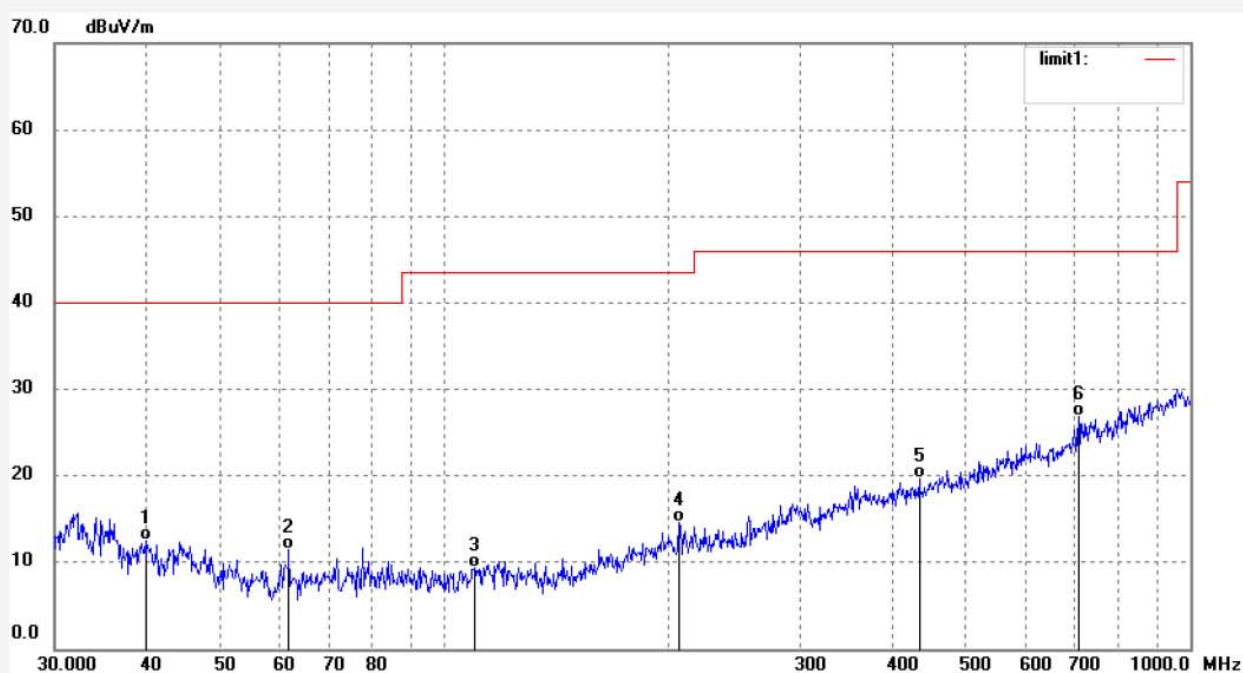

No.	Freq. (MHz)	Reading (dBuV/m)	Factor (dB)	Result (dBuV/m)	Limit (dBuV/m)	Margin (dB)	Detector	Height (cm)	Degree (deg.)	Remark
1	39.8768	30.64	-18.04	12.60	40.00	-27.40	QP			
2	61.8676	33.24	-21.84	11.40	40.00	-28.60	QP			
3	109.6957	31.25	-21.86	9.39	43.50	-34.11	QP			
4	206.4701	33.12	-18.47	14.65	43.50	-28.85	QP			
5	433.3396	31.93	-12.33	19.60	46.00	-26.40	QP			
6	708.6941	33.01	-6.15	26.86	46.00	-19.14	QP			

Job No.: ding1 #23	Polarization: Horizontal
Standard: FCC Class B 3M Radiated	Power Source: DC 3.7V
Test item: Radiation Test	Date: 17/04/18/
Temp.(C)/Hum.(%) 25 C / 55 %	Time: 9/18/11
EUT: LED Power Pulse Speaker-blk box	Engineer Signature: DING
Mode: TX 2480MHz	Distance: 3m
Model: CB-335072B	
Manufacturer: CLEVER BRIGHT	

Note: Report NO:ATE20170488

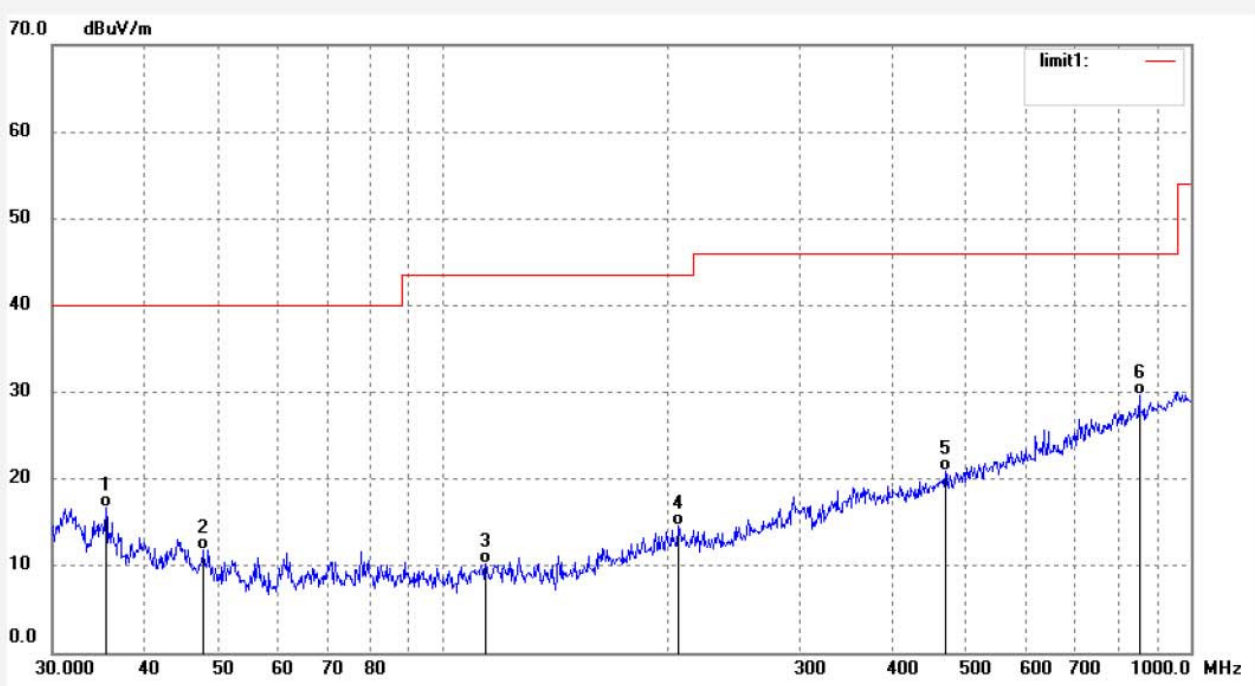

No.	Freq. (MHz)	Reading (dBuV/m)	Factor (dB)	Result (dBuV/m)	Limit (dBuV/m)	Margin (dB)	Detector	Height (cm)	Degree (deg.)	Remark
1	35.3866	32.79	-16.12	16.67	40.00	-23.33	QP			
2	47.8706	31.84	-19.98	11.86	40.00	-28.14	QP			
3	114.0183	32.01	-21.85	10.16	43.50	-33.34	QP			
4	206.4701	33.12	-18.47	14.65	43.50	-28.85	QP			
5	469.8129	32.36	-11.37	20.99	46.00	-25.01	QP			
6	853.7546	32.84	-3.18	29.66	46.00	-16.34	QP			

Job No.: ding1 #24	Polarization: Vertical
Standard: FCC Class B 3M Radiated	Power Source: DC 3.7V
Test item: Radiation Test	Date: 17/04/18/
Temp.(C)/Hum.(%) 25 C / 55 %	Time: 9/18/38
EUT: LED Power Pulse Speaker-blk box	Engineer Signature: DING
Mode: TX 2480MHz	Distance: 3m
Model: CB-335072B	
Manufacturer: CLEVER BRIGHT	

Note: Report NO:ATE20170488

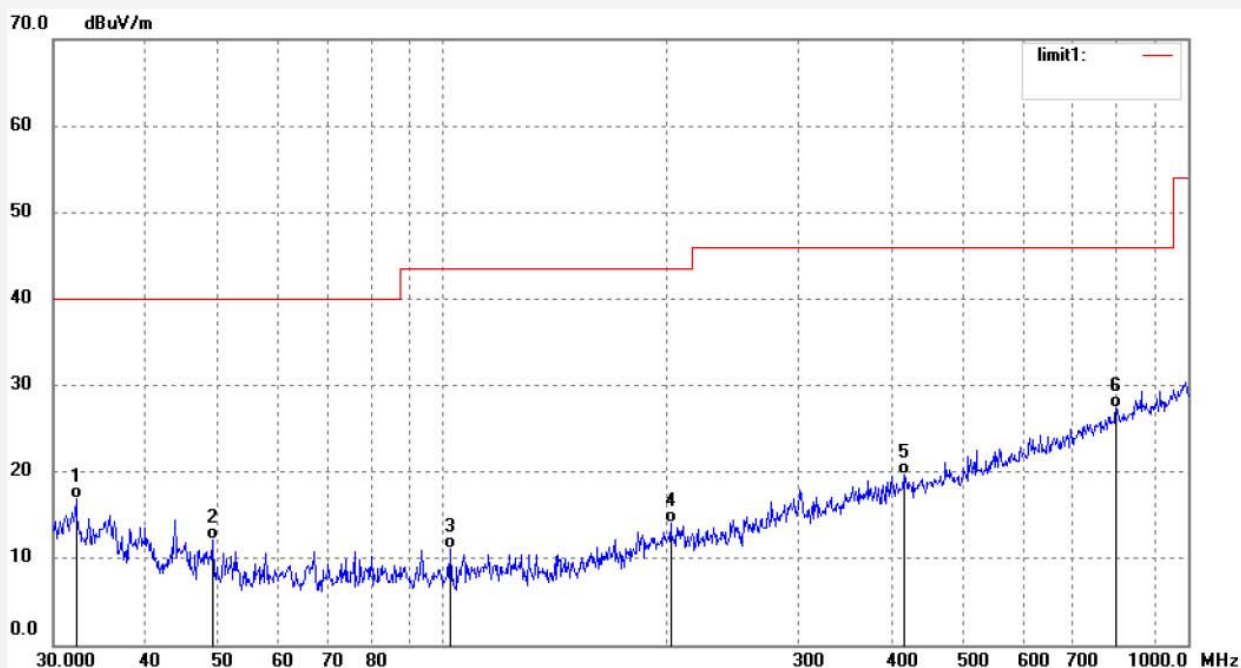

No.	Freq. (MHz)	Reading (dBuV/m)	Factor (dB)	Result (dBuV/m)	Limit (dBuV/m)	Margin (dB)	Detector	Height (cm)	Degree (deg.)	Remark
1	32.1839	32.10	-15.24	16.86	40.00	-23.14	QP			
2	49.0626	32.56	-20.45	12.11	40.00	-27.89	QP			
3	102.2518	33.82	-22.67	11.15	43.50	-32.35	QP			
4	202.1630	32.70	-18.59	14.11	43.50	-29.39	QP			
5	415.4485	32.34	-12.72	19.62	46.00	-26.38	QP			
6	801.4314	31.50	-4.15	27.35	46.00	-18.65	QP			

Above 1GHz



ACCURATE TECHNOLOGY CO., LTD.

F1,Bldg,A,Changyuan New Material Port Keyuan Rd,
Science & Industry Park,Nanshan Shenzhen,P.R.China

Site: 1# Chamber

Tel:+86-0755-26503290

Fax:+86-0755-26503396

Job No.: DING #302	Polarization: Horizontal
Standard: FCC PK	Power Source: DC 3.7V
Test item: Radiation Test	Date: 17/04/17/
Temp.(C)/Hum.(%) 25 C / 55 %	Time: 9/11/58
EUT: LED Power Pulse Speaker-blk box	Engineer Signature: DING
Mode: TX 2402MHz	Distance: 3m
Model: CB-335072B	
Manufacturer: CLEVER BRIGHT	

Note: Report NO.:ATE20170488

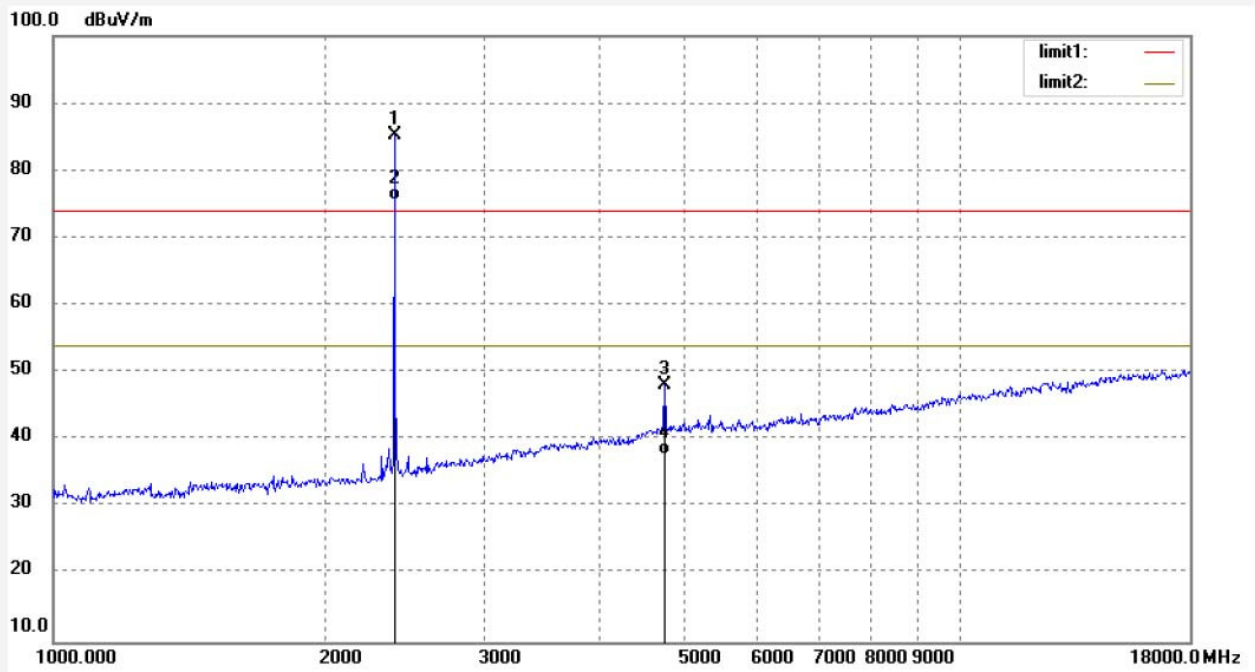

No.	Freq. (MHz)	Reading (dBuV/m)	Factor (dB)	Result (dBuV/m)	Limit (dBuV/m)	Margin (dB)	Detector	Height (cm)	Degree (deg.)	Remark
1	2402.119	91.30	-5.98	85.32			peak			
2	2402.119	81.46	-5.98	75.48			AVG			
3	4804.257	44.99	3.15	48.14	74.00	-25.86	peak			
4	4804.257	34.57	3.15	37.72	54.00	-16.28	AVG			

Job No.: DING #303	Polarization: Vertical
Standard: FCC PK	Power Source: DC 3.7V
Test item: Radiation Test	Date: 17/04/17/
Temp.(C)/Hum.(%) 25 C / 55 %	Time: 9/12/40
EUT: LED Power Pulse Speaker-blk box	Engineer Signature: DING
Mode: TX 2402MHz	Distance: 3m
Model: CB-335072B	
Manufacturer: CLEVER BRIGHT	

Note: Report NO.:ATE20170488

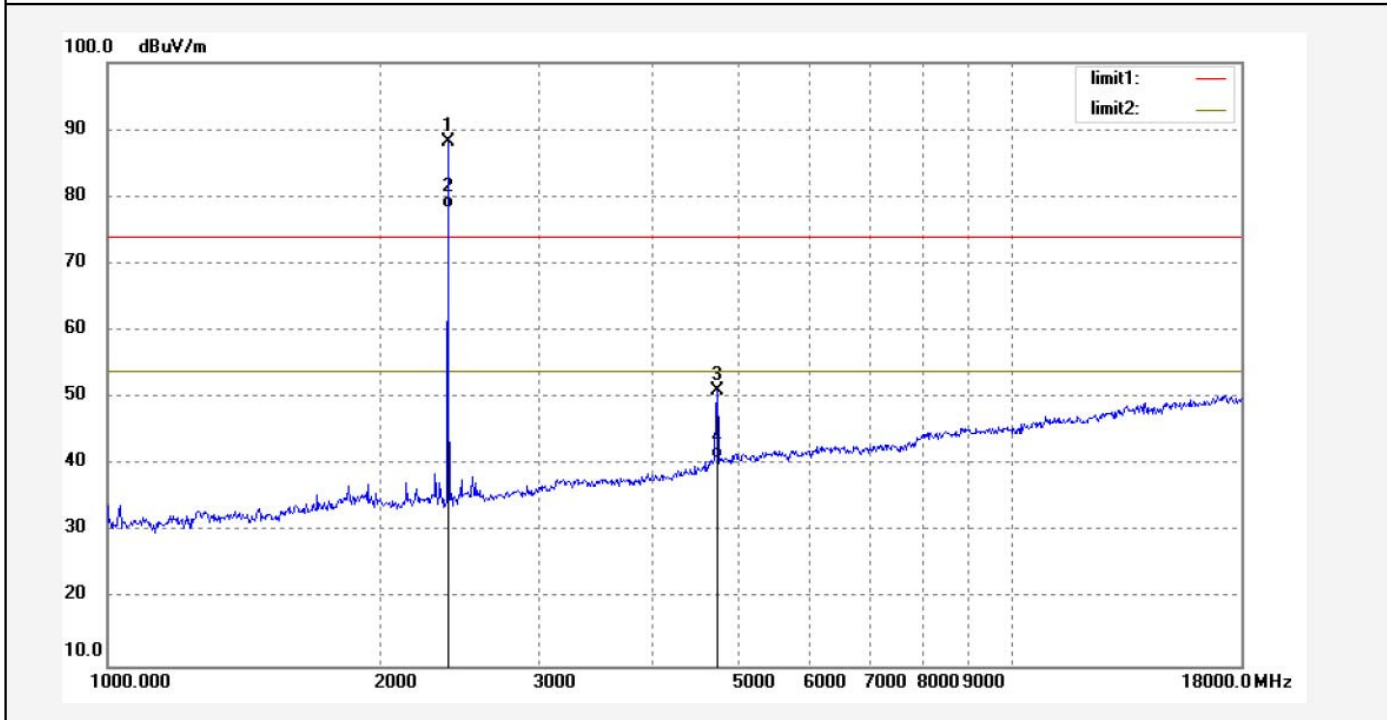

No.	Freq. (MHz)	Reading (dBuV/m)	Factor (dB)	Result (dBuV/m)	Limit (dBuV/m)	Margin (dB)	Detector	Height (cm)	Degree (deg.)	Remark
1	2402.119	94.12	-5.98	88.14			peak			
2	2402.119	84.21	-5.98	78.23			AVG			
3	4804.257	47.92	3.15	51.07	74.00	-22.93	peak			
4	4804.257	37.68	3.15	40.83	54.00	-13.17	AVG			

Job No.: DING #305

Standard: FCC PK

Test item: Radiation Test

Temp.(C)/Hum.(%) 25 C / 55 %

EUT: LED Power Pulse Speaker-blk box

Mode: TX 2440MHz

Model: CB-335072B

Manufacturer: CLEVER BRIGHT

Polarization: Horizontal

Power Source: DC 3.7V

Date: 17/04/17/

Time: 9/15/22

Engineer Signature: DING

Distance: 3m

Note: Report NO.:ATE20170488

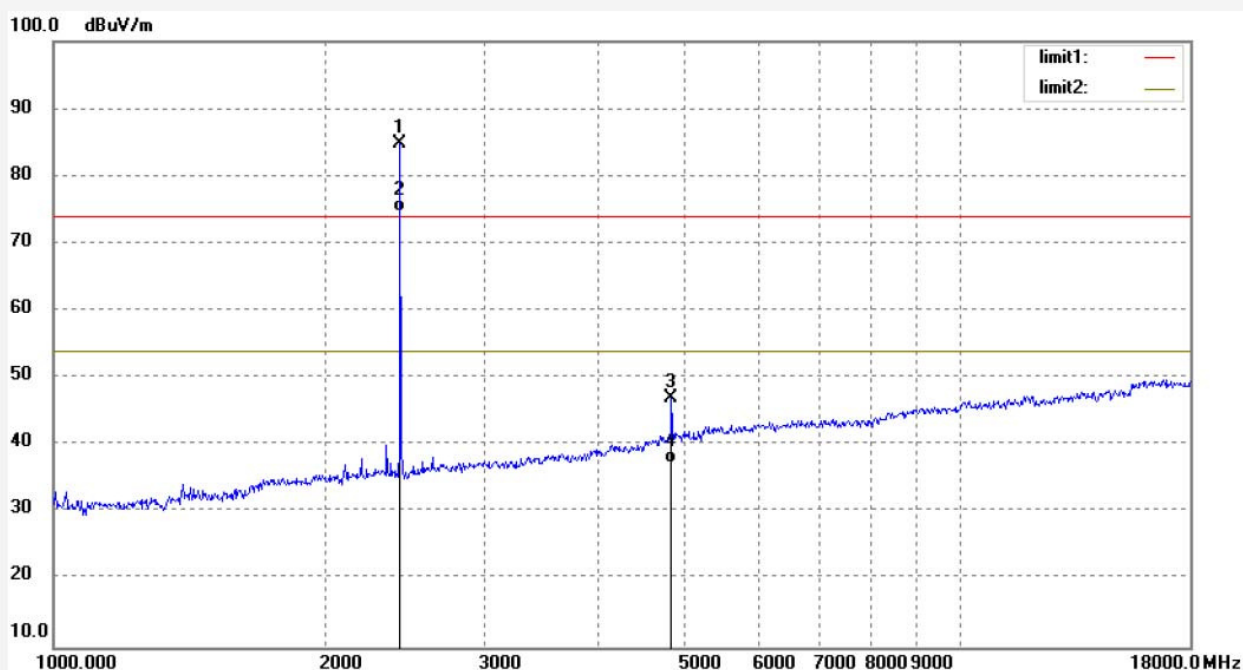

No.	Freq. (MHz)	Reading (dBuV/m)	Factor (dB)	Result (dBuV/m)	Limit (dBuV/m)	Margin (dB)	Detector	Height (cm)	Degree (deg.)	Remark
1	2440.121	90.61	-5.72	84.89			peak			
2	2440.121	80.49	-5.72	74.77			AVG			
3	4880.224	43.45	3.67	47.12	74.00	-26.88	peak			
4	4880.224	33.76	3.67	37.43	54.00	-16.57	AVG			

Job No.: DING #304	Polarization: Vertical
Standard: FCC PK	Power Source: DC 3.7V
Test item: Radiation Test	Date: 17/04/17/
Temp.(C)/Hum.(%) 25 C / 55 %	Time: 9/14/13
EUT: LED Power Pulse Speaker-blk box	Engineer Signature: DING
Mode: TX 2440MHz	Distance: 3m
Model: CB-335072B	
Manufacturer: CLEVER BRIGHT	

Note: Report NO.:ATE20170488

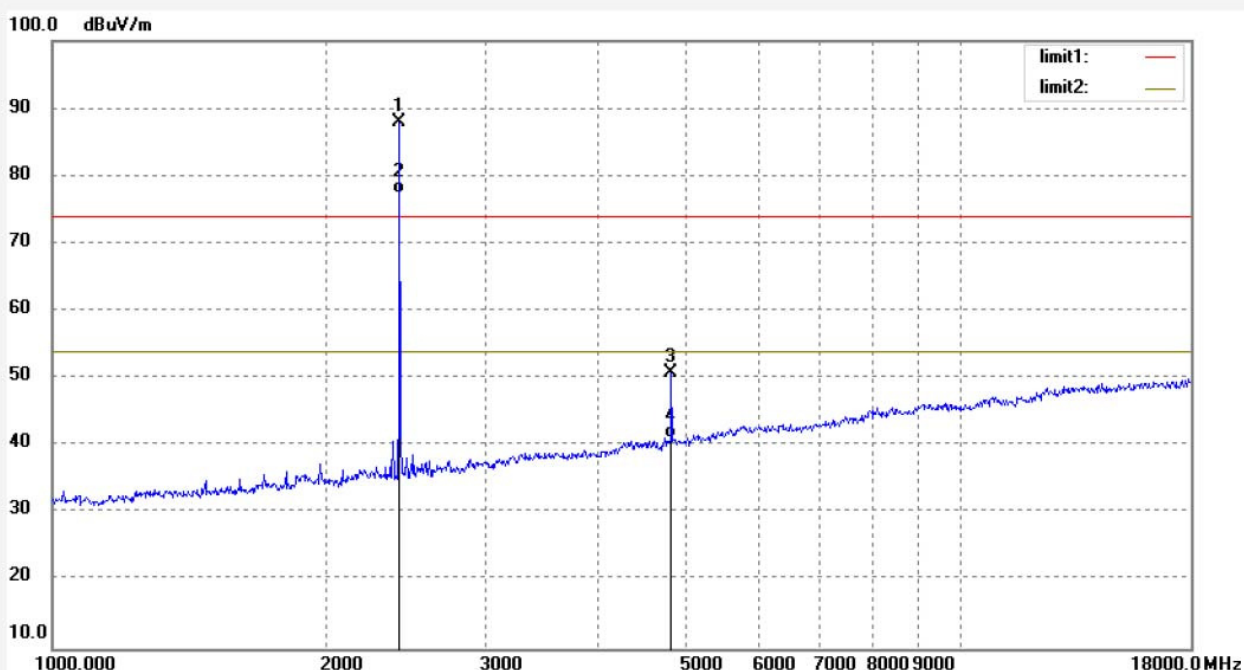

No.	Freq. (MHz)	Reading (dBuV/m)	Factor (dB)	Result (dBuV/m)	Limit (dBuV/m)	Margin (dB)	Detector	Height (cm)	Degree (deg.)	Remark
1	2440.121	93.61	-5.72	87.89			peak			
2	2440.121	83.02	-5.72	77.30			AVG			
3	4880.324	47.19	3.67	50.86	74.00	-23.14	peak			
4	4880.324	37.44	3.67	41.11	54.00	-12.89	AVG			

Job No.: DING #306	Polarization: Horizontal
Standard: FCC PK	Power Source: DC 3.7V
Test item: Radiation Test	Date: 17/04/17/
Temp.(C)/Hum.(%) 25 C / 55 %	Time: 9/16/27
EUT: LED Power Pulse Speaker-blk box	Engineer Signature: DING
Mode: TX 2480MHz	Distance: 3m
Model: CB-335072B	
Manufacturer: CLEVER BRIGHT	

Note: Report NO.:ATE20170488

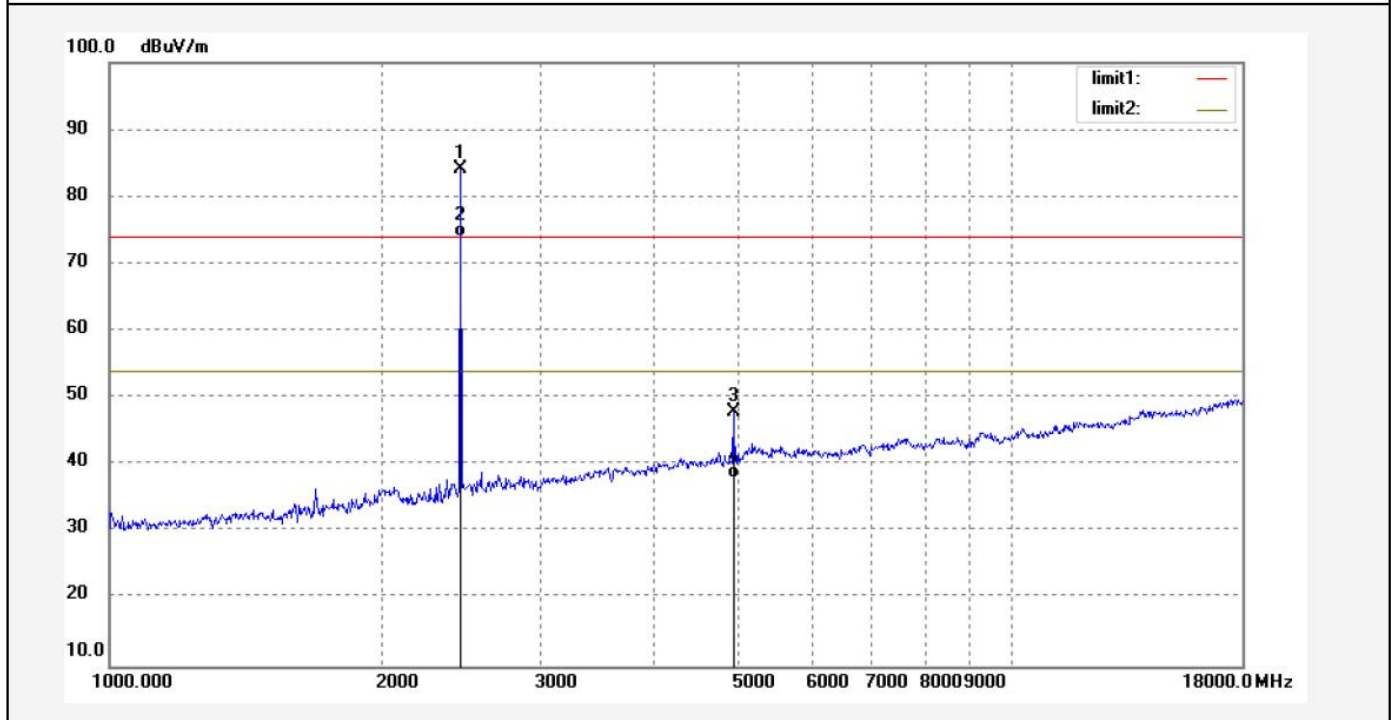

No.	Freq. (MHz)	Reading (dBuV/m)	Factor (dB)	Result (dBuV/m)	Limit (dBuV/m)	Margin (dB)	Detector	Height (cm)	Degree (deg.)	Remark
1	2480.014	89.66	-5.55	84.11			peak			
2	2480.014	79.64	-5.55	74.09			AVG			
3	4960.044	43.44	4.54	47.98	74.00	-26.02	peak			
4	4960.044	33.56	4.54	38.10	54.00	-15.90	AVG			

Job No.: DING #307

Standard: FCC PK

Test item: Radiation Test

Temp.(C)/Hum.(%) 25 C / 55 %

EUT: LED Power Pulse Speaker-blk box

Mode: TX 2480MHz

Model: CB-335072B

Manufacturer: CLEVER BRIGHT

Polarization: Vertical

Power Source: DC 3.7V

Date: 17/04/17/

Time: 9/17/56

Engineer Signature: DING

Distance: 3m

Note: Report NO.:ATE20170488

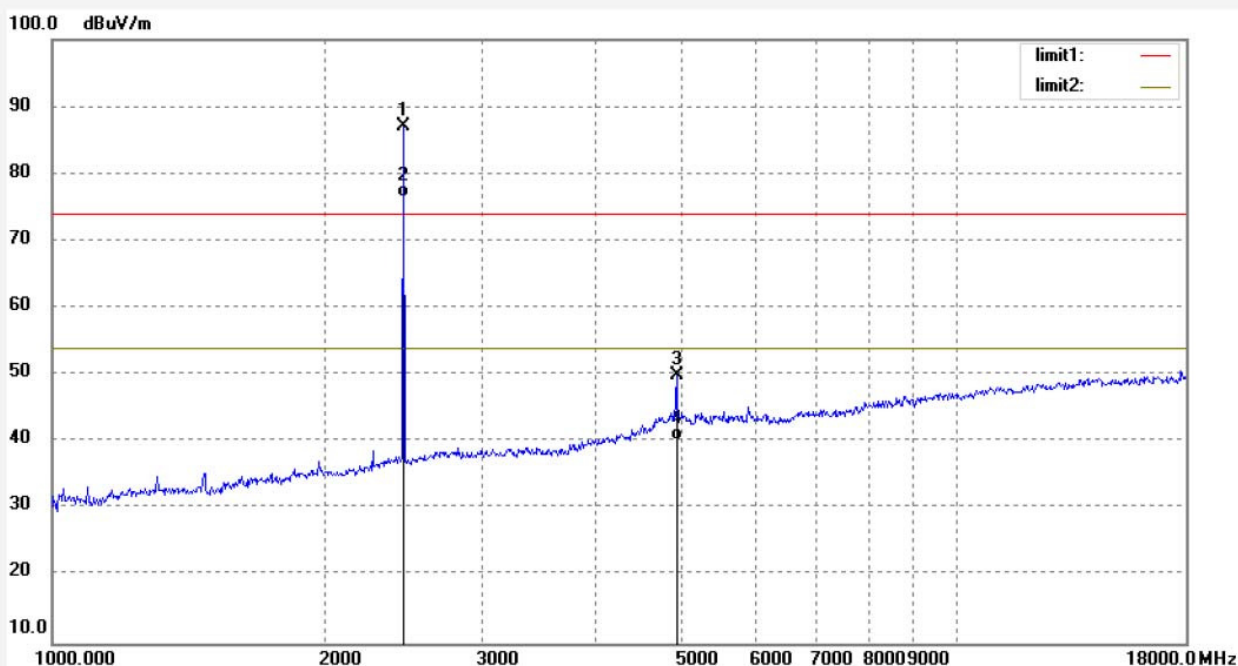

No.	Freq. (MHz)	Reading (dBuV/m)	Factor (dB)	Result (dBuV/m)	Limit (dBuV/m)	Margin (dB)	Detector	Height (cm)	Degree (deg.)	Remark
1	2480.014	92.55	-5.55	87.00			peak			
2	2480.014	82.14	-5.55	76.59			AVG			
3	4960.044	45.33	4.54	49.87	74.00	-24.13	peak			
4	4960.044	35.68	4.54	40.22	54.00	-13.78	AVG			

11. ANTENNA REQUIREMENT

11.1. The Requirement

According to Section 15.203, an intentional radiator shall be designed to ensure that no antenna other than that furnished by the responsible party shall be used with the device.

11.2. Antenna Construction

Device is equipped with permanent attached antenna, which isn't displaced by other antenna. The Antenna gain of EUT is 0dBi. Therefore, the equipment complies with the antenna requirement of Section 15.203.

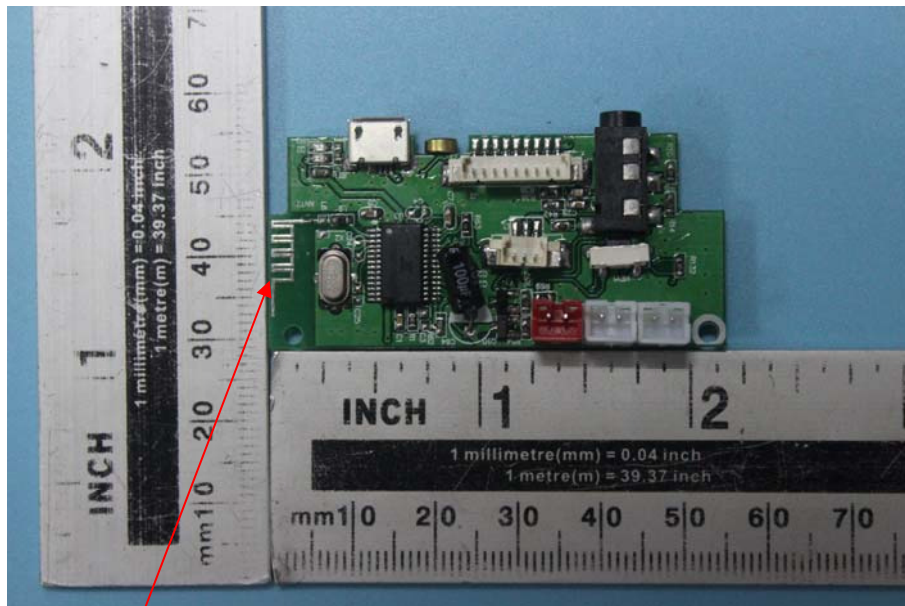

Antenna