

# FCC Report

**Application Purpose** : Original grant  
**Applicant Name:** : METEC ELECTRONICS CO., LTD.  
**FCC ID** : 2AD38TSME26BLK  
**Equipment Type** : MULTIMEDIA SPEAKER  
**Model Name** : TSME26 BLK, TSME26 BRD  
**Report Number** : FCC15080103  
**Standard(S)** : FCC Part 15 Subpart C  
**Date Of Receipt** : August 10, 2015  
**Date Of Issue** : August 18, 2015

**Test By** :

*Fall Ma*

(Fall Ma)

**Reviewed By** :

*Robie Chen*

(Robie Chen)

**Authorized by** :

*Michal Ling*

(Michal Ling)

**Prepared by** :

**Shenzhen WST Testing Technology Co., Ltd.**  
1F, No.9 Building, TGK Science & Technology Park Yangtian  
Rd., NO.72 Bao'an Dist., GuangDong, China

**REPORT REVISE RECORD**

<b>Report Version</b>	<b>Revise Time</b>	<b>Issued Date</b>	<b>Valid Version</b>	<b>Notes</b>
V1.0	/	August 18, 2015	Valid	Original Report

Table of Contents	Page
<b>1. GENERAL INFORMATION</b>	<b>5</b>
<b>2. TEST DESCRIPTION</b>	<b>7</b>
2.1 MEASUREMENT UNCERTAINTY	7
2.2 DESCRIPTION OF TEST MODES	8
2.3 TABLE OF PARAMETERS OF TEXT SOFTWARE SETTING	9
2.4 CONFIGURATION OF SYSTEM UNDER TEST	9
2.5 PERIPHERALS EQUIPMENT LIST	9
2.6 DESCRIPTION OF SUPPORT UNITS (CONDUCTED MODE)	10
<b>3. SUMMARY OF TEST RESULTS</b>	<b>11</b>
<b>4. MEASUREMENT INSTRUMENTS</b>	<b>12</b>
<b>5. EMC EMISSION TEST</b>	<b>13</b>
5.1 CONDUCTED EMISSION MEASUREMENT	13
5.1.1 POWER LINE CONDUCTED EMISSION LIMITS	13
5.1.2 TEST PROCEDURE	14
5.1.3 DEVIATION FROM TEST STANDARD	14
5.1.4 TEST SETUP	14
5.1.5 EUT OPERATING CONDITIONS	14
5.1.6 TEST RESULTS	15
5.2 RADIATED EMISSION MEASUREMENT	17
5.2.1 RADIATED EMISSION LIMITS	17
5.2.2 TEST PROCEDURE	17
5.2.3 DEVIATION FROM TEST STANDARD	18
5.2.4 TEST SETUP	19
5.2.5 EUT OPERATING CONDITIONS	20
5.2.5.1 RESULTS (BELOW 30 MHZ)	21
5.2.5.2 TEST RESULTS (BETWEEN 30M – 1000 MHZ)	22
5.2.5.3 TEST RESULTS(1GHZ TO 25GHZ)	24
5.3 CONDUCTED SPURIOUS EMISSION MEASUREMENT	32
5.3.1 CONDUCTED SPURIOUS EMISSION LIMITS	32
5.3.2 TEST PROCEDURE	32
5.3.3 DEVIATION FROM STANDARD	32
5.3.4 TEST SETUP	32
5.3.5 EUT OPERATION CONDITIONS	32
5.3.6 TEST RESULTS	33
<b>6. NUMBER OF HOPPING CHANNEL</b>	
6.1 APPLIED PROCEDURES / LIMIT	41

<b>Table of Contents</b>	<b>Page</b>
6.2 TEST PROCEDURE	41
6.3 DEVIATION FROM STANDARD	41
6.4 TEST SETUP	41
6.5 EUT OPERATION CONDITIONS	41
6.6 TEST RESULTS	42
<b>7. AVERAGE TIME OF OCCUPANCY</b>	
7.1 APPLIED PROCEDURES / LIMIT	43
7.2 TEST PROCEDURE	43
7.3 DEVIATION FROM STANDARD	43
7.4 TEST SETUP	44
7.5 EUT OPERATION CONDITIONS	44
7.6 TEST RESULTS	45
<b>8. HOPPING CHANNEL SEPARATION MEASUREMENT</b>	
8.1 APPLIED PROCEDURES / LIMIT	47
8.2 TEST PROCEDURE	47
8.3 DEVIATION FROM STANDARD	47
8.4 TEST SETUP	47
8.5 EUT OPERATION CONDITIONS	47
8.6 TEST RESULTS	48
<b>9. BANDWIDTH TEST</b>	
9.1 APPLIED PROCEDURES / LIMIT	54
9.2 TEST PROCEDURE	54
9.3 DEVIATION FROM STANDARD	54
9.4 TEST SETUP	54
9.5 EUT OPERATION CONDITIONS	54
9.6 TEST RESULTS	55
<b>10. PEAK OUTPUT POWER TEST</b>	
10.1 APPLIED PROCEDURES / LIMIT	61
10.2 TEST PROCEDURE	61
10.3 DEVIATION FROM STANDARD	61
10.4 TEST SETUP	61
10.5 EUT OPERATION CONDITIONS	61
10.6 TEST RESULTS	62
<b>11. ANTENNA APPLICATION</b>	63
<b>12. EUT TEST PHOTO</b>	64
<b>13. PHOTOGRAPHS OF EUT</b>	66

## 1. GENERAL INFORMATION

### GENERAL DESCRIPTION OF EUT

Test Model	TSME26 BLK
Derivative Model Name	TSME26 BRD
Model difference	All models are identical in circuitry and electrical, mechanical and physical construction, only different on model name, color and size. All tests are carried out on TSME26 BLK.
Applicant	METEC ELECTRONICS CO., LTD.
Address	Building D, No. 4 Industrial Zone of Shasan Village, Shajing Town, Bao'an District, Shenzhen, China
Manufacturer	SHENZHEN BEYEAR APPLIANCE CO., LTD.
Address	Building D, No. 4 Industrial Zone of Shasan Village, Shajing Town, Bao'an District, Shenzhen, China
Equipment Type	MULTIMEDIA SPEAKER
Brand Name	
Hardware version:	EM-1073-2 CON-DATE150117 VER1.0
Software version:	VER1.0.0
Extreme Temp. Tolerance	-10°C to +50°C
Operating Voltage	Input: AC 120V 60Hz
Operating Frequency	2402-2480MHz
Channels	79
Channel Spacing	1MHz
Modulation Type	GFSK, $\pi/4$ -DQPSK, 8-DPSK
Version	2.1+EDR
Antenna Type:	PCB Antenna
Antenna gain:	1.0dBi
Data of receipt	August 10, 2015
Date of test	August 10, 2015 to August 18, 2015
Deviation	None
Condition of Test Sample	Normal

**We hereby certify that:**

The above equipment was tested by Shenzhen WST Testing Technology Co., Ltd.

Registration Number: 939433

The data evaluation, test procedures, and equipment configurations shown in this report were made in accordance with the procedures given in ANSI C 63.4:2009. The sample tested as described in this report is in compliance with the FCC Rules Part15 Subpart C.

The test results of this report relate only to the tested sample identified in this report.

## 2. TEST DESCRIPTION

### 2.1 MEASUREMENT UNCERTAINTY

The reported uncertainty of measurement  $y \pm U$ , where expanded uncertainty  $U$  is based on a standard uncertainty multiplied by a coverage factor of  $k=2$ , providing a level of confidence of approximately **95 %**.

No.	Item	Uncertainty
1	Conducted Emission Test	$\pm 3.2$ dB
2	RF power, conducted	$\pm 0.16$ dB
3	Spurious emissions, conducted	$\pm 0.21$ dB
4	All emissions, radiated(<1G)	$\pm 4.7$ dB
5	All emissions, radiated(>1G)	$\pm 4.7$ dB
6	Temperature	$\pm 0.5^{\circ}$ C
7	Humidity	$\pm 2\%$

## 2.2 DESCRIPTION OF TEST MODES

To investigate the maximum EMI emission characteristics generated from EUT, the test system was pre-scanning tested based on the consideration of following EUT operation mode or test configuration mode which possibly have effect on EMI emission level. Each of these EUT operation mode(s) or test configuration mode(s) mentioned above was evaluated respectively.

Pretest Mode	Description
Mode 1	CH00
Mode 2	CH39
Mode 3	CH78
Mode 4	Normal Hopping

For Conducted Emission	
Final Test Mode	Description
Mode 4	Normal Hopping

For Radiated Emission	
Final Test Mode	Description
Mode 1	CH00
Mode 2	CH39
Mode 3	CH78

Note:

- (1) The measurements are performed at the highest, middle, lowest available channels.**
- (2) The data rate was set in 1Mbps, 2 Mbps, 3 Mbps for radiated emission due to the highest RF output power.**
- (3) Record the worst case of each test item in this report.**



### 2.3 TABLE OF PARAMETERS OF TEXT SOFTWARE SETTING

During testing channel & power controlling software provided by the customer was used to control the operating channel as well as the output power level. The RF output power selection is for the setting of RF output power expected by the customer and is going to be fixed on the firmware of the final end product power parameters of FHSS

Test software Version	N/A		
Frequency	2402 MHz	2441 MHz	2480 MHz
Parameters(1Mbps)	DEF	DEF	DEF
Parameters(2Mbps)	DEF	DEF	DEF
Parameters(3Mbps)	DEF	DEF	DEF

### 2.4 CONFIGURATION OF SYSTEM UNDER TEST

(1) Conducted emission

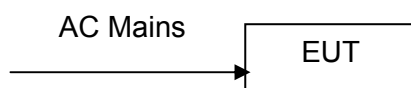

(2) Radiated emission

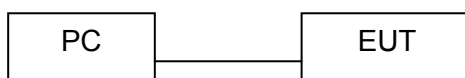

(EUT: MULTIMEDIA SPEAKER)

### 2.5 PERIPHERALS EQUIPMENT LIST

Item	Equipment	Model No.	ID or Specification	Remark
1	N/A	N/A	N/A	N/A

**2.6 DESCRIPTION OF SUPPORT UNITS (CONDUCTED MODE)**

The EUT has been tested as an independent unit together with other necessary accessories or support units. The following support units or accessories were used to form a representative test configuration during the tests.

Item	Equipment	Mfr/Brand	Model/Type No.	Series No.	Note
1	PC	DS	DS Series	/	/

**Note:**

- (1) The support equipment was authorized by Declaration of Confirmation.
- (2) For detachable type I/O cable should be specified the length in cm in 『Length』 column.
- (3) “YES” is means “shielded” “with core”; “NO” is means “unshielded” “without core”.
- (4) The adapter supply by the applicant.

### 3. SUMMARY OF TEST RESULTS

Test procedures according to the technical standards:

FCC Part15 (15.247) , Subpart C			
Standard Section	Test Item	Judgment	Remark
15.207	Conducted Emission	PASS	
15.247(a)(1)	Hopping Channel Separation	PASS	
15.247(b)(1)	Peak Output Power	PASS	
15.247(c)	Radiated Spurious Emission	PASS	
15.247(d)	Conducted Spurious Emission	PASS	
15.247(a)(iii)	Number of Hopping Frequency	PASS	
15.247(a)(iii)	Dwell Time	PASS	
15.247(a)(1)	Bandwidth	PASS	
15.205	Band Edge Emission	PASS	
15.203	Antenna Requirement	PASS	

**NOTE:**

(1) "N/A" denotes test is not applicable in this test report.

**4. MEASUREMENT INSTRUMENTS**

Kind of Equipment	Manufacturer	Type No.	Serial No.	Last Calibrated	Calibrated until
ESPI Test Receiver	R&S	ESPI	100379	2014-08-19	2015-08-18
EMI Test Receiver	R&S	ESCI	100005	2014-08-19	2015-08-18
LISN	Mestec	AN3016	04/10040	2014-08-19	2015-08-18
Coaxial cable	Megalon	LMR400	C001	2014-08-19	2015-08-18
System Controller	CT	SC100	011208	2014-08-19	2015-08-18
Bi-log Antenna	Chase	CBL6111C	2576	2014-08-19	2015-08-18
Spectrum analyzer	R&S	FSU26	200409	2014-08-19	2015-08-18
Horn Antenna	SCHWARZBECK	9120D	1141	2014-08-19	2015-08-18
Bi-log Antenna	Schwarebeck	VULB9163	9163/340	2014-08-19	2015-08-18
Loop Antenna	EMCO	6502	00042960	2014-08-22	2015-08-21
Pre Amplifier	H.P.	HP8447E	2945A02715	2014-10-13	2015-10-12
Pre-Amplifier	CDSI	PAP-1G18-38	7621	2014-10-13	2015-10-12
8*4*3 Anechoic	SAEMC	L×W×H 8×4×3	A001	2014-08-21	2015-08-20
9*6*6 Anechoic	SAEMC	L×W×H 9×6×6	A002	2014-08-21	2015-08-20
Power meter	Anritsu	ML2487A	6K00003613	2014-08-23	2015-08-22
H & T Chamber	Guangzhou gongwen	GDJS-500-40	0329	2014-08-19	2015-08-18
MXA Signal Analyzer	Aglient	N9020A	54123254	2014-08-19	2015-08-18
Power sensor	Anritsu	MX248XD	95327410	2014-08-19	2015-08-18
RF cable	H+S	SUCOFLEX 102	R002	2014-08-19	2015-08-18
Horn Antenna	SCHWARZBECK	BBHA 9170	1123	2014-08-19	2015-08-18

## 5. EMC EMISSION TEST

### 5.1 CONDUCTED EMISSION MEASUREMENT

#### 5.1.1 POWER LINE CONDUCTED EMISSION Limits (Frequency Range 150KHz-30MHz)

FREQUENCY (MHz)	Class A (dBuV)		Class B (dBuV)		Standard
	Quasi-peak	Average	Quasi-peak	Average	
0.15 -0.5	79.00	66.00	66 - 56 *	56 - 46 *	FCC
0.50 -5.0	73.00	60.00	56.00	46.00	FCC
5.0 -30.0	73.00	60.00	60.00	50.00	FCC

Note:

- (1) The tighter limit applies at the band edges.
- (2) The limit of " \* " marked band means the limitation decreases linearly with the logarithm of the frequency in the range.

The following table is the setting of the receiver

Receiver Parameters	Setting
Attenuation	10 dB
Start Frequency	0.15 MHz
Stop Frequency	30 MHz
IF Bandwidth	9 kHz

### 5.1.2 TEST PROCEDURE

- The EUT was placed 0.4 meters from the horizontal ground plane with EUT being connected to the power mains through a line impedance stabilization network (LISN). All other support equipments powered from additional LISN(s). The LISN provide 50 Ohm/ 50uH of coupling impedance for the measuring instrument.
- Interconnecting cables that hang closer than 40 cm to the ground plane shall be folded back and forth in the center forming a bundle 30 to 40 cm long.
- I/O cables that are not connected to a peripheral shall be bundled in the center. The end of the cable may be terminated, if required, using the correct terminating impedance. The overall length shall not exceed 1 m.
- LISN at least 80 cm from nearest part of EUT chassis.
- For the actual test configuration, please refer to the related Item –EUT Test Photos.

### 5.1.3 DEVIATION FROM TEST STANDARD

No deviation

### 5.1.4 TEST SETUP

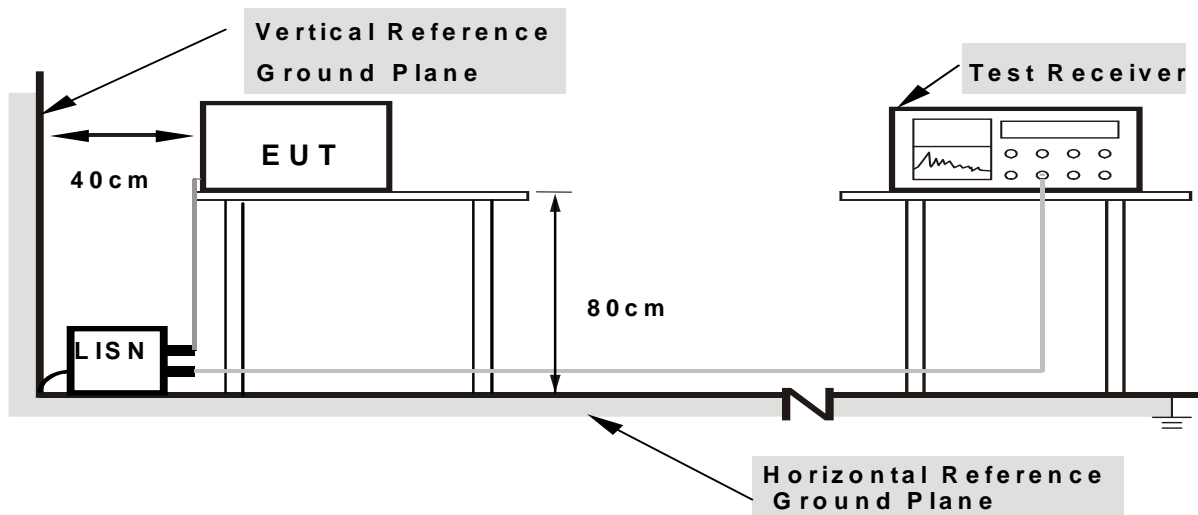

- Note:** 1. Support units were connected to second LISN.  
 2. Both of LISNs (AMN) are 80 cm from EUT and at least 80 cm from other units and other metal planes

### 5.1.5 EUT OPERATING CONDITIONS

The EUT was configured for testing in a typical fashion (as a customer would normally use it). The EUT has been programmed to continuously transmit during test. This operating condition was tested and used to collect the included data.

### 5.1.6 TEST RESULTS

EUT	MULTIMEDIA SPEAKER	Model Name	TSME26 BLK
Temperature	24 °C	Relative Humidity	54%
Pressure	1010hPa	Phase	L
Test Date	August 12, 2015	Test Mode	Mode 4
Test Voltage	AC120V/60Hz:		

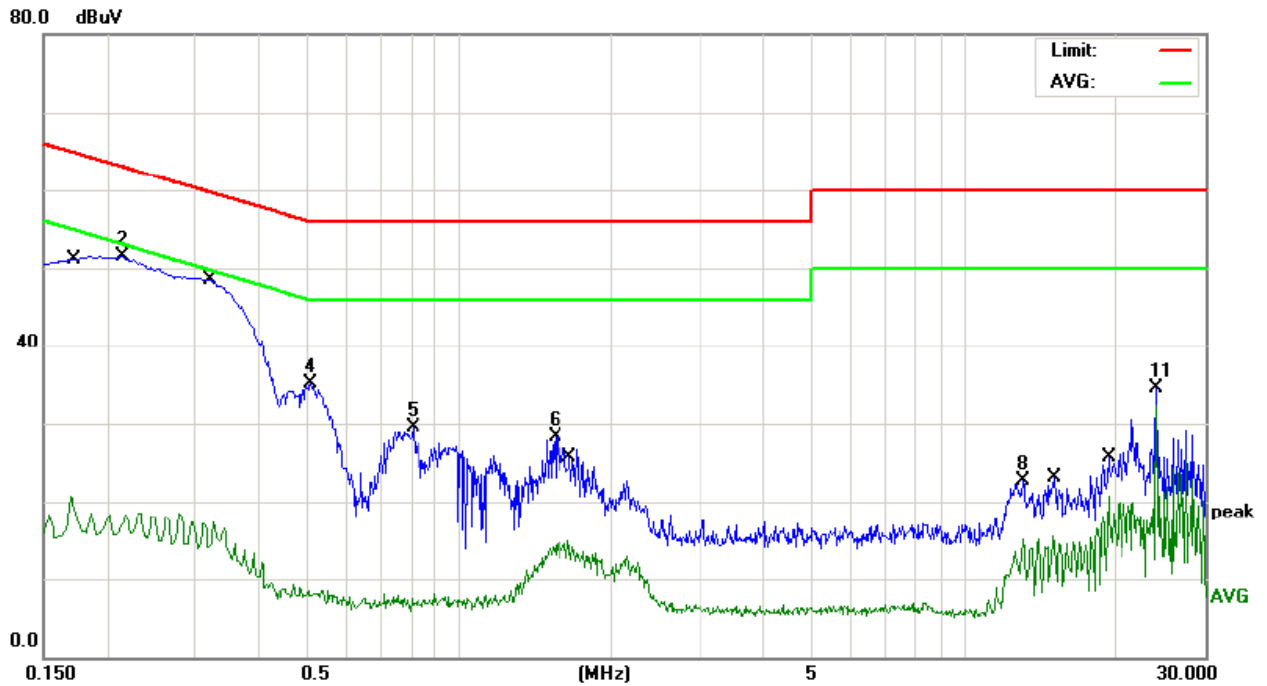

No.	Mk.	Freq. MHz	Reading Level dBuV	Correct Factor dB	Measure- ment dBuV	Limit dBuV	Over dB	Detector
1		0.1700	10.26	10.39	20.65	54.96	-34.31	AVG
2	*	0.2140	41.09	10.35	51.44	63.04	-11.60	peak
3		0.3260	6.65	10.61	17.26	49.55	-32.29	AVG
4		0.5100	24.61	10.43	35.04	56.00	-20.96	peak
5		0.8100	18.95	10.54	29.49	56.00	-26.51	peak
6		1.5540	17.65	10.73	28.38	56.00	-27.62	peak
7		1.6380	4.16	10.73	14.89	46.00	-31.11	AVG
8		13.1139	12.25	10.43	22.68	60.00	-37.32	peak
9		14.9939	5.06	10.45	15.51	50.00	-34.49	AVG
10		19.2859	10.24	10.49	20.73	50.00	-29.27	AVG
11		24.0340	24.05	10.54	34.59	60.00	-25.41	peak
12		24.0340	21.78	10.54	32.32	50.00	-17.68	AVG

Remark: All the modes have been investigated, and only worst mode is presented in this report.

EUT	MULTIMEDIA SPEAKER	Model Name	TSME26 BLK
Temperature	24 °C	Relative Humidity	54%
Pressure	1010hPa	Phase	N
Test Date	August 12, 2015	Test Mode	Mode 4
Test Voltage	AC120V/60Hz		

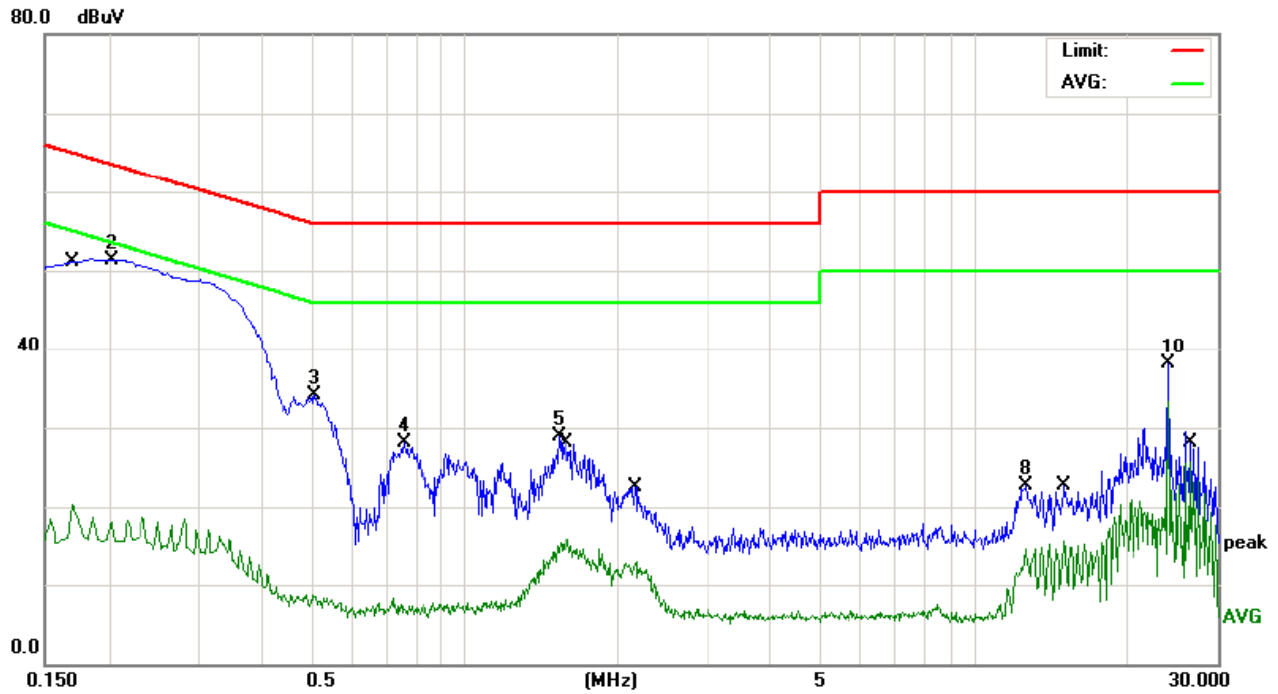

No.	Mk.	Freq. MHz	Reading Level dBuV	Correct Factor dB	Measure- ment dBuV	Limit dBuV	Over dB	Detector
1		0.1700	9.93	10.39	20.32	54.96	-34.64	AVG
2	*	0.2020	41.04	10.31	51.35	63.52	-12.17	peak
3		0.5100	23.74	10.43	34.17	56.00	-21.83	peak
4		0.7620	17.47	10.65	28.12	56.00	-27.88	peak
5		1.5300	18.23	10.73	28.96	56.00	-27.04	peak
6		1.5700	4.97	10.73	15.70	46.00	-30.30	AVG
7		2.1780	2.19	10.71	12.90	46.00	-33.10	AVG
8		12.6780	12.18	10.43	22.61	60.00	-37.39	peak
9		14.9940	5.08	10.45	15.53	50.00	-34.47	AVG
10		24.0340	27.61	10.54	38.15	60.00	-21.85	peak
11		24.0340	22.67	10.54	33.21	50.00	-16.79	AVG
12		26.5580	15.09	10.57	25.66	50.00	-24.34	AVG

Remark: All the modes have been investigated, and only worst mode is presented in this report.



## 5.2 RADIATED EMISSION MEASUREMENT

### 5.2.1 RADIATED EMISSION LIMITS (Frequency Range 9kHz-1000MHz)

20dBc in any 100 kHz bandwidth outside the operating frequency band. In case the emission fall within the restricted band specified on 15.205(a), then the 15.209(a) limit in the table below has to be followed.

Frequencies (MHz)	Field Strength (micorvolts/meter)	Measurement Distance (meters)
0.009~0.490	2400/F(KHz)	300
0.490~1.705	24000/F(KHz)	30
1.705~30.0	30	30
30~88	100	3
88~216	150	3
216~960	200	3
Above 960	500	3

### LIMITS OF RADIATED EMISSION MEASUREMENT (Above 1000MHz)

FREQUENCY (MHz)	Limit (dBuV/m) (at 3M)	
	PEAK	AVERAGE
Above 1000	74	54

Notes:

- (1) The limit for radiated test was performed according to FCC PART 15C.
- (2) The tighter limit applies at the band edges.
- (3) Emission level (dBuV/m)=20log Emission level (uV/m).

Spectrum Parameter	Setting
Attenuation	Auto
Start Frequency	1000 MHz
Stop Frequency	10th carrier harmonic
RB / VB (emission in restricted band)	1 MHz / 1 MHz for Peak, 1 MHz / 10Hz for Average

Receiver Parameter	Setting
Attenuation	Auto
Start ~ Stop Frequency	9kHz~150kHz / RB 200Hz for QP
Start ~ Stop Frequency	150kHz~30MHz / RB 9kHz for QP
Start ~ Stop Frequency	30MHz~1000MHz / RB 120kHz for QP

### 5.2.2 TEST PROCEDURE

- a. The measuring distance of at 3 m shall be used for measurements at frequency up to 1GHz. For frequencies above 1GHz, any suitable measuring distance may be used.

- b. The EUT was placed on the top of a rotating table 0.8 meters above the ground at a 3 meter open area test site. The table was rotated 360 degrees to determine the position of the highest radiation.
- c. The height of the equipment or of the substitution antenna shall be 0.8 m; the height of the test antenna shall vary between 1 m to 4 m. Both horizontal and vertical polarizations of the antenna are set to make the measurement.
- d. The initial step in collecting conducted emission data is a spectrum analyzer peak detector mode pre-scanning the measurement frequency range. Significant peaks are then marked and then Quasi Peak detector mode re-measured.
- e. If the Peak Mode measured value compliance with and lower than Quasi Peak Mode Limit, the EUT shall be deemed to meet QP Limits and then no additional QP Mode measurement performed.
- f. For the actual test configuration, please refer to the related Item –EUT Test Photos.

Note:

***Both horizontal and vertical antenna polarities were tested.  
The worst case emissions were reported***

### **5.2.3 DEVIATION FROM TEST STANDARD**

No deviation

## 5.2.4 TEST SETUP

### (A) Radiated Emission Test-Up Frequency Below 30MHz

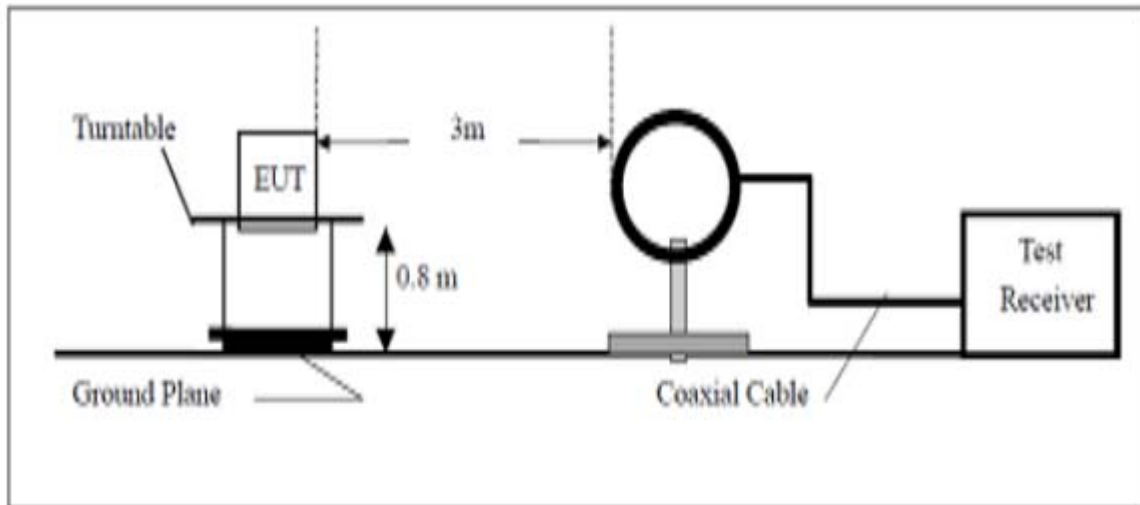

### (B) Radiated Emission Test-Up Frequency 30MHz~1GHz

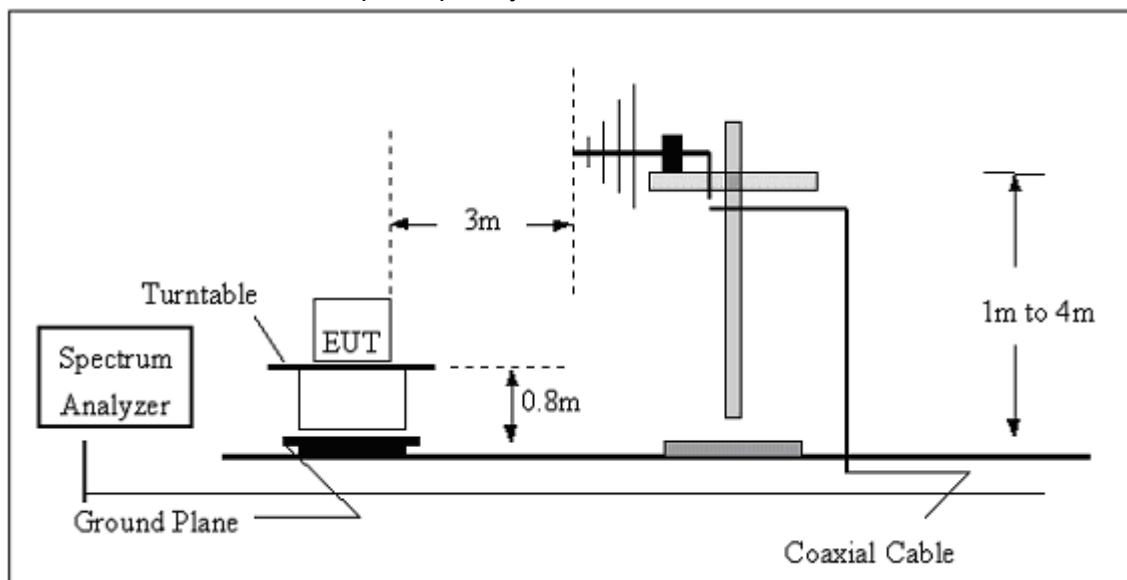

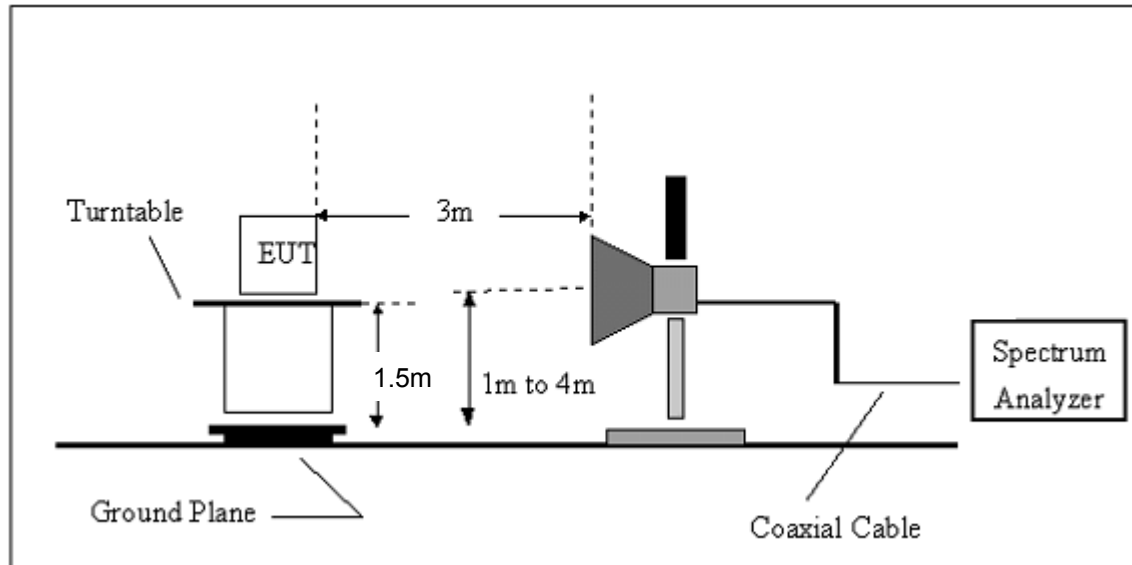
**(C) Radiated Emission Test-Up Frequency Above 1GHz****5.2.5 EUT OPERATING CONDITIONS**

The EUT tested system was configured as the statements of 2.4 Unless otherwise a special operating condition is specified in the follows during the testing.

**5.2.5.1 RESULTS (BELOW 30 MHZ)**

EUT	MULTIMEDIA SPEAKER	Model Name	TSME26 BLK
Temperature	20 °C	Relative Humidity	48%
Pressure	1010 hPa	Polarization	---
Test Mode	Mode 1/ Mode 2/ Mode 3/Mode 4	Test Date	August 12, 2015

Freq.	Reading	Limit	Margin	State
(MHz)	(dBuV/m)	(dBuV/m)	(dB)	P/F
--	--	--	--	P
--	--	--	--	P

**NOTE:**

No result in this part for margin above 20dB.

Distance extrapolation factor =  $20 \log (\text{specific distance}/\text{test distance})$ (dB);

Limit line = specific limits (dBuV) + distance extrapolation factor.

**5.2.5.2 TEST RESULTS (BETWEEN 30M – 1000 MHZ)**

EUT	MULTIMEDIA SPEAKER	Model Name	TSME26 BLK
Temperature	20 °C	Relative Humidity	48%
Pressure	1010 hPa	Polarization :	Horizontal
Test Mode	Mode 1 with 1 Mbps(GFSK)	Test Date	August 12, 2015

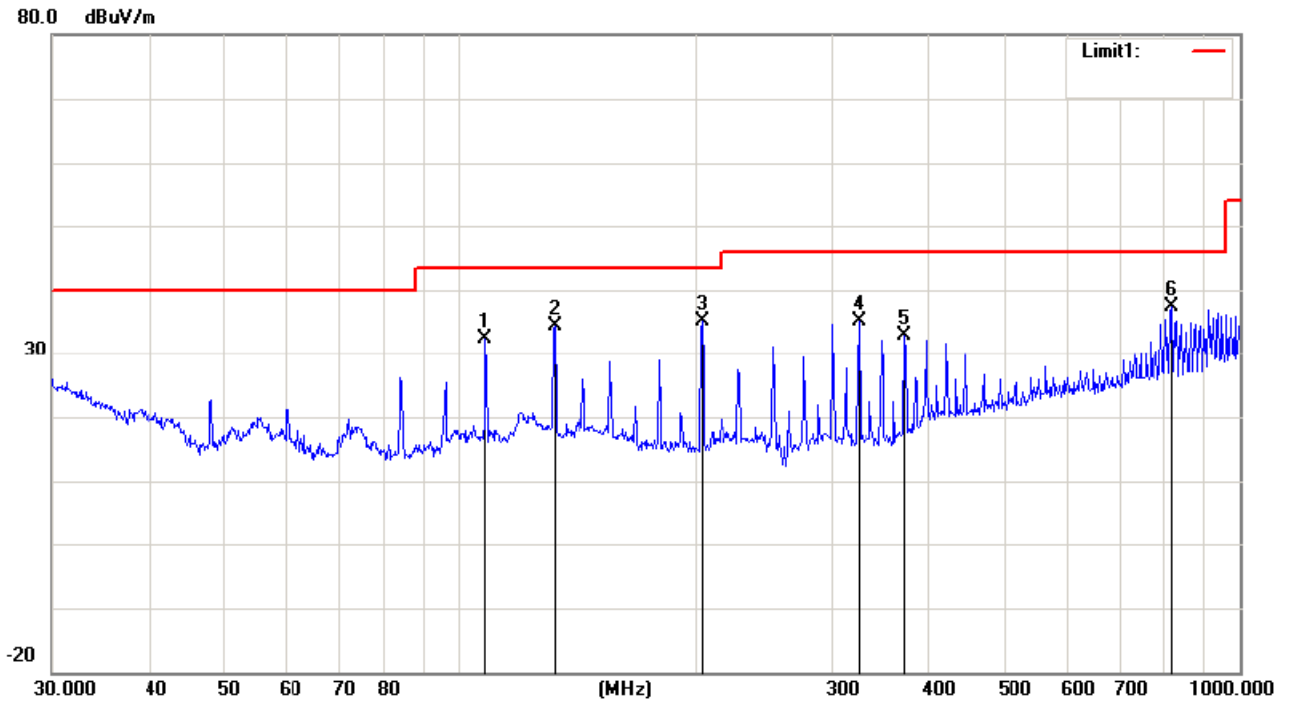

No.	Mk.	Freq. MHz	Reading Level dBuV	Correct Factor dB	Measure- ment dBuV/m	Limit dBuV/m	Over dB	Detector
1		107.8876	36.50	-4.16	32.34	43.50	-11.16	peak
2		132.2205	37.04	-2.56	34.48	43.50	-9.02	peak
3	*	204.2376	40.16	-4.97	35.19	43.50	-8.31	peak
4		324.4560	39.82	-4.62	35.20	46.00	-10.80	peak
5		372.0045	36.51	-3.55	32.96	46.00	-13.04	peak
6		818.8341	32.26	5.03	37.29	46.00	-8.71	peak

Remark: All the modes have been investigated, and only worst mode is presented in this report.

EUT	MULTIMEDIA SPEAKER	Model Name	TSME26 BLK
Temperature	20 °C	Relative Humidity	48%
Pressure	1010 hPa	Polarization :	Vertical
Test Mode	Mode 1 with 1 Mbps(GFSK)	Test Date	August 12, 2015

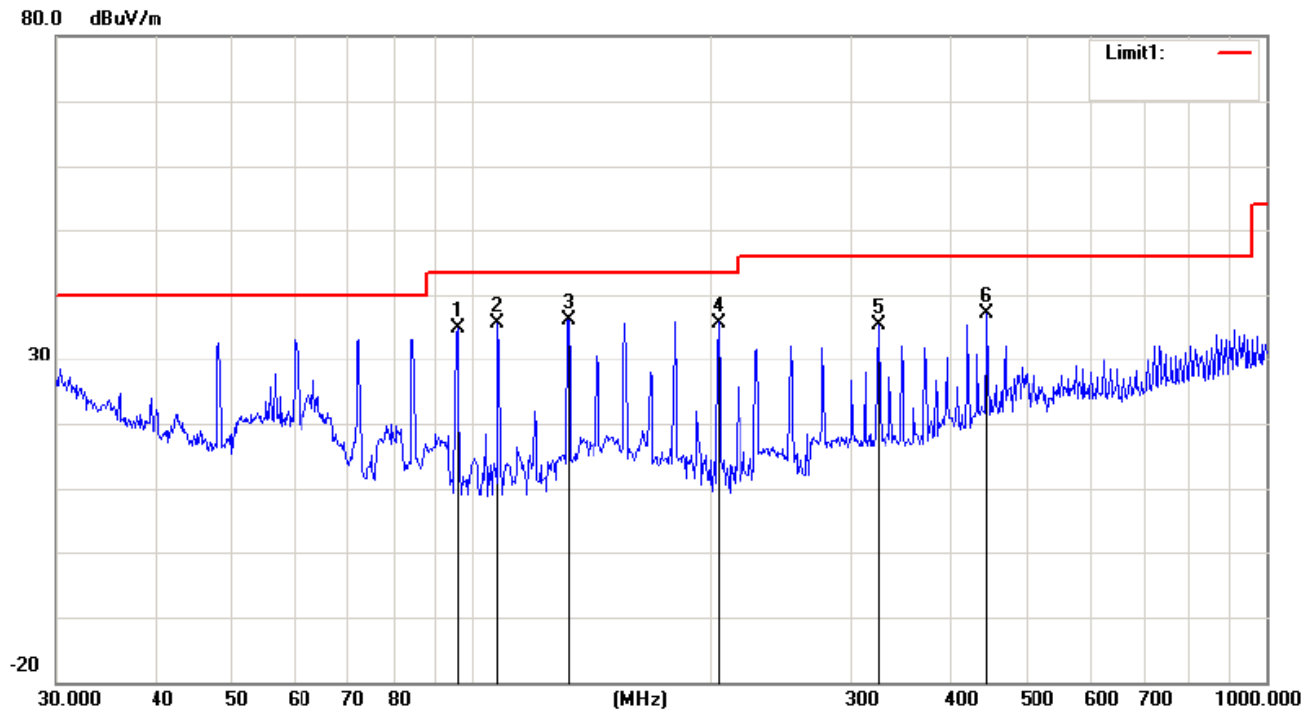

No.	Mk.	Freq. MHz	Reading Level dBuV	Correct Factor dB	Measure- ment dBuV/m	Limit dBuV/m	Over dB	Detector
1		96.0986	41.96	-7.12	34.84	43.50	-8.66	peak
2		107.8876	39.89	-4.16	35.73	43.50	-7.77	peak
3	*	132.2205	38.78	-2.56	36.22	43.50	-7.28	peak
4		204.2376	40.72	-4.97	35.75	43.50	-7.75	peak
5		324.4560	39.94	-4.62	35.32	46.00	-10.68	peak
6		444.8514	39.42	-2.18	37.24	46.00	-8.76	peak

Remark: All the modes have been investigated, and only worst mode is presented in this report.

### 5.2.5.3 TEST RESULTS(1GHZ TO 25GHZ)

Note: *the worst case is 1Mbps(GFSK)mode as result in this part.*

EUT	MULTIMEDIA SPEAKER	Model Name	TSME26 BLK
Temperature	20 °C	Relative Humidity	48%
Pressure	1010 hPa	Test Mode	Mode 1 TX(1Mbps)
Test Date	August 12, 2015		

Freq. (MHz)	Ant. Pol.	Emission Level(dBuV)		Limit 3m(dBuV/m)		Over(dB)	
		PK	AV	PK	AV	PK	AV
4804	V	60.62	41.10	74	54	-13.38	-12.90
7206	V	59.10	40.84	74	54	-14.90	-13.16
4804	H	59.09	39.40	74	54	-14.91	-14.60
7206	H	59.61	40.61	74	54	-14.39	-13.39

**Remark:**

All emissions not reported were more than 20dB below the specified limit or in the noise floor.  
Only worst case is presented in this report.



EUT	MULTIMEDIA SPEAKER	Model Name	TSME26 BLK
Temperature	20 °C	Relative Humidity	48%
Pressure	1010 hPa	Test Mode	Mode 2 TX(1Mbps)
Test Date	August 12, 2015		

Freq. (MHz)	Ant.Pol.	Emission Level(dBuV)		Limit 3m(dBuV/m)		Over(dB)	
		PK	AV	PK	AV	PK	AV
4882	V	59.32	39.27	74	54	-14.68	-14.73
7323	V	59.79	39.14	74	54	-14.21	-14.86
4882	H	58.83	40.58	74	54	-15.17	-13.42
7323	H	59.00	40.00	74	54	-15.00	-14.00

## Remark:

All emissions not reported were more than 20dB below the specified limit or in the noise floor.  
Only worst case is presented in this report.

EUT	MULTIMEDIA SPEAKER	Model Name	TSME26 BLK
Temperature	20 °C	Relative Humidity	48%
Pressure	1010 hPa	Test Mode	Mode 3 TX(1Mbps)
Test Date	August 12, 2015		

Freq. (MHz)	Ant.Pol.	Emission Level(dBuV)		Limit 3m(dBuV/m)		Over(dB)	
		PK	AV	PK	AV	PK	AV
4960	V	60.65	39.84	74	54	-13.35	-14.16
7440	V	58.81	40.90	74	54	-15.19	-13.10
4960	H	59.41	40.14	74	54	-14.59	-13.86
7440	H	58.35	39.35	74	54	-15.65	-14.65

## Remark:

All emissions not reported were more than 20dB below the specified limit or in the noise floor.  
Only worst case is presented in this report.

#### 5.2.5.4 TEST RESULTS (Restricted Bands Requirements)

##### Test result for 1Mbps Mode:

EUT	MULTIMEDIA SPEAKER	Model Name	TSME26 BLK
Temperature	20 °C	Relative Humidity	48%
Pressure	1010 hPa	Test Date	August 12, 2015
Test Mode	TX /2402MHz -1Mbps	Polarization	Vertical

Frequency	Meter Reading	Factor	Emission Level	Limits	Margin	Detector Type
(MHz)	(dB $\mu$ V)	(dB)	(dB $\mu$ V/m)	(dB $\mu$ V/m)	(dB)	
2382	61.36	-8.76	52.60	74	21.40	peak
2382	53.08	-8.76	44.32	54	9.68	AVG
2390	63.09	-8.73	54.36	74	19.64	peak
2390	56.71	-8.73	47.98	54	6.02	AVG

Remark:

Factor = Antenna Factor + Cable Loss – Pre-amplifier.  
Only worst case is presented in this report.

EUT	MULTIMEDIA SPEAKER	Model Name	TSME26 BLK
Temperature	20 °C	Relative Humidity	48%
Pressure	1010 hPa	Test Date	August 12, 2015
Test Mode	TX /2402MHz-1Mbps	Polarization	Horizontal

Frequency	Meter Reading	Factor	Emission Level	Limits	Margin	Detector Type
(MHz)	(dB $\mu$ V)	(dB)	(dB $\mu$ V/m)	(dB $\mu$ V/m)	(dB)	
2376	60.07	-8.78	51.29	74	22.71	peak
2376	53.07	-8.78	44.29	54	9.71	AVG
2390	63.22	-8.73	54.49	74	19.51	peak
2390	57.02	-8.73	48.29	54	5.71	AVG

Remark:

Factor = Antenna Factor + Cable Loss – Pre-amplifier.  
Only worst case is presented in this report.

EUT	MULTIMEDIA SPEAKER	Model Name	TSME26 BLK
Temperature	20 °C	Relative Humidity	48%
Pressure	1010 hPa	Test Date	August 12, 2015
Test Mode	TX /2480MHz-1Mbps	Polarization	Vertical

Frequency	Meter Reading	Factor	Emission Level	Limits	Margin	Detector Type
(MHz)	(dBμV)	(dB)	(dBμV/m)	(dBμV/m)	(dB)	
2483.5	63.61	-8.17	55.44	74	18.56	peak
2483.5	53.68	-8.17	45.51	54	8.49	AVG

Remark:  
Factor = Antenna Factor + Cable Loss – Pre-amplifier.  
Only worst case is presented in this report.

EUT	MULTIMEDIA SPEAKER	Model Name	TSME26 BLK
Temperature	20 °C	Relative Humidity	48%
Pressure	1010 hPa	Test Date	August 12, 2015
Test Mode	TX /2480MHz-1Mbps	Polarization	Horizontal

Frequency	Meter Reading	Factor	Emission Level	Limits	Margin	Detector Type
(MHz)	(dBμV)	(dB)	(dBμV/m)	(dBμV/m)	(dB)	
2483.5	63.62	-8.17	55.45	74	18.55	peak
2483.5	54.21	-8.17	46.04	54	7.96	AVG

Remark:  
Factor = Antenna Factor + Cable Loss – Pre-amplifier.  
Only worst case is presented in this report.

**Test result for 3Mbps Mode:**

EUT	MULTIMEDIA SPEAKER	Model Name	TSME26 BLK
Temperature	20 °C	Relative Humidity	48%
Pressure	1010 hPa	Test Date	August 12, 2015
Test Mode	TX /2402MHz-3Mbps	Polarization	Vertical

Frequency	Meter Reading	Factor	Emission Level	Limits	Margin	Detector Type
(MHz)	(dB $\mu$ V)	(dB)	(dB $\mu$ V/m)	(dB $\mu$ V/m)	(dB)	
2387	62.24	-8.74	53.50	74	20.50	peak
2387	56.56	-8.74	47.82	54	6.18	AVG
2390	59.90	-8.73	51.17	74	22.83	peak
2390	55.49	-8.73	46.76	54	7.24	AVG

Remark:

Factor = Antenna Factor + Cable Loss – Pre-amplifier.

Only worst case is presented in this report.

EUT	MULTIMEDIA SPEAKER	Model Name	TSME26 BLK
Temperature	20 °C	Relative Humidity	48%
Pressure	1010 hPa	Test Date	August 12, 2015
Test Mode	TX /2402MHz-3Mbps	Polarization	Horizontal

Frequency	Meter Reading	Factor	Emission Level	Limits	Margin	Detector Type
(MHz)	(dB $\mu$ V)	(dB)	(dB $\mu$ V/m)	(dB $\mu$ V/m)	(dB)	
2384	64.23	-8.75	55.48	74	18.52	peak
2384	53.43	-8.75	44.68	54	9.32	AVG
2390	62.01	-8.73	53.28	74	20.72	peak
2390	57.51	-8.73	48.78	54	5.22	AVG

Remark:

Factor = Antenna Factor + Cable Loss – Pre-amplifier.

Only worst case is presented in this report.

EUT	MULTIMEDIA SPEAKER	Model Name	TSME26 BLK
Temperature	20 °C	Relative Humidity	48%
Pressure	1010 hPa	Test Date	August 12, 2015
Test Mode	TX /2480MHz-3Mbps	Polarization	Vertical

Frequency	Meter Reading	Factor	Emission Level	Limits	Margin	Detector Type
(MHz)	(dB $\mu$ V)	(dB)	(dB $\mu$ V/m)	(dB $\mu$ V/m)	(dB)	
2483.5	61.48	-8.17	53.31	74	20.69	peak
2483.5	53.92	-8.17	45.75	54	8.25	AVG

Remark:

Factor = Antenna Factor + Cable Loss – Pre-amplifier.

Only worst case is presented in this report.

EUT	MULTIMEDIA SPEAKER	Model Name	TSME26 BLK
Temperature	20 °C	Relative Humidity	48%
Pressure	1010 hPa	Test Date	August 12, 2015
Test Mode	TX /2480MHz-3Mbps	Polarization	Horizontal

Frequency	Meter Reading	Factor	Emission Level	Limits	Margin	Detector Type
(MHz)	(dB $\mu$ V)	(dB)	(dB $\mu$ V/m)	(dB $\mu$ V/m)	(dB)	
2483.5	64.33	-8.17	56.16	74	17.84	peak
2483.5	54.13	-8.17	45.96	54	8.04	AVG

Remark:

Factor = Antenna Factor + Cable Loss – Pre-amplifier.

Only worst case is presented in this report.

**Test result for hopping mode:**

EUT	MULTIMEDIA SPEAKER	Model Name	TSME26 BLK
Temperature	20 °C	Relative Humidity	48%
Pressure	1010 hPa	Test Date	August 12, 2015
Test Mode	Hopping mode	Polarization	Vertical

Frequency (MHz)	Meter Reading (dB $\mu$ V)	Factor (dB)	Emission Level (dB $\mu$ V/m)	Limits (dB $\mu$ V/m)	Margin (dB)	Detector Type
2381	62.53	-8.76	53.77	74	20.23	peak
2381	56.43	-8.76	47.67	54	6.33	AVG
2390	61.65	-8.73	52.92	74	21.08	peak
2390	54.89	-8.73	46.16	54	7.84	AVG

Remark:  
Factor = Antenna Factor + Cable Loss – Pre-amplifier.  
Only worst case is presented in this report.

EUT	MULTIMEDIA SPEAKER	Model Name	TSME26 BLK
Temperature	20 °C	Relative Humidity	48%
Pressure	1010 hPa	Test Date	August 12, 2015
Test Mode	Hopping mode	Polarization :	Horizontal

Frequency (MHz)	Meter Reading (dB $\mu$ V)	Factor (dB)	Emission Level (dB $\mu$ V/m)	Limits (dB $\mu$ V/m)	Margin (dB)	Detector Type
2378	64.19	-8.77	55.42	74	18.58	peak
2378	53.27	-8.77	44.50	54	9.50	AVG
2390	63.52	-8.73	54.79	74	19.21	peak
2390	54.34	-8.73	45.61	54	8.39	AVG

Remark:  
Factor = Antenna Factor + Cable Loss – Pre-amplifier.  
Only worst case is presented in this report.

EUT	MULTIMEDIA SPEAKER	Model Name	TSME26 BLK
Temperature	20 °C	Relative Humidity	48%
Pressure	1010 hPa	Test Date	August 12, 2015
Test Mode	Hopping mode	Polarization	Vertical

Frequency	Meter Reading	Factor	Emission Level	Limits	Margin	Detector Type
(MHz)	(dBμV)	(dB)	(dBμV/m)	(dBμV/m)	(dB)	
2483.5	60.82	-8.17	52.65	74	21.35	peak
2483.5	53.72	-8.17	45.55	54	8.45	AVG

Remark:  
Factor = Antenna Factor + Cable Loss – Pre-amplifier.  
Only worst case is presented in this report.

EUT	MULTIMEDIA SPEAKER	Model Name	TSME26 BLK
Temperature	20 °C	Relative Humidity	48%
Pressure	1010 hPa	Test Date	August 12, 2015
Test Mode	Hopping mode	Polarization	Horizontal

Frequency	Meter Reading	Factor	Emission Level	Limits	Margin	Detector Type
(MHz)	(dBμV)	(dB)	(dBμV/m)	(dBμV/m)	(dB)	
2483.5	64.01	-8.17	55.84	74	18.16	peak
2483.5	54.65	-8.17	46.48	54	7.52	AVG

Remark:  
Factor = Antenna Factor + Cable Loss – Pre-amplifier.  
Only worst case is presented in this report.

### 5.3 CONDUCTED SPURIOUS EMISSION MEASUREMENT

#### 5.3.1 CONDUCTED SPURIOUS EMISSION LIMITS

FCC §15.247 (d)

Limit = -20 dBc

#### 5.3.2 TEST PROCEDURE

According to the dictates of DA-000705

- a. The transmitter output is connected to a spectrum analyzer. The resolution bandwidth is set to 100 kHz. The video bandwidth is set to 300 kHz.
- b. The spectrum from 30 MHz to 25 GHz is investigated with the transmitter set to the lowest, middle, and highest channels.
- c. The band edges at 2.4 and 2.4835 GHz are investigated with the transmitter set to the normal hopping mode.

**Note:** The correction factor has been added to the spectrum analyzer.

#### 5.3.3 DEVIATION FROM STANDARD

No deviation.

#### 5.3.4 TEST SETUP

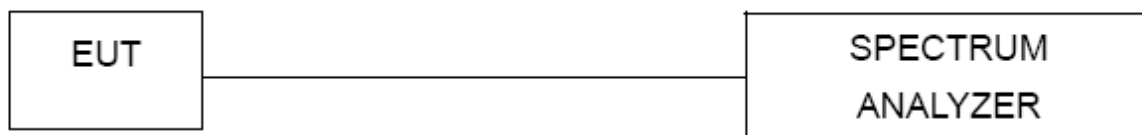

#### 5.3.5 EUT OPERATION CONDITIONS

The EUT tested system was configured as the statements of 2.4 Unless otherwise a special operating condition is specified in the follows during the testing.



### 5.3.6 TEST RESULTS

Operating Mode: GFSK (1 Mbps)

Low Channel

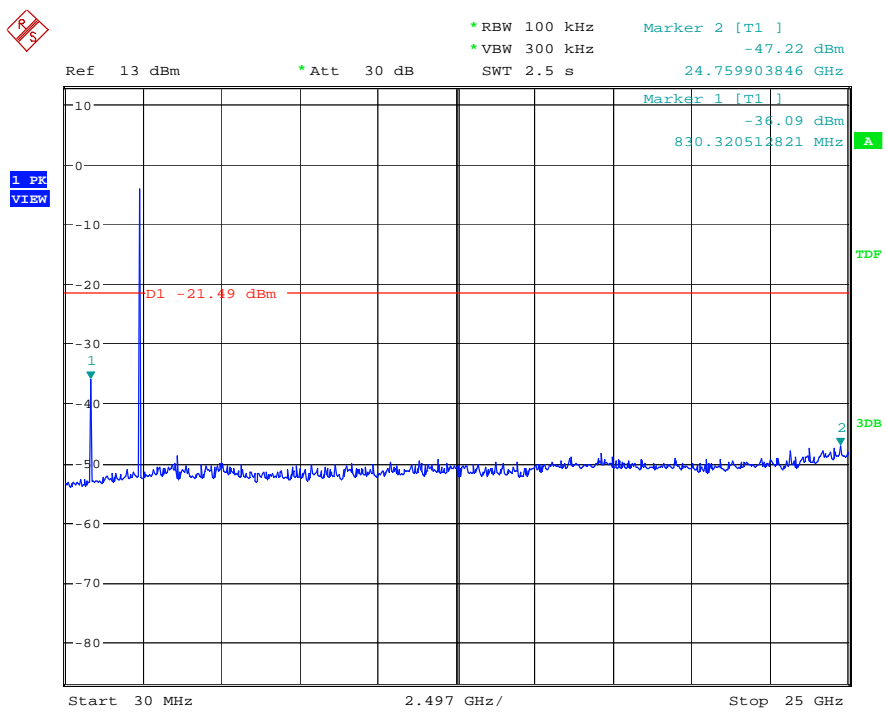
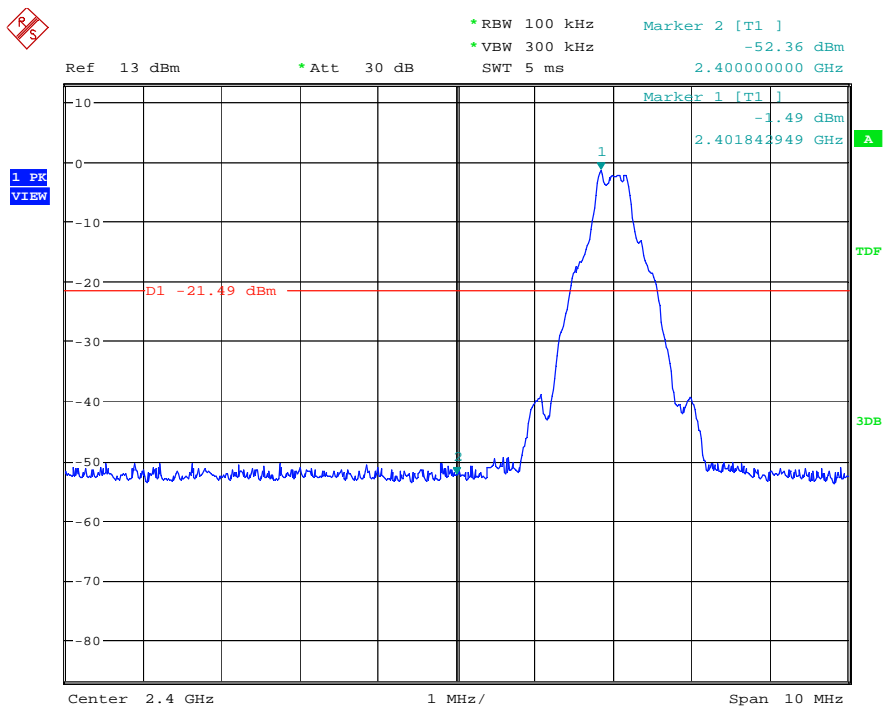

### Middle Channel

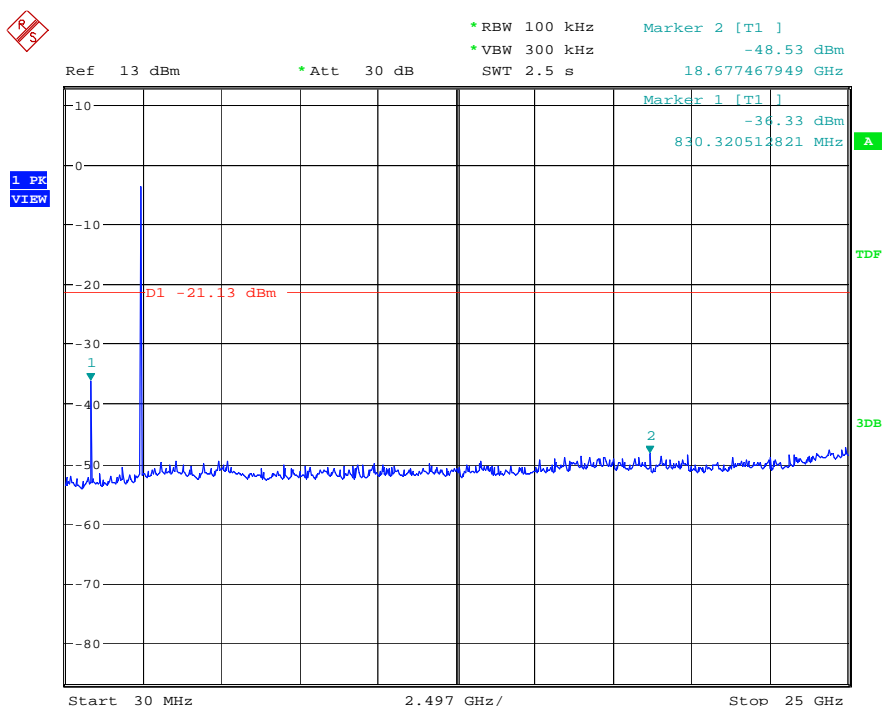
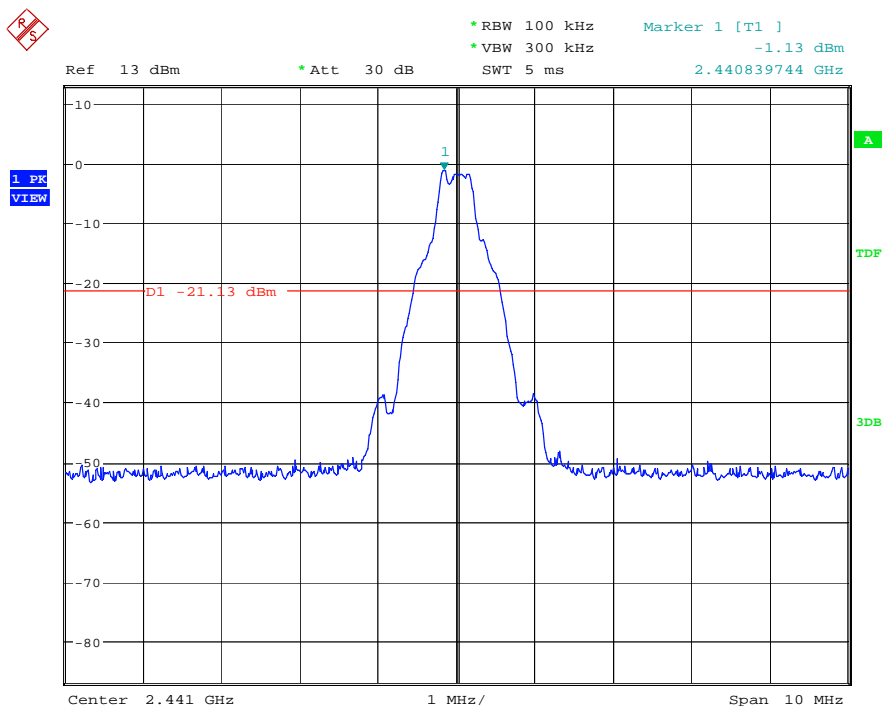

### High Channel

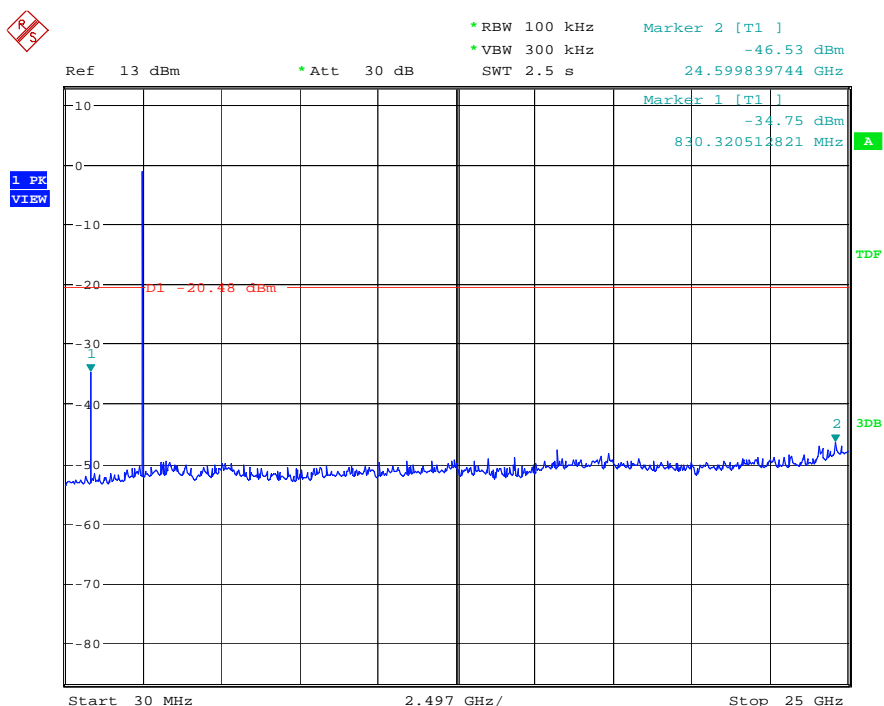
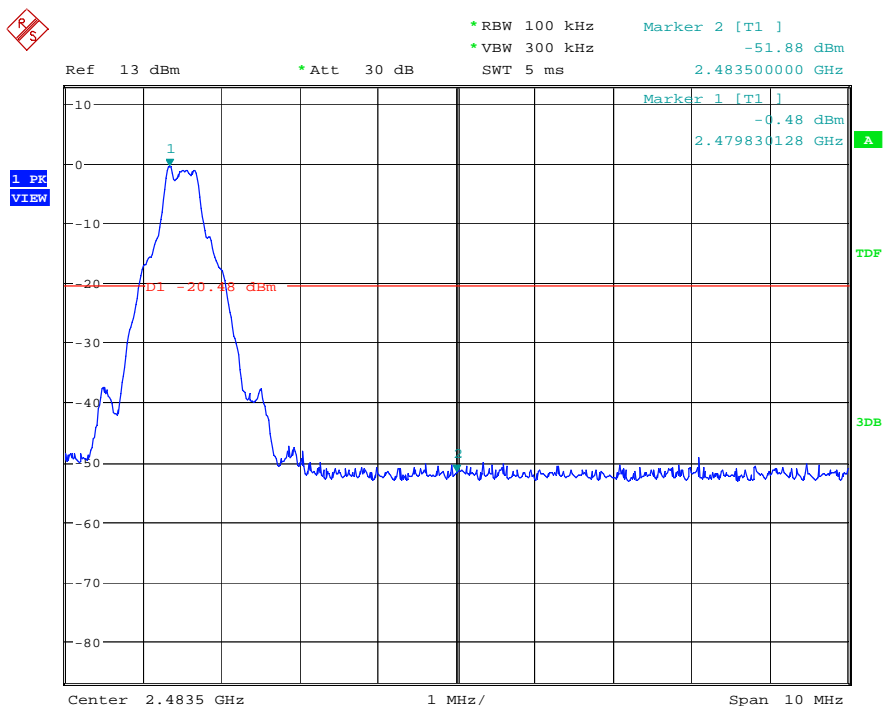

### Bandedge at Hopping

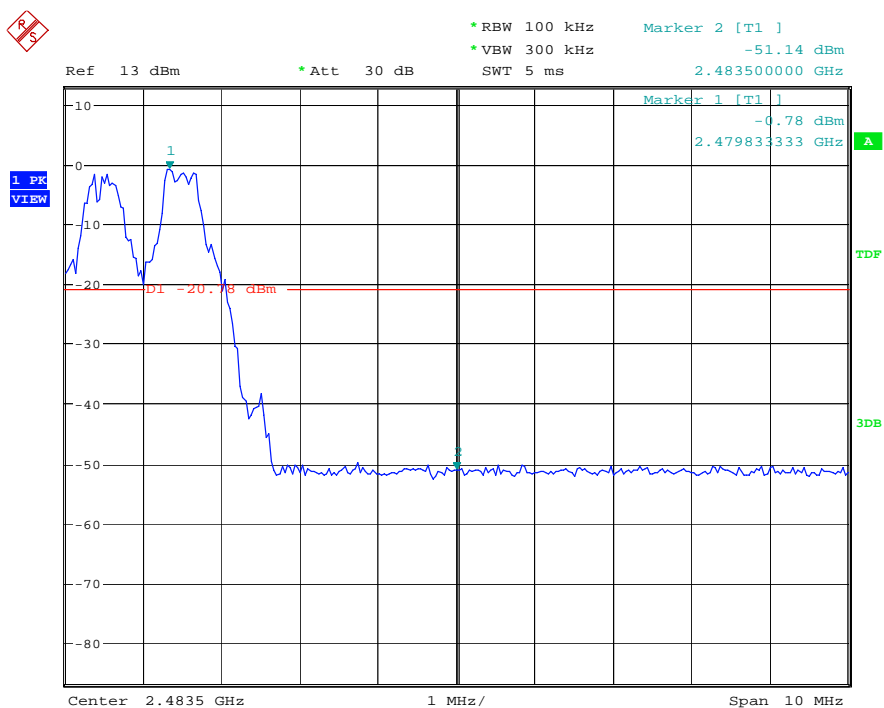
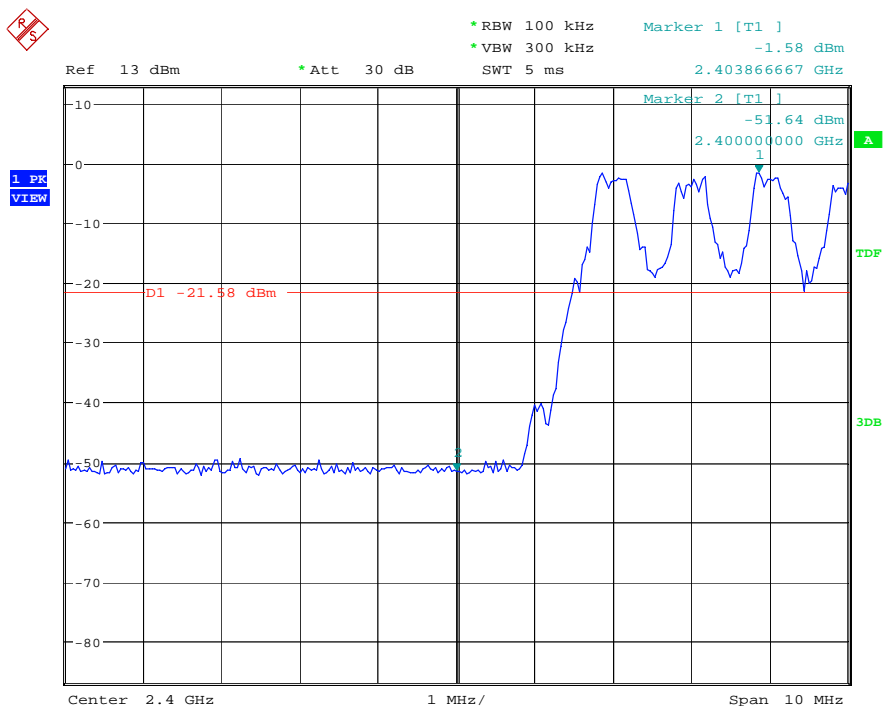

Operating Mode: 8DPSK(3 Mbps)

Low Channel

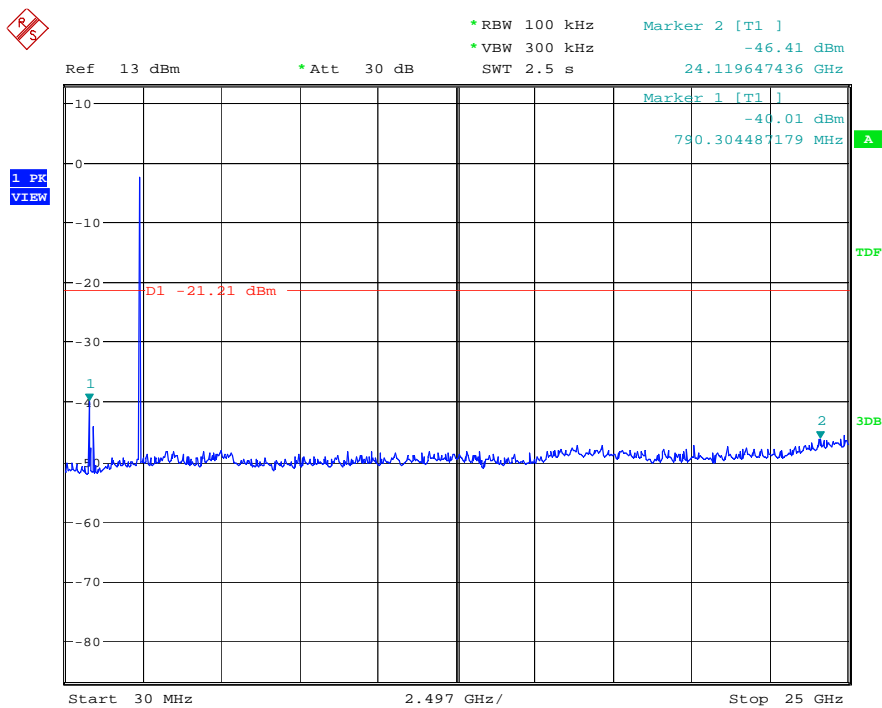
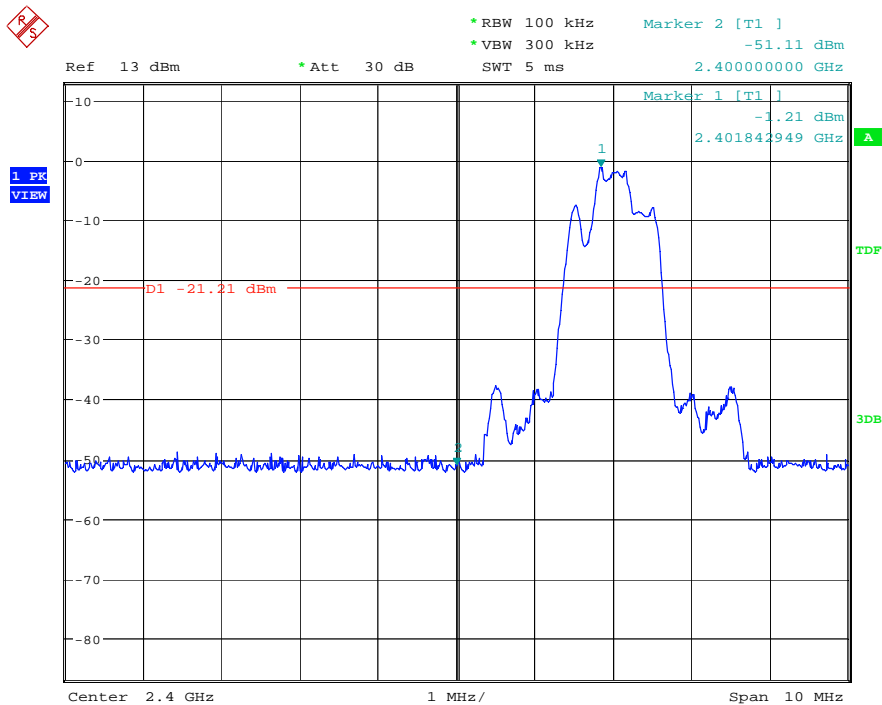

### Middle Channel

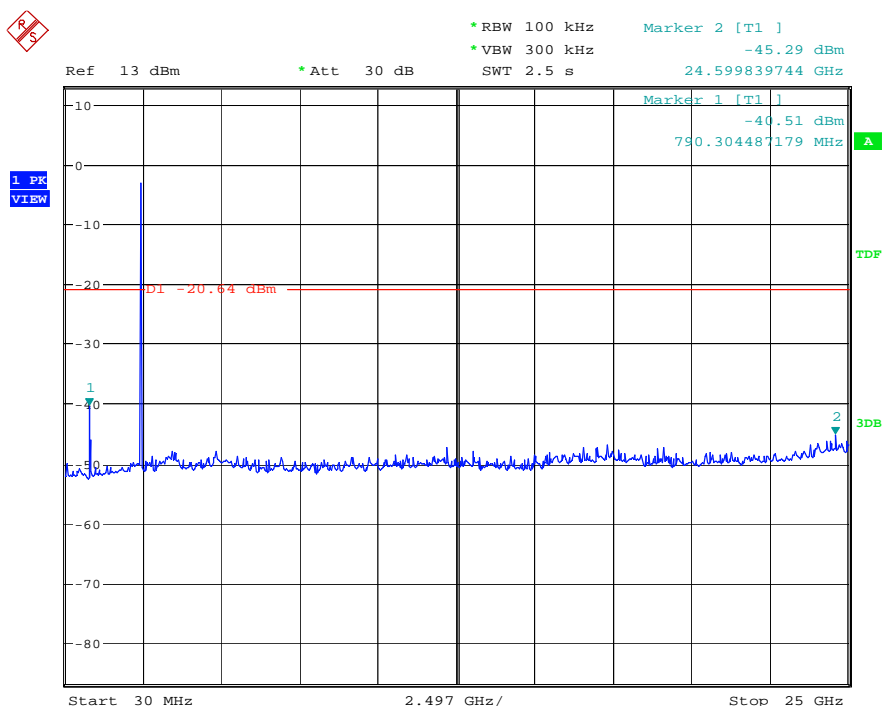
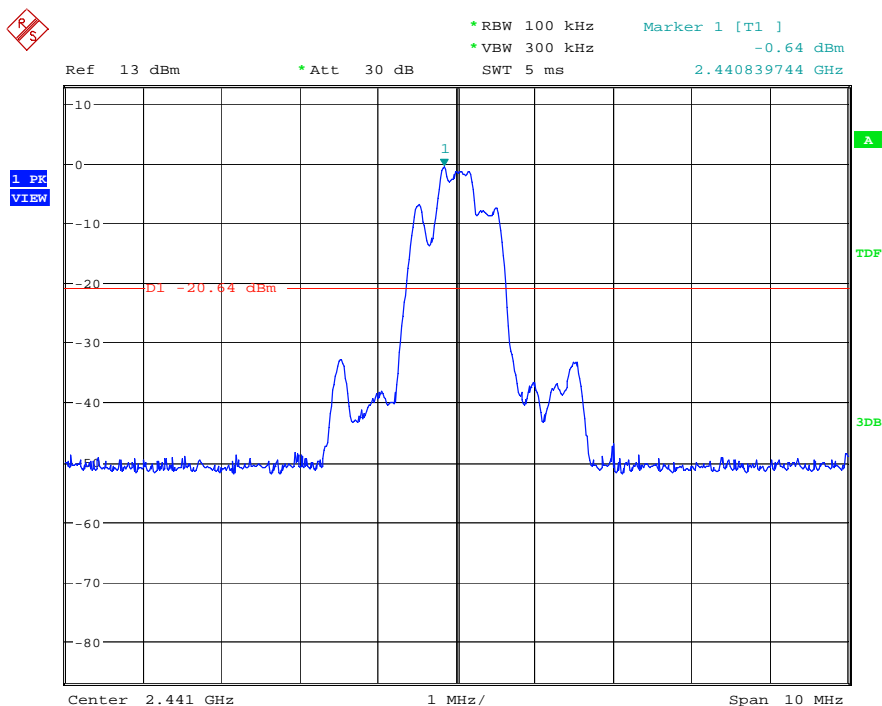

### High Channel

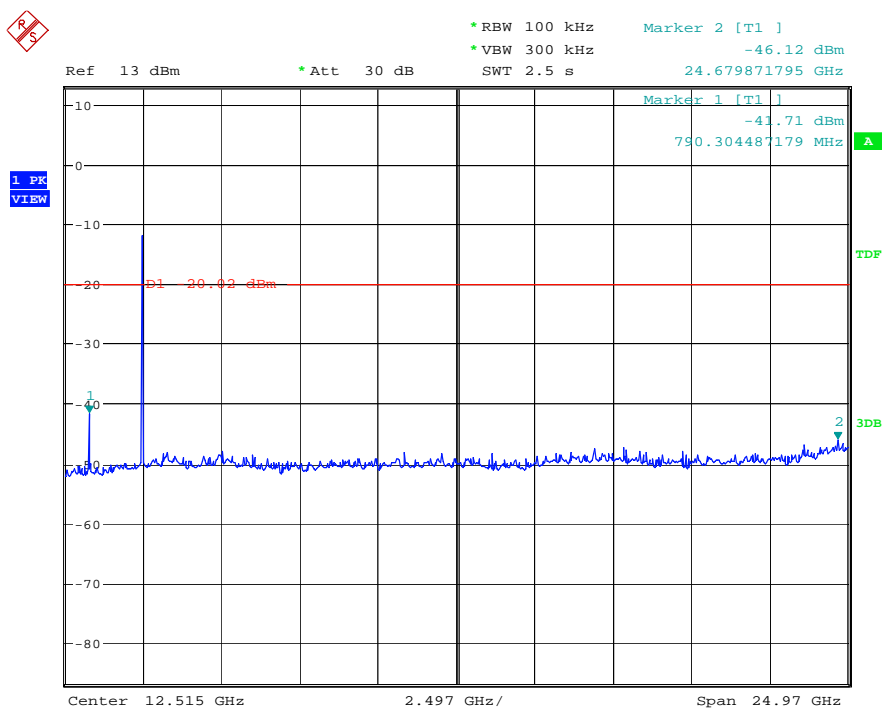
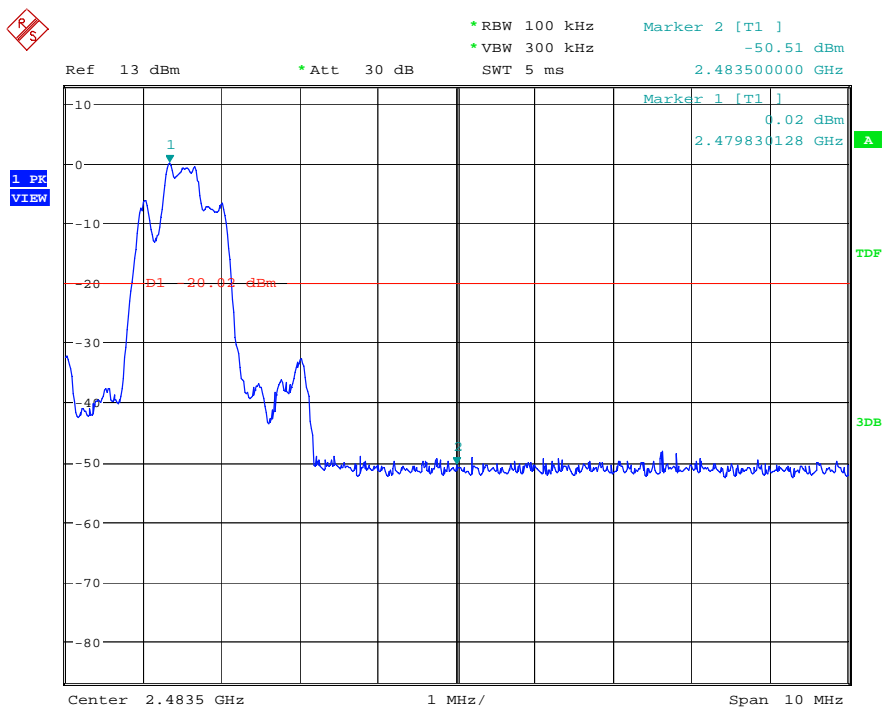

### Bandedge at Hopping

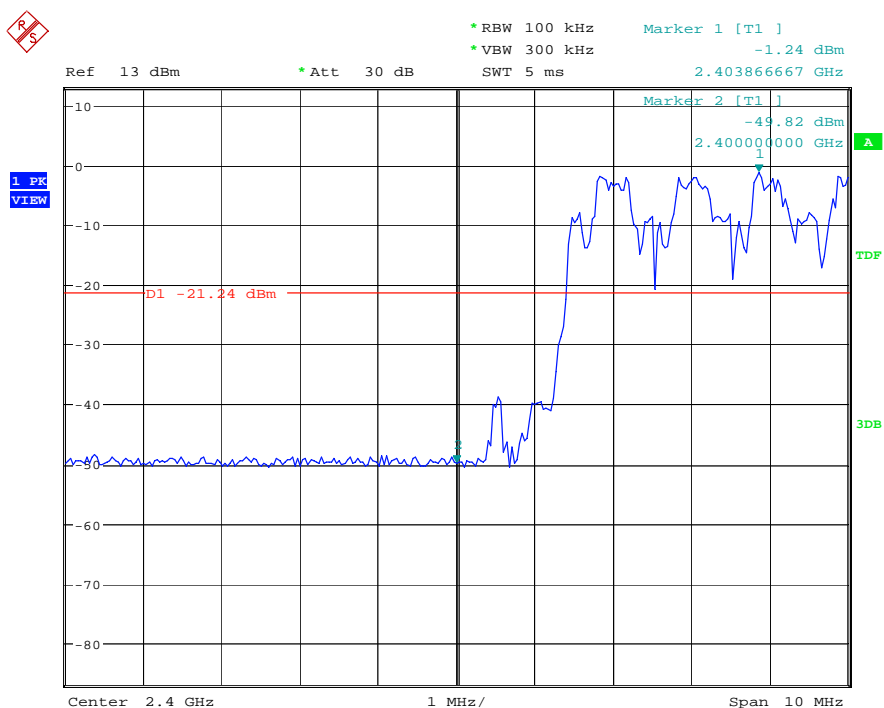



**6. NUMBER OF HOPPING CHANNEL****6.1 APPLIED PROCEDURES / LIMIT**

FCC Part15 (15.247) , Subpart C				
Section	Test Item	Limit	Frequency Range (MHz)	Result
15.247 (a)(1)(iii)	Number of Hopping Channel	≥15	2400-2483.5	PASS

Spectrum Parameters	Setting
Attenuation	Auto
Span Frequency	> Operating Frequency Range
RB	1MHz
VB	3MHz
Detector	Peak
Trace	Max Hold
Sweep Time	Auto

**6.2 TEST PROCEDURE**

- a. Remove the antenna from the EUT and then connect a low loss RF cable from the antenna port to the spectrum analyzer.
- b. Spectrum Setting: RBW= 1MHz, VBW=3MHz, Sweep time = Auto.

**6.3 DEVIATION FROM STANDARD**

No deviation.

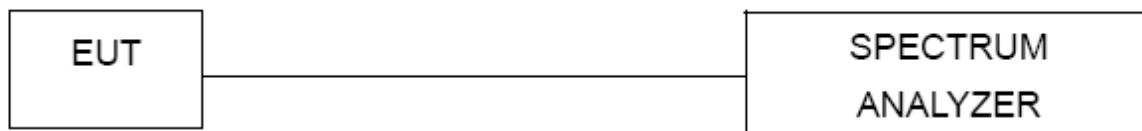
**6.4 TEST SETUP****6.5 EUT OPERATION CONDITIONS**

The EUT tested system was configured as the statements of 2.4 Unless otherwise a special operating condition is specified in the follows during the testing.

### 6.6 TEST RESULTS

EUT	MULTIMEDIA SPEAKER	Model Name	TSME26 BLK
Temperature	25 °C	Relative Humidity	60%
Pressure	1015 hPa	Test Date	August 12, 2015
Test Mode	Hopping Mode	Number of Hopping Channel	79

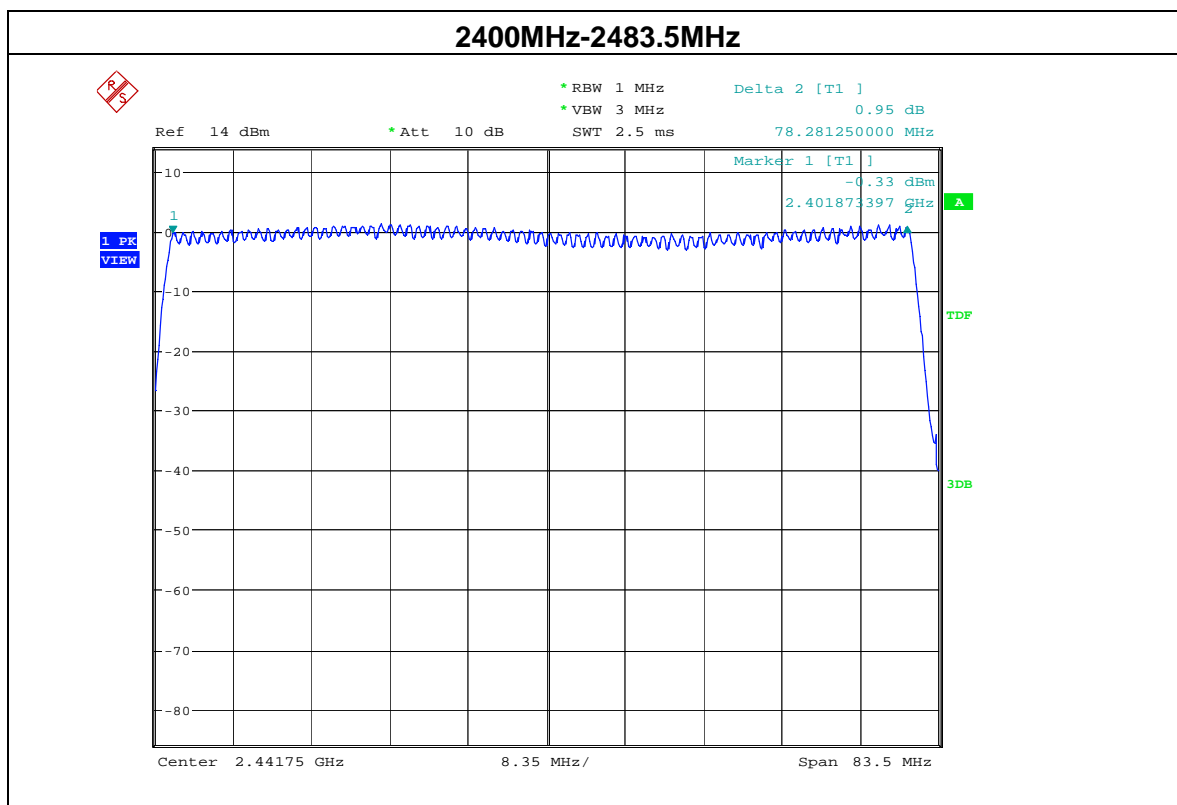

**7. AVERAGE TIME OF OCCUPANCY****7.1 APPLIED PROCEDURES / LIMIT**

FCC Part15 (15.247) , Subpart C				
Section	Test Item	Limit	Frequency Range (MHz)	Result
15.247 (a)(1)(iii)	Average Time of Occupancy	0.4sec	2400-2483.5	PASS

**7.2 TEST PROCEDURE**

- a. Remove the antenna from the EUT and then connect a low loss RF cable from the antenna port to the spectrum analyzer.
- b. Set RBW of spectrum analyzer to 1MHz and VBW to 3MHz.
- c. Use a video trigger with the trigger level set to enable triggering only on full pulses.
- d. Sweep Time is more than once pulse time.
- e. Set the center frequency on any frequency would be measure and set the frequency span to zero span.
- f. Measure the maximum time duration of one single pulse.
- g. Set the EUT for DH5, DH3 and DH1 packet transmitting.
- h. Measure the maximum time duration of one single pulse.
- i. DH1 Dwell time = Pulse time\*(1600/2/79)\*31.6S  
DH3 Dwell time = Pulse time\*(1600/4/79)\*31.6S  
DH5 Dwell time = Pulse time\*(1600/6/79)\*31.6S

**7.3 DEVIATION FROM STANDARD**

No deviation.

#### 7.4 TEST SETUP

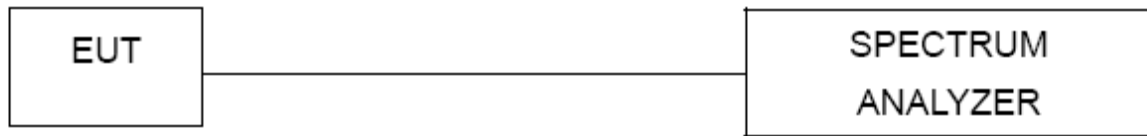

#### 7.5 EUT OPERATION CONDITIONS

The EUT tested system was configured as the statements of 2.4 Unless otherwise a special operating condition is specified in the follows during the testing.

### 7.6 TEST RESULTS

Note: *the worst case is DH5-3Mbps as result in this part.*

EUT	MULTIMEDIA SPEAKER	Model Name	TSME26 BLK
Temperature	25 °C	Relative Humidity	60%
Pressure	1012 hPa	Test Date	August 12, 2015
Test Mode	DH5-3Mbps		

Data Packet	Frequency	Pulse time(ms)	Dwell Time(S)	Limits (S)
DH5	2402MHz	2.9968	0.320	0.4
DH5	2441MHz	3.0128	0.321	0.4
DH5	2480MHz	3.0128	0.321	0.4

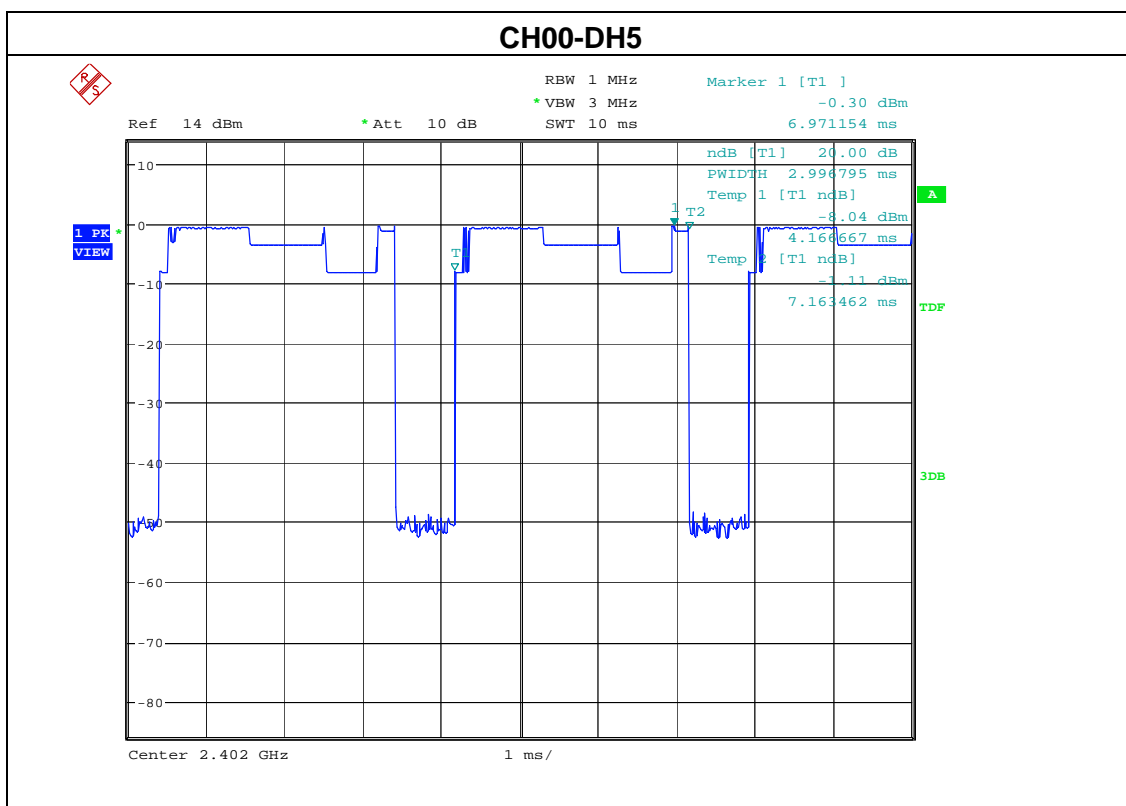

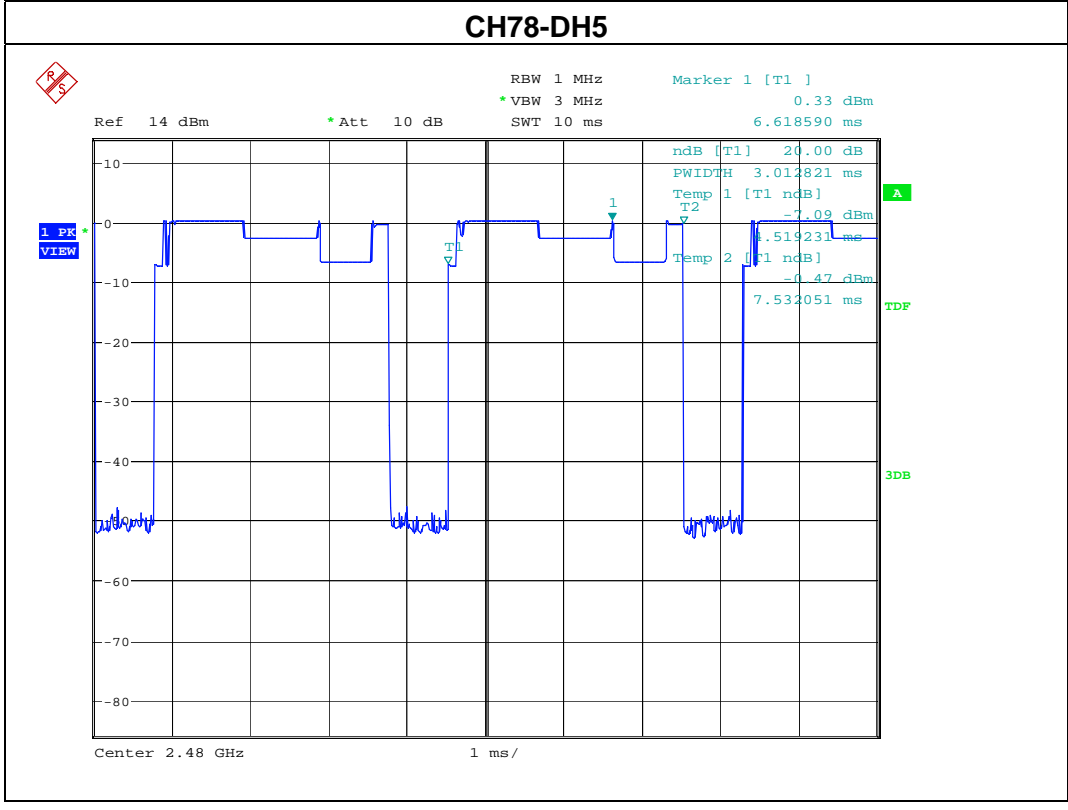
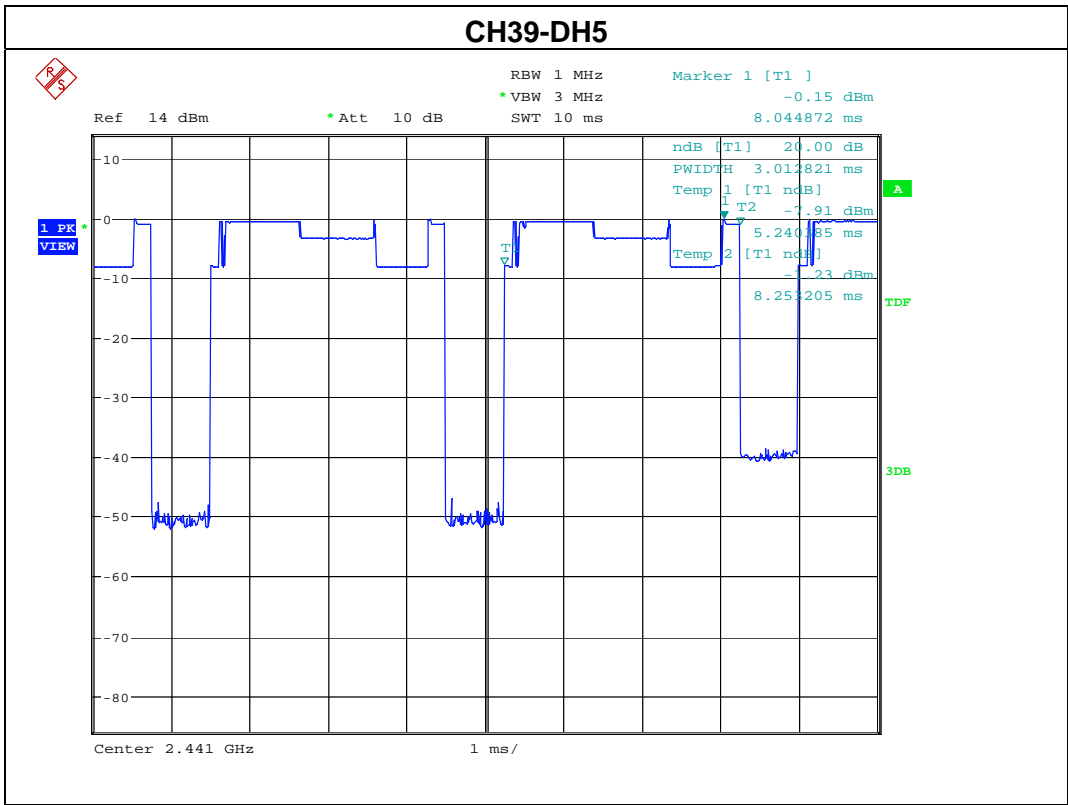

## 8. HOPPING CHANNEL SEPARATION MEASUREMENT

### 8.1 APPLIED PROCEDURES / LIMIT

Frequency hopping systems operating in the 2400-2483.5 MHz band may have hopping channel carrier frequencies that are separated by 25 kHz or two-thirds of the 20 dB bandwidth of the hopping channel, whichever is greater.

Spectrum Parameter	Setting
Attenuation	Auto
Span Frequency	> Measurement Bandwidth or Channel Separation
RB	Resolution (or IF) Bandwidth (RBW) $\geq$ 1% of the span
VB	Video (or Average) Bandwidth (VBW) $\geq$ RBW
Detector	Peak
Trace	Max hold
Sweep Time	Auto

### 8.2 TEST PROCEDURE

1. Check the calibration of the measuring instrument using either an internal calibrator or a known signal from an external generator.
3. Remove the antenna from the EUT and then connect a low loss RF cable from the antenna port to the spectrum analyzer.
4. Set the spectrum analyzer as follows: Span = wide enough to capture the peaks of two adjacent channels: Resolution (or IF) Bandwidth (RBW)  $\geq$  1% of the span; Video (or Average) Bandwidth (VBW)  $\geq$  RBW; Sweep = auto; Detector function = peak; Trace = max hold
5. Measure the separation between the peaks of the adjacent channels using the marker-delta function.
6. Repeat above procedures until all frequencies measured were complete.

### 8.3 DEVIATION FROM STANDARD

No deviation.

### 8.4 TEST SETUP

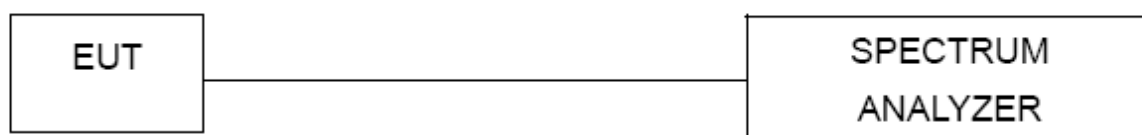

### 8.5 EUT OPERATION CONDITIONS

The EUT was programmed to be in continuously transmitting mode.

### 8.6 TEST RESULTS

EUT	MULTIMEDIA SPEAKER	Model Name	TSME26 BLK
Temperature	25 °C	Relative Humidity	60%
Pressure	1012 hPa	Test Result	Pass
Test Mode	CH00 / CH39 /CH78 (1Mbps Mode)	Test Date	August 12, 2015

Channel number	Channel frequency (MHz)	Separation Read value (KHz)	Separation limit 2/3 20db down BW(KHz)
00	2402	1000	>689.33
39	2441	1000	>696.00
78	2480	1000	>692.00

Note: 20db bandwidth refer to section 6.1.5

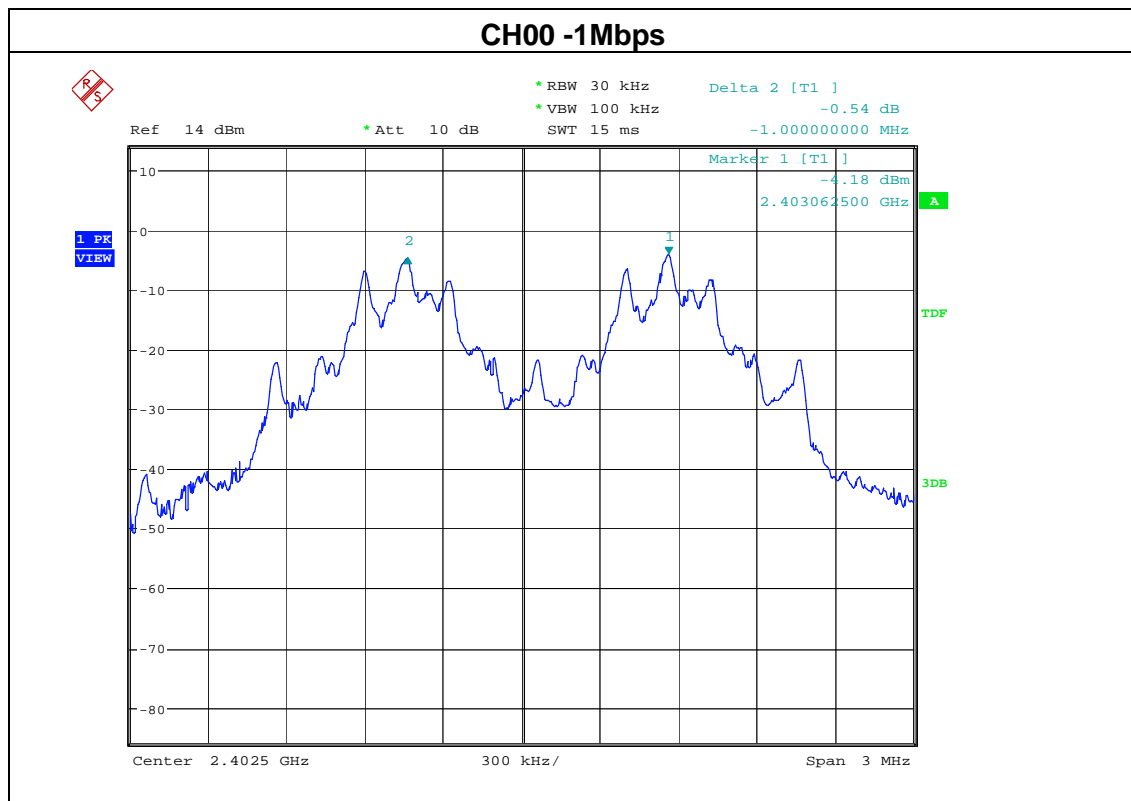



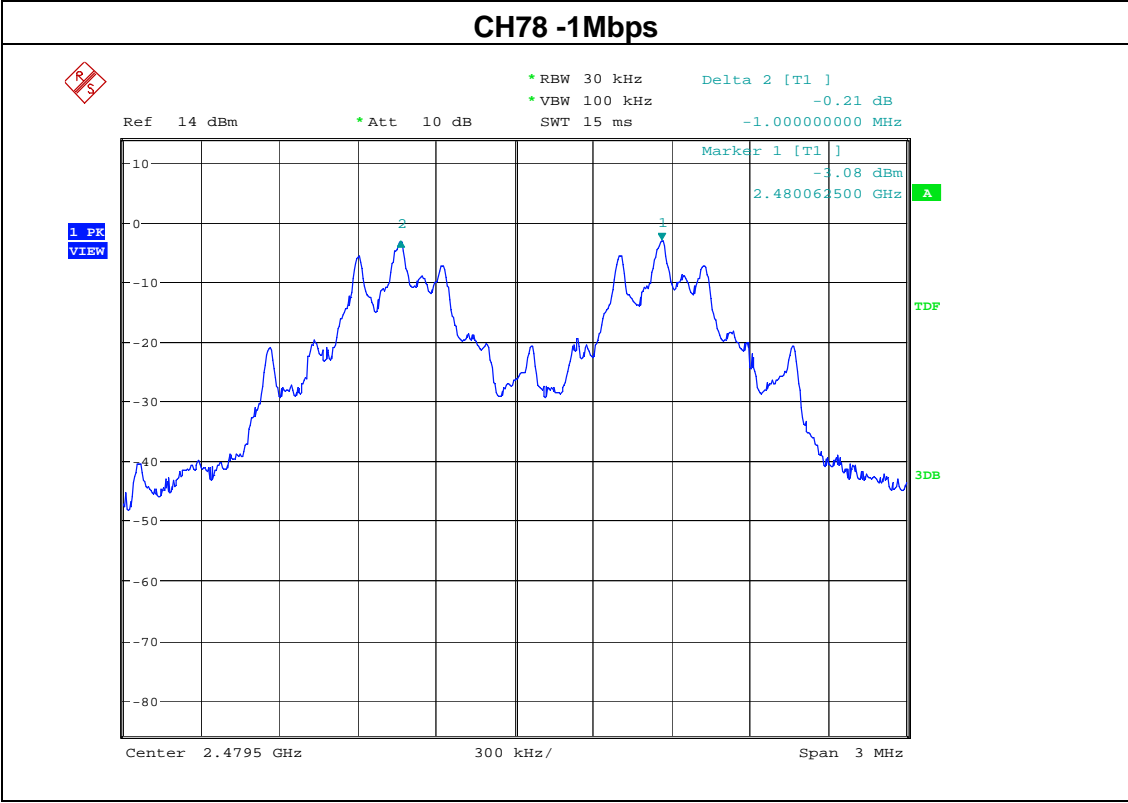
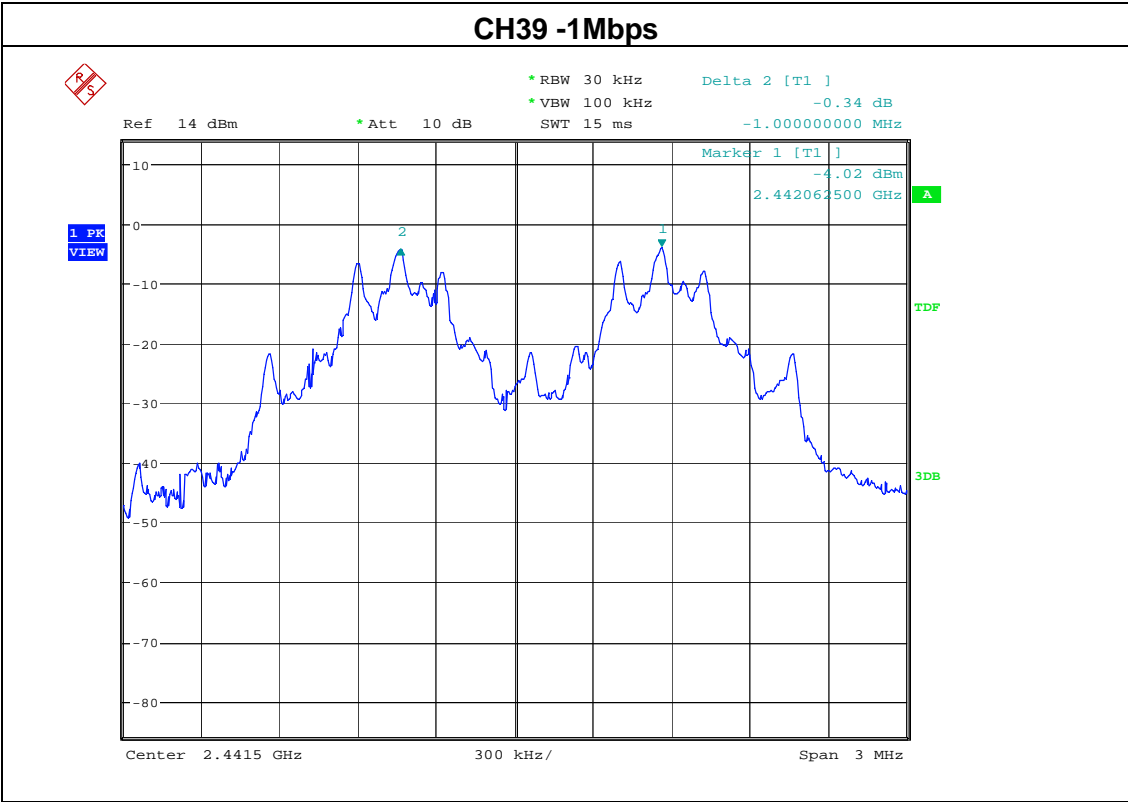

EUT	MULTIMEDIA SPEAKER	Model Name	TSME26 BLK
Temperature	25 °C	Relative Humidity	60%
Pressure	1012 hPa	Test Result	Pass
Test Mode	CH00 / CH39 /CH78 (2Mbps Mode)	Test Date	August 12, 2015

Channel number	Channel frequency (MHz)	Separation Read value (KHz)	Separation limit 2/3 20db down BW(KHz)
00	2402	1000	>734.00
39	2441	1005	>730.67
78	2480	995.2	>730.67

Note: 20db bandwidth refer to section 6.1.5

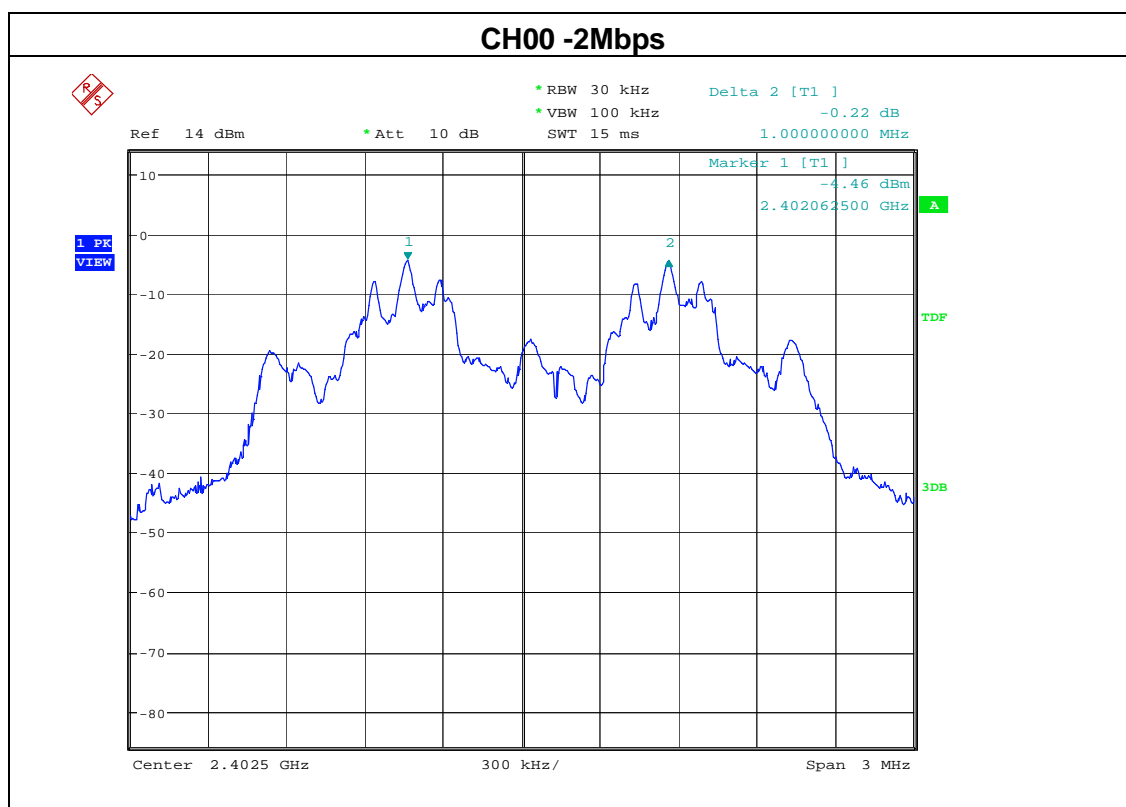

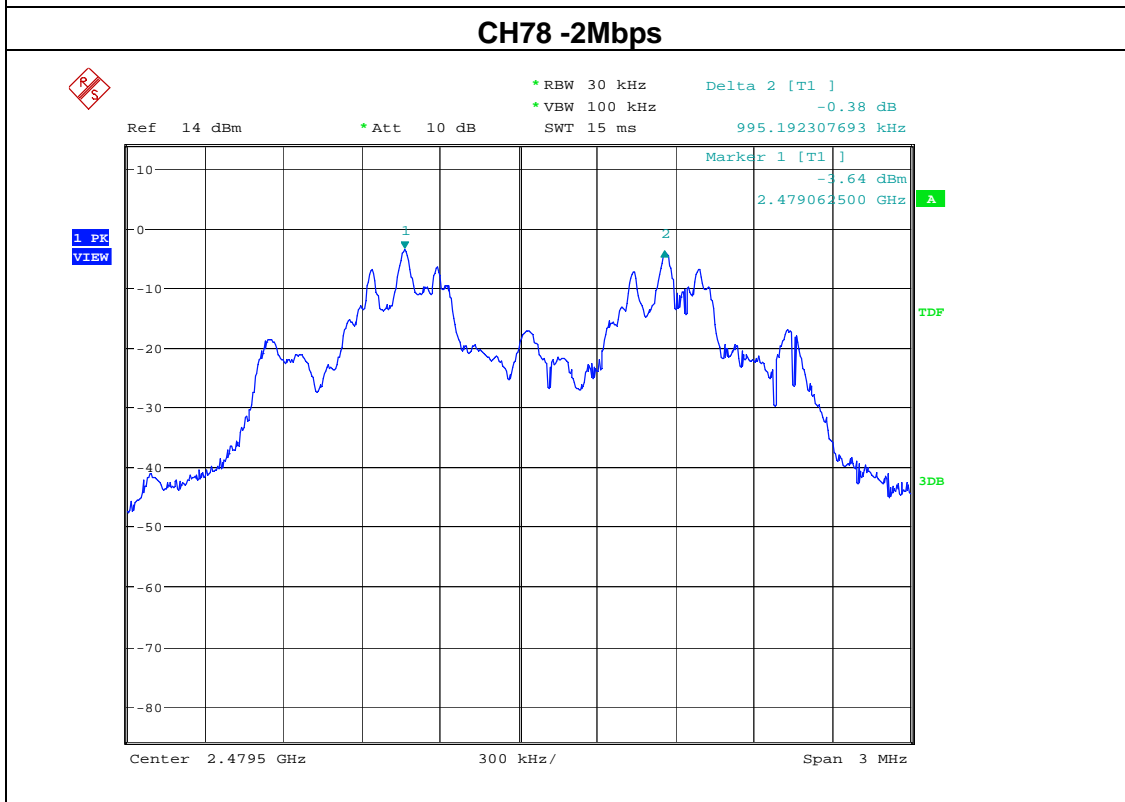
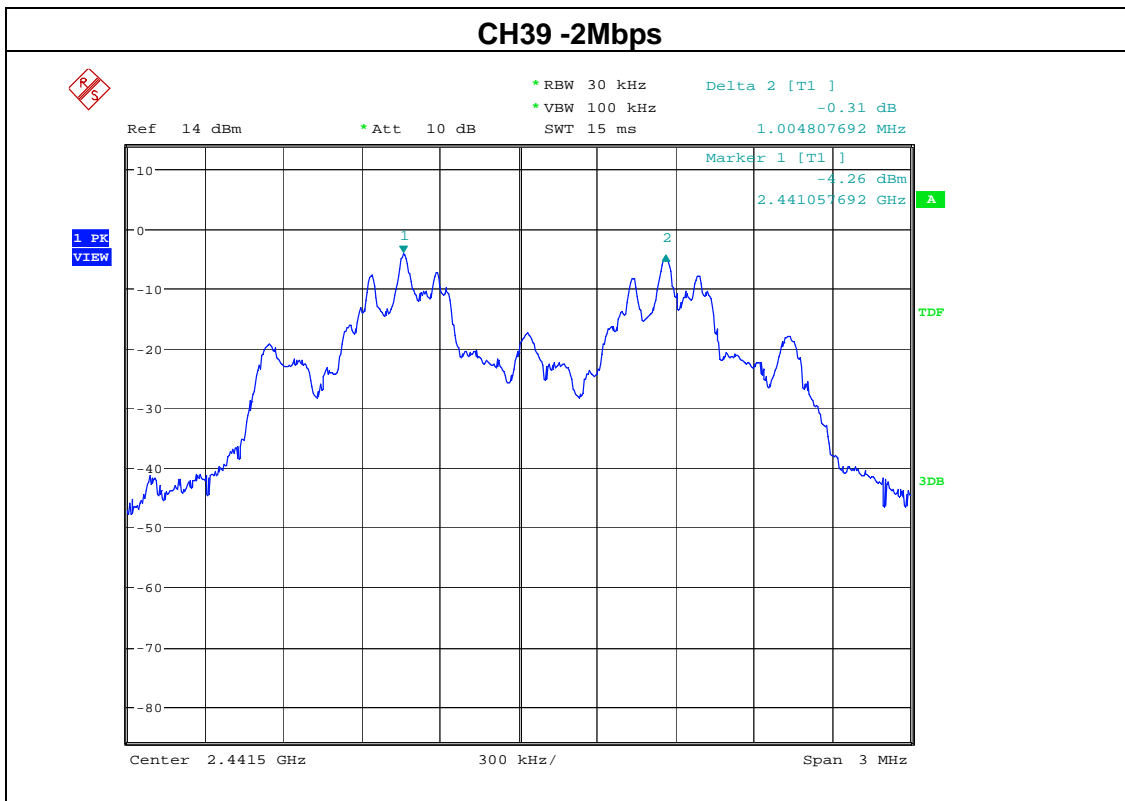

EUT	MULTIMEDIA SPEAKER	Model Name	TSME26 BLK
Temperature	25 °C	Relative Humidity	60%
Pressure	1012 hPa	Test Result	Pass
Test Mode	CH00 / CH39 /CH78 (3Mbps Mode)	Test Date	August 12, 2015

Channel number	Channel frequency (MHz)	Separation Read value (KHz)	Separation limit 2/3 20db down BW(KHz)
00	2402	1005	>740.67
39	2441	1000	>746.67
78	2480	1005	>743.33

Note: 20db bandwidth refer to section 6.1.5

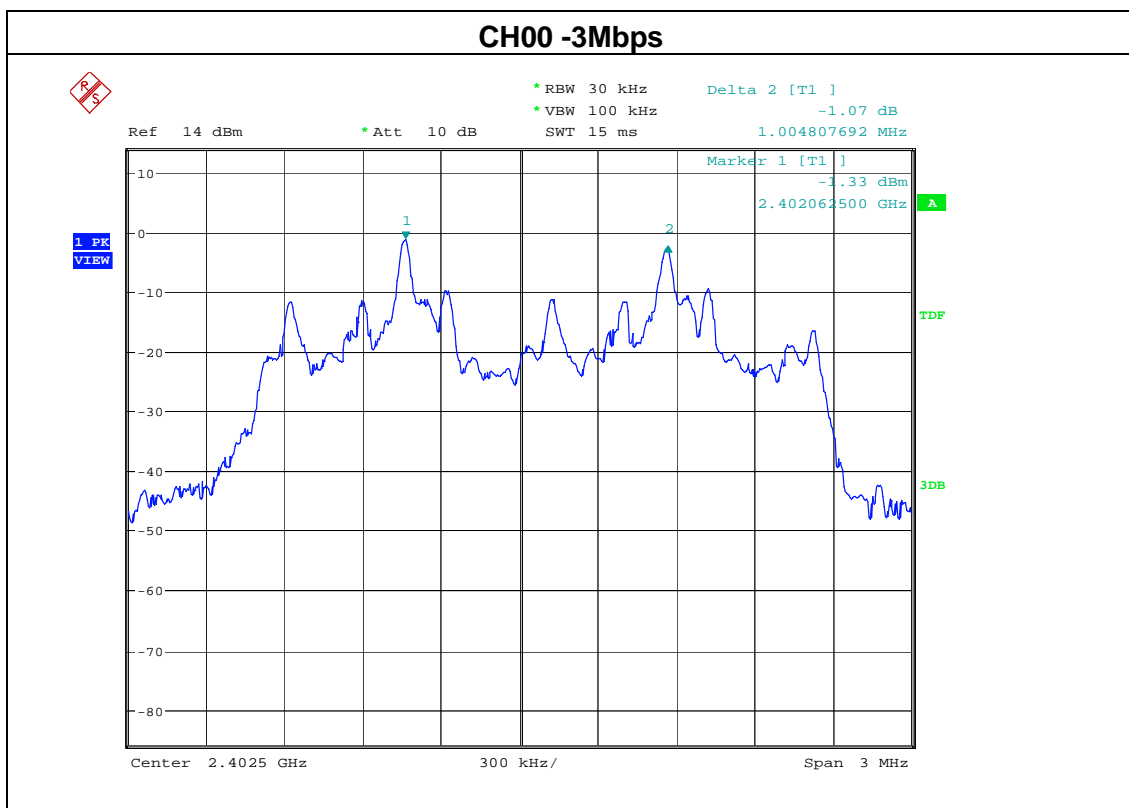

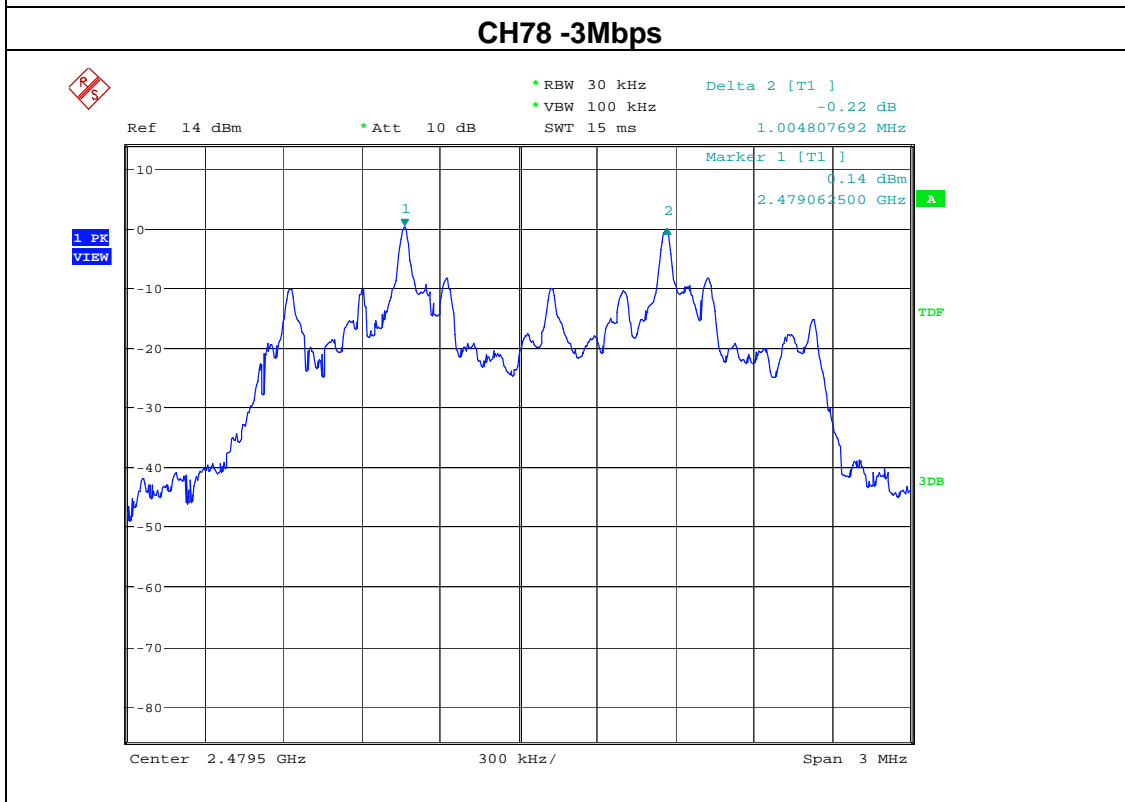
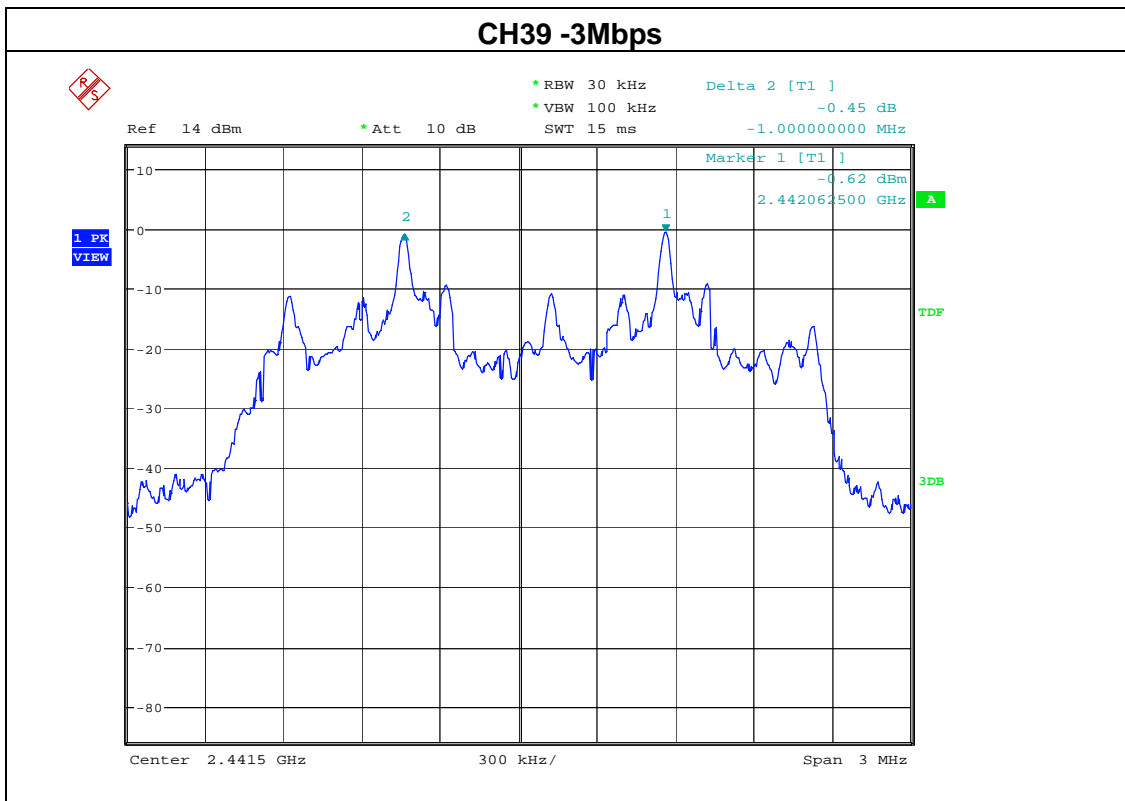

**9. BANDWIDTH TEST****9.1 APPLIED PROCEDURES / LIMIT**

FCC Part15 (15.247) , Subpart C				
Section	Test Item	Limit	Frequency Range (MHz)	Result
15.247 (a)(1)	Bandwidth	(20dB bandwidth)	2400-2483.5	PASS

Spectrum Parameter	Setting
Attenuation	Auto
Span Frequency	> Measurement Bandwidth or Channel Separation
RB	30kHz
VB	100kHz
Detector	Peak
Trace	Max hold
Sweep Time	Auto

**9.2 TEST PROCEDURE**

1. Check the calibration of the measuring instrument (spectrum analyzer) using either an internal calibrator or a known signal from an external generator.
2. Remove the antenna from the EUT and then connect a low loss RF cable from the antenna port to the spectrum analyzer.
3. Set the spectrum analyzer as follows: VBW =30kHz, RBW=100kHz, Sweep = auto Detector function = peak ,Trace = max hold
4. Measure the highest amplitude appearing on spectral display and record the level to calculate results.
5. Repeat above procedures until all frequencies measured were complete.

**9.3 DEVIATION FROM STANDARD**

No deviation.

**9.4 TEST SETUP****9.5 EUT OPERATION CONDITIONS**

The EUT tested system was configured as the statements of 2.4 Unless otherwise a special operating condition is specified in the follows during the testing.

### 9.6 TEST RESULTS

EUT	MULTIMEDIA SPEAKER	Model Name	TSME26 BLK
Temperature	25 °C	Relative Humidity	60%
Pressure	1012 hPa	Test Mode	CH00/CH39/C78(1Mbps)
Test Date	August 12, 2015		

Frequency	20dB Bandwidth (kHz)	Result
2402 MHz	1034	PASS
2441 MHz	1044	PASS
2480 MHz	1038	PASS

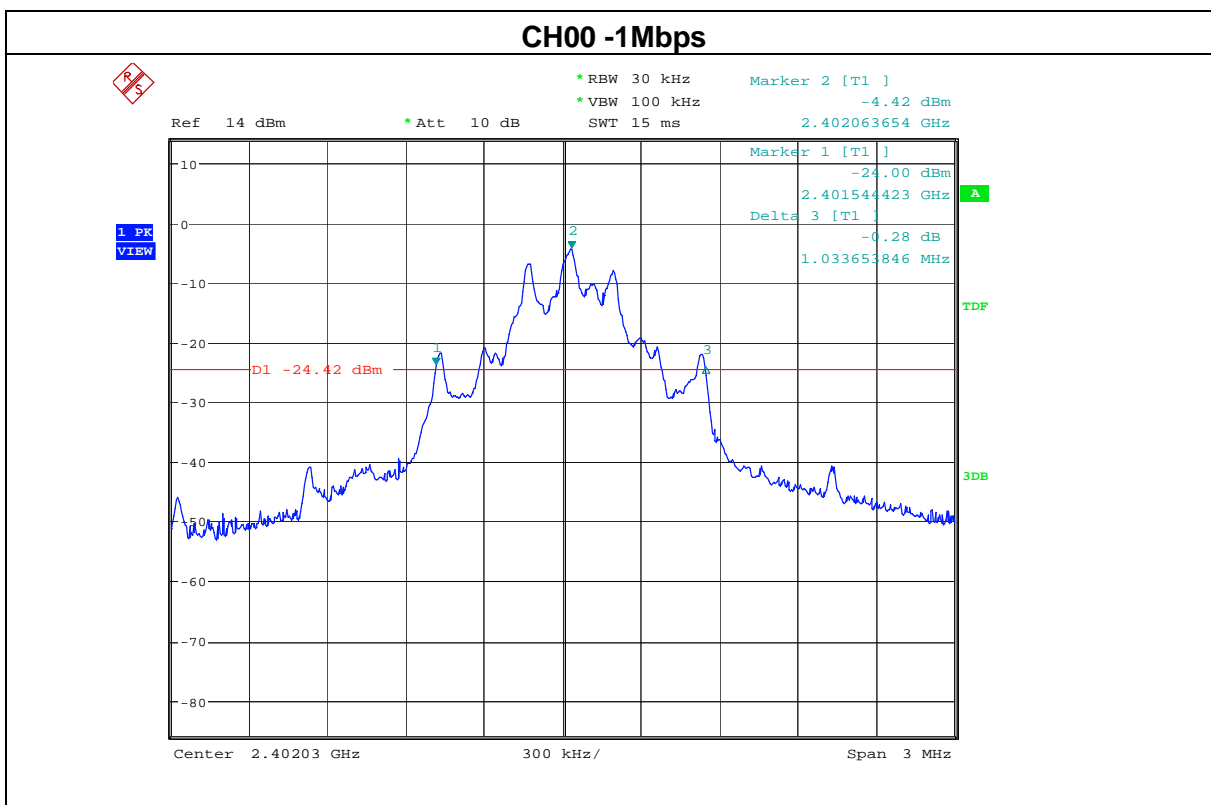





EUT	MULTIMEDIA SPEAKER	Model Name	TSME26 BLK
Temperature	25 °C	Relative Humidity	60%
Pressure	1012 hPa	Test Mode	CH00/CH39/C78(2Mbps)
Test Date	August 12, 2015		

Frequency	20dB Bandwidth (kHz)	Result
2402 MHz	1101	PASS
2441 MHz	1096	PASS
2480 MHz	1096	PASS

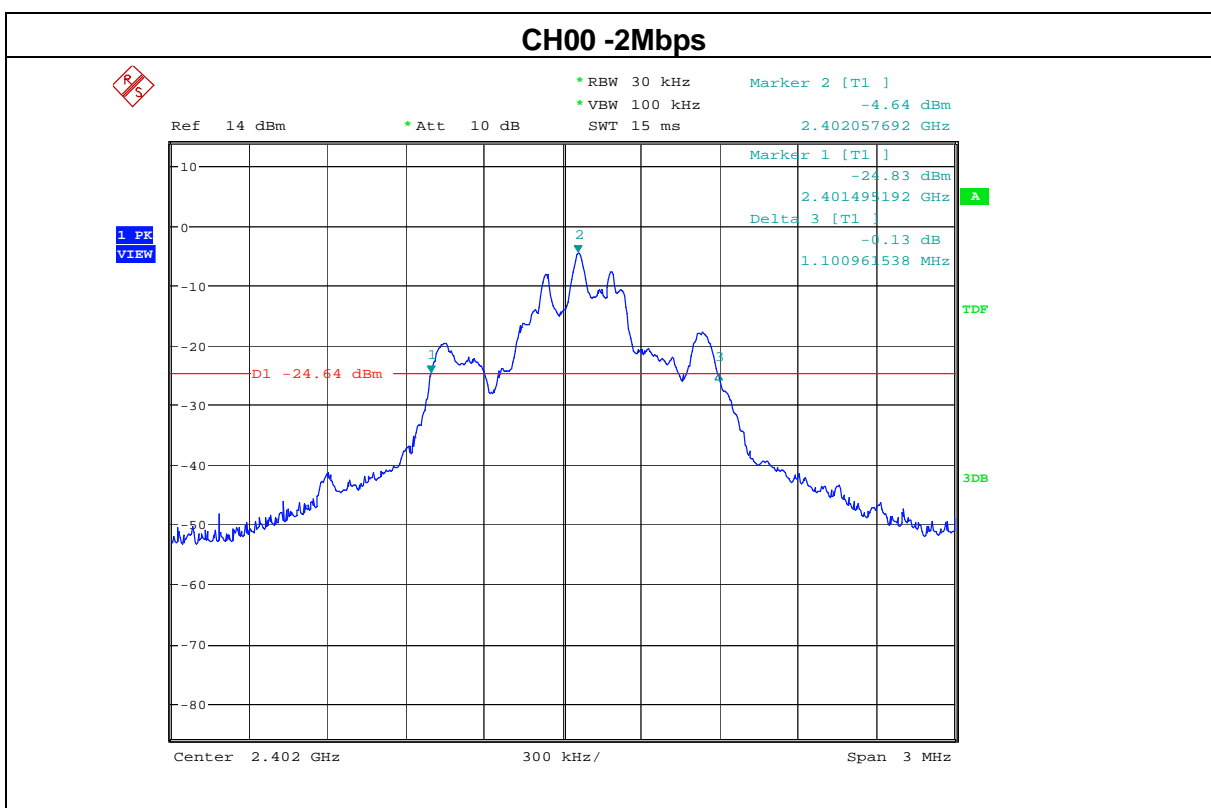



EUT	MULTIMEDIA SPEAKER	Model Name	TSME26 BLK
Temperature	25 °C	Relative Humidity	60%
Pressure	1012 hPa	Test Mode	CH00/CH39/C78(3Mbps)
Test Date	August 12, 2015		

Frequency	20dB Bandwidth (kHz)	Result
2402 MHz	1111	PASS
2441 MHz	1120	PASS
2480 MHz	1115	PASS

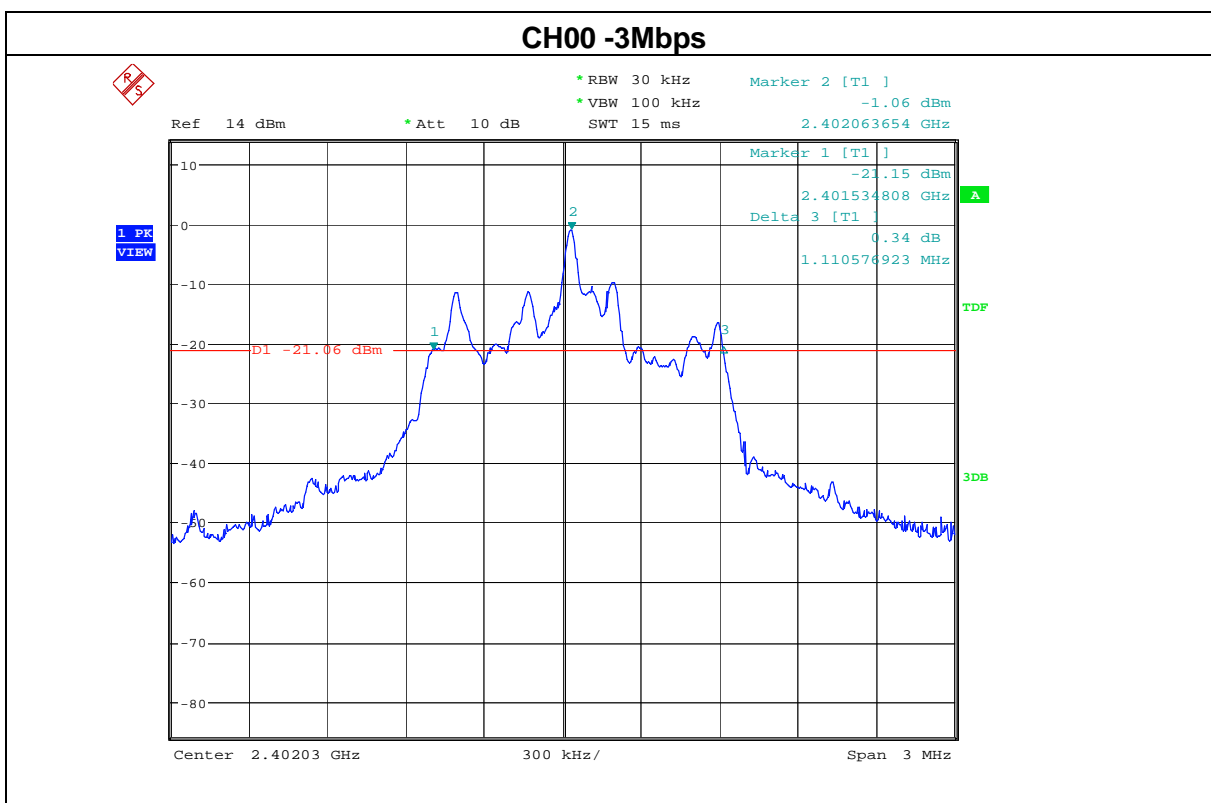



**10. PEAK OUTPUT POWER TEST****10.1 APPLIED PROCEDURES / LIMIT**

FCC Part15 (15.247) , Subpart C				
Section	Test Item	Limit	Frequency Range (MHz)	Result
15.247 (b)(i)	Peak Output Power	0.125 w or 20.96dBm	2400-2483.5	PASS

**10.2 TEST PROCEDURE**

- a. Remove the antenna from the EUT and then connect a low loss RF cable from the antenna port to the power meter through a power sensor and antenna output port as show in the block diagram below,
- b. Record the result

**10.3 DEVIATION FROM STANDARD**

No deviation.

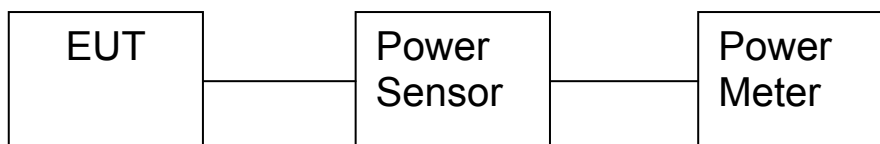
**10.4 TEST SETUP****10.5 EUT OPERATION CONDITIONS**

The EUT tested system was configured as the statements of 2.4 Unless otherwise a special operating condition is specified in the follows during the testing.

**10.6 TEST RESULTS**

EUT	MULTIMEDIA SPEAKER	Model Name	TSME26 BLK
Temperature	25 °C	Relative Humidity	60%
Pressure	1012 hPa	Test Mode	CH00/ CH39 /CH78 (1M/2M/3Mbps Mode)
Test Date	August 12, 2015		

<b>1Mbps</b>				
Test Channel	Frequency (MHz)	Peak Output Power (dBm)	LIMIT(dBm)	Result
CH00	2402	0.15	20.96	Pass
CH39	2441	0.16	20.96	Pass
CH78	2480	0.18	20.96	Pass
<b>2Mbps</b>				
CH00	2402	0.44	20.96	Pass
CH39	2441	0.47	20.96	Pass
CH78	2480	0.51	20.96	Pass
<b>3Mbps</b>				
CH00	2402	0.62	20.96	Pass
CH39	2441	0.64	20.96	Pass
CH78	2480	0.65	20.96	Pass

## **11. ANTENNA APPLICATION**

### **11.1 Antenna requirement**

The EUT'S antenna is met the requirement of FCC part 15C section 15.203 and 15.247

### **11.2 Result**

The EUT's antenna integrated on PCB, The antenna's gain is 1.0dBi and meets the requirement.

## 12. EUT TEST PHOTO

CONDUCTED EMISSION TEST



RADIATED EMISSION TEST

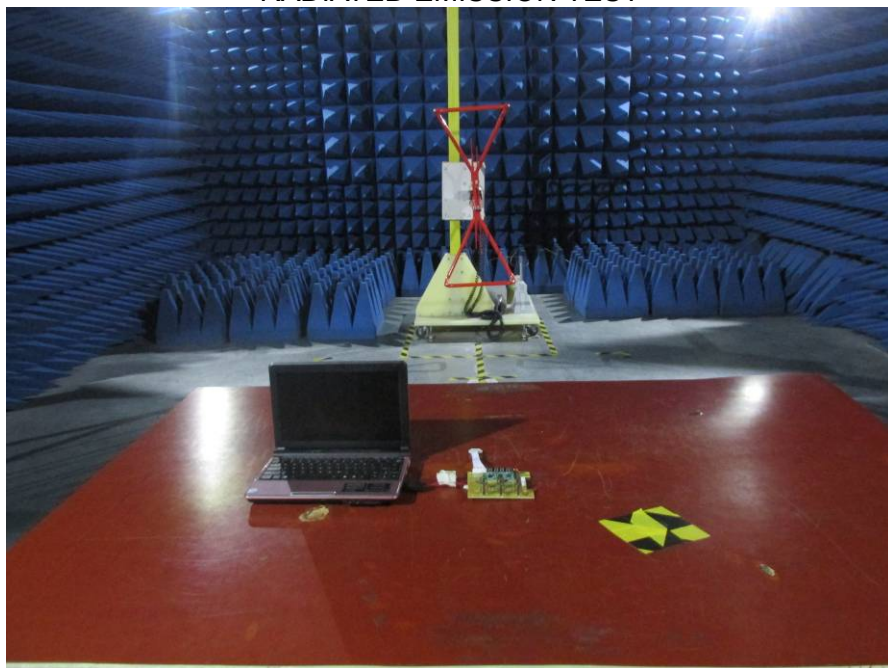



### RADIATED EMISSION TEST

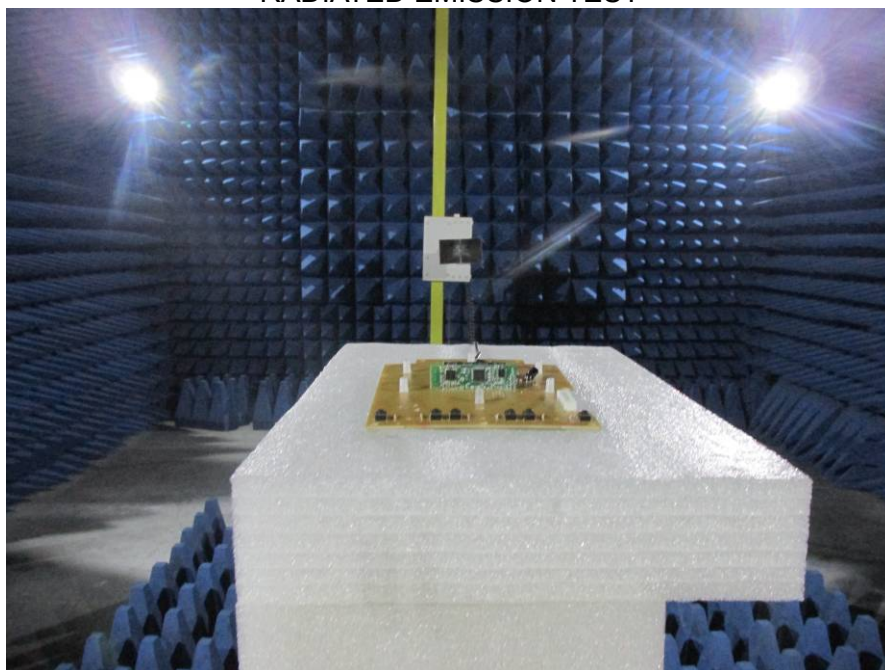

### RF TEST

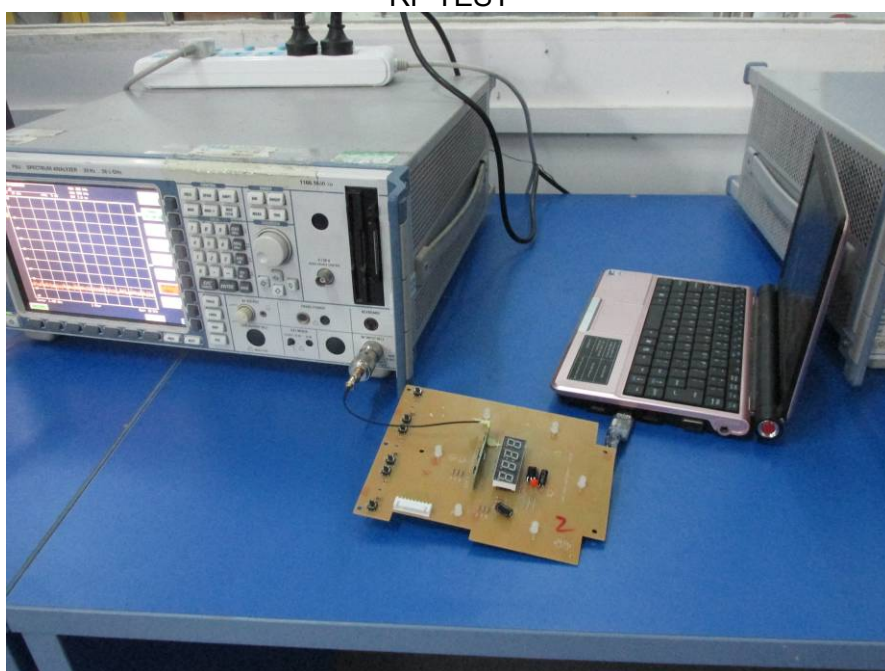

### 13. PHOTOGRAPHS OF EUT

Appearance photograph of EUT



Appearance photograph of EUT



Appearance photograph of EUT



Appearance photograph of EUT





Appearance photograph of EUT



Appearance photograph of EUT



Appearance photograph of EUT



Internal photograph of EUT





Internal photograph of EUT

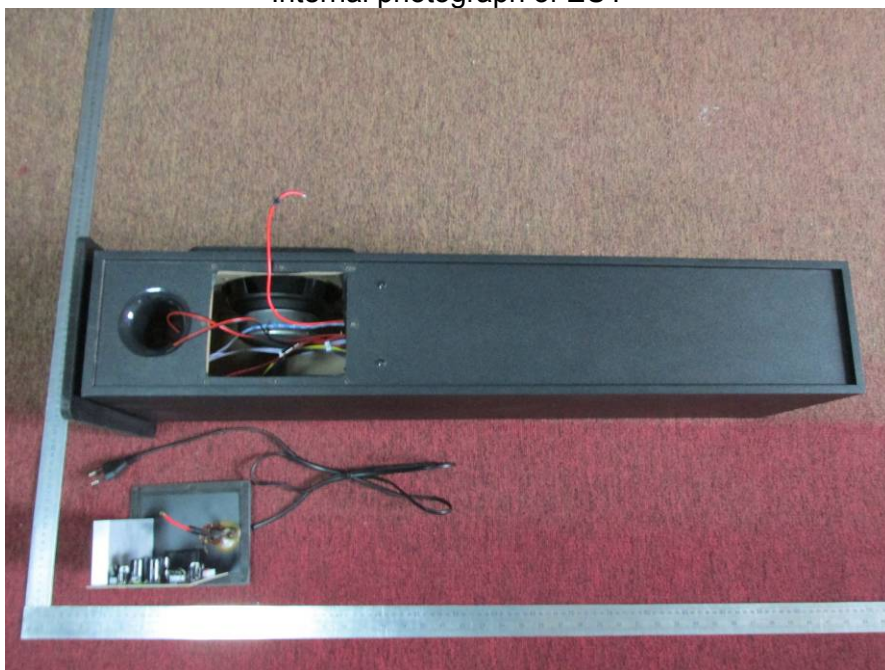

PCB photograph of EUT



PCB photograph of EUT

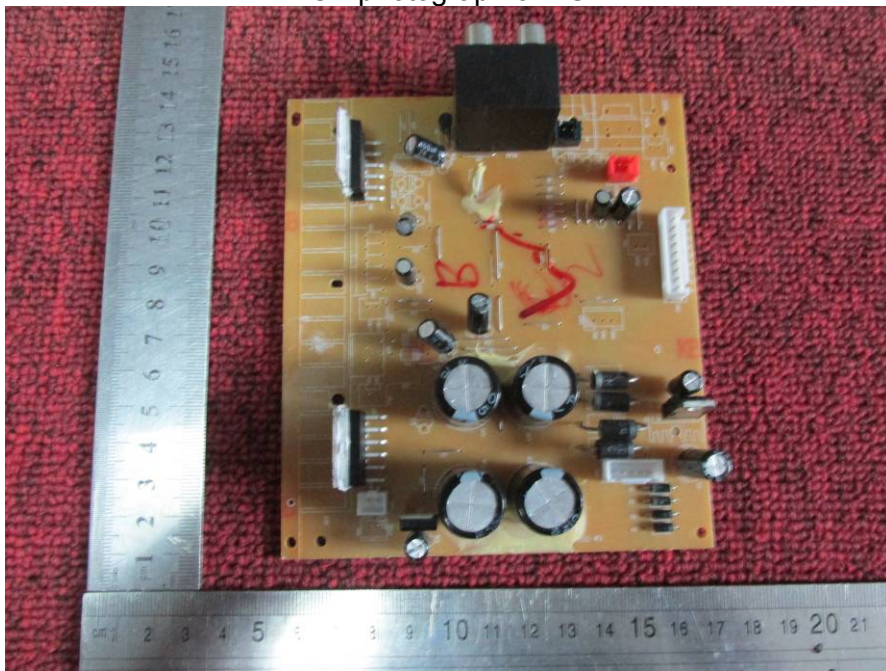

PCB photograph of EUT

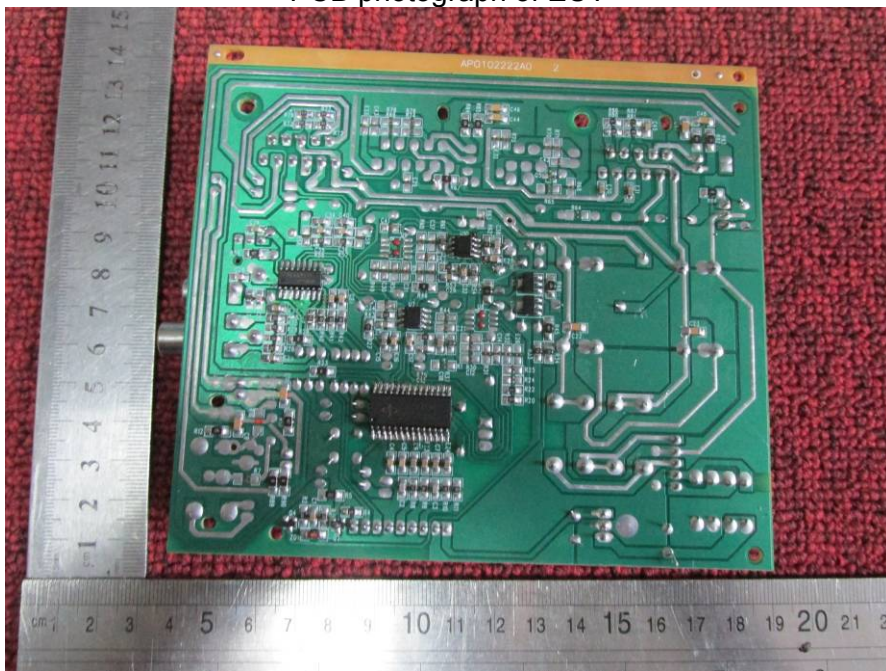



PCB photograph of EUT

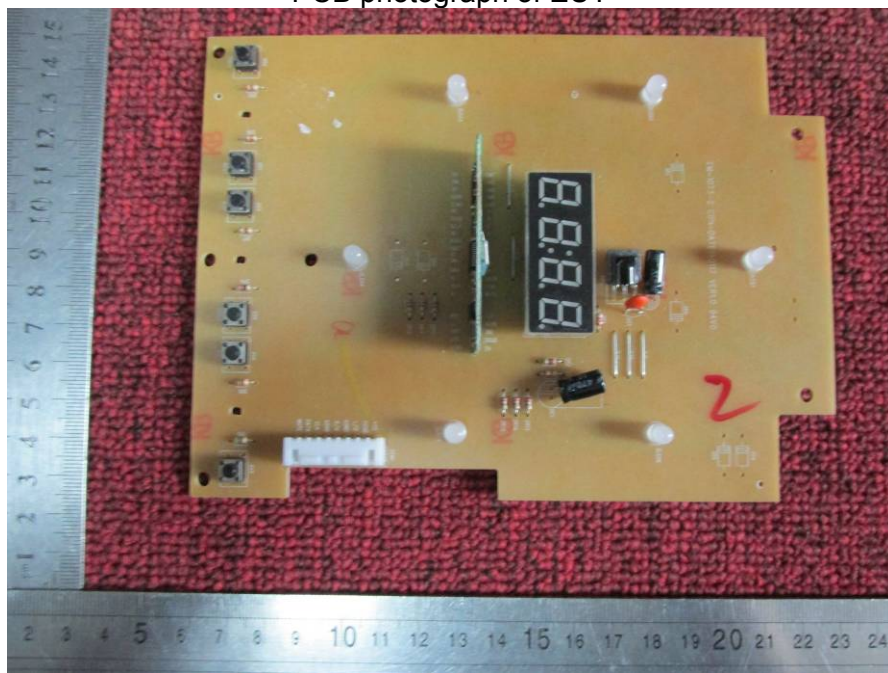

PCB photograph of EUT

