

FCC Test Report

FCC ID : 2AD37JVAW53RX
Equipment : Wireless Display HDMI Extender
Brand Name : j5create
Model Name : JVAW53-RX , JVAW50-RX
Applicant : KAIJET TECHNOLOGY INTERNATIONAL CORPORATION
8F., No.109, Zhongcheng Rd., Tucheng Dist., New Taipei City
236, Taiwan, R.O.C.
Manufacturer : Magic Control Technology Corporation
10F., No.123, Zhongcheng Rd., Tucheng Dist., New Taipei
City 236, Taiwan R.O.C.
Standard : 47 CFR FCC Part 15.407

The product was received on May 13, 2020, and testing was started from May 23, 2020 and completed on Jun. 02, 2020. We, SPORTON INTERNATIONAL INC. EMC & Wireless Communications Laboratory, would like to declare that the tested sample has been evaluated in accordance with the procedures given in ANSI C63.10-2013 and shown compliance with the applicable technical standards.

The report must not be used by the client to claim product certification, approval, or endorsement by TAF or any agency of government.

The test results in this report apply exclusively to the tested model / sample. Without written approval of SPORTON INTERNATIONAL INC. EMC & Wireless Communications Laboratory, the test report shall not be reproduced except in full.



Approved by: Allen Lin

SPORTON INTERNATIONAL INC. EMC & Wireless Communications Laboratory

No. 52, Huaya 1st Rd., Guishan Dist., Taoyuan City, Taiwan (R.O.C.)



Table of Contents

HISTORY OF THIS TEST REPORT3

SUMMARY OF TEST RESULT4

1 GENERAL DESCRIPTION5

1.1 Information.....5

1.2 Testing Applied Standards7

1.3 Testing Location Information7

1.4 Measurement Uncertainty8

2 TEST CONFIGURATION OF EUT.....9

2.1 Test Condition9

2.2 Test Channel Mode9

2.3 The Worst Case Measurement Configuration.....10

2.4 Accessories11

2.5 Support Equipment.....11

2.6 Test Setup Diagram12

3 TRANSMITTER TEST RESULT14

3.1 AC Power-line Conducted Emissions14

3.2 Emission Bandwidth.....16

3.3 Maximum Conducted Output Power17

3.4 Peak Power Spectral Density.....19

3.5 Unwanted Emissions.....21

4 TEST EQUIPMENT AND CALIBRATION DATA.....25

APPENDIX A. TEST RESULTS OF AC POWER-LINE CONDUCTED EMISSIONS

APPENDIX B. TEST RESULTS OF EMISSION BANDWIDTH

APPENDIX C. TEST RESULTS OF MAXIMUM CONDUCTED OUTPUT POWER

APPENDIX D. TEST RESULTS OF PEAK POWER SPECTRAL DENSITY

APPENDIX E. TEST RESULTS OF UNWANTED EMISSIONS

APPENDIX F. TEST PHOTOS

PHOTOGRAPHS OF EUT V02



Summary of Test Result

Report Clause	Ref. Std. Clause	Test Items	Result (PASS/FAIL)	Remark
1.1.2	15.203	Antenna Requirement	PASS	-
3.1	15.207	AC Power-line Conducted Emissions	PASS	-
3.2	15.407(a)	Emission Bandwidth	PASS	-
3.3	15.407(a)	Maximum Conducted Output Power	PASS	-
3.4	15.407(a)	Peak Power Spectral Density	PASS	-
3.5	15.407(b)	Unwanted Emissions	PASS	-

Note : From Sporton Project No.:FR030928-02AN.

Declaration of Conformity:
The test results with all measurement uncertainty excluded are presented in accordance with the regulation limits or requirements declared by manufacturers.
Comments and explanations:
None

Reviewed by: Sam Tsai

Report Producer: Jenny Yang

1 General Description

1.1 Information

1.1.1 RF General Information

Frequency Range (MHz)	IEEE Std. 802.11	Ch. Frequency (MHz)	Channel Number
5150-5250	ac (VHT80)	5210	42 [1]
5725-5850		5775	155 [1]

Band	Mode	BWch (MHz)	Nant
5.15-5.25GHz	802.11ac VHT80	80	2TX
5.725-5.85GHz	802.11ac VHT80	80	2TX

Note:

- ♦ VHT80 use a combination of OFDM-BPSK, QPSK, 16QAM, 64QAM, 256QAM modulation.
- ♦ BWch is the nominal channel bandwidth.

1.1.2 Antenna Information

Ant.	Port	Brand	Model Name	Antenna Type	Connector	Gain (dBi)
1	1	HT-TECH	WIA1J-2458-B1-SMA-MR-W2	Dipole	I-PEX	5
2	2	HT-TECH	WIA1J-2458-B1-SMA-MR-W2	Dipole	I-PEX	5

Note 1: The EUT has two antennas.

For 5GHz function:

For IEEE 802.11 ac mode (2TX/2RX)

Ant. 1 (port 1) and Ant. 2 (port 2) could transmit/receive simultaneously.

1.1.3 EUT Information

Operational Condition				
EUT Power Type	From AC Adapter			
EUT Function	<input type="checkbox"/>	Outdoor AP	<input type="checkbox"/>	Indoor AP
	<input checked="" type="checkbox"/>	Fixed P2P AP	<input type="checkbox"/>	Indoor Client
Beamforming Function	<input type="checkbox"/>	With beamforming	<input checked="" type="checkbox"/>	Without beamforming
Type of EUT				
<input checked="" type="checkbox"/>	Stand-alone			
<input type="checkbox"/>	Combined (EUT where the radio part is fully integrated within another device)			
	Combined Equipment - Brand Name / Model No.: ...			
<input type="checkbox"/>	Plug-in radio (EUT intended for a variety of host systems)			
	Host System - Brand Name / Model No.:			
<input type="checkbox"/>	Other:			

1.1.4 Mode Test Duty Cycle

JVAW50-RX

Mode	DC	DCF(dB)	T(s)	VBW(Hz) ≥ 1/T
802.11ac VHT80_Nss1,(MCS0)_2TX	0.756	1.21	336.25u	3k

Note. If DC < 0.98, the DCF was added while measuring Output power and PSD.

JVAW53-RX

Mode	DC	DCF(dB)	T(s)	VBW(Hz) ≥ 1/T
802.11ac VHT80_Nss1,(MCS0)_2TX	0.755	1.22	336.25u	3k

Note. If DC < 0.98, the DCF was added while measuring Output power and PSD.

1.1.5 Table for Multiple Listing

The model names in the following table are all refer to the identical product.

Model Name	USB Port	Description
JVAW53-RX	With	All the models are identical, the difference is that EUT with USB Port or not.
JVAW50-RX	Without	

1.2 Testing Applied Standards

According to the specifications of the manufacturer, the EUT must comply with the requirements of the following standards:

- ◆ 47 CFR FCC Part 15
- ◆ ANSI C63.10-2013
- ◆ KDB 789033 D02 v02r01

The following reference test guidance is not within the scope of accreditation of TAF:

- ◆ KDB 662911 D01 v02r01
- ◆ KDB 414788 D01 v01r01

1.3 Testing Location Information

Testing Location		
<input checked="" type="checkbox"/>	HWA YA	ADD : No. 52, Huaya 1st Rd., Guishan Dist., Taoyuan City, Taiwan (R.O.C.) TEL : 886-3-327-3456 FAX : 886-3-327-0973
Test site Designation No. TW1190 with FCC.		
<input type="checkbox"/>	JHUBEI	ADD : No.8, Ln. 724, Bo'ai St., Zhubei City, Hsinchu County, Taiwan (R.O.C.) TEL : 886-3-656-9065 FAX : 886-3-656-9085
Test site Designation No. TW0006 with FCC.		
<input type="checkbox"/>	Wen Shan	ADD : No.14-1, Ln. 19, Wen 33rd St., Guishan Dist., Taoyuan City 333, Taiwan (R.O.C.) TEL : 886-3-318-0787 FAX : 886-3-318-0287
Test site Designation No. TW1097 with FCC.		

Test Condition	Test Site No.	Test Engineer	Test Environment	Test Date
AC Conduction	CO04-HY	Edward Wang	23.1~24.5°C / 62~68%	27/May/2020
RF Conducted	TH07-HY	Justin Pan	20~24°C / 50~56%	25/May/2020~ 29/May/2020
Radiated	03CH03-HY	Jeff Lin	21.6~25.5°C / 51~ 62%	23/May/2020~ 02/Jun/2020



1.4 Measurement Uncertainty

ISO/IEC 17025 requires that an estimate of the measurement uncertainties associated with the emissions test results be included in the report. The measurement uncertainties given below are based on a 95% confidence level (based on a coverage factor (k=2))

Test Items	Uncertainty	Remark
Conducted Emission (150kHz ~ 30MHz)	0.9 dB	Confidence levels of 95%
Radiated Emission (9kHz ~ 30MHz)	2.4 dB	Confidence levels of 95%
Radiated Emission (30MHz ~ 1,000MHz)	3.7 dB	Confidence levels of 95%
Radiated Emission (1GHz ~ 18GHz)	3.6 dB	Confidence levels of 95%
Radiated Emission (18GHz ~ 40GHz)	3.5 dB	Confidence levels of 95%
Conducted Emission	1.0 dB	Confidence levels of 95%
Temperature	0.41 °C	Confidence levels of 95%
Humidity	3.4 %	Confidence levels of 95%



2 Test Configuration of EUT

2.1 Test Condition

Condition Item	Abbreviation/Remark	Remark
TnomVnom	Tnom	20°C
-	Vnom	120V

2.2 Test Channel Mode

Test Software Version	QATool: v 1.0.3.23
-----------------------	--------------------

JVAW50-RX

Mode	Power Setting
802.11ac VHT80_Nss1,(MCS0)_2TX	-
5210MHz	0E,0E
5775MHz	1C,1C



JVAW53-RX

Mode	Power Setting
802.11ac VHT80_Nss1,(MCS0)_2TX	-
5210MHz	0E,0E
5775MHz	1B,1B

2.3 The Worst Case Measurement Configuration

The Worst Case Mode for Following Conformance Tests	
Tests Item	AC power-line conducted emissions
Condition	AC power-line conducted measurement for line and neutral
Operating Mode	CTX
1	AC Adapter mode (DSA-12PFU-05 FCA); JVAW50-RX
2	AC Adapter mode (DSA-12PFU-05 FUS); JVAW50-RX
3	AC Adapter mode (DSA-12PFU-05 FCA); JVAW53-RX
4	AC Adapter mode (DSA-12PFU-05 FUS); JVAW53-RX

The Worst Case Mode for Following Conformance Tests	
Tests Item	Emission Bandwidth Maximum Conducted Output Power Peak Power Spectral Density
Test Condition	Conducted measurement at transmit chains

The Worst Case Mode for Following Conformance Tests		
Tests Item	Unwanted Emissions	
Test Condition	Radiated measurement If EUT consist of multiple antenna assembly (multiple antenna are used in EUT regardless of spatial multiplexing MIMO configuration), the radiated test should be performed with highest antenna gain of each antenna type.	
Operating Mode < 1GHz	CTX	
1	AC Adapter mode (DSA-12PFU-05 FCA); JVAW50-RX	
2	AC Adapter mode (DSA-12PFU-05 FUS); JVAW50-RX	
3	AC Adapter mode (DSA-12PFU-05 FCA); JVAW53-RX	
4	AC Adapter mode (DSA-12PFU-05 FUS); JVAW53-RX	
Operating Mode > 1GHz	CTX	
Orthogonal Planes of EUT	Y Plane	Z Plane
		
Worst Planes of EUT		V

2.4 Accessories

Accessories				
AC Adapter 1	Brand Name	EFFICIENCY LEVEL	Model Name	DSA-12PFU-05 FCA
	Power Rating	I/P: 100 - 240 Vac, 0.5 A, O/P: 5 Vdc, 2 A		
	Power Cord	1.5meter, non-shielded cable, w/o ferrite core		
AC Adapter 2	Brand Name	EFFICIENCY LEVEL	Model Name	DSA-12PFU-05 FUS
	Power Rating	I/P: 100 - 240 Vac, 0.5 A, O/P: 5Vdc, 2 A		
	Power Cord	1.5 meter, non-shielded cable, w/o ferrite core		
HDMI Cable	Brand Name	Hisetec	Model Name	5CH00100000001
	Signal Line	1 meter, shielded cable, w/o ferrite core		
IR Cable	Brand Name	Alaways Tai Lai	Model Name	ATL-0504
	Signal Line	1.5 meter, non-shielded cable		
IR Cable	Brand Name	Alaways Tai Lai	Model Name	ATL-0439
	Signal Line	1.5 meter, non-shielded cable		

Reminder: Regarding to more detail and other information, please refer to user manual.

2.5 Support Equipment

Support Equipment – Conducted					
No.	Equipment	Brand Name	Model Name	FCC ID	Remark
1	Notebook	DELL	PP13S	-	-
2	Adapter for NB	DELL	AA90PM111	-	-

2.6 Test Setup Diagram

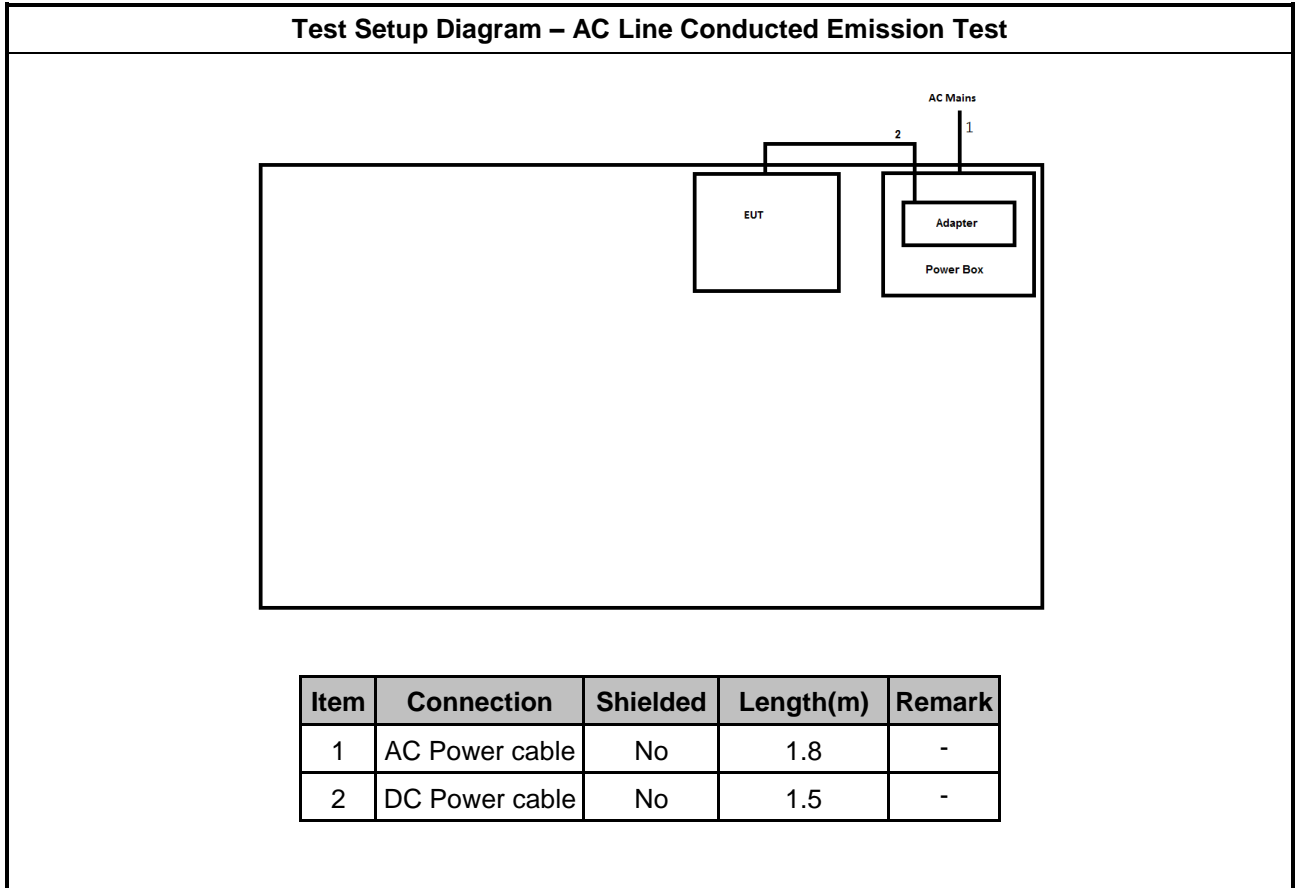

Test Setup Diagram - Radiated Test

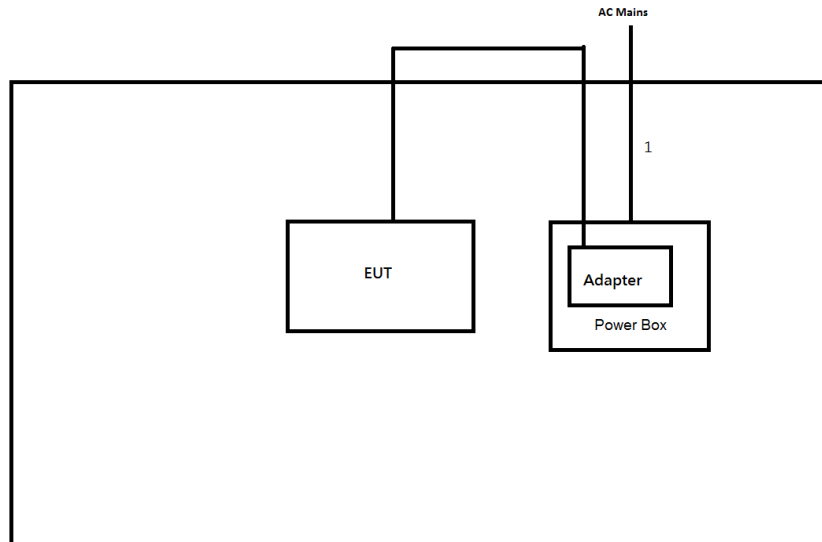

Item	Connection	Shielded	Length(m)	Remark
1	AC Power cable	No	1.8	-
2	DC Power cable	No	1.5	-



3 Transmitter Test Result

3.1 AC Power-line Conducted Emissions

3.1.1 AC Power-line Conducted Emissions Limit

AC Power-line Conducted Emissions Limit		
Frequency Emission (MHz)	Quasi-Peak	Average
0.15-0.5	66 - 56 *	56 - 46 *
0.5-5	56	46
5-30	60	50

Note 1: * Decreases with the logarithm of the frequency.

3.1.2 Measuring Instruments

Refer a test equipment and calibration data table in this test report.

3.1.3 Test Procedures

Test Method
<input checked="" type="checkbox"/> Refer as ANSI C63.10-2013, clause 6.2 for AC power-line conducted emissions.

3.1.4 Test Setup

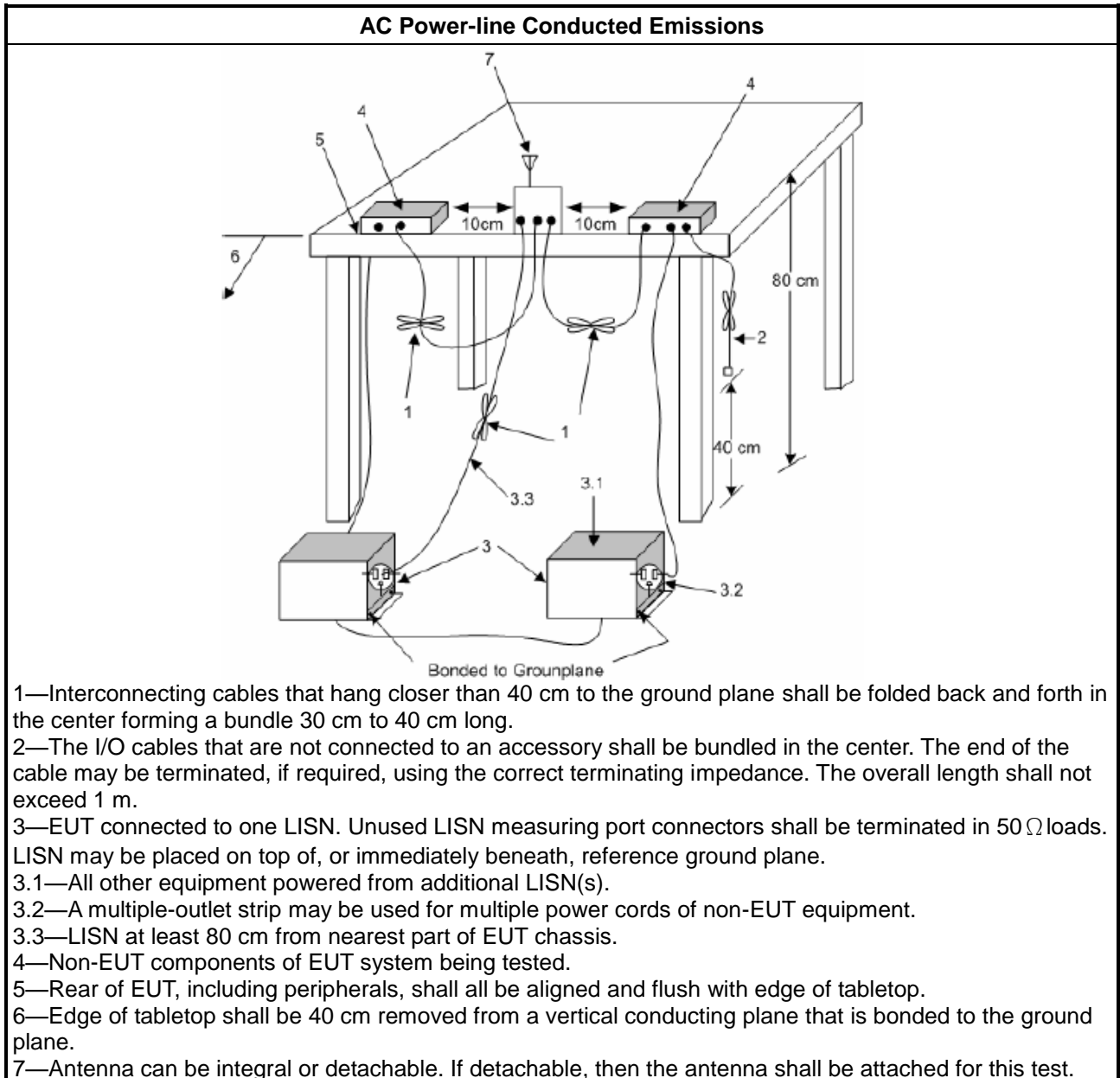

3.1.5 Test Result of AC Power-line Conducted Emissions

Refer as Appendix A

3.2 Emission Bandwidth

3.2.1 Emission Bandwidth Limit

Emission Bandwidth Limit	
UNII Devices	
<input checked="" type="checkbox"/>	For the 5.15-5.25 GHz band, N/A
<input type="checkbox"/>	For the 5.25-5.35 GHz band, N/A
<input type="checkbox"/>	For the 5.47-5.725 GHz band, N/A
<input checked="" type="checkbox"/>	For the 5.725-5.85 GHz band, 6 dB emission bandwidth \geq 500kHz.

3.2.2 Measuring Instruments

Refer a test equipment and calibration data table in this test report.

3.2.3 Test Procedures

Test Method	
<ul style="list-style-type: none"> ▪ For the emission bandwidth shall be measured using one of the options below: 	
<input checked="" type="checkbox"/>	Refer as KDB 789033, clause C for EBW and clause D for OBW measurement.
<input type="checkbox"/>	Refer as ANSI C63.10, clause 6.9.3 for occupied bandwidth testing.
<input type="checkbox"/>	Refer as IC RSS-Gen, clause 6.7 for bandwidth testing.

3.2.4 Test Setup

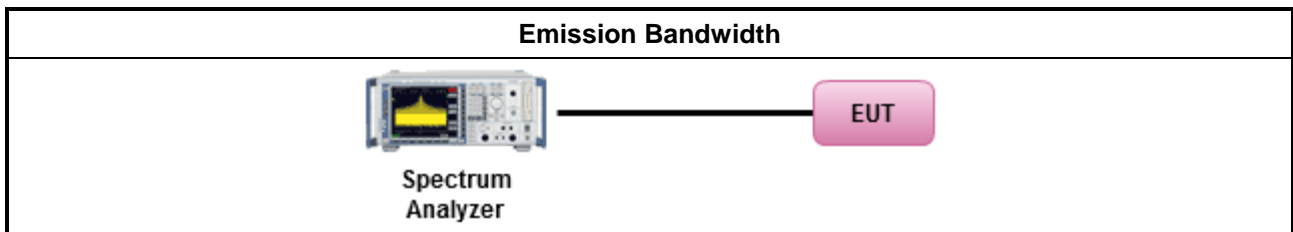

3.2.5 Test Result of Emission Bandwidth

Refer as Appendix B

3.3 Maximum Conducted Output Power

3.3.1 Maximum Conducted Output Power Limit

Maximum Conducted Output Power Limit	
UNII Devices	
<input checked="" type="checkbox"/> For the 5.15-5.25 GHz band:	
	<ul style="list-style-type: none"> ▪ Outdoor AP: the maximum conducted output power (P_{Out}) shall not exceed the lesser of 1 W. If $G_{TX} > 6$ dBi, then $P_{Out} = 30 - (G_{TX} - 6)$. e.i.r.p. at any elevation angle above 30 degrees $\leq 125mW$ [21dBm] ▪ Indoor AP: the maximum conducted output power (P_{Out}) shall not exceed the lesser of 1 W. If $G_{TX} > 6$ dBi, then $P_{Out} = 30 - (G_{TX} - 6)$ ▪ Point-to-point AP: the maximum conducted output power (P_{Out}) shall not exceed the lesser of 1 W. If $G_{TX} > 23$ dBi, then $P_{Out} = 30 - (G_{TX} - 23)$. ▪ Mobile or Portable Client: the maximum conducted output power (P_{Out}) shall not exceed the lesser of 250 mW. If $G_{TX} > 6$ dBi, then $P_{Out} = 24 - (G_{TX} - 6)$.
<input type="checkbox"/> For the 5.25-5.35 GHz band, the maximum conducted output power (P_{Out}) shall not exceed the lesser of 250 mW or $11 \text{ dBm} + 10 \log B$, where B is the 26 dB emission bandwidth in MHz. If $G_{TX} > 6$ dBi, then $P_{Out} = 24 - (G_{TX} - 6)$.	
<input type="checkbox"/> For the 5.47-5.725 GHz band, the maximum conducted output power (P_{Out}) shall not exceed the lesser of 250 mW or $11 \text{ dBm} + 10 \log B$, where B is the 26 dB emission bandwidth in MHz. If $G_{TX} > 6$ dBi, then $P_{Out} = 24 - (G_{TX} - 6)$.	
<input checked="" type="checkbox"/> For the 5.725-5.85 GHz band:	
	<ul style="list-style-type: none"> ▪ Point-to-multipoint systems (P2M): the maximum conducted output power (P_{Out}) shall not exceed the lesser of 1 W. If $G_{TX} > 6$ dBi, then $P_{Out} = 30 - (G_{TX} - 6)$. ▪ Point-to-point systems (P2P): the maximum conducted output power (P_{Out}) shall not exceed the lesser of 1 W.
P_{Out} = maximum conducted output power in dBm, G_{TX} = the maximum transmitting antenna directional gain in dBi.	

3.3.2 Measuring Instruments

Refer a test equipment and calibration data table in this test report.

3.3.3 Test Procedures

Test Method	
<ul style="list-style-type: none"> ▪ Maximum Conducted Output Power 	
	Duty cycle $\geq 98\%$
<input type="checkbox"/>	Refer as KDB 789033, clause E Method SA-2 (spectral trace averaging).
	Duty cycle $< 98\%$
<input type="checkbox"/>	Refer as KDB 789033, clause E Method SA-2 Alt. (RMS detection with slow sweep speed)
	Wideband RF power meter and average over on/off periods with duty factor
<input checked="" type="checkbox"/>	Refer as KDB 789033, clause E Method PM (using an RF average power meter).
<ul style="list-style-type: none"> ▪ For conducted measurement. 	
	<ul style="list-style-type: none"> ▪ If the EUT supports multiple transmit chains using options given below: Refer as KDB 662911, In-band power measurements. Using the measure-and-sum approach, measured all transmit ports individually. Sum the power (in linear power units e.g., mW) of all ports for each individual sample and save them.
	<ul style="list-style-type: none"> ▪ If multiple transmit chains, EIRP calculation could be following as methods: $P_{total} = P_1 + P_2 + \dots + P_n$ (calculated in linear unit [mW] and transfer to log unit [dBm]) $EIRP_{total} = P_{total} + DG$

3.3.4 Test Setup

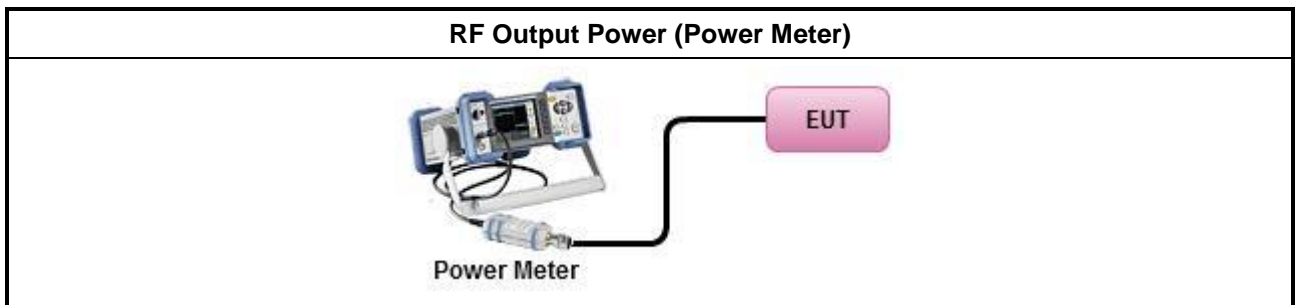

3.3.5 Test Result of Maximum Conducted Output Power

Refer as Appendix C

3.4 Peak Power Spectral Density

3.4.1 Peak Power Spectral Density Limit

Peak Power Spectral Density Limit	
UNII Devices	
<input checked="" type="checkbox"/> For the 5.15-5.25 GHz band:	
	<ul style="list-style-type: none"> ▪ Outdoor AP: the peak power spectral density (PPSD) shall not exceed the lesser of 17dBm/MHz. If $G_{TX} > 6$ dBi, then $P_{Out} = 17 - (G_{TX} - 6)$. ▪ Indoor AP: the peak power spectral density (PPSD) shall not exceed the lesser of 17dBm/MHz. If $G_{TX} > 6$ dBi, then $P_{Out} = 17 - (G_{TX} - 6)$. ▪ Point-to-point AP: the peak power spectral density (PPSD) shall not exceed the lesser of 17dBm/MHz. If $G_{TX} > 23$ dBi, then $P_{Out} = 17 - (G_{TX} - 23)$. ▪ Mobile or Portable Client: the peak power spectral density (PPSD) ≤ 11 dBm/MHz. If $G_{TX} > 6$ dBi, then $PPSD = 11 - (G_{TX} - 6)$.
<input type="checkbox"/> For the 5.25-5.35 GHz band, the peak power spectral density (PPSD) ≤ 11 dBm/MHz. If $G_{TX} > 6$ dBi, then $PPSD = 11 - (G_{TX} - 6)$.	
<input type="checkbox"/> For the 5.47-5.725 GHz band, the peak power spectral density (PPSD) ≤ 11 dBm/MHz. If $G_{TX} > 6$ dBi, then $PPSD = 11 - (G_{TX} - 6)$.	
<input checked="" type="checkbox"/> For the 5.725-5.85 GHz band:	
	<ul style="list-style-type: none"> ▪ Point-to-multipoint systems (P2M): the peak power spectral density (PPSD) ≤ 30 dBm/500kHz. If $G_{TX} > 6$ dBi, then $PPSD = 30 - (G_{TX} - 6)$. ▪ Point-to-point systems (P2P): the peak power spectral density (PPSD) ≤ 30 dBm/500kHz.
<p>PPSD = peak power spectral density that he same method as used to determine the conducted output power shall be used to determine the power spectral density. And power spectral density in dBm/MHz</p> <p>G_{TX} = the maximum transmitting antenna directional gain in dBi.</p>	

3.4.2 Measuring Instruments

Refer a test equipment and calibration data table in this test report.

3.4.3 Test Procedures

Test Method	
<ul style="list-style-type: none"> ▪ Peak power spectral density procedures that the same method as used to determine the conducted output power shall be used to determine the peak power spectral density and use the peak search function on the spectrum analyzer to find the peak of the spectrum. For the peak power spectral density shall be measured using below options: 	
<input type="checkbox"/>	Refer as KDB 789033, F)5) power spectral density can be measured using resolution bandwidths < 1 MHz provided that the results are integrated over 1 MHz bandwidth
Duty cycle ≥ 98%	
<input type="checkbox"/>	Refer as KDB 789033, clause E Method SA-2 (spectral trace averaging).
Duty cycle < 98%	
<input checked="" type="checkbox"/>	Refer as KDB 789033, clause E Method SA-2 Alt. (RMS detection with slow sweep speed)
<ul style="list-style-type: none"> ▪ For conducted measurement. 	
<ul style="list-style-type: none"> ▪ If the EUT supports multiple transmit chains using options given below: <ul style="list-style-type: none"> ▪ Measure and sum the spectra across the outputs. Refer as KDB 662911, In-band power spectral density (PSD). Sample all transmit ports simultaneously using a spectrum analyzer for each transmit port. Where the trace bin-by-bin of each transmit port summing can be performed. (i.e., in the first spectral bin of output 1 is summed with that in the first spectral bin of output 2 and that from the first spectral bin of output 3, and so on up to the NTX output to obtain the value for the first frequency bin of the summed spectrum.). Add up the amplitude (power) values for the different transmit chains and use this as the new data trace. ▪ If multiple transmit chains, EIRP PPSD calculation could be following as methods: $PPSD_{total} = PPSD_1 + PPSD_2 + \dots + PPSD_n$ (calculated in linear unit [mW] and transfer to log unit [dBm]) $EIRP_{total} = PPSD_{total} + DG$ 	

3.4.4 Test Setup

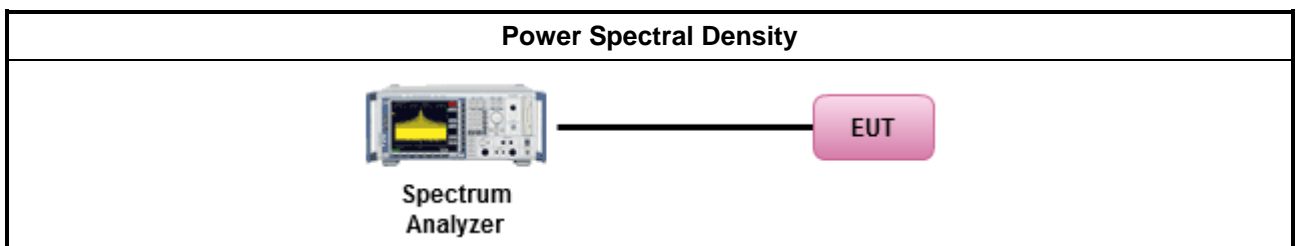

3.4.5 Test Result of Peak Power Spectral Density

Refer as Appendix D

3.5 Unwanted Emissions

3.5.1 Transmitter Radiated Unwanted Emissions Limit

Unwanted emissions below 1 GHz and restricted band emissions above 1GHz limit			
Frequency Range (MHz)	Field Strength (uV/m)	Field Strength (dBuV/m)	Measure Distance (m)
0.009~0.490	2400/F(kHz)	48.5 - 13.8	300
0.490~1.705	24000/F(kHz)	33.8 - 23	30
1.705~30.0	30	29	30
30~88	100	40	3
88~216	150	43.5	3
216~960	200	46	3
Above 960	500	54	3

Note 1: Test distance for frequencies at or above 30 MHz, measurements may be performed at a distance other than the limit distance provided they are not performed in the near field and the emissions to be measured can be detected by the measurement equipment. When performing measurements at a distance other than that specified, the results shall be extrapolated to the specified distance using an extrapolation factor of 20 dB/decade (inverse of linear distance for field-strength measurements, inverse of linear distance-squared for power-density measurements).

Note 2: Test distance for frequencies at below 30 MHz, measurements may be performed at a distance closer than the EUT limit distance; however, an attempt should be made to avoid making measurements in the near field. When performing measurements below 30 MHz at a closer distance than the limit distance, the results shall be extrapolated to the specified distance by either making measurements at a minimum of two or more distances on at least one radial to determine the proper extrapolation factor or by using the square of an inverse linear distance extrapolation factor (40 dB/decade). The test report shall specify the extrapolation method used to determine compliance of the EUT.

Note 3: Using the distance of 1m during the test for above 18 GHz, and the test value to correct for the distance factor at 3m.

Un-restricted band emissions above 1GHz Limit	
Operating Band	Limit
5.15 - 5.25 GHz	e.i.r.p. -27 dBm [68.2 dBuV/m@3m]
5.25 - 5.35 GHz	e.i.r.p. -27 dBm [68.2 dBuV/m@3m]
5.47 - 5.725 GHz	e.i.r.p. -27 dBm [68.2 dBuV/m@3m]
5.725 - 5.85 GHz	5.650-5700 GHz: e.i.r.p. -27 ~ 10 dBm [68.2 ~ 105.2 dBuV/m@3m] 5.700-5720 GHz: e.i.r.p. 10 ~ 15.6 dBm [105.2 ~ 110.8 dBuV/m@3m] 5.720-5725 GHz: e.i.r.p. 15.6 ~ 27 dBm [110.8 ~ 122.2 dBuV/m@3m] 5.850-5.855 GHz: e.i.r.p. 27 ~ 15.6 dBm [122.2 ~ 110.8 dBuV/m@3m] 5.855-5.875 GHz: e.i.r.p. 15.6 ~ 10 dBm [110.8 ~ 105.2 dBuV/m@3m] 5.875-5.925 GHz: e.i.r.p. 10 ~ -27 dBm [105.2 ~ 68.2dBuV/m@3m] Other un-restricted band: e.i.r.p. -27 dBm [68.2 dBuV/m@3m]

Note 1: Measurements may be performed at a distance other than the limit distance provided they are not performed in the near field and the emissions to be measured can be detected by the measurement equipment. When performing measurements at a distance other than that specified, the results shall be extrapolated to the specified distance using an extrapolation factor of 20 dB/decade (inverse of linear distance for field-strength measurements, inverse of linear distance-squared for power-density measurements).

3.5.2 Measuring Instruments

Refer a test equipment and calibration data table in this test report.

3.5.3 Test Procedures

Test Method	
<ul style="list-style-type: none"> ▪ Measurements may be performed at a distance other than the limit distance provided they are not performed in the near field and the emissions to be measured can be detected by the measurement equipment. Measurements shall not be performed at a distance greater than 30 m for frequencies above 30 MHz, unless it can be further demonstrated that measurements at a distance of 30 m or less are impractical. When performing measurements at a distance other than that specified, the results shall be extrapolated to the specified distance using an extrapolation factor of 20 dB/decade (inverse of linear distance for field-strength measurements, inverse of linear distance-squared for power-density measurements). 	
<ul style="list-style-type: none"> ▪ The average emission levels shall be measured in [duty cycle \geq 98 or duty factor]. 	
<ul style="list-style-type: none"> ▪ For the transmitter unwanted emissions shall be measured using following options below: 	
	<ul style="list-style-type: none"> ▪ Refer as KDB 789033, clause G)2) for unwanted emissions into non-restricted bands.
	<ul style="list-style-type: none"> ▪ Refer as KDB 789033, clause G)1) for unwanted emissions into restricted bands.
<input checked="" type="checkbox"/>	Refer as KDB 789033, G)6) Method VB (ANSI C63.10, clause 4.1.4.2.3), Reduced VBW.
<input checked="" type="checkbox"/>	Refer as KDB 789033, clause G)5) (ANSI C63.10, clause 4.1.4.2.2), measurement procedure peak limit.
<ul style="list-style-type: none"> ▪ For radiated measurement. 	
	<ul style="list-style-type: none"> ▪ Refer as ANSI C63.10, clause 6.4 for radiated emissions below 30 MHz and test distance is 3m.
	<ul style="list-style-type: none"> ▪ Refer as ANSI C63.10, clause 6.5 for radiated emissions 30 MHz to 1 GHz and test distance is 3m.
	<ul style="list-style-type: none"> ▪ Refer as ANSI C63.10, clause 6.6 for radiated emissions above 1GHz.
<ul style="list-style-type: none"> ▪ The any unwanted emissions level shall not exceed the fundamental emission level. 	
<ul style="list-style-type: none"> ▪ All amplitude of spurious emissions that are attenuated by more than 20 dB below the permissible value has no need to be reported. 	
<ul style="list-style-type: none"> ▪ Use the following spectrum analyzer settings: 	
	<ul style="list-style-type: none"> ▪ Set RBW=100 kHz for $f < 1$ GHz; VBW=3 * RBW; Sweep = auto; Detector function = peak; Trace = max hold.
	<ul style="list-style-type: none"> ▪ Set RBW = 1 MHz, VBW= 3MHz for $f \geq 1$ GHz for peak measurement. For average measurement, refer as 1.1.4.
<ul style="list-style-type: none"> ▪ KDB 414788 Open-Field Test Sites and Chamber Correlation Justification. 	
	<ul style="list-style-type: none"> ▪ Based on FCC 15.31 (f) (2): measurements may be performed at a distance closer than that specified in regulations; however, an attempt should be made to avoid making measurements in the near field.
	<ul style="list-style-type: none"> ▪ Open-field site and chamber correlation testing had been performed and chamber measured test result is the worst case test result.

3.5.4 Test Setup

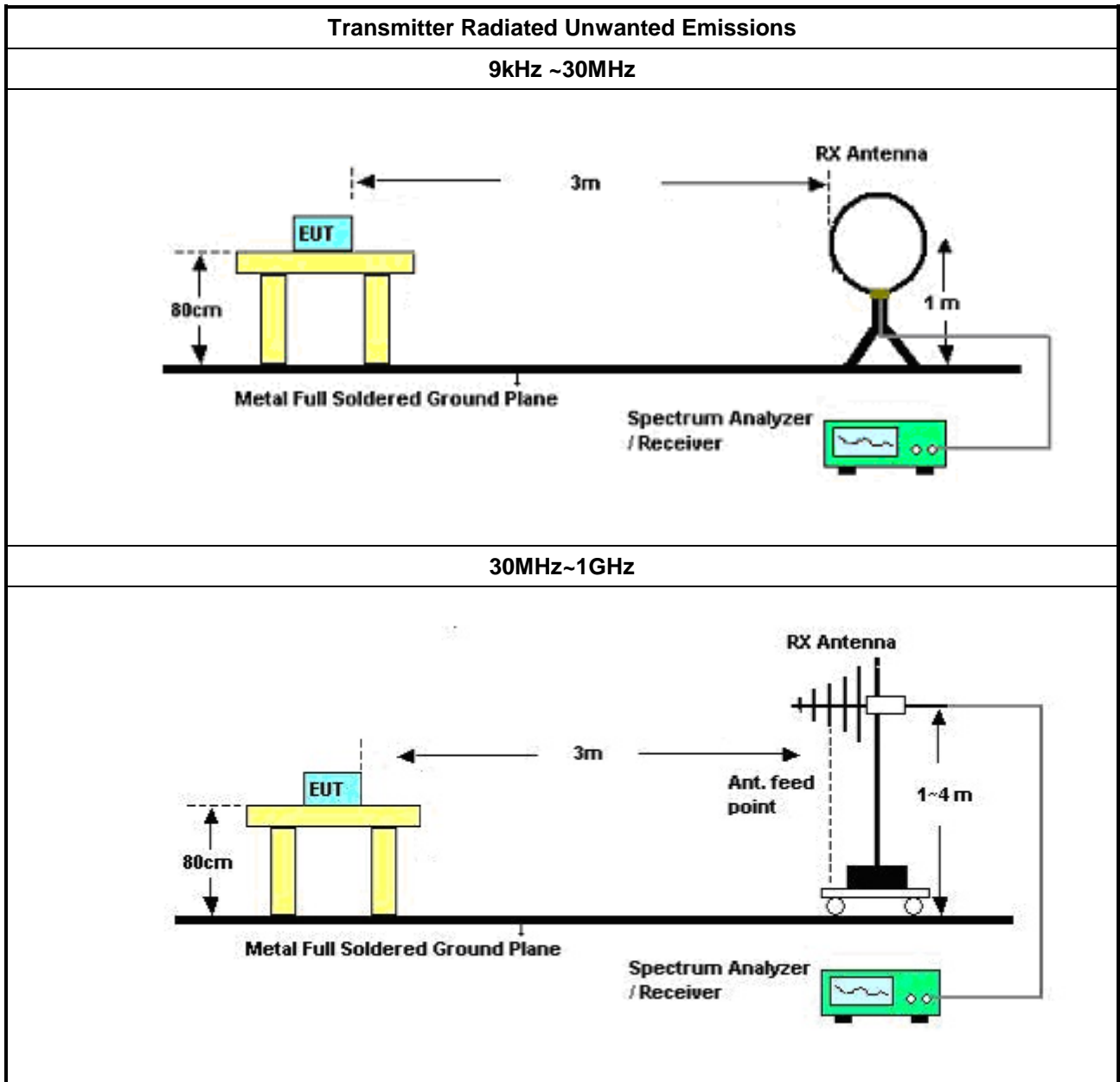

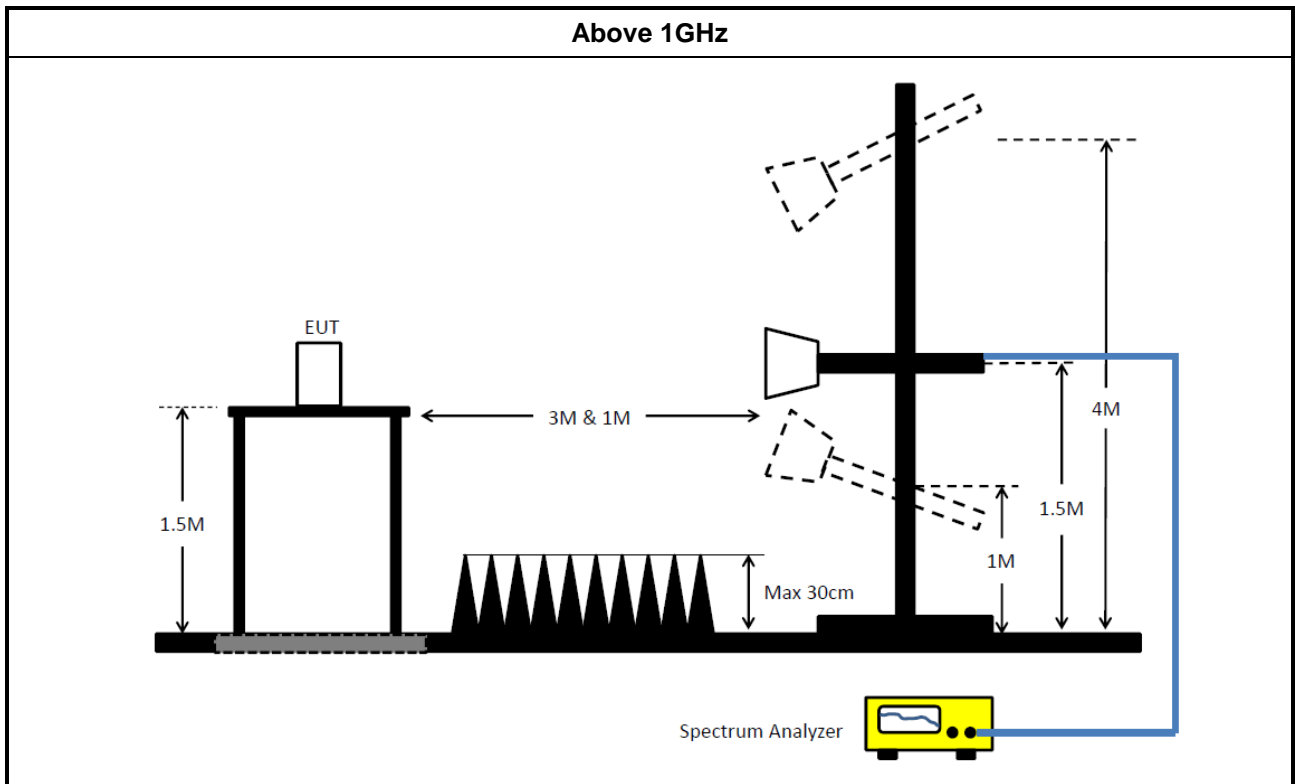

3.5.5 Transmitter Unwanted Emissions (Below 30MHz)

The amplitude of spurious emissions which are attenuated by more than 20dB below the permissible value has no need to be reported.

3.5.6 Test Result of Transmitter Unwanted Emissions

Refer as Appendix E



4 Test Equipment and Calibration Data

Instrument for AC Conduction

Instrument	Manufacturer	Model No.	Serial No.	Spec.	Calibration Date	Calibration Due Date
EMC Receiver	R&S	ESR3	102052	9kHz ~ 3.6GHz	09/Apr/2020	08/Apr/2021
LISN	R&S	ENV216	101295	9kHz ~ 30MHz	04/Nov/2019	05/Nov/2020
RF Cable-CON	MTJ	RG142	CB002-CO	9kHz ~ 200MHz	12/Sep/2019	11/Sep/2020
AC POWER	APC	AFC-11005G	F310050055	47Hz~63Hz 5~300V	NCR	NCR
Impuls Begrenzer Pulse Limiter	SCHWARZBECK	VTSD 9561-F	9561-F041	9 kHz ~ 30 MHz	24/Sep/2019	23/Sep/2020

NCR : Non-Calibration Require

Instrument for Conducted Test

Instrument	Manufacturer	Model No.	Serial No.	Spec.	Calibration Date	Calibration Due Date
Spectrum Analyzer	R&S	FSV 40	101013	10Hz~40GHz	19/Mar/2020	18/Mar/2021
Pulse Power Sensor	Anritsu	MA2411B	0917017	300MHz ~ 40GHz	17/Feb/2020	16/Feb/2021
Power Meter	Anritsu	ML2495A	0949003	300MHz ~ 40GHz	17/Feb/2020	16/Feb/2021
SMB100A Signal Generator	R&S	SMB100A03	181147	100kHz~40GHz	12/Nov/2018	10/Nov/2020

**Instrument for Radiated Test**

Instrument	Manufacturer	Model No.	Serial No.	Spec.	Calibration Date	Calibration Due Date
3m Semi Anechoic Chamber	SIDT FRANKONIA	SAC-3M	03CH03-HY	30MHz ~ 1GHz 3m	30/Aug/2019	29/Aug/2020
3m Semi Anechoic Chamber	SIDT FRANKONIA	SAC-3M	03CH03-HY	1GHz ~ 18GHz 3m	30/Aug/2019	29/Aug/2020
Amplifier	HP	8447D	2944A08033	10kHz ~ 1.3GHz	14/Apr/2020	13/Apr/2021
EMC Receiver	R&S	ESR3	102052	9kHz ~ 3.6GHz	09/Apr/2020	08/Apr/2021
Bilog Antenna & 6dB Attenuator	SCHAFFNER / EMCI	CBL6112B / N-6-05	22237 / AT-N-0603	30 MHz ~ 1 GHz	19/Apr/2020	18/Apr/2021
Microwave System Preamplifier	KEYSIGHT	83017A	MY53270196	1GHz ~ 26.5GHz	09/Sep/2019	08/Sep/2020
Signal Analyzer	R&S	FSV40	101500	10Hz ~ 40GHz	15/Aug/2019	14/Aug/2020
RF Cable-R03m	Jye Bao	RG142	CB021	9kHz ~ 1GHz	18/Mar/2020	17/Mar/2021
RF CABLE 5+6m	HUBER+SUHNER	SUOFLEX 104	SN 805801/4+SN 804300/4	1GHz ~ 40GHz	18/Mar/2020	17/Mar/2021
Broadband Horn Antenna	SCHWARZBECK	BBHA 9170	BBHA 9170221	18GHz~40GHz	13/Mar/2020	12/Mar/2021
Double Ridged Guide Horn Antenna	SCHWARZBECK	BBHA 9120 D	BBHA 9120 D 1531	1GHz ~ 18GHz	26/Mar/2020	25/Mar/2021
Preamplifier	MITEQ	TTA1840-35-HG	1864481	18GHz ~ 40GHz	10/Mar/2020	09/Mar/2021
Loop Antenna	TESEQ	HLA 6120	31244	9kHz ~ 30MHz	16/Mar/2020	15/Mar/2021

AC Power-line Conducted Emissions Result

Operating Mode	1	Power Phase	Neutral
Operating Function	AC Adapter mode (DSA-12PFU-05 FCA)		

27/05/2020

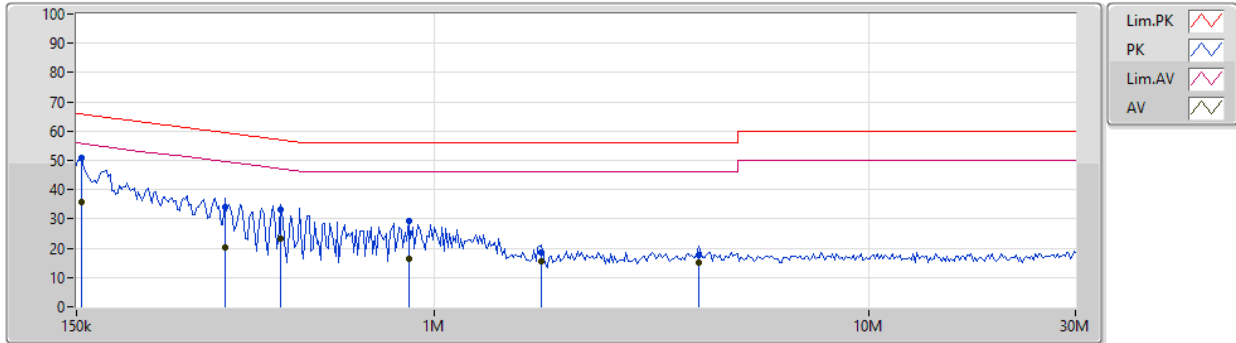

Type	Freq (Hz)	Level (dBuV)	Limit (dBuV)	Margin (dB)	Factor (dB)	Condition	Comment	Raw (dBuV)	LISN (dB)	CL (dB)	AT (dB)
QP	154.545k	50.77	65.75	-14.98	19.63	Neutral	"Worst"	31.14	9.65	0.11	9.87
AV	154.545k	35.86	55.75	-19.89	19.63	Neutral	-	16.23	9.65	0.11	9.87
QP	329.215k	33.99	59.48	-25.49	19.62	Neutral	-	14.37	9.63	0.12	9.87
AV	329.215k	20.06	49.48	-29.42	19.62	Neutral	-	0.44	9.63	0.12	9.87
QP	443.732k	33.34	56.99	-23.65	19.63	Neutral	-	13.71	9.63	0.13	9.87
AV	443.732k	23.40	46.99	-23.59	19.63	Neutral	-	3.77	9.63	0.13	9.87
QP	872.92k	29.10	56.00	-26.90	19.61	Neutral	-	9.49	9.63	0.11	9.87
AV	872.92k	16.37	46.00	-29.63	19.61	Neutral	-	-3.24	9.63	0.11	9.87
QP	1.769M	18.61	56.00	-37.39	19.66	Neutral	-	-1.05	9.65	0.14	9.87
AV	1.769M	15.47	46.00	-30.53	19.66	Neutral	-	-4.19	9.65	0.14	9.87
QP	4.081M	17.51	56.00	-38.49	19.73	Neutral	-	-2.22	9.66	0.19	9.88
AV	4.081M	14.97	46.00	-31.03	19.73	Neutral	-	-4.76	9.66	0.19	9.88



AC Power-line Conducted Emissions Result

Operating Mode	1	Power Phase	Line
Operating Function	AC Adapter mode (DSA-12PFU-05 FCA)		

27/05/2020

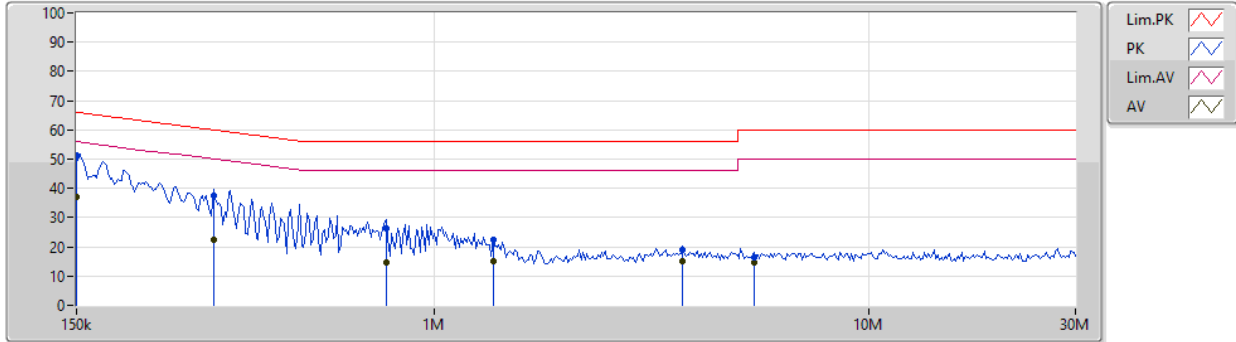

Type	Freq (Hz)	Level (dBuV)	Limit (dBuV)	Margin (dB)	Factor (dB)	Condition	Comment	Raw (dBuV)	LISN (dB)	CL (dB)	AT (dB)
QP	150k	51.18	66.00	-14.82	19.64	Line	"Worst"	31.54	9.66	0.11	9.87
AV	150k	36.90	56.00	-19.10	19.64	Line	-	17.26	9.66	0.11	9.87
QP	310.136k	37.44	59.96	-22.52	19.63	Line	-	17.81	9.64	0.12	9.87
AV	310.136k	22.23	49.96	-27.73	19.63	Line	-	2.60	9.64	0.12	9.87
QP	774.672k	26.39	56.00	-29.61	19.63	Line	-	6.76	9.64	0.12	9.87
AV	774.672k	14.73	46.00	-31.27	19.63	Line	-	-4.90	9.64	0.12	9.87
QP	1.366M	22.49	56.00	-33.51	19.65	Line	-	2.84	9.64	0.13	9.88
AV	1.366M	14.93	46.00	-31.07	19.65	Line	-	-4.72	9.64	0.13	9.88
QP	3.732M	18.90	56.00	-37.10	19.72	Line	-	-0.82	9.66	0.18	9.88
AV	3.732M	15.23	46.00	-30.77	19.72	Line	-	-4.49	9.66	0.18	9.88
QP	5.446M	16.59	60.00	-43.41	19.76	Line	-	-3.17	9.67	0.21	9.88
AV	5.446M	14.58	50.00	-35.42	19.76	Line	-	-5.18	9.67	0.21	9.88



AC Power-line Conducted Emissions Result

Operating Mode	2	Power Phase	Neutral
Operating Function	AC Adapter mode (DSA-12PFU-05 FUS)		

27/05/2020

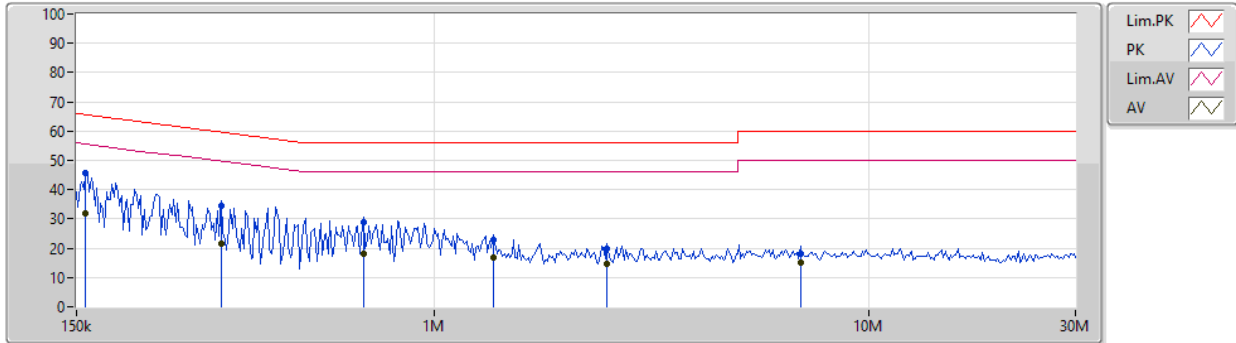

Type	Freq (Hz)	Level (dBuV)	Limit (dBuV)	Margin (dB)	Factor (dB)	Condition	Comment	Raw (dBuV)	LISN (dB)	CL (dB)	AT (dB)
QP	157.652k	45.67	65.58	-19.91	19.63	Neutral	"Worst"	26.04	9.65	0.11	9.87
AV	157.652k	31.89	55.58	-23.69	19.63	Neutral	-	12.26	9.65	0.11	9.87
QP	322.728k	34.64	59.63	-24.99	19.62	Neutral	-	15.02	9.63	0.12	9.87
AV	322.728k	21.60	49.63	-28.03	19.62	Neutral	-	1.98	9.63	0.12	9.87
QP	687.482k	28.84	56.00	-27.16	19.62	Neutral	-	9.22	9.63	0.12	9.87
AV	687.482k	18.24	46.00	-27.76	19.62	Neutral	-	-1.38	9.63	0.12	9.87
QP	1.366M	22.78	56.00	-33.22	19.65	Neutral	-	3.13	9.64	0.13	9.88
AV	1.366M	16.85	46.00	-29.15	19.65	Neutral	-	-2.80	9.64	0.13	9.88
QP	2.506M	19.73	56.00	-36.27	19.68	Neutral	-	0.05	9.65	0.16	9.87
AV	2.506M	14.75	46.00	-31.25	19.68	Neutral	-	-4.93	9.65	0.16	9.87
QP	6.985M	17.99	60.00	-42.01	19.79	Neutral	-	-1.80	9.68	0.23	9.88
AV	6.985M	15.15	50.00	-34.85	19.79	Neutral	-	-4.64	9.68	0.23	9.88



AC Power-line Conducted Emissions Result

Operating Mode	2	Power Phase	Line
Operating Function	AC Adapter mode (DSA-12PFU-05 FUS)		

27/05/2020

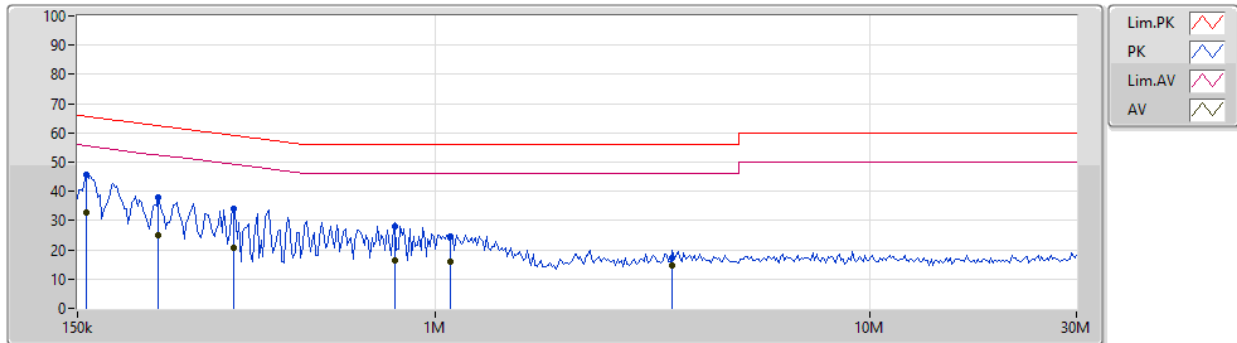

Type	Freq (Hz)	Level (dBuV)	Limit (dBuV)	Margin (dB)	Factor (dB)	Condition	Comment	Raw (dBuV)	LISN (dB)	CL (dB)	AT (dB)
QP	157.652k	45.87	65.58	-19.71	19.64	Line	"Worst"	26.23	9.66	0.11	9.87
AV	157.652k	32.56	55.58	-23.02	19.64	Line	-	12.92	9.66	0.11	9.87
QP	230.097k	38.12	62.44	-24.32	19.64	Line	-	18.48	9.65	0.12	9.87
AV	230.097k	24.82	52.44	-27.62	19.64	Line	-	5.18	9.65	0.12	9.87
QP	342.583k	33.90	59.14	-25.24	19.63	Line	-	14.27	9.64	0.12	9.87
AV	342.583k	20.57	49.14	-28.57	19.63	Line	-	0.94	9.64	0.12	9.87
QP	806.127k	28.13	56.00	-27.87	19.63	Line	-	8.50	9.64	0.12	9.87
AV	806.127k	16.36	46.00	-29.64	19.63	Line	-	-3.27	9.64	0.12	9.87
QP	1.087M	24.61	56.00	-31.39	19.63	Line	-	4.98	9.64	0.11	9.88
AV	1.087M	15.88	46.00	-30.12	19.63	Line	-	-3.75	9.64	0.11	9.88
QP	3.515M	17.10	56.00	-38.90	19.72	Line	-	-2.62	9.66	0.18	9.88
AV	3.515M	14.61	46.00	-31.39	19.72	Line	-	-5.11	9.66	0.18	9.88



AC Power-line Conducted Emissions Result

Operating Mode	3	Power Phase	Neutral
Operating Function	AC Adapter mode (DSA-12PFU-05 FCA)		

27/05/2020

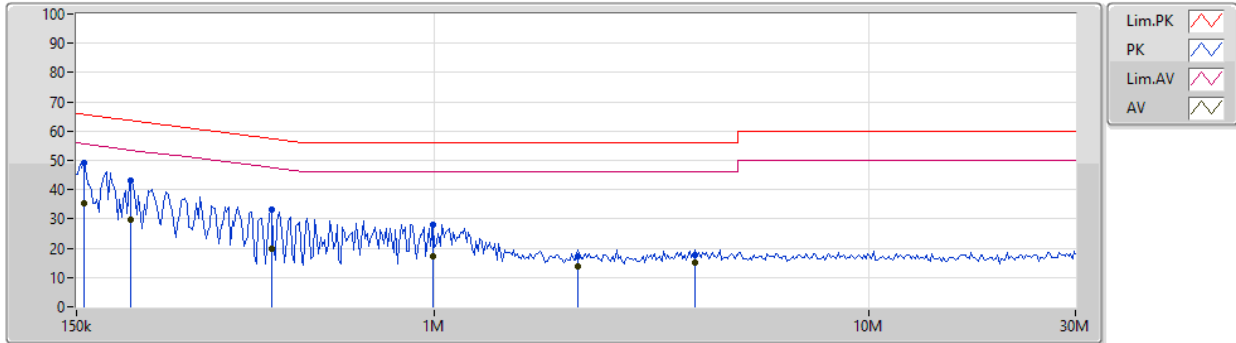

Type	Freq (Hz)	Level (dBuV)	Limit (dBuV)	Margin (dB)	Factor (dB)	Condition	Comment	Raw (dBuV)	LISN (dB)	CL (dB)	AT (dB)
QP	156.091k	49.01	65.67	-16.66	19.63	Neutral	"Worst"	29.38	9.65	0.11	9.87
AV	156.091k	35.29	55.67	-20.38	19.63	Neutral	-	15.66	9.65	0.11	9.87
QP	200.176k	43.27	63.61	-20.34	19.62	Neutral	-	23.65	9.64	0.11	9.87
AV	200.176k	29.64	53.61	-23.97	19.62	Neutral	-	10.02	9.64	0.11	9.87
QP	422.196k	33.20	57.40	-24.20	19.63	Neutral	-	13.57	9.63	0.13	9.87
AV	422.196k	19.68	47.40	-27.72	19.63	Neutral	-	0.05	9.63	0.13	9.87
QP	993.464k	27.87	56.00	-28.13	19.62	Neutral	-	8.25	9.63	0.11	9.88
AV	993.464k	17.09	46.00	-28.91	19.62	Neutral	-	-2.53	9.63	0.11	9.88
QP	2.137M	17.19	56.00	-38.81	19.67	Neutral	-	-2.48	9.65	0.15	9.87
AV	2.137M	14.00	46.00	-32.00	19.67	Neutral	-	-5.67	9.65	0.15	9.87
QP	4.001M	17.65	56.00	-38.35	19.73	Neutral	-	-2.08	9.66	0.19	9.88
AV	4.001M	15.08	46.00	-30.92	19.73	Neutral	-	-4.65	9.66	0.19	9.88



AC Power-line Conducted Emissions Result

Operating Mode	3	Power Phase	Line
Operating Function	AC Adapter mode (DSA-12PFU-05 FCA)		

27/05/2020

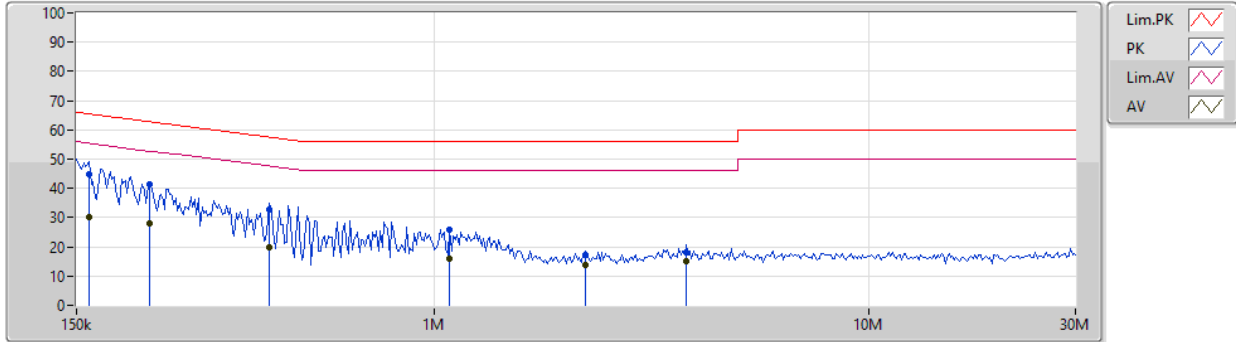

Type	Freq (Hz)	Level (dBuV)	Limit (dBuV)	Margin (dB)	Factor (dB)	Condition	Comment	Raw (dBuV)	LISN (dB)	CL (dB)	AT (dB)
QP	160.82k	44.92	65.43	-20.51	19.64	Line	"Worst"	25.28	9.66	0.11	9.87
AV	160.82k	30.31	55.43	-25.12	19.64	Line	-	10.67	9.66	0.11	9.87
QP	221.118k	41.39	62.77	-21.38	19.63	Line	-	21.76	9.65	0.11	9.87
AV	221.118k	27.99	52.77	-24.78	19.63	Line	-	8.36	9.65	0.11	9.87
QP	418.016k	32.63	57.49	-24.86	19.64	Line	-	12.99	9.64	0.13	9.87
AV	418.016k	19.81	47.49	-27.68	19.64	Line	-	0.17	9.64	0.13	9.87
QP	1.087M	26.07	56.00	-29.93	19.63	Line	-	6.44	9.64	0.11	9.88
AV	1.087M	16.01	46.00	-29.99	19.63	Line	-	-3.62	9.64	0.11	9.88
QP	2.224M	17.21	56.00	-38.79	19.67	Line	-	-2.46	9.65	0.15	9.87
AV	2.224M	13.65	46.00	-32.35	19.67	Line	-	-6.02	9.65	0.15	9.87
QP	3.807M	18.22	56.00	-37.78	19.72	Line	-	-1.50	9.66	0.18	9.88
AV	3.807M	15.25	46.00	-30.75	19.72	Line	-	-4.47	9.66	0.18	9.88



AC Power-line Conducted Emissions Result

Operating Mode	4	Power Phase	Neutral
Operating Function	AC Adapter mode (DSA-12PFU-05 FUS)		

27/05/2020

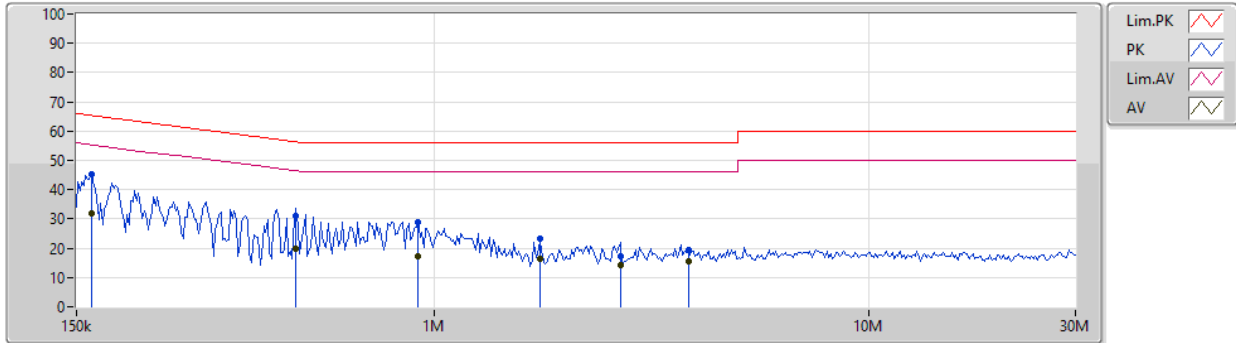

Type	Freq (Hz)	Level (dBuV)	Limit (dBuV)	Margin (dB)	Factor (dB)	Condition	Comment	Raw (dBuV)	LISN (dB)	CL (dB)	AT (dB)
QP	162.429k	45.12	65.33	-20.21	19.63	Neutral	"Worst"	25.49	9.65	0.11	9.87
AV	162.429k	31.75	55.33	-23.58	19.63	Neutral	-	12.12	9.65	0.11	9.87
QP	480.498k	31.24	56.33	-25.09	19.63	Neutral	-	11.61	9.63	0.13	9.87
AV	480.498k	19.94	46.33	-26.39	19.63	Neutral	-	0.31	9.63	0.13	9.87
QP	917.448k	29.06	56.00	-26.94	19.62	Neutral	-	9.44	9.63	0.11	9.88
AV	917.448k	17.37	46.00	-28.63	19.62	Neutral	-	-2.25	9.63	0.11	9.88
QP	1.752M	23.12	56.00	-32.88	19.66	Neutral	-	3.46	9.65	0.14	9.87
AV	1.752M	16.42	46.00	-29.58	19.66	Neutral	-	-3.24	9.65	0.14	9.87
QP	2.687M	17.05	56.00	-38.95	19.69	Neutral	-	-2.64	9.65	0.17	9.87
AV	2.687M	14.09	46.00	-31.91	19.69	Neutral	-	-5.60	9.65	0.17	9.87
QP	3.845M	19.37	56.00	-36.63	19.73	Neutral	-	-0.36	9.66	0.19	9.88
AV	3.845M	15.56	46.00	-30.44	19.73	Neutral	-	-4.17	9.66	0.19	9.88



AC Power-line Conducted Emissions Result

Operating Mode	4	Power Phase	Line
Operating Function	AC Adapter mode (DSA-12PFU-05 FUS)		

27/05/2020

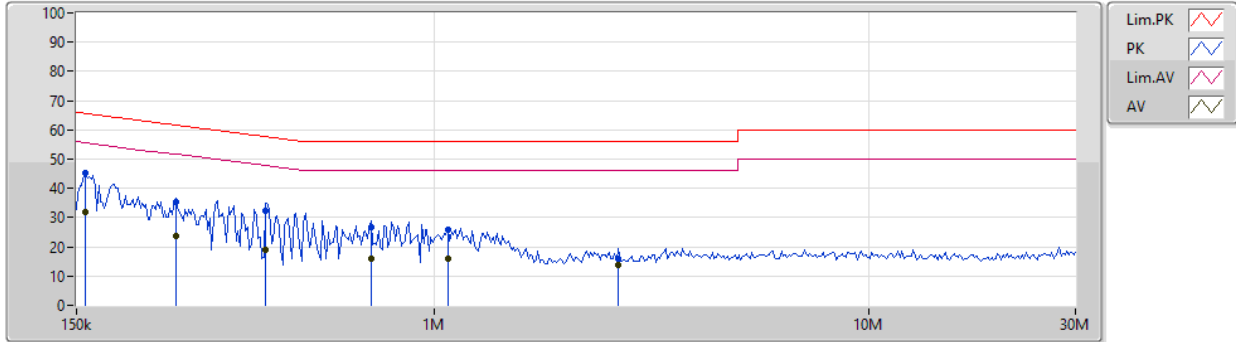

Type	Freq (Hz)	Level (dBuV)	Limit (dBuV)	Margin (dB)	Factor (dB)	Condition	Comment	Raw (dBuV)	LISN (dB)	CL (dB)	AT (dB)
QP	157.652k	45.23	65.58	-20.35	19.64	Line	"Worst"	25.59	9.66	0.11	9.87
AV	157.652k	31.69	55.58	-23.89	19.64	Line	-	12.05	9.66	0.11	9.87
QP	254.17k	35.45	61.62	-26.17	19.64	Line	-	15.81	9.65	0.12	9.87
AV	254.17k	23.51	51.62	-28.11	19.64	Line	-	3.87	9.65	0.12	9.87
QP	409.779k	32.31	57.64	-25.33	19.64	Line	-	12.67	9.64	0.13	9.87
AV	409.779k	19.09	47.64	-28.55	19.64	Line	-	-0.55	9.64	0.13	9.87
QP	715.397k	26.75	56.00	-29.25	19.63	Line	-	7.12	9.64	0.12	9.87
AV	715.397k	15.76	46.00	-30.24	19.63	Line	-	-3.87	9.64	0.12	9.87
QP	1.076M	25.73	56.00	-30.27	19.63	Line	-	6.10	9.64	0.11	9.88
AV	1.076M	16.09	46.00	-29.91	19.63	Line	-	-3.54	9.64	0.11	9.88
QP	2.661M	16.15	56.00	-39.85	19.68	Line	-	-3.53	9.65	0.16	9.87
AV	2.661M	13.82	46.00	-32.18	19.68	Line	-	-5.86	9.65	0.16	9.87



Summary

Mode	Max-N dB (Hz)	Max-OBW (Hz)	ITU-Code	Min-N dB (Hz)	Min-OBW (Hz)
5.15-5.25GHz	-	-	-	-	-
802.11ac VHT80_Nss1,(MCS0)_2TX	81.48M	75.13M	75M1D1D	81.36M	75.034M
5.725-5.85GHz	-	-	-	-	-
802.11ac VHT80_Nss1,(MCS0)_2TX	75.12M	75.61M	75M6D1D	74.88M	75.514M

Max-N dB = Maximum 6dB down bandwidth for 5.725-5.85GHz band / Maximum 26dB down bandwidth for other band;

Max-OBW = Maximum 99% occupied bandwidth;

Min-N dB = Minimum 6dB down bandwidth for 5.725-5.85GHz band / Maximum 26dB down bandwidth for other band;

Min-OBW = Minimum 99% occupied bandwidth;



Result

Mode	Result	Limit (Hz)	Port 1-N dB (Hz)	Port 1-OBW (Hz)	Port 2-N dB (Hz)	Port 2-OBW (Hz)
802.11ac VHT80_Nss1,(MCS0)_2TX	-	-	-	-	-	-
5210MHz_TnomVnom	Pass	Inf	81.36M	75.034M	81.48M	75.13M
5775MHz_TnomVnom	Pass	500k	74.88M	75.514M	75.12M	75.61M

Port X-N dB = Port X 6dB down bandwidth for 5.725-5.85GHz band / 26dB down bandwidth for other band

Port X-OBW = Port X 99% occupied bandwidth;

802.11ac VHT80_Nss1,(MCS0)_2TX

EBW

5210MHz

25/05/2020

CF: 5.21GHz
 Span: 240MHz
 RBW: 1MHz
 VBW: 3MHz
 Sweep Time: 100ms
 Detector Type: Peak

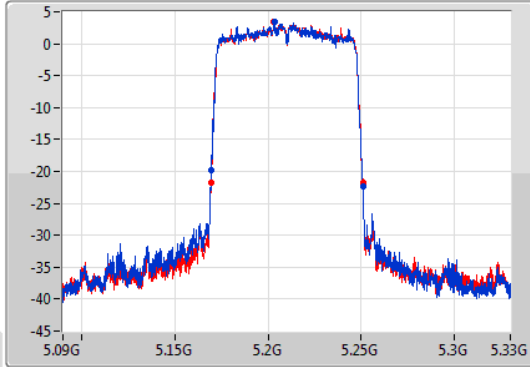

CF: 5.21GHz
 Span: 192MHz
 RBW: 1MHz
 VBW: 3MHz
 Sweep Time: 100ms
 Detector Type: Sample

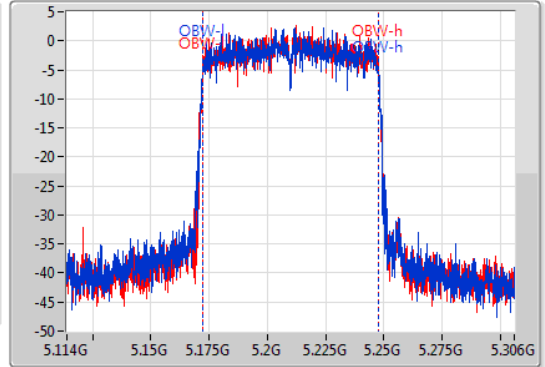

26dB(Hz)	Fl-26dB(Hz)	Fh-26dB(Hz)	OBW(Hz)	Fl-OBW(Hz)	Fh-OBW(Hz)	Limit(Hz)	Port
81.36M	5.16944G	5.2508G	75.034M	5.172483G	5.247517G	Inf	1
81.48M	5.16932G	5.2508G	75.13M	5.172483G	5.247613G	Inf	2

802.11ac VHT80_Nss1,(MCS0)_2TX

EBW

5775MHz

29/05/2020

CF: 5.775GHz
 Span: 240MHz
 RBW: 100kHz
 VBW: 300kHz
 Sweep Time: 100ms
 Detector Type: Peak

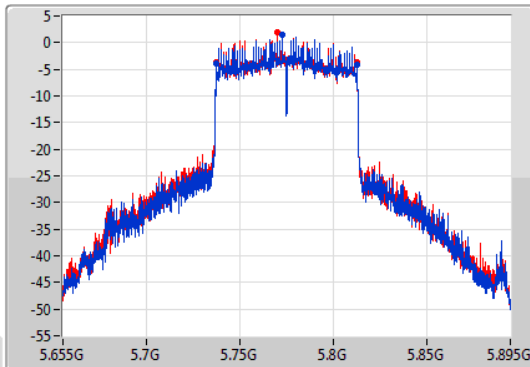

CF: 5.775GHz
 Span: 192MHz
 RBW: 1MHz
 VBW: 3MHz
 Sweep Time: 100ms
 Detector Type: Sample

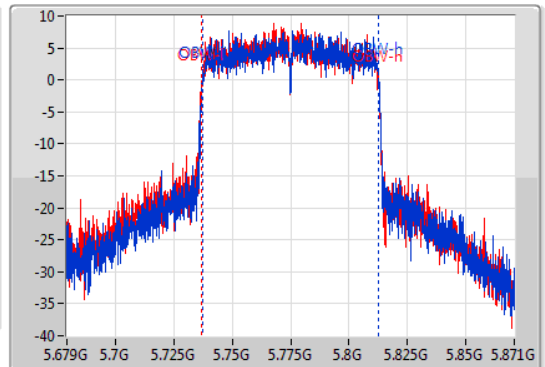

6dB(Hz)	Fl-6dB(Hz)	Fh-6dB(Hz)	OBW(Hz)	Fl-OBW(Hz)	Fh-OBW(Hz)	Limit(Hz)	Port
74.88M	5.73756G	5.81244G	75.514M	5.737195G	5.812709G	500k	1
75.12M	5.73744G	5.81256G	75.61M	5.736907G	5.812517G	500k	2



Summary

Mode	Max-N dB (Hz)	Max-OBW (Hz)	ITU-Code	Min-N dB (Hz)	Min-OBW (Hz)
5.15-5.25GHz	-	-	-	-	-
802.11ac VHT80_Nss1,(MCS0)_2TX	81.48M	75.034M	75MOD1D	81.24M	75.034M
5.725-5.85GHz	-	-	-	-	-
802.11ac VHT80_Nss1,(MCS0)_2TX	75.12M	75.418M	75M4D1D	75.12M	75.322M

Max-N dB = Maximum 6dB down bandwidth for 5.725-5.85GHz band / Maximum 26dB down bandwidth for other band;

Max-OBW = Maximum 99% occupied bandwidth;

Min-N dB = Minimum 6dB down bandwidth for 5.725-5.85GHz band / Maximum 26dB down bandwidth for other band;

Min-OBW = Minimum 99% occupied bandwidth;



Result

Mode	Result	Limit (Hz)	Port 1-N dB (Hz)	Port 1-OBW (Hz)	Port 2-N dB (Hz)	Port 2-OBW (Hz)
802.11ac VHT80_Nss1,(MCS0)_2TX	-	-	-	-	-	-
5210MHz_TnomVnom	Pass	Inf	81.24M	75.034M	81.48M	75.034M
5775MHz_TnomVnom	Pass	500k	75.12M	75.322M	75.12M	75.418M

Port X-N dB = Port X 6dB down bandwidth for 5.725-5.85GHz band / 26dB down bandwidth for other band

Port X-OBW = Port X 99% occupied bandwidth;

802.11ac VHT80_Nss1,(MCS0)_2TX

EBW

5210MHz

25/05/2020

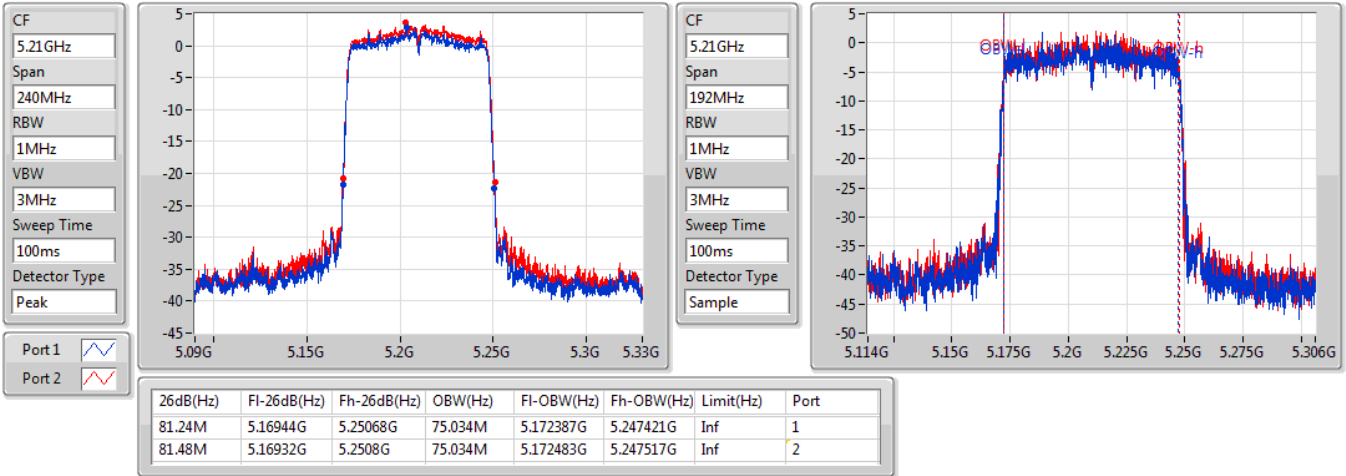

802.11ac VHT80_Nss1,(MCS0)_2TX

EBW

5775MHz

29/05/2020

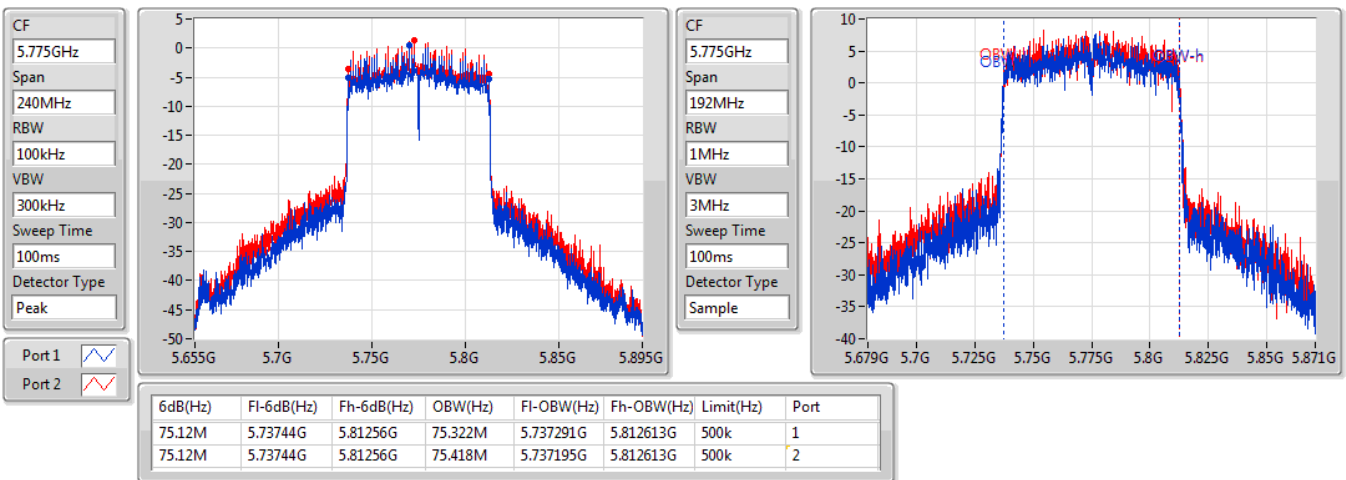



Summary

Mode	Total Power (dBm)	Total Power (W)	EIRP (dBm)	EIRP (W)
5.15-5.25GHz	-	-	-	-
802.11ac VHT80_Nss1,(MCS0)_2TX	14.30	0.02692	19.30	0.08511
5.725-5.85GHz	-	-	-	-
802.11ac VHT80_Nss1,(MCS0)_2TX	20.29	0.10691	25.29	0.33806



Result

Mode	Result	DG (dBi)	Port 1 (dBm)	Port 2 (dBm)	Total Power (dBm)	Power Limit (dBm)	EIRP (dBm)	EIRP Limit (dBm)
802.11ac VHT80_Nss1,(MCS0)_2TX	-	-	-	-	-	-	-	-
5210MHz_TnomVnom	Pass	5.00	11.17	11.40	14.30	30.00	19.30	53.00
5775MHz_TnomVnom	Pass	5.00	17.25	17.31	20.29	30.00	25.29	Inf

DG = Directional Gain; Port X = Port X output power



Summary

Mode	Total Power (dBm)	Total Power (W)	EIRP (dBm)	EIRP (W)
5.15-5.25GHz	-	-	-	-
802.11ac VHT80_Nss1,(MCS0)_2TX	14.15	0.02600	19.15	0.08222
5.725-5.85GHz	-	-	-	-
802.11ac VHT80_Nss1,(MCS0)_2TX	19.68	0.09290	24.68	0.29376



Result

Mode	Result	DG (dBi)	Port 1 (dBm)	Port 2 (dBm)	Total Power (dBm)	Power Limit (dBm)	EIRP (dBm)	EIRP Limit (dBm)
802.11ac VHT80_Nss1,(MCS0)_2TX	-	-	-	-	-	-	-	-
5210MHz_TnomVnom	Pass	5.00	10.72	11.53	14.15	30.00	19.15	53.00
5775MHz_TnomVnom	Pass	5.00	16.21	17.09	19.68	30.00	24.68	Inf

DG = Directional Gain; Port X = Port X output power



Summary

Mode	PD (dBm/RBW)	EIRP PD (dBm/RBW)
5.15-5.25GHz	-	-
802.11ac VHT80_Nss1,(MCS0)_2TX	-3.55	4.46
5.725-5.85GHz	-	-
802.11ac VHT80_Nss1,(MCS0)_2TX	1.30	9.31

RBW = 500 kHz for 5.725-5.85GHz band / 1MHz for other band;



Result

Mode	Result	DG (dBi)	Port 1 (dBm/RBW)	Port 2 (dBm/RBW)	PD (dBm/RBW)	PD Limit (dBm/RBW)	EIRP PD (dBm/RBW)	EIRP PD Limit (dBm/RBW)
802.11ac VHT80_Nss1,(MCS0)_2TX	-	-	-	-	-	-	-	-
5210MHz_TnomVnom	Pass	8.01	-6.51	-6.32	-3.55	17.00	4.46	40.00
5775MHz_TnomVnom	Pass	8.01	-1.54	-1.38	1.30	30.00	9.31	30.00

DG = Directional Gain; RBW = 500 kHz for 5.725-5.85GHz band / 1MHz for other band;

PD = trace bin-by-bin of each transmits port summing can be performed maximum power density; Port X = Port X power density;

802.11ac VHT80_Nss1,(MCS0)_2TX

PSD

5210MHz

25/05/2020

CF
5.21GHz
Span
120MHz
RBW
1MHz
VBW
3MHz
Sweep Time
20ms
Detector Type
RMS

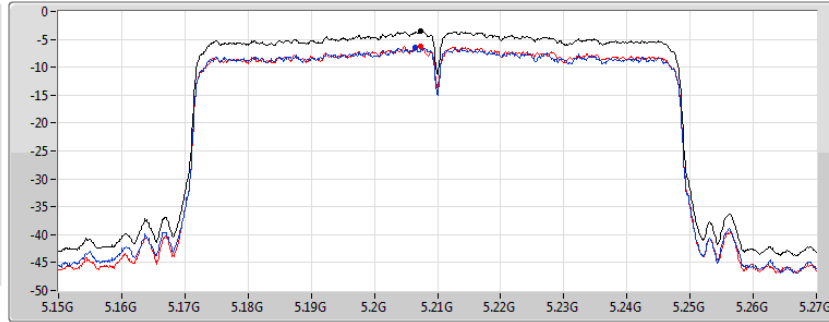

Sum
Port 1
Port 2

Sum	PD	Port 1	Port 2
(dBm/RBW)	(dBm/RBW)	(dBm/RBW)	(dBm/RBW)
-3.55	-3.55	-6.51	-6.32

802.11ac VHT80_Nss1,(MCS0)_2TX

PSD

5775MHz

29/05/2020

CF
5.775GHz
Span
120MHz
RBW
500kHz
VBW
3MHz
Sweep Time
20ms
Detector Type
RMS

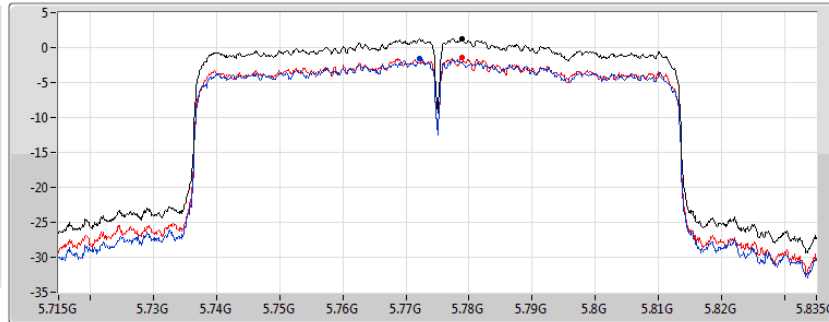

Sum
Port 1
Port 2

Sum	PD	Port 1	Port 2
(dBm/RBW)	(dBm/RBW)	(dBm/RBW)	(dBm/RBW)
1.30	1.30	-1.54	-1.38



Summary

Mode	PD (dBm/RBW)	EIRP PD (dBm/RBW)
5.15-5.25GHz	-	-
802.11ac VHT80_Nss1,(MCS0)_2TX	-3.80	4.21
5.725-5.85GHz	-	-
802.11ac VHT80_Nss1,(MCS0)_2TX	0.88	8.89

RBW = 500 kHz for 5.725-5.85GHz band / 1MHz for other band;



Result

Mode	Result	DG (dBi)	Port 1 (dBm/RBW)	Port 2 (dBm/RBW)	PD (dBm/RBW)	PD Limit (dBm/RBW)	EIRP PD (dBm/RBW)	EIRP PD Limit (dBm/RBW)
802.11ac VHT80_Nss1,(MCS0)_2TX	-	-	-	-	-	-	-	-
5210MHz_TnomVnom	Pass	8.01	-7.29	-6.18	-3.80	17.00	4.21	40.00
5775MHz_TnomVnom	Pass	8.01	-2.64	-1.63	0.88	30.00	8.89	30.00

DG = Directional Gain; RBW = 500 kHz for 5.725-5.85GHz band / 1MHz for other band;

PD = trace bin-by-bin of each transmits port summing can be performed maximum power density; Port X = Port X power density;

802.11ac VHT80_Nss1,(MCS0)_2TX

PSD

5210MHz

25/05/2020

CF
5.21GHz
Span
120MHz
RBW
1MHz
VBW
3MHz
Sweep Time
20ms
Detector Type
RMS

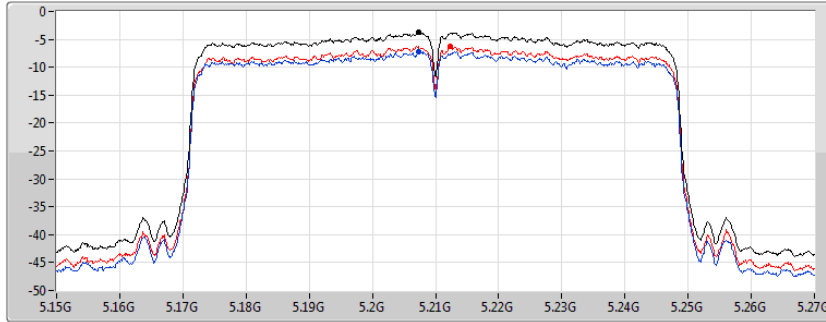

Sum
Port 1
Port 2

Sum	PD	Port 1	Port 2
(dBm/RBW)	(dBm/RBW)	(dBm/RBW)	(dBm/RBW)
-3.80	-3.80	-7.29	-6.18

802.11ac VHT80_Nss1,(MCS0)_2TX

PSD

5775MHz

29/05/2020

CF
5.775GHz
Span
120MHz
RBW
500kHz
VBW
3MHz
Sweep Time
20ms
Detector Type
RMS

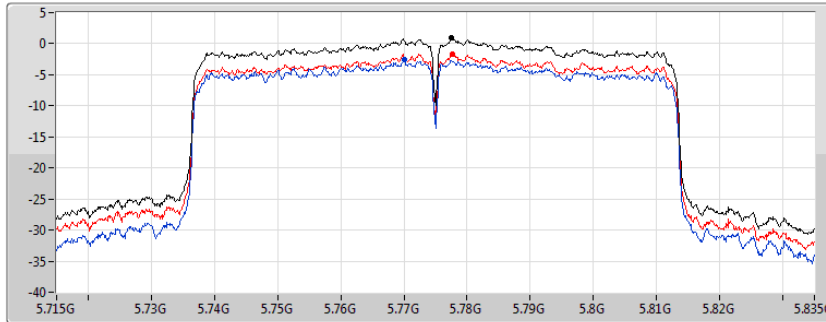

Sum
Port 1
Port 2

Sum	PD	Port 1	Port 2
(dBm/RBW)	(dBm/RBW)	(dBm/RBW)	(dBm/RBW)
0.88	0.88	-2.64	-1.63



Summary

Mode	Result	Type	Freq (Hz)	Level (dBuV/m)	Limit (dBuV/m)	Margin (dB)	Dist (m)	Condition	Azimuth (°)	Height (m)	Comments
5.725-5.85GHz	-	-	-	-	-	-	-	-	-	-	-
802.11ac_VHT80_Nss1,(MCS0)_2TX	Pass	PK	49.4M	34.22	40.00	-5.78	3	Vertical	0	1.00	-



Result

Mode	Result	Type	Freq (Hz)	Level (dBuV/m)	Limit (dBuV/m)	Margin (dB)	Dist (m)	Condition	Azimuth (°)	Height (m)	Comments
802.11ac VHT80_Nss1,(MCS0)_2TX	-	-	-	-	-	-	-	-	-	-	-
5775MHz	Pass	PK	59.1M	33.35	40.00	-6.65	3	Vertical	360	1.00	-
5775MHz	Pass	PK	97.9M	32.96	43.50	-10.54	3	Vertical	360	1.00	-
5775MHz	Pass	PK	418M	29.93	46.00	-16.07	3	Vertical	360	1.00	-
5775MHz	Pass	PK	480.08M	35.84	46.00	-10.16	3	Vertical	360	1.00	-
5775MHz	Pass	PK	745.86M	32.61	46.00	-13.39	3	Vertical	360	1.00	-
5775MHz	Pass	QP	33.88M	33.83	40.00	-6.17	3	Vertical	307	1.00	-
5775MHz	Pass	PK	59.1M	28.27	40.00	-11.73	3	Horizontal	0	1.00	-
5775MHz	Pass	PK	95.96M	29.91	43.50	-13.59	3	Horizontal	0	1.00	-
5775MHz	Pass	PK	136.7M	29.54	43.50	-13.96	3	Horizontal	0	1.00	-
5775MHz	Pass	PK	419.94M	30.18	46.00	-15.82	3	Horizontal	0	1.00	-
5775MHz	Pass	PK	480.08M	34.71	46.00	-11.29	3	Horizontal	0	1.00	-
5775MHz	Pass	PK	741.98M	32.63	46.00	-13.37	3	Horizontal	0	1.00	-
5775MHz	Pass	PK	49.4M	34.22	40.00	-5.78	3	Vertical	0	1.00	-
5775MHz	Pass	PK	99.84M	32.64	43.50	-10.86	3	Vertical	0	1.00	-
5775MHz	Pass	PK	134.76M	32.76	43.50	-10.74	3	Vertical	0	1.00	-
5775MHz	Pass	PK	371.44M	27.99	46.00	-18.01	3	Vertical	0	1.00	-
5775MHz	Pass	PK	439.34M	29.67	46.00	-16.33	3	Vertical	0	1.00	-
5775MHz	Pass	PK	480.08M	34.70	46.00	-11.30	3	Vertical	0	1.00	-
5775MHz	Pass	PK	59.1M	27.06	40.00	-12.94	3	Horizontal	0	1.00	-
5775MHz	Pass	PK	99.84M	31.23	43.50	-12.27	3	Horizontal	0	1.00	-
5775MHz	Pass	PK	136.7M	33.39	43.50	-10.11	3	Horizontal	0	1.00	-
5775MHz	Pass	PK	480.08M	33.88	46.00	-12.12	3	Horizontal	0	1.00	-
5775MHz	Pass	PK	745.86M	33.96	46.00	-12.04	3	Horizontal	0	1.00	-
5775MHz	Pass	PK	802.12M	33.84	46.00	-12.16	3	Horizontal	0	1.00	-



802.11ac VHT80_Nss1,(MCS0)_2TX

01/06/2020

5775MHz_Adapter1

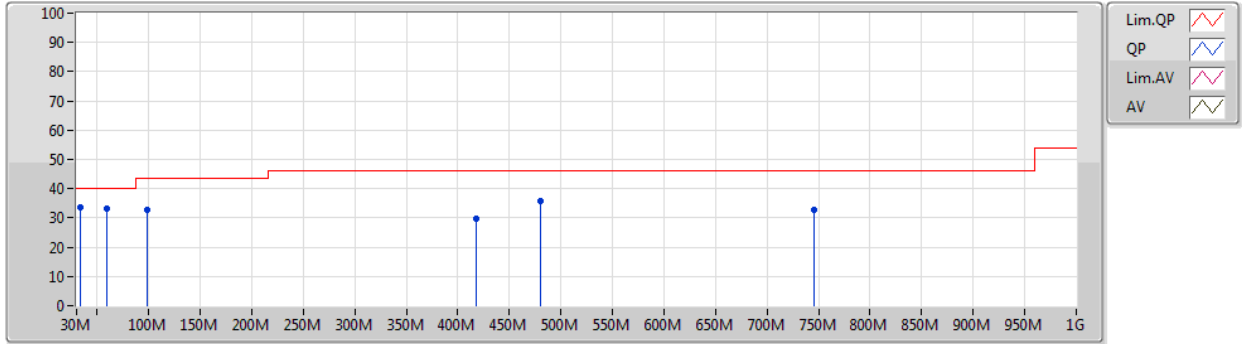

Type	Freq (Hz)	Level (dBuV/m)	Limit (dBuV/m)	Margin (dB)	Factor (dB)	Dist (m)	Condition	Azimuth (°)	Height (m)	Comment	Raw (dBuV)	AF (dB)	CL (dB)	PA (dB)
PK	59.1M	33.35	40.00	-6.65	-14.91	3	Vertical	360	1.00	-	48.26	11.39	1.20	27.50
PK	97.9M	32.96	43.50	-10.54	-10.21	3	Vertical	360	1.00	-	43.17	15.58	1.60	27.39
PK	418M	29.93	46.00	-16.07	-2.25	3	Vertical	360	1.00	-	32.18	21.82	3.34	27.41
PK	480.08M	35.84	46.00	-10.16	-1.72	3	Vertical	360	1.00	-	37.56	22.45	3.58	27.75
PK	745.86M	32.61	46.00	-13.39	1.48	3	Vertical	360	1.00	-	31.13	24.91	4.58	28.01
QP	33.88M	33.83	40.00	-6.17	-5.66	3	Vertical	307	1.00	-	39.49	21.00	0.90	27.56



802.11ac VHT80_Nss1,(MCS0)_2TX

01/06/2020

5775MHz_Adapter1

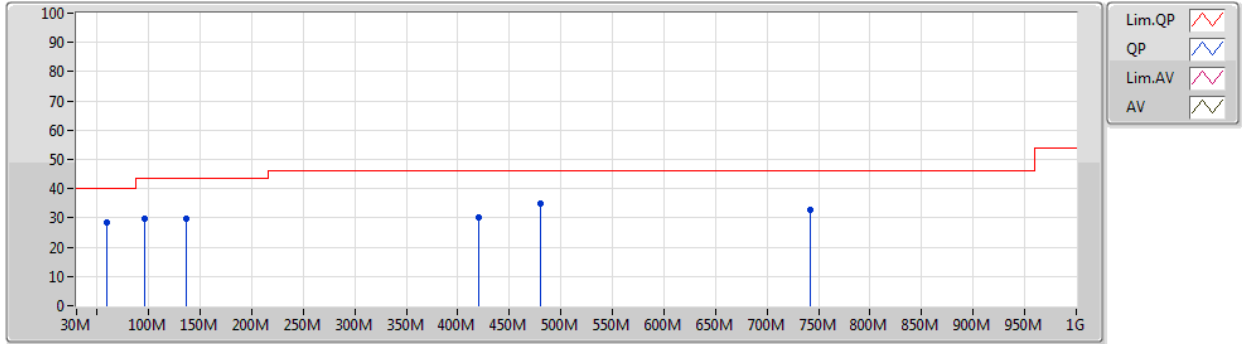

Type	Freq (Hz)	Level (dBuV/m)	Limit (dBuV/m)	Margin (dB)	Factor (dB)	Dist (m)	Condition	Azimuth (°)	Height (m)	Comment	Raw (dBuV)	AF (dB)	CL (dB)	PA (dB)
PK	59.1M	28.27	40.00	-11.73	-14.91	3	Horizontal	0	1.00	-	43.18	11.39	1.20	27.50
PK	95.96M	29.91	43.50	-13.59	-10.62	3	Horizontal	0	1.00	-	40.53	15.16	1.60	27.38
PK	136.7M	29.54	43.50	-13.96	-8.86	3	Horizontal	0	1.00	-	38.40	16.50	1.88	27.24
PK	419.94M	30.18	46.00	-15.82	-2.28	3	Horizontal	0	1.00	-	32.46	21.81	3.34	27.43
PK	480.08M	34.71	46.00	-11.29	-1.72	3	Horizontal	0	1.00	-	36.43	22.45	3.58	27.75
PK	741.98M	32.63	46.00	-13.37	1.37	3	Horizontal	0	1.00	-	31.26	24.81	4.57	28.01



802.11ac VHT80_Nss1,(MCS0)_2TX

01/06/2020

5775MHz_Adapter2

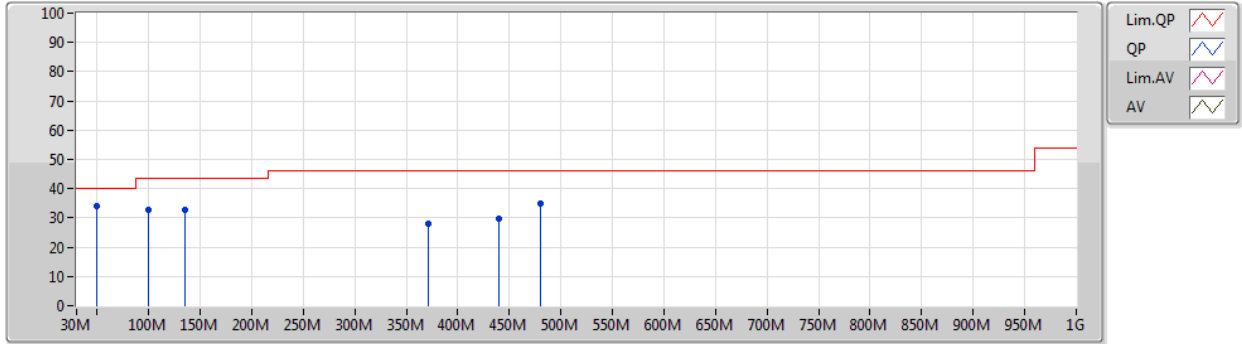

Type	Freq (Hz)	Level (dBuV/m)	Limit (dBuV/m)	Margin (dB)	Factor (dB)	Dist (m)	Condition	Azimuth (°)	Height (m)	Comment	Raw (dBuV)	AF (dB)	CL (dB)	PA (dB)
PK	49.4M	34.22	40.00	-5.78	-13.22	3	Vertical	0	1.00	-	47.44	13.20	1.09	27.51
PK	99.84M	32.64	43.50	-10.86	-9.86	3	Vertical	0	1.00	-	42.50	15.93	1.60	27.39
PK	134.76M	32.76	43.50	-10.74	-8.82	3	Vertical	0	1.00	-	41.58	16.56	1.87	27.25
PK	371.44M	27.99	46.00	-18.01	-3.92	3	Vertical	0	1.00	-	31.91	19.96	3.19	27.07
PK	439.34M	29.67	46.00	-16.33	-2.34	3	Vertical	0	1.00	-	32.01	21.88	3.38	27.60
PK	480.08M	34.70	46.00	-11.30	-1.72	3	Vertical	0	1.00	-	36.42	22.45	3.58	27.75



802.11ac VHT80_Nss1,(MCS0)_2TX

01/06/2020

5775MHz_Adapter2

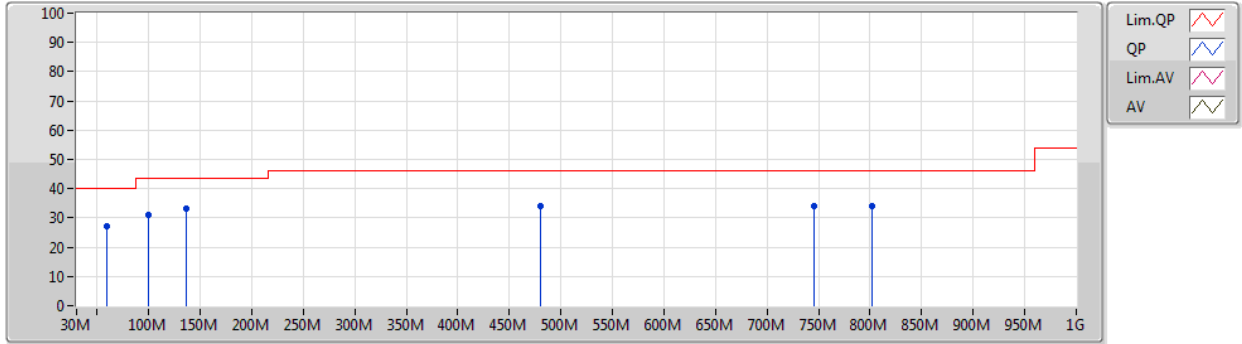

Type	Freq (Hz)	Level (dBuV/m)	Limit (dBuV/m)	Margin (dB)	Factor (dB)	Dist (m)	Condition	Azimuth (°)	Height (m)	Comment	Raw (dBuV)	AF (dB)	CL (dB)	PA (dB)
PK	59.1M	27.06	40.00	-12.94	-14.91	3	Horizontal	0	1.00	-	41.97	11.39	1.20	27.50
PK	99.84M	31.23	43.50	-12.27	-9.86	3	Horizontal	0	1.00	-	41.09	15.93	1.60	27.39
PK	136.7M	33.39	43.50	-10.11	-8.86	3	Horizontal	0	1.00	-	42.25	16.50	1.88	27.24
PK	480.08M	33.88	46.00	-12.12	-1.72	3	Horizontal	0	1.00	-	35.60	22.45	3.58	27.75
PK	745.86M	33.96	46.00	-12.04	1.48	3	Horizontal	0	1.00	-	32.48	24.91	4.58	28.01
PK	802.12M	33.84	46.00	-12.16	1.72	3	Horizontal	0	1.00	-	32.12	24.71	4.80	27.79



Summary

Mode	Result	Type	Freq (Hz)	Level (dBuV/m)	Limit (dBuV/m)	Margin (dB)	Dist (m)	Condition	Azimuth (°)	Height (m)	Comments
5.15-5.25GHz	-	-	-	-	-	-	-	-	-	-	-
802.11ac VHT80_Nss1,(MCS0)_2TX	Pass	AV	5.141G	53.57	54.00	-0.43	3	Vertical	91	2.58	-
5.725-5.85GHz	-	-	-	-	-	-	-	-	-	-	-
802.11ac VHT80_Nss1,(MCS0)_2TX	Pass	PK	5.6502G	67.80	68.35	-0.55	3	Vertical	6	1.94	-



Result

Mode	Result	Type	Freq (Hz)	Level (dBuV/m)	Limit (dBuV/m)	Margin (dB)	Dist (m)	Condition	Azimuth (°)	Height (m)	Comments
802.11ac VHT80_Nss1,(MCS0)_2TX	-	-	-	-	-	-	-	-	-	-	-
5210MHz	Pass	AV	5.141G	53.57	54.00	-0.43	3	Vertical	91	2.58	-
5210MHz	Pass	AV	5.212G	93.76	Inf	-Inf	3	Vertical	91	2.58	-
5210MHz	Pass	AV	5.355G	48.45	54.00	-5.55	3	Vertical	91	2.58	-
5210MHz	Pass	PK	5.142G	65.46	74.00	-8.54	3	Vertical	91	2.58	-
5210MHz	Pass	PK	5.203G	103.45	Inf	-Inf	3	Vertical	91	2.58	-
5210MHz	Pass	PK	5.362G	59.85	74.00	-14.15	3	Vertical	91	2.58	-
5210MHz	Pass	PK	10.4282G	57.82	68.20	-10.38	3	Vertical	140	2.44	-
5210MHz	Pass	PK	10.4028G	55.55	68.20	-12.65	3	Horizontal	0	1.49	-
5775MHz	Pass	AV	5.7738G	103.03	Inf	-Inf	3	Vertical	6	1.94	-
5775MHz	Pass	PK	5.6502G	67.80	68.35	-0.55	3	Vertical	6	1.94	-
5775MHz	Pass	PK	5.7678G	111.98	Inf	-Inf	3	Vertical	6	1.94	-
5775MHz	Pass	PK	5.9286G	66.41	68.20	-1.79	3	Vertical	6	1.94	-
5775MHz	Pass	AV	11.55012G	47.64	54.00	-6.36	3	Vertical	344	1.46	-
5775MHz	Pass	PK	11.54322G	59.22	74.00	-14.78	3	Vertical	344	1.46	-
5775MHz	Pass	AV	11.54622G	46.62	54.00	-7.38	3	Horizontal	241	1.50	-
5775MHz	Pass	PK	11.54484G	58.10	74.00	-15.90	3	Horizontal	241	1.50	-

802.11ac VHT80_Nss1,(MCS0)_2TX

23/05/2020

5210MHz_TX

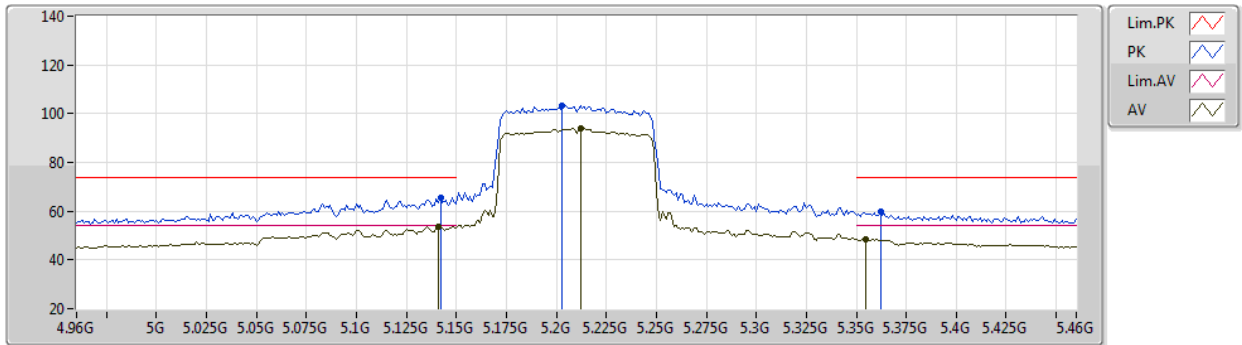

Type	Freq (Hz)	Level (dBuV/m)	Limit (dBuV/m)	Margin (dB)	Factor (dB)	Dist (m)	Condition	Azimuth (°)	Height (m)	Comment	Raw (dBuV)	AF (dB)	CL (dB)	PA (dB)
AV	5.141G	53.57	54.00	-0.43	6.44	3	Vertical	91	2.58	-	47.13	31.76	8.51	33.83
AV	5.212G	93.76	Inf	-Inf	6.50	3	Vertical	91	2.58	-	87.26	31.78	8.57	33.85
AV	5.355G	48.45	54.00	-5.55	6.55	3	Vertical	91	2.58	-	41.90	31.84	8.60	33.89
PK	5.142G	65.46	74.00	-8.54	6.44	3	Vertical	91	2.58	-	59.02	31.76	8.51	33.83
PK	5.203G	103.45	Inf	-Inf	6.50	3	Vertical	91	2.58	-	96.95	31.78	8.57	33.85
PK	5.362G	59.85	74.00	-14.15	6.55	3	Vertical	91	2.58	-	53.30	31.84	8.60	33.89



802.11ac VHT80_Nss1,(MCS0)_2TX

23/05/2020

5210MHz_TX

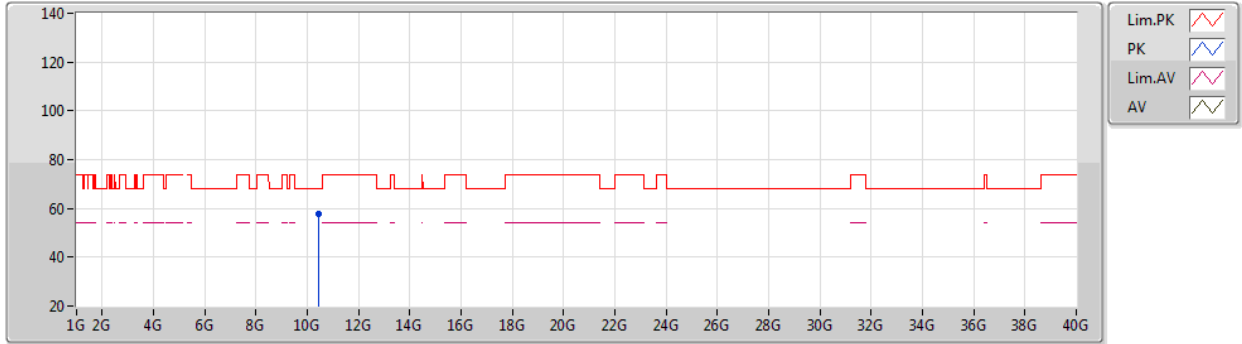

Type	Freq (Hz)	Level (dBuV/m)	Limit (dBuV/m)	Margin (dB)	Factor (dB)	Dist (m)	Condition	Azimuth (°)	Height (m)	Comment	Raw (dBuV)	AF (dB)	CL (dB)	PA (dB)
PK	10.4282G	57.82	68.20	-10.38	17.43	3	Vertical	140	2.44	-	40.39	39.46	12.22	34.25



802.11ac VHT80_Nss1,(MCS0)_2TX

23/05/2020

5210MHz_TX

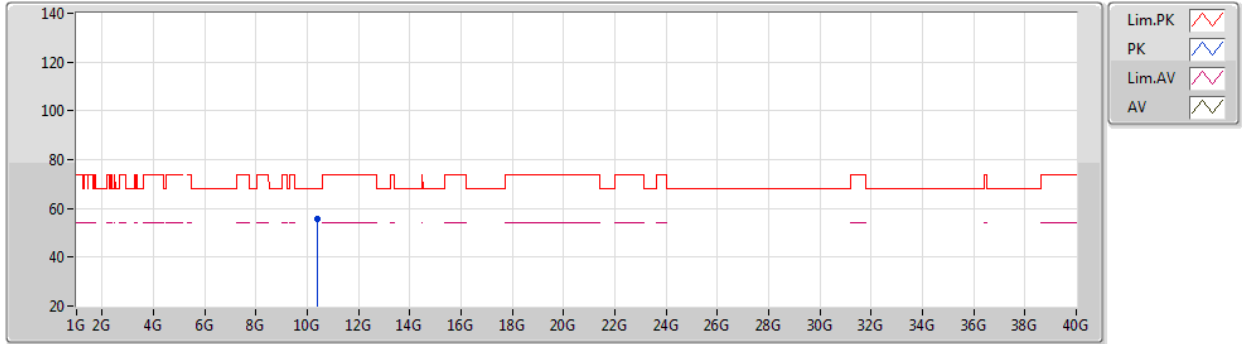

Type	Freq (Hz)	Level (dBuV/m)	Limit (dBuV/m)	Margin (dB)	Factor (dB)	Dist (m)	Condition	Azimuth (°)	Height (m)	Comment	Raw (dBuV)	AF (dB)	CL (dB)	PA (dB)
PK	10.4028G	55.55	68.20	-12.65	17.35	3	Horizontal	0	1.49	-	38.20	39.42	12.20	34.27



802.11ac VHT80_Nss1,(MCS0)_2TX

29/05/2020

5775MHz_TX

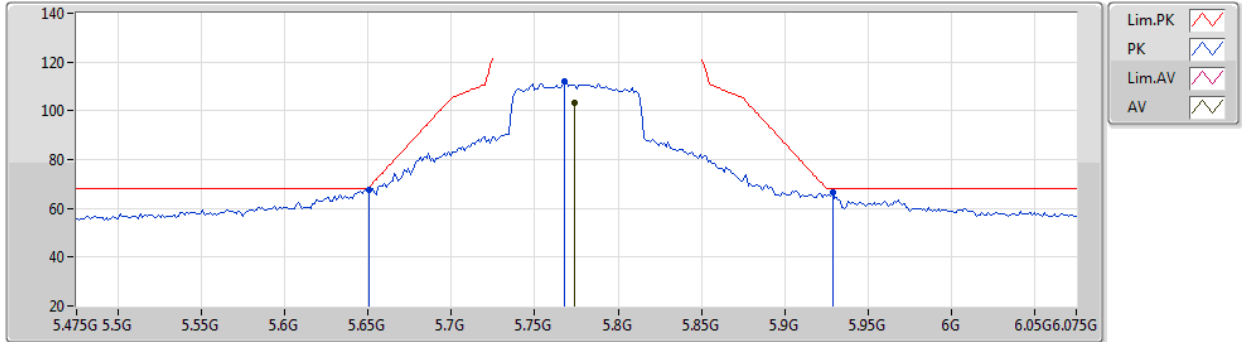

Type	Freq (Hz)	Level (dBuV/m)	Limit (dBuV/m)	Margin (dB)	Factor (dB)	Dist (m)	Condition	Azimuth (°)	Height (m)	Comment	Raw (dBuV)	AF (dB)	CL (dB)	PA (dB)
AV	5.7738G	103.03	Inf	-Inf	10.31	3	Vertical	6	1.94	-	92.72	32.00	7.67	29.36
PK	5.6502G	67.80	68.35	-0.55	9.89	3	Vertical	6	1.94	-	57.91	31.70	7.55	29.36
PK	5.7678G	111.98	Inf	-Inf	10.31	3	Vertical	6	1.94	-	101.67	32.00	7.67	29.36
PK	5.9286G	66.41	68.20	-1.79	10.79	3	Vertical	6	1.94	-	55.62	32.31	7.83	29.35



802.11ac VHT80_Nss1,(MCS0)_2TX

29/05/2020

5775MHz_TX

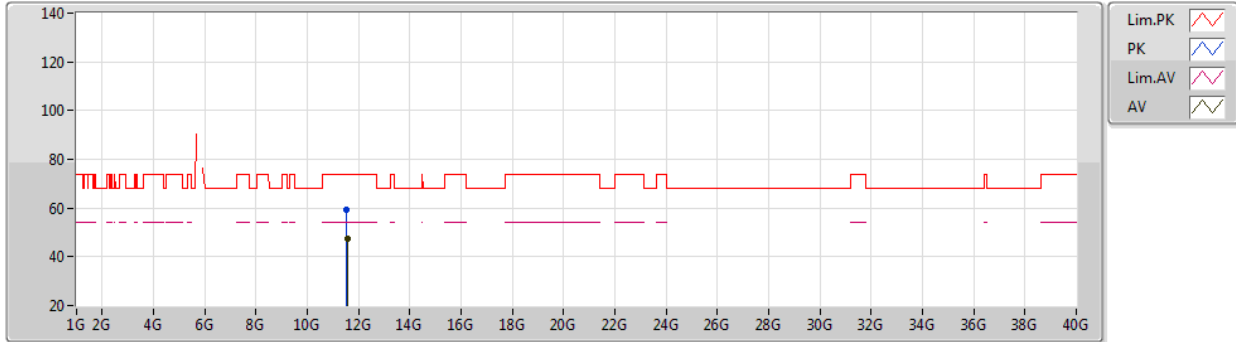

Type	Freq (Hz)	Level (dBuV/m)	Limit (dBuV/m)	Margin (dB)	Factor (dB)	Dist (m)	Condition	Azimuth (°)	Height (m)	Comment	Raw (dBuV)	AF (dB)	CL (dB)	PA (dB)
AV	11.55012G	47.64	54.00	-6.36	19.45	3	Vertical	344	1.46	-	28.19	39.95	10.28	30.78
PK	11.54322G	59.22	74.00	-14.78	19.45	3	Vertical	344	1.46	-	39.77	39.96	10.27	30.78



802.11ac VHT80_Nss1,(MCS0)_2TX

29/05/2020

5775MHz_TX

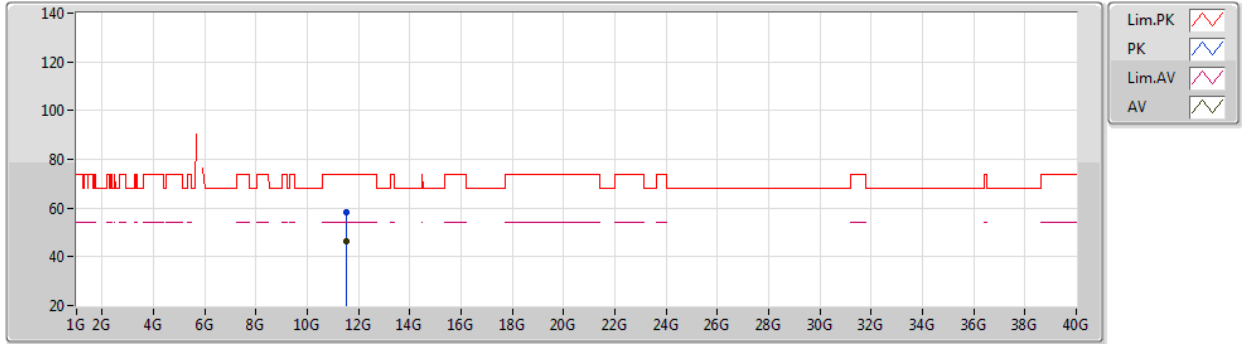

Type	Freq (Hz)	Level (dBuV/m)	Limit (dBuV/m)	Margin (dB)	Factor (dB)	Dist (m)	Condition	Azimuth (°)	Height (m)	Comment	Raw (dBuV)	AF (dB)	CL (dB)	PA (dB)
AV	11.54622G	46.62	54.00	-7.38	19.44	3	Horizontal	241	1.50	-	27.18	39.95	10.27	30.78
PK	11.54484G	58.10	74.00	-15.90	19.45	3	Horizontal	241	1.50	-	38.65	39.96	10.27	30.78



Summary

Mode	Result	Type	Freq (Hz)	Level (dBuV/m)	Limit (dBuV/m)	Margin (dB)	Dist (m)	Condition	Azimuth (°)	Height (m)	Comments
5.725-5.85GHz	-	-	-	-	-	-	-	-	-	-	-
802.11ac_VHT80_Nss1,(MCS0)_2TX	Pass	QP	59.1M	35.77	40.00	-4.23	3	Vertical	155	1.00	-



Result

Mode	Result	Type	Freq (Hz)	Level (dBuV/m)	Limit (dBuV/m)	Margin (dB)	Dist (m)	Condition	Azimuth (°)	Height (m)	Comments
802.11ac VHT80_Nss1,(MCS0)_2TX	-	-	-	-	-	-	-	-	-	-	-
5775MHz	Pass	PK	59.1M	34.00	40.00	-6.00	3	Vertical	0	1.00	-
5775MHz	Pass	PK	239.52M	32.63	46.00	-13.37	3	Vertical	0	1.00	-
5775MHz	Pass	PK	371.44M	28.65	46.00	-17.35	3	Vertical	0	1.00	-
5775MHz	Pass	PK	480.08M	35.80	46.00	-10.20	3	Vertical	0	1.00	-
5775MHz	Pass	PK	582.9M	31.27	46.00	-14.73	3	Vertical	0	1.00	-
5775MHz	Pass	QP	33.88M	33.30	40.00	-6.70	3	Vertical	328	1.00	-
5775MHz	Pass	PK	59.1M	29.38	40.00	-10.62	3	Horizontal	360	1.00	-
5775MHz	Pass	PK	97.9M	30.35	43.50	-13.15	3	Horizontal	360	1.00	-
5775MHz	Pass	PK	239.52M	39.67	46.00	-6.33	3	Horizontal	360	1.00	-
5775MHz	Pass	PK	416.06M	30.13	46.00	-15.87	3	Horizontal	360	1.00	-
5775MHz	Pass	PK	480.08M	34.70	46.00	-11.30	3	Horizontal	360	1.00	-
5775MHz	Pass	PK	656.62M	31.77	46.00	-14.23	3	Horizontal	360	1.00	-
5775MHz	Pass	PK	103.72M	33.78	43.50	-9.72	3	Vertical	0	1.00	-
5775MHz	Pass	PK	371.44M	30.55	46.00	-15.45	3	Vertical	0	1.00	-
5775MHz	Pass	PK	450.98M	30.75	46.00	-15.25	3	Vertical	0	1.00	-
5775MHz	Pass	PK	549.92M	31.08	46.00	-14.92	3	Vertical	0	1.00	-
5775MHz	Pass	QP	33.88M	34.71	40.00	-5.29	3	Vertical	329	1.00	-
5775MHz	Pass	QP	59.1M	35.77	40.00	-4.23	3	Vertical	155	1.00	-
5775MHz	Pass	PK	33.88M	31.44	40.00	-8.56	3	Horizontal	360	1.00	-
5775MHz	Pass	PK	59.1M	33.25	40.00	-6.75	3	Horizontal	360	1.00	-
5775MHz	Pass	PK	109.54M	32.95	43.50	-10.55	3	Horizontal	360	1.00	-
5775MHz	Pass	PK	363.68M	28.31	46.00	-17.69	3	Horizontal	360	1.00	-
5775MHz	Pass	PK	416.06M	30.48	46.00	-15.52	3	Horizontal	360	1.00	-
5775MHz	Pass	PK	480.08M	32.10	46.00	-13.90	3	Horizontal	360	1.00	-

802.11ac VHT80_Nss1,(MCS0)_2TX

01/06/2020

5775MHz_Adapter1

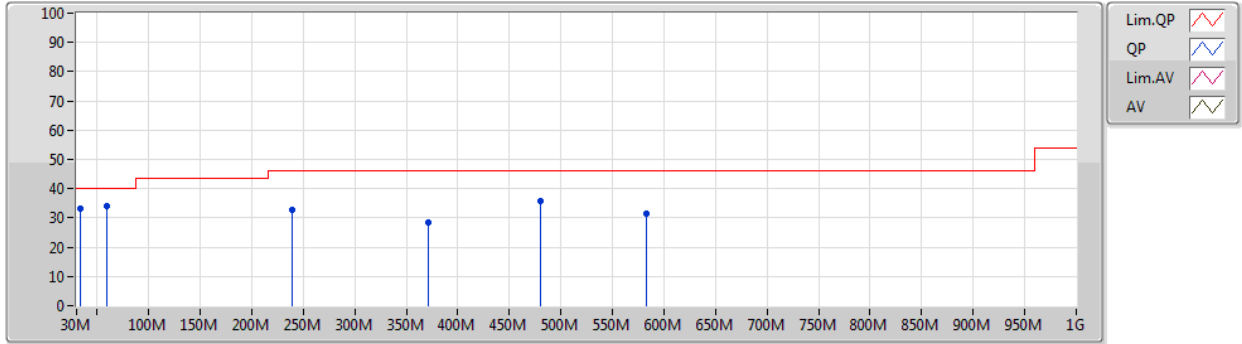

Type	Freq (Hz)	Level (dBuV/m)	Limit (dBuV/m)	Margin (dB)	Factor (dB)	Dist (m)	Condition	Azimuth (°)	Height (m)	Comment	Raw (dBuV)	AF (dB)	CL (dB)	PA (dB)
PK	59.1M	34.00	40.00	-6.00	-14.91	3	Vertical	0	1.00	-	48.91	11.39	1.20	27.50
PK	239.52M	32.63	46.00	-13.37	-7.88	3	Vertical	0	1.00	-	40.51	16.33	2.54	26.75
PK	371.44M	28.65	46.00	-17.35	-3.92	3	Vertical	0	1.00	-	32.57	19.96	3.19	27.07
PK	480.08M	35.80	46.00	-10.20	-1.72	3	Vertical	0	1.00	-	37.52	22.45	3.58	27.75
PK	582.9M	31.27	46.00	-14.73	-0.31	3	Vertical	0	1.00	-	31.58	23.67	4.03	28.01
QP	33.88M	33.30	40.00	-6.70	-5.66	3	Vertical	328	1.00	-	38.96	21.00	0.90	27.56



802.11ac VHT80_Nss1,(MCS0)_2TX

01/06/2020

5775MHz_Adapter1

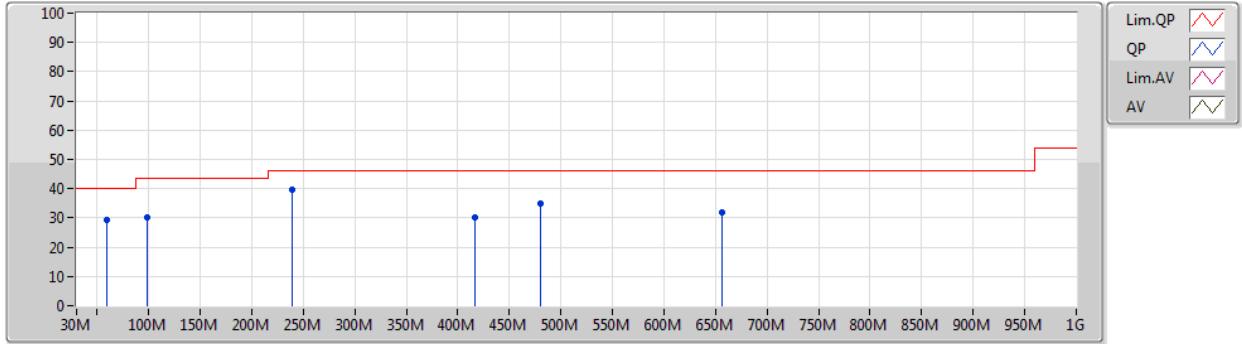

Type	Freq (Hz)	Level (dBuV/m)	Limit (dBuV/m)	Margin (dB)	Factor (dB)	Dist (m)	Condition	Azimuth (°)	Height (m)	Comment	Raw (dBuV)	AF (dB)	CL (dB)	PA (dB)
PK	59.1M	29.38	40.00	-10.62	-14.91	3	Horizontal	360	1.00	-	44.29	11.39	1.20	27.50
PK	97.9M	30.35	43.50	-13.15	-10.21	3	Horizontal	360	1.00	-	40.56	15.58	1.60	27.39
PK	239.52M	39.67	46.00	-6.33	-7.88	3	Horizontal	360	1.00	-	47.55	16.33	2.54	26.75
PK	416.06M	30.13	46.00	-15.87	-2.23	3	Horizontal	360	1.00	-	32.36	21.83	3.33	27.39
PK	480.08M	34.70	46.00	-11.30	-1.72	3	Horizontal	360	1.00	-	36.42	22.45	3.58	27.75
PK	656.62M	31.77	46.00	-14.23	0.05	3	Horizontal	360	1.00	-	31.72	23.82	4.31	28.08

802.11ac VHT80_Nss1,(MCS0)_2TX

01/06/2020

5775MHz_Adapter2

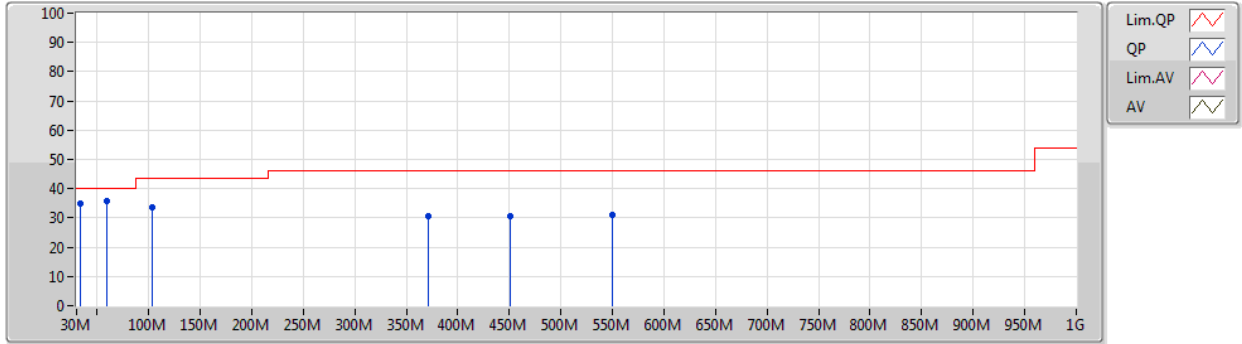

Type	Freq (Hz)	Level (dBuV/m)	Limit (dBuV/m)	Margin (dB)	Factor (dB)	Dist (m)	Condition	Azimuth (°)	Height (m)	Comment	Raw (dBuV)	AF (dB)	CL (dB)	PA (dB)
PK	103.72M	33.78	43.50	-9.72	-9.35	3	Vertical	0	1.00	-	43.13	16.38	1.64	27.37
PK	371.44M	30.55	46.00	-15.45	-3.92	3	Vertical	0	1.00	-	34.47	19.96	3.19	27.07
PK	450.98M	30.75	46.00	-15.25	-2.30	3	Vertical	0	1.00	-	33.05	21.98	3.41	27.69
PK	549.92M	31.08	46.00	-14.92	-0.18	3	Vertical	0	1.00	-	31.26	23.94	3.90	28.02
QP	33.88M	34.71	40.00	-5.29	-5.66	3	Vertical	329	1.00	-	40.37	21.00	0.90	27.56
QP	59.1M	35.77	40.00	-4.23	-14.91	3	Vertical	155	1.00	-	50.68	11.39	1.20	27.50



802.11ac VHT80_Nss1,(MCS0)_2TX

01/06/2020

5775MHz_Adapter2

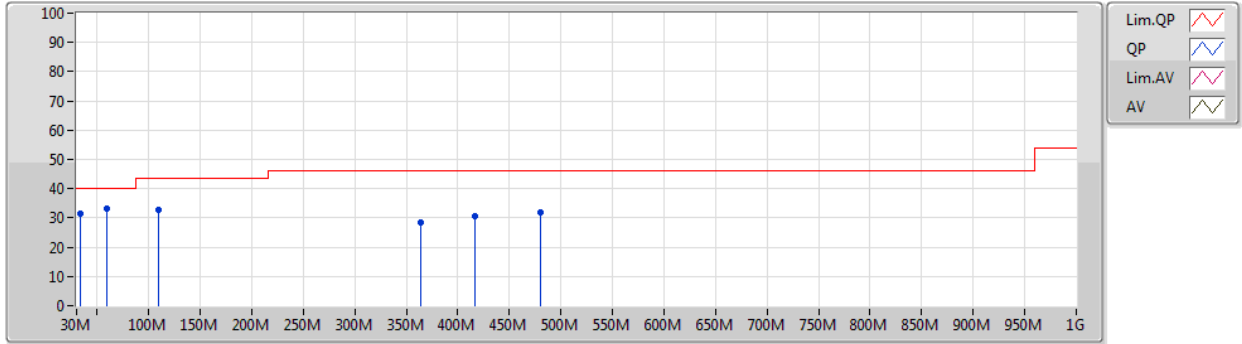

Type	Freq (Hz)	Level (dBuV/m)	Limit (dBuV/m)	Margin (dB)	Factor (dB)	Dist (m)	Condition	Azimuth (°)	Height (m)	Comment	Raw (dBuV)	AF (dB)	CL (dB)	PA (dB)
PK	33.88M	31.44	40.00	-8.56	-5.66	3	Horizontal	360	1.00	-	37.10	21.00	0.90	27.56
PK	59.1M	33.25	40.00	-6.75	-14.91	3	Horizontal	360	1.00	-	48.16	11.39	1.20	27.50
PK	109.54M	32.95	43.50	-10.55	-8.77	3	Horizontal	360	1.00	-	41.72	16.87	1.70	27.34
PK	363.68M	28.31	46.00	-17.69	-4.04	3	Horizontal	360	1.00	-	32.35	19.83	3.15	27.02
PK	416.06M	30.48	46.00	-15.52	-2.23	3	Horizontal	360	1.00	-	32.71	21.83	3.33	27.39
PK	480.08M	32.10	46.00	-13.90	-1.72	3	Horizontal	360	1.00	-	33.82	22.45	3.58	27.75



Summary

Mode	Result	Type	Freq (Hz)	Level (dBuV/m)	Limit (dBuV/m)	Margin (dB)	Dist (m)	Condition	Azimuth (°)	Height (m)	Comments
5.15-5.25GHz	-	-	-	-	-	-	-	-	-	-	-
802.11ac VHT80_Nss1,(MCS0)_2TX	Pass	AV	5.141G	53.25	54.00	-0.75	3	Vertical	177	2.00	-
5.725-5.85GHz	-	-	-	-	-	-	-	-	-	-	-
802.11ac VHT80_Nss1,(MCS0)_2TX	Pass	PK	5.6442G	67.35	68.20	-0.85	3	Vertical	6	2.15	-



Result

Mode	Result	Type	Freq (Hz)	Level (dBuV/m)	Limit (dBuV/m)	Margin (dB)	Dist (m)	Condition	Azimuth (°)	Height (m)	Comments
802.11ac VHT80_Nss1,(MCS0)_2TX	-	-	-	-	-	-	-	-	-	-	-
5210MHz	Pass	AV	5.141G	53.25	54.00	-0.75	3	Vertical	177	2.00	-
5210MHz	Pass	AV	5.208G	93.41	Inf	-Inf	3	Vertical	177	2.00	-
5210MHz	Pass	AV	5.365G	47.91	54.00	-6.09	3	Vertical	177	2.00	-
5210MHz	Pass	PK	5.141G	64.38	74.00	-9.62	3	Vertical	177	2.00	-
5210MHz	Pass	PK	5.203G	102.94	Inf	-Inf	3	Vertical	177	2.00	-
5210MHz	Pass	PK	5.365G	58.62	74.00	-15.38	3	Vertical	177	2.00	-
5210MHz	Pass	PK	10.40734G	55.28	68.20	-12.92	3	Vertical	358	2.32	-
5210MHz	Pass	PK	10.42594G	54.86	68.20	-13.34	3	Horizontal	341	1.49	-
5775MHz	Pass	AV	5.7738G	102.29	Inf	-Inf	3	Vertical	6	2.15	-
5775MHz	Pass	PK	5.6442G	67.35	68.20	-0.85	3	Vertical	6	2.15	-
5775MHz	Pass	PK	5.769G	111.58	Inf	-Inf	3	Vertical	6	2.15	-
5775MHz	Pass	PK	5.9286G	66.16	68.20	-2.04	3	Vertical	6	2.15	-
5775MHz	Pass	AV	11.54988G	47.97	54.00	-6.03	3	Vertical	184	2.26	-
5775MHz	Pass	PK	11.55648G	60.28	74.00	-13.72	3	Vertical	184	2.26	-
5775MHz	Pass	AV	11.56062G	46.85	54.00	-7.15	3	Horizontal	104	1.50	-
5775MHz	Pass	PK	11.55492G	58.19	74.00	-15.81	3	Horizontal	104	1.50	-

802.11ac VHT80_Nss1,(MCS0)_2TX

23/05/2020

5210MHz_TX

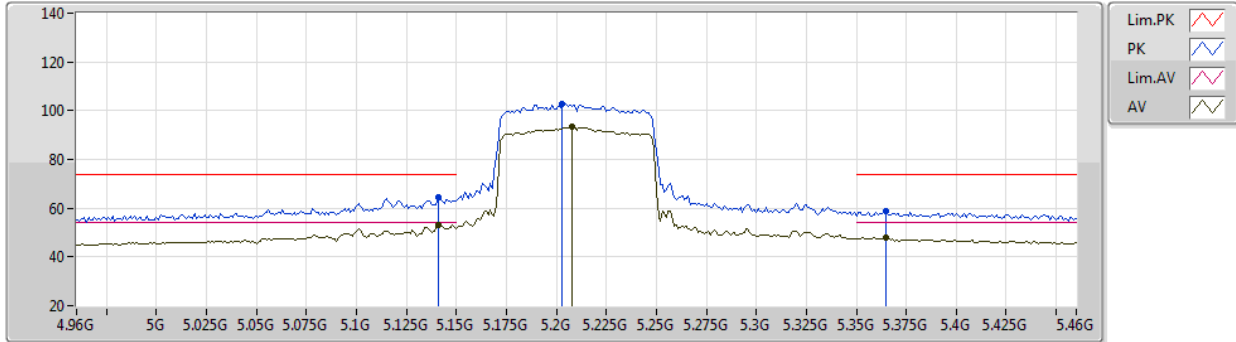

Type	Freq (Hz)	Level (dBuV/m)	Limit (dBuV/m)	Margin (dB)	Factor (dB)	Dist (m)	Condition	Azimuth (°)	Height (m)	Comment	Raw (dBuV)	AF (dB)	CL (dB)	PA (dB)
AV	5.141G	53.25	54.00	-0.75	6.44	3	Vertical	177	2.00	-	46.81	31.76	8.51	33.83
AV	5.208G	93.41	Inf	-Inf	6.50	3	Vertical	177	2.00	-	86.91	31.78	8.57	33.85
AV	5.365G	47.91	54.00	-6.09	6.56	3	Vertical	177	2.00	-	41.35	31.85	8.60	33.89
PK	5.141G	64.38	74.00	-9.62	6.44	3	Vertical	177	2.00	-	57.94	31.76	8.51	33.83
PK	5.203G	102.94	Inf	-Inf	6.50	3	Vertical	177	2.00	-	96.44	31.78	8.57	33.85
PK	5.365G	58.62	74.00	-15.38	6.56	3	Vertical	177	2.00	-	52.06	31.85	8.60	33.89



802.11ac VHT80_Nss1,(MCS0)_2TX

23/05/2020

5210MHz_TX

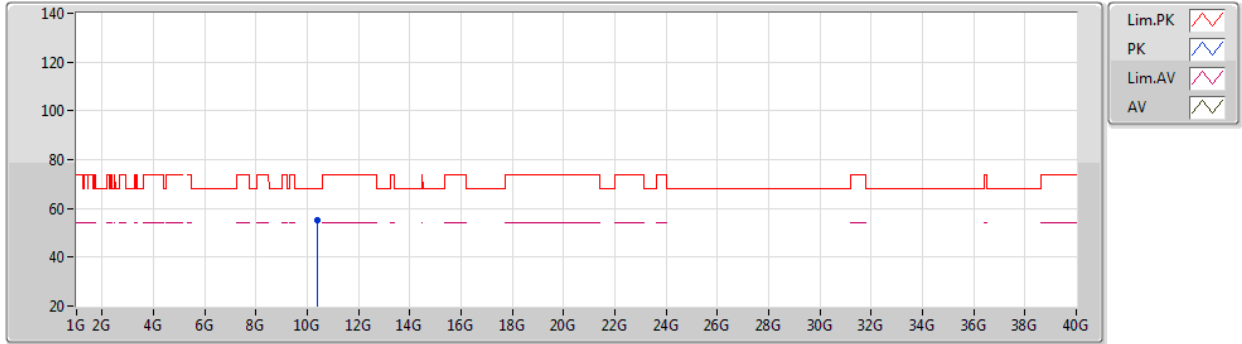

Type	Freq (Hz)	Level (dBuV/m)	Limit (dBuV/m)	Margin (dB)	Factor (dB)	Dist (m)	Condition	Azimuth (°)	Height (m)	Comment	Raw (dBuV)	AF (dB)	CL (dB)	PA (dB)
PK	10.40734G	55.28	68.20	-12.92	17.38	3	Vertical	358	2.32	-	37.90	39.43	12.21	34.26



802.11ac VHT80_Nss1,(MCS0)_2TX

23/05/2020

5210MHz_TX

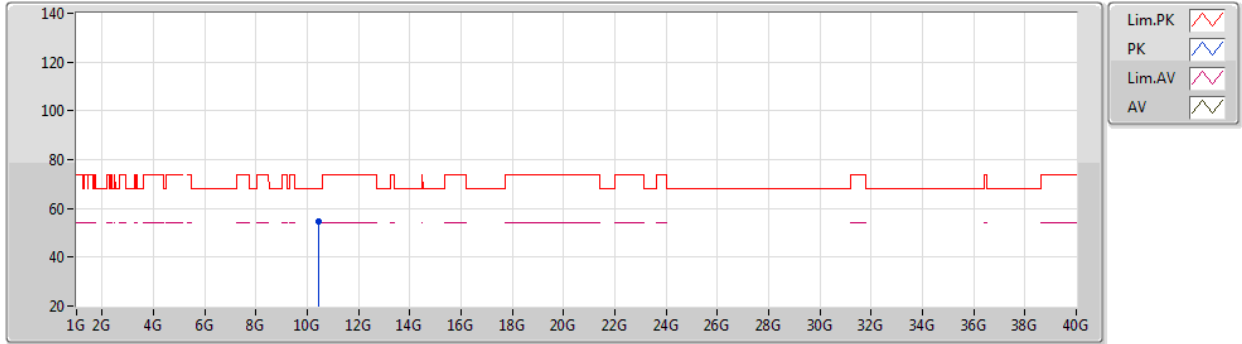

Type	Freq (Hz)	Level (dBuV/m)	Limit (dBuV/m)	Margin (dB)	Factor (dB)	Dist (m)	Condition	Azimuth (°)	Height (m)	Comment	Raw (dBuV)	AF (dB)	CL (dB)	PA (dB)
PK	10.42594G	54.86	68.20	-13.34	17.42	3	Horizontal	341	1.49	-	37.44	39.45	12.22	34.25

802.11ac VHT80_Nss1,(MCS0)_2TX

29/05/2020

5775MHz_TX

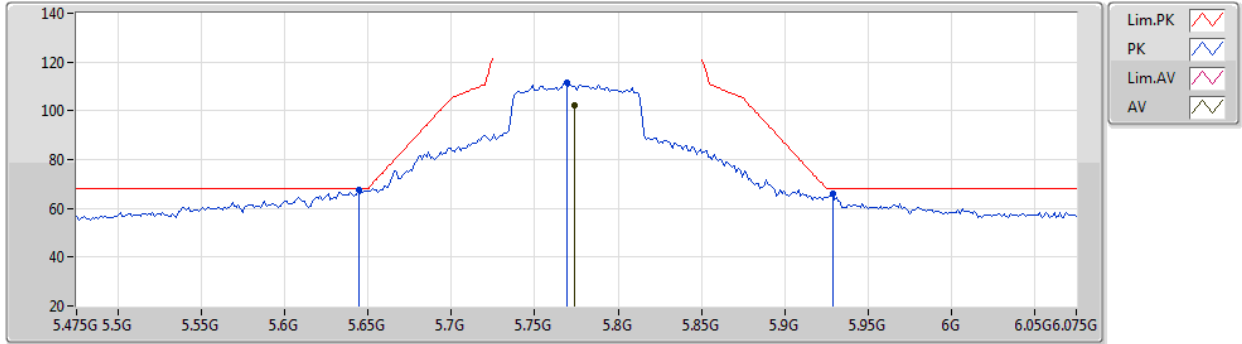

Type	Freq (Hz)	Level (dBuV/m)	Limit (dBuV/m)	Margin (dB)	Factor (dB)	Dist (m)	Condition	Azimuth (°)	Height (m)	Comment	Raw (dBuV)	AF (dB)	CL (dB)	PA (dB)
AV	5.7738G	102.29	Inf	-Inf	10.31	3	Vertical	6	2.15	-	91.98	32.00	7.67	29.36
PK	5.6442G	67.35	68.20	-0.85	9.90	3	Vertical	6	2.15	-	57.45	31.72	7.54	29.36
PK	5.769G	111.58	Inf	-Inf	10.31	3	Vertical	6	2.15	-	101.27	32.00	7.67	29.36
PK	5.9286G	66.16	68.20	-2.04	10.79	3	Vertical	6	2.15	-	55.37	32.31	7.83	29.35



802.11ac VHT80_Nss1,(MCS0)_2TX

29/05/2020

5775MHz_TX

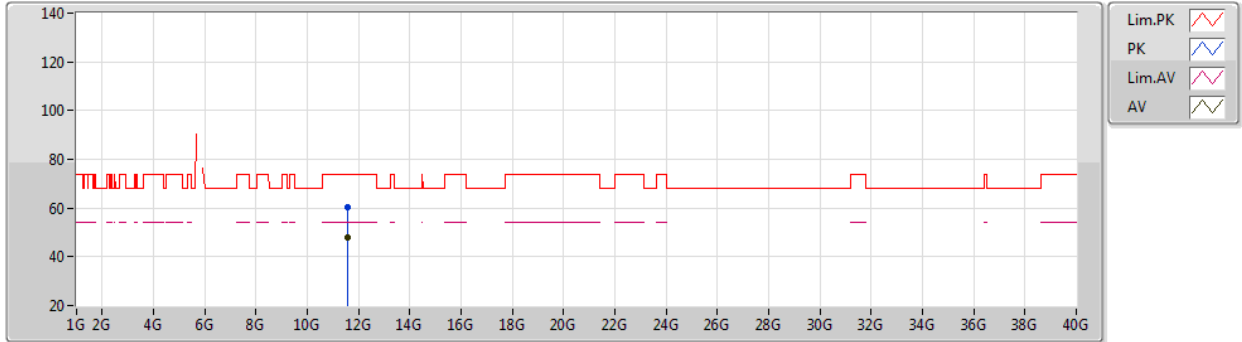

Type	Freq (Hz)	Level (dBuV/m)	Limit (dBuV/m)	Margin (dB)	Factor (dB)	Dist (m)	Condition	Azimuth (°)	Height (m)	Comment	Raw (dBuV)	AF (dB)	CL (dB)	PA (dB)
AV	11.54988G	47.97	54.00	-6.03	19.44	3	Vertical	184	2.26	-	28.53	39.95	10.27	30.78
PK	11.55648G	60.28	74.00	-13.72	19.44	3	Vertical	184	2.26	-	40.84	39.94	10.28	30.78



802.11ac VHT80_Nss1,(MCS0)_2TX

29/05/2020

5775MHz_TX

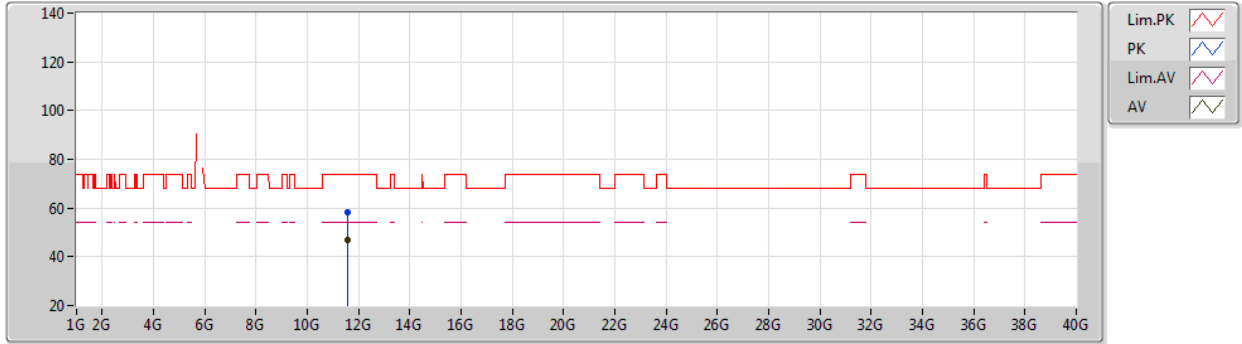

Type	Freq (Hz)	Level (dBuV/m)	Limit (dBuV/m)	Margin (dB)	Factor (dB)	Dist (m)	Condition	Azimuth (°)	Height (m)	Comment	Raw (dBuV)	AF (dB)	CL (dB)	PA (dB)
AV	11.56062G	46.85	54.00	-7.15	19.44	3	Horizontal	104	1.50	-	27.41	39.94	10.28	30.78
PK	11.55492G	58.19	74.00	-15.81	19.45	3	Horizontal	104	1.50	-	38.74	39.95	10.28	30.78