



FCC RADIO TEST REPORT

Applicant : Kaijet Technology International Corporation
Address : 8F., No. 109, Zhongcheng Road, Tucheng Dist.,
New Taipei City, Taiwan R.O.C
Equipment : USI Stylus Pen for Chromebook
Model No. : JITP100
Trade Name : j5create
FCC ID. : 2AD37JITP100

I HEREBY CERTIFY THAT :

The sample was received on May. 25, 2021 and the testing was completed on Jul. 01, 2021 at CerpPASS Technology Corp. The test result refers exclusively to the test presented test model / sample. Without written approval of CerpPASS Technology Corp., the test report shall not be reproduced except in full.

Approved by:

Mark Liao / Supervisor

Laboratory Accreditation:

CerpPASS Technology Corporation Test Laboratory





CONTENTS

- 1. Summary of Test Procedure and Test Results.....4**
 - 1.1 Applicable Standards4
- 2. Test Configuration of Equipment under Test5**
 - 2.1 Feature of Equipment under Test.....5
 - 2.1 Carrier Frequency of Channels5
 - 2.2 Test Mode and Test Software5
 - 2.3 Description of Test System.....6
 - 2.4 General Information of Test.....7
 - 2.5 Measurement Uncertainty7
- 3. Test Equipment and Ancillaries Used for Tests8**
- 4. Antenna Requirements9**
 - 4.1 Standard Applicable9
 - 4.2 Antenna Construction and Directional Gain.....9
- 5. Test of AC Power Line Conducted Emission10**
 - 5.1 Test Limit10
 - 5.2 Test Procedures10
 - 5.3 Typical Test Setup11
 - 5.4 Test Result and Data12
- 6. Test of Spurious Emission (Radiated)13**
 - 6.1 Test Limit13
 - 6.2 Test Procedures14
 - 6.3 Typical Test Setup15
 - 6.4 Test Result and Data (9kHz ~ 30MHz).....16
 - 6.5 Test Result and Data (30MHz ~ 1GHz).....20
 - 6.6 Restricted Bands of Operation22
 - 6.7 Test Photographs (9kHz ~ 30MHz)23
 - 6.8 Test Photographs (30MHz ~ 1GHz)24



History of this test report

Report No.	Issue Date	Description
21050177-TRFCC01	Jul. 22, 2021	Original



1. Summary of Test Procedure and Test Results

1.1 Applicable Standards

ANSI C63.10:2013

FCC Rules and Regulations Part 15 Subpart C §15.209

FCC Rule	Description of Test	Result
15.203	Antenna Requirement	PASS
15.207	AC Power Line Conducted Emission	N/A
15.209 15.205	Radiated Spurious Emission	PASS

*The lab has reduced the uncertainty risk factor from test equipment, environment and staff technicians which according to the standard on contract. Therefore, the test result will only be determined by standard requirement.

*This EUT has been also tested and compiled with the requirement of FCC Part 15, Subpart B, recorded in a separate test report(21050177- TEFV01).



2. Test Configuration of Equipment under Test

2.1 Feature of Equipment under Test

Frequency Range	111KHz~489KHz
Modulation Type	FSK
Antenna Type	Internal Antenna
Antenna Gain	0dBi

Note: For more details, please refer to the User's manual of the EUT.

2.1 Carrier Frequency of Channels

Frequency(KHz)
250

2.2 Test Mode and Test Software

- a. During testing, the interface cables and equipment positions were varied according to ANSI C63.10.
- b. The complete test system included Notebook and EUT for RF test.
- c. Hardware control was executed to transmit data via 250KHz.
- d. The following test modes were performed for the test:

Test Mode	Operating Description
1	250KHz



2.3 Description of Test System

Radiated Emissions				
Equipment	Brand	Model	Length/Type	Power cord/Length/Type
Notebook	ASUS	C436FA-0111A10510U	N/A	N/A
Adapter	ASUS	ADP-45EW B	N/A	Adapter / 1.8m / NS



2.4 General Information of Test

Test Site	CerpPASS Technology Corporation Test Laboratory Address: No.10, Ln. 2, Lianfu St., Luzhu Dist., Taoyuan City 33848, Taiwan (R.O.C.) Tel:+886-3-3226-888 Fax:+886-3-3226-881	
	FCC	TW1439, TW1079
	IC	4934E-1, 4934E-2
	VCCI	T-2205 for Telecommunication test C-4663 for Conducted emission test R-4218 for Radiated emission test G-10812, G-10813 for radiated disturbance above 1GHz
Frequency Range Investigated:	Conducted: from 150kHz to 30 MHz Radiation: from 30 MHz to 1,000MHz	
Test Distance:	9KHz~30MHz: radiated emission from antenna to EUT is 1 M. 30MHz~1GHz: radiated emission from antenna to EUT is 3 M.	

Test Item	Test Site	Test Period	Environmental Conditions	Tested By
Radiated Emissions	3M02-NK	2021/07/01	23°C / 42%	Nick Guan

2.5 Measurement Uncertainty

Measurement Item	Uncertainty
Radiated Spurious Emission(9KHz~30MHz)	±3.4dB
Radiated Spurious Emission(30MHz~1GHz)	±5.6dB



3. Test Equipment and Ancillaries Used for Tests

Test Item	Radiated Emissions				
Test Site	Semi Anechoic Room(3M02-NK)				
Instrument	Manufacturer	Model No	Serial No	Calibration Date	Valid Date
Bilog Antenna	Schwarzbeck	VULB9168	369	2021/04/26	2022/04/25
Active Loop Antenna	EMCO	6507	40855	2021/06/10	2022/06/09
EMI Receiver	ROHDE & SCHWARZ	ESCI	101200	2020/09/11	2021/09/10
Spectrum Analyzer	ROHDE & SCHWARZ	FSV 40-N	102151	2020/08/03	2021/08/02
Preamplifier	EM Electronics corp.	EM330	60658	2020/10/20	2021/10/19
Preamplifier	EM Electronics corp.	EM330	60660	2021/03/18	2022/03/17
Preamplifier	Agilent	8449B	3008A01954	2021/03/22	2022/03/21
Cable-3in1(30M-1G)	HARBOUR INDUSTRIES	LL142	CCE1315	2021/04/12	2022/04/11
Cable-0.5m(30M-40G)	HUBER SUHNER	SUCOFLEX 102	28420/2	2021/04/03	2022/04/02
Cable-3m(30M-40G)	HUBER SUHNER	SUCOFLEX 102	MY2608/2	2021/04/09	2022/04/08
Cable-6m(9k~300M)	NA	EMC5D-BM-BM-6	130605	2020/09/18	2021/09/17
E3	AUDIX	v8.2014-8-6	RK-000529	NA	NA



4. Antenna Requirements

4.1 Standard Applicable

For intentional device, according to FCC 47 CFR Section 15.203, an intentional radiator shall be designed to ensure that no antenna other than that furnished by the responsible party shall be used with the device.

And according to FCC 47 CFR Section 15.247 (b), if transmitting antennas of directional gain greater than 6dBi are used, the power shall be reduced by the amount in dB that the directional gain of the antenna exceeds 6dBi.

4.2 Antenna Construction and Directional Gain

Antenna Type	Internal Antenna
Antenna Gain	0dBi



5. Test of AC Power Line Conducted Emission

The power supply is DC source, so this item doesn't require testing.

5.1 Test Limit

Conducted Emissions were measured from 150 kHz to 30 MHz with a bandwidth of 9 KHz, according to the methods defined in ANSI C63.4-2014. The EUT was placed on a nonmetallic stand in a shielded room 0.8 meters above the ground plane. The interface cables and equipment positioning were varied within limits of reasonable applications to determine the position produced maximum conducted emissions.

Frequency (MHz)	Quasi Peak (dB μ V)	Average (dB μ V)
0.15 – 0.5	66-56*	56-46*
0.5 – 5.0	56	46
5.0 – 30.0	60	50

*Decreases with the logarithm of the frequency.

5.2 Test Procedures

- a. The EUT was placed 0.4 meter from the conducting wall of the shielding room was kept at least 80 centimeters from any other grounded conducting surface.
- b. Connect EUT to the power mains through a line impedance stabilization network (LISN).
- c. All the support units are connecting to the other LISN.
- d. The LISN provides 50 ohm coupling impedance for the measuring instrument.
- e. The FCC states that a 50 ohm, 50 micro-Henry LISN should be used.
- f. Both sides of AC line were checked for maximum conducted interference.
- g. The frequency range from 150 kHz to 30 MHz was searched.
- h. Set the test-receiver system to Peak Detect Function and Specified Bandwidth with Maximum Hold Mode.



5.3 Typical Test Setup

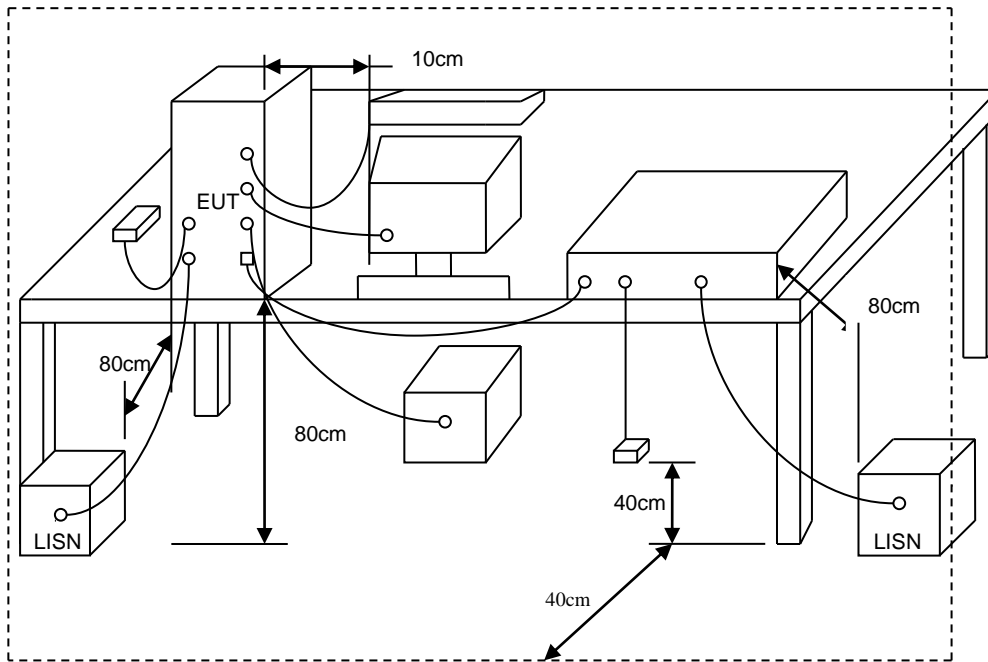



5.4 Test Result and Data

The power supply is DC source, so this item doesn't require testing.



6. Test of Spurious Emission (Radiated)

6.1 Test Limit

In any 100kHz bandwidth outside the frequency band in which the spread spectrum or digitally modulated intentional radiator is operating, the radio frequency power that is produced by the intentional radiator shall be at least 20dB below that in the 100kHz bandwidth within the band that contains the highest level of the desired power, based on either an RF conducted or a radiated measurement. If the transmitter measurement is based on the maximum conducted output power, the attenuation required under this paragraph shall be 30dB instead of 20dB. In addition, radiated emissions which fall in section 15.205(a) the restricted bands must also comply with the radiated emission limit specified in section 15.209(a).

Frequency (MHz)	Field Strength (microvolt/meter)	Measurement Distance (meters)
0.009 ~ 0.490	2400/F(kHz)	300
0.490 ~ 1.705	24000/F(kHz)	30
1.705 ~ 30.0	30	30
30 ~ 88	100	3
88 ~ 216	150	3
216 ~ 960	200	3
Above 960	500	3



6.2 Test Procedures

- a. The EUT was placed on a rotatable table top 0.8 meter above ground.
- b. The EUT was set 3 meters from the interference receiving antenna which was mounted on the top of a variable height antenna tower.
- c. The table was rotated 360 degrees to determine the position of the highest radiation.
- d. The antenna is a broadband antenna and its height is varied between one meter and four meters above ground to find the maximum value of the field strength both horizontal polarization and vertical polarization of the antenna are set to make the measurement.
- e. For each suspected emission the EUT was arranged to its worst case and then tune the antenna tower (from 1 M to 4 M) and turn table (from 0 degree to 360 degrees) to find the maximum reading.
- f. Set the test-receiver system to Peak or CISPR quasi-peak Detect Function and specified bandwidth with Maximum Hold Mode.
- g. If the emission level of the EUT in peak mode was 3 dB lower than the limit specified, then testing will be stopped and peak values of EUT will be reported, otherwise, the emissions which do not have 3 dB margin will be repeated one by one using the quasi-peak method and reported.
- h. For testing above 1GHz, the emission level of the EUT in peak mode was 20dB lower than average limit (that means the emission level in peak mode also complies with the limit in average mode), then testing will be stopped and peak values of EUT will be reported, otherwise, the emissions will be measured in average mode again and reported.
- i. "Cone of radiation" has been considered to be 3dB bandwidth of the measurement antenna.

Note: The supporting fixture shall permit orientation of the EUT in each of three orthogonal axis positions such that emissions from the EUT are maximized.
(Y-AXIS is the worst.)



6.3 Typical Test Setup

Below 30MHz test setup

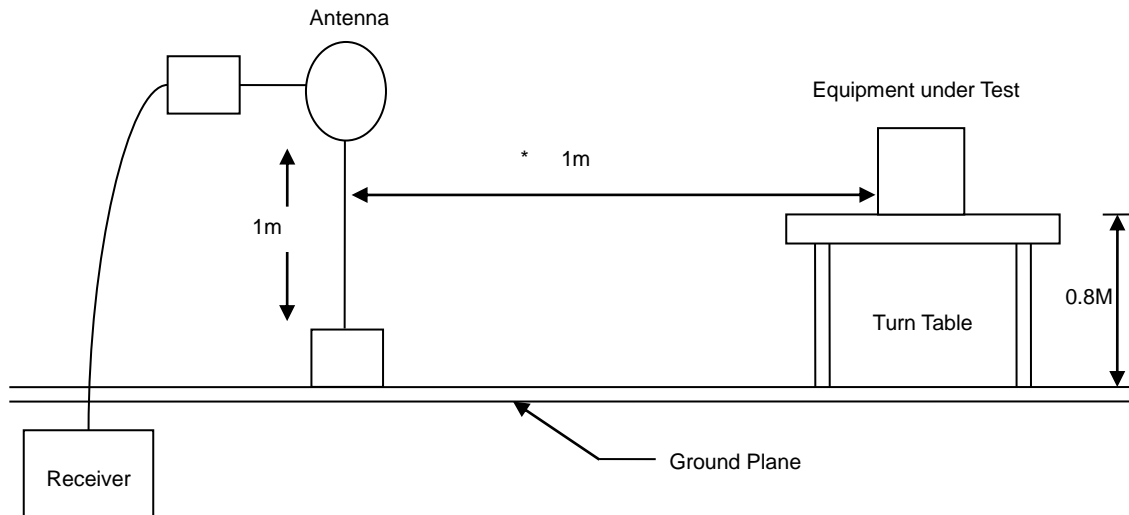

30MHz- 1GHz Test Setup

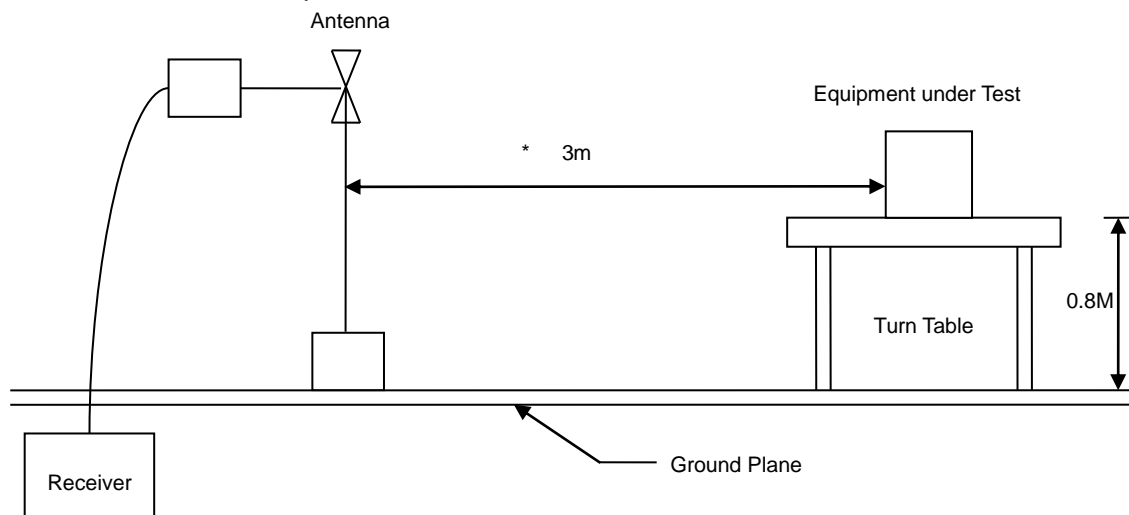



6.4 Test Result and Data (9kHz ~ 30MHz)

Power	: DC 1.5V From Battery	Pol/Phase	: OPEN
Test Mode	: Mode 1		

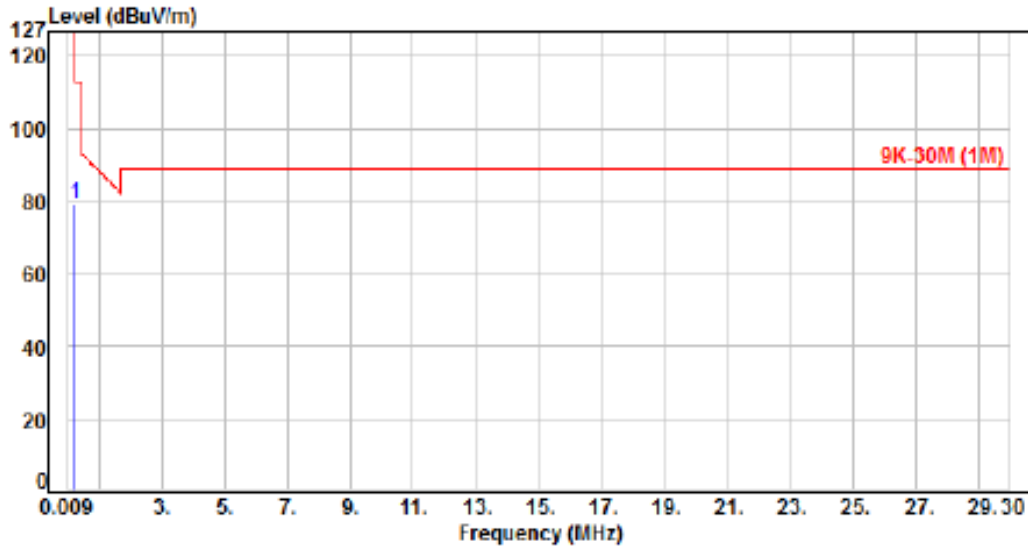

No.	Frequency (MHz)	Factor (dB)	Reading (dBuV)	Level (dBuV/m)	Limit (dBuV/m)	Margin (dB)	Detector	Height (cm)	Azimuth (deg)	P/F
1	0.25	18.51	60.69	79.20	118.73	-39.53	Average	100	237	P

Note: Level=Reading+Factor
Margin=Level-Limit
Factor=Antenna Factor + cable loss - Amplifier Factor



Power	: DC 1.5V From Battery	Pol/Phase	: CLOSE
Test Mode	: Mode 1		:

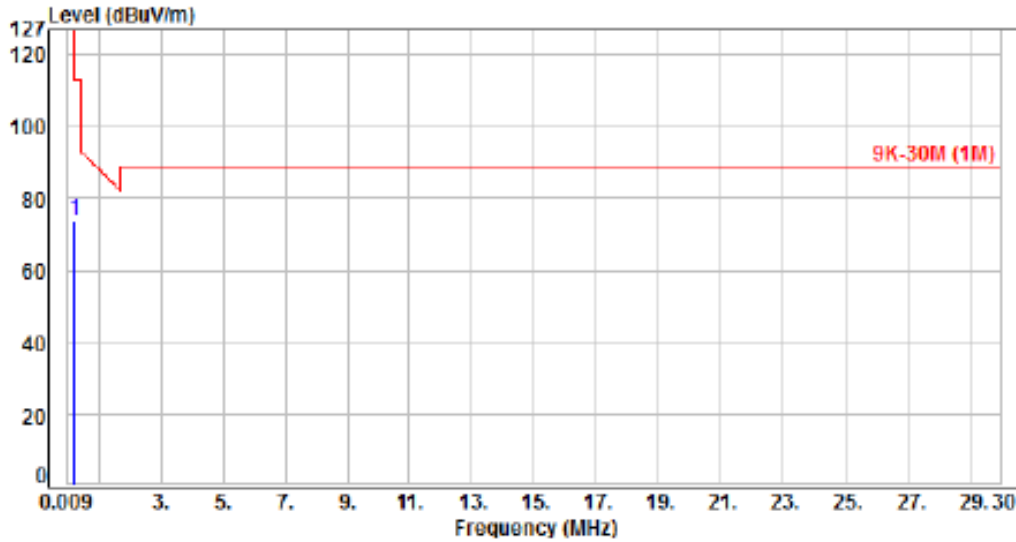

No.	Frequency (MHz)	Factor (dB)	Reading (dBuV)	Level (dBuV/m)	Limit (dBuV/m)	Margin (dB)	Detector	Height (cm)	Azimuth (deg)	P/F
1	0.25	18.51	55.40	73.91	118.73	-44.82	Average	100	182	P

Note: Level=Reading+Factor
Margin=Level-Limit
Factor=Antenna Factor + cable loss - Amplifier Factor



Power	: DC 1.5V From Battery	Pol/Phase	: OPEN
Test Mode	: Mode 1		:

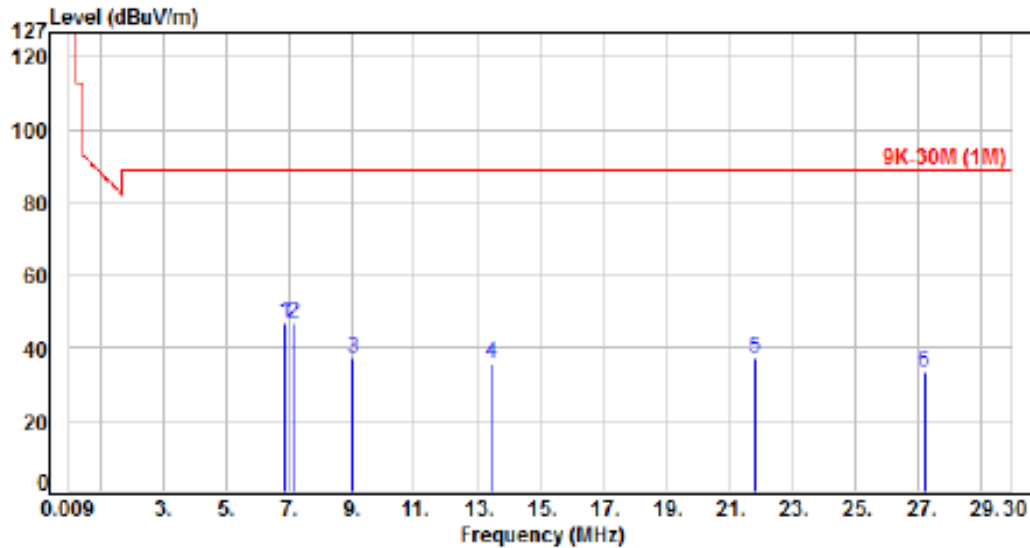

No.	Frequency (MHz)	Factor (dB)	Reading (dBuV)	Level (dBuV/m)	Limit (dBuV/m)	Margin (dB)	Detector	Height (cm)	Azimuth (deg)	P/F
1	6.88	16.92	30.01	46.93	88.63	-41.70	Peak	100	231	P
2	7.14	16.96	29.94	46.90	88.63	-41.73	Peak	100	233	P
3	9.04	17.33	20.07	37.40	88.63	-51.23	Peak	100	246	P
4	13.40	17.40	18.40	35.80	88.63	-52.83	Peak	100	284	P
5	21.82	17.03	20.05	37.08	88.63	-51.55	Peak	100	263	P
6	27.18	16.51	16.74	33.25	88.63	-55.38	Peak	100	292	P

Note: Level=Reading+Factor
 Margin=Level-Limit
 Factor=Antenna Factor + cable loss - Amplifier Factor



Power	: DC 1.5V From Battery	Pol/Phase	: CLOSE
Test Mode	: Mode 1		:

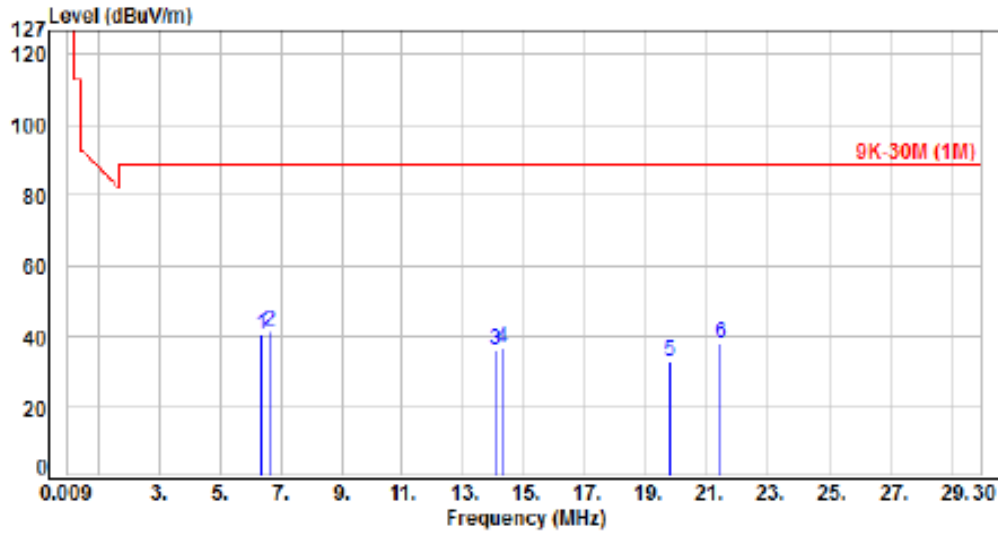

No.	Frequency (MHz)	Factor (dB)	Reading (dBuV)	Level (dBuV/m)	Limit (dBuV/m)	Margin (dB)	Detector	Height (cm)	Azimuth (deg)	P/F
1	6.38	16.82	23.80	40.62	88.63	-48.01	Peak	100	172	P
2	6.64	16.88	24.68	41.56	88.63	-47.07	Peak	100	157	P
3	14.03	17.39	18.84	36.23	88.63	-52.40	Peak	100	138	P
4	14.25	17.38	19.11	36.49	88.63	-52.14	Peak	100	151	P
5	19.78	17.21	15.60	32.81	88.63	-55.82	Peak	100	162	P
6	21.42	17.07	21.10	38.17	88.63	-50.46	Peak	100	122	P

Note: Level=Reading+Factor
 Margin=Level-Limit
 Factor=Antenna Factor + cable loss - Amplifier Factor



6.5 Test Result and Data (30MHz ~ 1GHz)

Power	: DC 1.5V From Battery	Pol/Phase	: VERTICAL
Test Mode	: Mode 1		

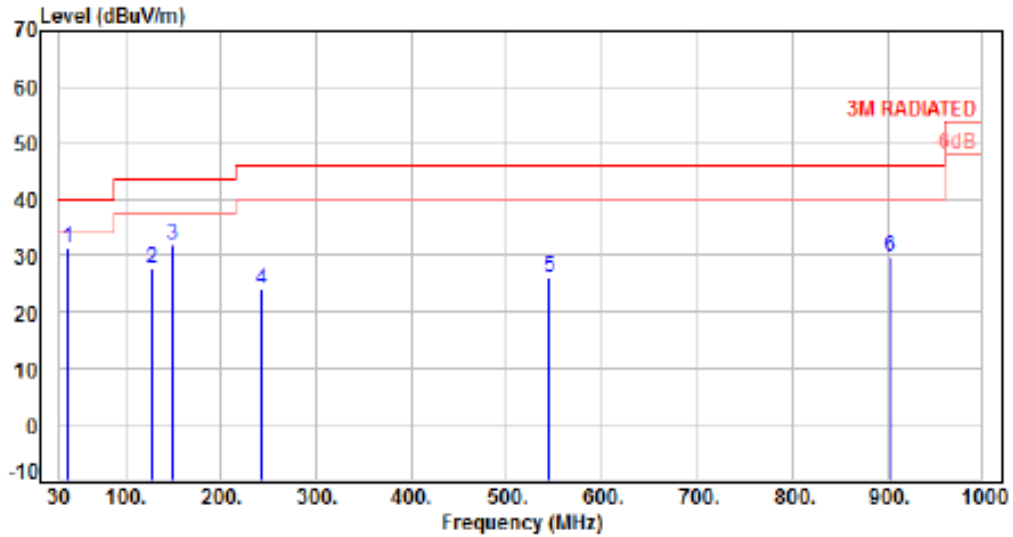

No.	Frequency (MHz)	Factor (dB)	Reading (dBuV)	Level (dBuV/m)	Limit (dBuV/m)	Margin (dB)	Detector	Height (cm)	Azimuth (deg)	P/F
1	38.73	-11.13	42.58	31.45	40.00	-8.55	Peak	400	360	P
2	127.80	-12.26	39.84	27.58	43.50	-15.92	Peak	400	360	P
3	149.31	-10.89	42.78	31.89	43.50	-11.61	Peak	400	360	P
4	243.40	-11.81	35.80	23.99	46.00	-22.01	Peak	400	360	P
5	544.10	-3.91	30.25	26.34	46.00	-19.66	Peak	400	360	P
6	982.03	1.96	27.80	29.76	46.00	-16.24	Peak	400	360	P

Note: Level=Reading+Factor
Margin=Level-Limit
Factor=Antenna Factor + cable loss - Amplifier Factor



Power	: DC 1.5V From Battery	Pol/Phase	: HORIZONTAL
Test Mode	: Mode 1		:

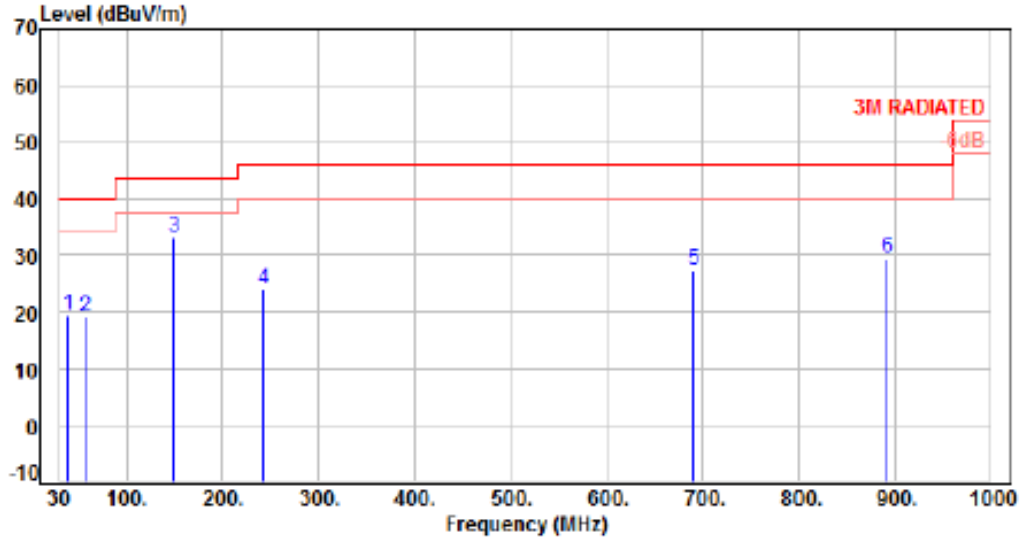

No.	Frequency (MHz)	Factor (dB)	Reading (dBuV)	Level (dBuV/m)	Limit (dBuV/m)	Margin (dB)	Detector	Height (cm)	Azimuth (deg)	P/F
1	39.70	-11.00	30.41	19.41	40.00	-20.59	Peak	400	0	P
2	58.13	-11.40	30.63	19.23	40.00	-20.77	Peak	400	0	P
3	149.31	-10.89	44.04	33.15	43.50	-10.35	Peak	400	0	P
4	243.40	-11.81	35.74	23.93	46.00	-22.07	Peak	400	0	P
5	690.57	-1.21	28.70	27.49	46.00	-18.51	Peak	400	0	P
6	891.36	1.67	27.95	29.62	46.00	-16.38	Peak	400	0	P

Note: Level=Reading+Factor
 Margin=Level-Limit
 Factor=Antenna Factor + cable loss - Amplifier Factor



6.6 Restricted Bands of Operation

Only spurious emissions are permitted in any of the frequency bands listed below:

MHz	MHz	MHz	GHz
0.09000 – 0.11000	16.42000 – 16.42300	399.9 – 410.0	4.500 – 5.250
0.49500 – 0.505**	16.69475 – 16.69525	608.0 – 614.0	5.350 – 5.460
2.17350 – 2.19050	16.80425 – 16.80475	960.0 – 1240.0	7.250 – 7.750
4.12500 – 4.12800	25.50000 – 25.67000	1300.0 – 1427.0	8.025 – 8.500
4.17725 – 4.17775	37.50000 – 38.25000	1435.0 – 1626.5	9.000 – 9.200
4.20725 – 4.20775	73.00000 – 74.60000	1645.5 – 1646.5	9.300 – 9.500
6.21500 – 6.21800	74.80000 – 75.20000	1660.0 – 1710.0	10.600 – 12.700
6.26775 – 6.26825	108.00000 – 121.94000	1718.8 – 1722.2	13.250 – 13.400
6.31175 – 6.31225	123.00000 – 138.00000	2200.0 – 2300.0	14.470 – 14.500
8.29100 – 8.29400	149.90000 – 150.05000	2310.0 – 2390.0	15.350 – 16.200
8.36200 – 8.36600	156.52475 – 156.52525	2483.5 – 2500.0	17.700 – 21.400
8.37625 – 8.38675	156.70000 – 156.90000	2655.0 – 2900.0	22.010 – 23.120
8.41425 – 8.41475	162.01250 – 167.17000	3260.0 – 3267.0	23.600 – 24.000
12.29000 – 12.29300	167.72000 – 173.20000	3332.0 – 3339.0	31.200 – 31.800
12.51975 – 12.52025	240.00000 – 285.00000	3345.8 – 3358.0	36.430 – 36.500
12.57675 – 12.57725	322.00000 – 335.40000	3600.0 – 4400.0	Above 38.6
13.36000 – 13.41000			

** : Until February 1, 1999, this restricted band shall be 0.490-0.510 MHz