



5-IN-1 WIRELESS WEATHER STATION WITH WI-FI USER GUIDE

LOWSC510WB



Thank you for purchasing the **Logia™ 5-in-1 Wireless Weather Station with WI-FI**. This User Guide is intended to provide you with guidelines to ensure that operation of this product is safe and does not pose risk to the user. Any use that does not conform to the guidelines described in this User Guide may void the limited warranty.

Please read all directions before using the product and retain this guide for reference. This product is intended for household use only. It is not intended for commercial use.

This product is covered by a limited one-year warranty. Coverage is subject to limits and exclusions. See warranty for details.

■ TABLE OF CONTENTS

SAFETY PRECAUTIONS	3
PRODUCT FEATURES	4
PACKAGE CONTENTS	5
DISPLAY CONSOLE OVERVIEW	6
LCD DISPLAY OVERVIEW	7
WIRELESS WEATHER SENSOR OVERVIEW	8
WIRELESS WEATHER SENSOR SETUP	10
DISPLAY CONSOLE SETUP	13
CREATE YOUR WEATHER SERVER ACCOUNT & SET UP WI-FI CONNECTION	15
CREATE YOUR WEATHERCLOUD ACCOUNT	17
SET UP WI-FI CONNECTION	18
ADVANCED SETTINGS VIA WEB INTERFACE	20
VIEW YOUR WEATHER DATA IN WEATHER UNDERGROUND	22
VIEW YOUR WEATHER DATA IN WEATHERCLOUD	22
OTHER CONSOLE SETTINGS AND FUNCTIONS	24
SETTING THE ALARM	26
WIND READOUTS	28
WEATHER FORECAST	30
BAROMETRIC PRESSURE	30
RAINFALL	31
WEATHER ALERT SETTINGS	32
CARE AND MAINTENANCE	34
SPECIFICATIONS	35
QUESTIONS?	39

■ SAFETY PRECAUTIONS

1. Do not let children use or play with this device. It is not a toy.
2. Do not use any attachments not supplied or recommended by the manufacturer.
3. Do not place the appliance near open flames or heat sources. Fire, electric shock, product damage, or injury might occur.
4. Do not mix old and new batteries in the display unit.
5. A low battery symbol  will appear in the OUT or CH sections of the LCD display when battery power is low on the console or weather sensor, respectively. Be sure to change the batteries promptly to ensure the proper operation of the weather station.
6. Do not subject the display unit to excessive force or shock (do not throw the unit!), dust, extreme high or low temperatures, or humidity/moisture. These can cause the unit to stop functioning as well as present the risk of shock, fire, or other hazards.
7. Do not cover the ventilation holes on the display with newspapers, curtains, or any other items.
8. Never immerse the display in water! If you spill any liquid on the display, dry it immediately with a soft, lint-free cloth.
9. Do not use abrasive or corrosive materials to clean the display.
10. Do not tamper with the display or the weather vane's internal components. This invalidates your limited warranty.
11. Placing this product on certain types of wood may result in unintended damage to the finish, for which Logia™ will not be responsible. Consult your furniture manufacturer's instructions for information on wood care.
12. Do not dispose of old batteries as unsorted municipal waste. Make sure to dispose of them properly according to your local guidelines.
13. The main display console is only intended for use indoors.

QUESTIONS OR PROBLEMS? CONTACT US!

Email: info@supportcbp.com or call: 1-833-815-0568
www.logiaweatherstation.com

■ PRODUCT FEATURES

1. Wireless 5-in-1 weather sensor measures wind speed, wind direction, rainfall, temperature, and humidity.
2. No calibration needed! The product is fully pre-calibrated and mostly assembled; all you need to do is install it and sync with the included display console.
3. Provides precise weather and environmental information directly from your own backyard, instead of relying on a national weather station.
4. Color LCD display with dimmable backlight.
5. Can alert you to excessively high/low indoor or outdoor temperatures or humidity, high wind speeds, extreme drops in barometric pressure, high heat indexes, low wind chills, and high/low dew points.
6. Syncs with installed WI-FI and online weather servers (Weather Underground and Weathercloud) to help you store and track weather data in your area, plus view live weather statistics and historical weather trends.

PACKAGE CONTENTS

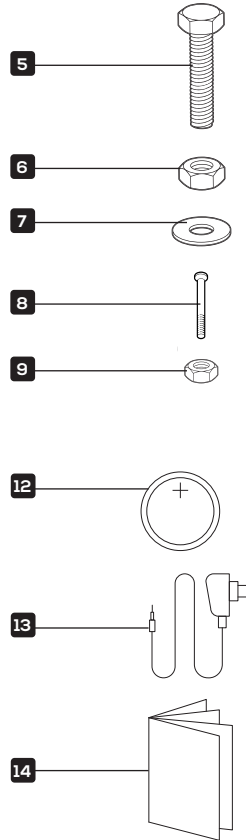
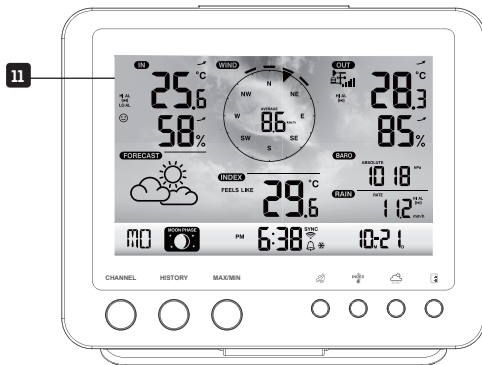
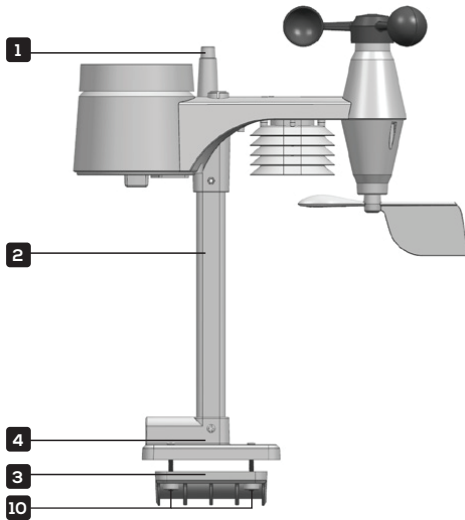

- | | | |
|--|------------------------------------|--|
| 1. Wireless Weather Sensor (1) | 6. Large Hexagonal Nuts (4) | 11. Display Console with Kickstand (1) |
| 2. Mounting Pole (1)
Plastic Exterior | 7. Large Washers (4) | 12. Display Console Battery (1) |
| 3. Mounting Clamp (1) | 8. Small Screws (2) | 13. Display Console Power Cable (1) |
| 4. Mounting Base (1) | 9. Small Hexagonal Nuts (2) | 14. User Guide |
| 5. Large Mounting Screws (4) | 10. Rubber Pads for Mounting Clamp | |

■ DISPLAY CONSOLE OVERVIEW

MAIN CONSOLE OVERVIEW

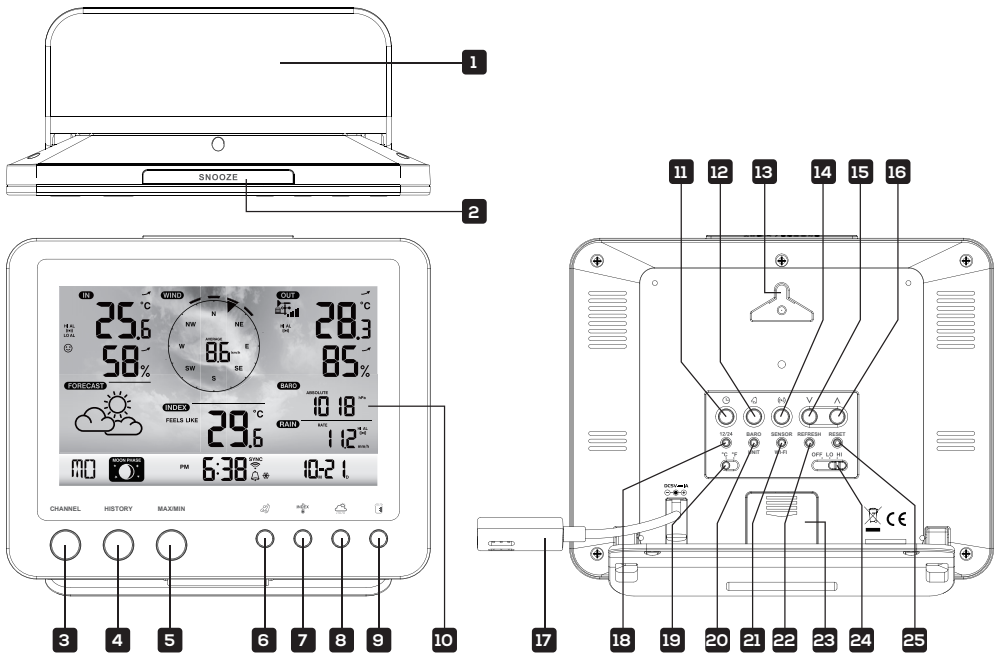

- | | |
|-------------------|--|
| 1. Kickstand | 10. LCD Display (See overview on page 7) |
| 2. SNOOZE button | 11. CLOCK SET button |
| 3. CHANNEL button | 12. ALARM button |
| 4. HISTORY button | 13. Wall mount notch |
| 5. MAX/MIN button | 14. ALERT button |
| 6. WIND button | 15. ▼ button |
| 7. INDEX button | 16. ▲ button |
| 8. BARO button | 17. Power connection |
| 9. RAIN button | |

- | |
|-------------------------|
| 18. 12/24 button |
| 19. °C/°F button |
| 20. BARO UNIT button |
| 21. SENSOR/WI-FI button |
| 22. REFRESH button |
| 23. Battery compartment |
| 24. OFF/LO/HI button |
| 25. RESET button |

LCD DISPLAY OVERVIEW

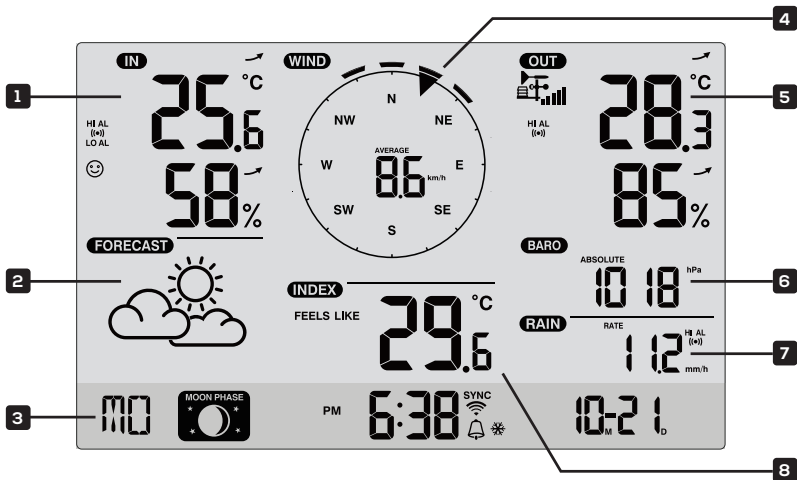

1. Temperature & humidity (indoor/CH)
2. Weather forecast
3. Time, date, & moon phase
4. Wind speed & direction
5. Temperature & humidity (outdoor)
6. Barometer
7. Rainfall
8. Weather index

WIRELESS WEATHER SENSOR OVERVIEW

MAIN DEVICE

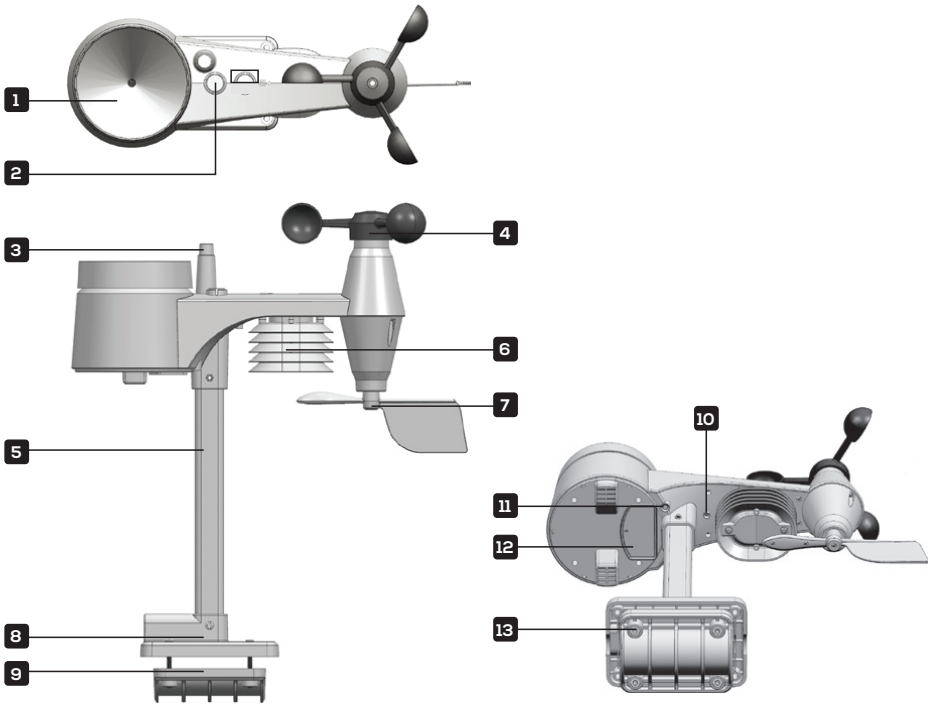

1. Rain collector
2. Level
3. Antenna
4. Wind cups (anemometer)
5. Mounting pole
6. Sensor casing
7. Wind vane
8. Mounting base
9. Mounting clamp
10. Red LED indicator
11. RESET button
12. Battery compartment
13. Mounting clamp screws

RAIN GAUGE

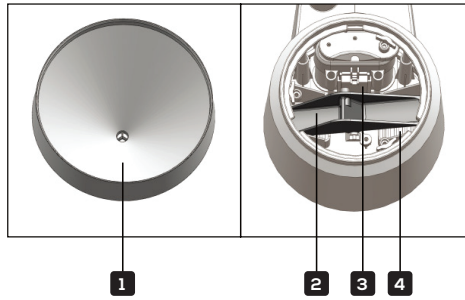

1. Rain collector
2. Tipping bucket
3. Rain sensor
4. Drain holes

TEMPERATURE AND HUMIDITY SENSOR

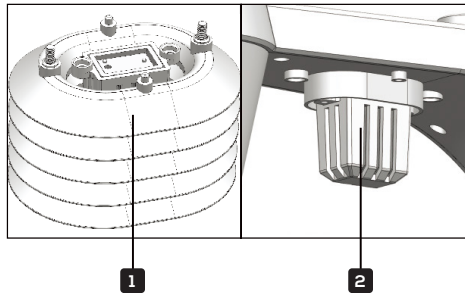

1. Sensor shield
2. Temperature and humidity sensor

WIND SENSOR

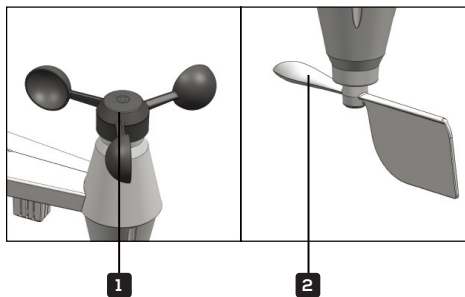

1. Wind cups (anemometer)
2. Wind vane

■ WIRELESS WEATHER SENSOR SETUP

INSTALL BATTERIES

1. Unscrew the door to the battery compartment on the underside of the main sensor unit.
2. Insert three (3) new AA alkaline batteries, making sure the polarities match up with the markings inside the compartment.

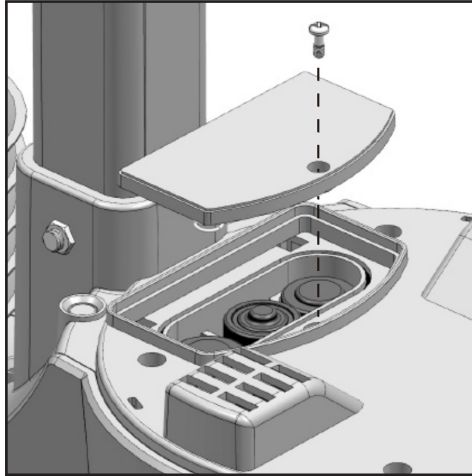

3. Replace the battery door, ensuring the watertight O-ring is properly aligned. This maintains the water-resistant seal.
4. Replace the battery screw, making sure it is tightly fastened down. The red LED should begin flashing every 12 seconds.

ASSEMBLE STAND AND POLE

1. Insert the top of the pole into the square hole at the bottom of the weather sensor. Ensure that the arrow indicators are lined up as shown.

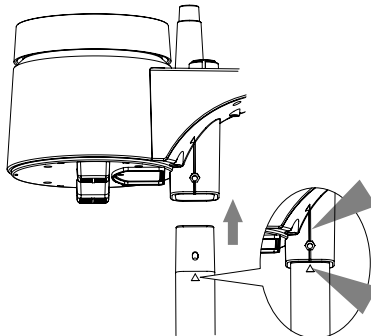

2. Insert the nut into the hexagonal hole by the sensor and hold it in place, then insert the screw through the other side. Use a screwdriver to tighten the screw. Do not insert the screw first, or the nut may not line up correctly with the designated hole.

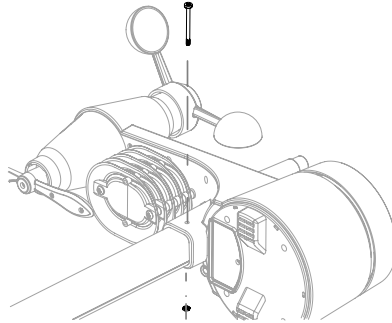

3. Insert the bottom of the pole into the square hole on the plastic stand, making sure the arrows are lined up as shown.

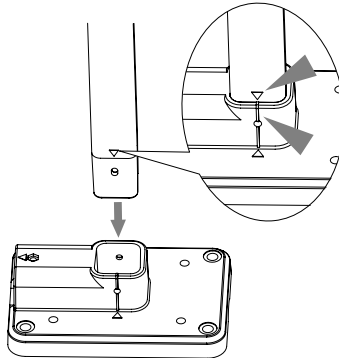

Please note that there are two different ways you can attach the pole to the base, depending on how you will be mounting it outdoors. If you will be fastening the sensor directly to a railing, use the option that positions the stand perpendicular to the sensor pole. If you will be fastening it to a pole, use the slot that positions the base parallel to the sensor pole.

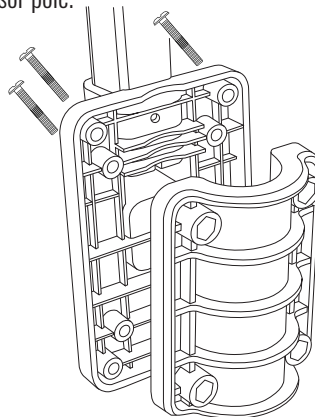

4. Insert the nut into the hexagonal hole on the side of the stand and hold it in place, then insert the screw through the other side. Use a screwdriver to tighten the screw.

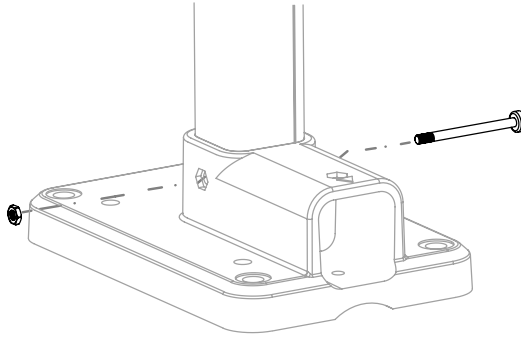

MOUNT THE SENSOR OUTDOORS

1. The wireless weather sensor should be mounted in an open area with no obstructions above and/or around it, so that it can accurately measure the rain and wind.
2. The wind vane should be pointed due North (refer to the arrow on top of the unit) in order to be properly oriented and receive accurate wind readings.
3. The mounting stand and included clamps should be secured to a post or pole, with a minimum of 4.9 ft. (1.5 m) ground clearance.
4. If securing to a pole, make sure you add the rubber pads to the clamp before fastening it with the included screws. The pole should be between 1"-1.3" in diameter.

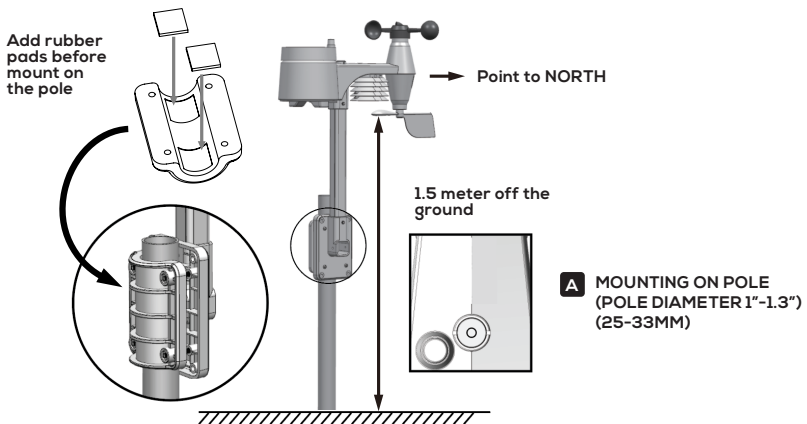

If securing to a railing, make sure the railing is made of suitable material, and screw directly through the openings in the base stand into the railing until secure.

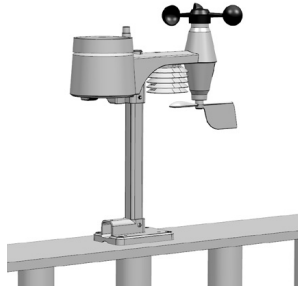

B MOUNTING ON A RAILING

5. The mounting location should be within 492 ft. (150 m) of the location where you will be keeping the display console with few obstructions and relatively clear sightlines. If there are multiple walls/buildings in between the sensor and the display console, the functionality could be compromised and you will need less space between the two.
6. Use the built-in level to make sure the sensor is parallel with the ground.

■ DISPLAY CONSOLE SETUP

Your display console can pair with the wireless weather sensor as well as up to seven (7) optional wireless hygro-thermo outdoor sensors (not included).

INSTALLING THE BACKUP BATTERY

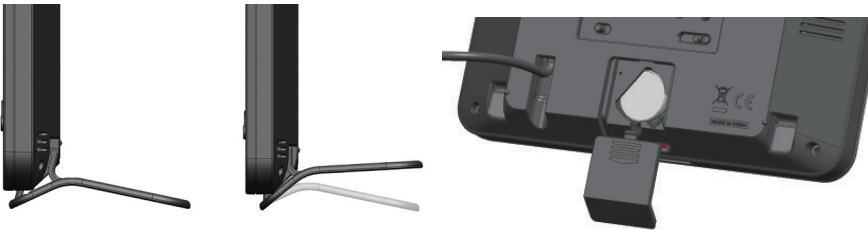

1. Remove the battery door on the rear of the console unit.
2. Insert a new button battery.
3. Replace the battery door.

NOTE: The backup battery can assist with backing up the time & date, MAX/MIN data, weather records from the past 24 hours, alert settings, the offset value of weather data, and the sensor(s) channel history. The built-in memory will backup router and weather server settings.

POWERING THE DISPLAY CONSOLE

1. Connect the power cable to a wall outlet or power source and to the display console power connection port.
2. The display console should power on, and all the segments of the LCD display screen should be shown.
3. The display console will automatically start AP mode.

NOTE: If nothing appears on the LCD display screen after you plug in the power adaptor, use a pin or similar small object to press the RESET button.

SET THE LCD DISPLAY VIEWING ANGLE

If you have the display console wall-mounted or on a table stand, the viewing angle may need adjustment. Press ▲ or ▼ buttons while the display is in normal operating mode to adjust the viewing angle.

PAIRING THE WIRELESS WEATHER SENSOR WITH THE DISPLAY CONSOLE

1. Once your display console powers on, it should automatically search for and connect to the wireless weather sensor. If the console does not connect within the first 15 minutes, refer to the following section, Changing Batteries and Manual Pairing, for instructions on manual pairing.
2. You will see the icon of an antenna blinking in the temperature and humidity (outdoor) section of the display.
3. Once the pairing process completes, the antenna icon will appear solid (not blinking), and the readings for outdoor temperature and humidity, wind speed, wind direction, and rainfall will appear in their designated sections of the LCD display.

CHANGING BATTERIES AND MANUAL PAIRING

Whenever you change the batteries in the sensor, you will need to manually repair it with the display console. Follow these instructions to manually pair your console with the sensor.

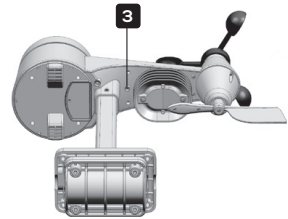
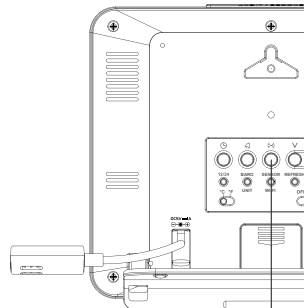
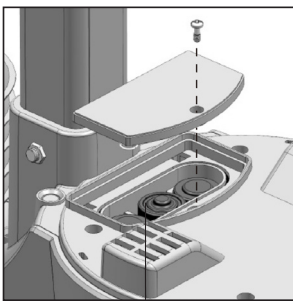

1. Change the batteries in the wireless weather sensor.
2. Press the SENSOR/WI-FI button at the back of the console.
3. Press the RESET key on the underside of the wireless weather sensor. Make sure after pressing the RESET key that the red LED indicator is flashing every 12 seconds.

NOTE: Any time you press the RESET key underneath the wireless weather sensor, it generates a new ID code for pairing with the console, and you will need to press the SENSOR/WI-FI button on the console for the two devices to pair again.

PAIRING ADDITIONAL WIRELESS SENSORS WITH THE DISPLAY CONSOLE

The display console should automatically search and pair with any additional wireless hygro-thermo outdoor sensors you install. You can also press the SENSOR/WI-FI button to search manually for the sensor while on the channel where it should display. Once your sensor has paired, the sensor signal strength indicator and weather information will appear in the temperature and humidity (outdoor) section when you are on the channel associated with that sensor.

■ CREATE YOUR WEATHER SERVER ACCOUNT & SET UP WI-FI CONNECTION

Your display console can upload weather data to Weather Underground and/or Weathercloud via your WI-FI router.

NOTE: Logia™ does not own Weather Underground or Weathercloud, and these instructions are liable to change without notice due to changes in either website.

CREATE YOUR WEATHER UNDERGROUND ACCOUNT

1. Visit the Weather Underground website at <https://www.wunderground.com> and click the link that says “JOIN”. Follow the instructions to create an account.

NOTE: Please use a valid email address to register your account.



2. Once you have created your account and completed the email validation process, return to the Weather Underground website. Click the dropdown link at the top of the site that says MORE, and then select Add Weather Station from the dropdown menu.

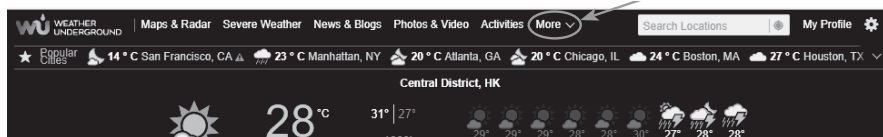

3. Follow the instructions on screen to enter your weather station information. Step 2 will ask you to enter a name for your weather station (get creative if you want, but don't forget the name you gave it!) and choose your station hardware (choose “other”). Once you complete this section, click Submit to generate your unique Station ID and key.

Step 2: Tell Us About Your Station

✔ **Your Location Has Been Added**

Address: , Frankfurt, 60323, DE
 Elevation: 328.084000 ft
 Height Above Ground: 5 ft
 Lat, Lon: 50.1148400354092, 8.717210805321628
 Time Zone:

We could not find your Time Zone, please select one from the list above to continue

Fill out the additional information about your weather station:

Neighborhood: [required] Organization:

Website:
 MADIS ID:

Station Hardware: [required] Surface Type:

Associated WebCam:

PWS Notification Email Preferences:

I would like to receive PWS notifications [?]
 I would like to receive PWS community newsletter [?]

- Write down or screenshot your Station ID and Station Key/Password for reference and to complete the setup process.

Step 3: Add Your WU Info to Your Weather Station Software

Congratulations. Your station is now registered with Wunderground!

You are almost done. Now go to your weather station software and add the following:

Your Station ID:
18

Your Station Key/Password:
qtk4on0s

It may take a few minutes or several hours for your station to start sending data to Weather Underground.
 ID and Password are case-sensitive. Process may require you to register with a 3rd party site [eg. rainwise.net].
 Check your PWS!

CREATE YOUR WEATHERCLOUD ACCOUNT

1. Visit the Weathercloud website at <https://www.weathercloud.net> and enter your information in the box that says Join Us Today. Follow the instructions to create an account.

NOTE: Please use a valid email address to register your account.

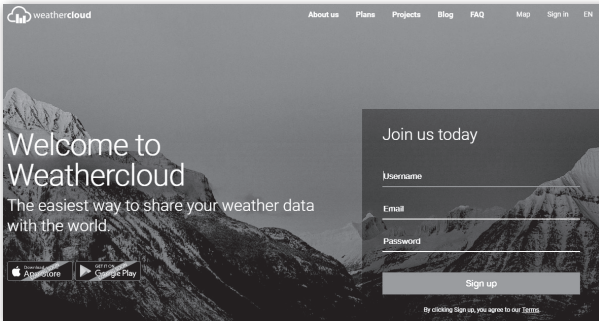

2. Once your account is created, sign into it, and then click +New to add a new device.

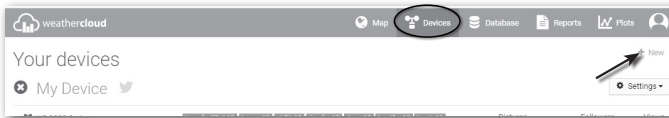

3. Enter all the requested information into the Create New Device page. When presented with the **Model** selection box, choose **LOWSC510WB Series** under the **Logia** section. When presented with the **Link Type** selection box, choose **Pro Weather Link**. Once you have completed this section, click **Create**.

4. Write down or screenshot your Weathercloud ID and Station Key/Password for reference and to complete the setup process.

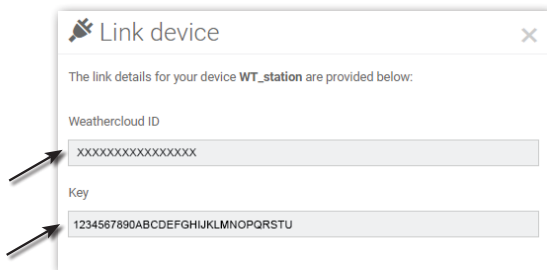

SET UP WI-FI CONNECTION

When you first power up the console, or press and hold the SENSOR/WI-FI button for six (6) seconds, the console LCD display will show the letters “AP” and an  icon to signify that it has entered Access Point (AP) mode. At this time it will be ready for the WI-FI settings to be adjusted.



Use your smartphone, tablet, or computer to connect to the console via WI-FI by following these steps:

1. On PC, open your WI-FI network settings. On Android™ or iOS devices, go to settings menu and then select Connections/WI-FI to open the network settings.
2. Locate the display console’s SSID from the list. It should appear as PWS-XXXXXX (where all the X’s are integers) in the list. Tap on the SSID to connect. This step will take several seconds.

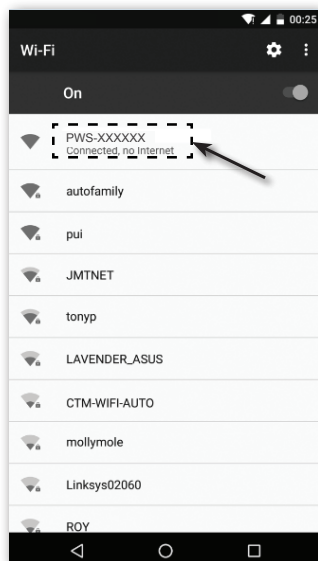
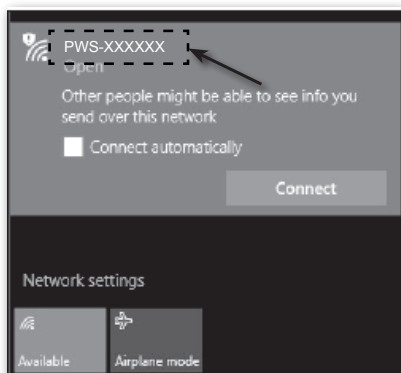

- Once you are connected to the display console, open up your internet or mobile web browser, and enter the following address into the address bar: `http://192.168.1.1` (make sure to include the `http://` or else the web browser may interpret the address as a search query). We recommend using the latest version of reputable web browsers.

SET UP WEATHER SERVER CONNECTION

Once you are connected via WI-FI to the display console and have opened the settings page at `http://192.168.1.1`, enter the following information into the web interface setup page. If you have chosen not to use Weather Underground or Weathercloud's servers, leave the check boxes unchecked.

The screenshot shows the 'Pro Weather Link' web interface with the 'SETUP' tab selected. The page is divided into several sections: 'WIFI Router setup', 'Weather server setup', and 'Time server setup'. Annotations with arrows point to specific elements:

- Language:** English (dropdown menu)
- Buttons:** 'SETUP' and 'ADVANCED' tabs; 'Search' and 'Add Router' buttons in the router setup section; 'Apply' button at the bottom.
- WIFI Router setup:**
 - Router:** Router_A (dropdown menu)
 - Security type:** WAP2 (dropdown menu)
 - Router Password:** ***** (password field)
- Weather server setup:**
 - Wunderground:** (checkbox to confirm upload)
 - Station ID:** (text field)
 - Station key:** WdW124 (password field)
 - Weathercloud:** (checkbox to confirm upload)
 - Station ID:** IPACIR23Wc (text field)
 - Station key:** (password field)
- Mac address:** 00:0E:C6:00:07:10
- Time server setup:**
 - Server URL:** nist.time.gov (dropdown menu)
- Footer:** Function firmware version: 1.00, WiFi firmware version: 1.00



SETUP page

NOTES: When the WI-FI setup is complete, your computer or mobile device will return to the default WI-FI connection. If it does not, simply open your device's wireless network settings and manually reconnect.

While in AP mode, you can press and hold the SENSOR/WI-FI button for six (6) seconds to exit AP mode. The display console will simply restore the previous AP settings.

WI-FI CONNECTION STATUS

The following icons on the LCD display screen show the WI-FI status:

		
Solid: the display console is connected to your wireless router	Flashing: the display console is attempting to connect to your wireless router	Flashing: the display console is currently in AP (access point) mode

TIME SERVER CONNECTION STATUS

Once the display console has connected to the internet, it will attempt to connect to the internet time server to obtain the UTC time. Once the connection is successful and the time has been updated, the "SYNC" icon will appear above the WI-FI icon on the LCD.



To display the correct time for your specific time zone, you'll need to change the time zone in the CLOCK setting mode from 00 (default) to your specific time zone (e.g. -5 for EST). If you don't know your time zone, you can look it up online.

1. In normal operating mode, press and hold the CLOCK SET button for two (2) seconds to enter the clock setting menu.
2. Press the ▲ or ▼ buttons to adjust the time zone, and then press and hold the CLOCK SET button for two (2) seconds to confirm and exit the menu. Please refer to the Setting the Time section of the manual on page 24 for details of other available clock settings.

The time will automatically sync with the internet time server at 12:00AM and 12:00PM each day. If you would like to force it to sync sooner than that, press the REFRESH button on the console to update the time in the next minute.

ADVANCED SETTINGS VIA WEB INTERFACE

Once you are connected via WI-FI to the display console and have opened the settings page at <http://192.168.1.1>, clicking on the tab that says ADVANCED will open the following page. This page will allow you to set and view specific calibration data of your display console, and also update the firmware if you are on PC.

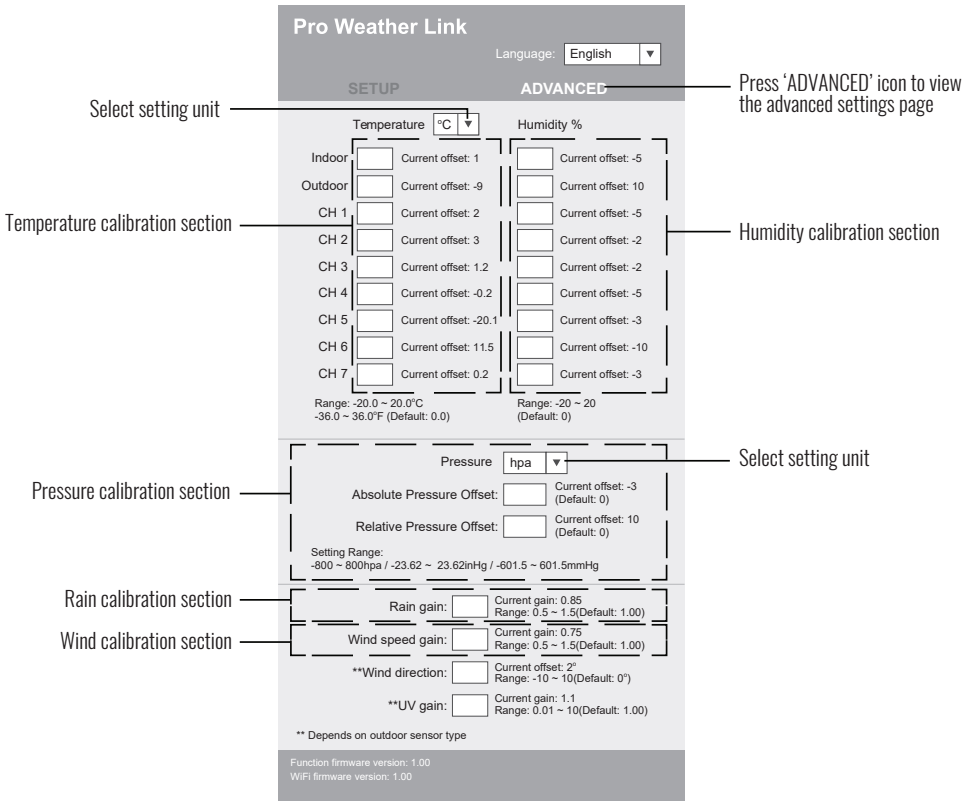

Advanced page

CALIBRATION

1. You may enter or change the offset and gain values for different measurement parameters, while viewing the current offset and gain values next to the corresponding boxes.
2. Once you have completed your calibrations, press the APPLY button on the SETUP tab.
3. The current offset value will update to show the value that you entered (instead of the default value). If you want to change the value, you can enter a new value in the box beside the number (as in step 1). To update the value, again, press APPLY in the SETUP tab.

NOTE:

We do not recommend calibration of most values with the exception of Relative Pressure, which must be correctly calibrated to reflect your distance above sea level to account for altitude effects.

VIEW YOUR WEATHER DATA IN WEATHER UNDERGROUND

To view your weather station data live via PC or mobile web browser, visit <http://www.wunderground.com>, and then enter the Station ID you were provided during account setup in the search box. Your weather data will show up on the next page. Alternately, you can log in to your Weather Underground account to view and download the recorded data from your weather station.

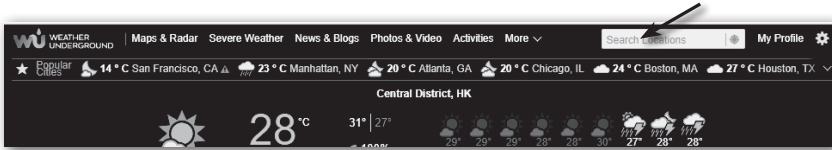

If you are using an iOS device, you can download the WunderStation app from the Apple® App Store® and login to your own weather station to view your data live.



VIEW YOUR WEATHER DATA IN WEATHERCLOUD

1. To view your weather station data live via PC or mobile web browser, visit <http://www.weathercloud.net> and sign into the account you created.
2. Click on the tab at the top of the page titled Devices.
3. Click on the Settings menu at the top right of the page, and select the option View.



4. Click on either Current, Wind, Evolution, or Inside to view your weather station's data.

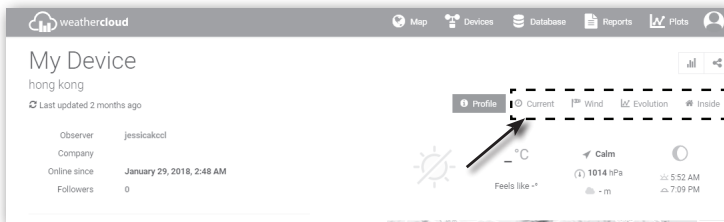

UPDATING THE FIRMWARE

This display console supports OTA (over the air) Function Firmware and WI-FI System Firmware updates via any web browser (not mobile browser) on a PC that is connected to WI-FI. The update function for both types of updates can be found at the bottom of the Advanced Tab on the wireless settings interface (see Advanced Settings via Web Interface on page 20).

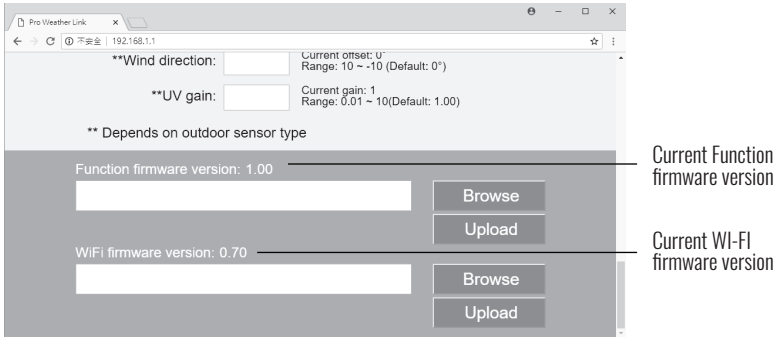

Follow the steps below to update your device's Function or WI-FI System Firmware

1. Download the latest version of the firmware (function or WI-FI) and save it to your PC. Remember where you saved the file.
2. Press and hold the SENSOR/WI-FI button for six (6) seconds to put the display console into AP mode, then connect the PC to the console (refer to steps in Set Up WI-FI Connection on page 18).
3. Click the button that says Browse next to the appropriate type of update that you downloaded and navigate to the location where you saved the file.
4. Click the corresponding Upload button to transfer the update file to the console.

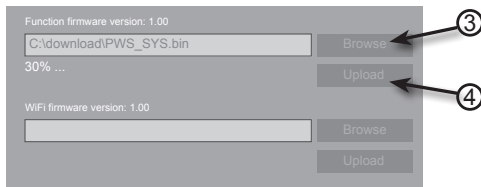

5. The file will install automatically once it is uploaded. You can view update progress on the display console in the wind direction section (the number displayed will correspond to the percentage completed, so 50 = 50% and so on).

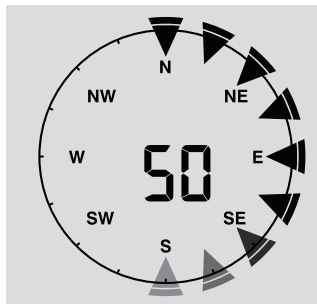

6. The console will restart once the update completes.

NOTES:

- You cannot update the Function Firmware and WI-FI Firmware at the same time. Updates must be installed one by one.
- Make sure the power cable remains connected during the update process.
- Make sure your PC's wireless connection is stable.
- Once the update process starts, do not try to do anything else on your PC or on the display console.
- During the firmware update process, the console will stop uploading data temporarily. It will reconnect to your router and resume uploading data once the update is complete. If the console cannot connect to your router, you may need to set up the WI-FI connection again, following the steps on page 18.
- Once your firmware update completes, you may need to input your Weather Underground ID and password again on the SETUP tab of the wireless interface.

■ OTHER CONSOLE SETTINGS AND FUNCTIONS

MANUALLY SETTING THE TIME

The display console is designed to synchronize with the internet time server to obtain the local time, but if you want to use it without connecting to your home wireless network, you can set the time manually. During initial setup, you will need to press and hold the SENSOR/WI-FI button for six (6) seconds, then let the display console return to normal mode. This will put it into offline mode for you to use it.

















1. In normal operating mode while offline, press and hold the CLOCK SET button for two (2) seconds to enter the clock setting menu.
2. Press the ▲ or ▼ buttons to adjust the time zone.
3. Press the CLOCK SET button again to make adjustments to the next setting.
4. Settings will cycle through the following options: **Time Zone > DST ON/OFF > Hour > Minute > 12/24-hour Format > Year > Month > Day > M-D/D-M Format > Time Sync ON/OFF > Language.**
5. Press the CLOCK SET button one final time after adjusting all settings options to save and exit, or the console will automatically save and exit the menu after 60 seconds of idle time.

NOTES:

- In normal operating mode, press the CLOCK SET button once to switch between date and year display.
- While adjusting settings, you can press and hold the CLOCK SET button for two (2) seconds to return to normal mode.

MOON PHASE

The display console calculates the moon phase according to your time, date, and time zone. The table below explains the corresponding phases and their icons for both Northern and Southern hemispheres. Please refer to the section regarding Orienting the Wireless Weather Sensor Due South on page 25 for more information on setting up your Wireless Weather Sensor in the Southern Hemisphere.

Northern Hemisphere Icons	Moon Phase	Southern Hemisphere Icons
	New Moon	
	Waxing Crescent Moon	
	First Quarter Moon	
	Waxing Gibbous Moon	
	Full Moon	
	Waning Gibbous Moon	
	Third Quarter Moon	
	Waning Crescent Moon	

POINTING THE WIRELESS WEATHER SENSOR TO SOUTH

The outdoor wireless weather sensor is calibrated to be pointed North for maximum accuracy. However, for your convenience, if you are a user located in the Southern Hemisphere, you can use the sensor with the wind vane pointing South.

1. Mount and install the wireless weather sensor with the wind meter end pointed South, instead of North. (Please refer to the Installation Instructions on page 12 for mounting instructions.)
2. While the display console is in normal operating mode, press and hold the INDEX button for eight (8) seconds until the N icon appears in the weekday section of the display to indicate the console is in sensor orientation mode.
3. Use the ▲ or ▼ buttons to change the orientation to Southern Hemisphere. The N should change to an S.
4. Press the INDEX button another time to confirm and exit the menu.

NOTES:

- Changing the hemisphere setting will automatically switch the direction of the moon phases on the display.
- Pointing the wireless weather sensor toward the South will allow maximum sunlight on the solar panel, especially during the winter season in the Southern Hemisphere.

SETTING THE ALARM

If you'd like to use your display console as an alarm clock, follow these instructions to set the alarm time:

1. In normal operating mode, press and hold the ALARM button for two (2) seconds until the alarm hour starts flashing. This indicates that you have entered the alarm time setting mode.
2. Use the ▲ or ▼ buttons to adjust the alarm hour. Press and hold either button to move through the hours quickly.
3. Press the ALARM button again to confirm the alarm hour and move to adjusting the minutes. The minute digits should be flashing.
4. Use the ▲ or ▼ buttons to adjust the alarm minute. Press and hold either button to move through the minutes quickly.
5. Press the ALARM button to save and exit the menu.

NOTES:

- Once you have an alarm set, the  icon will be displayed next to the time on the LCD display.
- The alarm function will be activated automatically once you set a time.

ACTIVATING/DEACTIVATING THE ALARM & TEMPERATURE PRE-ALARM

The temperature pre-alarm will alert you 30 minutes prior to your alarm time whenever the outdoor temperature falls below 26.5°F (-3°C).

1. In normal operating mode, press the ALARM button to display the set alarm time for five (5) seconds.
2. When the alarm time is being shown on the LCD display, press the ALARM button again to cycle through the alarm functions as shown below. The corresponding icons will appear on the LCD display.

		
Alarm off	Alarm on	Alarm with ice-alert

3. When the clock reaches the designated alarm time, the alarm sound will start playing.
4. To stop the alarm:
 - a. Allow the alarm to continue for two minutes and it will stop itself automatically. It will remain set for the following day.
 - b. Press the SNOOZE/BACKLIGHT button on top of the unit to snooze the alarm for five minutes. The snooze can be set continuously for 24 hours. We don't recommend doing that, though. While the console is in snooze mode, the alarm icon  will continue flashing.
 - c. Press and hold the SNOOZE/BACKLIGHT BELL for two (2) seconds to stop the alarm completely. It will stay set for the following day.
 - d. Press the ALARM button to stop the alarm completely. It will remain set for the following day.

TEMPERATURE/HUMIDITY & TRENDS

Press the °C/°F button to switch between Celsius and Fahrenheit temperature measurements. The arrows show the trend in changes to the temperature/humidity levels.

Arrow Icon			
Temp/Humidity Trend	Rising	Steady	Falling

NOTE:



- If/when the temperature outside falls below -40°F (-40°C), the LCD display will show the word “Lo” in the temperature section. If the temperature outside rises above 176°F (80°C), the LCD display will show the word, “HI” in the temperature section.
- If/when the humidity level falls below 1%, the LCD display will show the word “Lo” in the humidity section. If/when the humidity level rises above 99%, the LCD display will show the word, “HI” in the humidity section.

VIEWING OUTDOOR CHANNELS

This console is capable of pairing with the wireless weather sensor and up to 7 additional wireless thermal-hygro sensors. If you have 2 or more sensors installed, press the CH button to cycle between different wireless channels in normal operating mode, or press and hold the CH button for two (2) seconds to toggle auto-cycle mode on, which cycles through displaying all connected channels at 4-second intervals. While the console is in auto-cycle mode, you can press the CH button once to toggle auto-cycle mode off and continue displaying the current channel.

RECEIVING WIRELESS SENSOR SIGNALS

1. While in normal operating mode, press the SENSOR/SYNC button once to start receiving the current sensor signal on the channel being displayed. (i.e. if you're on CH 1 and press the SENSOR/SYNC button, the current wireless sensor signal being received will only display on CH 1.) The signal icon will start flashing.
2. The signal icon will continue flashing until it successfully receives a signal. If no signal is received within five (5) minutes, the icon will disappear.

		
No signal	Weak signal	Good signal

3. If the signal for the outdoor channel has been interrupted and does not recover within 15 minutes, the signal icon will disappear. The temperature and humidity section (outdoor) will display “—” on the corresponding channel.
4. If the signal still does not recover within 48 hours, the “—” display will become permanent. You will need to replace the batteries on the associated channel’s sensor and press the SENSOR/SYNC button to pair up the sensors again.
5. After replacing batteries in the display console or the wireless weather sensor, or if the unit fails to receive a specified channel, press the SENSOR/SYNC button while the failed channel is being displayed to manually receive that sensor’s signal again.

INDOOR COMFORT INDICATOR KEY

The indoor comfort indicators display a pictorial representation based on the indoor air temperature and humidity levels to determine the approximate comfort level.

☹️	😊	☹️💧
Too cold	Comfortable	Too hot

NOTE:

Comfort indicator levels may vary even when the temperature is the same due to variances in relative humidity levels. No comfort indicator will be displayed if the temperature falls below 32°F (0°C) or over 140°F (60°C).

WIND READOUTS

Wind Direction

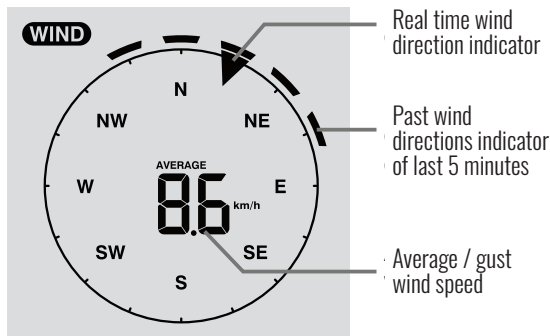

SELECTING WIND DISPLAY MODE

While in normal operating mode, press the WIND button to switch between the average wind speed measurement and gust wind speed measurement.

Set Wind Speed Units

1. While in normal operating mode, press and hold the WIND button for two seconds to enter the wind speed unit setting mode. The unit display will start flashing. Press the ▲ or ▼ buttons to cycle through the wind speed units in the following order: **m/s > km/h > knots > mph**

2. Press the WIND button again to return to normal display mode.
3. Press the WIND button while in normal operating mode to switch between AVERAGE and GUST wind speeds.

Wind Speed Level Chart

Level	Light	Moderate	Strong	Storm
Speed	0.1-11.8 mph	12-30.4 mph	31-54.7 mph	>55 mph

WEATHER INDEXES

When reading the Weather Index display, you can press the INDEX button to cycle through different weather indexes in the following order: **Feels Like > Heat Index > Wind Chill > Dewpoint.**

Feels Like

The Feels Like temperature index determines what temperature it actually feels like outside, taking into account factors like wind chill and the heat index.

Wind Chill

Wind chill is determined by a combination of the wireless weather sensor's temperature and wind speed data.

Heat Index

The heat index is determined by the wireless weather sensor's temperature and humidity readings when the temperature outdoors is between 80°F (27°C) and 120°F (50°C).







Heat Index range	Warning	Explanation
80°F to 90°F (27°C to 32°C)	Caution	Possibility of heat exhaustion
91°F to 105°F (33°C to 40°C)	Extreme Caution	Possibility of heat dehydration
106°F to 129°F (41°C to 54°C)	Danger	Heat exhaustion likely
≥ 130°F (≥ 55°C)	Extreme Danger	Strong risk of dehydration / sun stroke

Dew Point

- The dew point is the temperature below which the water vapor in air at constant barometric pressure condenses into liquid water at the same rate at which it evaporates. The condensed water is called dew when it forms on a solid surface.
- The dew point temperature is determined by the temperature and humidity data from the wireless weather sensor.

WEATHER FORECAST

The built-in barometer can notice atmospheric pressure changes, and based on the data collected, can predict the weather conditions in the forthcoming 12-24 hours within a 19 ~ 31 mile (30 ~ 50 km) radius.

					
Sunny	Partly cloudy	Cloudy	Rainy	Rainy / Stormy	Snowy

NOTE:

- The accuracy of a general pressure-based forecast is about 70% - 75%. Forecasts are not guaranteed.
- The forecast section reflects a general prediction for the next roughly 12 ~ 24 hours. It may not necessarily reflect the current situation.
- The SNOWY weather forecast is not based on the atmospheric pressure, but based on the current temperature reading from that wireless sensor. When the outdoor temperature is below ~ 26°F (-3°C), the SNOWY weather indicator will be shown on the LCD display.

BAROMETRIC PRESSURE



The atmospheric pressure is the pressure at any location on Earth caused by the weight of the column of air directly above that location. The average pressure gradually decreases as the altitude increases. Meteorologists use barometers to measure atmospheric pressure. Since variation in atmospheric pressure can be greatly affected by the weather, it is possible to forecast the weather by measuring these changes in pressure.

Set Barometer Units

1. In normal operating mode, press the BARO button to cycle through options for the barometer units of measure in the following order: **hPa** > **inHg** > **mmHg**.
2. While in normal operating mode, press and hold the BARO button to switch between **ABSOLUTE** and **RELATIVE** barometric pressure displays.

Absolute	The absolute atmospheric pressure of your location
Relative	The relative atmospheric pressure based on the sea level

RAINFALL

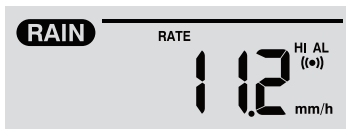

The Rainfall shows information regarding the rainfall and rain rate.

Set the Rainfall Units

1. Press and hold the RAIN button for two (2) seconds to enter unit setting mode.
2. Press the ▲ or ▼ buttons to toggle the units of measure for rainfall between mm and in.
3. Press the RAIN button again to save and exit the setting mode.

Select the Rainfall Display Mode

Press the RAIN button to toggle between:

1. HOURLY: total rainfall in the past hour
2. DAILY: total rainfall since midnight
3. WEEKLY: total rainfall for the current week
4. MONTHLY: total rainfall since the beginning of the current month
5. RATE: current rainfall rate in the past hour (updates every 24 seconds)
6. ACCUMULATION: total rainfall since the last reset (will show the record start date on the display for five seconds)

Reset the Accumulating Rainfall Record

While in normal operating mode, press and hold the °C/°F button for two (2) seconds to reset the ACCUMULATION rainfall record.

NOTE:

- To ensure precise data, please reset the ACCUMULATION rainfall record whenever you move and reinstall your wireless weather sensor to a different location.

MAX/MIN DATA RECORD

The display console can record the accumulated and daily MAX/MIN weather data with a corresponding time stamp for you to review.

View the Daily MAX/MIN

While in normal operating mode, press the MAX/MIN button to cycle through the daily MAX/MIN records. Records are displayed in the following order:

Indoor* daily MAX temperature > indoor* daily MIN temperature > indoor* daily MAX humidity > indoor* daily MIN humidity > outdoor daily MAX temperature > outdoor daily MIN temperature > outdoor daily MAX humidity > outdoor daily MIN humidity > daily MAX average wind speed > daily MAX gust > daily MAX relative pressure > daily MIN relative pressure > daily MAX absolute pressure > daily MIN absolute pressure > daily MAX feels like temperature > daily MIN feels like temperature > daily MAX heat index > daily MIN heat index > daily MAX wind chill > daily MIN wind chill > daily MAX dew point > daily MIN dew point > daily MAX rainfall

* or current display channel sensor

Reset the Accumulated MAX/MIN Records

Press and hold the MAX/MIN button for two (2) seconds to reset the MAX/MIN records of the specific weather display section.

History Data for Past 24 Hours

The display console automatically stores the weather data from the past 24 hours.

1. Press the HISTORY button to check the beginning of the current hour's weather data, e.g., if the current time is 7:25 AM on Dec 1st, the display will show the data for 7:00 AM on Dec 1st.
2. Press the HISTORY button to view the older readings for each hour of the past 24 hours, e.g. 6:00 AM (Dec 1st), 5:00 AM (Dec 1st), ..., 10:00 AM (Nov 30th), 9:00 AM (Nov 30th), 8:00 AM (Nov 30th).

NOTE: The LCD display will also show the History icon, along with the time and date, when displaying the history data records.

WEATHER ALERT SETTINGS

The Weather Alert can alert you to certain weather conditions by activating an alarm sound and flashing the LCD display's alert icon when specific criteria are met.

To Set the Alert

1. Press the ALERT button to cycle through and display the desired weather alert options in the following order:

Alert Option Sequence	Setting Range	Display Section	Default Setting
High Outdoor Temperature Alert (current channel)	-40°F ~ 176°F (-40°C ~ 80°C)	Outdoor temperature & humidity	104°F (40°C)
Low Outdoor Temperature Alert (current channel)			32°F (0°C)
High Outdoor Humidity Alert	1% ~ 99%		80%
Low Outdoor Humidity Alert			40%
High Indoor Temperature Alert	-40°F ~ 176°F (-40°C ~ 80°C)	Indoor temperature & humidity	104°F (40°C)
Low Indoor Temperature Alert			32°F (0°C)
High Indoor Humidity Alert	1% ~ 99%		80%
Low Indoor Humidity Alert			40%

Wind Speed Alert	0.1 m/s ~ 50 m/s (0.1 ~ 180 km/h 0.1 ~ 112 mph 0.1 ~ 97 knots)	Wind direction & speed	17.2 m/s (62 km/h 39 mph 34 knots)
Pressure Drop Alert	1hPa ~ 10hPa	Barometer & Rainfall	3hPa
Hourly Rainfall Alert	0.04 in ~ 39 in (1 mm ~ 1000 mm)		4 in (100 mm)

2. While on the alert option you want to set, press and hold the ALERT button for two (2) seconds to enter that alert's settings mode. The alert option will start flashing.
3. Press the ▲ or ▼ buttons to adjust the value, or press and hold the buttons to adjust the value more quickly.
4. Press the ALERT button when the desired value is reached to save the alert setting, then press the ALARM button to toggle the weather alert on or off.

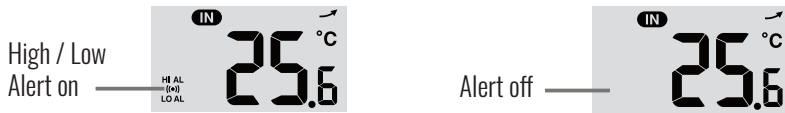

5. Press any button on the front of the display console to save and return to normal mode, or wait 30 seconds without pressing any buttons and the alert will save itself and return to normal mode.

To Silence the Weather Alert Alarm

Press the SNOOZE/LIGHT button on top of the display console to silence the alarm, or it will automatically turn off after two (2) minutes.

NOTES:

- Once the alert is triggered, the alarm will sound for two (2) minutes and the associated alert icon and weather readings will flash.
- If the alert alarm automatically shuts off after two (2) minutes instead of being manually shut off, the associated alert icon and readings will continue flashing until the reading is out of the alert range.
- The weather alert alarm will go off once the readings fall into alert range again.

CARE AND MAINTENANCE

BATTERY REPLACEMENT

If the low battery indicator icon is displayed in the outdoor temperature and humidity section or the corresponding CH section of the LCD console display, this indicates that the batteries in your wireless weather sensor are running low and should be replaced. Make sure to replace all batteries at the same time.

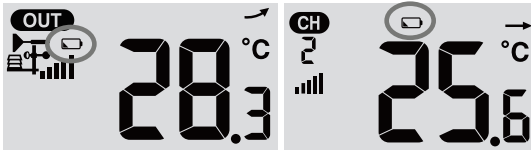

CLEANING THE RAIN COLLECTOR

1. Rotate the rain collector by 30° counter-clockwise until it is in the unlock position as shown.

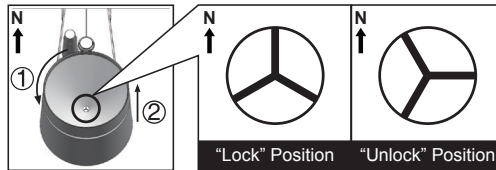

2. Gently remove the rain collector.
3. Clean and remove any debris or insects.
4. Wait until the parts are fully dry, and then reinstall them, and return the rain collector to a locked position.

CLEANING THE THERMO/HYGRO SENSOR

1. Unscrew the 2 screws at the bottom of the sensor casing.
2. Gently pull out the shield.
3. Carefully remove any dirt or insects inside the sensor casing, making sure the inside sensors remain dry.
4. Clean the shield with water and remove any dirt or insects.
5. Once the parts are fully clean and dry, reinstall them and replace the screws.

SPECIFICATIONS

DISPLAY CONSOLE

SPECIFICATIONS	
DISPLAY CONSOLE	
General Specifications	
Dimensions (W x H x D)	5.4" x 6.6" x 1" (117 x 189 x 31mm)
Weight	0.82 lb. (370g) with batteries
Power source	DC 5V, 1A adaptor
Backup battery	CR2032, 3V battery
Operating temperature range	23°F ~ 122°F (-5°C ~ 50°C)
Wi-Fi Communication Specifications	
Wi-Fi standard	802.11 b/g/n
Wi-Fi operating frequency	2.4GHz
Router security type	WPA/WPA2, OPEN, WEP (WEP will only support a hexadecimal password)
Supported devices for setup UI	Smart devices, tablets, laptops, or PCs with built-in Wi-Fi and AP mode functionality such as: Android™ phone or tablet, iPhone or iPad, or a Windows® laptop/PC
Recommended web browser version	Latest version of any web browser that supports HTML 5
Wireless Sensor Communication Specifications	
Supported sensors	1 Wireless 5-in-1 weather outdoor sensor and up to 7 optional wireless hygro-thermo outdoor sensors
RF frequency	868 MHz (EU or UK version), 915 MHz (US version), 917 MHz (AU version)
RF transmission range	492 ft (150m)
Time Function Specifications	
Time display	HH: MM: SS
Hour format	12 hour or 24 hour
Date display	DD / MM or MM / DD
Time synchronization method	Synchronizes with UTC clock through internet time server
Weekday languages	EN / DE / FR / ES / IT / NL / RU
Time zones	GMT +13 ~ GMT -12
DST	ON / OFF
Barometer Display & Function Specifications	
Note: The following details are listed as they are displayed or operate on the console.	
Barometer units	hPa, inHg, and mmHg
Measuring range	540 ~ 1100 hPa (relative setting range 930 ~ 1050 hPa)
Accuracy	(700 ~ 1100 hPa ± 5 hPa) / (540 ~ 696 hPa ± 8 hPa) (20.67 ~ 32.48 inHg ± 0.15 inHg) / (15.95 ~ 20.55 inHg ± 0.24 inHg) (525 ~ 825mmHg ± 3.8mmHg) / (405 ~ 522 mmHg ± 6 mmHg) Typical at 77°F (25°C)
Resolution	1hPa / 0.01inHg / 0.1mmHg
Weather forecast	Sunny, Partly Cloudy, Cloudy, Rainy, Stormy and Snowy
Display modes	Current
Memory modes	Historical data of past 24 hours, daily Max / Min
Alarm	Pressure change alert

Indoor / Outdoor Temperature Display & Function Specifications	
Note: The following details are listed as they are displayed or operate on the console.	
Temperature unit	°C and °F
Display range	-40 ~ 176°F (-40 ~ 80°C)
Indoor Accuracy	>104°F ± 3.6°F (>40°C ± 2°C) 32°F ~ 104°F ± 1.8°F (0~40°C ± 1°C) < 32°F ± 3.6°F (< 0°C ± 2°C)
Outdoor Accuracy	131°F ~ 140°F ± 0.9°F (55°C ~ 60°C ± 0.5°C) 50°F ~ 131°F ± 0.7°F (10°C ~ 55°C ± 0.4°C) -4°F ~ 50°F ± 2.3°F (-20°C ~ 10°C ± 1.3°C) -40°F ~ -4°F ± 3.4°F (-40°C ~ -20°C ± 1.9°C)
Resolution	0.1°F / 0.1°C
Display modes	Current
Memory modes	Historical data of past 24 hours, daily Max / Min
Alarm	High / Low temperature alert
Indoor / Outdoor Humidity Display & Function Specifications	
Note: The following details are listed as they are displayed or operate on the console.	
Humidity unit	%
Display range	1 ~ 99%
Indoor Accuracy	20~39% RH ±8%RH @ 77°F (25°C) 40~70% RH ±5%RH @ 77°F (25°C) 71~90% RH ±8%RH @ 77°F (25°C)
Outdoor Accuracy	1 ~ 90% RH ± 2.5% RH @ 77°F (25°C) 90 ~ 99% RH ± 3.5% RH @ 77°F (25°C)
Resolution	1%
Display modes	Current
Memory modes	Historical data of past 24 hours, daily Max / Min
Alarm	High / Low Humidity Alert
Wind Speed & Direction Display and Function Specifications	
Note: The following detail are listed as they are displayed or operate on the console.	
Wind speed unit	mph, m/s, km/h and knots
Wind speed display range	0 ~ 112mph, 50m/s, 180km/h, 97knots
Resolution	0.1mph, 0.1m/s, 0.1km/h, 0.1knots
Speed accuracy	± 2.2 mph or ± 10% (whichever is greater)
Display mode	Gust / Average
Memory modes	Historical Data of past 24 hours, daily Max Gust/ Average
Alarm	Hi Wind Speed Alert (Average / Gust)
Wind direction	16 direction
Rain Display & Function Specifications	
Note: The following details are listed as they are displayed or operate on the console.	
Unit for rainfall	mm and in
Accuracy for rainfall	± 7%
Range of rainfall	0 ~ 19999mm (0 ~ 787.3 in)
Resolution	0.254mm (0.01in)
Display modes	Current
Memory modes	Historical Data of past 24 hours, daily Max
Rainfall display mode	Hourly / Daily / Weekly / Monthly / Total rainfall
Alarm	High Hourly Rainfall Alert

Weather Index Display & Function Specifications	
Note: The following details are listed as they are displayed or operate on the console.	
Weather index mode	Beaufort, Wind Chill, Heat Index and Dew point
Beaufort scale	0 ~ 12
Wind Chill range	-40°F ~ 64.4°F (-40°C ~ 18°C), wind speed > 4.8km/h
Heat index range	78.8°F ~ 122°F (26°C ~ 50 °C)
Dew point range	-4°F ~ 140°F (-20°C ~ 60°C)
Display modes	Current
Memory modes	Historical Data of past 24 hours, Daily Max / Min
Wireless 5-in-1 Sensor Specifications	
Dimensions (W x H x D)	13.5" x 15.5" x 5.35" (343.5 x 393.5 x 136 mm)
Weight	1.62 lb. (734g) with batteries
Main power source	3 x AA 1.5V batteries (lithium batteries recommended)
Weather data recorded	Temperature, humidity, wind speed, wind direction, and rainfall
RF Transmission range	492 ft (150m)
RF frequency	868 MHz (EU or UK version), 915 MHz (US version), 917 MHz (AU version)
Transmission interval	<ul style="list-style-type: none"> • Every 12 seconds: wind speed and wind direction • Every 24 seconds: temperature, humidity, and rain
Operating range	-40°F ~ 140°F (-40°C ~ 60°C)

FCC STATEMENT

This device complies with Part 15 of the FCC Rules. Operation is subject to the following two conditions:

- (1) This device may not cause harmful interference, and;
- (2) This device must accept any interference received, including interference that may cause undesired operation.

NOTE: This equipment has been tested and found to comply with the limits for a Class B digital device, pursuant to part 15 of the FCC Rules. These limits are designed to provide reasonable protection against harmful interference in a residential installation. This equipment generates—and can radiate—radio frequency energy and, if not installed and used in accordance with the instructions, may cause harmful interference to radio communications.

However, there is no guarantee that interference will not occur in a particular installation. If the equipment does not cause harmful interference to radio or television reception, which can be determined by turning the equipment off and on, the user is encouraged to try to correct the interference by one or more of the following measures:

- Reorient or relocate the receiving antenna
- Increase the separation between the equipment and the receiver
- Connect the equipment into an outlet on a circuit different from that to which the receiver is connected.
- Consult the dealer or an experienced radio/TV technician for help.

FCC RF Radiation Exposure Statement

Caution: To maintain compliance with the FCC's RF exposure guidelines, place the unit at least 20cm from nearby persons.

Warning: Changes or modifications to this unit not expressly approved by the party responsible for compliance could void the user's authority to operate the equipment.

WARRANTY INFORMATION

LIMITED WARRANTY ON LOGIA™ 5-IN-1 WIRELESS WEATHER STATION WITH WI-FI
THIS LIMITED WARRANTY GIVES YOU SPECIFIC LEGAL RIGHTS AND YOU MAY ALSO HAVE OTHER RIGHTS, WHICH VARY FROM STATE TO STATE.

WE WARRANT THAT DURING THE WARRANTY PERIOD, THE PRODUCT WILL BE FREE FROM DEFECTS IN MATERIALS AND WORKMANSHIP.

LIMITATION OF LIABILITY

TO THE EXTENT NOT PROHIBITED BY LAW, THIS WARRANTY IS EXCLUSIVE AND IN LIEU OF ALL OTHER WARRANTIES, ORAL, WRITTEN, STATUTORY, EXPRESS OR IMPLIED. EXCEPT FOR THE EXPRESS WARRANTIES CONTAINED IN THIS LIMITED WARRANTY STATEMENT AND TO THE EXTENT NOT PROHIBITED BY LAW, WE DISCLAIM ALL OTHER WARRANTIES, EXPRESSED OR IMPLIED, STATUTORY OR OTHERWISE, INCLUDING WITHOUT LIMITATION, THE WARRANTIES OF MERCHANTABILITY AND FITNESS FOR A PARTICULAR PURPOSE. SOME STATES DO NOT ALLOW DISCLAIMERS OF IMPLIED WARRANTIES, SO THIS DISCLAIMER MAY NOT APPLY TO YOU. TO THE EXTENT SUCH WARRANTIES CANNOT BE DISCLAIMED UNDER THE LAWS OF YOUR JURISDICTION, WE LIMIT THE DURATION AND REMEDIES OF SUCH WARRANTIES TO THE DURATION OF THIS EXPRESS LIMITED WARRANTY.

OUR RESPONSIBILITY FOR DEFECTIVE GOODS IS LIMITED TO REPAIR, REPLACEMENT OR REFUND AS DESCRIBED BELOW IN THIS WARRANTY STATEMENT.

WHO MAY USE THIS WARRANTY? C&A Marketing, Inc. located at 114 Tived Lane East, Edison, NJ (“we”) extend this limited warranty only to the consumer who originally purchased the product (“you”). It does not extend to any subsequent owner or other transferee of the product.

WHAT DOES THIS WARRANTY COVER? This limited warranty covers defects in materials and workmanship of the Logia™ 5-in-1 Wireless Weather Station with WI-FI (the “product”) for the Warranty Period as defined below.

WHAT DOES THIS WARRANTY NOT COVER? This limited warranty does not cover any damage due to: (a) transportation; (b) storage; (c) improper use; (d) failure to follow the product instructions or to perform any preventive maintenance; (e) modifications; (f) unauthorized repair; (g) normal wear and tear; or (h) external causes such as accidents, abuse, or other actions or events beyond our reasonable control.

WHAT IS THE PERIOD OF COVERAGE? This limited warranty starts on the date of your purchase and lasts for one year (the “Warranty Period”). The Warranty Period is not extended if we repair or replace the product. We may change the availability of this limited warranty at our discretion, but any changes will not be retroactive.

WHAT ARE YOUR REMEDIES UNDER THIS WARRANTY? With respect to any defective product during the Warranty Period, we will, at our sole discretion, either: (a) repair or replace such product (or the defective part) free of charge or (b) refund the purchase price of such product if an exchange unit cannot be provided.

HOW DO YOU OBTAIN WARRANTY SERVICE? To obtain warranty service, you must contact us at 1-833-815-0568 or by email at info@supportcbp.com during the Warranty Period to obtain a Defective Merchandise Authorization (“DMA”) number. No warranty service will be provided without a DMA number and return shipping costs to our facilities shall be assumed by you, the purchaser. Shipping costs of the replacement unit to you shall be assumed by us.

If you experience any issues with your Logia™ 5-in-1 Wireless Weather Station with WI-FI, please contact us before returning your product to the place of purchase. We're here to help!

QUESTIONS OR PROBLEMS? CONTACT US!

Email: info@supportcbp.com or call: 1-833-815-0568
www.logiaweatherstation.com



LOGIA is a trademark of C&A IP Holdings, LLC, in the U.S.

Android is a trademark of Google LLC. Apple and App Store are trademarks of Apple Inc. in the U.S. and other countries. IOS is a trademark of Cisco in the U.S. and other countries and is used under license. Microsoft, Windows, Windows Server, Windows Vista, and Windows 10 are trademarks of Microsoft Corporation in the U.S. and/or other countries. WI-FI, WPA, and WPA2 are trademarks of WI-FI Alliance in the U.S. and/or other countries.

All other products, brand names, company names, and logos are trademarks of their respective owners, used merely to identify their respective products, and are not meant to connote any sponsorship, endorsement or approval.

Distributed by C&A Marketing, Inc., 114 Tived Lane East, Edison, NJ 08837.

Made in China.

© 2019. C&A IP Holdings, LLC. All Rights Reserved.