

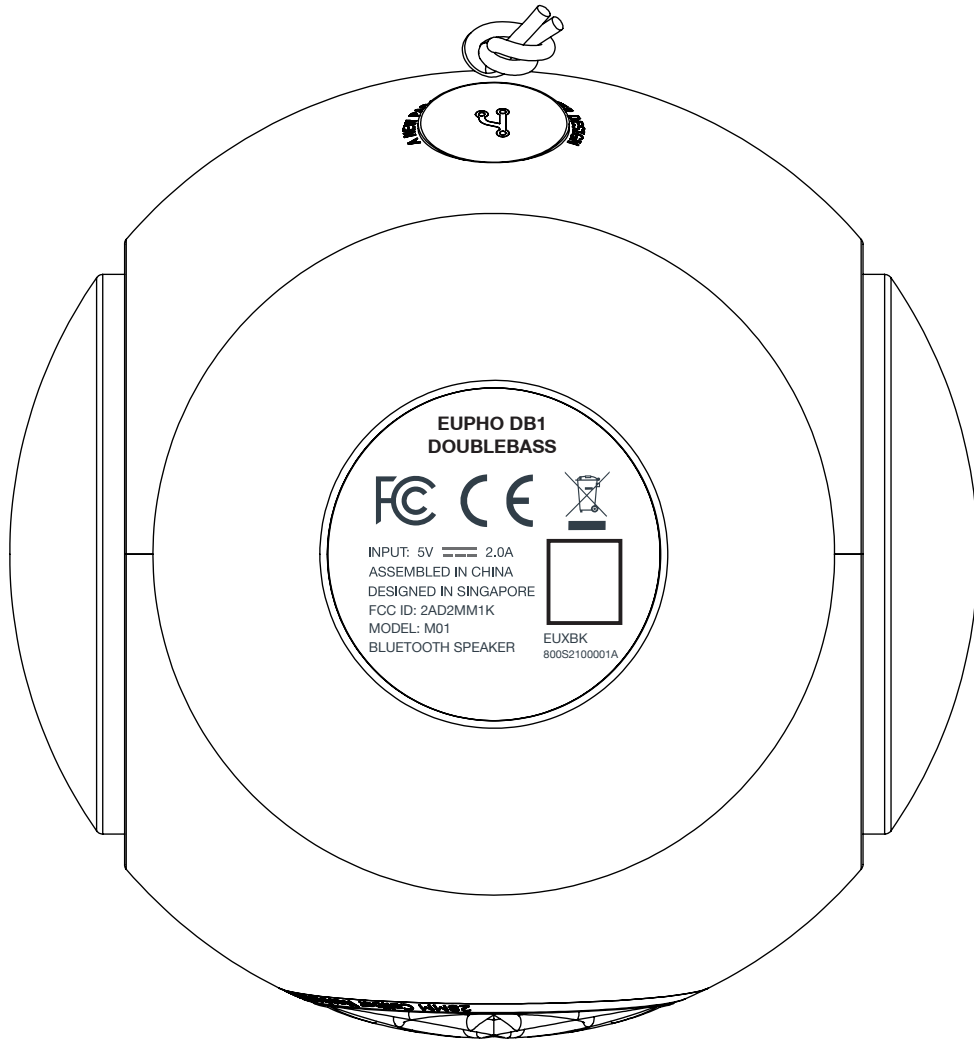

Code name : 128



Version 1.0

	<p>PROJECT ARTWORK - EUPHO DB1 DOUBLEBASS</p>	<p>FILE NAME</p>		
<p>TGI TECHNOLOGY Pte Ltd 140 PAYA LEBAR ROAD #06-25 AZ PAYA LEBAR Singapore 409015</p> <p>UB+.com</p>	<p>BACKGROUND COLOUR (DO NOT PRINT)</p> <div style="background-color: #cccccc; width: 40px; height: 20px; margin: 5px 0;"></div> <p>C100 M85 Y5 K36</p> <p style="text-align: right;">A new paradigm in speaker design flexible and adaptable for different usage scenarios crafted for a wireless aural experience.</p>	<p>SCALE</p> <p>—</p>	<p>VERSION</p>	<p>DRAWN BY</p>
		<p>REVISION DATE</p> <p>18/02/2022</p>		

All content and information contained on this page is confidential and remains the exclusive property of UB+ Singapore Pte.Ltd. No distribution, reproduction, communication and/or alteration, in whole or part, is permitted without express written permission of UB+Singapore Pte Ltd. Whether directly or indirectly, any infringement of copyright on a commercial scale is an Intellectual Property criminal offence.

Code name :138

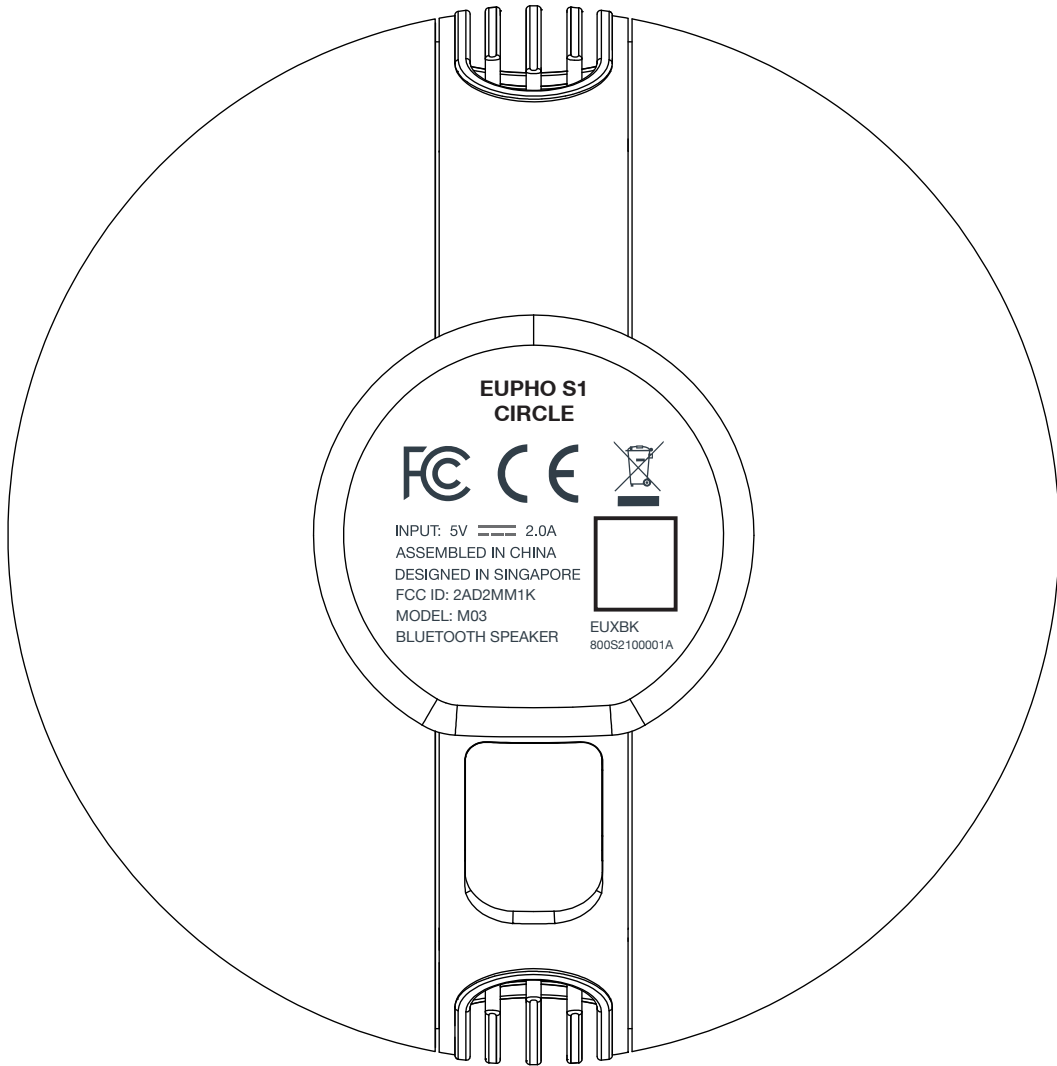

Version 1.0

	<p>PROJECT ARTWORK - EUPHO S1 CIRCLE</p>	<p>FILE NAME</p>		
<p>TGI TECHNOLOGY Pte Ltd 140 PAYA LEBAR ROAD #06-25 AZ PAYA LEBAR Singapore 409015</p> <p>UB+.com</p>	<p>BACKGROUND COLOUR (DO NOT PRINT)</p> <div style="background-color: #cccccc; width: 40px; height: 20px; margin: 5px 0;"></div> <p>C100M85 Y5 K36</p> <p style="text-align: right;">A new paradigm in speaker design flexible and adaptable for different usage scenarios crafted for a wireless aural experience.</p>	<p>SCALE -</p>	<p>VERSION</p>	<p>DRAWN BY</p>
		<p>REVISION DATE 18/02/2022</p>		

All content and information contained on this page is confidential and remains the exclusive property of UB+ Singapore Pte.Ltd. No distribution, reproduction, communication and/or alteration, in whole or part, is permitted without express written permission of UB+Singapore Pte Ltd. Whether directly or indirectly, any infringement of copyright on a commercial scale is an Intellectual Property criminal offence.

Code name :168

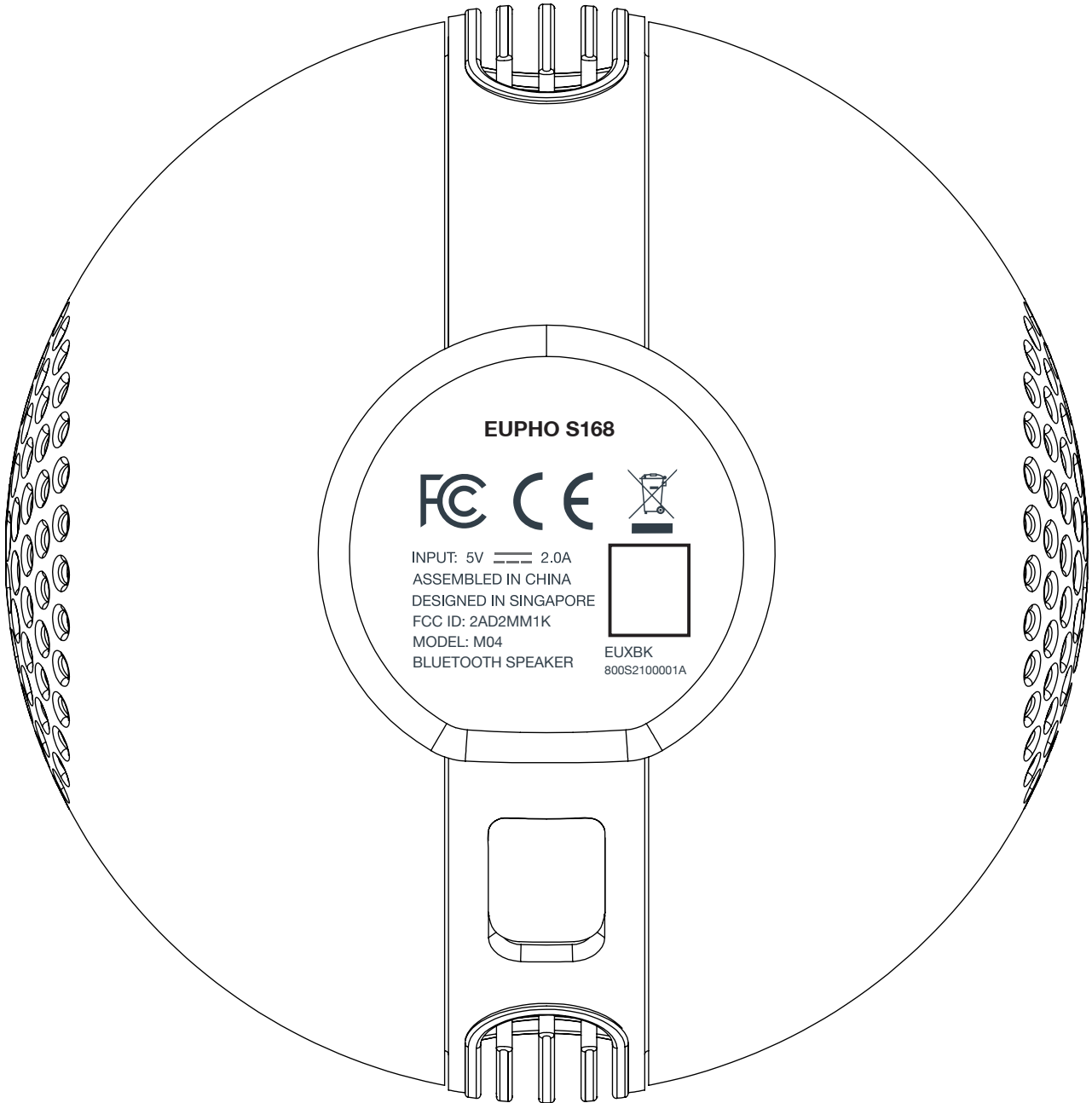

Version 1.0

	<p>PROJECT ARTWORK - EUPHO S168</p>	<p>FILE NAME</p>		
<p>TGI TECHNOLOGY Pte Ltd 140 PAYA LEBAR ROAD #06-25 AZ PAYA LEBAR Singapore 409015</p> <p>UB+.com</p>	<p>BACKGROUND COLOUR (DO NOT PRINT)</p> <div style="display: flex; align-items: center;"> <div style="width: 30px; height: 30px; background-color: #cccccc; margin-right: 10px;"></div> <div> <p>C100M85 Y5 K36</p> </div> </div> <p style="text-align: right; font-size: small;">A new paradigm in speaker design flexible and adaptable for different usage scenarios crafted for a wireless aural experience.</p>	<p>SCALE</p> <p>—</p>	<p>VERSION</p>	<p>DRAWN BY</p>
		<p>REVISION DATE</p> <p>18/02/2022</p>		

All content and information contained on this page is confidential and remains the exclusive property of UB+ Singapore Pte.Ltd. No distribution, reproduction, communication and/or alteration, in whole or part, is permitted without express written permission of UB+Singapore Pte Ltd. Whether directly or indirectly, any infringement of copyright on a commercial scale is an Intellectual Property criminal offence.

EUPHO E2+ SPEAKER

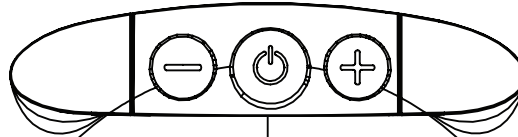

INPUT: 5V  2.0A
 ASSEMBLED IN CHINA
 DESIGNED IN SINGAPORE

FCC ID: 2AD2MM1K
 MODEL: M05



EUXBK
 800E3100001A



PROJECT
 WIND TUNNEL CYLINDER ARTWORK - M05

FILE NAME

TGI TECHNOLOGY Pte Ltd
 140 PAYA LEBAR ROAD
 #06-25 AZ PAYA LEBAR
 Singapore 409015

BACKGROUND COLOUR
 (DO NOT PRINT)





C100 M85
 Y5 K36

SCALE	VERSION	DRAWN BY
-		

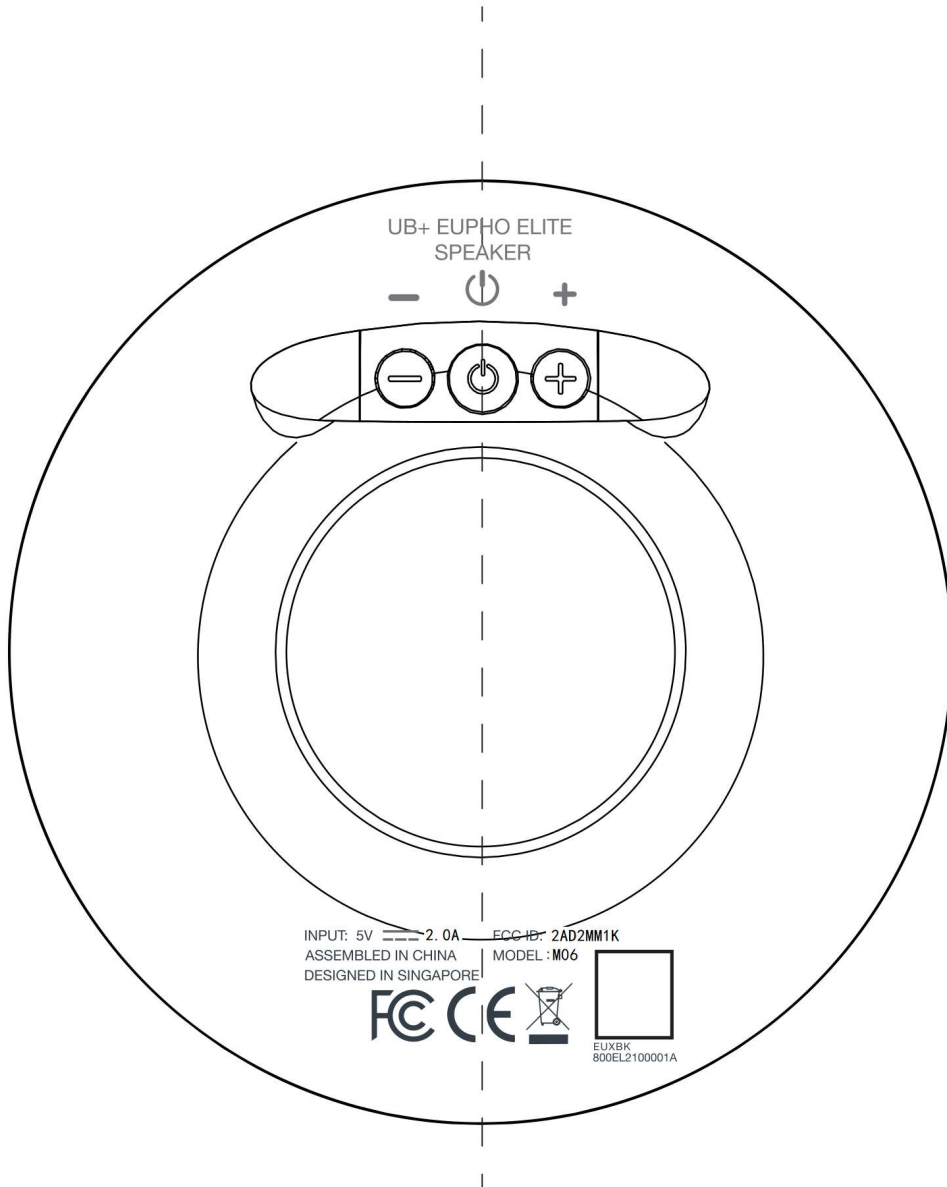
REVISION DATE
 07/12/21



	<p>PROJECT WIND TUNNEL CYLINDER ARTWORK - M06</p>	<p>FILE NAME</p>		
<p>TGI TECHNOLOGY Pte Ltd 140 PAYA LEBAR ROAD #06-25 AZ PAYA LEBAR Singapore 409015</p> <p>UB+.com</p>	<p>BACKGROUND COLOUR (DO NOT PRINT)</p> <div style="text-align: center;">  </div> <p>C100M85 Y5 K36</p> <p style="text-align: center;">A new paradigm in speaker design flexible and adaptable for different usage scenarios crafted for a wireless aural experience.</p>	<p>SCALE</p> <p>—</p>	<p>VERSION</p>	<p>DRAWN BY</p>
		<p>REVISION DATE</p>		

All content and information contained on this page is confidential and remains the exclusive property of UB+ Singapore Pte.Ltd. No distribution, reproduction, communication and/or alteration, in whole or part, is permitted without express written permission of UB+Singapore Pte Ltd. Whether directly or indirectly, any infringement of copyright on a commercial scale is an Intellectual Property criminal offence.

Code name : 185



Version 1.0



	<p>PROJECT ARTWORK - EUPHO CODENAME 218</p>	<p>FILE NAME</p>		
<p>TGI TECHNOLOGY Pte Ltd 140 PAYA LEBAR ROAD #06-25 AZ PAYA LEBAR Singapore 409015</p> <p>UB+.com</p>	<p>BACKGROUND COLOUR (DO NOT PRINT)</p> <div style="display: flex; align-items: center;"> <div style="width: 30px; height: 30px; background-color: #cccccc; margin-right: 10px;"></div> <div> <p>C100M85 Y5 K36</p> </div> </div> <p style="text-align: right; font-size: small;">A new paradigm in speaker design flexible and adaptable for different usage scenarios crafted for a wireless aural experience.</p>	<p>SCALE</p> <p>—</p>	<p>VERSION</p>	<p>DRAWN BY</p>
		<p>REVISION DATE</p> <p style="text-align: right;">18/02/2022</p>		

All content and information contained on this page is confidential and remains the exclusive property of UB+ Singapore Pte.Ltd. No distribution, reproduction, communication and/or alteration, in whole or part, is permitted without express written permission of UB+ Singapore Pte Ltd. Whether directly or indirectly, any infringement of copyright on a commercial scale is an Intellectual Property criminal offence.

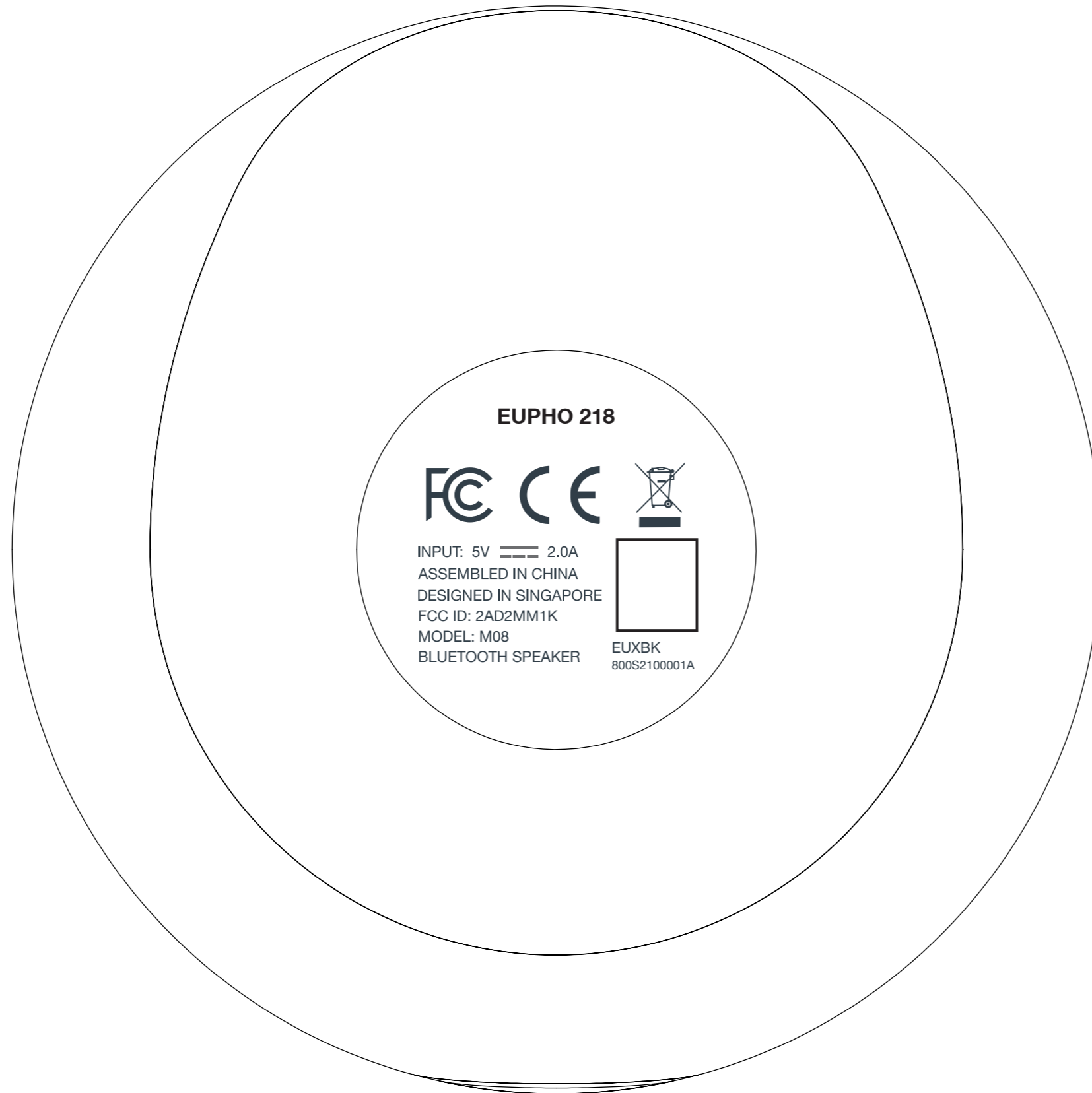
Code name : 218





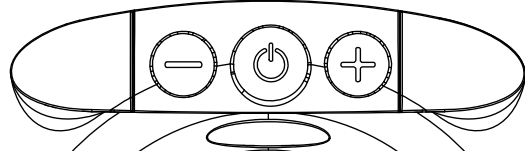

Version 1.0

	PROJECT ARTWORK - EUPHO DB1 DOUBLEBASS	FILE NAME		
TGI TECHNOLOGY Pte Ltd 140 PAYA LEBAR ROAD #06-25 AZ PAYA LEBAR Singapore 409015 UB+.com	BACKGROUND COLOUR (DO NOT PRINT)  C100 M85 Y5 K36 A new paradigm in speaker design flexible and adaptable for different usage scenarios crafted for a wireless aural experience.	SCALE -	VERSION	DRAWN BY
		REVISION DATE 18/02/2022		

EUPHO S2+ ALPHORN



INPUT: 5V  2.0A
 ASSEMBLED IN CHINA
 DESIGNED IN SINGAPORE
 FCC ID: 2AD2MM1K
 MODEL: M09
 BLUETOOTH SPEAKER



EUXBK
 800S2100001A



PROJECT
 WIND TUNNEL CYLINDER INTERN ARTWORK - S2

FILE NAME

TGI TECHNOLOGY Pte Ltd
 140 PAYA LEBAR ROAD
 #06-25 AZ PAYA LEBAR
 Singapore 409015

BACKGROUND COLOUR
 (DO NOT PRINT)



C100M85
 Y5 K36

A new paradigm in speaker design flexible and adaptable for
 different usage scenarios crafted for a wireless aural experience.

SCALE VERSION DRAWN BY

—

REVISION DATE
 07/12/21