

FCC TEST REPORT
FOR
Shenzhen L&Y Audio Co., LTD
Bluetooth Speaker
Test Model: Harmony II

Prepared for : Shenzhen L&Y Audio Co., LTD
Address : No.2 Bldg, No.2 Industrial Zone, Tong Fu YuIndustrial, Tang
Xia Yong, Songgang,Bao'an District, Shenzhen, Guangdong,
China

Prepared by : Shenzhen LCS Compliance Testing Laboratory Ltd.
Address : 1/F., Xingyuan Industrial Park, Tongda Road, Bao'an Avenue,
Bao'an District, Shenzhen, Guangdong, China

Tel : (+86)755-82591330
Fax : (+86)755-82591332
Web : www.LCS-cert.com
Mail : webmaster@LCS-cert.com

Date of receipt of test sample : May 31, 2016
Number of tested samples : 1
Sample number : Prototype
Date of Test : May 31, 2016~June 20, 2016
Date of Report : June 20, 2016

FCC TEST REPORT
FCC CFR 47 PART 15 C(15.247): 2015

Report Reference No. : LCS1605312728E

Date of Issue..... : June 20, 2016

Testing Laboratory Name : Shenzhen LCS Compliance Testing Laboratory Ltd.

Address..... : 1/F., Xingyuan Industrial Park, Tongda Road, Bao'an Avenue, Bao'an District, Shenzhen, Guangdong, China

Testing Location/ Procedure : Full application of Harmonised standards [checked]
Partial application of Harmonised standards []
Other standard testing method []

Applicant's Name : Shenzhen L&Y Audio Co., LTD

Address..... : No.2 Bldg, No.2 Industrial Zone, Tong Fu Yu Industrial, Tang Xia Yong, Songgang, Bao'an District, Shenzhen, Guangdong, China

Test Specification

Standard..... : FCC CFR 47 PART 15 C(15.247): 2015 / ANSI C63.10: 2013

Test Report Form No..... : LCSEMC-1.0

TRF Originator : Shenzhen LCS Compliance Testing Laboratory Ltd.

Master TRF : Dated 2011-03

Shenzhen LCS Compliance Testing Laboratory Ltd. All rights reserved.

This publication may be reproduced in whole or in part for non-commercial purposes as long as the Shenzhen LCS Compliance Testing Laboratory Ltd. is acknowledged as copyright owner and source of the material. Shenzhen LCS Compliance Testing Laboratory Ltd. takes no responsibility for and will not assume liability for damages resulting from the reader's interpretation of the reproduced material due to its placement and context.

Test Item Description..... : Bluetooth Speaker

Trade Mark..... : DREAMWAVE

Test Model..... : Harmony II

Ratings..... : DC 11.1V by battery (1500mAh)
Recharge Voltage: 5V=1-2A

Result : Positive

Compiled by:

Ada Liang

Supervised by:

Glin Lu

Approved by:

Gavin Liang

Ada Liang/ File administrators

Glin Lu/ Technique principal

Gavin Liang/ Manager

FCC -- TEST REPORT

Test Report No. : LCS1605312728E	<u>June 20, 2016</u> Date of issue
---	---------------------------------------

Test Model.....	: Harmony II
EUT.....	: Bluetooth Speaker
Applicant.....	: Shenzhen L&Y Audio Co., LTD
Address.....	: No.2 Bldg, No.2 Industrial Zone, Tong Fu YuIndustrial, Tang Xia Yong, Songgang,Bao'an District, Shenzhen, Guangdong, China
Telephone.....	: /
Fax.....	: /
Manufacturer.....	: Shenzhen L&Y Audio Co., LTD
Address.....	: No.2 Bldg, No.2 Industrial Zone, Tong Fu YuIndustrial, Tang Xia Yong, Songgang,Bao'an District, Shenzhen, Guangdong, China
Telephone.....	: /
Fax.....	: /
Factory.....	: Shenzhen L&Y Audio Co., LTD
Address.....	: No.2 Bldg, No.2 Industrial Zone, Tong Fu YuIndustrial, Tang Xia Yong, Songgang,Bao'an District, Shenzhen, Guangdong, China
Telephone.....	: /
Fax.....	: /

Test Result	Positive
--------------------	-----------------

The test report merely corresponds to the test sample.
 It is not permitted to copy extracts of these test result without the written permission of the test laboratory.

Revision History

Revision	Issue Date	Revisions	Revised By
00	2016-06-20	Initial Issue	Gavin Liang

TABLE OF CONTENTS

1. GENERAL INFORMATION.....	6
1.1 Description of Device (EUT).....	6
1.2 Support equipment List.....	6
1.3 External I/O	6
1.4 Description of Test Facility	7
1.5 List Of Measuring Equipment	7
1.6 Statement of The Measurement Uncertainty	8
1.7 Measurement Uncertainty.....	8
1.8 Description Of Test Modes.....	9
2. TEST METHODOLOGY	10
2.1 EUT Configuration	10
2.2 EUT Exercise.....	10
2.3 General Test Procedures	10
3. SYSTEM TEST CONFIGURATION.....	11
3.1 Justification.....	11
3.2 EUT Exercise Software	11
3.3 Special Accessories	11
3.4 Block Diagram/Schematics.....	11
3.5 Equipment Modifications	11
3.6 Test Setup	11
4. SUMMARY OF TEST RESULTS	12
5. ANTENNA PORT MEASUREMENT	13
5.1 Maximum Conducted Output Power	13
5.2 Frequency Separation And 20 dB Bandwidth	16
5.3 Number Of Hopping Frequency	21
5.4 Time Of Occupancy (Dwell Time).....	23
5.5 Conducted Spurious Emissions and Band Edges Test.....	25
6. RADIATED MEASUREMENT	29
6.1 Standard Applicable.....	29
6.2 Instruments Setting	29
6.3 Test Procedures.....	30
6.4 Test Setup Layout	34
6.5 EUT Operation during Test	35
6.6 Results for Radiated Emissions	35
6.7 Results for Band edge Testing (Radiated)	38
7. LINE CONDUCTED EMISSIONS.....	39
7.1 Standard Applicable.....	39
7.2 Block Diagram of Test Setup.....	39
7.3 Test Results.....	39
8. ANTENNA REQUIREMENT	41
8.1 Standard Applicable.....	41
8.2 Antenna Connected Construction	41

1. GENERAL INFORMATION

1.1 Description of Device (EUT)

EUT	: Bluetooth Speaker
Test Model	: Harmony II
Hardware Version	: LB-283II
Software Version	: LB-283 (BT1207SA-PA)
Power Supply	: DC 11.1V by battery (1500mAh) Recharge Voltage: 5V==1-2A
Frequency Range	: 2402.00-2480.00MHz
Channel Spacing	: 1MHz for Bluetooth V3.0 (DSS) 2MHz for Bluetooth V4.0 (DTS)
Channel Number	: 79 channels for Bluetooth V3.0 (DSS) 40 channels for Bluetooth V4.0 (DTS)
Modulation Type	: GFSK, Pi/4-DQPSK, 8-DPSK for Bluetooth V3.0 (DSS) GFSK for Bluetooth V4.0 (DTS)
Bluetooth Version	: This report is only for V3.0 part only. For V4.0 BLE part, please see another separate report.
Antenna Description	: Internal Antenna, 1.84dBi (Max.)

Additional models No.		
--	--	--
<i>Remark: no additional models were tested.</i>		

1.2 Support equipment List

Manufacturer	Description	Model	Serial Number	Certificate
Lenovo	PC	B470	--	DOC
Lenovo	AC/DC Adapter	ADP-900DB	--	VOC

1.3 External I/O

I/O Port Description	Quantity	Cable
Charge Interface	1	N/A
AUX IN	1	N/A

1.4 Description of Test Facility

CNAS Registration Number. is L4595.

FCC Registration Number. is 899208.

Industry Canada Registration Number. is 9642A-1.

VCCI Registration Number. is C-4260 and R-3804.

ESMD Registration Number. is ARCB0108.

UL Registration Number. is 100571-492.

TUV SUD Registration Number. is SCN1081.

TUV RH Registration Number. is UA 50296516-001

1.5 List Of Measuring Equipment

Instrument	Manufacturer	Model No.	Serial No.	Characteristics	Cal Date	Due Date
EMC Receiver	R&S	ESCS 30	100174	9kHz – 2.75GHz	June 18,2016	June 17,2017
Signal analyzer	Agilent	E4448A(External mixers to 40GHz)	US44300469	9kHz~40GHz	July 16,2015	July 15,2016
LISN	MESS Tec	NNB-2/16Z	99079	9KHz-30MHz	June 18,2016	June 17,2017
LISN (Support Unit)	EMCO	3819/2NM	9703-1839	9KHz-30MHz	June 18,2016	June 17,2017
RF Cable-CON	UTIFLEX	3102-26886-4	CB049	9KHz-30MHz	June 18,2016	June 17,2017
ISN	SCHAFFNER	ISN ST08	21653	9KHz-30MHz	June 18,2016	June 17,2017
3m Semi Anechoic Chamber	SIDT FRANKONIA	SAC-3M	03CH03-HY	30M-1GHz 3m	June 18,2016	June 17,2017
Amplifier	SCHAFFNER	COA9231A	18667	9kHz-2GHz	June 18,2016	June 17,2017
Amplifier	Agilent	8449B	3008A02120	1GHz-26.5GHz	July 16,2015	July 15,2016
Amplifier	MITEQ	AMF-6F-260400	9121372	26.5GHz-40GHz	July 16,2015	July 15,2016
Spectrum Analyzer	Agilent	E4407B	MY41440292	9k-26.5GHz	July 16,2015	July 15,2016
MAX Signal Analyzer	Agilent	N9020A	MY50510140	20Hz~26.5GHz	Oct. 27,2015	Oct. 26,2016
Loop Antenna	R&S	HFH2-Z2	860004/001	9k-30MHz	June 18,2016	June 17,2017
By-log Antenna	SCHWARZBECK	VULB9163	9163-470	30MHz-1GHz	June 10,2016	June 09,2017
Horn Antenna	EMCO	3115	6741	1GHz-18GHz	June 10,2016	June 09,2017
Horn Antenna	SCHWARZBECK	BBHA9170	BBHA9170154	15GHz-40GHz	June 10,2016	June 09,2017
RF Cable-R03m	Jye Bao	RG142	CB021	30MHz-1GHz	June 18,2016	June 17,2017
RF Cable-HIGH	SUHNER	SUCOFLEX 106	03CH03-HY	1GHz-40GHz	June 18,2016	June 17,2017
Power Meter	R&S	NRVS	100444	DC-40GHz	June 18,2016	June 17,2017
Power Sensor	R&S	NRV-Z51	100458	DC-30GHz	June 18,2016	June 17,2017
Power Sensor	R&S	NRV-Z32	10057	30MHz-6GHz	June 18,2016	June 17,2017
RF CABLE-1m	JYE Bao	RG142	CB034-1m	20MHz-7GHz	June 18,2016	June 17,2017
RF CABLE-2m	JYE Bao	RG142	CB035-2m	20MHz-1GHz	June 18,2016	June 17,2017

Note: All equipment through GRGT EST calibration

1.6 Statement of The Measurement Uncertainty

The data and results referenced in this document are true and accurate. The reader is cautioned that there may be errors within the calibration limits of the equipment and facilities. The measurement uncertainty was calculated for all measurements listed in this test report acc. To CISPR 16 – 4 “Specification for radio disturbance and immunity measuring apparatus and methods – Part 4: Uncertainty in EMC Measurements” and is documented in the LCS quality system acc. To DIN EN ISO/IEC 17025. Furthermore, component and process variability of devices similar to that tested may result in additional deviation. The manufacturer has the sole responsibility of continued compliance of the device.

1.7 Measurement Uncertainty

Test Item	Frequency Range	Uncertainty	Note
Radiation Uncertainty	9KHz~30MHz	3.10dB	(1)
	30MHz~200MHz	2.96dB	(1)
	200MHz~1000MHz	3.10dB	(1)
	1GHz~26.5GHz	3.80dB	(1)
	26.5GHz~40GHz	3.90dB	(1)
Conduction Uncertainty	150kHz~30MHz	1.63dB	(1)
Power disturbance	30MHz~300MHz	1.60dB	(1)

(1). This uncertainty represents an expanded uncertainty expressed at approximately the 95% confidence level using a coverage factor of k=2.

1.8 Description Of Test Modes

Bluetooth operates in the unlicensed ISM Band at 2.4GHz. With the introduction of the enhanced data rate (EDR) feature, the data rates can be up to 3 Mb/s. An increase in the peak data rate beyond the basic rate of 1 Mb/s is achieved by modulating the RF carrier using GFSK techniques, resulting in an increase of two to three times the number of bits per symbol. The 2 Mb/s EDR packets use $\pi/4$ -DQPSK modulation and the 3 Mb/s EDR packets use 8DPSK modulation. The following operating modes were applied for the related test items. For radiated measurement, the test was performed with EUT in X, Y, Z position and the worse case was found when EUT in X position. All test modes were tested, only the result of the worst case was recorded in the report.

Mode of Operations	Frequency Range (MHz)	Data Rate (Mbps)
GFSK	2402	1
	2441	1
	2480	1
$\pi/4$ DQPSK	2402	2
	2441	2
	2480	2
8-DPSK	2402	3
	2441	3
	2480	3
For Conducted Emission		
Test Mode	TX Mode	
For Radiated Emission		
Test Mode	TX Mode	

Worst-case mode and channel used for 150kHz-30 MHz power line conducted emissions was the mode and channel with the highest output power, that was determined to be TX(1Mbps-Hopping Mode).

Worst-case mode and channel used for 9kHz-1000 MHz radiated emissions was determined to be TX-Low Channel (2402MHz, 1Mbps).

***Note: Using a temporary antenna connector for the EUT when the conducted measurements are performed.

For pre-testing, when performed with LiPo Battery Charger, the input Voltage/Frequency AC 120V/60Hz and AC 240V/60Hz were used. Only recorded the worst case in this report.

2. TEST METHODOLOGY

The tests documented in this report were performed in accordance with ANSI C63.10: 2013, FCC CFR PART 15C 15.207, 15.209, 15.247 and DA 00-705.

2.1 EUT Configuration

The EUT configuration for testing is installed on RF field strength measurement to meet the Commissions requirement and operating in a manner that intends to maximize its emission characteristics in a continuous normal application.

2.2 EUT Exercise

The EUT was operated in the engineering mode to fix the TX frequency that was for the purpose of the measurements.

According to its specifications, the EUT must comply with the requirements of the Section 15.207, 15.209, 15.247 under the FCC Rules Part 15 Subpart C.

2.3 General Test Procedures

2.3.1 Conducted Emissions

According to the requirements in Section 6.2 of ANSI C63.10: 2013, AC power-line conducted emissions shall be measured in the frequency range between 0.15 MHz and 30MHz using Quasi-peak and average detector modes.

2.3.2 Radiated Emissions

The EUT is placed on a turn table and the turntable shall rotate 360 degrees to determine the position of maximum emission level. EUT is set 3m away from the receiving antenna, which varied from 1m to 4m to find out the highest emission. And also, each emission was to be maximized by changing the polarization of receiving antenna both horizontal and vertical. In order to find out the maximum emissions, exploratory radiated emission measurements were made according to the requirements in Section 6.3 of ANSI C63.10: 2013

3. SYSTEM TEST CONFIGURATION

3.1 Justification

The system was configured for testing in a continuous transmit condition.

3.2 EUT Exercise Software

N/A.

3.3 Special Accessories

N/A.

3.4 Block Diagram/Schematics

Please refer to the related document.

3.5 Equipment Modifications

Shenzhen LCS Compliance Testing Laboratory Ltd. has not done any modification on the EUT.

3.6 Test Setup

Please refer to the test setup photo.

4. SUMMARY OF TEST RESULTS

Applied Standard: FCC Part 15 Subpart C		
FCC Rules	Description of Test	Result
§15.247(b)(1)	Maximum Conducted Output Power	Compliant
§15.247(a)(1)	Frequency Separation And 20 dB Bandwidth	Compliant
§15.247(a)(1)(iii)	Number Of Hopping Frequency	Compliant
§15.247(a)(1)(iii)	Time Of Occupancy (Dwell Time)	Compliant
§15.209, §15.247(d)	Radiated and Conducted Spurious Emissions	Compliant
§15.205	Emissions at Restricted Band	Compliant
§15.207(a)	Line Conducted Emissions	Compliant
§15.203	Antenna Requirements	Compliant

5. ANTENNA PORT MEASUREMENT

5.1 Maximum Conducted Output Power

5.1.1 Block Diagram of Test Setup

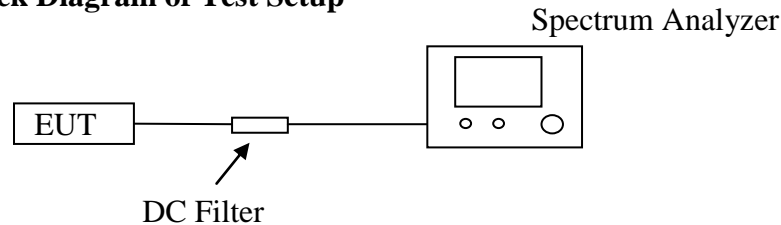

5.1.2 Limit

According to § 15.247(b)(1), For frequency hopping systems operating in the 2400-2483.5 MHz band employing at least 75 non-overlapping hopping channels, and all frequency hopping systems in the 5725-5850 MHz band: 1 watt. For all other frequency hopping systems in the 2400-2483.5 MHz band: 0.125 watts.

5.1.3 Test Procedure

The output of the transmitter shall be connected to a spectrum analyzer.

a) Use the following spectrum analyzer settings:

Span: Approximately five times the 20 dB bandwidth, centered on a hopping channel.
 RBW > 20 dB bandwidth of the emission being measured.

VBW ≥ RBW. Sweep: Auto.

Detector function: Peak. Trace: Max hold.

b) Allow trace to stabilize.

c) Use the marker-to-peak function to set the marker to the peak of the emission.

5.1.4 Test Results

Channel	Frequency (MHz)	Output Power (dBm, Average)	Output Power (mW)	Limit (mW)	Result
GFSK	2402	0.571	1.14	1000	Pass
	2441	2.062	1.61	1000	Pass
	2480	2.259	1.68	1000	Pass
π /4 DQPSK	2402	1.351	1.36	125	Pass
	2441	1.116	1.29	125	Pass
	2480	-0.606	0.87	125	Pass
8-DPSK	2402	-0.537	0.88	125	Pass
	2441	1.130	1.30	125	Pass
	2480	1.391	1.38	125	Pass

Test Plots Of Maximum Conducted Output Power Measurement

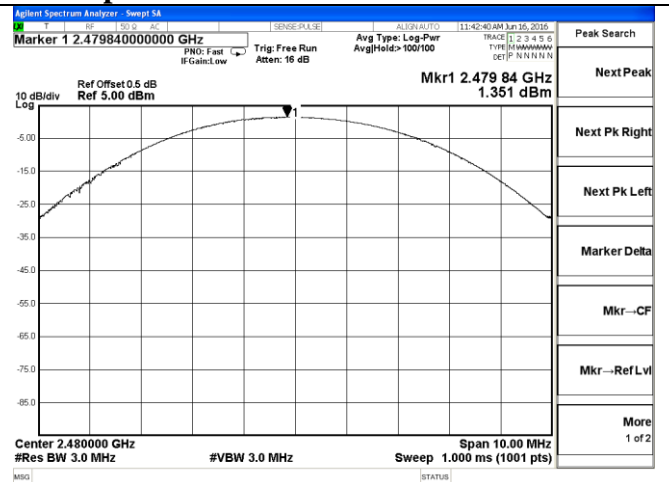
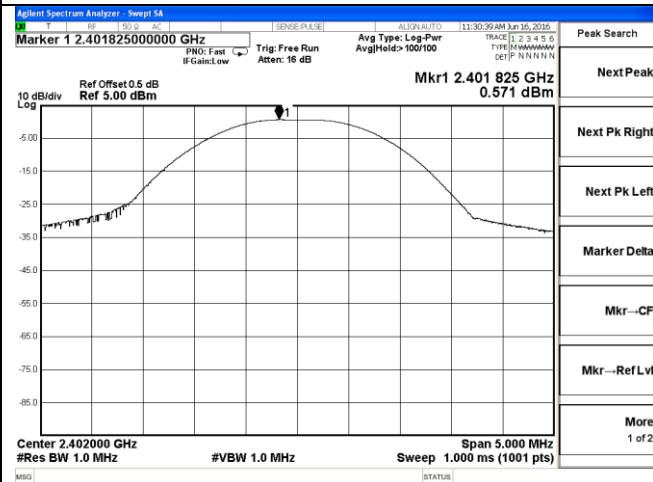

Test frequency: 2402MHz(1Mbps)

Test frequency: 2402MHz(2Mbps)

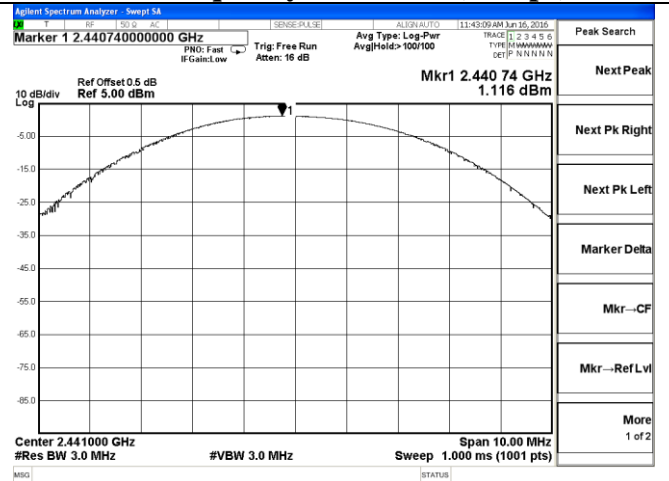
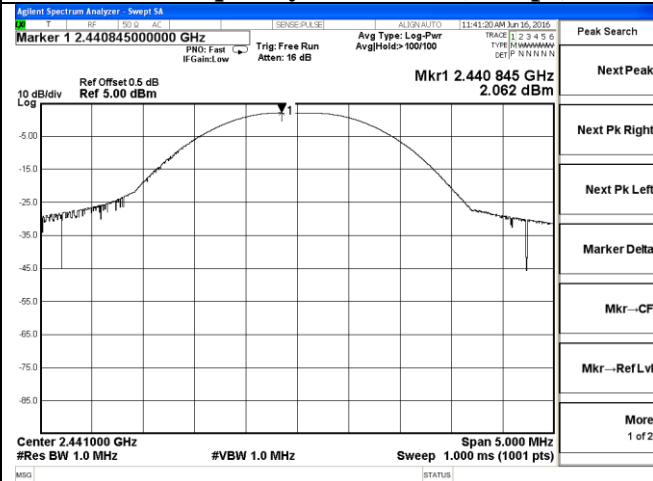

Test frequency: 2441MHz(1Mbps)

Test frequency: 2441MHz(2Mbps)

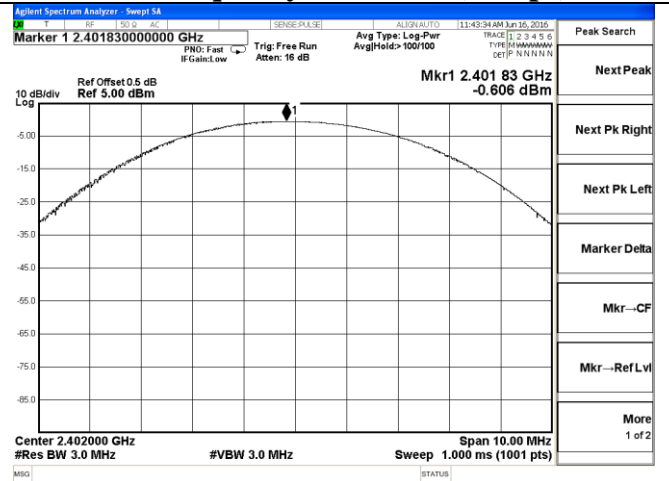
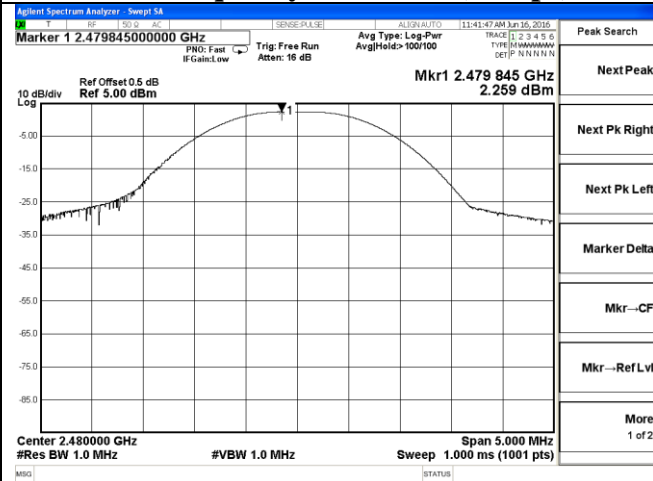

Test frequency: 2480MHz(1Mbps)

Test frequency: 2480MHz(2Mbps)

Test Plots Of Maximum Conducted Output Power Measurement

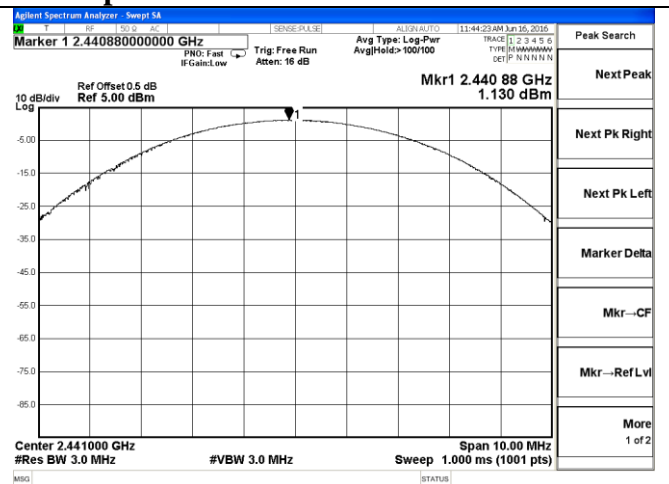
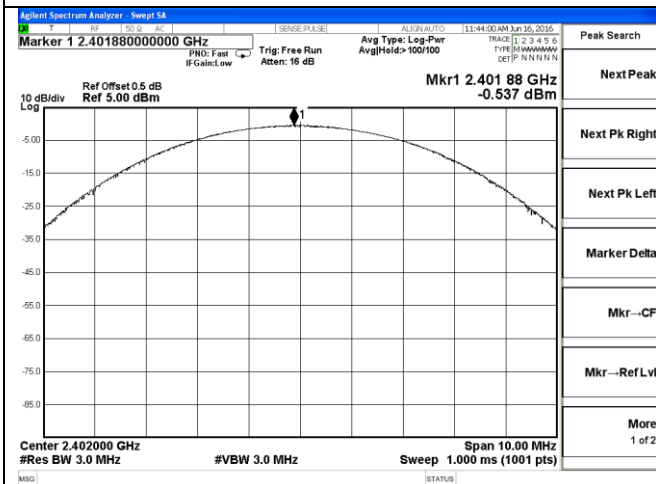

Test frequency: 2402MHz(3Mbps)

Test frequency: 2441MHz(3Mbps)

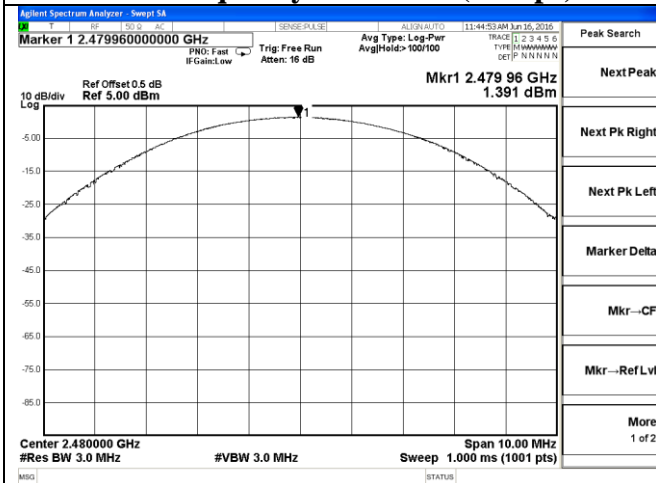

Test frequency: 2480MHz(3Mbps)

5.2 Frequency Separation And 20 dB Bandwidth

5.2.1 Limit

According to §15.247(a)(1), Frequency hopping systems shall have hopping channel carrier frequencies separated by a minimum of 25 kHz or the 20 dB bandwidth of the hopping channel, whichever is greater. Alternatively, frequency hopping systems operating in the 2400-2483.5 MHz band may have hopping channel carrier frequencies that are separated by 25 kHz or two-thirds of the 20 dB bandwidth of the hopping channel, whichever is greater, provided the systems operate with an output power no greater than 125 mW.

5.2.2 Block Diagram of Test Setup

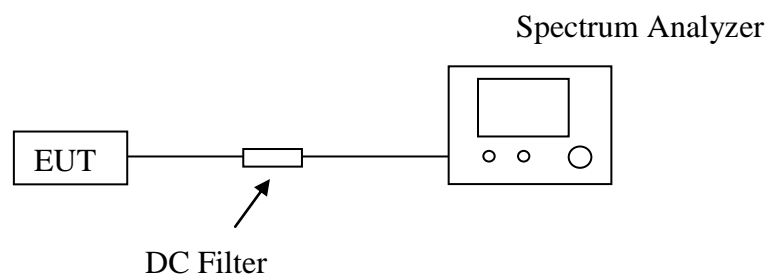

5.2.3 Test Procedure

- A. Place the EUT on the table and set it in transmitting mode.
- B. Remove the antenna from the EUT and then connect a low loss RF cable from the antenna port to the Spectrum Analyzer.
- C. Set to the maximum power setting and enable the EUT transmit continuously.
- D. For carrier frequency separation measurement, use the following spectrum analyzer settings:
 - Span = wide enough to capture the peaks of two adjacent channels;
 - RBW / VBW=100KHz / 300KHz; Sweep = auto; Detector function = peak;
 - Trace = max hold.
- E. For 20dB bandwidth measurement, use the following spectrum analyzer settings:
 - Span = approximately 2 to 3 times the 20 dB bandwidth, centered on a hopping channel; RBW/VBW=30KHz / 100KHz; Sweep = auto; Detector function = peak;
 - Trace = max hold.

5.2.4 Test Results

The Measurement Result With 1Mbps For GFSK Modulation			
20dB Bandwidth Measurement			
Channel	20dB Bandwidth (MHz)	Limit	
Low	0.831	Non-specified	
Middle	0.834	Non-specified	
High	0.837	Non-specified	
Channel Separation Measurement			
Channel	Channel Separation (MHz)	Limit (MHz)	Result
Low	1.000	0.831	Pass
Middle	1.000	0.834	Pass
High	1.000	0.837	Pass

The Measurement Result With 2Mbps For $\pi/4$ DQPSK Modulation			
20dB Bandwidth Measurement			
Channel	20dB Bandwidth (MHz)	Limit	
Low	1.117	Non-specified	
Middle	1.118	Non-specified	
High	1.117	Non-specified	
Channel Separation Measurement			
Channel	Channel Separation (MHz)	Limit (MHz)	Result
Low	1.000	0.745	Pass
Middle	1.000	0.745	Pass
High	1.000	0.745	Pass

The Measurement Result With 3Mbps For 8-DPSK Modulation			
20dB Bandwidth Measurement			
Channel	20dB Bandwidth (MHz)	Limit	
Low	1.162	Non-specified	
Middle	1.164	Non-specified	
High	1.166	Non-specified	
Channel Separation Measurement			
Channel	Channel Separation (MHz)	Limit (MHz)	Result
Low	1.000	0.775	Pass
Middle	1.000	0.776	Pass
High	1.000	0.777	Pass

The test data refer to the following page.

For Frequency Separation Measurement, the Low, Mid and High channels were performed and only recorded the worst test plots for Low in this report.

Test Plot Of Frequency Separation(Worst Case)

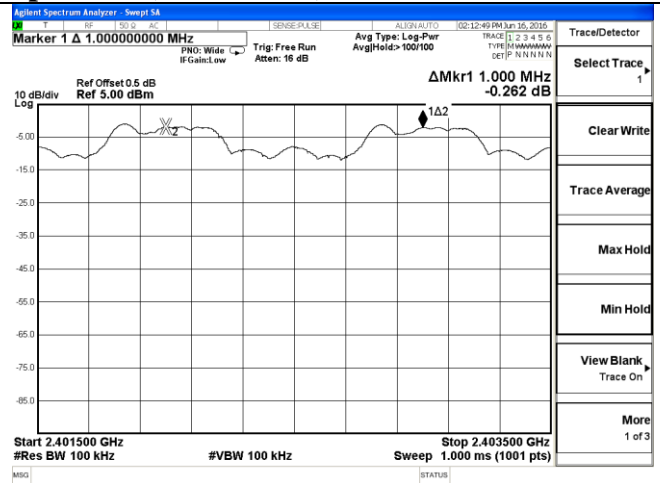
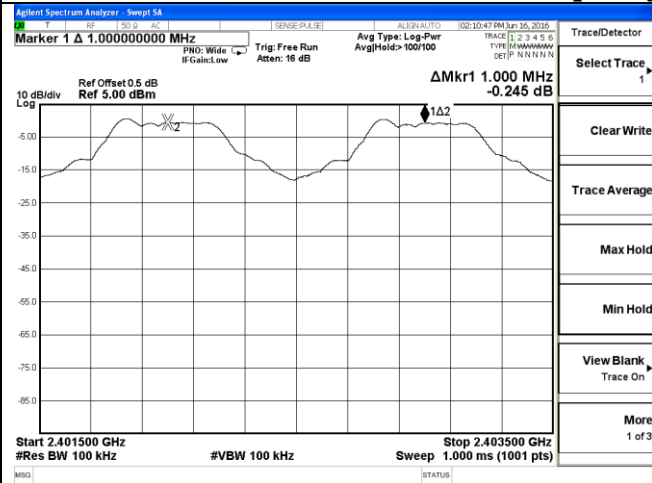

Test Plot Of Frequency Separation (1Mbps)

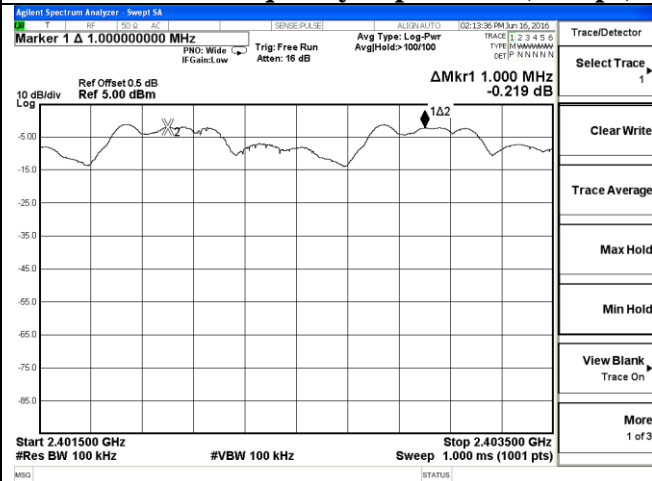

Test Plot Of Frequency Separation (2Mbps)

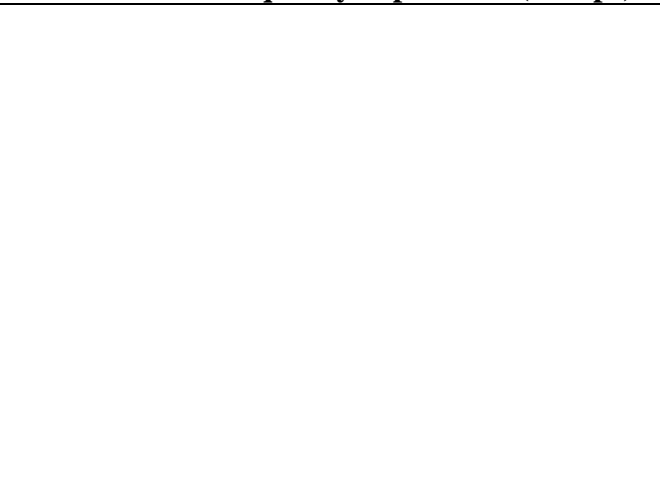

Test Plot Of Frequency Separation (3Mbps)

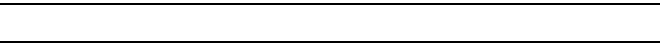

Measurement of 20dB Bandwidth

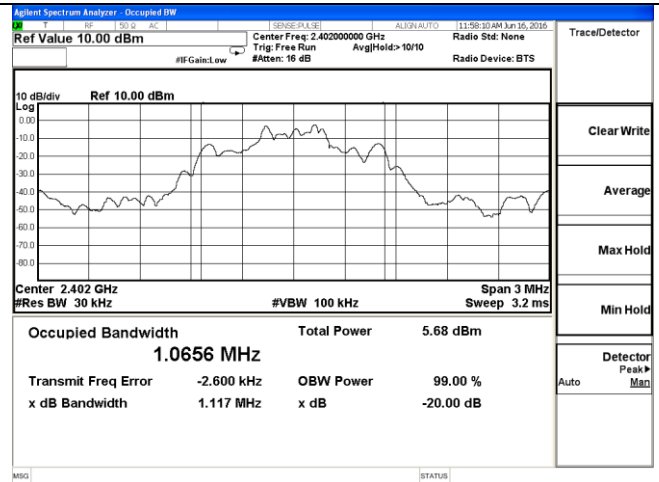
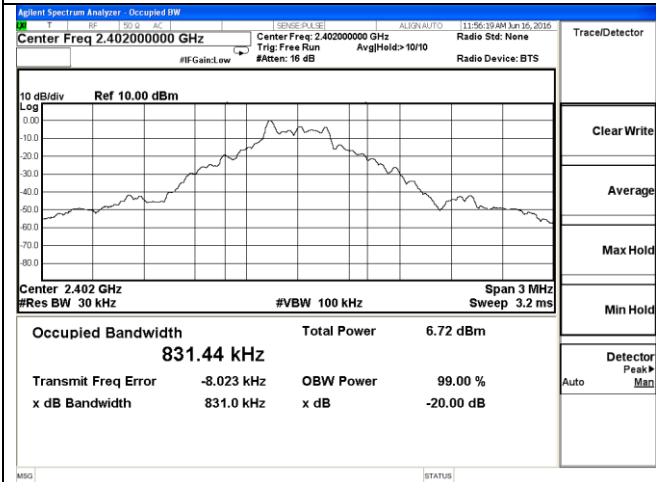

Test frequency: 2402MHz(1Mbps)

Test frequency: 2402MHz(2Mbps)

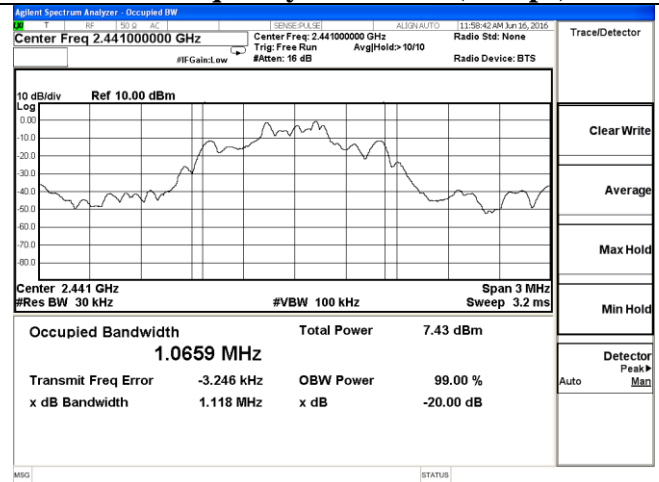
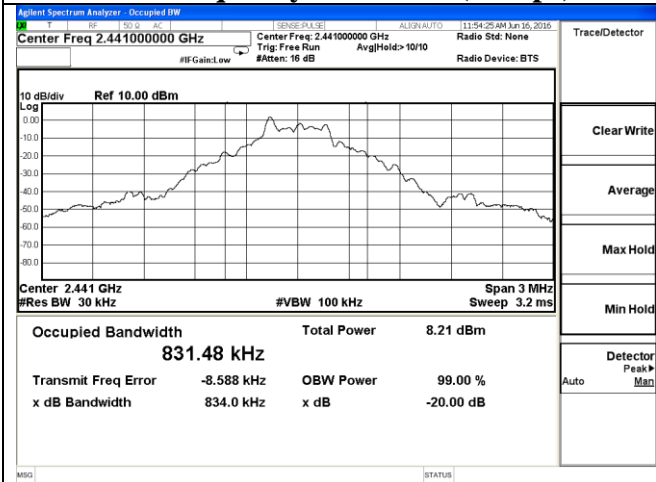

Test frequency: 2441MHz(1Mbps)

Test frequency: 2441MHz(2Mbps)

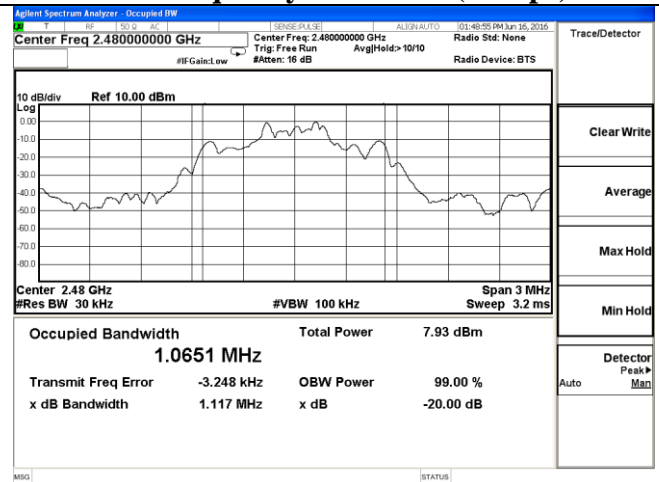
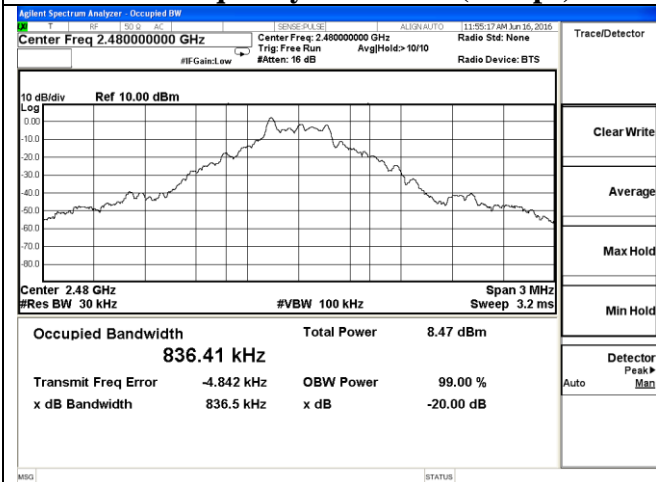

Test frequency: 2480MHz(1Mbps)

Test frequency: 2480MHz(2Mbps)

Measurement of 20dB Bandwidth

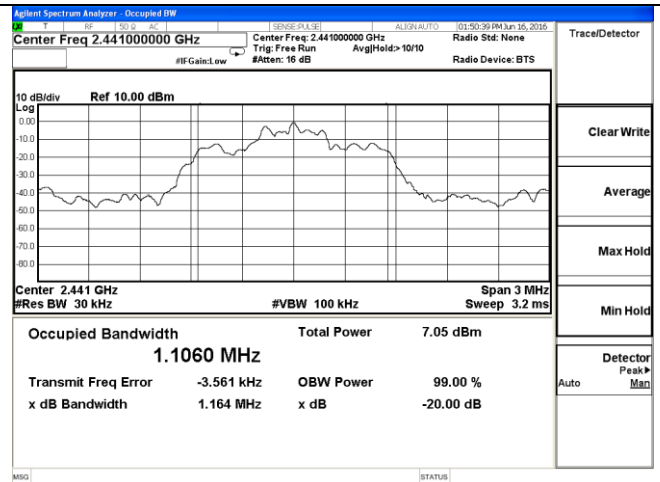
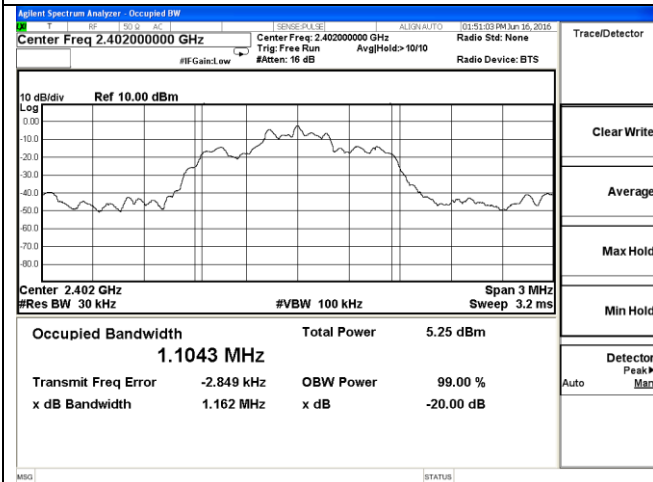

Test frequency: 2402MHz(3Mbps)

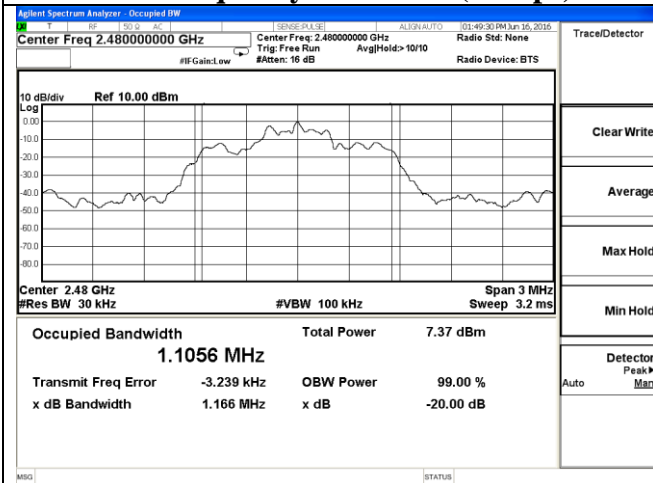

Test frequency: 2441MHz(3Mbps)

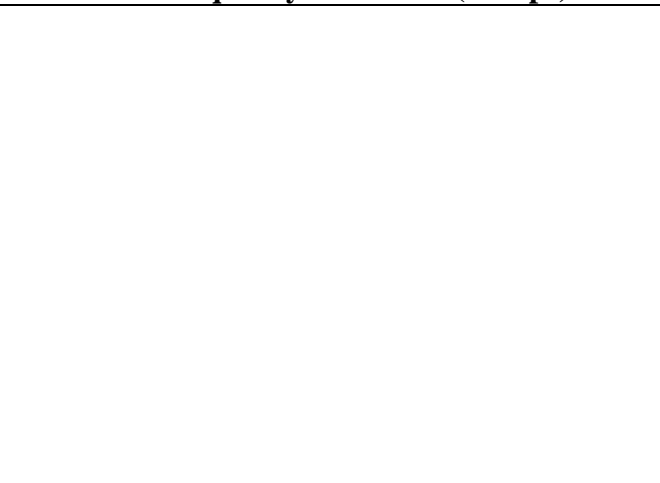

Test frequency: 2480MHz(3Mbps)

5.3 Number Of Hopping Frequency

5.3.1 Limit

According to §15.247(a)(1)(iii), Frequency hopping systems in the 2400-2483.5 MHz band shall use at least 15 channels.

5.3.2 Block Diagram of Test Setup

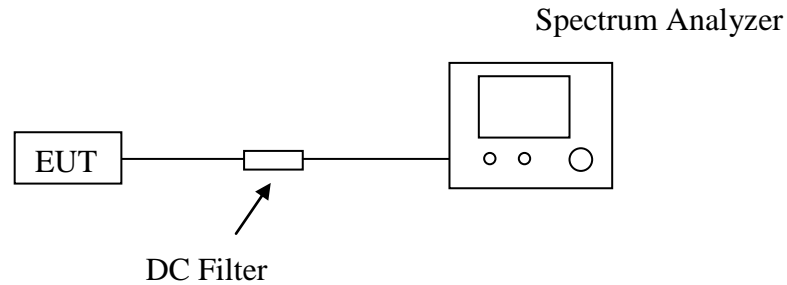

5.3.3 Test Procedure

- Place the EUT on the table and set it in transmitting mode.
- Remove the antenna from the EUT and then connect a low loss RF cable from the antenna port to the Spectrum Analyzer.
- Set Spectrum Analyzer Start=2400MHz, Stop = 2483.5MHz, Sweep = auto.
- Set the Spectrum Analyzer as RBW, VBW=1MHz.
- Max hold, view and count how many channel in the band.

5.3.4 Test Results

Test Mode	Measurement Result (No. of Ch)	Limit (No. of Ch)	Result
Hopping(GFSK)	79	≥ 15	Pass
Hopping($\pi/4$ -DQPSK)	79	≥ 15	Pass
Hopping(8-DPSK)	79	≥ 15	Pass

The worst test data refer to the following page.

Test Plot For Number of Hopping Channel(GFSK)

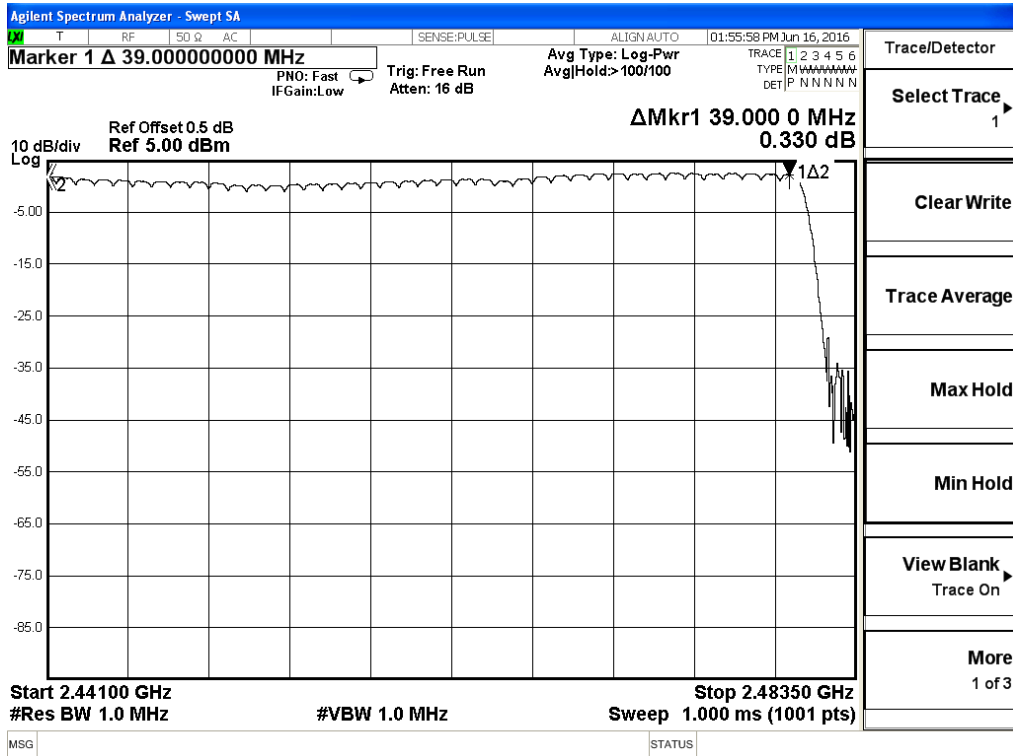
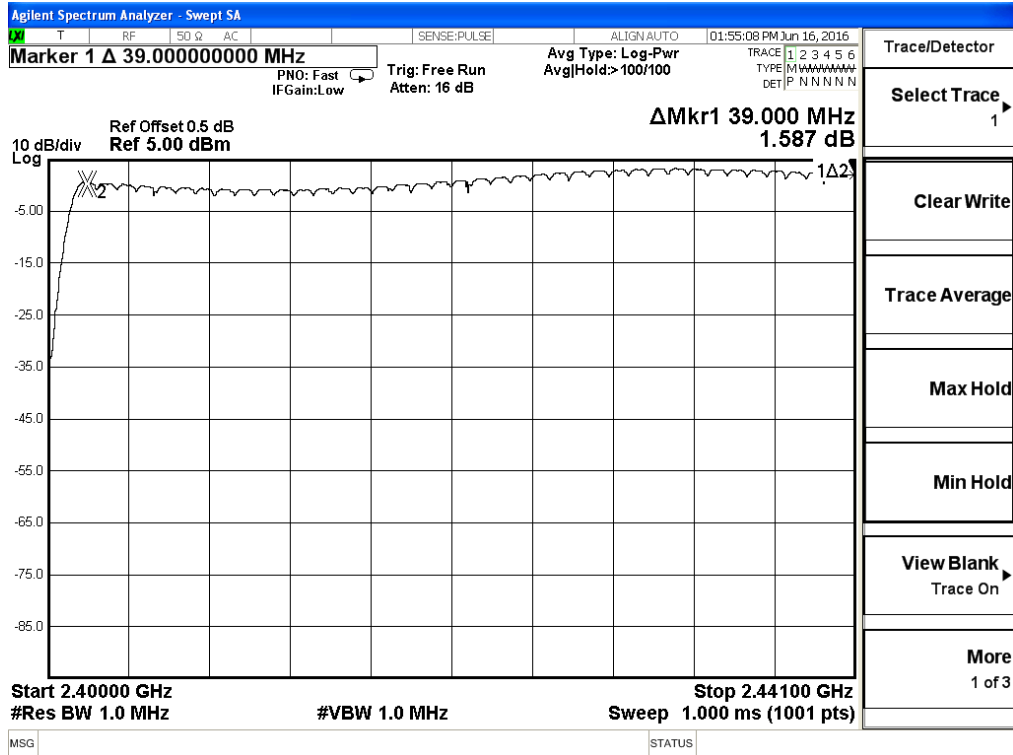

5.4 Time Of Occupancy (Dwell Time)

5.4.1 Limit

According to §15.247(a)(1)(iii), Frequency hopping systems operating in the 2400MHz-2483.5 MHz bands. The average time of occupancy on any channel shall not be greater than 0.4 seconds within a period of 0.4seconds multiplied by the number of hopping channels employed.

5.4.2 Block Diagram of Test Setup

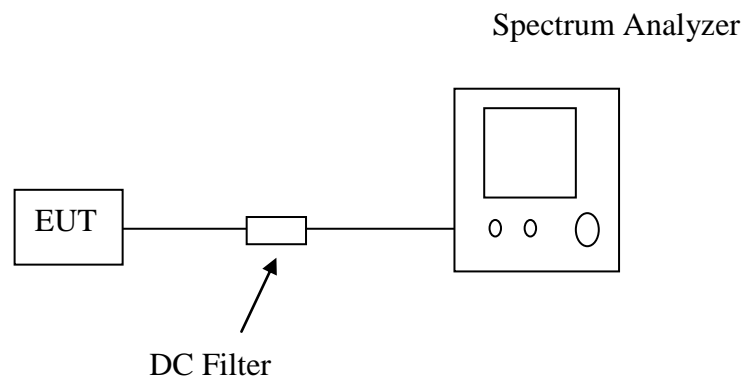

5.4.3 Test Procedure

- A. Place the EUT on the table and set it in transmitting mode.
- B. Remove the antenna from the EUT and then connect a low loss RF cable from the antenna port to the Spectrum Analyzer.
- C. Set center frequency of Spectrum Analyzer = operating frequency.
- D. Set the Spectrum Analyzer as RBW, VBW=1MHz, Span = 0Hz, Sweep = auto.
- E. Repeat above procedures until all frequency measured were complete.

5.4.4 Test Results

The Measurement Result With The Worst Case of 1Mbps For GFSK Modulation

Channel	Time of Pulse for DH5 (ms)	Period Time (s)	Sweep Time (ms)	Limit (ms)
Low	2.88	31.6	307.2	400
Middle	2.88	31.6	307.2	400
High	2.88	31.6	307.2	400

Calculation formula: Dwell Time(3DH5)=Burst Length(ms)*(1600/6)/79*31.6

Measurement of Time Of Occupancy (Dwell Time)

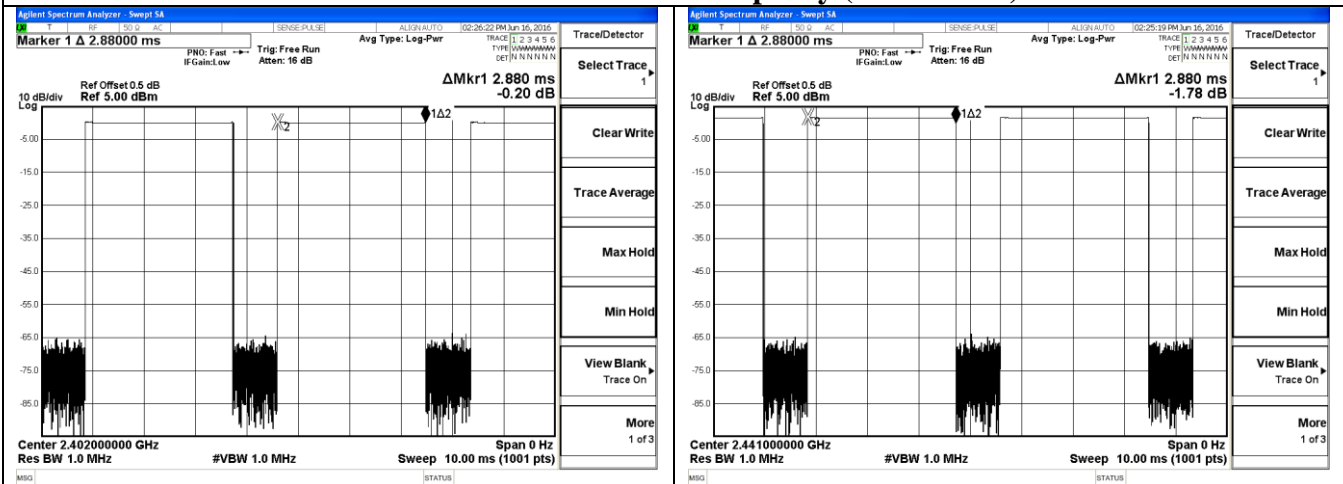

Test frequency: 2402MHz(3Mbps)

Test frequency: 2441MHz(3Mbps)

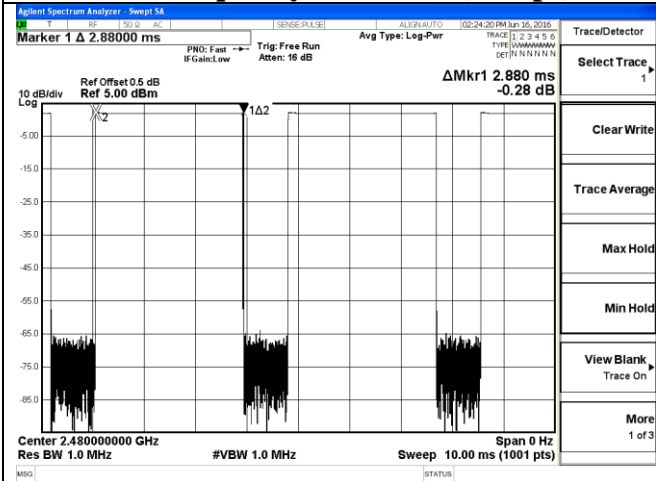

Test frequency: 2480MHz(3Mbps)

5.5 Conducted Spurious Emissions and Band Edges Test

5.5.1 Limit

In any 100 kHz bandwidth outside the frequency band in which the spread spectrum or digitally modulated intentional radiator is operating, the radio frequency power that is produced by the intentional radiator shall be at least 20 dB below that in the 100 kHz bandwidth within the band that contains the highest level of the desired power, based on either an RF conducted or a radiated measurement, provided the transmitter demonstrates compliance with the peak conducted power limits. If the transmitter complies with the conducted power limits based on the use of RMS averaging over a time interval, as permitted under paragraph (b)(3) of this section, the attenuation required under this paragraph shall be 30 dB instead of 20 dB. Attenuation below the general limits specified in §15.209(a) is not required. In addition, radiated emissions which fall in the restricted bands, as defined in §15.205(a), must also comply with the radiated emission limits specified in §15.209(a) (see §15.205(c)).

5.5.2 Block Diagram of Test Setup

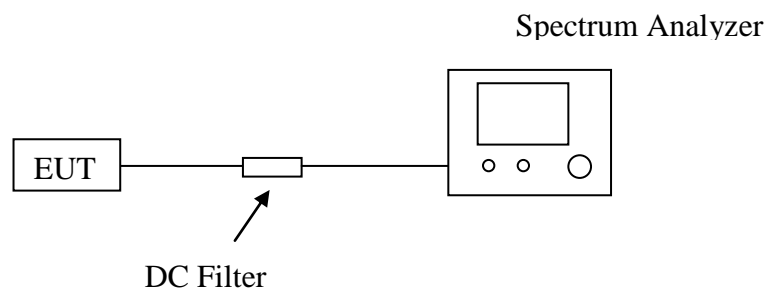

5.5.3 Test Procedure

Conducted RF measurements of the transmitter output were made to confirm that the EUT antenna port conducted emissions meet the specified limit and to identify any spurious signals that require further investigation or measurements on the radiated emissions site.

The transmitter output is connected to the spectrum analyzer. The resolution bandwidth is set to 100 KHz. The video bandwidth is set to 300 KHz.

Measurements are made over the 9kHz to 26.5GHz range with the transmitter set to the lowest, middle, and highest channels

5.5.4 Test Results of Conducted Spurious Emissions

No non-compliance noted. Only record the worst test result (TX-GFSK) in this report. The test data refer to the following page.

Test Results of Conducted Spurious Emissions (Worst Case)

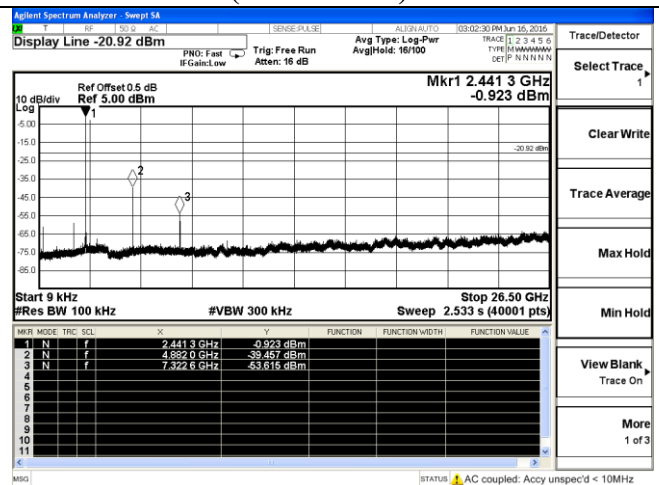
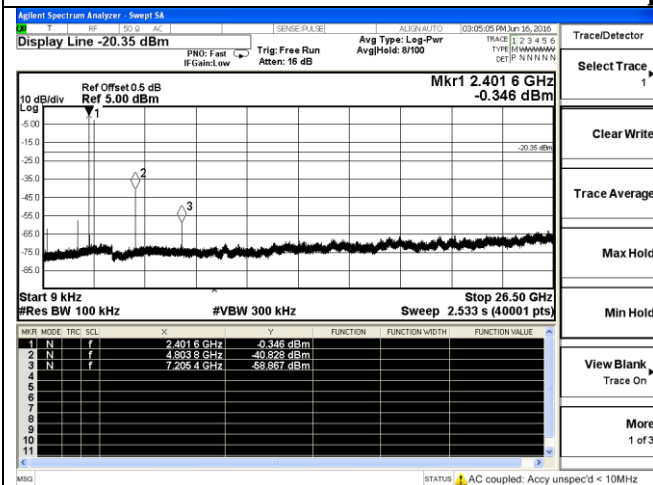

Test frequency: 2402MHz(1Mbps)

Test frequency: 2441MHz(1Mbps)

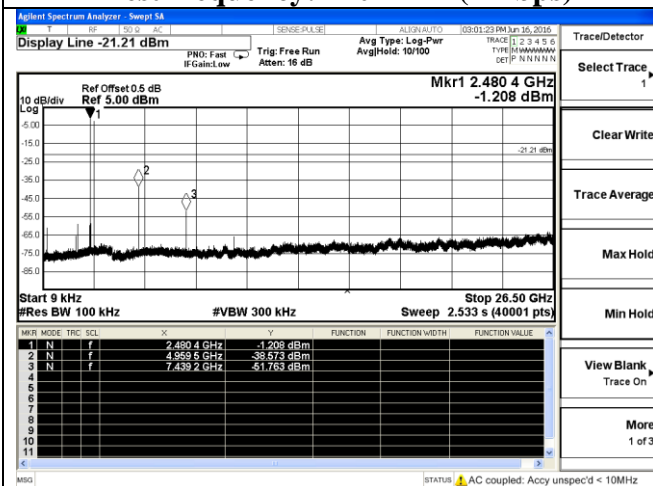

Test frequency: 2480MHz(1Mbps)

5.5.5 Test Results of Band Edges Test

No non-compliance noted. Only record the worst test result in this report. The test data refer to the following page.

Test Results of Band Edges Test (Worst Case) Hopping On (1Mbps)

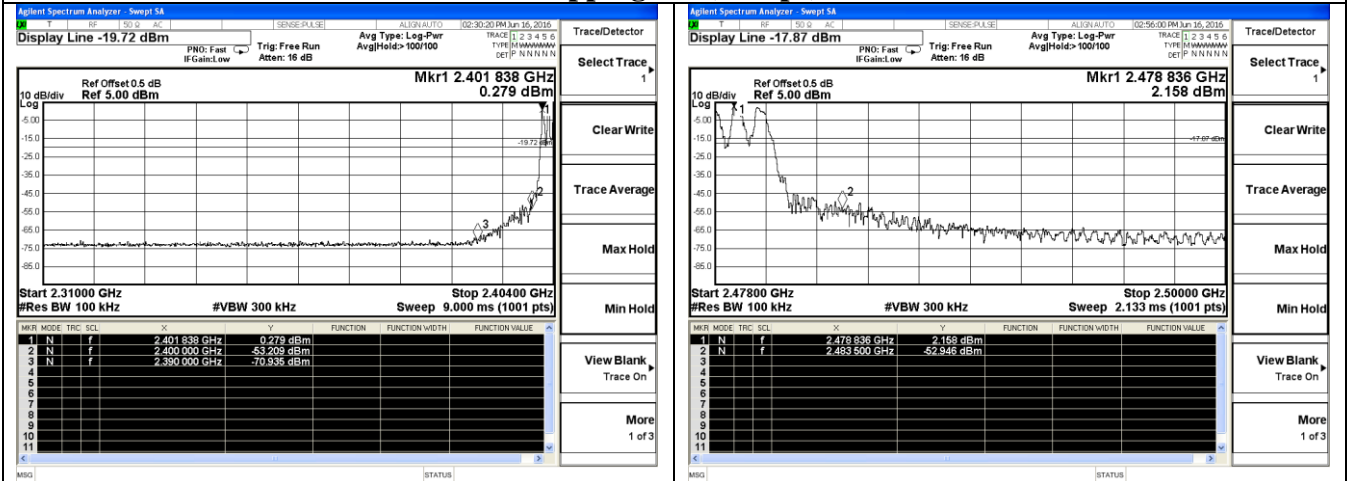

Hopping Off (1Mbps)

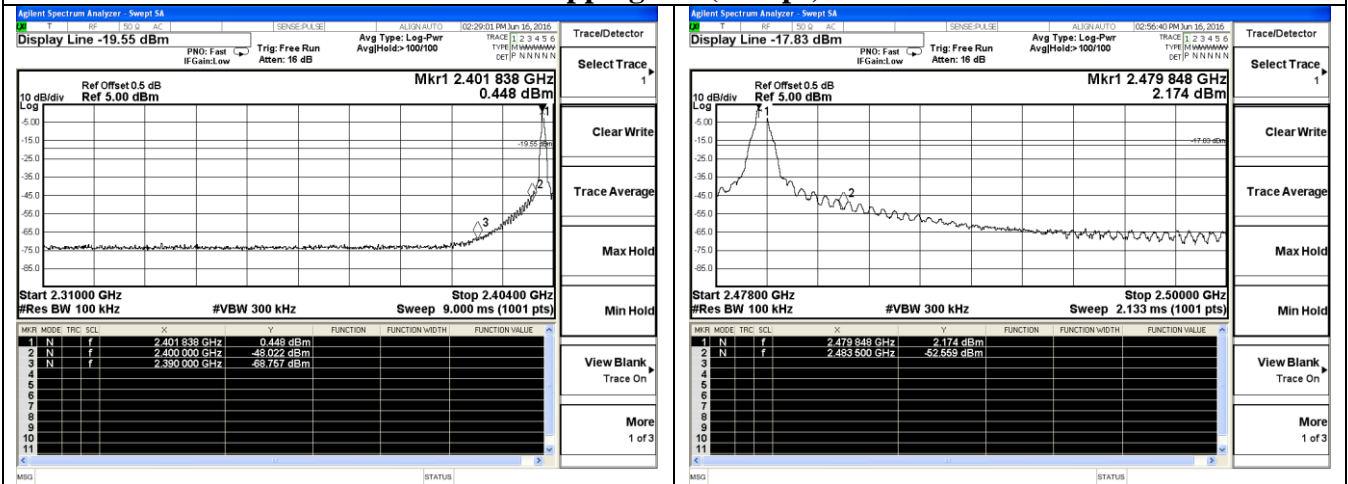

Hopping On (3Mbps)

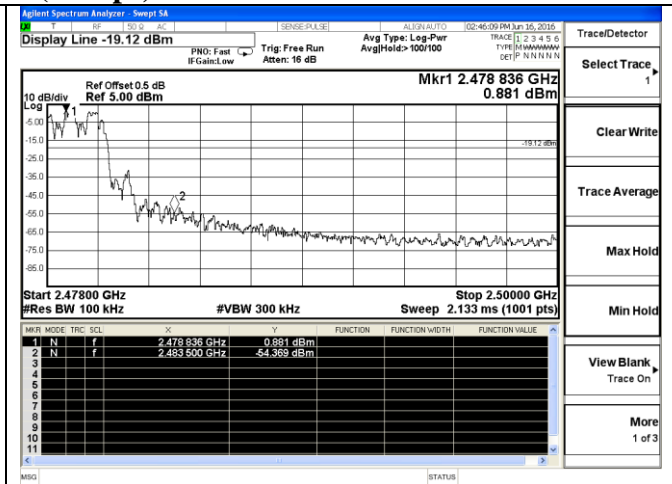
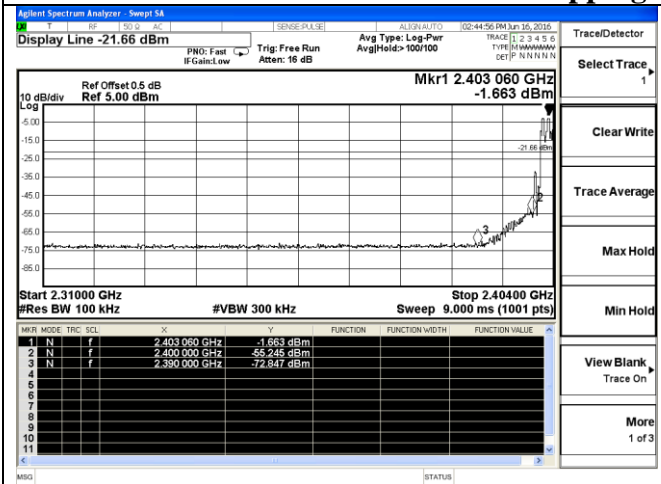

Hopping Off (3Mbps)

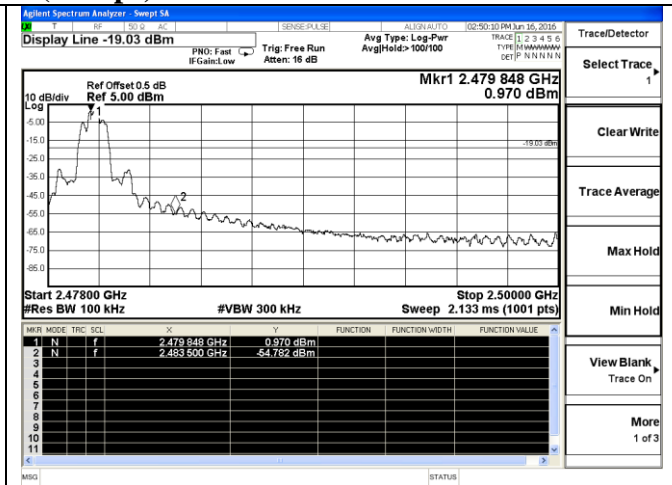
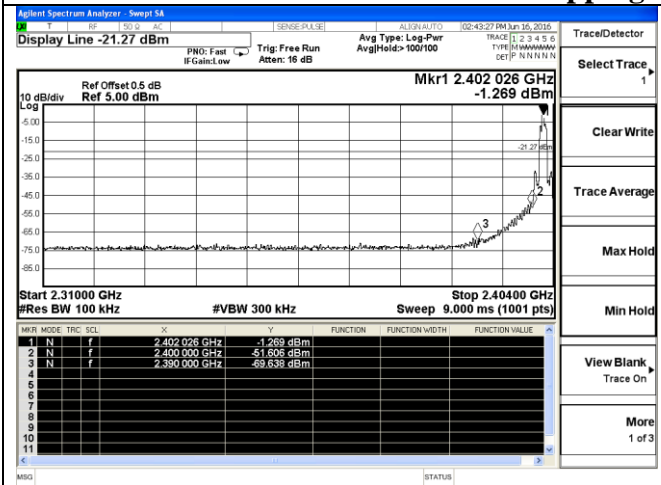

6. RADIATED MEASUREMENT

6.1 Standard Applicable

According to §15.247 (d): 20dBc in any 100 kHz bandwidth outside the operating frequency band. In case the emission fall within the restricted band specified on 15.205(a), then the 15.209(a) limit in the table below has to be followed.

Frequencies(MHz)	Field Strength(microvolts/meter)	Measurement Distance(meters)
0.009~0.490	2400/F(KHz)	300
0.490~1.705	24000/F(KHz)	30
1.705~30.0	30	30
30~88	100	3
88~216	150	3
216~960	200	3
Above 960	500	3

6.2 Instruments Setting

The following table is the setting of spectrum analyzer and receiver.

Spectrum Parameter	Setting
Attenuation	Auto
Start Frequency	1000 MHz
Stop Frequency	10th carrier harmonic
RB / VB (Emission in restricted band)	1MHz / 1MHz for Peak, 1 MHz / 10Hz for Average
RB / VB (Emission in non-restricted band)	1MHz / 1MHz for Peak, 1 MHz / 10Hz for Average

Receiver Parameter	Setting
Attenuation	Auto
Start ~ Stop Frequency	9kHz~150kHz / RB 200Hz for QP
Start ~ Stop Frequency	150kHz~30MHz / RB 9kHz for QP
Start ~ Stop Frequency	30MHz~1000MHz / RB 100kHz for QP

6.3 Test Procedures

1) Sequence of testing 9 kHz to 30 MHz

Setup:

- The equipment was set up to simulate a typical usage like described in the user manual or described by manufacturer.
- If the EUT is a tabletop system, a rotatable table with 0.8 m height is used.
- If the EUT is a floor standing device, it is placed on the ground.
- Auxiliary equipment and cables were positioned to simulate normal operation conditions.
- The AC power port of the EUT (if available) is connected to a power outlet below the turntable.
- The measurement distance is 3 meter.
- The EUT was set into operation.

Premeasurement:

- The turntable rotates from 0 ° to 315 ° using 45 ° steps.
- The antenna height is 0.8 meter.
- At each turntable position the analyzer sweeps with peak detection to find the maximum of all emissions

Final measurement:

- Identified emissions during the premeasurement the software maximizes by rotating the turntable position (0 ° to 360 °) and by rotating the elevation axes (0 ° to 360 °).
- The final measurement will be done in the position (turntable and elevation) causing the highest emissions with QPK detector.
- The final levels, frequency, measuring time, bandwidth, turntable position, correction factor, margin to the limit and limit will be recorded. Also a plot with the graph of the premeasurement and the limit will be stored.

2) Sequence of testing 30 MHz to 1 GHz

Setup:

- The equipment was set up to simulate a typical usage like described in the user manual or described by manufacturer.
- If the EUT is a tabletop system, a table with 0.8 m height is used, which is placed on the ground plane.
- If the EUT is a floor standing device, it is placed on the ground plane with insulation between both.
- Auxiliary equipment and cables were positioned to simulate normal operation conditions
- The AC power port of the EUT (if available) is connected to a power outlet below the turntable.
- The measurement distance is 3 meter.
- The EUT was set into operation.

Premeasurement:

- The turntable rotates from 0 ° to 315 ° using 45 ° steps.
- The antenna is polarized vertical and horizontal.
- The antenna height changes from 1 to 3 meter.
- At each turntable position, antenna polarization and height the analyzer sweeps three times in peak to find the maximum of all emissions.

Final measurement:

- The final measurement will be performed with minimum the six highest peaks.
- According to the maximum antenna and turntable positions of premeasurement the software maximize the peaks by changing turntable position ($\pm 45^\circ$) and antenna movement between 1 and 4 meter.
- The final measurement will be done with QP detector with an EMI receiver.
- The final levels, frequency, measuring time, bandwidth, antenna height, antenna polarization, turntable angle, correction factor, margin to the limit and limit will be recorded. Also a plot with the graph of the premeasurement with marked maximum final measurements and the limit will be stored.

3) Sequence of testing 1 GHz to 18 GHz

Setup:

- The equipment was set up to simulate a typical usage like described in the user manual or described by manufacturer.
- If the EUT is a tabletop system, a rotatable table with 1.5 m height is used.
- If the EUT is a floor standing device, it is placed on the ground plane with insulation between both.
- Auxiliary equipment and cables were positioned to simulate normal operation conditions
- The AC power port of the EUT (if available) is connected to a power outlet below the turntable.
- The measurement distance is 3 meter.
- The EUT was set into operation.

Premeasurement:

- The turntable rotates from 0 ° to 315 ° using 45 ° steps.
- The antenna is polarized vertical and horizontal.
- The antenna height scan range is 1 meter to 2.5 meter.
- At each turntable position and antenna polarization the analyzer sweeps with peak detection to find the maximum of all emissions.

Final measurement:

- The final measurement will be performed with minimum the six highest peaks.
- According to the maximum antenna and turntable positions of premeasurement the software maximize the peaks by changing turntable position ($\pm 45^\circ$) and antenna movement between 1 and 4 meter. This procedure is repeated for both antenna polarizations.
- The final measurement will be done in the position (turntable, EUT-table and antenna polarization) causing the highest emissions with Peak and Average detector.
- The final levels, frequency, measuring time, bandwidth, turntable position, EUT-table position, antenna polarization, correction factor, margin to the limit and limit will be recorded. Also a plot with the graph of the premeasurement with marked maximum final measurements and the limit will be stored.

4) Sequence of testing above 18 GHz

Setup:

- The equipment was set up to simulate a typical usage like described in the user manual or described by manufacturer.
- If the EUT is a tabletop system, a rotatable table with 1.5 m height is used.
- If the EUT is a floor standing device, it is placed on the ground plane with insulation between both.
- Auxiliary equipment and cables were positioned to simulate normal operation conditions
- The AC power port of the EUT (if available) is connected to a power outlet below the turntable.
- The measurement distance is 1 meter.
- The EUT was set into operation.

Premeasurement:

- The antenna is moved spherical over the EUT in different polarisations of the antenna.

Final measurement:

- The final measurement will be performed at the position and antenna orientation for all detected emissions that were found during the premeasurements with Peak and Average detector.
- The final levels, frequency, measuring time, bandwidth, correction factor, margin to the limit and limit will be recorded. Also a plot with the graph of the premeasurement and the limit will be stored.

6.4 Test Setup Layout

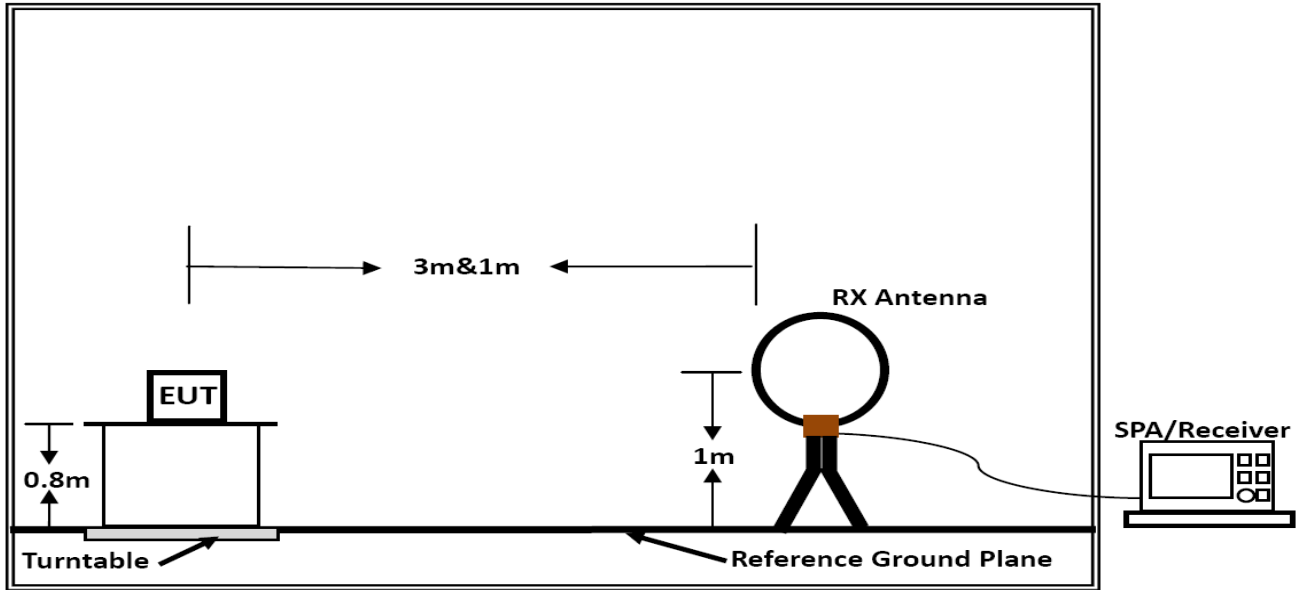

Below 30MHz

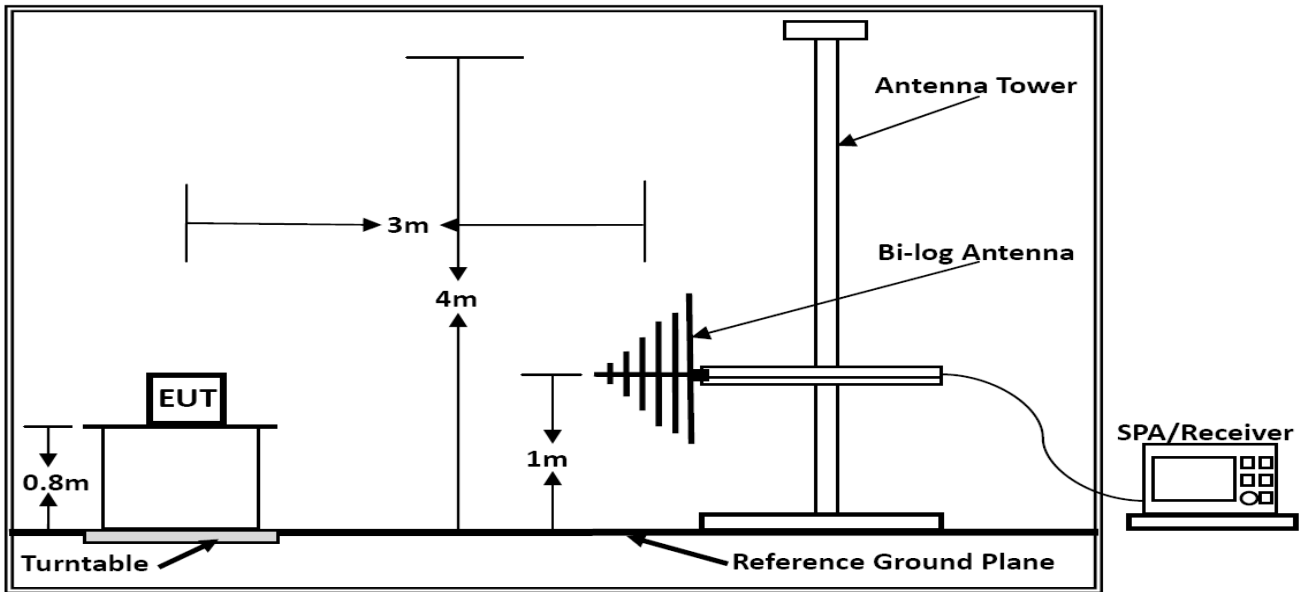

Below 1GHz

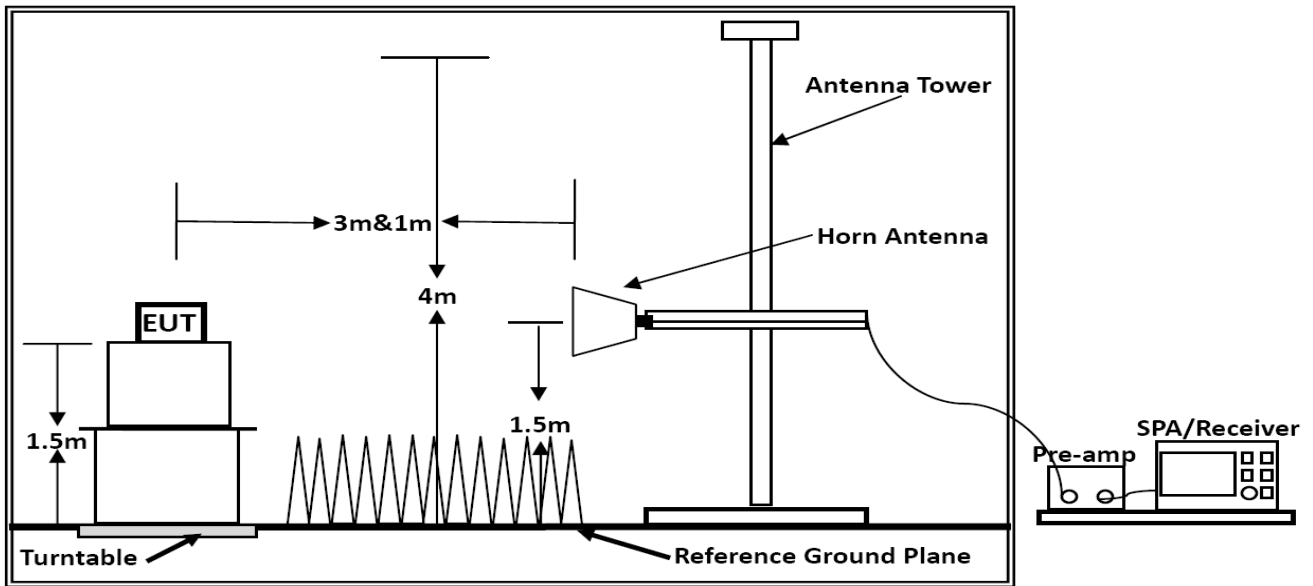

Above 1GHz

6.5 EUT Operation during Test

The EUT was programmed to be in continuously transmitting mode.

6.6 Results for Radiated Emissions

PASS.

Only record the worst test result in this report.

The radiated emissions from 9kHz to 30MHz are at least 20dB below the official limit and no need to report.

The test data please refer to following page:

Below 1GHz

Temperature	24°C	Humidity	56%
Test Engineer	Kyle Yin	Configurations	TX-Low Channel(1Mbps)

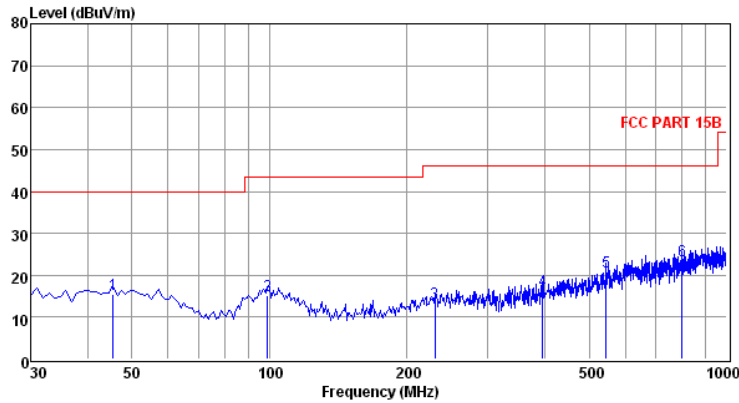

Env./Ins: 24°C/56%
 pol: VERTICAL

	Freq	Reading	CabLos	Antfac	Measured	Limit	Over	Remark
	MHz	dBuV	dB	dB/m	dBuV/m	dBuV/m	dB	
1	45.52	1.55	0.41	13.52	15.48	40.00	-24.52	QP
2	98.87	1.50	0.61	13.09	15.20	43.50	-28.30	QP
3	229.82	0.88	0.93	11.64	13.45	46.00	-32.55	QP
4	395.69	0.09	1.30	14.96	16.35	46.00	-29.65	QP
5	545.07	2.09	1.44	17.42	20.95	46.00	-25.05	QP
6	799.21	1.86	1.68	20.05	23.59	46.00	-22.41	QP

Note: 1. All readings are Quasi-peak values.
 2. Measured= Reading + Antenna Factor + Cable Loss
 3. The emission that are 20db below the official limit are not reported

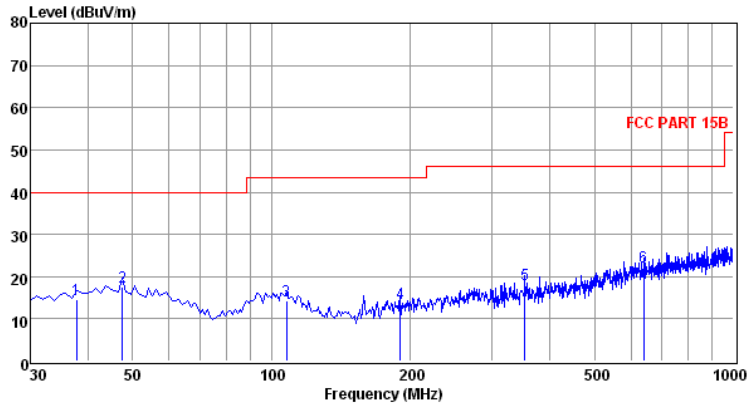

Env./Ins: 24°C/56%
 pol: HORIZONTAL

	Freq	Reading	CabLos	Antfac	Measured	Limit	Over	Remark
	MHz	dBuV	dB	dB/m	dBuV/m	dBuV/m	dB	
1	37.76	1.15	0.38	13.01	14.54	40.00	-25.46	QP
2	47.46	3.88	0.35	13.40	17.63	40.00	-22.37	QP
3	107.60	1.23	0.68	12.47	14.38	43.50	-29.12	QP
4	190.05	2.12	0.86	10.56	13.54	43.50	-29.96	QP
5	353.98	2.68	1.15	14.34	18.17	46.00	-27.83	QP
6	640.13	2.29	1.56	18.59	22.44	46.00	-23.56	QP

Note: 1. All readings are Quasi-peak values.
 2. Measured= Reading + Antenna Factor + Cable Loss
 3. The emission that are 20db below the official limit are not reported

***Note:

Pre-scan all mode and recorded the worst case results in this report (TX-Low Channel(1Mbps)).

Emission level (dBuV/m) = 20 log Emission level (uV/m).

Corrected Reading: Antenna Factor + Cable Loss + Read Level - Preamp Factor = Level.

Above 1GHz

The worst test result for GFSK, Tx-Low Channel:

Freq. MHz	Reading dBuV	Ant. Fac. dB/m	Pre. Fac. dB	Cab. Loss dB	Measured dBuV/m	Limit dBuV/m	Margin dB	Remark	Pol.
4804.19	44.51	33.06	35.04	3.94	46.47	74	-27.53	Peak	Horizontal
4804.19	34.34	33.06	35.04	3.94	36.30	54	-17.70	Average	Horizontal
4804.14	45.40	33.06	35.04	3.94	47.36	74	-26.64	Peak	Vertical
4804.20	35.10	33.06	35.04	3.94	37.06	54	-16.94	Average	Vertical

The worst test result for GFSK, Tx-Middle Channel:

Freq. MHz	Reading dBuV	Ant. Fac. dB/m	Pre. Fac. dB	Cab. Loss dB	Measured dBuV/m	Limit dBuV/m	Margin dB	Remark	Pol.
4882.21	45.89	33.16	35.15	3.96	47.86	74	-26.14	Peak	Horizontal
4882.20	35.78	33.16	35.15	3.96	37.75	54	-16.25	Average	Horizontal
4882.14	44.59	33.16	35.15	3.96	46.56	74	-27.44	Peak	Vertical
4882.24	36.17	33.16	35.15	3.96	38.14	54	-15.86	Average	Vertical

The worst test result for GFSK, Tx-High Channel:

Freq. MHz	Reading dBuV	Ant. Fac. dB/m	Pre. Fac. dB	Cab. Loss dB	Measured dBuV/m	Limit dBuV/m	Margin dB	Remark	Pol.
4960.31	42.95	33.26	35.14	3.98	45.05	74	-28.95	Peak	Horizontal
4960.38	34.04	33.26	35.14	3.98	36.14	54	-17.86	Average	Horizontal
4960.25	44.82	33.26	35.14	3.98	46.92	74	-27.08	Peak	Vertical
4960.36	35.96	33.26	35.14	3.98	38.06	54	-15.94	Average	Vertical

Notes:

1. Measuring frequencies from 9k~10th harmonic (ex. 26GHz), No emission found between lowest internal used/generated frequency to 30MHz.
2. Radiated emissions measured in frequency range from 9k~10th harmonic (ex. 26GHz) were made with an instrument using Peak detector mode.
3. 18~25GHz at least have 20dB margin. No recording in the test report.

6.7 Results for Band edge Testing (Radiated)

Note: Only recorded the worst test result.

Tx-2402, GFSK, Non-hopping

Freq. MHz	Reading Level dBuV	Ant. Fac. dB/m	Pre. Fac. dB	Cab. Loss dB	Measured dBuV/m	Limit dBuV/m	Margin dB	Remark	Pol.
2376.39	42.82	32.89	35.16	3.51	44.06	74	-29.94	Peak	Horizontal
2376.42	33.58	32.90	35.16	3.51	34.83	54	-19.17	Average	Horizontal
2389.97	47.02	32.92	35.16	3.54	48.32	74	-25.68	Peak	Horizontal
2389.92	38.75	32.92	35.16	3.54	40.05	54	-13.95	Average	Horizontal
2376.48	44.18	32.89	35.16	3.51	45.42	74	-28.58	Peak	Vertical
2376.42	33.76	32.90	35.16	3.51	35.01	54	-18.99	Average	Vertical
2389.94	44.58	32.92	35.16	3.54	45.88	74	-28.12	Peak	Vertical
2390.03	37.58	32.92	35.16	3.54	38.88	54	-15.12	Average	Vertical

Tx-2480, GFSK, Non-hopping

Freq. MHz	Reading Level dBuV	Ant. Fac. dB/m	Pre. Fac. dB	Cab. Loss dB	Measured dBuV/m	Limit dBuV/m	Margin dB	Remark	Pol.
2483.51	47.21	33.06	35.18	3.60	48.69	74	-25.31	Peak	Horizontal
2483.50	36.34	33.08	35.18	3.60	37.84	54	-16.16	Average	Horizontal
2488.74	44.68	33.08	35.18	3.62	46.20	74	-27.80	Peak	Horizontal
2488.76	34.54	33.08	35.18	3.62	36.06	54	-17.94	Average	Horizontal
2483.49	45.53	33.06	35.18	3.60	47.01	74	-26.99	Peak	Vertical
2483.58	37.48	33.08	35.18	3.60	38.98	54	-15.02	Average	Vertical
2488.74	45.31	33.08	35.18	3.62	46.83	74	-27.17	Peak	Vertical
2488.79	33.59	33.08	35.18	3.62	35.11	54	-18.89	Average	Vertical

7. LINE CONDUCTED EMISSIONS

7.1 Standard Applicable

According to §15.207 (a): For an intentional radiator which is designed to be connected to the public utility (AC) power line, the radio frequency voltage that is conducted back onto the AC power line on any frequency or frequencies within the band 150 kHz to 30 MHz shall not exceed 250 microvolt (The limit decreases linearly with the logarithm of the frequency in the range 0.15 MHz to 0.50 MHz). The limits at specific frequency range are listed as follows:

Frequency Range(MHz)	Limits (dB μ V)	
	Quasi-peak	Average
0.15 to 0.50	66 to 56	56 to 46
0.50 to 5	56	46
5 to 30	60	50

7.2 Block Diagram of Test Setup

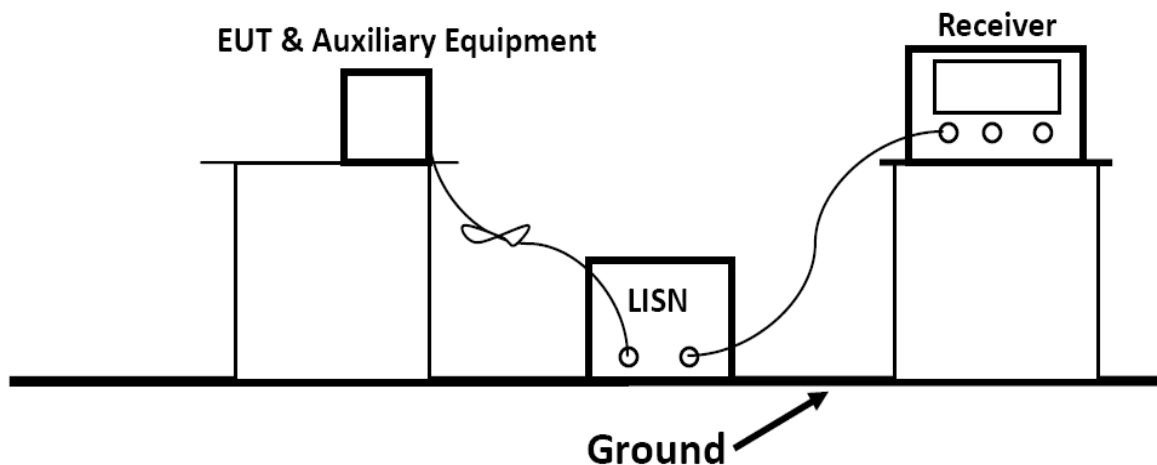

7.3 Test Results

PASS.

The test data please refer to following page.

Temperature	24°C	Humidity	56%
Test Engineer	Kyle Yin	Configurations	TX-Low Channel(1Mbps)

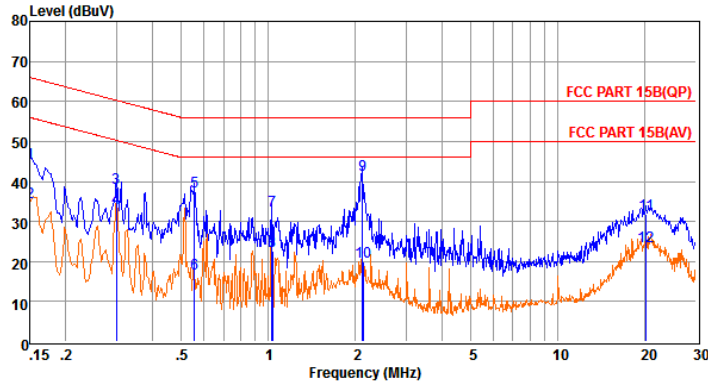

Env. Ins: 24*/56%
 Power Rating: AC 120V/60Hz
 Pol: NEUTRAL

Freq	Reading	LisnFac	CabLos	Atten_Fac	Measured	Limit	Over	Remark
MHz	dBuV	dB	dB	dB	dBuV	dBuV	dB	
1 0.15000	24.95	9.70	0.02	10.00	44.67	66.00	-21.33	QP
2 0.15010	14.98	9.70	0.02	10.00	34.70	55.99	-21.29	Average
3 0.29869	18.67	9.60	0.03	10.00	38.30	60.28	-21.98	QP
4 0.29879	13.59	9.60	0.03	10.00	33.22	50.28	-17.06	Average
5 0.55520	17.89	9.62	0.04	10.00	37.55	56.00	-18.45	QP
6 0.55530	-2.64	9.62	0.04	10.00	17.02	46.00	-28.98	Average
7 1.03197	13.04	9.63	0.05	10.00	32.72	56.00	-23.28	QP
8 1.03297	2.92	9.63	0.05	10.00	22.60	46.00	-23.40	Average
9 2.12132	21.82	9.63	0.05	10.00	41.50	56.00	-14.50	QP
10 2.12232	0.35	9.63	0.05	10.00	20.03	46.00	-25.97	Average
1120.16248	11.93	9.88	0.12	10.00	31.93	60.00	-28.07	QP
1220.16348	3.70	9.88	0.12	10.00	23.70	50.00	-26.30	Average

Remarks: 1. Measured = Reading + Lisn Factor +Cable Loss+Atten_Fac.
 2. The emission levels that are 20dB below the official limit are not reported.

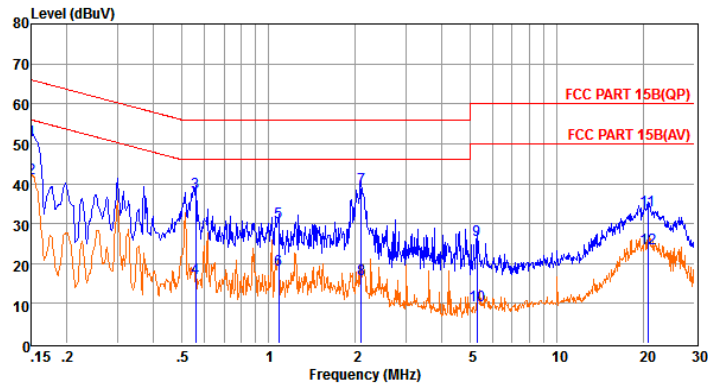

Env. Ins: 24*/56%
 Power Rating: AC 120V/60Hz
 Pol: LINE

Freq	Reading	LisnFac	CabLos	Atten_Fac	Measured	Limit	Over	Remark
MHz	dBuV	dB	dB	dB	dBuV	dBuV	dB	
1 0.15000	31.36	9.57	0.02	10.00	50.95	66.00	-15.05	QP
2 0.15010	21.62	9.57	0.02	10.00	41.21	55.99	-14.78	Average
3 0.55814	17.97	9.63	0.04	10.00	37.64	56.00	-18.36	QP
4 0.55824	-3.33	9.63	0.04	10.00	16.34	46.00	-29.66	Average
5 1.08237	10.63	9.63	0.05	10.00	30.31	56.00	-25.69	QP
6 1.08337	-1.24	9.63	0.05	10.00	18.44	46.00	-27.56	Average
7 2.09896	19.15	9.64	0.05	10.00	38.84	56.00	-17.16	QP
8 2.09996	-3.72	9.64	0.05	10.00	15.97	46.00	-30.03	Average
9 5.27696	6.04	9.65	0.06	10.00	25.75	60.00	-34.25	QP
10 5.27796	-10.21	9.65	0.06	10.00	9.50	50.00	-40.50	Average
1120.70376	13.53	9.74	0.12	10.00	33.39	60.00	-26.61	QP
1220.70476	3.88	9.74	0.12	10.00	23.74	50.00	-26.26	Average

Remarks: 1. Measured = Reading + Lisn Factor +Cable Loss+Atten_Fac.
 2. The emission levels that are 20dB below the official limit are not reported.

Note: Pre-scan all modes and recorded the worst case results in this report.

8. ANTENNA REQUIREMENT

8.1 Standard Applicable

According to antenna requirement of §15.203.

An intentional radiator shall be designed to ensure that no antenna other than that furnished by the responsible party shall be used with the device. The use of a permanently attached antenna or of an antenna that uses a unique coupling to the intentional radiator shall be considered sufficient to comply with the provisions of this Section. The manufacturer may design the unit so that a broken antenna can be re-placed by the user, but the use of a standard antenna jack or electrical connector is prohibited. This requirement does not apply to carrier current devices or to devices operated under the provisions of Sections 15.211, 15.213, 15.217, 15.219, or 15.221. Further, this requirement does not apply to intentional radiators that must be professionally installed, such as perimeter protection systems and some field disturbance sensors, or to other intentional radiators which, in accordance with Section 15.31(d), must be measured at the installation site. However, the installer shall be responsible for ensuring that the proper antenna is employed so that the limits in this Part are not exceeded.

And according to §15.247(4)(1), system operating in the 2400-2483.5MHz bands that are used exclusively for fixed, point-to-point operations may employ transmitting antennas with directional gain greater than 6dBi provided the maximum peak output power of the intentional radiator is reduced by 1 dB for every 3 dB that the directional gain of the antenna exceeds 6dBi.

8.2 Antenna Connected Construction

8.2.1. Standard Applicable

According to § 15.203 & RSS-Gen, an intentional radiator shall be designed to ensure that no antenna other than that furnished by the responsible party shall be used with the device.

8.2.2. Antenna Connector Construction

The directional gains of antenna used for transmitting is 1.84dBi, and the antenna is connected to PCB board and no consideration of replacement. Please see EUT photo for details.

8.2.3. Results: Compliance.

-----THE END OF REPORT-----