



RADIO TEST REPORT

Test Report No. : 10447653H-B-R1

Applicant : RICOH IMAGING COMPANY, LTD.
Type of Equipment : Wireless LAN Module
Model No. : P-W092
FCC ID : 2ACZS-WG30W01
Test regulation : FCC Part 15 Subpart C: 2014
Test Result : Complied

1. This test report shall not be reproduced in full or partial, without the written approval of UL Japan, Inc.
2. The results in this report apply only to the sample tested.
3. This sample tested is in compliance with the above regulation.
4. The test results in this report are traceable to the national or international standards.
5. This test report must not be used by the customer to claim product certification, approval, or endorsement by NVLAP, NIST, or any agency of the Federal Government.
6. This test report covers Radio technical requirements. It does not cover administrative issues such as Manual or non-Radio test related Requirements. (if applicable)
7. This report is a revised version of 10447653H-B. 10447653H-B is replaced with this report.

Date of test: September 19 to 22, 2012

Representative test engineer: T. Nakagawa
Tomohisa Nakagawa
Engineer
Consumer Technology Division

Approved by: Takayuki Shimada
Takayuki Shimada
Engineer
Consumer Technology Division



NVLAP LAB CODE: 200572-0

This laboratory is accredited by the NVLAP LAB CODE 200572-0, U.S.A. The tests reported herein have been performed in accordance with its terms of accreditation.
*As for the range of Accreditation in NVLAP, you may refer to the WEB address,
<http://www.ul.com/japan/jpn/pages/services/emc/about/mark1/index.jsp#nvlap>

UL Japan, Inc.

Ise EMC Lab.

4383-326 Asama-cho, Ise-shi, Mie-ken 516-0021 JAPAN

Telephone : +81 596 24 8999

Facsimile : +81 596 24 8124

REVISION HISTORY

Original Test Report No.: 10447653H-B

Revision	Test report No.	Date	Page revised	Contents
- (Original)	10447653H-B	October 29, 2014	-	-
1	10447653H-B-R1	November 17, 2014	P20	Deletion: Antenna gain of Average Output Power data

CONTENTS	PAGE
SECTION 1: Customer information.....	4
SECTION 2: Equipment under test (E.U.T.).....	4
SECTION 3: Test specification, procedures & results.....	5
SECTION 4: Operation of E.U.T. during testing.....	8
SECTION 5: Conducted Emission.....	10
SECTION 6: Radiated Spurious Emission	11
SECTION 7: Antenna Terminal Conducted Tests.....	12
APPENDIX 1: Data of EMI test.....	13
Conducted Emission	13
6dB Bandwidth	14
Maximum Peak Output Power	17
Average Output Power	20
Radiated Spurious Emission	21
Conducted Spurious Emission	28
Conducted Emission Band Edge compliance	46
Power Density	47
99% Occupied Bandwidth	51
APPENDIX 2: Test instruments	53
APPENDIX 3: Photographs of test setup	54
Conducted Emission	54
Radiated Spurious Emission	55
Worst Case Position (Horizontal: X-axis/ Vertical:Y-axis).....	56

SECTION 1: Customer information

Company Name : RICOH IMAGING COMPANY, LTD.
Address : 2-35-7, Maeno-cho, Itabashi-ku Tokyo Japan 174-8639
Telephone Number : +81-3-3960-5624
Facsimile Number : +81-3-3960-5704
Contact Person : Atsushi Sato

***Remarks:**

RICOH IMAGING COMPANY, LTD. designates MITSUMI ELECTRIC CO., LTD as manufacturer of the product (Wireless LAN Module).

SECTION 2: Equipment under test (E.U.T.)

2.1 Identification of E.U.T.

Type of Equipment : Wireless LAN Module
Model No. : P-W092
Serial No. : Refer to Section 4, Clause 4.2
Rating : DC 3.3V
Receipt Date of Sample : September 17, 2012
Country of Mass-production : Philippines
Condition of EUT : Production prototype
(Not for Sale: This sample is equivalent to mass-produced items.)
Modification of EUT : No Modification by the test lab

2.2 Product Description

General Specification

Clock frequency(ies) in the system : 26MHz

Radio Specification of WLAN (IEEE802.11b/g/n)

Radio Type : Transceiver
Frequency of Operation : 2412-2462MHz
Modulation : DSSS and OFDM
Power Supply (radio part input) : DC3.3V (Digital part), DC1.6V (RF Core), DC1.2V (Digital part)
Antenna type : 2.4GHz Pattern Antenna
Antenna Gain : 0.41dBi

UL Japan, Inc.

Ise EMC Lab.

4383-326 Asama-cho, Ise-shi, Mie-ken 516-0021 JAPAN

Telephone : +81 596 24 8999

Facsimile : +81 596 24 8124

SECTION 3: Test specification, procedures & results

3.1 Test Specification

Test Specification : FCC Part 15 Subpart C: 2014, final revised on August 15, 2014 and effective October 14, 2014

Title : FCC 47CFR Part15 Radio Frequency Device Subpart C Intentional Radiators Section 15.207 Conducted limits Section 15.247 Operation within the bands 902-928MHz, 2400-2483.5MHz, and 5725-5850MHz

* The revision on August 15, 2014 does not affect the test specification applied to the EUT.

3.2 Procedures and results

Item	Test Procedure	Specification	Worst margin	Results	Remarks
Conducted Emission	FCC: ANSI C63.4:2003 7. AC powerline Conducted Emission measurements ----- IC: RSS-Gen 7.2.4	FCC: Section 15.207 ----- IC: RSS-Gen 7.2.4	QP 29.6dB, 0.15000MHz, L AV 31.7dB, 0.15000MHz, N	Complied	-
6dB Bandwidth	FCC: "Guidance on Measurement of Digital Transmission Systems Operating under Section15.247" ----- IC: RSS-Gen 4.6.2	FCC: Section 15.247(a)(2) ----- IC: RSS-210 A8.2(a)	See data.	Complied	Conducted
Maximum Peak Output Power	FCC: "Guidance on Measurement of Digital Transmission Systems Operating under Section15.247" ----- IC: RSS-Gen 4.8	FCC: Section 15.247(b)(3) ----- IC: RSS-210 A8.4(4)		Complied	Conducted
Power Density	FCC: "Guidance on Measurement of Digital Transmission Systems Operating under Section15.247" ----- IC: -	FCC: Section 15.247 (e) ----- IC: RSS-210 A8.2(b)		Complied	Conducted
Spurious Emission Restricted Band Edges	FCC: "Guidance on Measurement of Digital Transmission Systems Operating under Section15.247" ----- IC: RSS-Gen 4.9	FCC: Section15.247(d) ----- IC: RSS-210 A8.5 RSS-Gen 7.2.3	0.5dB 2483.500MHz, Horizontal, AV	Complied	Conducted/ Radiated

Note: UL Japan, Inc.'s EMI Work Procedures No. 13-EM-W0420 and 13-EM-W0422.

* In case any questions arise about test procedure, ANSI C63.4: 2003 is also referred.

* This test report was confirmed to comply with the current technical requirements in KDB versions (KDB 558074 D01 v03r02 (June 5, 2014))

FCC 15.31 (e)

This EUT provides stable voltage (DC3.3V, DC1.6V, DC1.2V) constantly to RF Module regardless of input voltage. Therefore, this EUT complies with the requirement.

FCC Part 15.203/212Antenna requirement

It is impossible for end users to replace the antenna, because the antenna is mounted inside of the EUT. Therefore, the equipment complies with the antenna requirement of Section 15.203/212.

UL Japan, Inc.

Ise EMC Lab.

4383-326 Asama-cho, Ise-shi, Mie-ken 516-0021 JAPAN

Telephone : +81 596 24 8999

Facsimile : +81 596 24 8124

3.3 Addition to standard

Item	Test Procedure	Specification	Worst margin	Results	Remarks
99% Occupied Bandwidth	IC: RSS-Gen 4.6.1	IC: RSS-Gen 4.6.1	N/A	-	Conducted

Other than above, no addition, exclusion nor deviation has been made from the standard.

3.4 Uncertainty

EMI

The following uncertainties have been calculated to provide a confidence level of 95% using a coverage factor k=2.

Test room (semi-anechoic chamber)	Conducted emission (+dB)
	150kHz-30MHz
No.1	3.5dB
No.2	3.6dB
No.3	3.6dB
No.4	3.6dB

Test room (semi-anechoic chamber)	Radiated emission						
	(3m*)(+dB)				(1m*)(+dB)		(0.5m*)(+dB)
	9kHz -30MHz	30MHz -300MHz	300MHz -1GHz	1GHz -10GHz	10GHz -18GHz	18GHz -26.5GHz	26.5GHz -40GHz
No.1	4.3dB	5.0dB	5.1dB	4.9dB	5.8dB	4.4dB	4.3dB
No.2	4.3dB	5.2dB	5.1dB	5.0dB	5.7dB	4.3dB	4.2dB
No.3	4.6dB	5.0dB	5.1dB	5.0dB	5.7dB	4.5dB	4.2dB
No.4	4.8dB	5.2dB	5.0dB	5.0dB	5.7dB	5.2dB	4.2dB

*3m/1m/0.5m = Measurement distance

Power meter (+dB)	
Below 1GHz	Above 1GHz
1.0dB	1.0dB

Antenna terminal conducted emission and Power density (+dB)			Antenna terminal conducted emission (+dB)		Channel power (+dB)
Below 1GHz	1GHz-3GHz	3GHz-18GHz	18GHz-26.5GHz	26.5GHz-40GHz	
1.0dB	1.1dB	2.7dB	3.2dB	3.3dB	1.5dB

Conducted Emission test

The data listed in this test report has enough margin, more than the site margin.

Radiated emission test (3m)

The data listed in this report meets the limits unless the uncertainty is taken into consideration.

UL Japan, Inc.

Ise EMC Lab.

4383-326 Asama-cho, Ise-shi, Mie-ken 516-0021 JAPAN

Telephone : +81 596 24 8999

Facsimile : +81 596 24 8124

3.5 Test Location

UL Japan, Inc. Ise EMC Lab. *NVLAP Lab. code: 200572-0
 4383-326 Asama-cho, Ise-shi, Mie-ken 516-0021 JAPAN
 Telephone : +81 596 24 8999 Facsimile : +81 596 24 8124

	IC Registration Number	Width x Depth x Height (m)	Size of reference ground plane (m) / horizontal conducting plane	Other rooms
No.1 semi-anechoic chamber	2973C-1	19.2 x 11.2 x 7.7m	7.0 x 6.0m	No.1 Power source room
No.2 semi-anechoic chamber	2973C-2	7.5 x 5.8 x 5.2m	4.0 x 4.0m	-
No.3 semi-anechoic chamber	2973C-3	12.0 x 8.5 x 5.9m	6.8 x 5.75m	No.3 Preparation room
No.3 shielded room	-	4.0 x 6.0 x 2.7m	N/A	-
No.4 semi-anechoic chamber	2973C-4	12.0 x 8.5 x 5.9m	6.8 x 5.75m	No.4 Preparation room
No.4 shielded room	-	4.0 x 6.0 x 2.7m	N/A	-
No.5 semi-anechoic chamber	-	6.0 x 6.0 x 3.9m	6.0 x 6.0m	-
No.6 shielded room	-	4.0 x 4.5 x 2.7m	4.0 x 4.5 m	-
No.6 measurement room	-	4.75 x 5.4 x 3.0m	4.75 x 4.15 m	-
No.7 shielded room	-	4.7 x 7.5 x 2.7m	4.7 x 7.5m	-
No.8 measurement room	-	3.1 x 5.0 x 2.7m	N/A	-
No.9 measurement room	-	8.0 x 4.6 x 2.8m	2.4 x 2.4m	-
No.11 measurement room	-	6.2 x 4.7 x 3.0m	4.8 x 4.6m	-

* Size of vertical conducting plane (for Conducted Emission test) : 2.0 x 2.0m for No.1, No.2, No.3, and No.4 semi-anechoic chambers and No.3 and No.4 shielded rooms.

3.6 Data of EMI, Test instruments, and Test set up

Refer to APPENDIX.

SECTION 4: Operation of E.U.T. during testing

4.1 Operating Mode(s)

Test operating mode was determined as follows according to “Section 1 of 6 802.11 a/b/g/n testing- Managing Complex Regulatory Approvals - ” of TCB Council Workshop October 2009.

Mode	Remarks*
IEEE 802.11b (11b)	2Mbps, PN9
IEEE 802.11g (11g)	36Mbps, PN9
IEEE 802.11n SISO 20MHz BW (11n-20)	MCS 6 (Short GI), PN9
*The worst condition was determined based on the test result of Maximum Peak Output Power (Mid Channel)	
*Power of the EUT was set by the software as follows; Power settings: 11b/g: 14.5, 11n: 12.5 Software: Wi-Fi_GUI_TOOL (Release X86) Version: 1.0.0.0 *This setting of software is the worst case. Any conditions under the normal use do not exceed the condition of setting. In addition, end users cannot change the settings of the output power of the product.	

*The details of Operating mode(s)

Test Item	Operating Mode	Tested frequency
Conducted Emission	11n Tx	2412MHz *1)
6dB Bandwidth, Maximum Peak Output Power, Conducted Spurious Emission, Power Density, 99% Occupied Bandwidth	11b Tx 11g Tx 11n-20 Tx	2412MHz 2437MHz 2462MHz
Radiated Spurious Emission (Below 1GHz)	11n-20 Tx	2412MHz *1)
Radiated Spurious Emission (Above 1GHz)	11b Tx 11n-20 Tx *2)	2412MHz 2437MHz 2462MHz

*1) The mode was tested as a representative, because it had the highest power at antenna terminal test.

*2) Since 11g and 11n-20 have the same modulation method and no differences in transmitting specification, test was performed on the representative mode that had the highest peak output power.

UL Japan, Inc.

Ise EMC Lab.

4383-326 Asama-cho, Ise-shi, Mie-ken 516-0021 JAPAN

Telephone : +81 596 24 8999

Facsimile : +81 596 24 8124

4.2 Configuration and peripherals

<Conducted emission test>

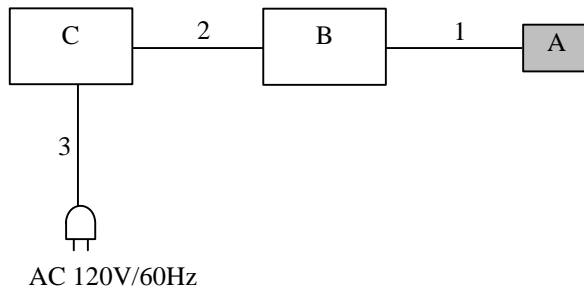

<Radiated emission test>

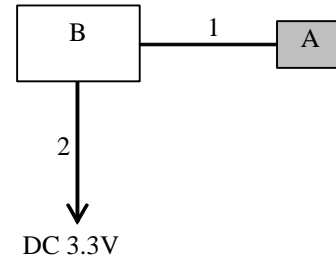

<Antenna conducted terminal test>

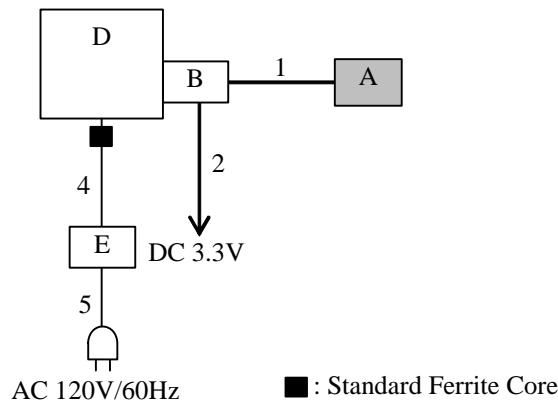

* Cabling and setup(s) were taken into consideration and test data was taken under worse case conditions.

Description of EUT and Support equipment

No.	Item	Model number	Serial number	Manufacturer	Remarks
A	Wireless LAN Module	P-W092	66	MITSUMI ELECTRIC CO., LTD	EUT
B	Jig	-	-	-	-
C	DC Power Supply	PW8-3ATP	09067054	KENWOOD TMI	-
D	Laptop PC	LATITUDEEE6510	CFGYZ A00	DELL	-
E	AC Adapter	LA90PE0-01	CN-03T6XF-71615-07J-0DEB-A01	DELL	-

List of cables used

No.	Name	Length (m)	Shield		Remarks
			Cable	Connector	
1	Signal Cable	0.07 ^{*1)} for RE* only 0.04 for other tests	Unshielded	Unshielded	-
2	DC Cable	2.6	Unshielded	Unshielded	-
3	AC Cable	2.2	Unshielded	Unshielded	-
4	DC Cable	1.8	Unshielded	Unshielded	-
5	AC Cable	1.0	Unshielded	Unshielded	-

*1) For practical use, the test was performed with conceivable maximum cable length.

*RE: Radiated Spurious Emission test

UL Japan, Inc.

Ise EMC Lab.

4383-326 Asama-cho, Ise-shi, Mie-ken 516-0021 JAPAN

Telephone : +81 596 24 8999

Facsimile : +81 596 24 8124

SECTION 5: Conducted Emission

Test Procedure and conditions

EUT was placed on a urethane platform of nominal size, 1.0m by 1.5m, raised 0.8m above the conducting ground plane. The rear of tabletop was located 40cm to the vertical conducting plane. The rear of EUT, including peripherals aligned and flushed with rear of tabletop. All other surfaces of tabletop were at least 80cm from any other grounded conducting surface. EUT was located 80cm from a Line Impedance Stabilization Network (LISN)/ Artificial mains Network (AMN) and excess AC cable was bundled in center.

For the tests on EUT with other peripherals (as a whole system)

I/O cables that were connected to the peripherals were bundled in center. They were folded back and forth forming a bundle 30cm to 40cm long and were hanged at a 40cm height to the ground plane. All unused 50ohm connectors of the LISN(AMN) were resistivity terminated in 50ohm when not connected to the measuring equipment.

The AC Mains Terminal Continuous disturbance Voltage has been measured with the EUT in a Semi Anechoic Chamber.

The EUT was connected to a LISN (AMN).

An overview sweep with peak detection has been performed.

The test results and limit are rounded off to one decimal place, so some differences might be observed.

Detector : QP and AV
Measurement range : 0.15-30MHz
Test data : APPENDIX
Test result : Pass

UL Japan, Inc.

Ise EMC Lab.

4383-326 Asama-cho, Ise-shi, Mie-ken 516-0021 JAPAN

Telephone : +81 596 24 8999

Facsimile : +81 596 24 8124

SECTION 6: Radiated Spurious Emission

Test Procedure

It was measured based on "2. Radiated emission test" of "Guidance on Measurement of Digital Transmission Systems Operating under Section 15.247 (issued on March 23, 2005)".

EUT was placed on a urethane platform of nominal size, 0.5m by 1.0m, raised 0.8m above the conducting ground plane.

The Radiated Electric Field Strength has been measured in a Semi Anechoic Chamber with a ground plane.

The height of the measuring antenna varied between 1 and 4m and EUT was rotated a full revolution in order to obtain the maximum value of the electric field strength.

The measurements were performed for both vertical and horizontal antenna polarization with the Test Receiver, or the Spectrum Analyzer.

The measurements were made with the following detector function of the test receiver and the Spectrum analyzer (in linear mode).

The test was made with the detector (RBW/VBW) in the following table.

When using Spectrum analyzer, the test was made with adjusting span to zero by using peak hold.

Test Antennas are used as below;

Frequency	Below 30MHz	30MHz to 300MHz	300MHz to 1GHz	Above 1GHz
Antenna Type	Loop	Biconical	Logperiodic	Horn

In any 100kHz bandwidth outside the restricted band in which the spread spectrum intentional radiator is operating, the radio frequency power that is produced by the intentional radiator confirmed 20dB below that in the 100kHz bandwidth within the band that contains the highest level of the desired power, based on a radiated measurement.

20dBc was applied to the frequency over the limit of FCC 15.209 / Table 5 of RSS-Gen 7.2.5(IC) and outside the restricted band of FCC15.205 / Table 3 of RSS-Gen 7.2.2 (IC).

Frequency	Below 1GHz	Above 1GHz		20dBc
Instrument used	Test Receiver	Spectrum Analyzer		Spectrum Analyzer
Detector	QP	PK	AV	PK
IF Bandwidth	BW 120kHz	RBW: 1MHz VBW: 3MHz	Average Power Method: RBW: 1MHz VBW: 240Hz(11b)/ 6.2kHz(11n) *1)	RBW: 100kHz VBW: 300kHz
Test Distance	3m	3m (below 10GHz), 1m *2) (above 10GHz)		3m

*1) Used for the band edge of the carrier and the harmonics that can be measured. The VBW is based on the inverse of the Tx on time (see Appendix).

*2) Distance Factor: $20 \times \log(3.0\text{m}/1.0\text{m}) = 9.5\text{dB}$

- The carrier level and noise levels were confirmed at each position of X, Y and Z axes of EUT to see the position of maximum noise, and the test was made at the position that has the maximum noise.

The test results and limit are rounded off to one decimal place, so some differences might be observed.

Measurement range : 30M-26.5GHz
Test data : APPENDIX
Test result : Pass

UL Japan, Inc.

Ise EMC Lab.

4383-326 Asama-cho, Ise-shi, Mie-ken 516-0021 JAPAN

Telephone : +81 596 24 8999

Facsimile : +81 596 24 8124

SECTION 7: Antenna Terminal Conducted Tests

Test Procedure

The tests were made with below setting connected to the antenna port.

Test	Span	RBW	VBW	Sweep time	Detector	Trace	Instrument used
6dB Bandwidth	18MHz, 20MHz	100kHz	300kHz	Auto	Peak	Max Hold	Spectrum Analyzer
99% Occupied Bandwidth	Enough width to display 20dB Bandwidth	1 to 3% of Span	Three times of RBW	Auto	Peak	Max Hold	Spectrum Analyzer
Maximum Peak Output Power	-	-	-	Auto	Peak/ Average *4)	-	Power Meter (Sensor: 50MHz BW)
Peak Power Density	18MHz, 20MHz	30kHz	100kHz	600sec, 667sec	Peak	Max Hold	Spectrum Analyzer *1) *2)
Conducted Spurious Emission *3)	9kHz to 150kHz	200Hz	620Hz	Auto	Peak	Max Hold	Spectrum Analyzer
	150kHz to 30MHz	9.1kHz	27kHz				
	30MHz to 25GHz (Less or equal to 5GHz)	100kHz	300kHz				

*1) PSD Option 1 of "Guidance on Measurement of Digital Transmission Systems Operating under Section 15.247 (issued on March 23, 2005)".

This test report was confirmed to comply with the current technical requirements in KDB versions (KDB 558074 D01 v03r02 (June 5, 2014))

*2) The test was not performed at RBW:3kHz however the measurement is to be performed with RBW:3kHz in the regulation, because, the measurement value with RBW:3kHz is less than the value of RBW:30kHz and the test data met the limit with RBW:30kHz.

*3) In the frequency range below 30MHz, RBW was narrowed to separate the noise contents.

Then, wide-band noise near the limit was checked separately, however the noise was low enough as shown in the chart.(9kHz-150kHz:RBW=200Hz, 150kHz-30MHz:RBW=9.1kHz). Since the margin is more than about 50dB, the EUT complies with the limit of FCC15.209 if the measurement is performed with RBW=100kHz.

*4) Reference data

The test results and limit are rounded off to two decimals place, so some differences might be observed.

Test data : APPENDIX
Test result : Pass

UL Japan, Inc.

Ise EMC Lab.

4383-326 Asama-cho, Ise-shi, Mie-ken 516-0021 JAPAN

Telephone : +81 596 24 8999

Facsimile : +81 596 24 8124

APPENDIX 1: Data of EMI test

Conducted Emission

DATA OF CONDUCTED EMISSION TEST

UL Japan, Inc. Ise EMC Lab. No.4 Semi Anechoic Chamber
Date : 2012/09/22

Report No. : 10447653H
 Power : AC 120V / 60Hz
 Temp./Humi. : 23deg. C / 52% RH
 Engineer : Kazuya Yoshioka

Mode / Remarks : Tx 11n 2412MHz MCS6

LIMIT : FCC15.207 QP
 FCC15.207 AV

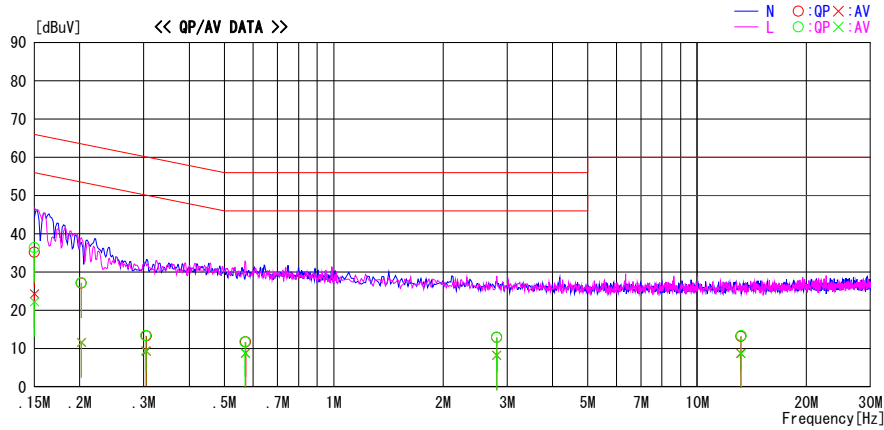

Frequency [MHz]	Reading Level		Corr. Factor	Results		Limit		Margin		Phase	Comment
	QP [dBuV]	AV [dBuV]		QP [dBuV]	AV [dBuV]	QP [dBuV]	AV [dBuV]	QP [dB]	AV [dB]		
0.15000	21.9	11.0	13.3	35.2	24.3	66.0	56.0	30.8	31.7	N	
0.20220	13.8	-1.7	13.3	27.1	11.6	63.5	53.5	36.4	41.9	N	
0.30515	-0.1	-4.1	13.4	13.3	9.3	60.1	50.1	46.8	40.8	N	
0.57195	-1.7	-4.6	13.4	11.7	8.8	56.0	46.0	44.3	37.2	N	
2.80912	-0.7	-5.4	13.6	12.9	8.2	56.0	46.0	43.1	37.8	N	
13.19142	-1.2	-5.6	14.4	13.2	8.8	60.0	50.0	46.8	41.2	N	
0.15000	23.1	8.9	13.3	36.4	22.2	66.0	56.0	29.6	33.8	L	
0.20220	13.9	-1.7	13.3	27.2	11.6	63.5	53.5	36.3	41.9	L	
0.30370	0.0	-4.0	13.4	13.4	9.4	60.1	50.1	46.7	40.7	L	
0.57050	-1.7	-4.6	13.4	11.7	8.8	56.0	46.0	44.3	37.2	L	
2.80912	-0.7	-5.4	13.6	12.9	8.2	56.0	46.0	43.1	37.8	L	
13.22484	-1.0	-5.7	14.4	13.4	8.7	60.0	50.0	46.6	41.3	L	

CHART: WITH FACTOR, Peak hold data. CALCULATION: RESULT=READING+C.F (LISN LOSS+ATT LOSS +CABLE LOSS)
 Except for the above table : adequate margin data below the limits.

6dB Bandwidth

Test place Ise EMC Lab. No.7 Shielded Room
Report No. 10447653H
Date 09/19/2012 09/20/2012
Temperature/ Humidity 20 deg. C / 48% RH 21 deg. C / 46% RH
Engineer Tomohisa Nakagawa Tomohisa Nakagawa
Mode Tx

11b

Frequency [MHz]	6dB Bandwidth [MHz]	Limit [kHz]
2412	8.250	>500
2437	9.590	>500
2462	9.387	>500

11g

Frequency [MHz]	6dB Bandwidth [MHz]	Limit [kHz]
2412	16.304	>500
2437	16.366	>500
2462	16.334	>500

11n-20

Frequency [MHz]	6dB Bandwidth [MHz]	Limit [kHz]
2412	17.564	>500
2437	17.566	>500
2462	17.582	>500

6dB Bandwidth

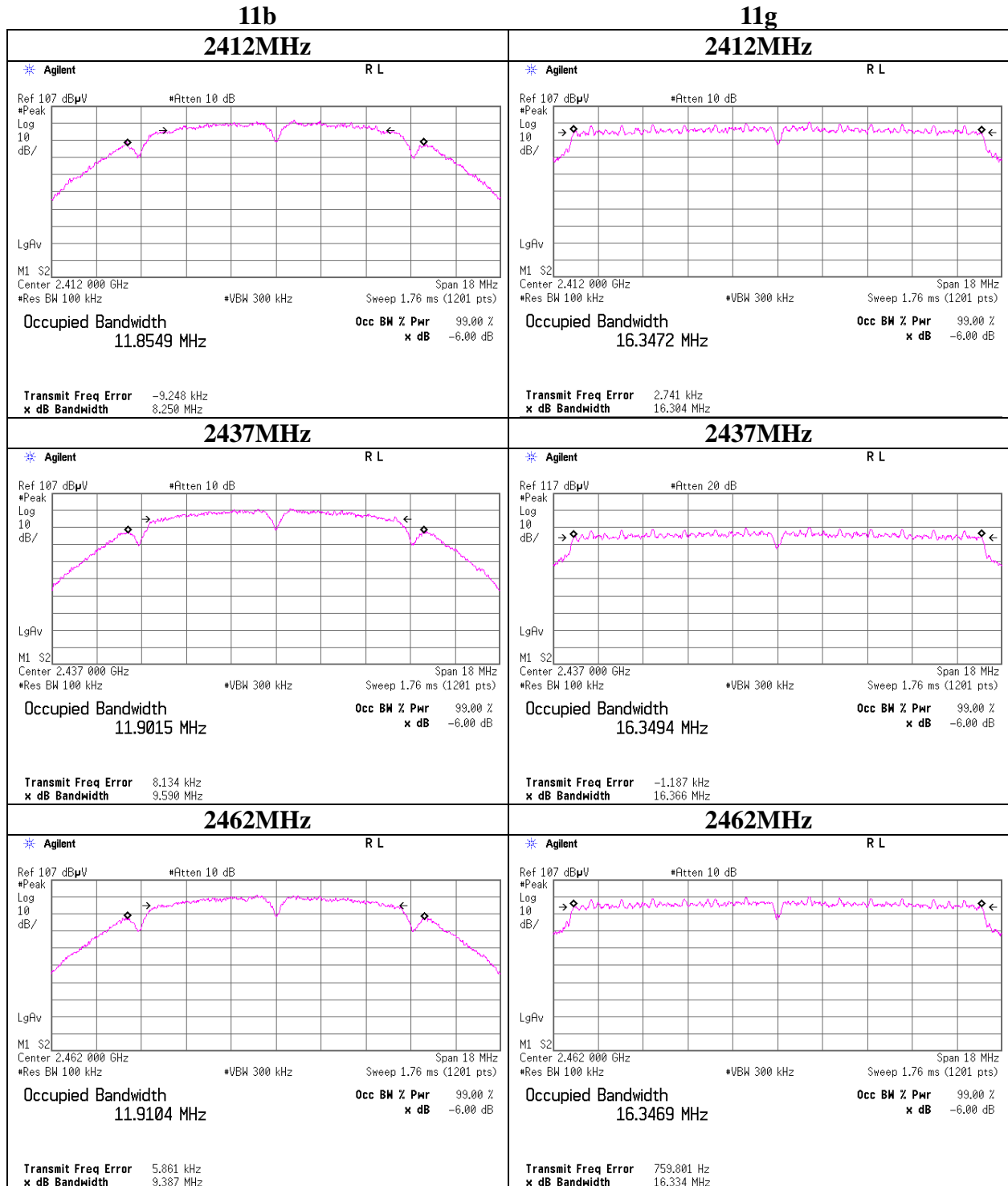

6dB Bandwidth

11n-20 Antenna

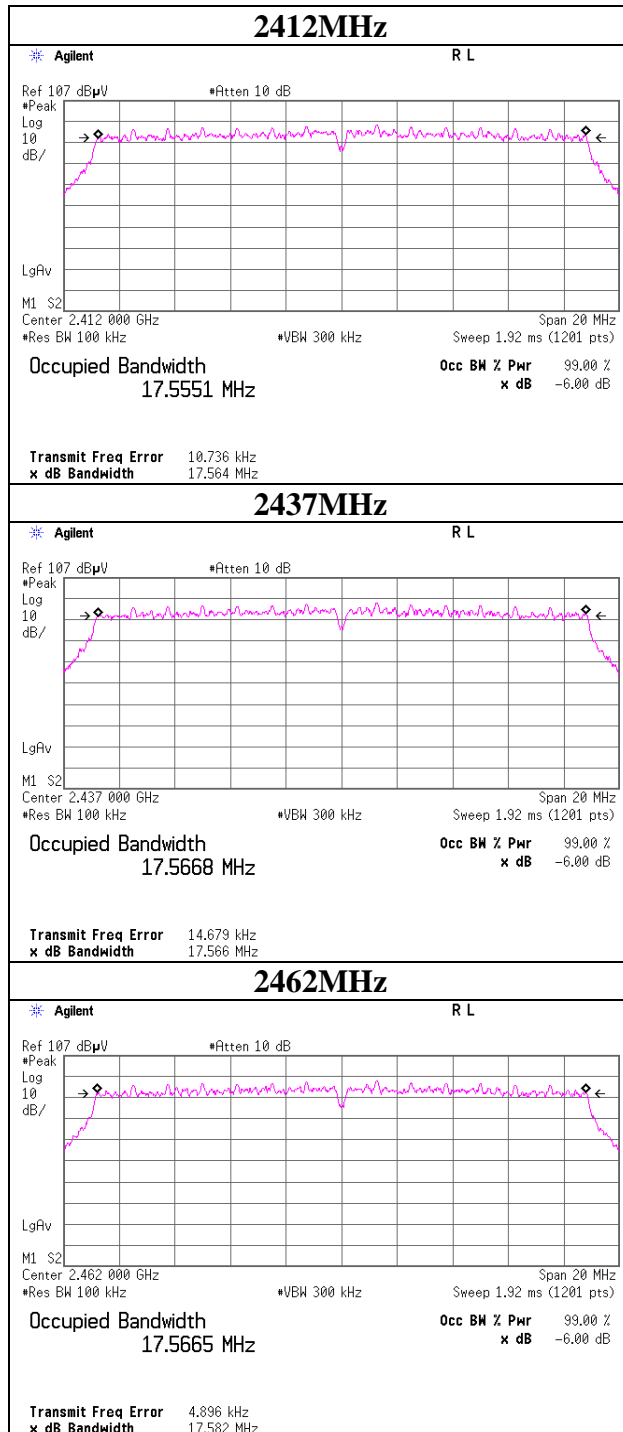

Maximum Peak Output Power

Test place	Ise EMC Lab. No.7 Shielded Room
Report No.	10447653H
Date	09/19/2012
Temperature/ Humidity	20 deg. C / 48% RH
Engineer	Tomohisa Nakagawa
Mode	11b Tx

Freq. [MHz]	Reading [dBm]	Cable Loss [dB]	Atten. [dB]	Result		Limit		Margin [dB]
				[dBm]	[mW]	[dBm]	[mW]	
2412	1.72	0.88	10.00	12.60	18.20	30.00	1000	17.40
2437	1.43	0.89	10.00	12.32	17.06	30.00	1000	17.68
2462	1.30	0.89	10.00	12.19	16.56	30.00	1000	17.81

Sample Calculation:

Result = Reading + Cable Loss (including the cable(s) customer supplied) + Attenuator

Antenna, 2437MHz

Rate [Mbps]	Reading [dBm]	Remark
1	1.40	
2	1.43	*
5.5	1.22	
11	1.23	

*: Worst Rate

All comparizon were carried out on same frequency and measurement factors.

Maximum Peak Output Power

Test place	Ise EMC Lab. No.7 Shielded Room
Report No.	10447653H
Date	09/19/2012
Temperature/ Humidity	20 deg. C / 48% RH
Engineer	Tomohisa Nakagawa
Mode	11g Tx

Freq. [MHz]	Reading [dBm]	Cable Loss [dB]	Atten. [dB]	Result		Limit		Margin [dB]
				[dBm]	[mW]	[dBm]	[mW]	
2412	8.01	0.88	10.00	18.89	77.45	30.00	1000	11.11
2437	7.69	0.89	10.00	18.58	72.11	30.00	1000	11.42
2462	7.34	0.89	10.00	18.23	66.53	30.00	1000	11.77

Sample Calculation:

Result = Reading + Cable Loss (including the cable(s) customer supplied) + Attenuator

Antenna, 2437MHz

Rate [Mbps]	Reading Long GI [dBm]
6	7.51
9	7.52
12	7.58
18	7.58
24	7.66
36	7.69*
48	7.60
54	7.62

*: Worst Rate

All comparison were carried out on same frequency and measurement factors.

UL Japan, Inc.

Ise EMC Lab.

4383-326 Asama-cho, Ise-shi, Mie-ken 516-0021 JAPAN

Telephone : +81 596 24 8999

Facsimile : +81 596 24 8124

Maximum Peak Output Power

Test place	Ise EMC Lab. No.7 Shielded Room
Report No.	10447653H
Date	09/19/2012
Temperature/ Humidity	20 deg. C / 48% RH
Engineer	Tomohisa Nakagawa
Mode	11n Tx

Freq. [MHz]	Reading [dBm]	Cable Loss [dB]	Atten. [dB]	Result		Limit		Margin [dB]
				[dBm]	[mW]	[dBm]	[mW]	
2412	8.71	0.88	10.00	19.59	90.99	30.00	1000	10.41
2437	8.05	0.89	10.00	18.94	78.34	30.00	1000	11.06
2462	7.56	0.89	10.00	18.45	69.98	30.00	1000	11.55

Sample Calculation:

Result = Reading + Cable Loss (including the cable(s) customer supplied) + Attenuator

Antenna, 2437MHz

MCS	Reading Short GI [dBm]	Reading Long GI [dBm]
0	7.86	/
1	7.90	
2	7.92	
3	7.97	
4	8.01	
5	8.01	
6	8.05*	7.70
7	8.00	

*: Worst Rate

All comparison were carried out on same frequency and measurement factors.

UL Japan, Inc.

Ise EMC Lab.

4383-326 Asama-cho, Ise-shi, Mie-ken 516-0021 JAPAN

Telephone : +81 596 24 8999

Facsimile : +81 596 24 8124

Average Output Power

Test place : Ise EMC Lab. No.7 Shielded Room
Report No. : 10447653H
Date : 09/19/2012
Temperature/ Humidity : 20 deg. C / 48% RH
Engineer : Tomohisa Nakagawa
Mode : 11b/g/n-20 Tx

[AV]

11b **2Mbps**

Freq. [MHz]	Reading [dBm]	Cable Loss [dB]	Atten. [dB]	Result		Limit		Margin [dB]
				[dBm]	[mW]	[dBm]	[mW]	
2412	0.14	0.88	10.00	11.02	12.65	30.00	1000	18.98
2437	-0.16	0.89	10.00	10.73	11.83	30.00	1000	19.27
2462	-0.14	0.89	10.00	10.75	11.89	30.00	1000	19.25

11g **36Mbps**

Freq. [MHz]	Reading [dBm]	Cable Loss [dB]	Atten. [dB]	Result		Limit		Margin [dB]
				[dBm]	[mW]	[dBm]	[mW]	
2412	-1.18	0.88	10.00	9.70	9.33	30.00	1000	20.30
2437	-1.38	0.89	10.00	9.51	8.93	30.00	1000	20.49
2462	-1.36	0.89	10.00	9.53	8.97	30.00	1000	20.47

11n-20 **MCS6**

Freq. [MHz]	Reading [dBm]	Cable Loss [dB]	Atten. [dB]	Result		Limit		Margin [dB]
				[dBm]	[mW]	[dBm]	[mW]	
2412	-3.05	0.88	10.00	7.83	6.07	30.00	1000	22.17
2437	-3.51	0.89	10.00	7.38	5.47	30.00	1000	22.62
2462	-3.41	0.89	10.00	7.48	5.60	30.00	1000	22.52

Sample Calculation:

Result = Reading + Cable Loss (including the cable(s) customer supplied) + Attenuator

UL Japan, Inc.

Ise EMC Lab.

4383-326 Asama-cho, Ise-shi, Mie-ken 516-0021 JAPAN

Telephone : +81 596 24 8999

Facsimile : +81 596 24 8124

Radiated Spurious Emission

Test place Ise EMC Lab. No.4 Semi Anechoic Chamber
Report No. 10447653H
Date 09/20/2012 09/21/2012
Temperature/ Humidity 23 deg. C / 52% RH 23 deg. C / 52% RH
Engineer Kazuya Yoshioka Kazuya Yoshioka
(1-10GHz) (10-26.5GHz)
Mode 11b Tx 2412MHz

Polarity	Frequency [MHz]	Detector	Reading [dBuV]	Ant.Fac. [dB/m]	Loss [dB]	Gain [dB]	Result [dBuV/m]	Limit [dBuV/m]	Margin [dB]	Remark
Hori	2390.000	PK	49.2	27.5	2.4	32.3	46.8	73.9	27.1	
Hori	4824.000	PK	43.0	31.4	4.3	31.5	47.2	73.9	26.7	
Hori	7236.000	PK	42.0	35.8	5.0	32.5	50.3	73.9	23.6	NS
Hori	9648.000	PK	44.4	38.3	5.8	32.9	55.6	73.9	18.3	NS
Hori	24120.000	PK	46.3	38.5	-1.1	32.1	51.6	73.9	22.3	NS
Hori	2390.000	AV	39.8	27.5	2.4	32.3	37.4	53.9	16.5	
Hori	4824.000	AV	35.9	31.4	4.3	31.5	40.1	53.9	13.8	
Hori	7236.000	AV	30.7	35.8	5.0	32.5	39.0	53.9	14.9	NS
Hori	9648.000	AV	32.5	38.3	5.8	32.9	43.7	53.9	10.2	NS
Hori	24120.000	AV	34.4	38.5	-1.1	32.1	39.7	53.9	14.2	NS
Vert	2390.000	PK	48.9	27.5	2.4	32.3	46.5	73.9	27.4	
Vert	4824.000	PK	43.1	31.4	4.3	31.5	47.3	73.9	26.6	
Vert	7236.000	PK	41.7	35.8	5.0	32.5	50.0	73.9	23.9	NS
Vert	9648.000	PK	44.6	38.3	5.8	32.9	55.8	73.9	18.1	NS
Vert	24120.000	PK	46.2	38.5	-1.1	32.1	51.5	73.9	22.4	NS
Vert	2390.000	AV	39.6	27.5	2.4	32.3	37.2	53.9	16.7	
Vert	4824.000	AV	32.8	31.4	4.3	31.5	37.0	53.9	16.9	
Vert	7236.000	AV	30.7	35.8	5.0	32.5	39.0	53.9	14.9	NS
Vert	9648.000	AV	32.5	38.3	5.8	32.9	43.7	53.9	10.2	NS
Vert	24120.000	AV	34.4	38.5	-1.1	32.1	39.7	53.9	14.2	NS

Result = Reading + Ant Factor + Loss (Cable+Attenuator+Filter-Distance factor(above 10GHz)) - Gain(Amplifier)

*Other frequency noises omitted in this report were not seen or had enough margin (more than 20dB).

NS:Non Signal

Distance factor: 10GHz-26.5GHz 20log(3.0m/1.0m)= 9.5dB
26.5GHz-40GHz 20log(3.0m/0.5m)=15.6dB

20dBc Data Sheet

Polarity	Frequency [MHz]	Detector	Reading [dBuV]	Ant Factor [dB/m]	Loss [dB]	Gain [dB]	Result [dBuV/m]	Limit [dBuV/m]	Margin [dB]	Remark
Hori	2412.000	PK	100.2	27.5	2.4	32.3	97.8	-	-	Carrier
Hori	2399.920	PK	46.7	27.5	2.4	32.3	44.3	77.8	33.5	
Hori	2400.000	PK	47.8	27.5	2.4	32.3	45.4	77.8	32.4	
Vert	2412.000	PK	101.6	27.5	2.4	32.3	99.2	-	-	Carrier
Vert	2399.920	PK	47.1	27.5	2.4	32.3	44.7	79.2	34.5	
Vert	2400.000	PK	47.3	27.5	2.4	32.3	44.9	79.2	34.3	

Result = Reading + Ant Factor + Loss (Cable+Attenuator+Filter-Distance factor(above 10GHz)) - Gain(Amplifier)

Radiated Spurious Emission

Test place Ise EMC Lab. No.4 Semi Anechoic Chamber
Report No. 10447653H
Date 09/20/2012 09/21/2012
Temperature/ Humidity 23 deg. C / 52% RH 23 deg. C / 52% RH
Engineer Kazuya Yoshioka Kazuya Yoshioka
(1-10GHz) (10-26.5GHz)
Mode 11b Tx 2437MHz

Polarity	Frequency [MHz]	Detector	Reading [dBuV]	Ant.Fac. [dB/m]	Loss [dB]	Gain [dB]	Result [dBuV/m]	Limit [dBuV/m]	Margin [dB]	Remark
Hori	4874.000	PK	43.2	31.5	4.3	31.5	47.5	73.9	26.4	
Hori	7311.000	PK	42.0	35.8	5.0	32.5	50.3	73.9	23.6	NS
Hori	9748.000	PK	44.0	38.4	5.9	32.9	55.4	73.9	18.5	NS
Hori	24370.000	PK	45.8	38.6	-1.1	32.1	51.2	73.9	22.7	NS
Hori	4874.000	AV	34.4	31.5	4.3	31.5	38.7	53.9	15.2	
Hori	7311.000	AV	30.4	35.8	5.0	32.5	38.7	53.9	15.2	NS
Hori	9748.000	AV	31.8	38.4	5.9	32.9	43.2	53.9	10.7	NS
Hori	24370.000	AV	34.9	38.6	-1.1	32.1	40.3	53.9	13.6	NS
Vert	4874.000	PK	41.9	31.5	4.3	31.5	46.2	73.9	27.7	
Vert	7311.000	PK	42.2	35.8	5.0	32.5	50.5	73.9	23.4	NS
Vert	9748.000	PK	44.2	38.4	5.9	32.9	55.6	73.9	18.3	NS
Vert	24370.000	PK	46.1	38.6	-1.1	32.1	51.5	73.9	22.4	NS
Vert	4874.000	AV	32.3	31.5	4.3	31.5	36.6	53.9	17.3	
Vert	7311.000	AV	30.4	35.8	5.0	32.5	38.7	53.9	15.2	NS
Vert	9748.000	AV	31.8	38.4	5.9	32.9	43.2	53.9	10.7	NS
Vert	24370.000	AV	34.9	38.6	-1.1	32.1	40.3	53.9	13.6	NS

Result = Reading + Ant Factor + Loss (Cable+Attenuator+Filter-Distance factor(above 10GHz)) - Gain(Amplifier)

*Other frequency noises omitted in this report were not seen or had enough margin (more than 20dB).

NS:Non Signal

Distance factor: 10GHz-26.5GHz $20\log(3.0m/1.0m)= 9.5dB$
26.5GHz-40GHz $20\log(3.0m/0.5m)=15.6dB$

Radiated Spurious Emission

Test place Ise EMC Lab. No.4 Semi Anechoic Chamber
Report No. 10447653H
Date 09/20/2012 09/21/2012
Temperature/ Humidity 23 deg. C / 52% RH 23 deg. C / 52% RH
Engineer Kazuya Yoshioka Kazuya Yoshioka
(1-10GHz) (10-26.5GHz)
Mode 11b Tx 2462MHz

Polarity	Frequency [MHz]	Detector	Reading [dBuV]	Ant.Fac. [dB/m]	Loss [dB]	Gain [dB]	Result [dBuV/m]	Limit [dBuV/m]	Margin [dB]	Remark
Hori	2483.500	PK	55.8	27.5	2.4	32.2	53.5	73.9	20.4	
Hori	4924.000	PK	44.1	31.7	4.3	31.5	48.6	73.9	25.3	
Hori	7386.000	PK	41.9	35.9	5.1	32.6	50.3	73.9	23.6	NS
Hori	9848.000	PK	43.0	38.5	5.9	33.0	54.4	73.9	19.5	NS
Hori	24620.000	PK	46.0	38.7	-1.0	32.2	51.5	73.9	22.4	NS
Hori	2483.500	AV	48.9	27.5	2.4	32.2	46.6	53.9	7.3	
Hori	4924.000	AV	34.2	31.7	4.3	31.5	38.7	53.9	15.2	
Hori	7386.000	AV	29.9	35.9	5.1	32.6	38.3	53.9	15.6	NS
Hori	9848.000	AV	32.0	38.5	5.9	33.0	43.4	53.9	10.5	NS
Hori	24620.000	AV	34.4	38.7	-1.0	32.2	39.9	53.9	14.0	NS
Vert	2483.500	PK	52.9	27.5	2.4	32.2	50.6	73.9	23.3	
Vert	4924.000	PK	43.3	31.7	4.3	31.5	47.8	73.9	26.1	
Vert	7386.000	PK	41.5	35.9	5.1	32.6	49.9	73.9	24.0	NS
Vert	9848.000	PK	43.0	38.5	5.9	33.0	54.4	73.9	19.5	NS
Vert	24620.000	PK	45.9	38.7	-1.0	32.2	51.4	73.9	22.5	NS
Vert	2483.500	AV	46.2	27.5	2.4	32.2	43.9	53.9	10.0	
Vert	4924.000	AV	33.0	31.7	4.3	31.5	37.5	53.9	16.4	
Vert	7386.000	AV	29.9	35.9	5.1	32.6	38.3	53.9	15.6	NS
Vert	9848.000	AV	32.0	38.5	5.9	33.0	43.4	53.9	10.5	NS
Vert	24620.000	AV	34.4	38.7	-1.0	32.2	39.9	53.9	14.0	NS

Result = Reading + Ant Factor + Loss (Cable+Attenuator+Filter-Distance factor(above 10GHz)) - Gain(Amplifier)

*Other frequency noises omitted in this report were not seen or had enough margin (more than 20dB).

NS:Non Signal

Distance factor: 10GHz-26.5GHz 20log(3.0m/1.0m)= 9.5dB
26.5GHz-40GHz 20log(3.0m/0.5m)=15.6dB

Radiated Spurious Emission

Test place Ise EMC Lab. No.4 Semi Anechoic Chamber
Report No. 10447653H
Date 09/20/2012 09/21/2012
Temperature/ Humidity 23 deg. C / 52% RH 23 deg. C / 52% RH
Engineer Kazuya Yoshioka Kazuya Yoshioka
(1-10GHz) (10-26.5GHz)/(Below 1GHz)
Mode 1In Tx 2412MHz

Polarity	Frequency [MHz]	Detector	Reading [dBuV]	Ant.Fac. [dB/m]	Loss [dB]	Gain [dB]	Result [dBuV/m]	Limit [dBuV/m]	Margin [dB]	Remark
Hori	39.900	QP	22.7	14.9	7.2	32.0	12.8	40.0	27.2	NS
Hori	96.150	QP	22.4	9.5	8.0	32.1	7.8	43.5	35.7	NS
Hori	145.650	QP	22.0	14.8	8.5	32.0	13.3	43.5	30.2	NS
Hori	200.999	QP	22.2	16.7	8.8	31.9	15.8	43.5	27.7	NS
Hori	421.332	QP	21.8	17.9	10.4	32.0	18.1	46.0	27.9	NS
Hori	603.333	QP	22.1	20.6	11.4	32.1	22.0	46.0	24.0	NS
Hori	2390.000	PK	67.5	27.5	2.4	32.3	65.1	73.9	8.8	
Hori	4824.000	PK	42.9	31.4	4.3	31.5	47.1	73.9	26.8	
Hori	7236.000	PK	42.2	35.8	5.0	32.5	50.5	73.9	23.4	NS
Hori	9648.000	PK	44.2	38.3	5.8	32.9	55.4	73.9	18.5	NS
Hori	24120.000	PK	46.0	38.5	-1.1	32.1	51.3	73.9	22.6	NS
Hori	2390.000	AV	50.1	27.5	2.4	32.3	47.7	53.9	6.2	
Hori	4824.000	AV	37.2	31.4	4.3	31.5	41.4	53.9	12.5	
Hori	7236.000	AV	30.7	35.8	5.0	32.5	39.0	53.9	14.9	NS
Hori	9648.000	AV	32.5	38.3	5.8	32.9	43.7	53.9	10.2	NS
Hori	24120.000	AV	34.4	38.5	-1.1	32.1	39.7	53.9	14.2	NS
Vert	41.250	QP	22.8	14.3	7.3	32.0	12.4	40.0	27.6	NS
Vert	96.600	QP	22.4	9.6	8.1	32.1	8.0	43.5	35.5	NS
Vert	146.100	QP	22.0	14.9	8.5	32.0	13.4	43.5	30.1	NS
Vert	200.549	QP	22.2	16.7	8.8	31.9	15.8	43.5	27.7	NS
Vert	420.166	QP	21.8	17.9	10.4	32.0	18.1	46.0	27.9	NS
Vert	608.000	QP	22.2	20.7	11.4	32.1	22.2	46.0	23.8	NS
Vert	2390.000	PK	66.2	27.5	2.4	32.3	63.8	73.9	10.1	
Vert	4824.000	PK	42.1	31.4	4.3	31.5	46.3	73.9	27.6	
Vert	7236.000	PK	41.6	35.8	5.0	32.5	49.9	73.9	24.0	NS
Vert	9648.000	PK	44.3	38.3	5.8	32.9	55.5	73.9	18.4	NS
Vert	24120.000	PK	46.4	38.5	-1.1	32.1	51.7	73.9	22.2	NS
Vert	2390.000	AV	47.2	27.5	2.4	32.3	44.8	53.9	9.1	
Vert	4824.000	AV	35.4	31.4	4.3	31.5	39.6	53.9	14.3	
Vert	7236.000	AV	30.7	35.8	5.0	32.5	39.0	53.9	14.9	NS
Vert	9648.000	AV	32.5	38.3	5.8	32.9	43.7	53.9	10.2	NS
Vert	24120.000	AV	34.4	38.5	-1.1	32.1	39.7	53.9	14.2	NS

Result = Reading + Ant Factor + Loss (Cable+Attenuator+Filter-Distance factor(above 10GHz)) - Gain(Amplifier)

*Other frequency noises omitted in this report were not seen or had enough margin (more than 20dB).

NS:Non Signal

Distance factor: 10GHz-26.5GHz 20log(3.0m/1.0m)= 9.5dB
26.5GHz-40GHz 20log(3.0m/0.5m)=15.6dB

20dBc Data Sheet

Polarity	Frequency [MHz]	Detector	Reading [dBuV]	Ant Factor [dB/m]	Loss [dB]	Gain [dB]	Result [dBuV/m]	Limit [dBuV/m]	Margin [dB]	Remark
Hori	2412.000	PK	98.0	27.5	2.4	32.3	95.6	-	-	Carrier
Hori	2398.250	PK	59.4	27.5	2.4	32.3	57.0	75.6	18.6	
Hori	2400.000	PK	55.7	27.5	2.4	32.3	53.3	75.6	22.3	
Vert	2412.000	PK	98.3	27.5	2.4	32.3	95.9	-	-	Carrier
Vert	2398.567	PK	58.1	27.5	2.4	32.3	55.7	75.9	20.2	
Vert	2400.000	PK	55.8	27.5	2.4	32.3	53.4	75.9	22.5	

Result = Reading + Ant Factor + Loss (Cable+Attenuator+Filter-Distance factor(above 10GHz)) - Gain(Amplifier)

UL Japan, Inc.

Ise EMC Lab.

4383-326 Asama-cho, Ise-shi, Mie-ken 516-0021 JAPAN

Telephone : +81 596 24 8999

Facsimile : +81 596 24 8124

Radiated Spurious Emission

Test place Ise EMC Lab. No.4 Semi Anechoic Chamber
Report No. 10447653H
Date 09/20/2012 09/21/2012
Temperature/ Humidity 23 deg. C / 52% RH 23 deg. C / 52% RH
Engineer Kazuya Yoshioka Kazuya Yoshioka
(1-10GHz) (10-26.5GHz)
Mode 11n Tx 2437MHz

Polarity	Frequency [MHz]	Detector	Reading [dBuV]	Ant.Fac. [dB/m]	Loss [dB]	Gain [dB]	Result [dBuV/m]	Limit [dBuV/m]	Margin [dB]	Remark
Hori	4874.000	PK	42.7	31.5	4.3	31.5	47.0	73.9	26.9	
Hori	7311.000	PK	41.9	35.8	5.0	32.5	50.2	73.9	23.7	NS
Hori	9748.000	PK	43.8	38.4	5.9	32.9	55.2	73.9	18.7	NS
Hori	24370.000	PK	46.2	38.6	-1.1	32.1	51.6	73.9	22.3	NS
Hori	4874.000	AV	36.9	31.5	4.3	31.5	41.2	53.9	12.7	
Hori	7311.000	AV	30.4	35.8	5.0	32.5	38.7	53.9	15.2	NS
Hori	9748.000	AV	31.8	38.4	5.9	32.9	43.2	53.9	10.7	NS
Hori	24370.000	AV	34.9	38.6	-1.1	32.1	40.3	53.9	13.6	NS
Vert	4874.000	PK	42.3	31.5	4.3	31.5	46.6	73.9	27.3	
Vert	7311.000	PK	42.4	35.8	5.0	32.5	50.7	73.9	23.2	NS
Vert	9748.000	PK	44.0	38.4	5.9	32.9	55.4	73.9	18.5	NS
Vert	24370.000	PK	46.0	38.6	-1.1	32.1	51.4	73.9	22.5	NS
Vert	4874.000	AV	34.8	31.5	4.3	31.5	39.1	53.9	14.8	
Vert	7311.000	AV	30.4	35.8	5.0	32.5	38.7	53.9	15.2	NS
Vert	9748.000	AV	31.8	38.4	5.9	32.9	43.2	53.9	10.7	NS
Vert	24370.000	AV	34.9	38.6	-1.1	32.1	40.3	53.9	13.6	NS

Result = Reading + Ant Factor + Loss (Cable+Attenuator+Filter-Distance factor(above 10GHz)) - Gain(Amplifier)

*Other frequency noises omitted in this report were not seen or had enough margin (more than 20dB).

NS:Non Signal

Distance factor: 10GHz-26.5GHz 20log(3.0m/1.0m)= 9.5dB
26.5GHz-40GHz 20log(3.0m/0.5m)=15.6dB

Radiated Spurious Emission

Test place : Ise EMC Lab. No.4 Semi Anechoic Chamber
Report No. : 10447653H
Date : 09/20/2012 09/21/2012
Temperature/ Humidity : 23 deg. C / 52% RH 23 deg. C / 52% RH
Engineer : Kazuya Yoshioka Kazuya Yoshioka
(1-10GHz) (10-26.5GHz)
Mode : 1In Tx 2462MHz

Polarity	Frequency [MHz]	Detector	Reading [dBuV]	Ant.Fac. [dB/m]	Loss [dB]	Gain [dB]	Result [dBuV/m]	Limit [dBuV/m]	Margin [dB]	Remark
Hori	2483.500	PK	71.2	27.5	2.4	32.2	68.9	73.9	5.0	
Hori	2488.586	PK	69.6	27.5	2.4	32.2	67.3	73.9	6.6	
Hori	4924.000	PK	43.2	31.7	4.3	31.5	47.7	73.9	26.2	
Hori	7386.000	PK	41.6	35.9	5.1	32.6	50.0	73.9	23.9	NS
Hori	9848.000	PK	43.3	38.5	5.9	33.0	54.7	73.9	19.2	NS
Hori	24620.000	PK	46.1	38.7	-1.0	32.2	51.6	73.9	22.3	NS
Hori	2483.500	AV	55.7	27.5	2.4	32.2	53.4	53.9	0.5	
Hori	2488.586	AV	52.8	27.5	2.4	32.2	50.5	53.9	3.4	
Hori	4924.000	AV	36.0	31.7	4.3	31.5	40.5	53.9	13.4	
Hori	7386.000	AV	29.9	35.9	5.1	32.6	38.3	53.9	15.6	NS
Hori	9848.000	AV	32.0	38.5	5.9	33.0	43.4	53.9	10.5	NS
Hori	24620.000	AV	34.4	38.7	-1.0	32.2	39.9	53.9	14.0	NS
Vert	2483.500	PK	68.3	27.5	2.4	32.2	66.0	73.9	7.9	
Vert	2488.586	PK	66.8	27.5	2.4	32.2	64.5	73.9	9.4	
Vert	4924.000	PK	41.4	31.7	4.3	31.5	45.9	73.9	28.0	
Vert	7386.000	PK	41.4	35.9	5.1	32.6	49.8	73.9	24.1	NS
Vert	9848.000	PK	43.4	38.5	5.9	33.0	54.8	73.9	19.1	NS
Vert	24620.000	PK	46.3	38.7	-1.0	32.2	51.8	73.9	22.1	NS
Vert	2483.500	AV	52.9	27.5	2.4	32.2	50.6	53.9	3.3	
Vert	2488.586	AV	50.0	27.5	2.4	32.2	47.7	53.9	6.2	
Vert	4924.000	AV	34.0	31.7	4.3	31.5	38.5	53.9	15.4	
Vert	7386.000	AV	29.9	35.9	5.1	32.6	38.3	53.9	15.6	NS
Vert	9848.000	AV	32.0	38.5	5.9	33.0	43.4	53.9	10.5	NS
Vert	24620.000	AV	34.4	38.7	-1.0	32.2	39.9	53.9	14.0	NS

Result = Reading + Ant Factor + Loss (Cable+Attenuator+Filter-Distance factor(above 10GHz)) - Gain(Amplifier)

*Other frequency noises omitted in this report were not seen or had enough margin (more than 20dB).

NS:Non Signal

Distance factor: 10GHz-26.5GHz 20log(3.0m/1.0m)= 9.5dB

26.5GHz-40GHz 20log(3.0m/0.5m)=15.6dB

Burst rate confirmation

Test place : Ise EMC Lab. No.7 Shielded Room
 Report No. : 10447653H
 Date : 09/19/2012 09/20/2012
 Temperature/ Humidity : 20 deg. C / 48% RH 21 deg. C / 46% RH
 Engineer : Tomohisa Nakagawa Tomohisa Nakagawa
 Mode : Tx

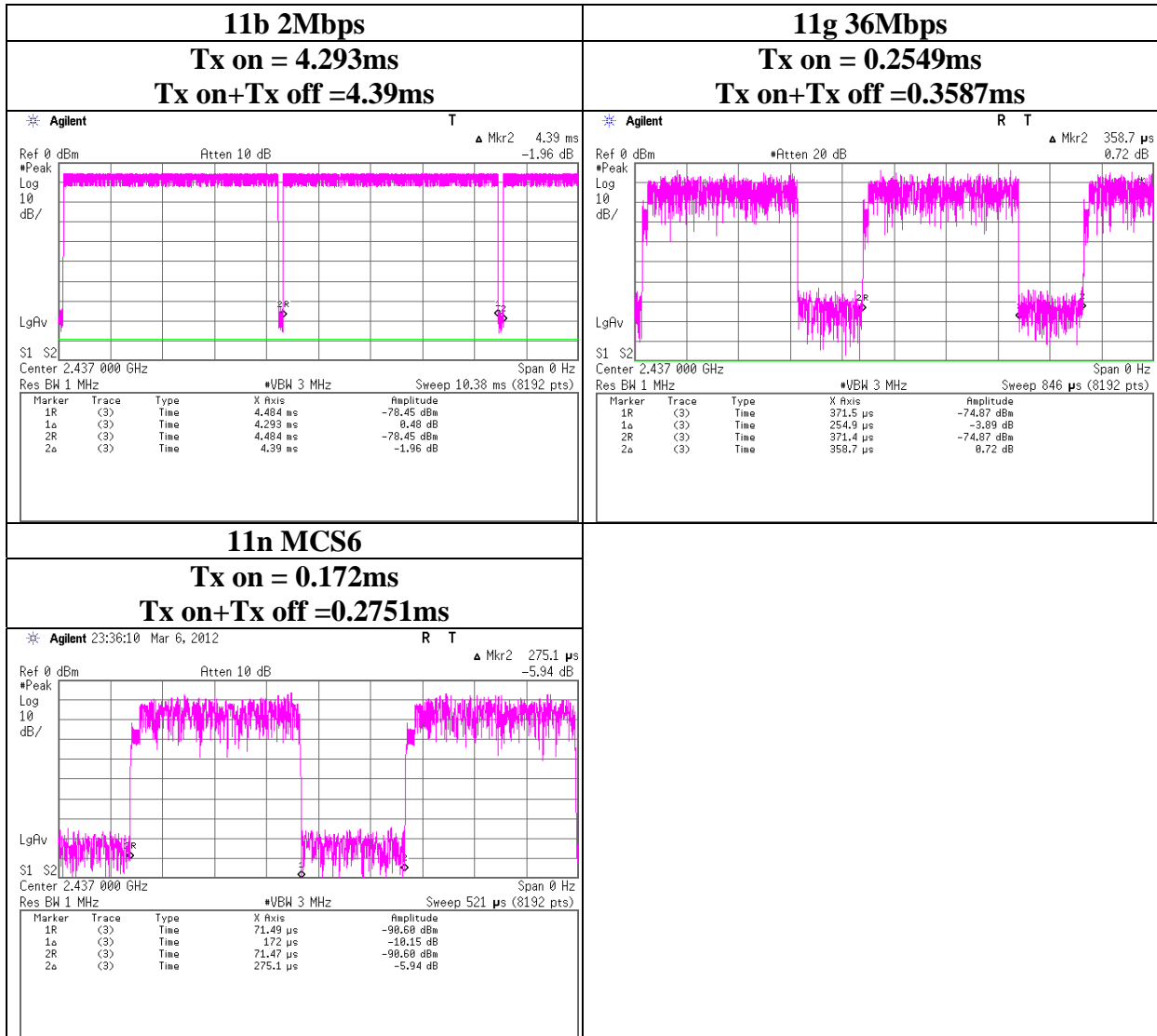

Conducted Spurious Emission

Test place	Ise EMC Lab. No.7 Shielded Room	
Report No.	10447653H	
Date	09/19/2012	09/20/2012
Temperature/ Humidity	20 deg. C / 48% RH	21 deg. C / 46% RH
Engineer	Tomohisa Nakagawa	Tomohisa Nakagawa
Mode	Tx	

11b Tx 2412MHz

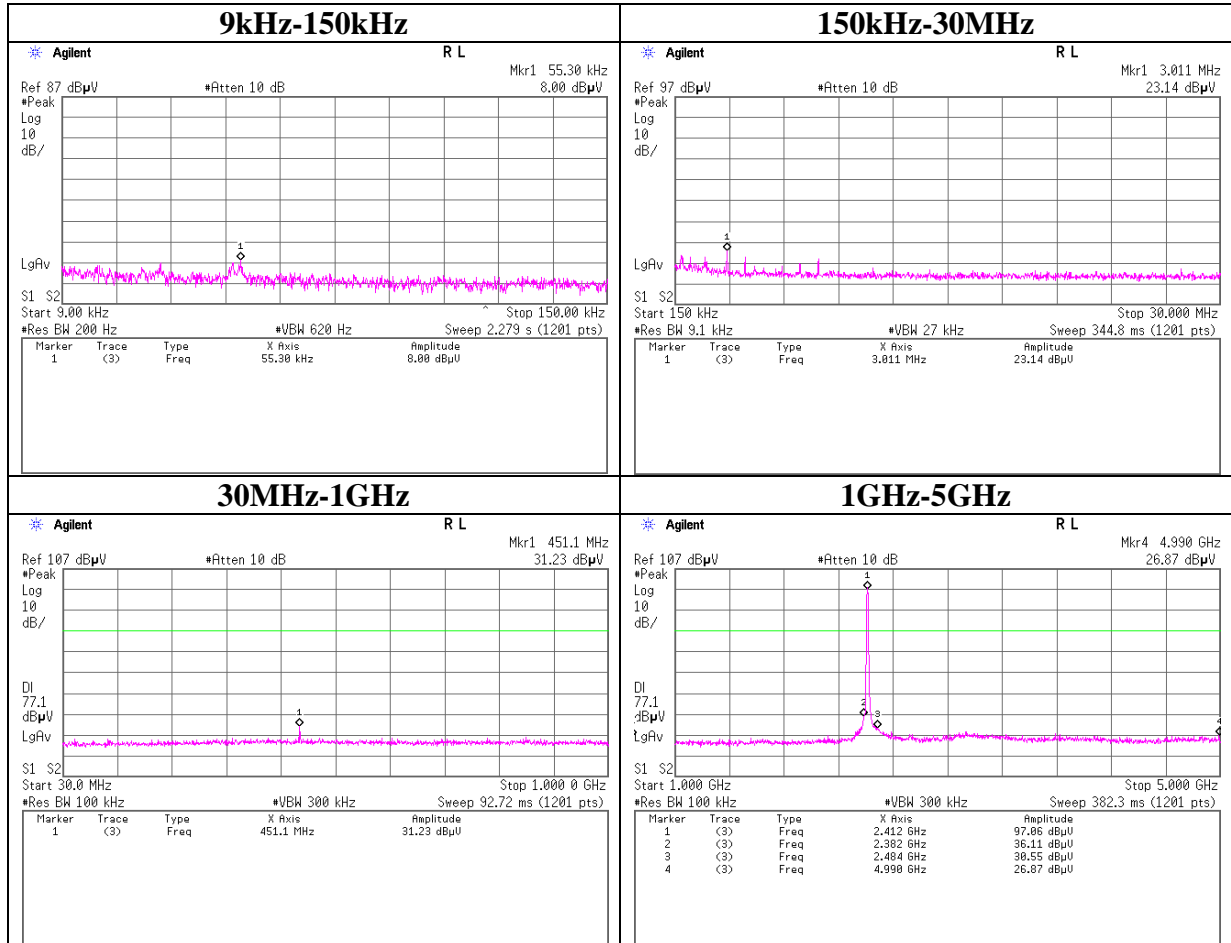

Conducted Spurious Emission

Test place	Ise EMC Lab. No.7 Shielded Room	
Report No.	10447653H	
Date	09/19/2012	09/20/2012
Temperature/ Humidity	20 deg. C / 48% RH	21 deg. C / 46% RH
Engineer	Tomohisa Nakagawa	Tomohisa Nakagawa
Mode	Tx	

11b Tx 2412MHz

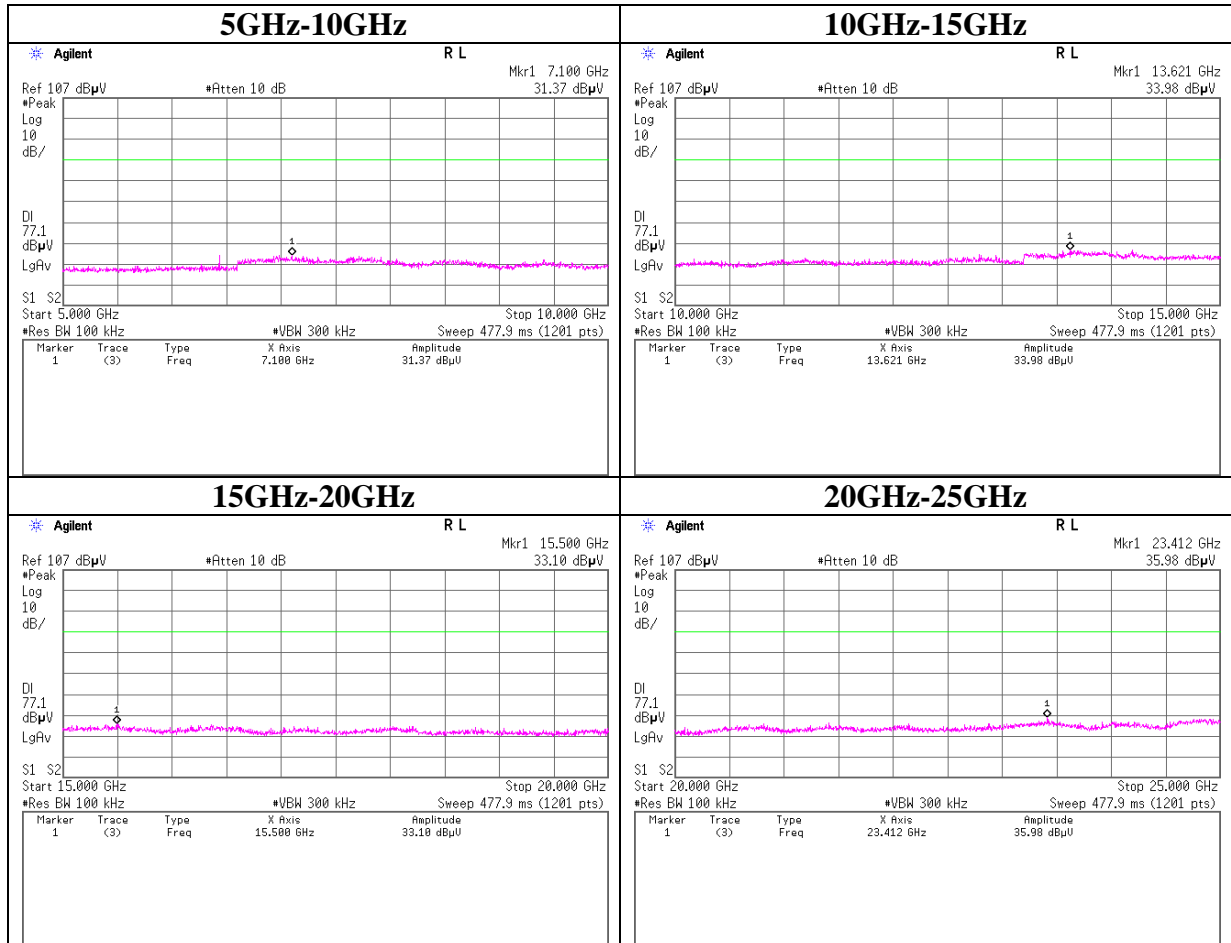

Conducted Spurious Emission

Test place	Ise EMC Lab. No.7 Shielded Room	
Report No.	10447653H	
Date	09/19/2012	09/20/2012
Temperature/ Humidity	20 deg. C / 48% RH	21 deg. C / 46% RH
Engineer	Tomohisa Nakagawa	Tomohisa Nakagawa
Mode	Tx	

11b Tx 2437MHz

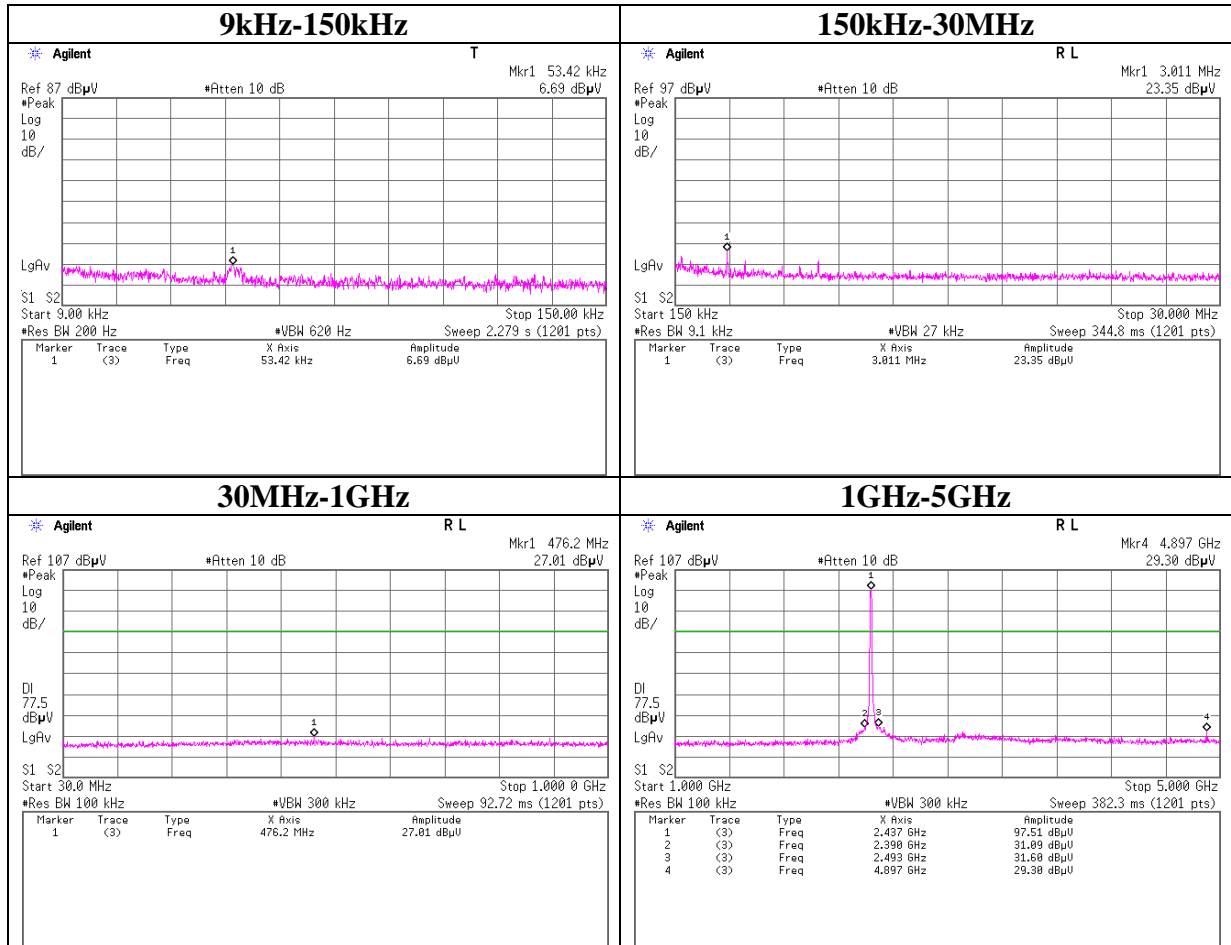

Conducted Spurious Emission

Test place	Ise EMC Lab. No.7 Shielded Room	
Report No.	10447653H	
Date	09/19/2012	09/20/2012
Temperature/ Humidity	20 deg. C / 48% RH	21 deg. C / 46% RH
Engineer	Tomohisa Nakagawa	Tomohisa Nakagawa
Mode	Tx	

11b Tx 2437MHz

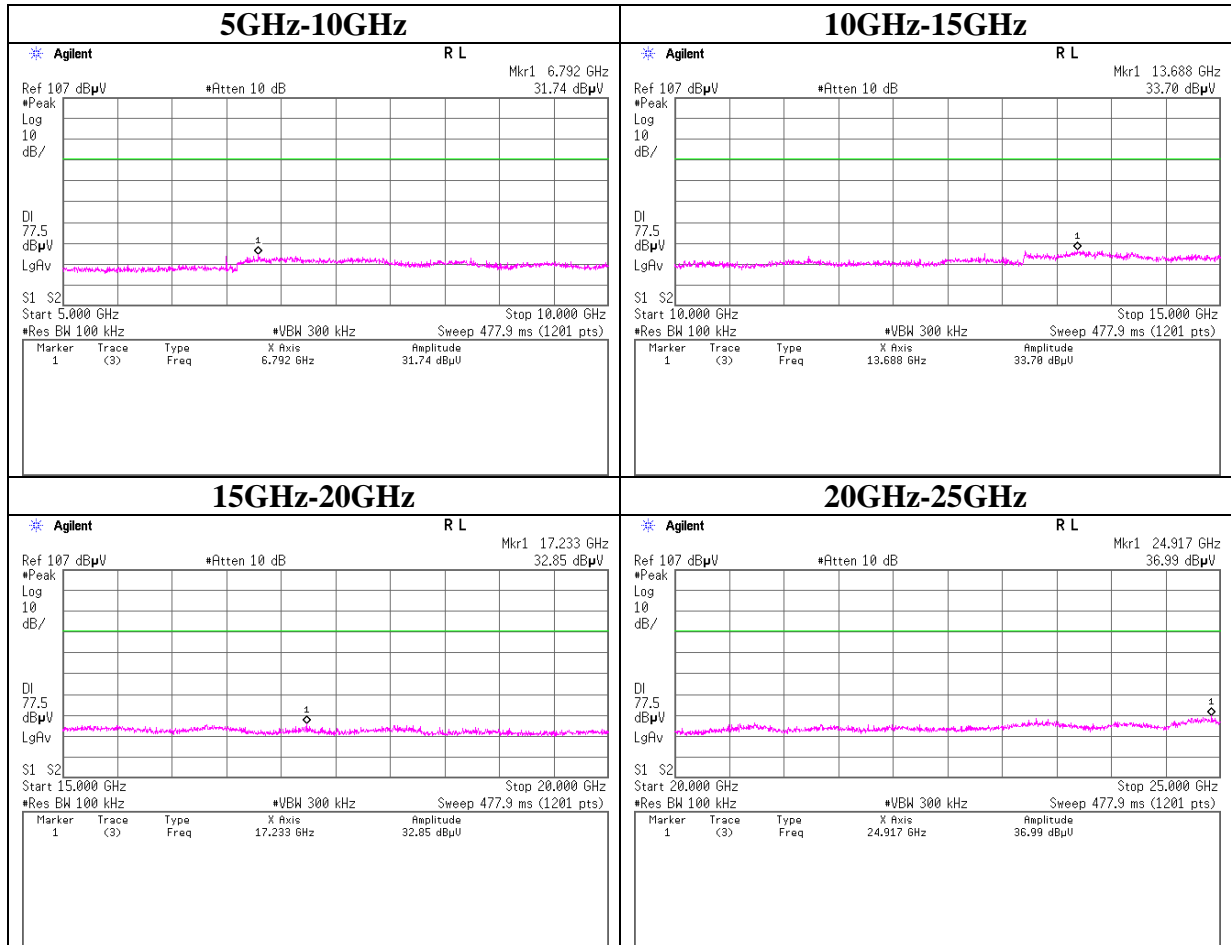

Conducted Spurious Emission

Test place	Ise EMC Lab. No.7 Shielded Room	
Report No.	10447653H	
Date	09/19/2012	09/20/2012
Temperature/ Humidity	20 deg. C / 48% RH	21 deg. C / 46% RH
Engineer	Tomohisa Nakagawa	Tomohisa Nakagawa
Mode	Tx	

11b Tx 2462MHz

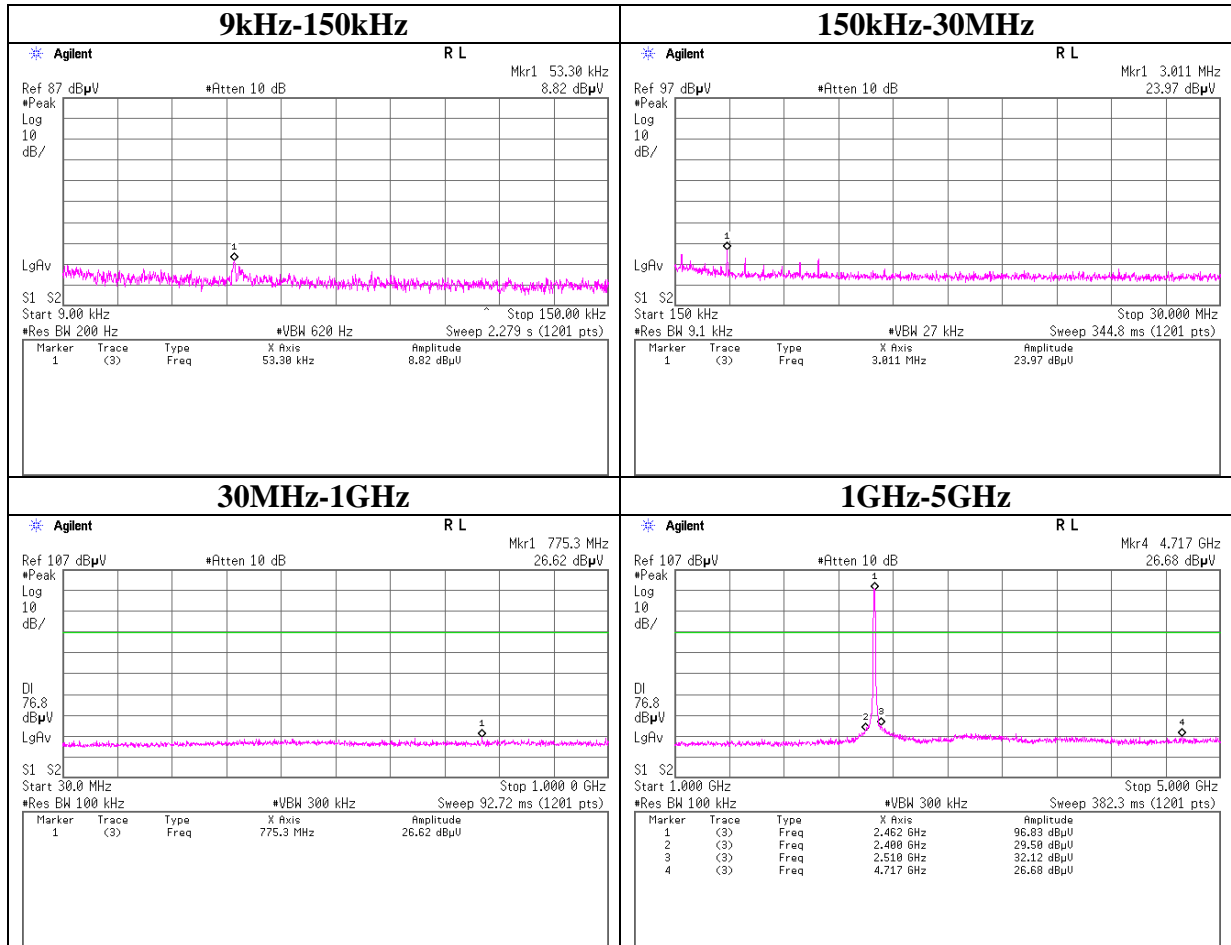

Conducted Spurious Emission

Test place	Ise EMC Lab. No.7 Shielded Room	
Report No.	10447653H	
Date	09/19/2012	09/20/2012
Temperature/ Humidity	20 deg. C / 48% RH	21 deg. C / 46% RH
Engineer	Tomohisa Nakagawa	Tomohisa Nakagawa
Mode	Tx	

11b Tx 2462MHz

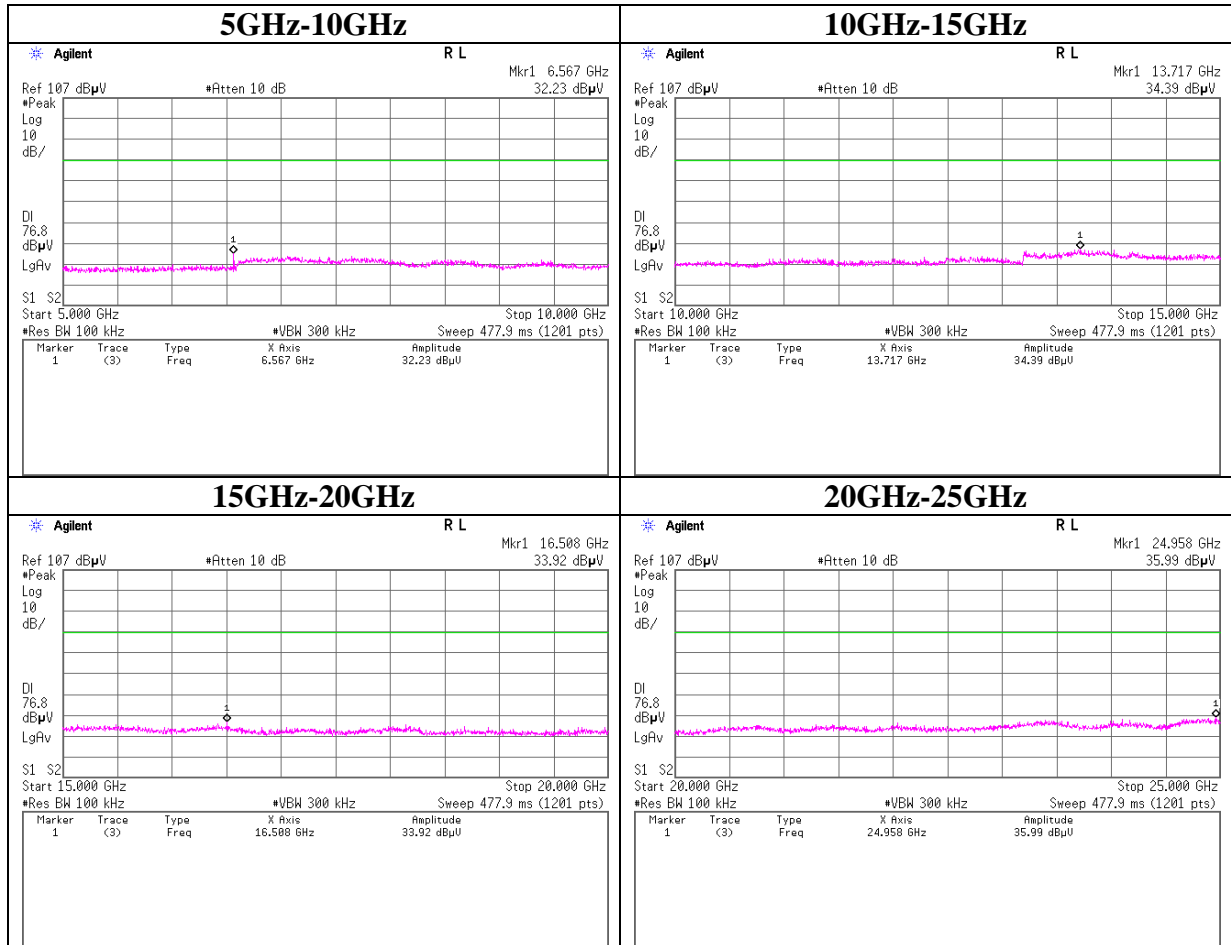

Conducted Spurious Emission

Test place	Ise EMC Lab. No.7 Shielded Room	
Report No.	10447653H	
Date	09/19/2012	09/20/2012
Temperature/ Humidity	20 deg. C / 48% RH	21 deg. C / 46% RH
Engineer	Tomohisa Nakagawa	Tomohisa Nakagawa
Mode	Tx	

11g Tx 2412MHz

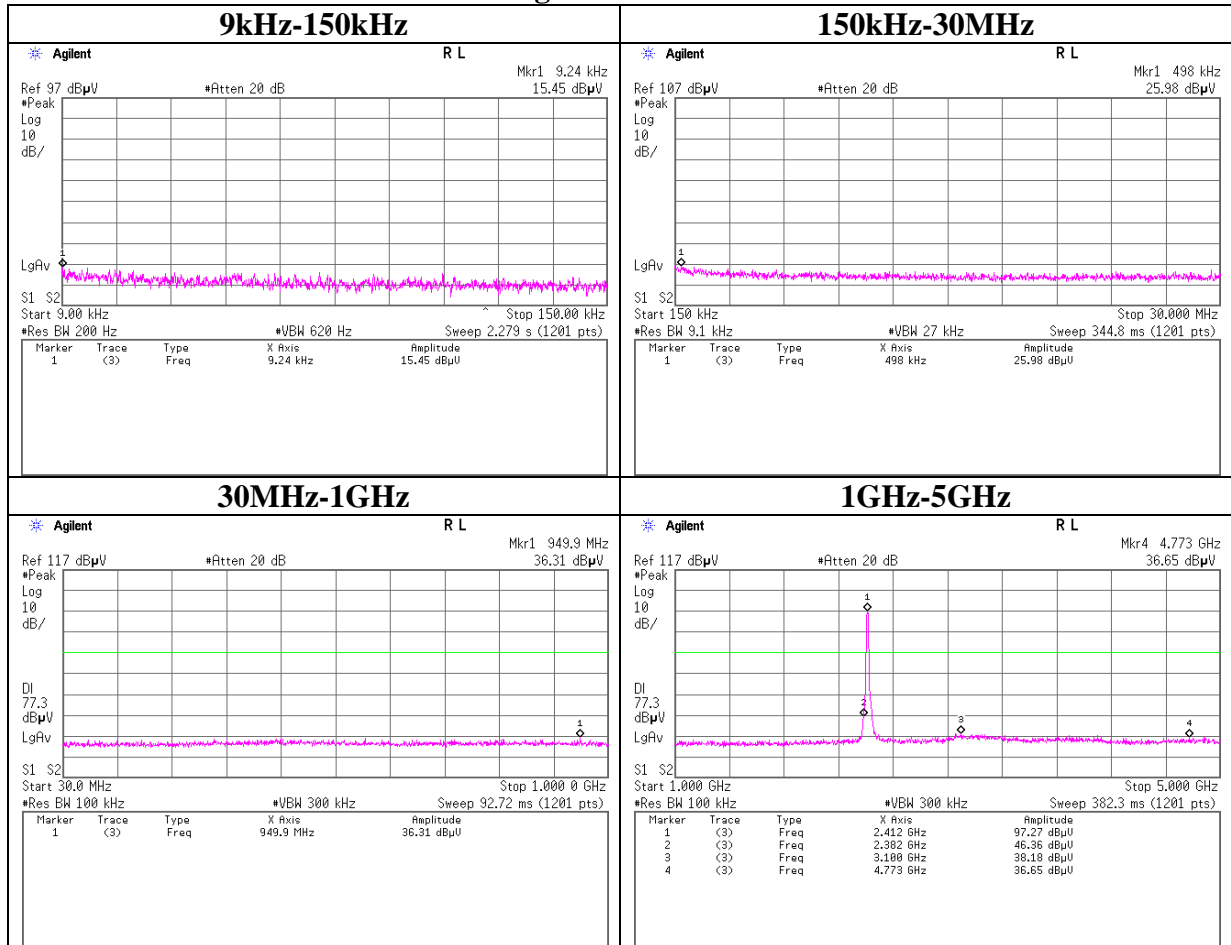

Conducted Spurious Emission

Test place	Ise EMC Lab. No.7 Shielded Room	
Report No.	10447653H	
Date	09/19/2012	09/20/2012
Temperature/ Humidity	20 deg. C / 48% RH	21 deg. C / 46% RH
Engineer	Tomohisa Nakagawa	Tomohisa Nakagawa
Mode	Tx	

11g Tx 2412MHz

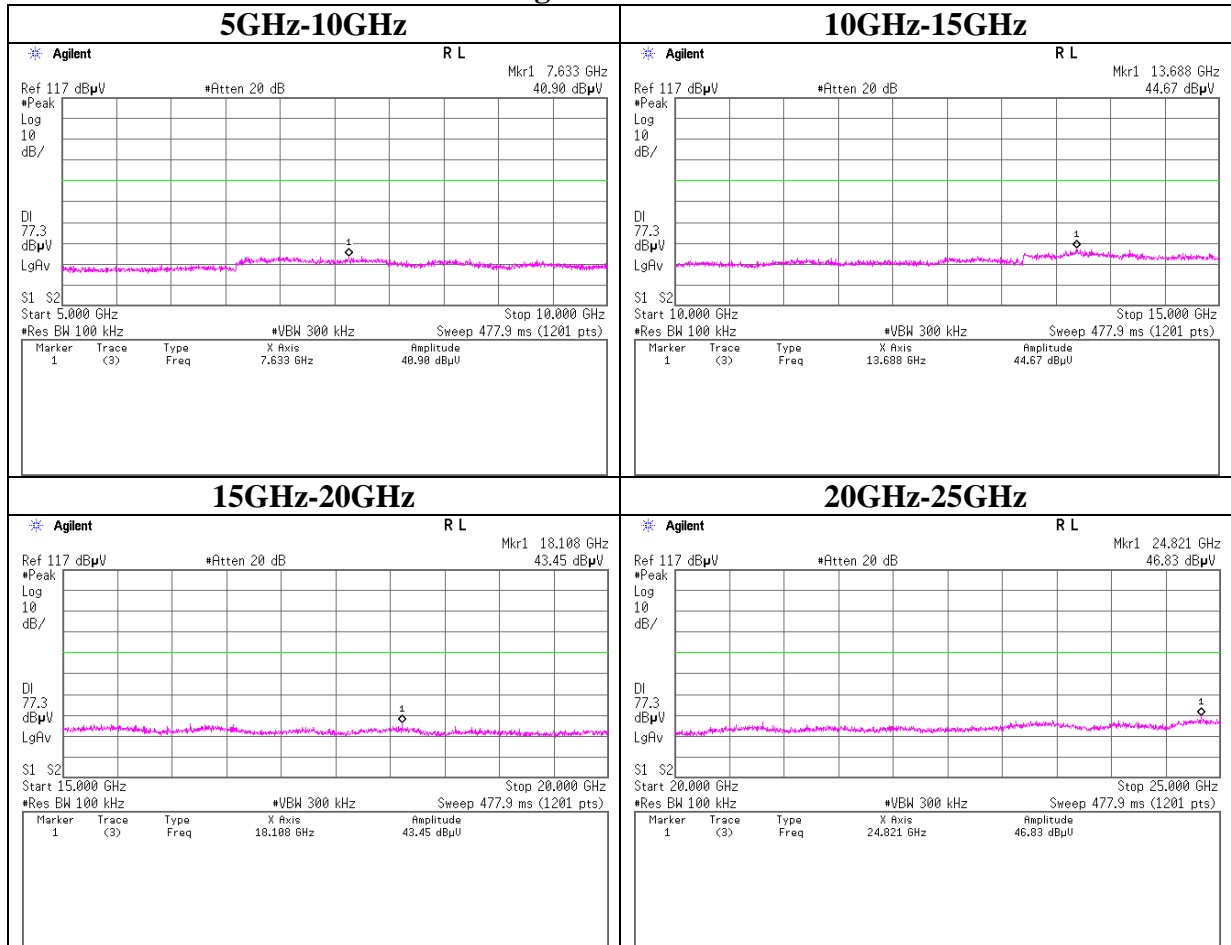

Conducted Spurious Emission

Test place	Ise EMC Lab. No.7 Shielded Room	
Report No.	10447653H	
Date	09/19/2012	09/20/2012
Temperature/ Humidity	20 deg. C / 48% RH	21 deg. C / 46% RH
Engineer	Tomohisa Nakagawa	Tomohisa Nakagawa
Mode	Tx	

11g Tx 2437MHz

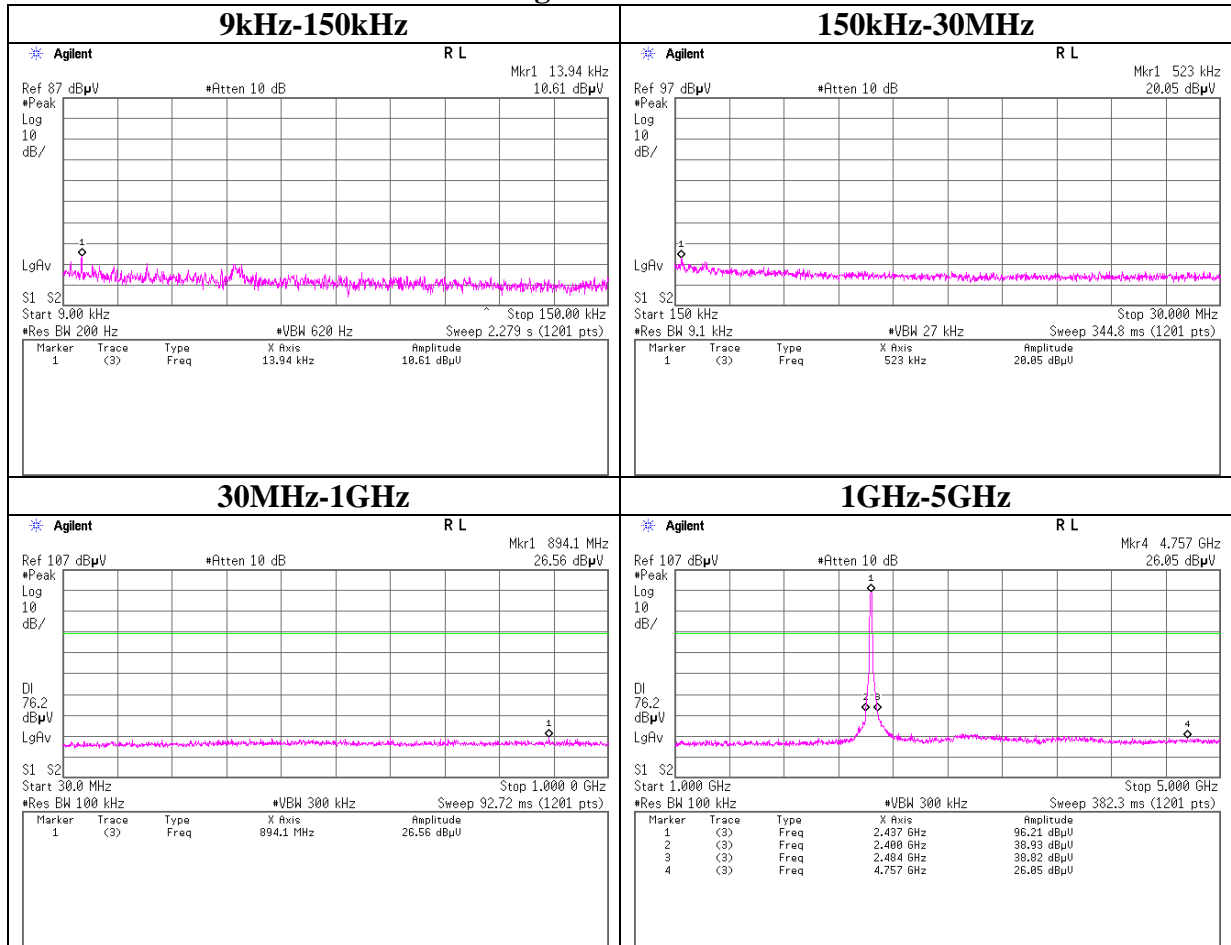

Conducted Spurious Emission

Test place	Ise EMC Lab. No.7 Shielded Room	
Report No.	10447653H	
Date	09/19/2012	09/20/2012
Temperature/ Humidity	20 deg. C / 48% RH	21 deg. C / 46% RH
Engineer	Tomohisa Nakagawa	Tomohisa Nakagawa
Mode	Tx	

11g Tx 2437MHz

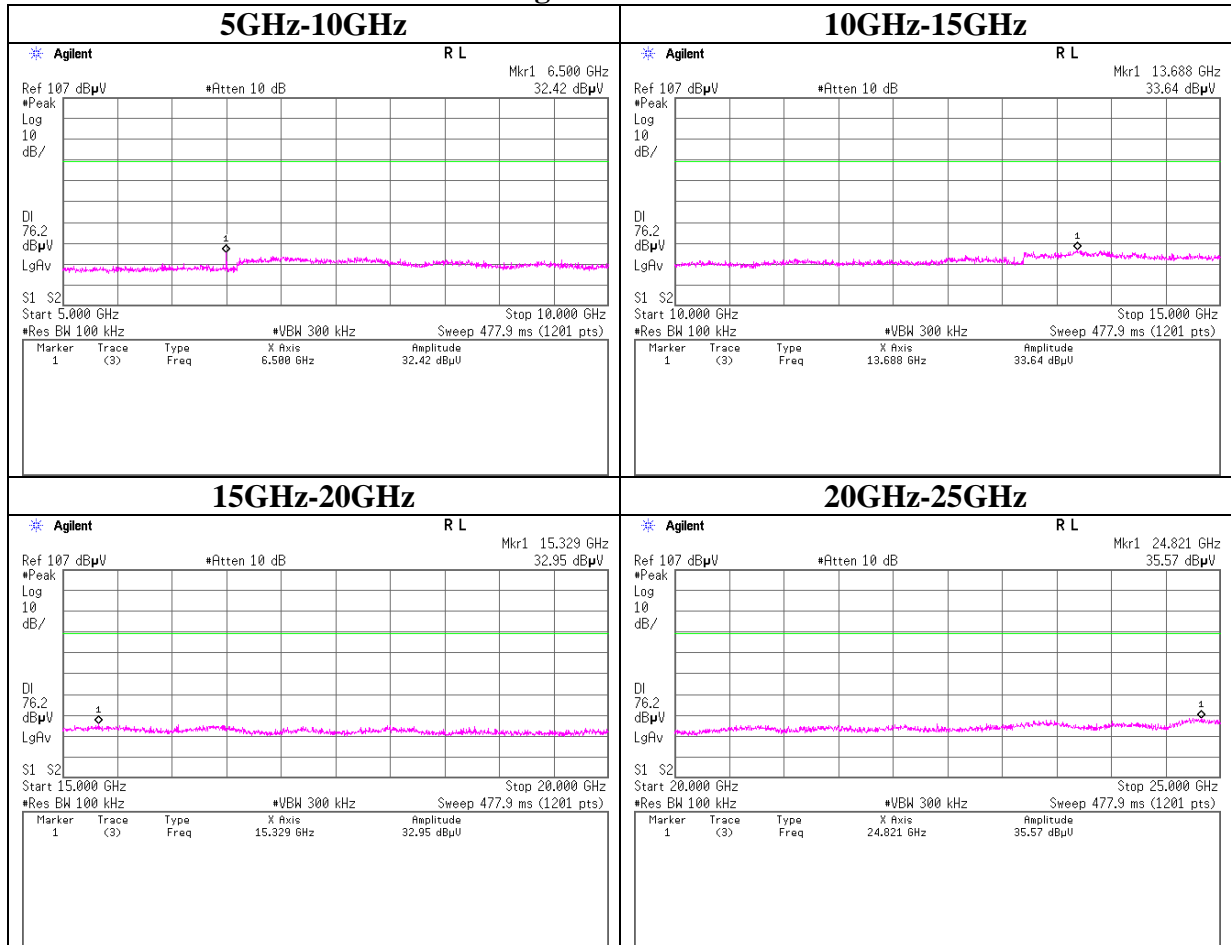

Conducted Spurious Emission

Test place	Ise EMC Lab. No.7 Shielded Room	
Report No.	10447653H	
Date	09/19/2012	09/20/2012
Temperature/ Humidity	20 deg. C / 48% RH	21 deg. C / 46% RH
Engineer	Tomohisa Nakagawa	Tomohisa Nakagawa
Mode	Tx	

11g Tx 2462MHz

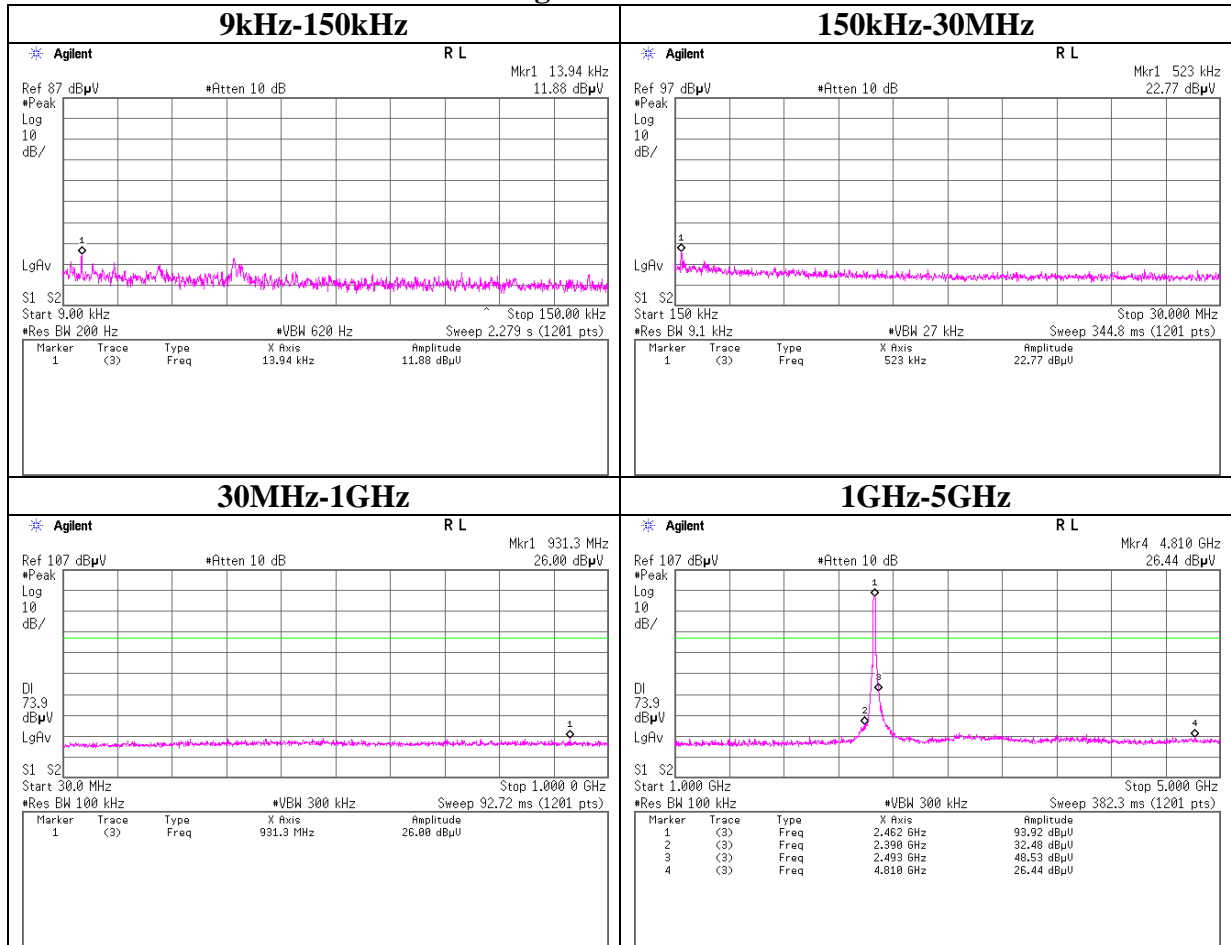

Conducted Spurious Emission

Test place	Ise EMC Lab. No.7 Shielded Room	
Report No.	10447653H	
Date	09/19/2012	09/20/2012
Temperature/ Humidity	20 deg. C / 48% RH	21 deg. C / 46% RH
Engineer	Tomohisa Nakagawa	Tomohisa Nakagawa
Mode	Tx	

11g Tx 2462MHz

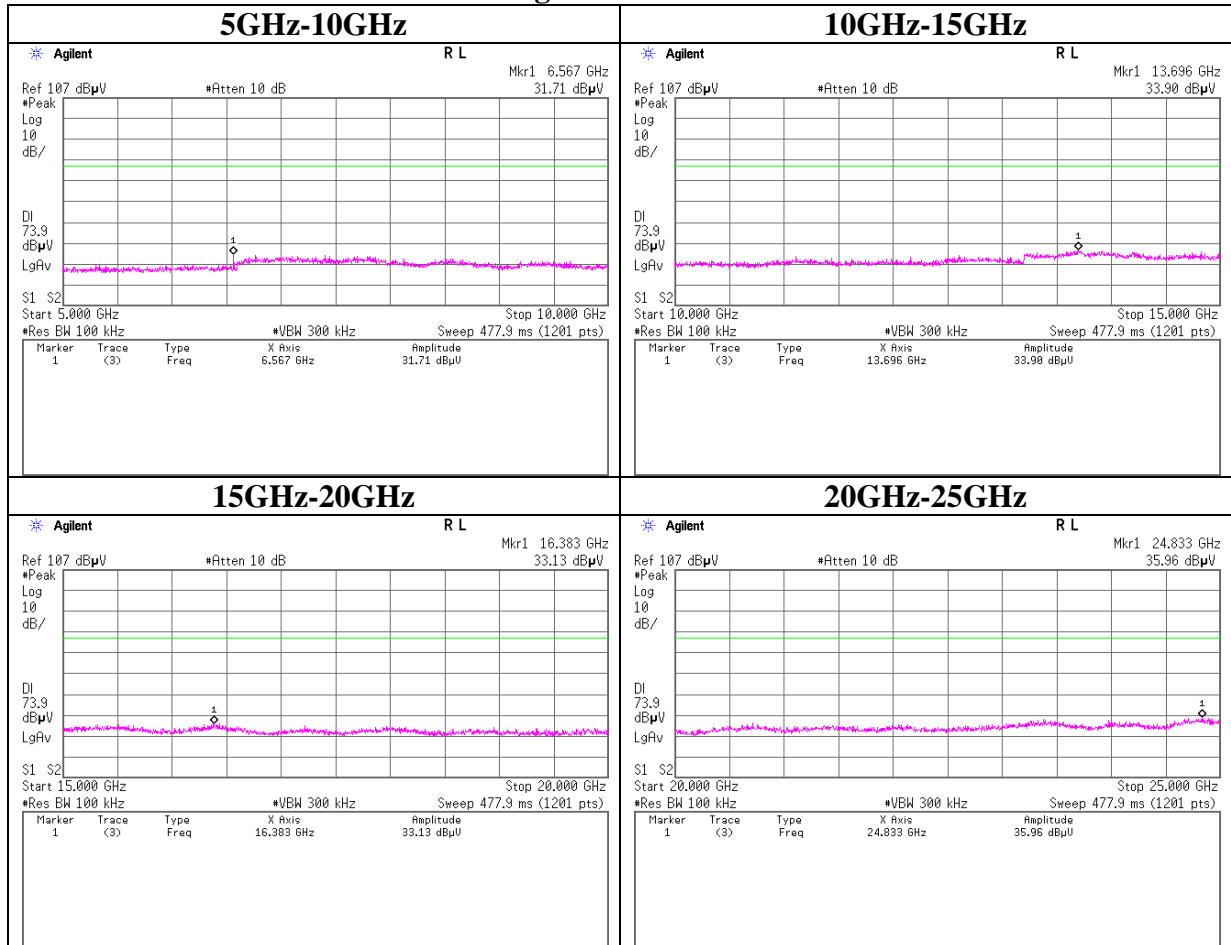

Conducted Spurious Emission

Test place	Ise EMC Lab. No.7 Shielded Room	
Report No.	10447653H	
Date	09/19/2012	09/20/2012
Temperature/ Humidity	20 deg. C / 48% RH	21 deg. C / 46% RH
Engineer	Tomohisa Nakagawa	Tomohisa Nakagawa
Mode	Tx	

11n-20 Tx 2412MHz

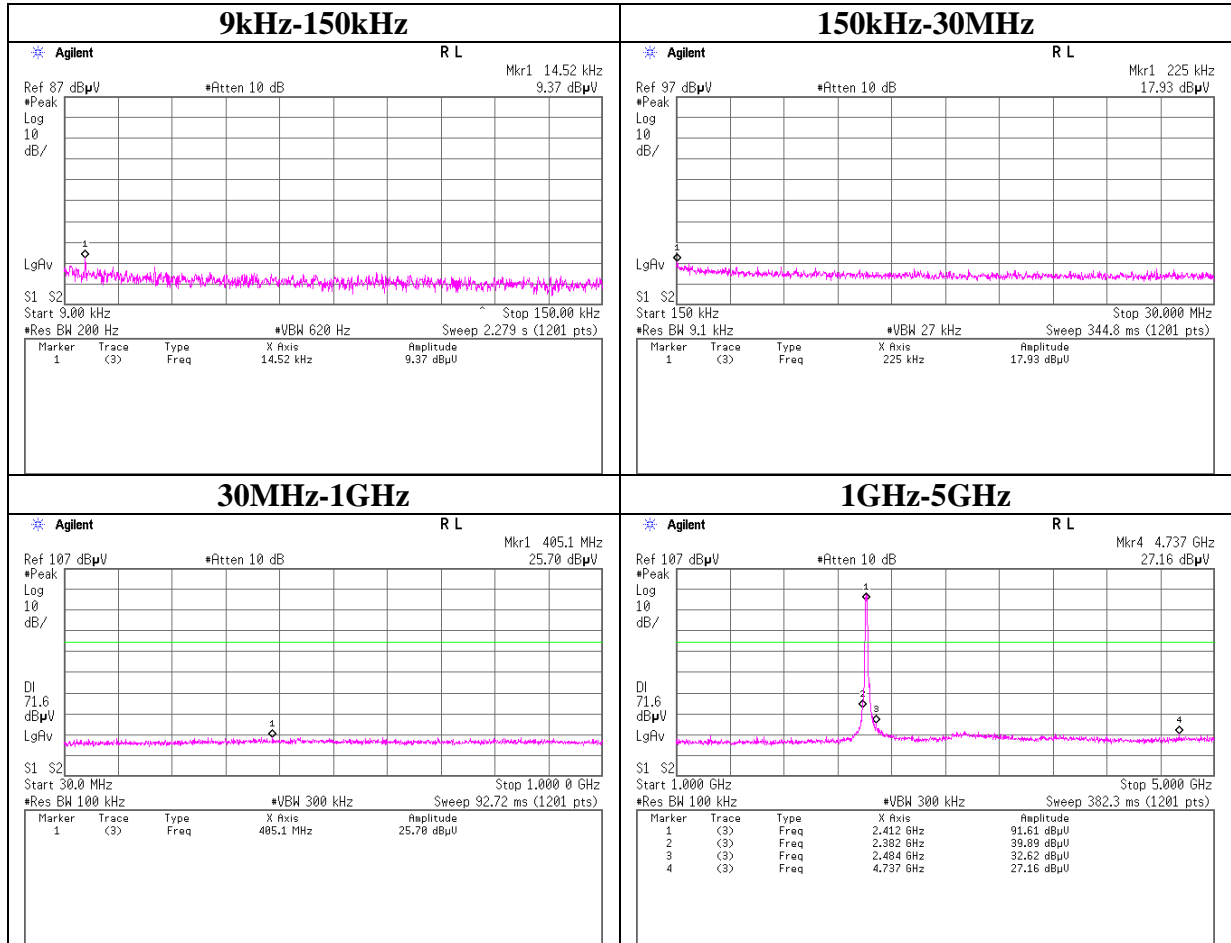

Conducted Spurious Emission

Test place	Ise EMC Lab. No.7 Shielded Room	
Report No.	10447653H	
Date	09/19/2012	09/20/2012
Temperature/ Humidity	20 deg. C / 48% RH	21 deg. C / 46% RH
Engineer	Tomohisa Nakagawa	Tomohisa Nakagawa
Mode	Tx	

11n-20 Tx 2412MHz

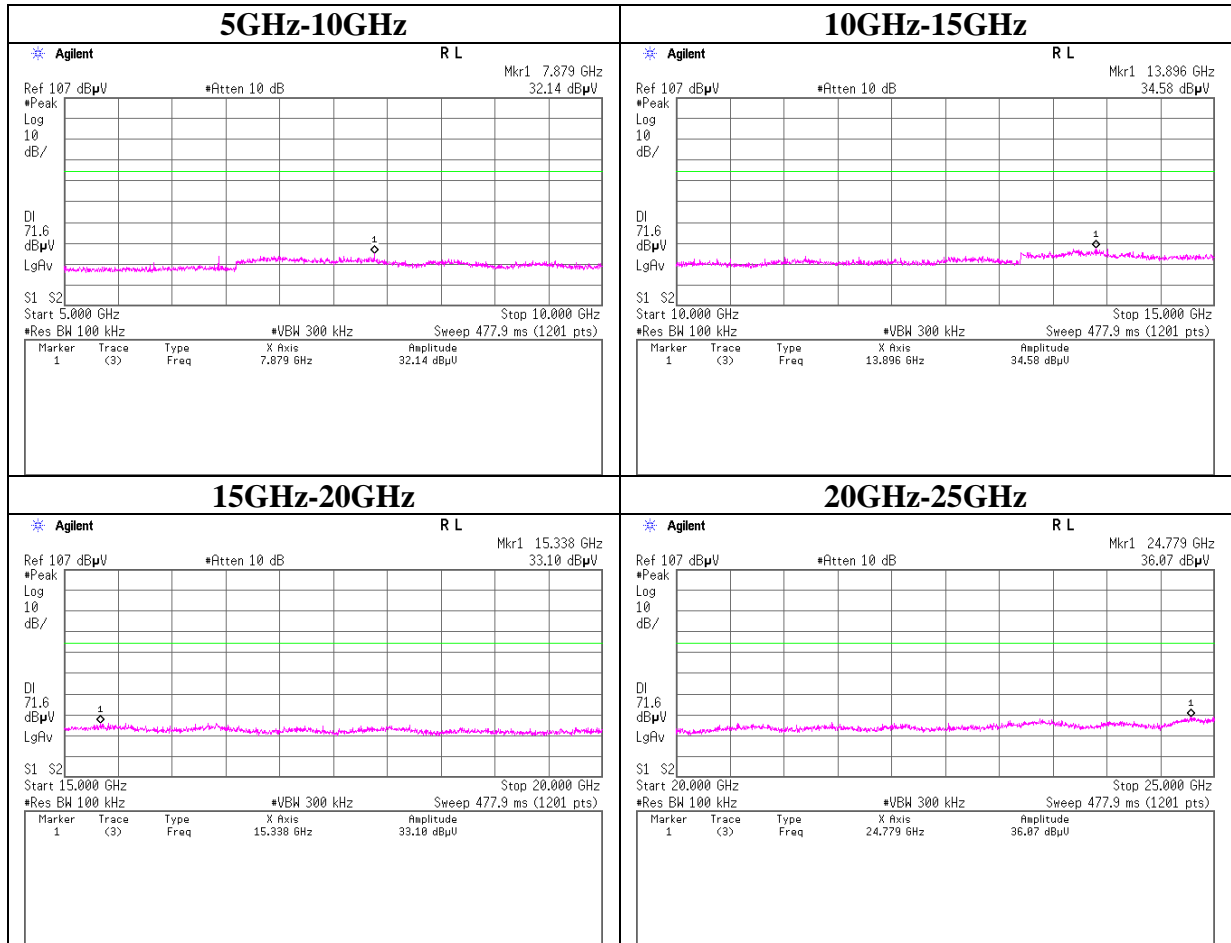

Conducted Spurious Emission

Test place	Ise EMC Lab. No.7 Shielded Room	
Report No.	10447653H	
Date	09/19/2012	09/20/2012
Temperature/ Humidity	20 deg. C / 48% RH	21 deg. C / 46% RH
Engineer	Tomohisa Nakagawa	Tomohisa Nakagawa
Mode	Tx	

11n-20 Tx 2437MHz

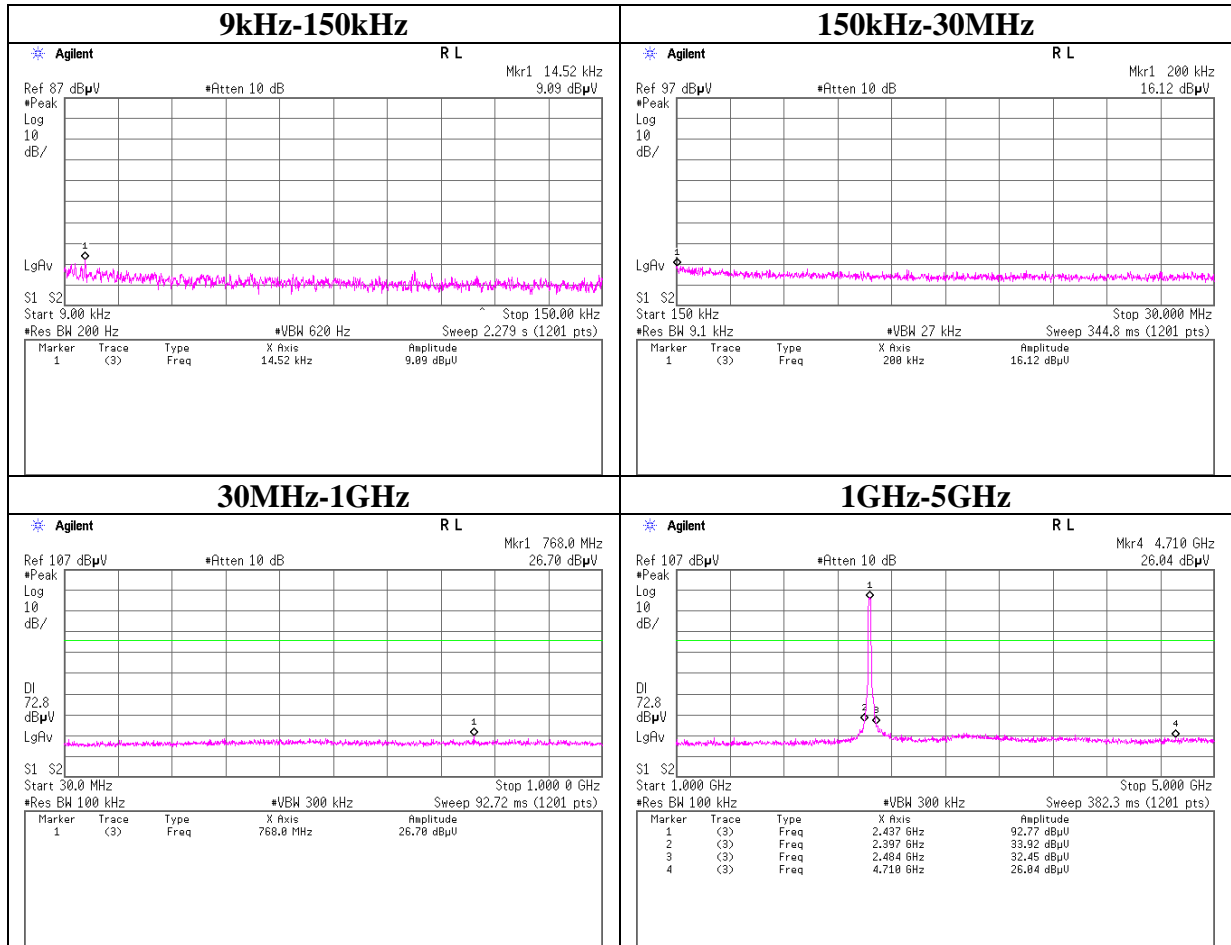

Conducted Spurious Emission

Test place	Ise EMC Lab. No.7 Shielded Room	
Report No.	10447653H	
Date	09/19/2012	09/20/2012
Temperature/ Humidity	20 deg. C / 48% RH	21 deg. C / 46% RH
Engineer	Tomohisa Nakagawa	Tomohisa Nakagawa
Mode	Tx	

11n-20 Tx 2437MHz

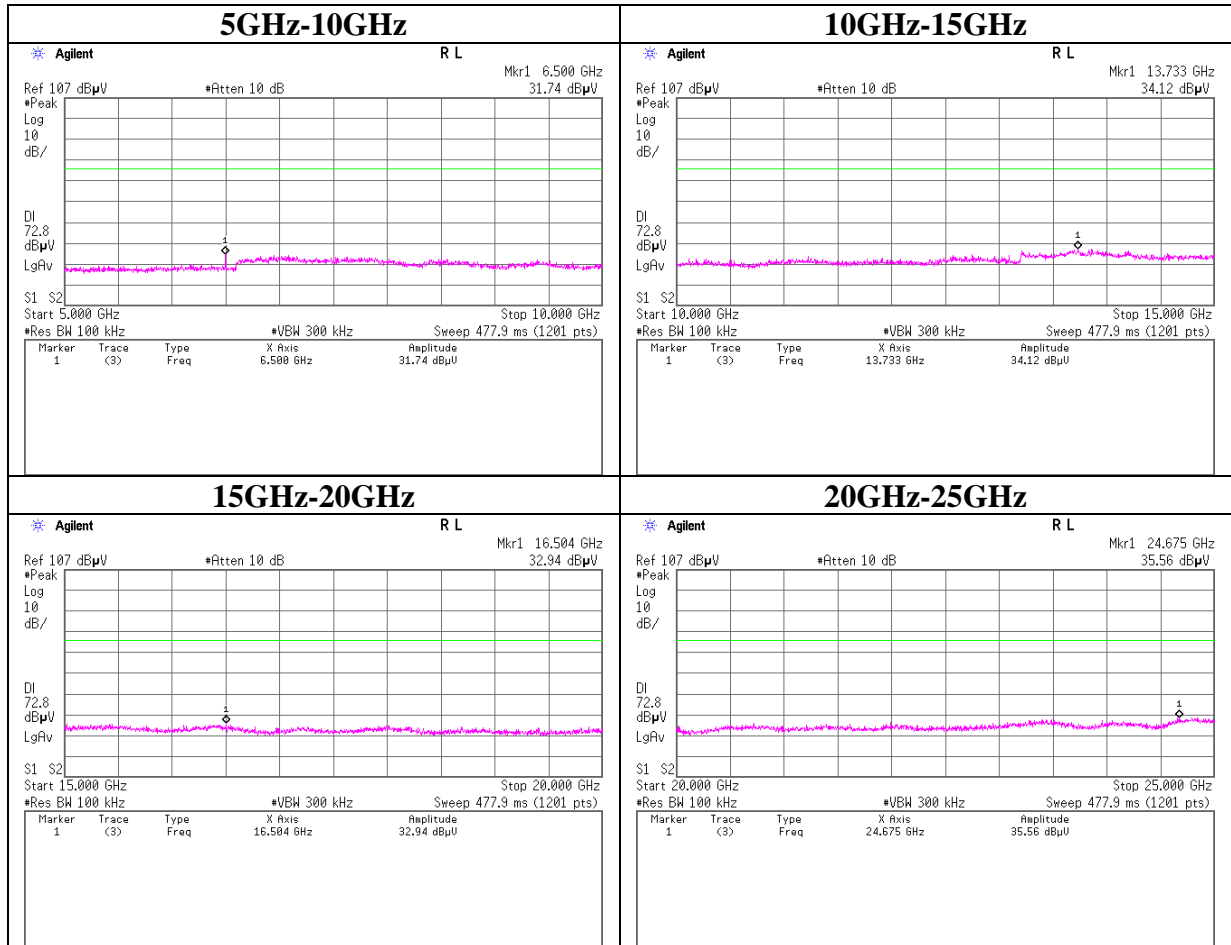

Conducted Spurious Emission

Test place	Ise EMC Lab. No.7 Shielded Room	
Report No.	10447653H	
Date	09/19/2012	09/20/2012
Temperature/ Humidity	20 deg. C / 48% RH	21 deg. C / 46% RH
Engineer	Tomohisa Nakagawa	Tomohisa Nakagawa
Mode	Tx	

11n-20 Tx 2462MHz

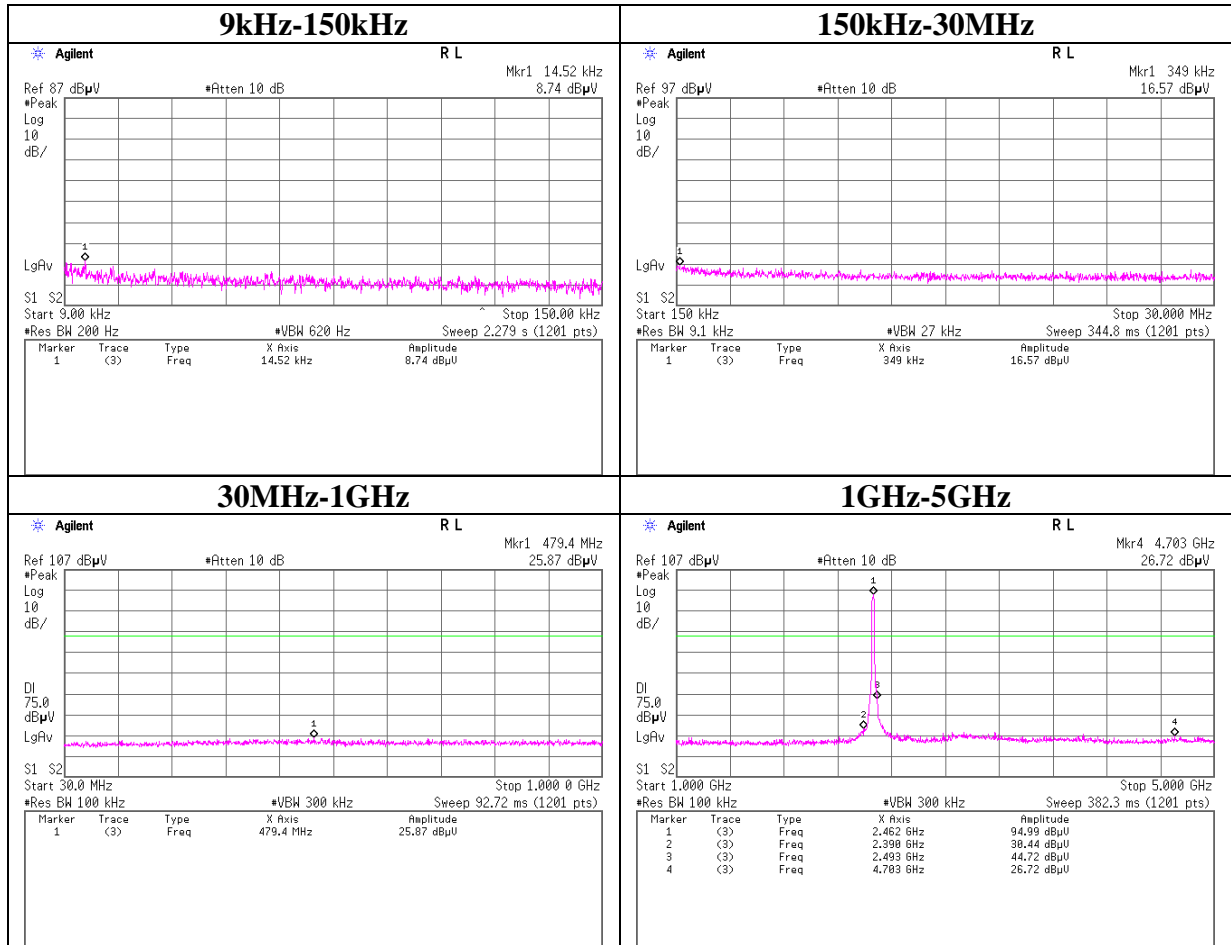

Conducted Spurious Emission

Test place	Ise EMC Lab. No.7 Shielded Room	
Report No.	10447653H	
Date	09/19/2012	09/20/2012
Temperature/ Humidity	20 deg. C / 48% RH	21 deg. C / 46% RH
Engineer	Tomohisa Nakagawa	Tomohisa Nakagawa
Mode	Tx	

11n-20 Tx 2462MHz

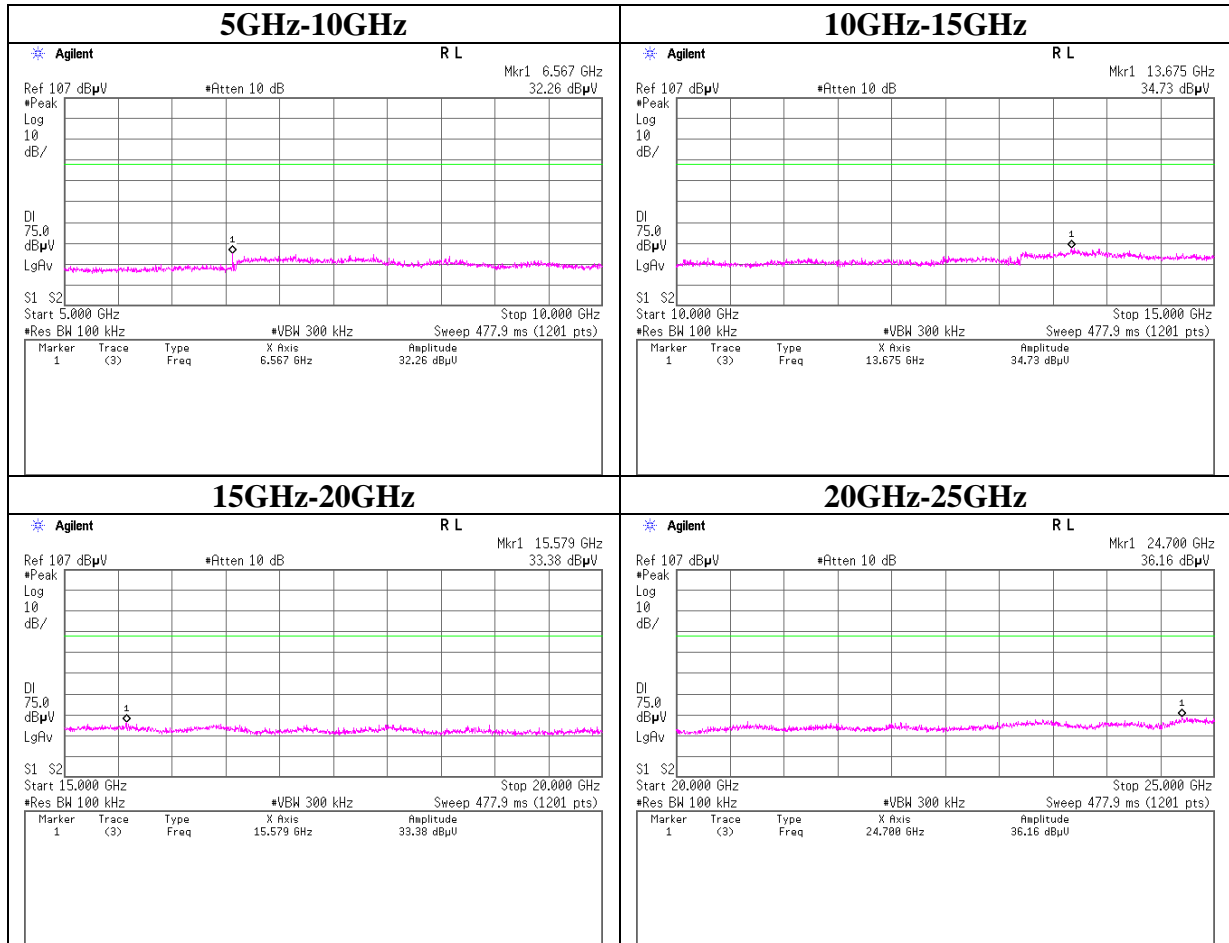

Conducted Emission Band Edge compliance

Test place : Ise EMC Lab. No.7 Shielded Room
Report No. : 10447653H
Date : 09/19/2012 09/20/2012
Temperature/ Humidity : 20 deg. C / 48% RH 21 deg. C / 46% RH
Engineer : Tomohisa Nakagawa Tomohisa Nakagawa
Mode : Tx

11b Tx

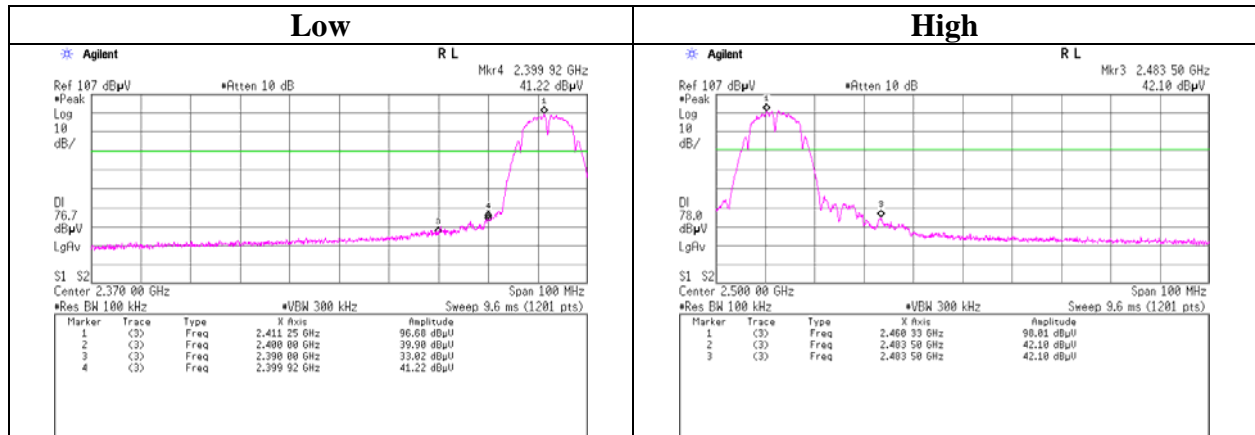

11g Tx

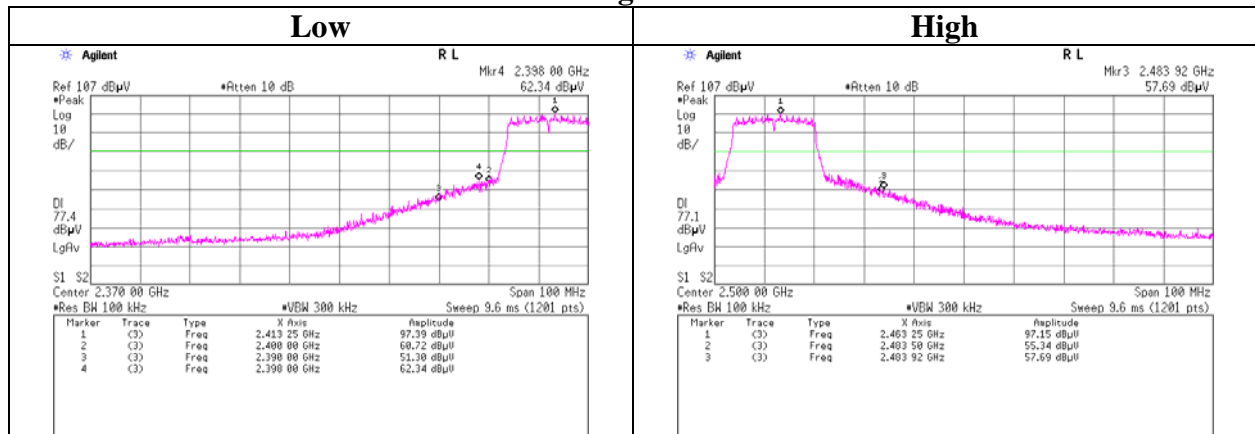

11n-20 Tx

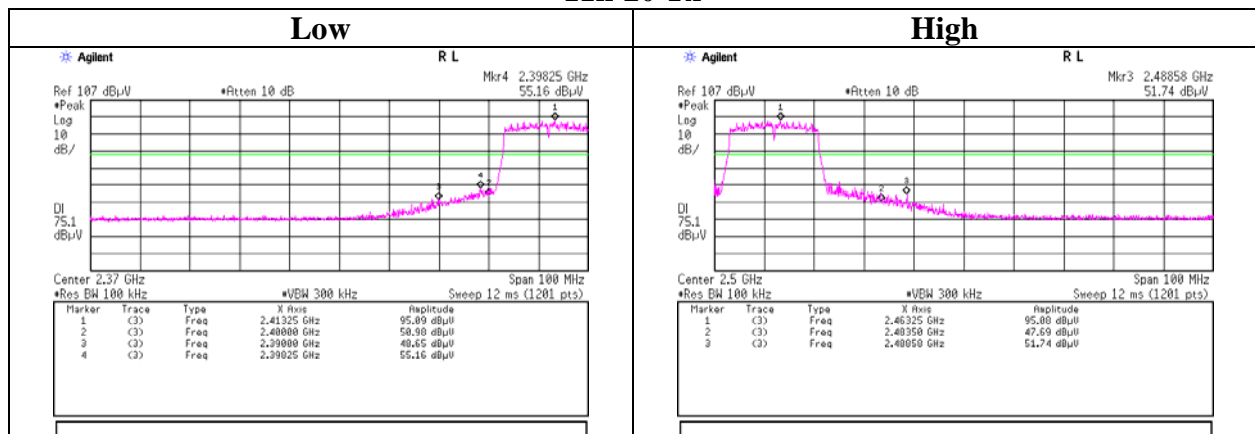

Power Density

Test place Ise EMC Lab. No.7 Shielded Room
Report No. 10447653H
Date 09/19/2012
Temperature/ Humidity 20 deg. C / 48% RH
Engineer Tomohisa Nakagawa
Mode 11b Tx, 11g Tx

11b

Freq. [MHz]	Reading [dBm]	Cable Loss [dB]	Atten. [dB]	Result [dBm]	Limit [dBm]	Margin [dB]
2412.00	-13.86	0.88	10.00	-2.98	8.00	10.98
2437.00	-12.05	0.89	10.00	-1.16	8.00	9.16
2462.00	-12.04	0.89	10.00	-1.15	8.00	9.15

11g

Freq. [MHz]	Reading [dBm]	Cable Loss [dB]	Atten. [dB]	Result [dBm]	Limit [dBm]	Margin [dB]
2412.00	-14.00	0.88	10.00	-3.12	8.00	11.12
2437.00	-14.28	0.89	10.00	-3.39	8.00	11.39
2462.00	-14.04	0.89	10.00	-3.15	8.00	11.15

Sample Calculation:

Result = Reading + Cable Loss (including the cable(s) customer supplied) + Attenuator

Power Density

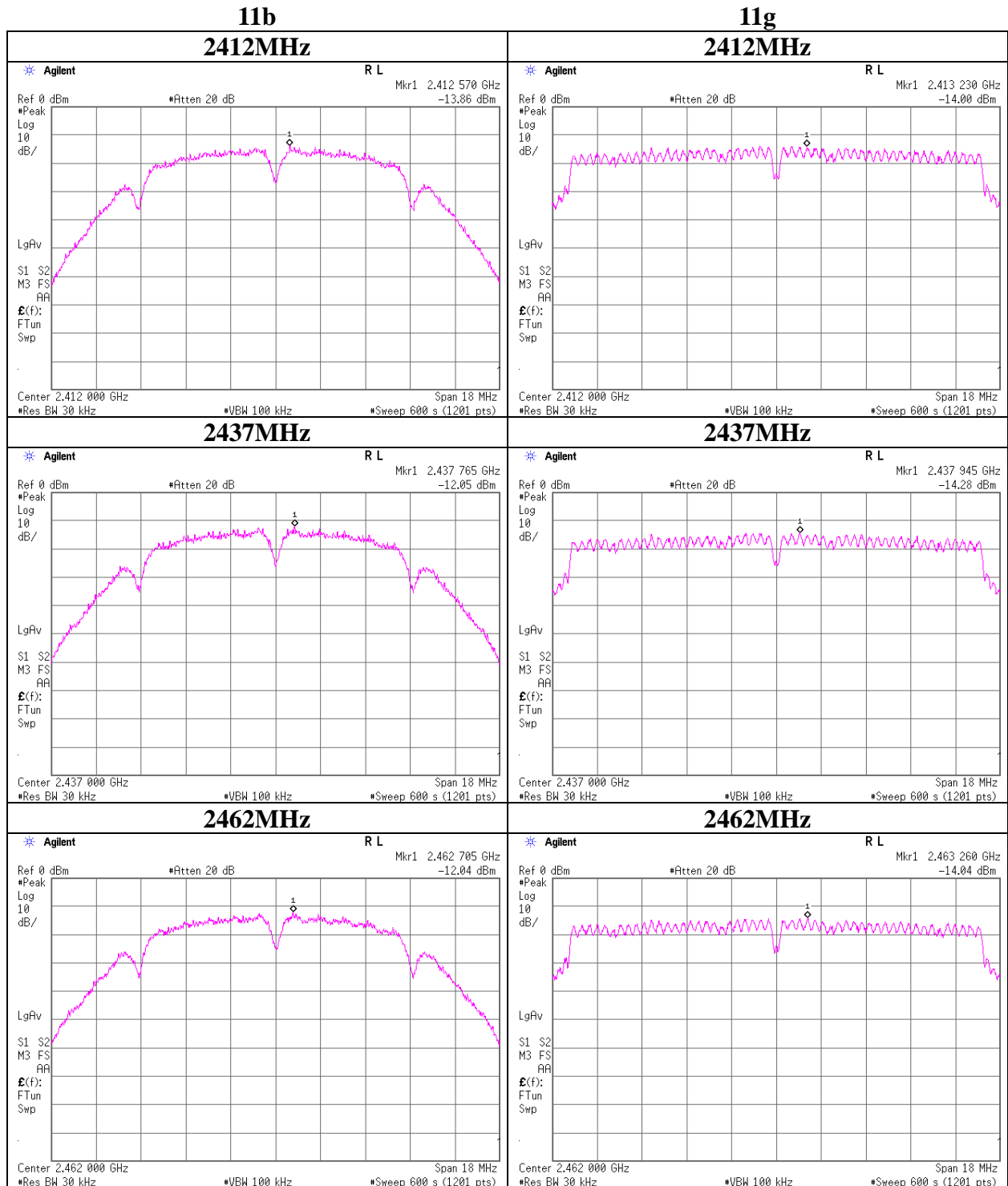

Power Density

Test place Ise EMC Lab. No.7 Shielded Room
Report No. 10447653H
Date 09/19/2012
Temperature/ Humidity 21 deg. C / 46% RH
Engineer Tomohisa Nakagawa
Mode 11n-20 Tx

Freq. [MHz]	Reading [dBm]	Cable Loss [dB]	Atten. [dB]	Result		Limit [dBm]	Margin [dB]
				[dBm]	[mW]		
2412.00	-15.91	0.88	10.00	-5.03	0.31	8.00	13.03
2437.00	-16.08	0.89	10.00	-5.19	0.30	8.00	13.19
2462.00	-16.19	0.89	10.00	-5.30	0.30	8.00	13.30

Sample Calculation:

Result = Reading + Cable Loss (including the cable(s) customer supplied) + Attenuator

Power Density

11n-20

2412MHz

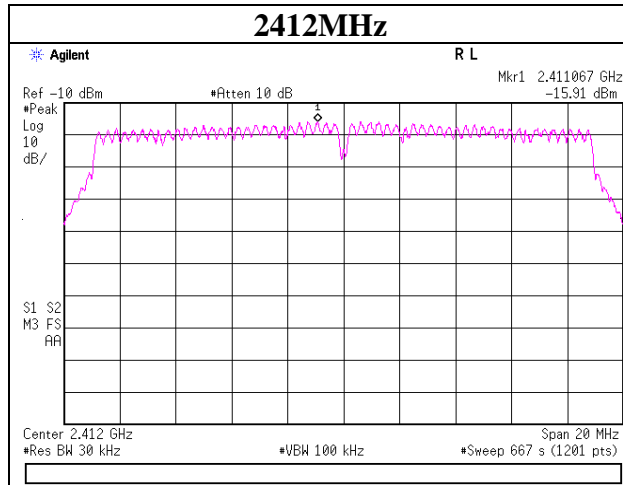

2437MHz

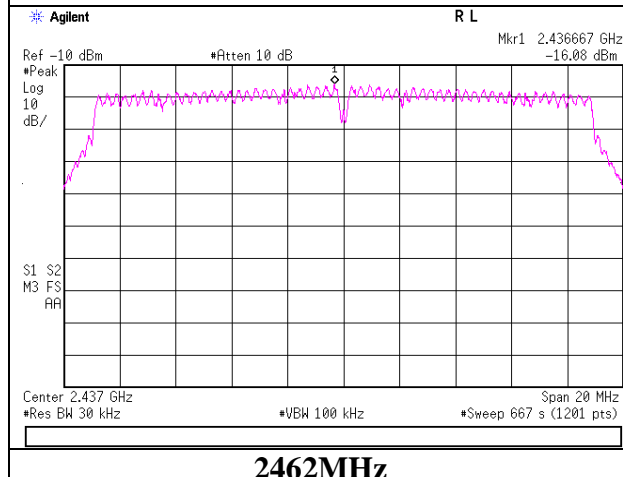

2462MHz

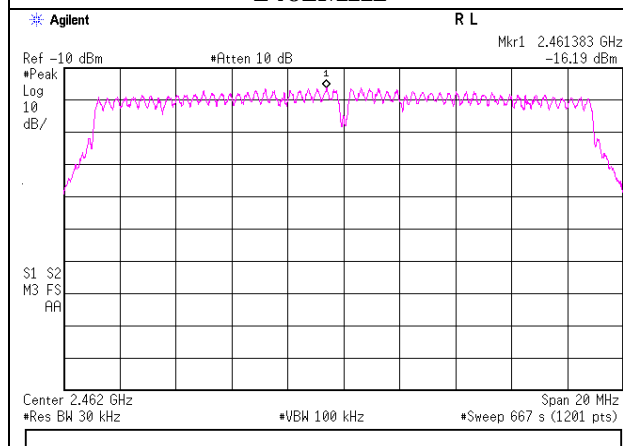

UL Japan, Inc.
Ise EMC Lab.

4383-326 Asama-cho, Ise-shi, Mie-ken 516-0021 JAPAN

Telephone : +81 596 24 8999

Facsimile : +81 596 24 8124

99% Occupied Bandwidth

Test place	Ise EMC Lab. No.7 Shielded Room
Report No.	10447653H
Date	09/19/2012
Temperature/ Humidity	21 deg. C / 46% RH
Engineer	Tomohisa Nakagawa
Mode	11b Tx, 11g Tx

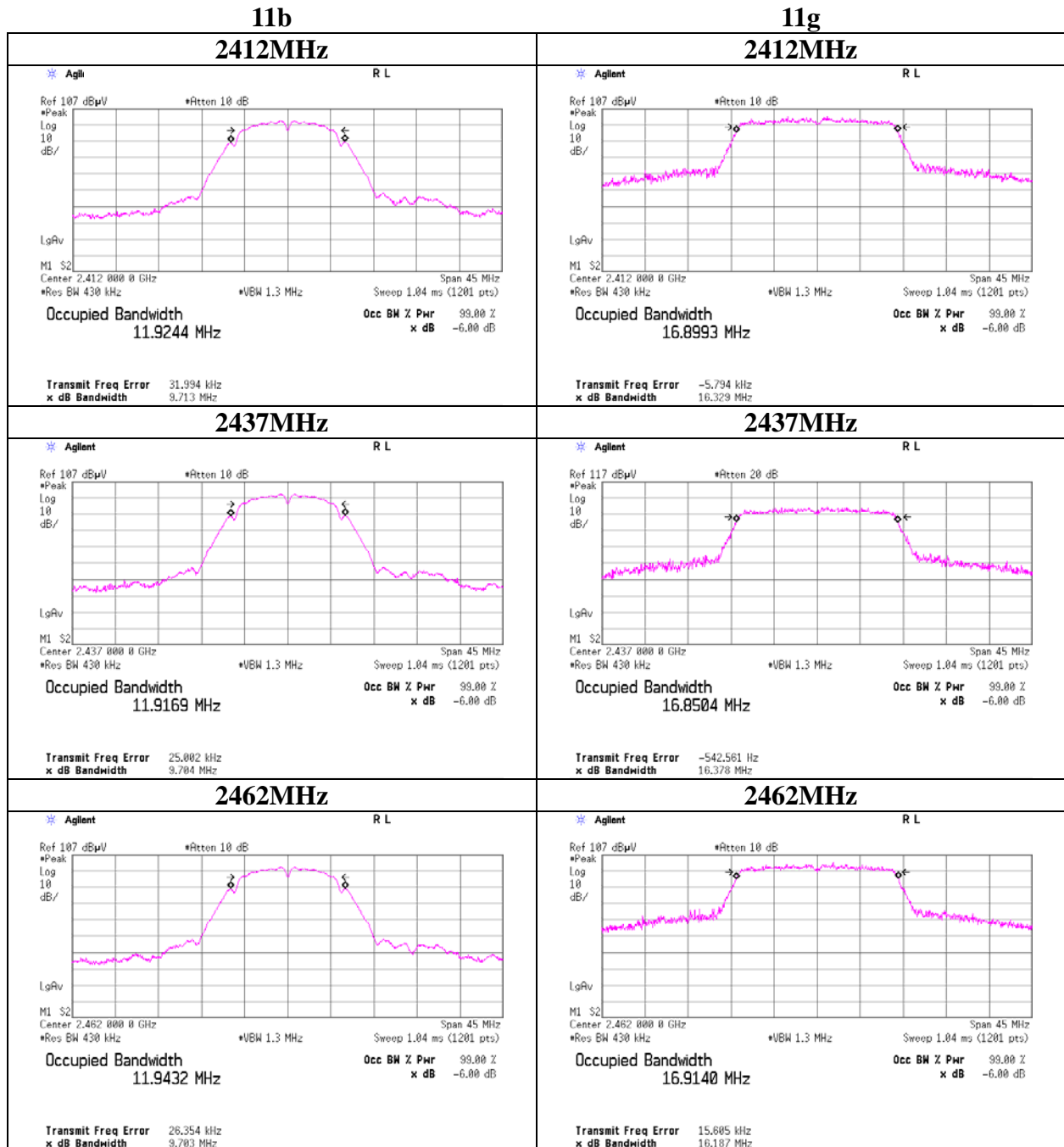

99% Occupied Bandwidth

Test place	Ise EMC Lab. No.7 Shielded Room
Report No.	10447653H
Date	09/19/2012
Temperature/ Humidity	21 deg. C / 46% RH
Engineer	Tomohisa Nakagawa
Mode	11n-20 Tx

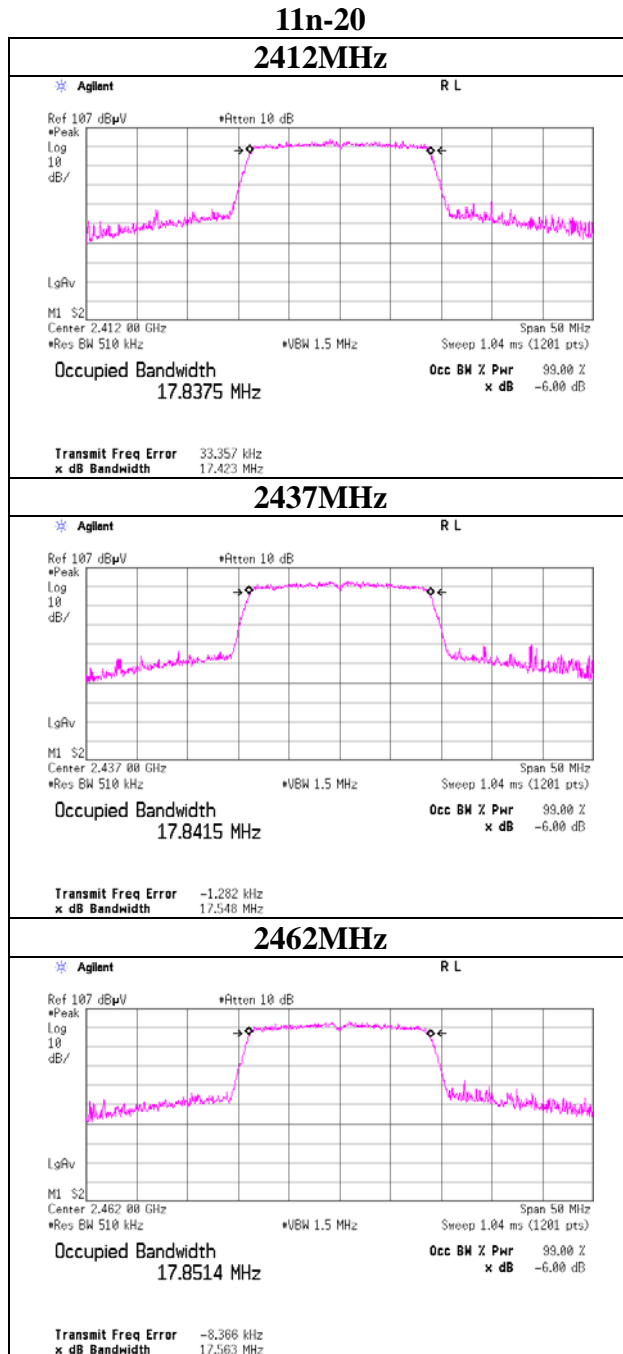

APPENDIX 2: Test instruments

EMI test equipment

Control No.	Instrument	Manufacturer	Model No	Serial No	Test Item	Calibration Date * Interval(month)
MOS-04	Digital Humidity Indicator	N.T	NT-1800	MOS04	AT	2012/02/06 * 12
MSA-10	Spectrum Analyzer	Agilent	E4448A	MY46180655	AT	2012/02/03 * 12
MPM-12	Power Meter	Anritsu	ML2495A	0825002	AT	2012/06/01 * 12
MPSE-17	Power sensor	Anritsu	MA2411B	0738285	AT	2012/06/01 * 12
MCC-144	Microwave Cable	Junkosha	MWX221	1207S407	AT	2012/08/03 * 12
MAT-22	Attenuator(10dB) 1-18GHz	Orient Microwave	BX10-0476-00	-	AT	2012/03/27 * 12
MCC-96	Microwave Cable 1G-40GHz	Schner	SUCOFLEX102	30817/2	AT	2012/05/09 * 12
MSA-06	Spectrum Analyzer	Agilent	E4407B	MY45107638	AT	2012/04/04 * 12
MAEC-04	Semi Anechoic Chamber(NSA)	TDK	Semi Anechoic Chamber 3m	DA-10005	RE/CE	2012/02/29 * 12
MOS-15	Thermo-Hygrometer	Custom	CTH-180	-	RE/CE	2012/02/06 * 12
MJM-07	Measure	PROMART	SEN1955	-	RE/CE	-
COTS-MEMI	EMI measurement program	TSJ	TEPTO-DV	-	RE/CE	-
MSA-04	Spectrum Analyzer	Agilent	E4448A	US44300523	RE/CE	2012/04/06 * 12
MHA-21	Horn Antenna 1-18GHz	Schwarzbeck	BBHA9120D	9120D-557	RE	2012/08/17 * 12
MCC-141	Microwave Cable	Junkosha	MWX221	1203S212(1m) / 1204S062(5m)	RE	2012/04/23 * 12
MPA-12	MicroWave System Amplifier	Agilent	83017A	MY39500780	RE	2012/03/28 * 12
MHF-06	High Pass Filter 3.5-24GHz	TOKIMEC	TF323DCA	601	RE	2012/05/30 * 12
MTR-07	Test Receiver	Rohde & Schwarz	ESCI	100635	RE/CE	2012/04/05 * 12
MBA-05	Biconical Antenna	Schwarzbeck	BBA9106	1302	RE	2011/11/16 * 12
MLA-08	Logperiodic Antenna	Schwarzbeck	UKLP9140-A	N/A	RE	2011/11/16 * 12
MCC-50	Coaxial Cable	UL Japan	-	-	RE	2012/06/01 * 12
AT-38	Attenuator	Anritsu	MP721B	6200961025	RE	2011/12/08 * 12
MPA-14	Pre Amplifier	SONOMA INSTRUMENT	310	260833	RE	2012/03/05 * 12
MHA-17	Horn Antenna 15-40GHz	Schwarzbeck	BBHA9170	BBHA9170307	RE	2012/06/27 * 12
MSA-05	Spectrum Analyzer	Advantest	R3273	160400285	CE	2011/11/23 * 12
MLS-06	LISN(AMN)	Schwarzbeck	NSLK8127	8127363	CE(EUT)	2012/02/06 * 12
MAT-67	Attenuator(13dB)	JFW Industries, Inc.	50FP-013H2 N	-	CE	2012/01/28 * 12
MCC-113	Coaxial cable	Fujikura/Suhner/TSJ	5D-2W(10m)/ SFM141(5m)/ 421-010(1m)/ sucoform141-PE(1m)/ RFM-E121(Switcher)	-/04178	CE	2012/07/12 * 12

The expiration date of the calibration is the end of the expired month.

All equipment is calibrated with valid calibrations. Each measurement data is traceable to the national or international standards.

As for some calibrations performed after the tested dates, those test equipment have been controlled by means of an unbroken chains of calibrations.

Test Item: CE: Conducted Emission
RE: Radiated Emission
AT: Antenna Terminal Conducted test

UL Japan, Inc.

Ise EMC Lab.

4383-326 Asama-cho, Ise-shi, Mie-ken 516-0021 JAPAN

Telephone : +81 596 24 8999

Facsimile : +81 596 24 8124