

FCC TEST REPORT
for
Jinan USR IOT Technology Limited

Serial to WIFI Module
Model No.: USR-WIFI232-610, USR-WIFI232-2,
USR-WIFI232-602, USR-WIFI232-604, USR-WIFI232-200

Prepared for : Jinan USR IOT Technology Limited
Address : #1-724~729, Huizhan Guoji Cheng, Gaoxin District, Jinan City,
Shandong Province, 250101, China

Prepared By : Shenzhen Anbotek Compliance Laboratory Limited
Address : 1/F., Building 1, SEC Industrial Park, No.0409 Qianhai Road,
Nanshan District, Shenzhen, Guangdong, China
Tel: (86) 755-26066544
Fax: (86) 755-26014772

Report Number : R011407005E
Date of Test : Jul. 10~ Aug. 18, 2014
Date of Report : Aug. 19, 2014

TABLE OF CONTENT

Description

Page

Test Report

1. GENERAL INFORMATION.....4

1.1. Description of Device (EUT).....4

1.2. Auxiliary Equipment Used during Test.....5

1.3. Description of Test Facility.....6

1.4. Measurement Uncertainty.....6

2. TEST METHODOLOGY.....7

2.1. Summary of Test Results.....7

2.2. Description of Test Modes.....7

2.3. List of channels:.....8

3. CONDUCTED EMISSION TEST.....9

3.1. Block Diagram of Test Setup.....9

3.2. Power Line Conducted Emission Measurement Limits (15.207).....9

3.3. Configuration of EUT on Measurement.....9

3.4. Operating Condition of EUT.....9

3.5. Test Procedure.....10

3.6. Test equipment.....10

3.7. Power Line Conducted Emission Measurement Results.....10

4. FCC PART 15.247 REQUIREMENTS FOR DSSS & OFDM MODULATION..... 13

4.1 Test Setup.....13

4.2 6dB Bandwidth.....13

4.3. Maximum Peak output power test.....21

4.4. Band Edges Measurement.....29

4.5. Peak Power Spectral Density.....66

4.6. Radiated Emissions.....74

5. PHOTOGRAPH..... 85

5.1. Photo of Conducted Emission Measurement.....85

5.2. Photo of Radiation Emission Test.....85

APPENDIX I (EXTERNAL PHOTOS).....87

APPENDIX II (INTERNAL PHOTOS)..... 91

Appendix I (4 Pages)

Appendix II (4 Pages)

TEST REPORT

Applicant : Jinan USR IOT Technology Limited
Manufacturer : Jinan USR IOT Technology Limited
EUT : Serial to WIFI Module
Model No. : USR-WIFI232-610, USR-WIFI232-2, USR-WIFI232-602,
USR-WIFI232-604, USR-WIFI232-200
Serial No. : N.A.
Trade Mark : USR IOT
Rating : DC 5-18V, 1000mA

Measurement Procedure Used:
FCC Part15 Subpart C, Paragraph 15.247

The device described above is tested by Shenzhen Anbotek Compliance Laboratory Limited to determine the maximum emission levels emanating from the device and the severe levels of the device can endure and its performance criterion. The measurement results are contained in this test report and Shenzhen Anbotek Compliance Laboratory Limited is assumed full of responsibility for the accuracy and completeness of these measurements. Also, this report shows that the EUT (Equipment Under Test) is technically compliant with the FCC Part 15 Subpart C requirements.

This report applies to above tested sample only and shall not be reproduced in part without written approval of Shenzhen Anbotek Compliance Laboratory Limited.

Date of Test : Jul. 10~ Aug. 18, 2014

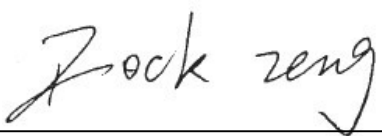
Prepared by : 
(Tested Engineer / Rock Zeng)

Reviewer : 
(Project Manager / Amy Ding)

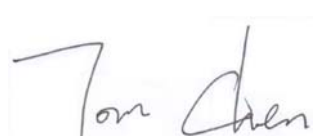
Approved & Authorized Signer : 
(Manager / Tom Chen)

1. GENERAL INFORMATION

1.1. Description of Device (EUT)

EUT	: Serial to WIFI Module
Model Number	: USR-WIFI232-610, USR-WIFI232-2, USR-WIFI232-602, USR-WIFI232-604, USR-WIFI232-200 (Note: All samples are the same except the model number and appearance, so we prepare “USR-WIFI232-610” for EMC test only.)
Test Power Supply	: AC 120V/60Hz for adapter
Adapter	: Model:FLD052-0501000-UH Input: AC 100-240V, 50/60Hz, 0.15A MAX Output: DC 5.0V, 1.0A
RF Transmission Frequency	: 2412MHz~2462MHz (802.11b/802.11g/802.11n(HT20)) 2422MHz~2452MHz (802.11n(HT40))
Channels	: 11 For (802.11b/802.11g/802.11n(HT20)) 7 For (802.11n(HT40))
Modulation	802.11b CCK 802.11g OFDM 802.11n MCS
Antenna Gain:	: 3dBi
Applicant Address	: Jinan USR IOT Technology Limited : #1-724~729, Huizhan Guoji Cheng, Gaoxin District, Jinan City, Shandong Province, 250101, China
Manufacturer Address	: Jinan USR IOT Technology Limited : #1-724~729, Huizhan Guoji Cheng, Gaoxin District, Jinan City, Shandong Province, 250101, China
Factory Address	: Jinan USR IOT Technology Limited : #1-724~729, Huizhan Guoji Cheng, Gaoxin District, Jinan City, Shandong Province, 250101, China
Date of receipt	: Jul. 10, 2014
Date of Test	: Jul. 10~ Aug. 18, 2014

1.2. Auxiliary Equipment Used during Test

PC	: Manufacturer: DELL M/N: OPTIPLEX 380 S/N: 1J63X2X CE , FCC: DOC
MONITOR	: Manufacturer: DELL M/N: E170Sc S/N: CN-00V539-64180-055-0UPS CE , FCC: DOC
KEYBOARD	: Manufacturer: DELL M/N: SK-8115 S/N: CN-0DJ313-71616-06C-02XN CE , FCC: DOC Cable: 1m, unshielded
MOUSE	: Manufacturer: DELL M/N: M-UARDEL7 S/N: N/A CE , FCC: DOC Cable: 1m, unshielded
Printer	: Manufacturer: Brother M/N: MFC-3360C S/N: N/A CE, FCC: DOC
Power Line	: Non-Shielded, 1.5m
VGA Cable	: Non-Shielded, 1.5m
Network Cable	: Non-Shielded, 1.5m

1.3. Description of Test Facility

The test facility is recognized, certified, or accredited by the following organizations:

CNAS - LAB Code: L3503

Shenzhen Anbotek Compliance Laboratory Limited., Laboratory has been assessed and in compliance with CNAS/CL01: 2006 accreditation criteria for testing laboratories (identical to ISO/IEC 17025:2005 General Requirements) for the Competence of Testing Laboratories.

FCC-Registration No.: 752021

Shenzhen Anbotek Compliance Laboratory Limited, EMC Laboratory has been registered and fully described in a report filed with the (FCC) Federal Communications Commission. The acceptance letter from the FCC is maintained in our files. Registration 752021, July 10, 2013.

IC-Registration No.: 8058A-1

Shenzhen Anbotek Compliance Laboratory Limited., EMC Laboratory has been registered and fully described in a report filed with the (IC) Industry Canada. The acceptance letter from the IC is maintained in our files. Registration 8058A, February 22, 2013.

Test Location

All Emissions tests were performed at
Shenzhen Anbotek Compliance Laboratory Limited. at 1/F., Building 1, SEC Industrial Park, No.0409 Qianhai Road, Nanshan District, Shenzhen, Guangdong, China

1.4. Measurement Uncertainty

Radiation Uncertainty : Ur = 4.3dB

Conduction Uncertainty : Uc = 3.4dB

2. TEST METHODOLOGY

The tests documented in this report were performed in accordance with ANSI C63.4: 2009 and FCC Part 15, Paragraph 15.247.

2.1. Summary of Test Results

The EUT has been tested according to the following specifications:

Standard	Test Type	Result	Notes
FCC Part 15, Paragraph 15.107, 15.207	Conducted Emission Test	PASS	Complies
FCC Part 15, Paragraph 15.247(b)(1)	Peak Output Power	PASS	Complies
FCC Part 15, Paragraph 15.247(a)(2)	6dB Bandwidth	PASS	Complies
FCC Part 15, Paragraph 15.247(c)	100kHz Bandwidth of Frequency Band Edges	PASS	Complies
FCC Part 15, Paragraph 15.209(a)(f)	Spurious Emission	PASS	Complies
FCC Part 15, Paragraph 15.247(a)(1)	Frequency Separation	-	N/A
FCC Part 15, Paragraph 15.247(a)(1)(iii)	Number of Hopping Frequency	-	N/A
FCC Part 15, Paragraph 15.247(a)(1)(iii)	Time of Occupancy	-	N/A
FCC Part 15, Paragraph 15.247(c)	Peak Power Density	PASS	Complies

2.2. Description of Test Modes

The EUT has been tested under operating condition.

Software used to control the EUT for staying in continuous transmitting and receiving mode is programmed.

IEEE802.11b: Channel 1(2412MHz), Channel 6(2437MHz) and Channel 11(2462MHz) with 1 Mbps lowest data rate (worst case) are chosen for the final testing.

IEEE802.11g: Channel 1(2412MHz), Channel 6(2437MHz) and Channel 11(2462MHz) with 6 Mbps lowest data rate (the worst case) are chosen for the final testing.

IEEE802.11n (HT20): Channel 1(2412MHz), Channel 6(2437MHz) and Channel 11(2462MHz) with MCS 0 Mbps lowest data rate (the worst case) are chosen for the final testing.

IEEE802.11n (HT40): Channel 3(2422MHz), Channel 6(2437MHz) and Channel 9(2452MHz) with MCS 0 Mbps lowest data rate (the worst case) are chosen for the final testing.

2.3. List of channels:

√ - available

X - tested

Number	Frequency(MHz)		802.11 b/g/n (HT20)	802.11 b/g/n (HT40)
1	2412	√	X	
2	2417	√		
3	2422	√		X
4	2427	√		
5	2432	√		
6	2437	√	X	X
7	2442	√		
8	2447	√		
9	2452	√		X
10	2457	√		
11	2462	√	X	

3. Conducted Emission Test

3.1. Block Diagram of Test Setup

3.1.1. Block diagram of connection between the EUT and simulators

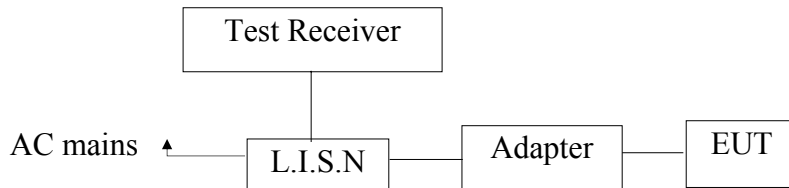

3.2. Power Line Conducted Emission Measurement Limits (15.207)

Frequency MHz	Limits dB(μV)	
	Quasi-peak Level	Average Level
0.15 ~ 0.50	66 ~ 56*	56 ~ 46*
0.50 ~ 5.00	56	46
5.00 ~ 30.00	60	50

- Notes: 1. *Decreasing linearly with logarithm of frequency.
2. The lower limit shall apply at the transition frequencies.

3.3. Configuration of EUT on Measurement

The following equipments are installed on Power Line Conducted Emission Measurement to meet the commission requirement and operating regulations in a manner which tends to maximize its emission characteristics in a normal application.

3.4. Operating Condition of EUT

- 3.4.1. Setup the EUT and simulator as shown as Section 3.1.
- 3.4.2. Turn on the power of all equipment.
- 3.4.3. Let the EUT work in test mode (WiFi Mode, RJ45 Mode) and measure it.

3.5. Test Procedure

The EUT system is connected to the power mains through a line impedance stabilization network (L.I.S.N.). This provides a 50ohm coupling impedance for the EUT system. Please refer the block diagram of the test setup and photographs. Both sides of AC line are checked to find out the maximum conducted emission. In order to find the maximum emission levels, the relative positions of equipment and all of the interface cables shall be changed according to FCC ANSI C63.4-2003 on Conducted Emission Measurement.

The bandwidth of test receiver (ESCI) set at 9KHz.

The frequency range from 150KHz to 30MHz is checked.

The test results are reported on Section 3.6.

3.6. Test equipment

Item	Equipment	Manufacturer	Model No.	Serial No.	Last Cal.	Cal. Interval
1.	Two-Line V-network	Rohde & Schwarz	ENV216	100055	Apr. 23, 2014	1 Year
2.	EMI Test Receiver	Rohde & Schwarz	ESCI	100627	Apr. 23, 2014	1 Year
3.	RF Switching Unit	Compliance Direction	RSU-M2	38303	Apr. 23, 2014	1 Year

3.7. Power Line Conducted Emission Measurement Results

PASS.

The frequency range from 150KHz to 30 MHz is investigated.

The EUT was tested on (WiFi Mode, RJ45 Mode) modes, only the worst data of (WiFi Mode) is attached in the following pages.

CONDUCTED EMISSION TEST DATA

Test Site: 1# Shielded Room
 Operating Condition: WiFi Mode
 Test Specification: AC 120V/60Hz for Adapter
 Comment: Live Line
 Tem:25°C Hum:50%

SCAN TABLE: "Voltage (150K~30M) FIN"

Short Description: 150K-30M Disturbance Voltages

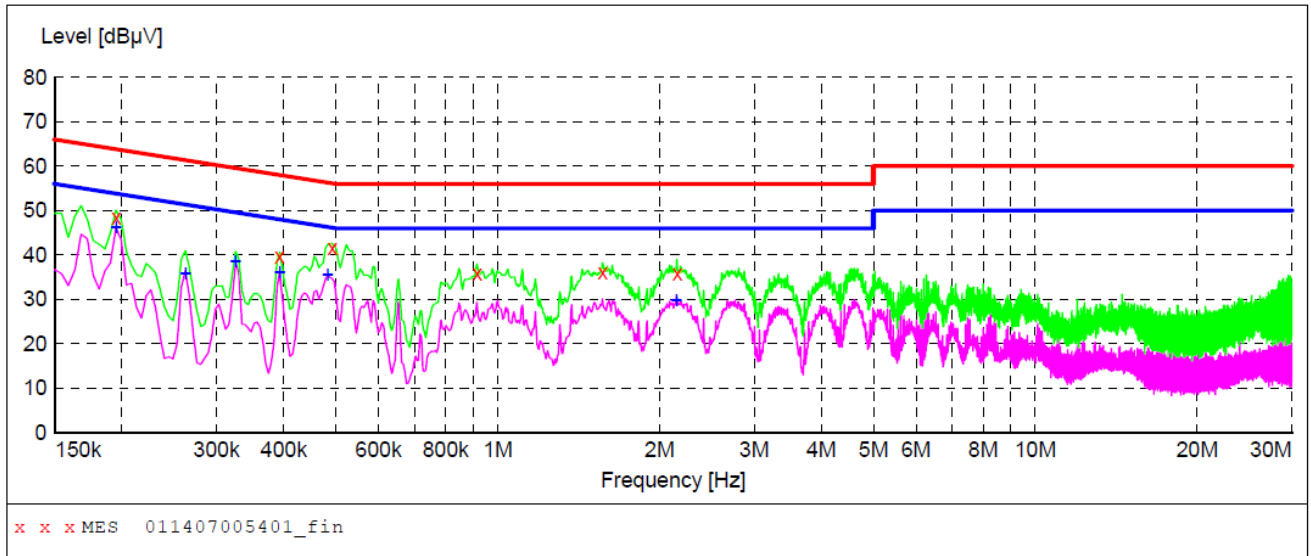

MEASUREMENT RESULT: "011407005401_fin"

7/12/2014 9:06AM

Frequency MHz	Level dBµV	Transd dB	Limit dBµV	Margin dB	Detector	Line	PE
0.195000	48.40	20.1	64	15.4	QP	L1	GND
0.393000	39.50	20.1	58	18.5	QP	L1	GND
0.492000	41.60	20.1	56	14.5	QP	L1	GND
0.915000	35.80	20.1	56	20.2	QP	L1	GND
1.567000	36.10	20.3	56	19.9	QP	L1	GND
2.156500	35.90	20.3	56	20.1	QP	L1	GND

MEASUREMENT RESULT: "011407005401_fin2"

7/12/2014 9:06AM

Frequency MHz	Level dBµV	Transd dB	Limit dBµV	Margin dB	Detector	Line	PE
0.195000	46.20	20.1	54	7.6	AV	L1	GND
0.262500	35.80	20.1	51	15.6	AV	L1	GND
0.325500	38.50	20.1	50	11.1	AV	L1	GND
0.393000	36.00	20.1	48	12.0	AV	L1	GND
0.483000	35.50	20.1	46	10.8	AV	L1	GND
2.152000	29.90	20.3	46	16.1	AV	L1	GND

CONDUCTED EMISSION TEST DATA

Test Site: 1# Shielded Room
 Operating Condition: WiFi Mode
 Test Specification: AC 120V/60Hz for Adapter
 Comment: Neutral Line
 Tem:25°C Hum:50%

SCAN TABLE: "Voltage (150K~30M) FIN"

Short Description: 150K-30M Disturbance Voltages

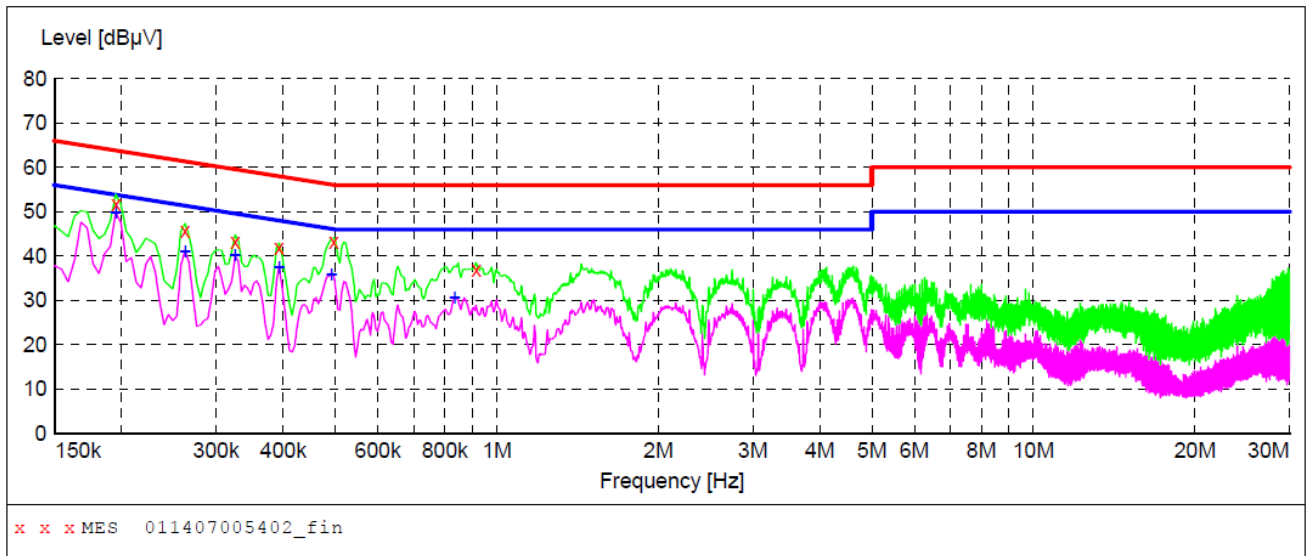

MEASUREMENT RESULT: "011407005402_fin"

7/12/2014 9:11AM

Frequency MHz	Level dBµV	Transd dB	Limit dBµV	Margin dB	Detector	Line	PE
0.195000	51.80	20.1	64	12.0	QP	N	GND
0.262500	45.70	20.1	61	15.7	QP	N	GND
0.325500	43.30	20.1	60	16.3	QP	N	GND
0.393000	41.90	20.1	58	16.1	QP	N	GND
0.496500	43.30	20.1	56	12.8	QP	N	GND
0.915000	36.80	20.1	56	19.2	QP	N	GND

MEASUREMENT RESULT: "011407005402_fin2"

7/12/2014 9:11AM

Frequency MHz	Level dBµV	Transd dB	Limit dBµV	Margin dB	Detector	Line	PE
0.195000	49.90	20.1	54	3.9	AV	N	GND
0.262500	41.10	20.1	51	10.3	AV	N	GND
0.325500	40.20	20.1	50	9.4	AV	N	GND
0.393000	37.60	20.1	48	10.4	AV	N	GND
0.492000	35.90	20.1	46	10.2	AV	N	GND
0.834000	30.60	20.1	46	15.4	AV	N	GND

4. FCC Part 15.247 Requirements for DSSS & OFDM Modulation

4.1 Test Setup

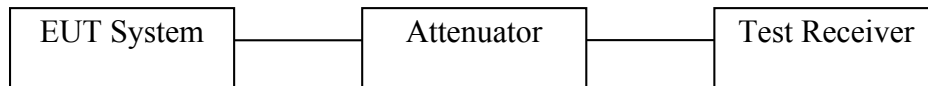

4.2 6dB Bandwidth

a. Limit

For the direct sequence systems, the minimum 6dB bandwidth shall be at least 500kHz.

b. Test Procedure

1. Place the EUT on the table and set it in the transmitting mode.
2. Remove the antenna from the EUT and then connect a low loss RF cable from the antenna port to the spectrum analyzer.
3. Set the spectrum analyzer as:
 RBW = 100kHz, VBW \geq 3*RBW = 300kHz,
 Detector= Peak
 Trace mode= Max hold.
 Sweep- auto couple.
4. Mark the peak frequency and -6dB (upper and lower) frequency.
5. Repeat until all the rest channels are investigated.

c. Test Setup See 4.1

d. Test Equipment

Item	Equipment	Manufacturer	Model No.	Serial No.	Last Cal.	Cal. Interval
1.	Spectrum Analysis	Agilent	E4407B	US39390582	Aug. 09, 2014	1 Year
2.	Preamplifier	Instruments corporation	EMC011830	980100	Aug. 09, 2014	1 Year
3.	EMI Test Receiver	Rohde & Schwarz	ESPI	101604	Apr. 23, 2014	1 Year
4.	Double Ridged Horn Antenna	Instruments corporation	GTH-0118	351600	Aug. 09, 2013	3 Year
5.	EMI Test Software EZ-EMC	SHURPLE	N/A	N/A	N/A	N/A

e. Test Results

Pass.

f. Test Data

Test mode: IEEE 802.11b

Channel	Frequency (MHz)	Bandwidth (MHz)	Limit (kHz)	Results
Low	2412	11.704		Pass
Mid	2437	11.704	>500	Pass
High	2462	11.704		Pass

Test mode: IEEE 802.11g

Channel	Frequency (MHz)	Bandwidth (MHz)	Limit (kHz)	Results
Low	2412	16.500		Pass
Mid	2437	16.500	>500	Pass
High	2462	16.500		Pass

Test mode: IEEE 802.11n (HT20)

Channel	Frequency (MHz)	Bandwidth (MHz)	Limit (kHz)	Results
Low	2412	17.688		Pass
Mid	2437	17.688	>500	Pass
High	2462	17.688		Pass

Test mode: IEEE 802.11n (HT40)

Channel	Frequency (MHz)	Bandwidth (MHz)	Limit (kHz)	Results
Low	2422	36.432		Pass
Mid	2437	36.432	>500	Pass
High	2452	36.432		Pass

Test Plots See the following page.

Test Mode: 802.11b---Low

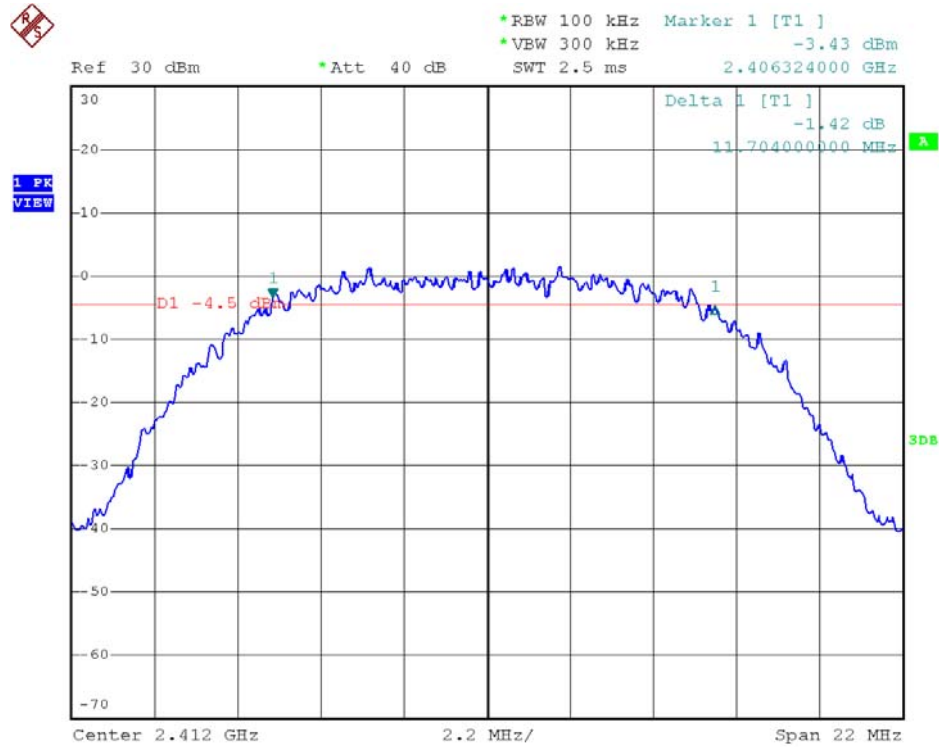

Test Mode: 802.11b---Mid

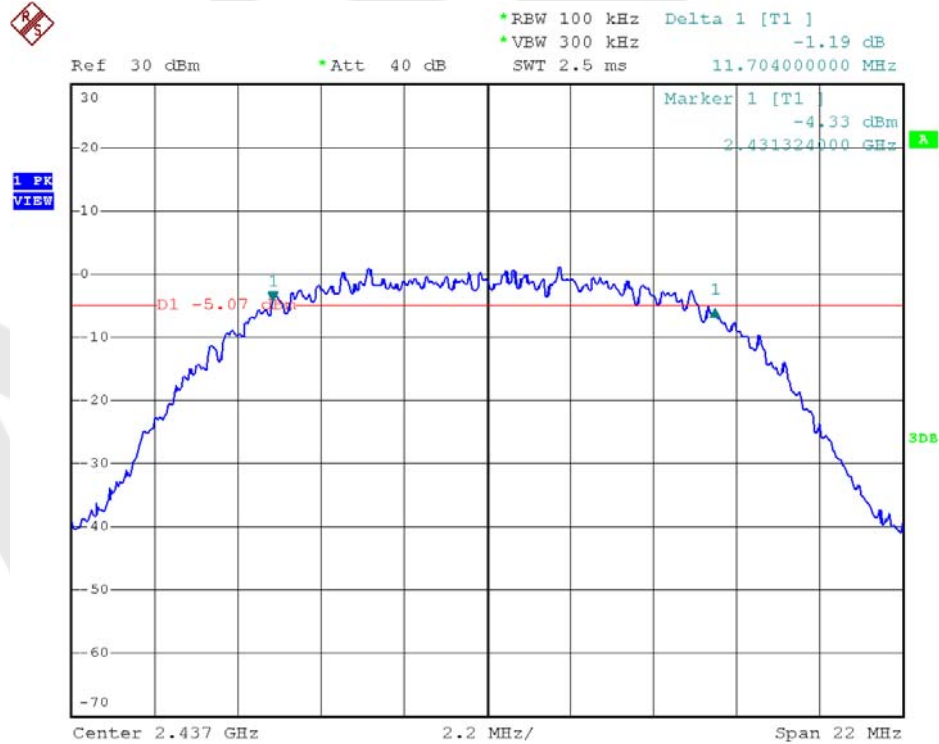

Test Mode: 802.11b---High

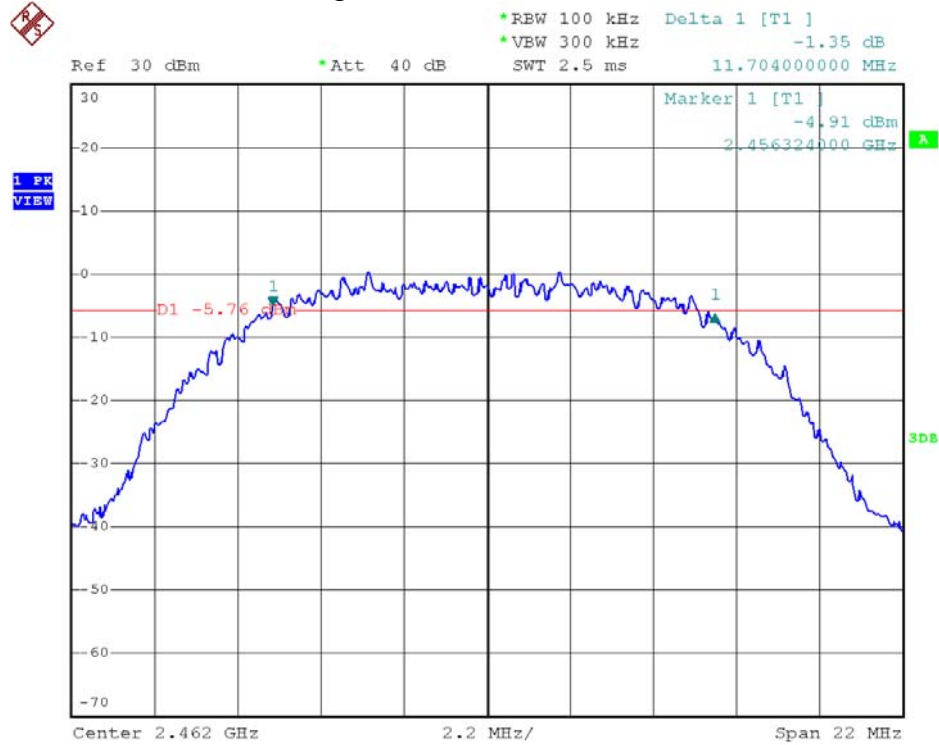

Test Mode: 802.11g---Low

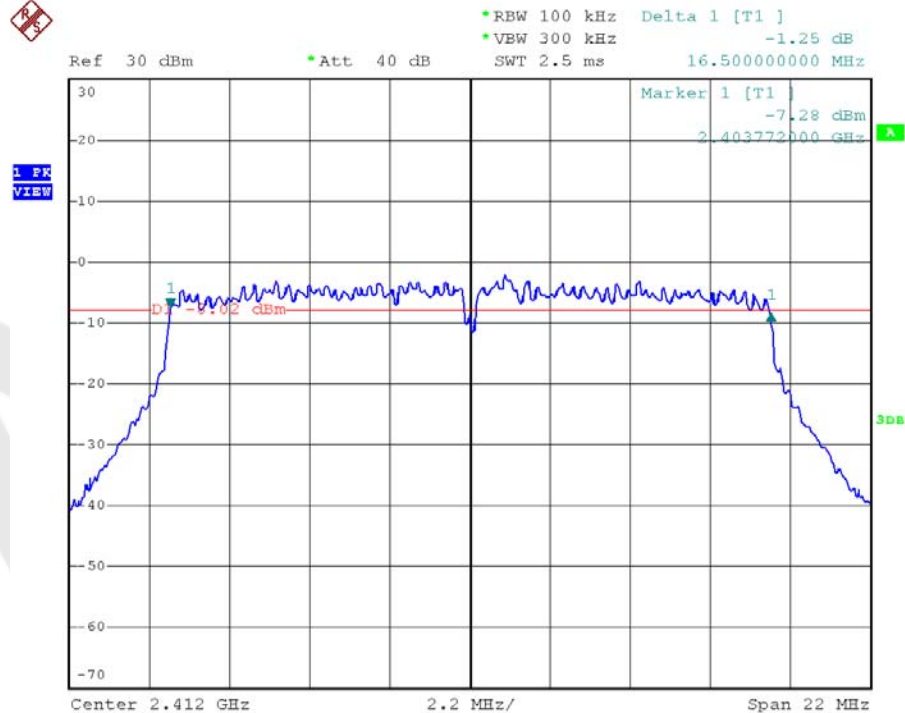

Test Mode: 802.11g---Mid

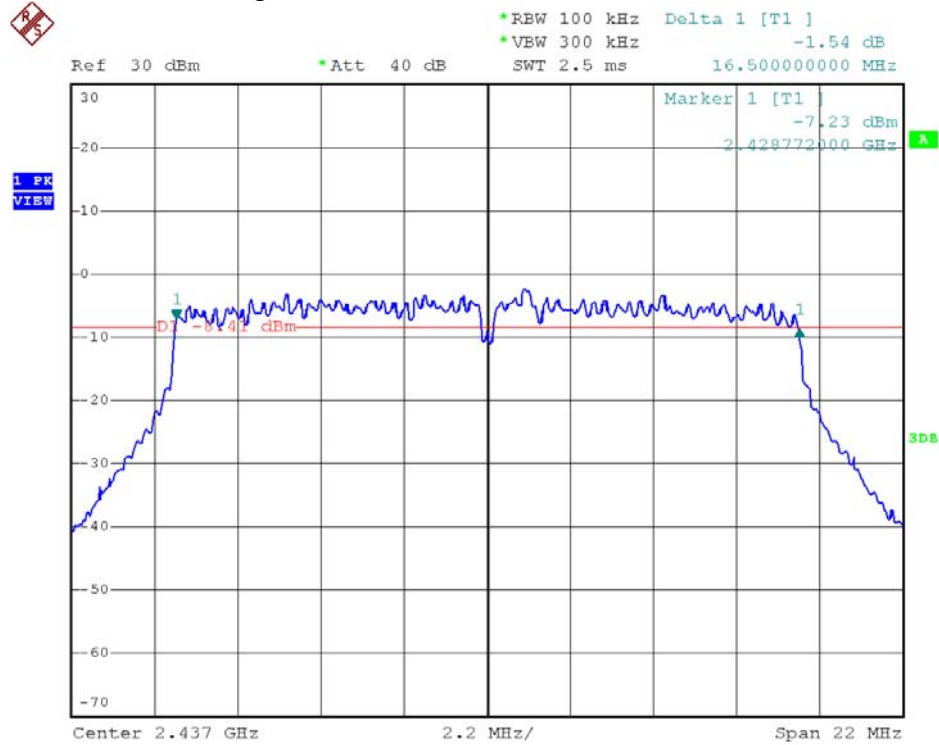

Test Mode: 802.11g---High

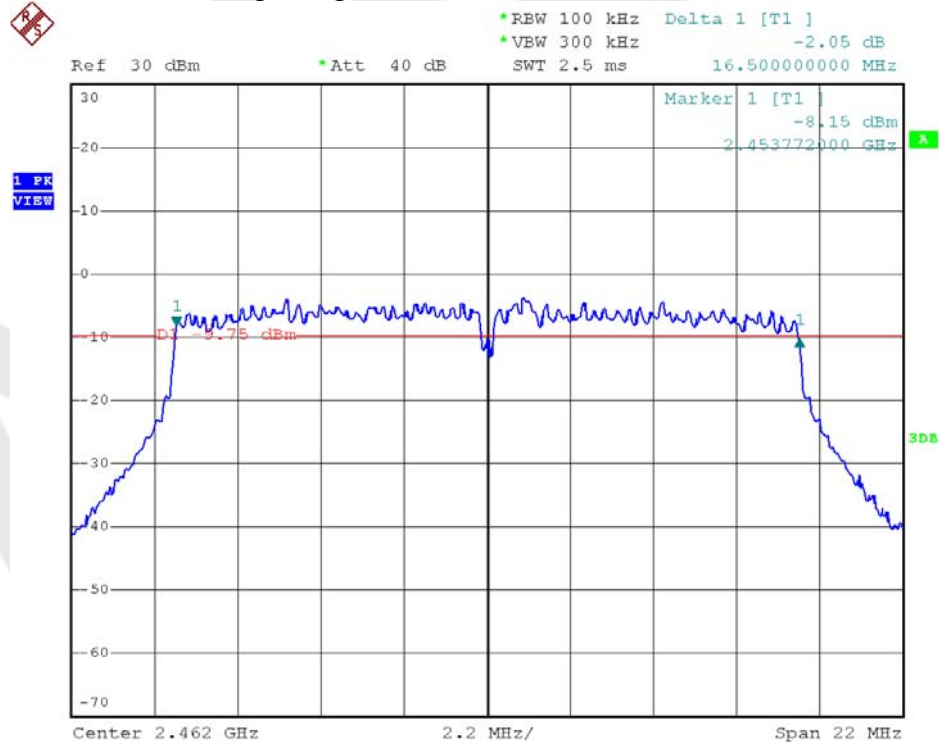

Test Mode: 802.11n (HT20)---Low

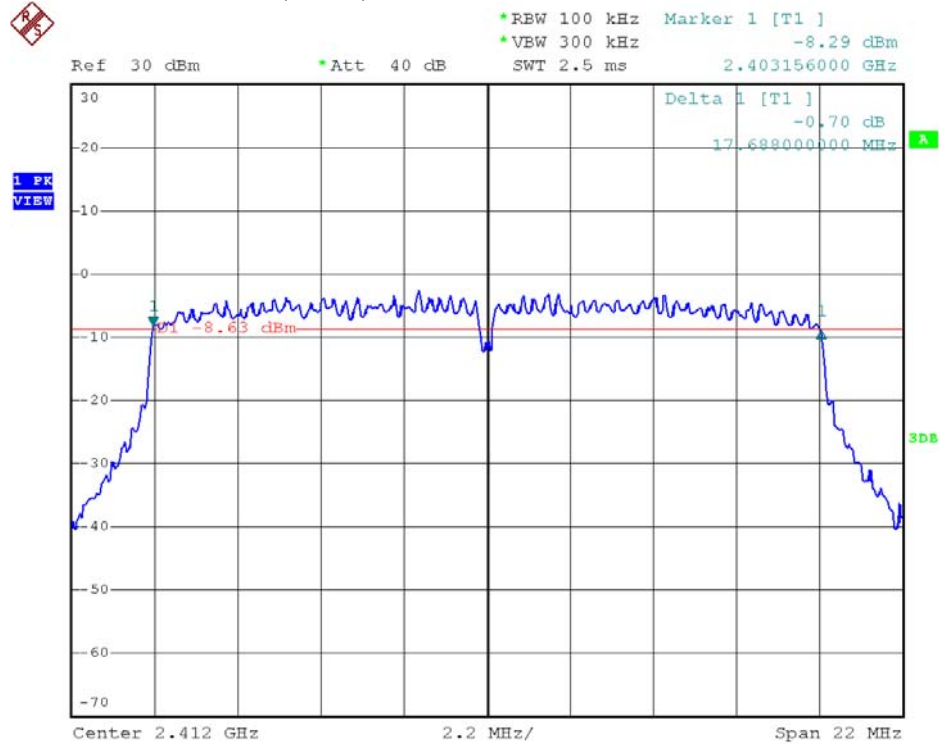

Test Mode: 802.11n (HT20)---Mid

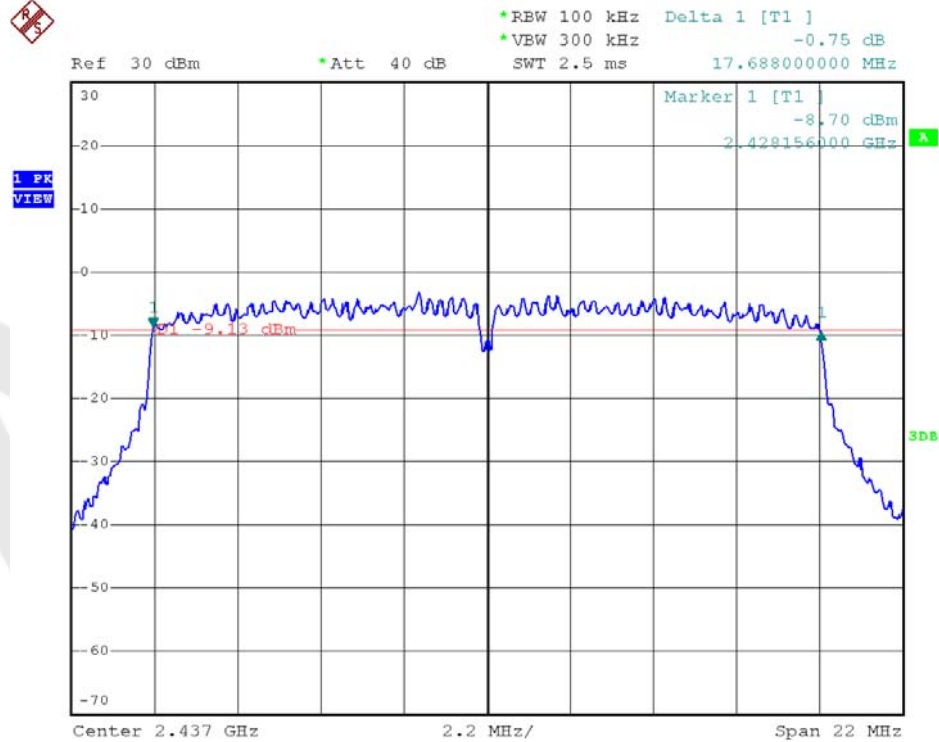

Test Mode: 802.11n (HT20)---High

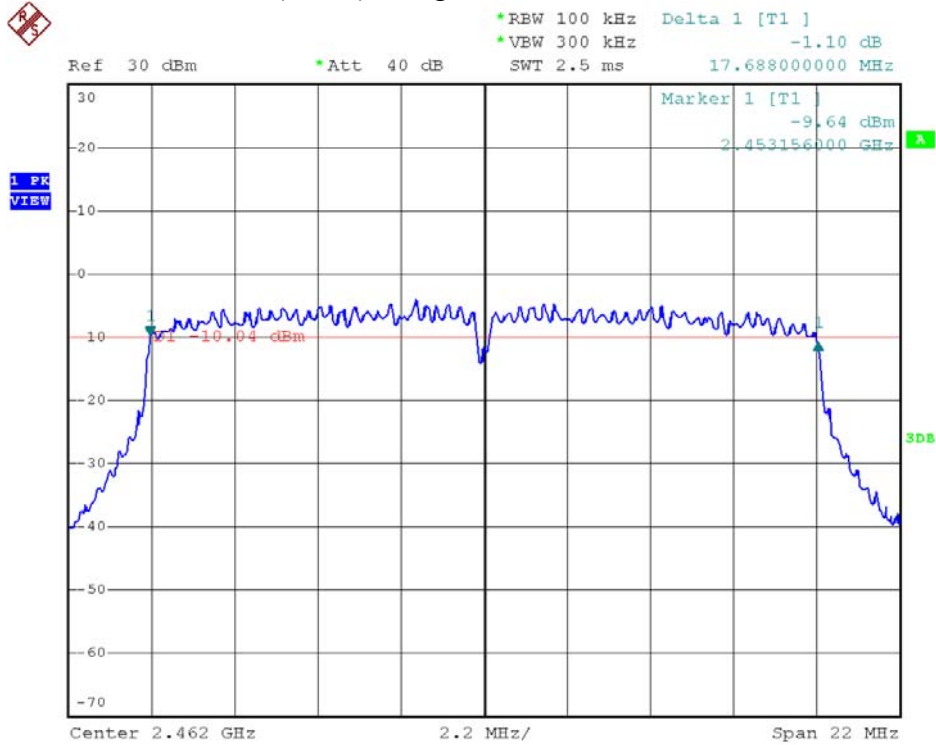

Test Mode: 802.11n (HT40)---Low

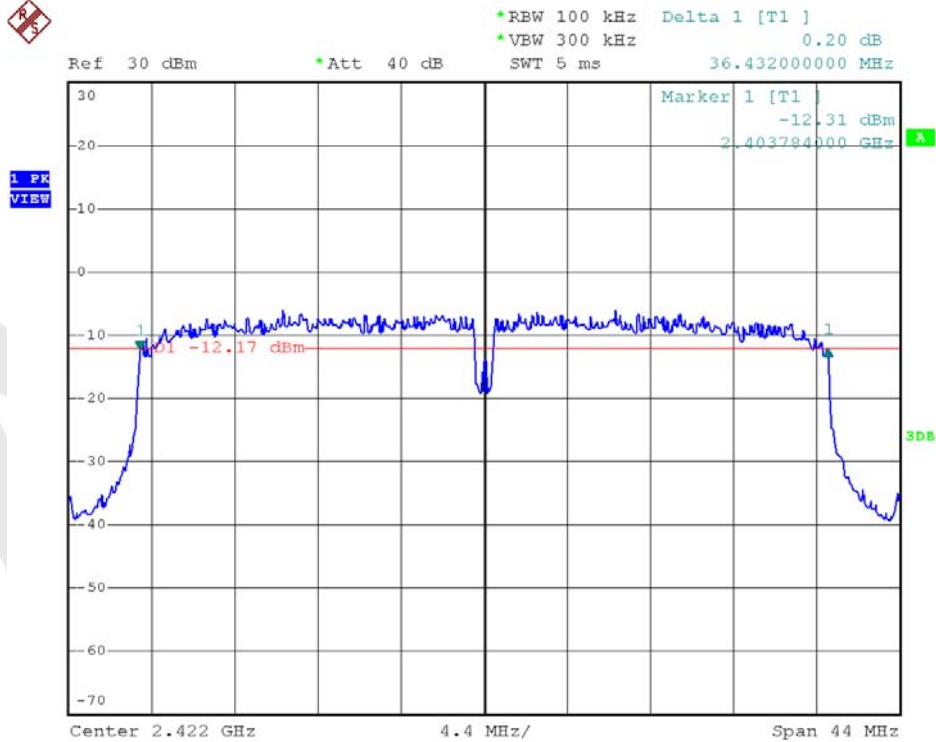

Test Mode: 802.11n (HT40)---Mid

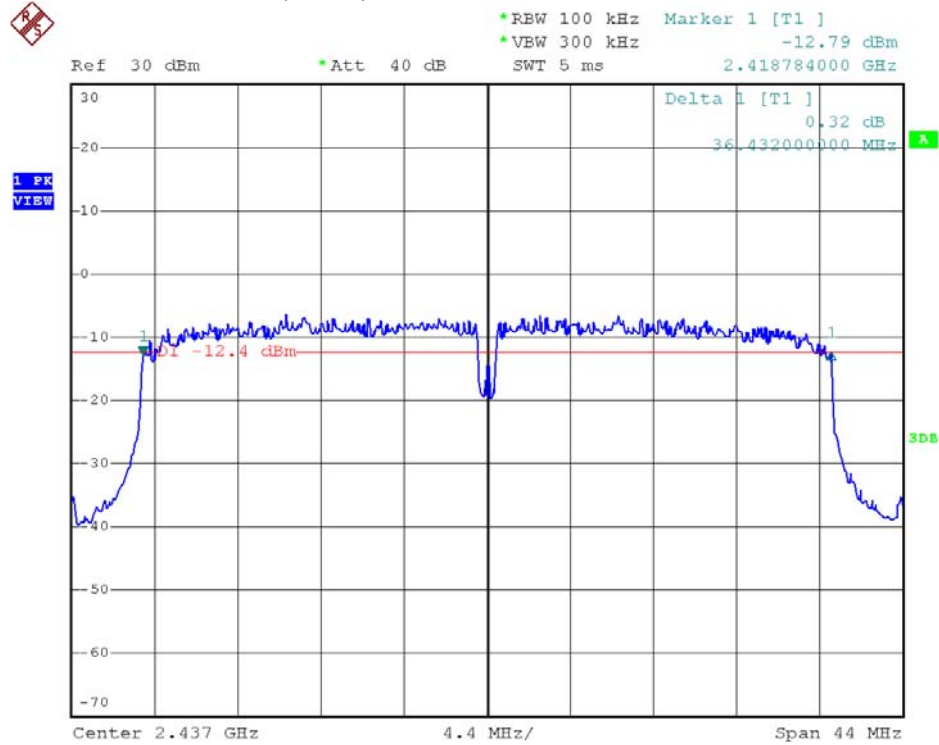

Test Mode: 802.11n (HT40)---High

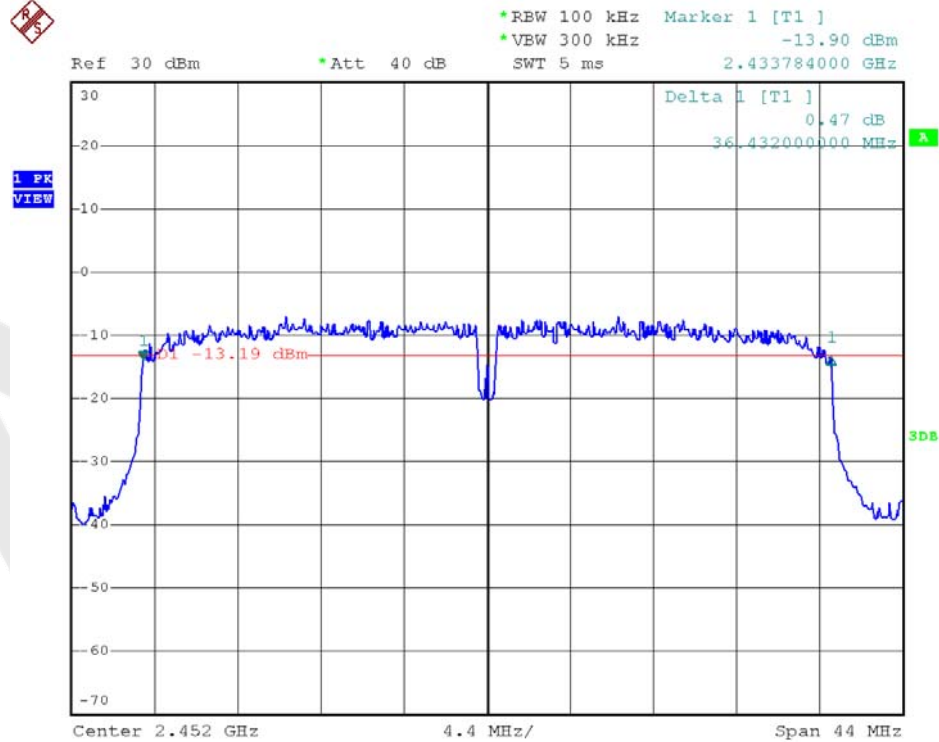

4.3. Maximum Peak output power test

a. Limit

The maximum peak output power of the intentional radiator shall not exceed the following:

1. For systems using digital modulation in the bands of 902-928 MHz, 2400-2483.5 MHz, and 5725-5850 MHz: 1 watt (30dBm).
2. Except as shown in paragraphs (b)(3) (i), (ii) and (iii) of this section, if transmitting antenna of directional gain greater than 6 dBi are used the peak output power from the intentional radiator shall be reduced below the stated values in paragraphs (b)(1) or (b)(2) of this section, as appropriate, by the amount in dB that the directional gain of the antenna exceeds 6 dBi.

b. Configuration of Measurement

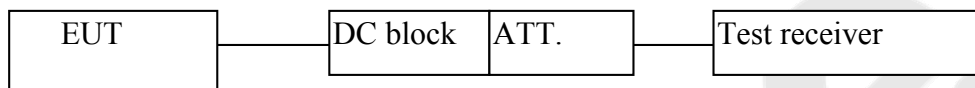

c. Data Rates

IEEE802.11b: Channel 1(2412MHz), Channel 6(2437MHz) and Channel 11(2462MHz) with 1 Mbps data rate (worst case) are chosen for the final testing.

IEEE802.11g: Channel 1(2412MHz), Channel 6(2437MHz) and Channel 11(2462MHz) with 6 Mbps data rate (the worst case) are chosen for the final testing.

IEEE802.11n (HT20: Channel 1(2412MHz), Channel 6(2437MHz) and Channel 11(2462MHz) with 6.5Mbps data rate (the worst case) are chosen for the final testing.

IEEE802.11n (HT40: Channel 3(2422MHz), Channel 6(2437MHz) and Channel 9(2452MHz) with 13.5Mbps data rate (the worst case) are chosen for the final testing.

d. Test Procedure

This test was according the kDB 558074 9.1.2:

1. This procedure may be used when the maximum available RBW of the measurement instrument is less than the DTS bandwidth.
2. Set the RBW = 1 MHz.
3. Set the VBW $\geq 3 * RBW = 3$ MHz.
4. Set the span $\geq 1.5 * DTS$ bandwidth.
5. Detector = peak.
6. Sweep time = auto couple.
7. Trace mode = max hold.
8. Allow trace to fully stabilize.
9. Use the instrument's band/channel power measurement function with the band limits set equal to the DTS bandwidth edges (for some instruments, this may require a manual override to select peak detector). If the instrument does not have a band power function, sum the spectrum levels (in linear power units) at intervals equal to the RBW extending across the DTS bandwidth.

e. Test Equipment

Same as the equipment listed in 4.2.

f. Test Results

Pass.

g. Test Data

Test mode: IEEE 802.11b

Channel	Frequency (MHz)	Maximum transmit power (dBm)	Limit		Result
			(dBm)	(watts)	
Low	2412	19.24	30	1	Pass
Mid	2437	18.80			Pass
High	2462	17.88			Pass

Test mode: IEEE 802.11g

Channel	Frequency (MHz)	Maximum transmit power (dBm)	Limit		Result
			(dBm)	(watts)	
Low	2412	18.97	30	1	Pass
Mid	2437	18.50			Pass
High	2462	17.40			Pass

Test mode: IEEE 802.11n (HT20)

Channel	Frequency (MHz)	Maximum transmit power (dBm)	Limit		Result
			(dBm)	(watts)	
Low	2412	18.56	30	1	Pass
Mid	2437	18.12			Pass
High	2462	17.16			Pass

Test mode: IEEE 802.11n (HT40)

Channel	Frequency (MHz)	Maximum transmit power (dBm)	Limit		Result
			(dBm)	(watts)	
Low	2422	17.82	30	1	Pass
Mid	2437	18.13			Pass
High	2452	17.41			Pass

Test Mode: 802.11b---Low



Ref 30 dBm *Att 40 dB *RBW 1 MHz *VBW 3 MHz SWT 2.5 ms Marker 1 [T1]
10.33 dBm
2.412960000 GHz

1 PK
MAXH

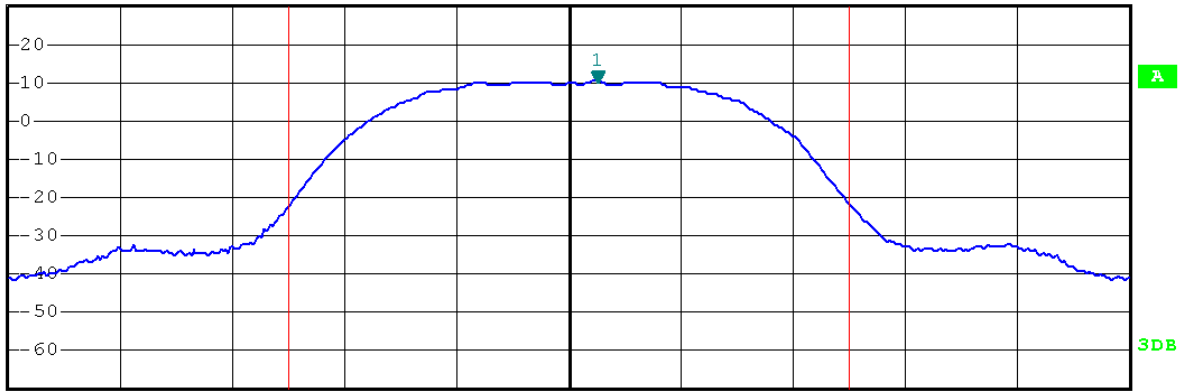

Center 2.412 GHz 4 MHz/ Span 40 MHz

Tx Channel
Bandwidth 20 MHz Power 19.24 dBm

Test Mode: 802.11b---Mid



Ref 30 dBm *Att 40 dB *RBW 1 MHz *VBW 3 MHz SWT 2.5 ms Marker 1 [T1]
9.89 dBm
2.438040000 GHz

1 PK
MAXH

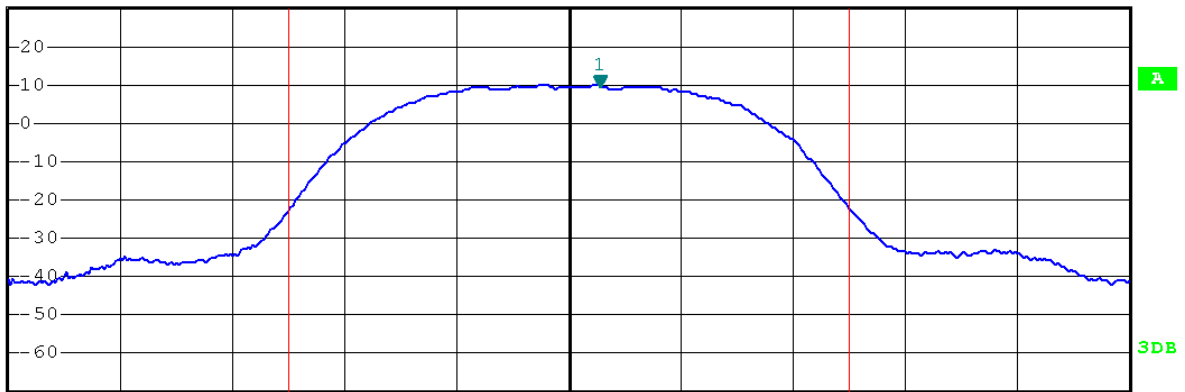

Center 2.437 GHz 4 MHz/ Span 40 MHz

Tx Channel
Bandwidth 20 MHz Power 18.80 dBm

Test Mode: 802.11b---High



Ref 30 dBm *Att 40 dB *RBW 1 MHz *VBW 3 MHz SWT 2.5 ms Marker 1 [T1]
8.97 dBm
2.463040000 GHz

1 PK
MAXH

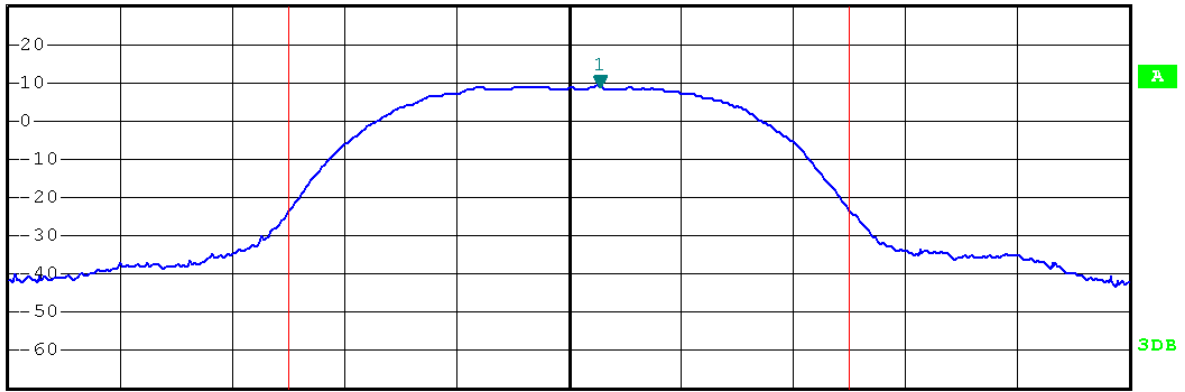

Center 2.462 GHz 4 MHz/ Span 40 MHz

Tx Channel
Bandwidth 20 MHz Power 17.88 dBm

Test Mode: 802.11g---Low



Ref 30 dBm *Att 40 dB *RBW 1 MHz *VBW 3 MHz SWT 2.5 ms Marker 1 [T1]
9.25 dBm
2.417280000 GHz

1 PK
MAXH

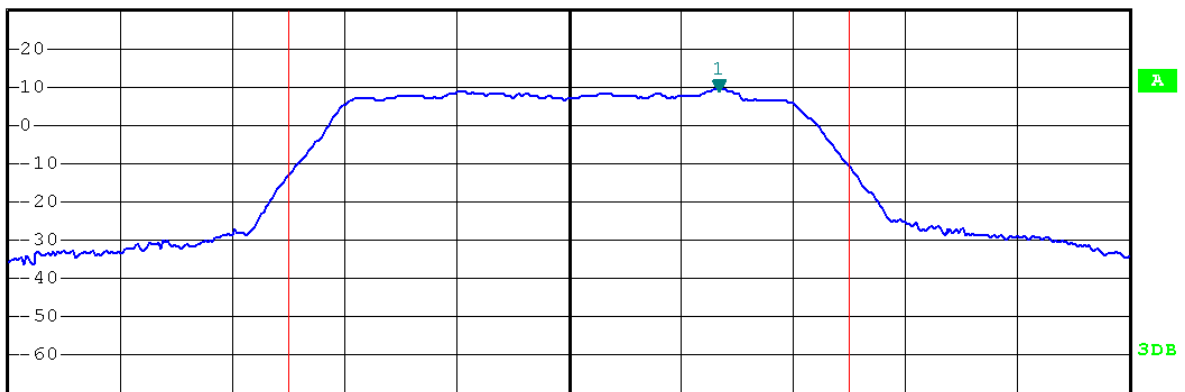

Center 2.412 GHz 4 MHz/ Span 40 MHz

Tx Channel
Bandwidth 20 MHz Power 18.97 dBm

Test Mode: 802.11g---Mid



*RBW 1 MHz
*VBW 3 MHz
SWT 2.5 ms
Marker 1 [T1]
8.81 dBm
2.442360000 GHz

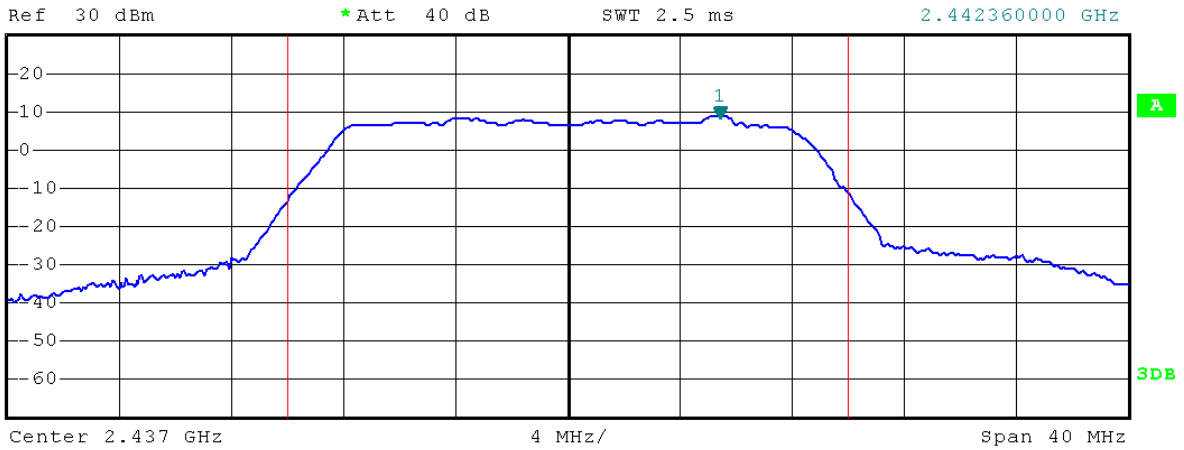

Tx Channel
Bandwidth 20 MHz Power 18.50 dBm

Test Mode: 802.11g---High



*RBW 1 MHz
*VBW 3 MHz
SWT 2.5 ms
Marker 1 [T1]
7.59 dBm
2.467440000 GHz

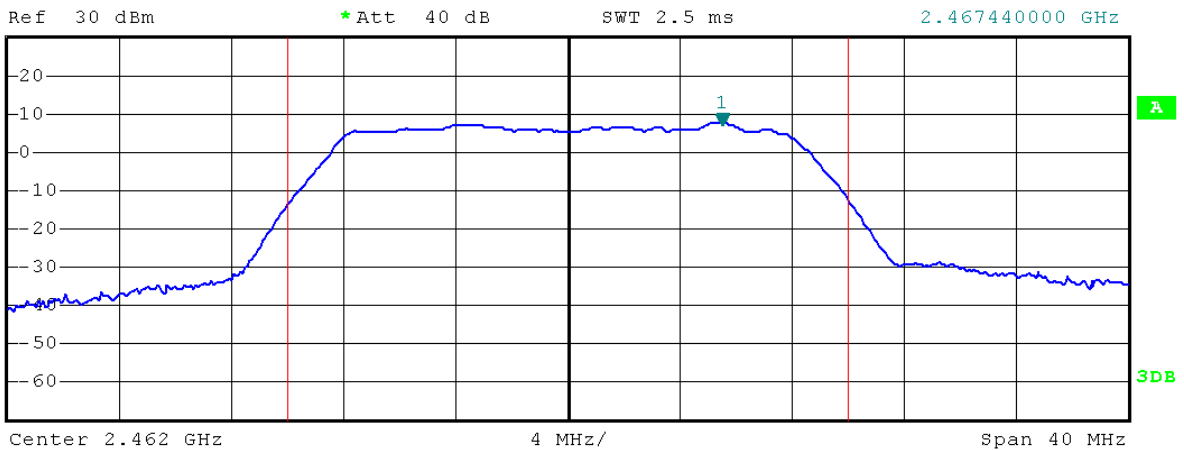

Tx Channel
Bandwidth 20 MHz Power 17.40 dBm

Test Mode: 802.11n(HT20)---Low



*RBW 1 MHz
*VBW 3 MHz
SWT 2.5 ms
Marker 1 [T1]
8.39 dBm
2.413760000 GHz

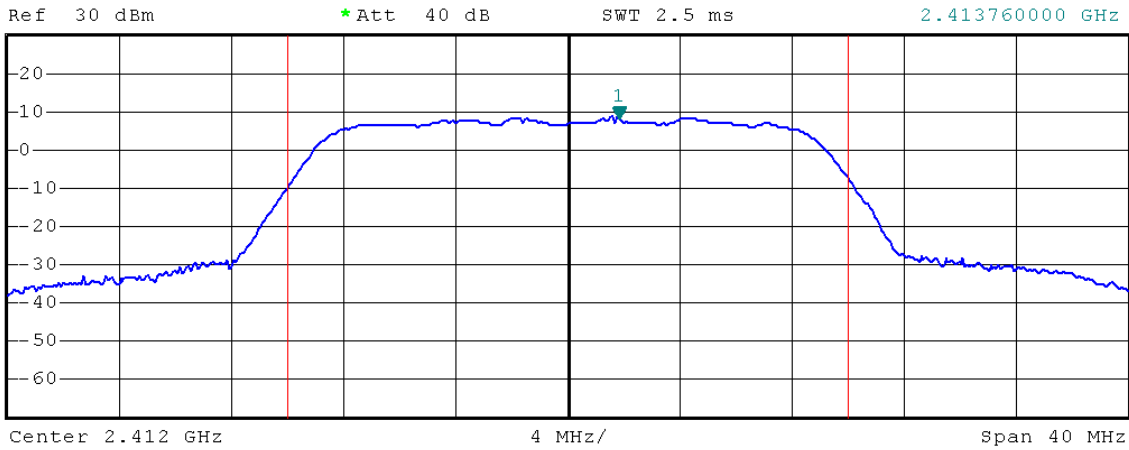

1 PK
MAXH

A

3DB

Tx Channel
Bandwidth 20 MHz Power 18.56 dBm

Test Mode: 802.11n(HT20)---Mid



*RBW 1 MHz
*VBW 3 MHz
SWT 2.5 ms
Marker 1 [T1]
8.20 dBm
2.438600000 GHz

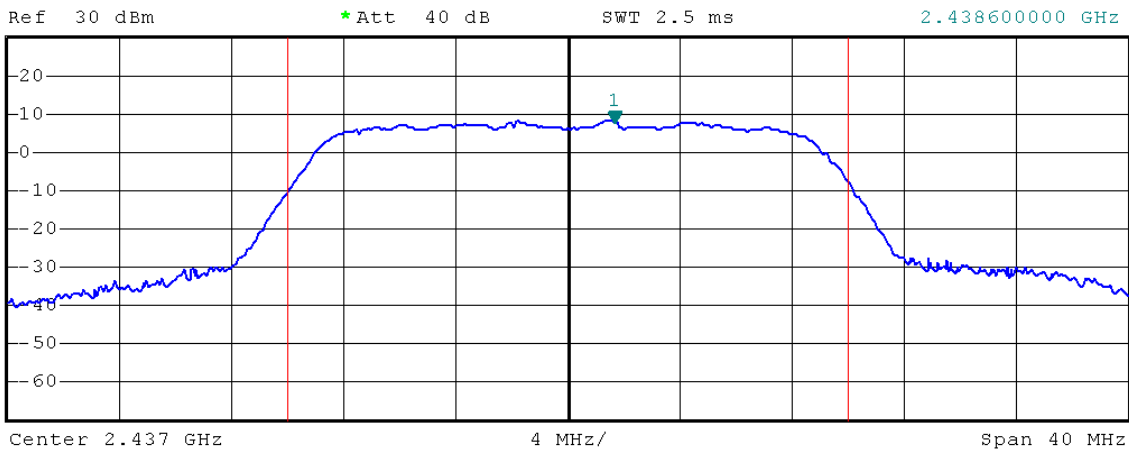

1 PK
MAXH

A

3DB

Tx Channel
Bandwidth 20 MHz Power 18.12 dBm

Test Mode: 802.11n(HT20)---High



*RBW 1 MHz
*VBW 3 MHz
SWT 2.5 ms
Marker 1 [T1]
7.08 dBm
2.463440000 GHz

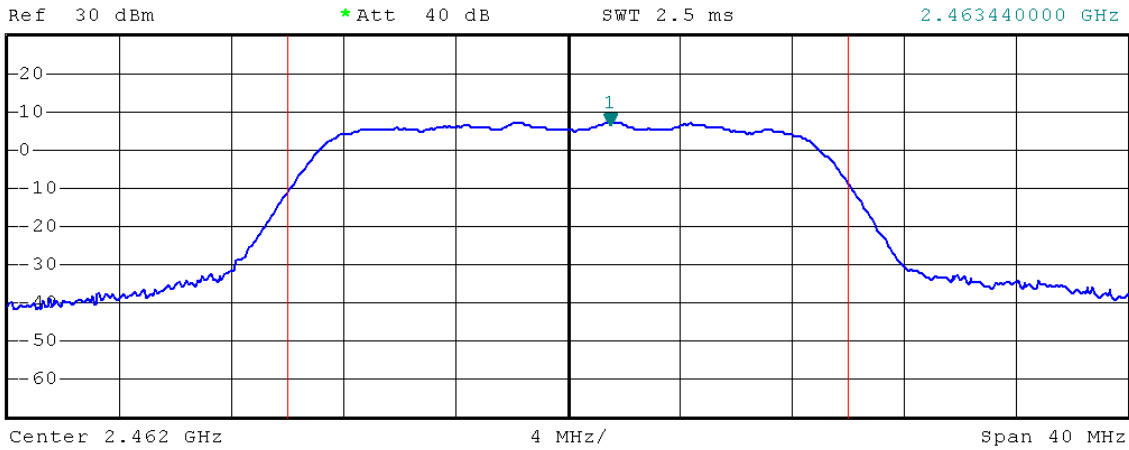

Tx Channel
Bandwidth 20 MHz Power 17.16 dBm

Test Mode: 802.11n(HT40)---Low



*RBW 1 MHz
*VBW 3 MHz
SWT 2.5 ms
Marker 1 [T1]
4.71 dBm
2.411760000 GHz

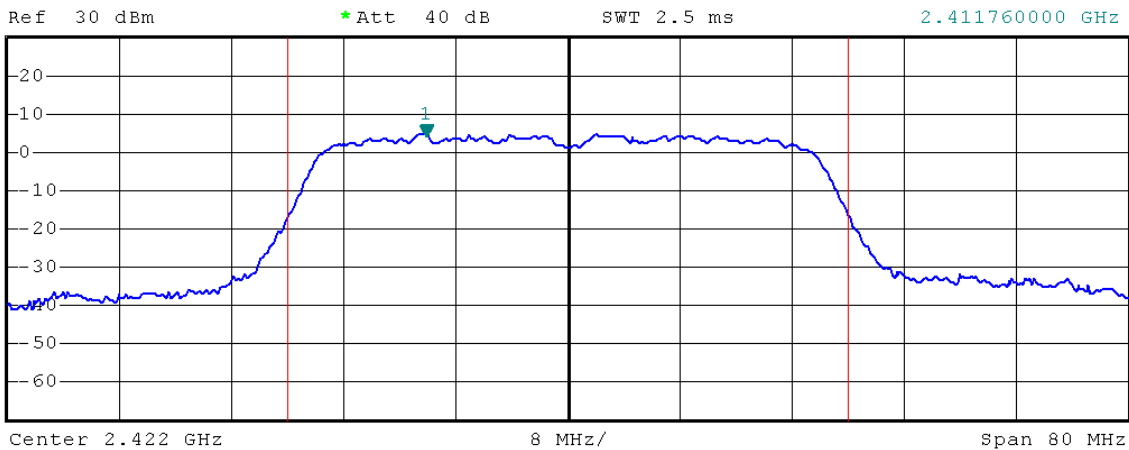

Tx Channel
Bandwidth 40 MHz Power 17.82 dBm

Test Mode: 802.11n(HT40)---Mid



* RBW 1 MHz
* VBW 3 MHz
SWT 2.5 ms
Marker 1 [T1]
5.15 dBm
2.426600000 GHz

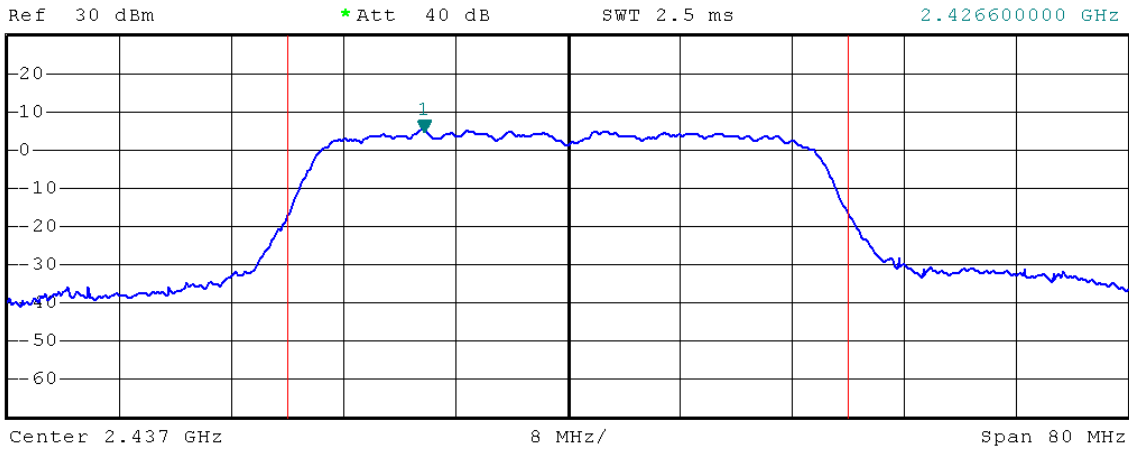

Tx Channel
Bandwidth 40 MHz Power 18.13 dBm

Test Mode: 802.11n(HT40)---High



* RBW 1 MHz
* VBW 3 MHz
SWT 2.5 ms
Marker 1 [T1]
4.31 dBm
2.444960000 GHz

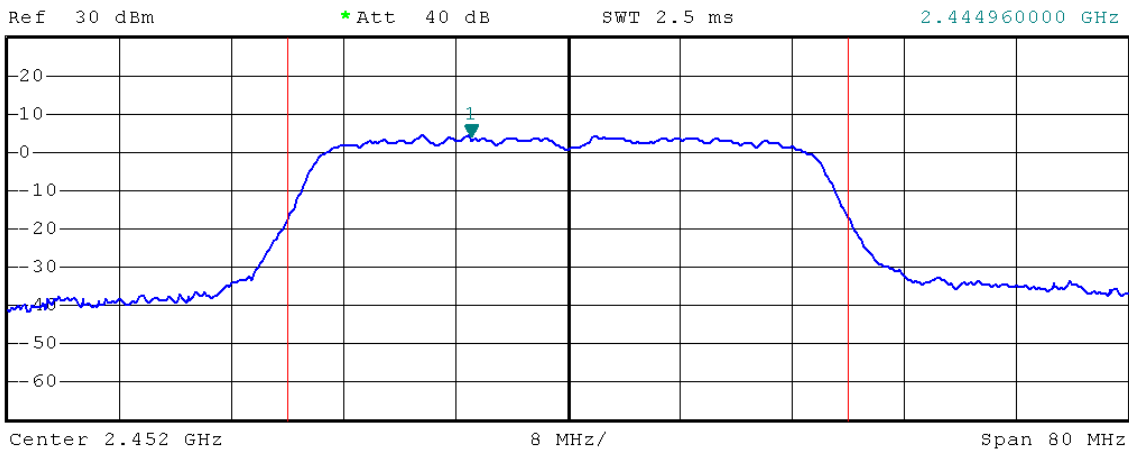

Tx Channel
Bandwidth 40 MHz Power 17.41 dBm

4.4. Band Edges Measurement

a. Limit

According to §15.247(c), in any 100 kHz bandwidth outside the frequency bands in which the spread spectrum intentional radiator is operating, the radio frequency power that is produced by the intentional radiator shall be at least 20dB below that in the 100kHz bandwidth within the band that contains the highest level of the desired power. In addition, radiated emissions which fall in the restricted bands, as defined in §15.205(a), must also comply with the radiated emission limits specified in §15.209(a).

b. Test Procedure

1. Conducted Method:

- 1) Set RBW=100KHz, VBW=300KHz
- 2) Detector=peak
- 3) Sweep time= auto
- 4) Trace mode=max hold.

2. Radiated Method:

- 1) The EUT is placed on a turntable, which is 0.8m above the ground plane.
- 2) The turntable shall be rotated for 360 degrees to determine the position of maximum emission level.
- 3) EUT is set 3m away from the receiving antenna, which is varied from 1m to 4m to find out the highest emission.
- 4) Peak detector: RBW=1MHz, VBW=3MHz, SWT=AUTO
Average detector: RBW=1MHz, VBW=10Hz, SWT=AUTO
The EUT is tested in 9*6*6 Chamber.
- 5) Repeat the procedures until all the PEAK and AVERAGE versus POLARIZATION are measured.

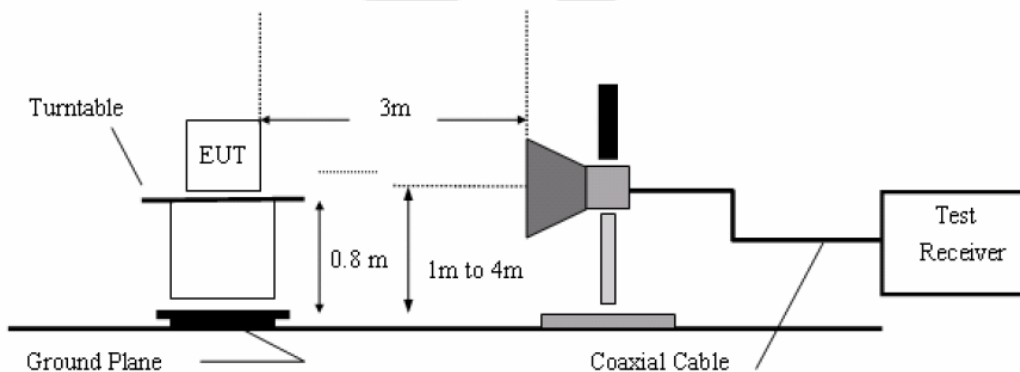

c. Test Equipment

Same as the equipment listed in 4.2.

d. Test Results

Pass.

e. Test Plots

See the following page.

Test Mode: 802.11b ---Low

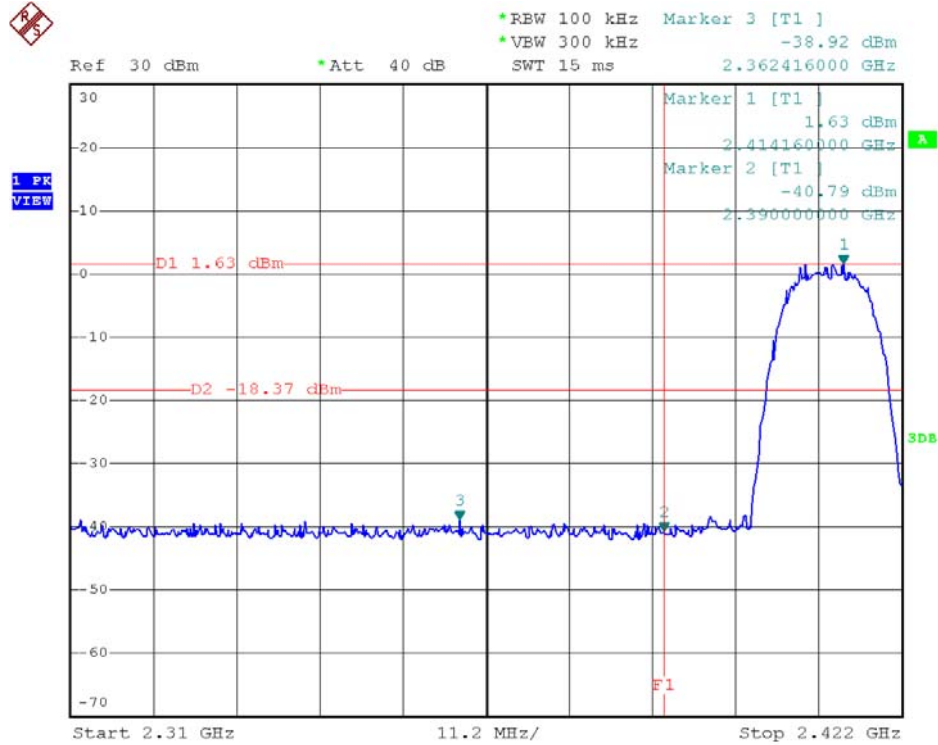

Test Mode: 802.11b ---High

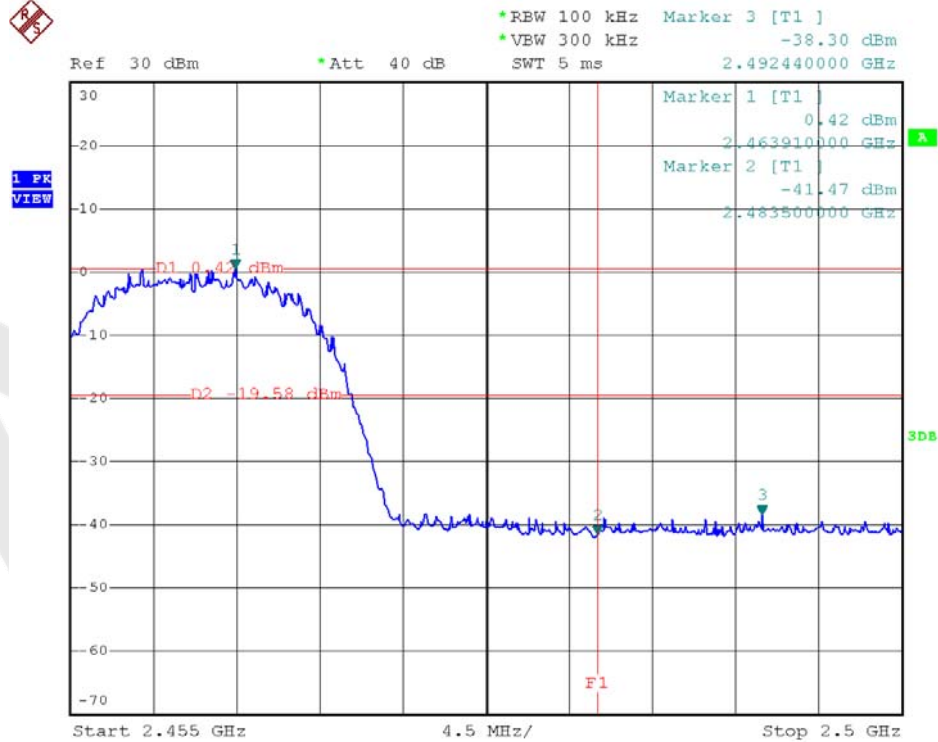

Test Mode: 802.11g ---Low

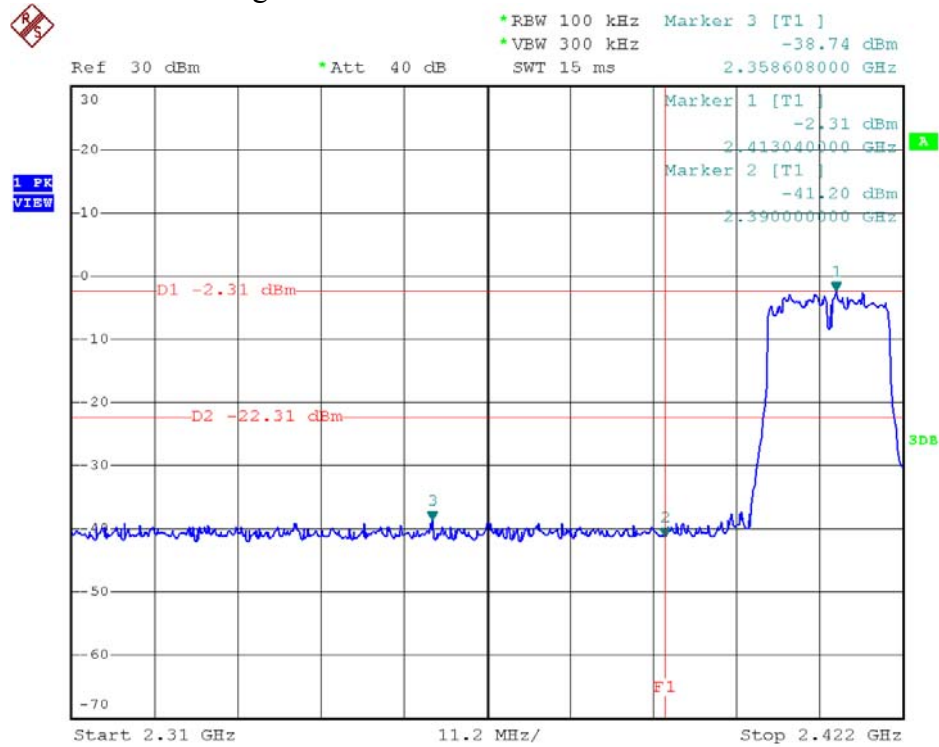

Test Mode: 802.11g ---High

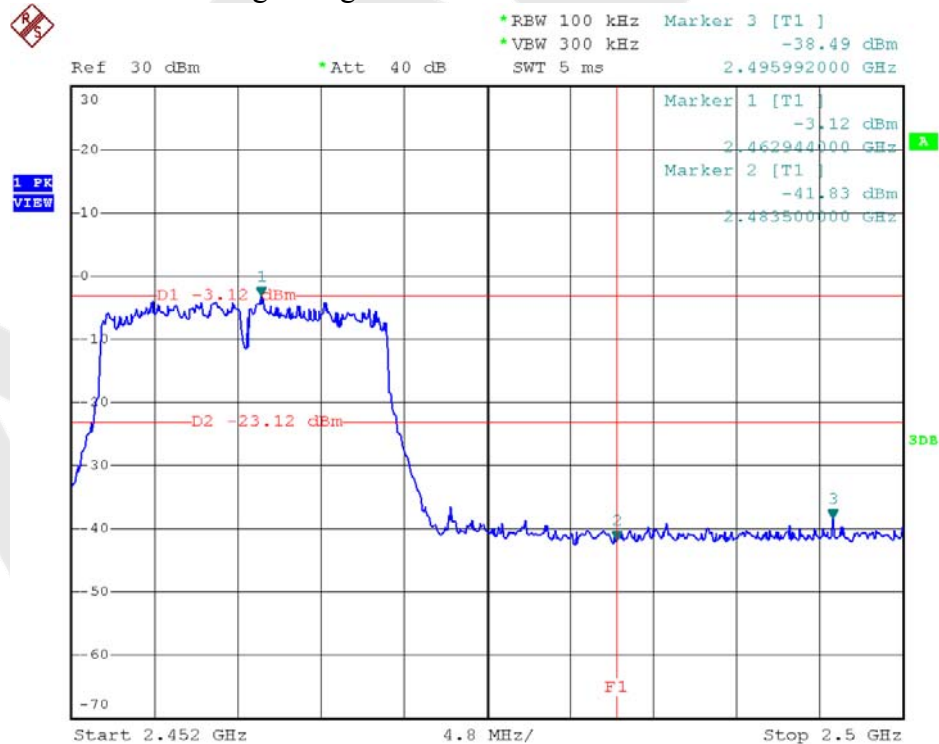

Test Mode: 802.11n (HT20) ---Low

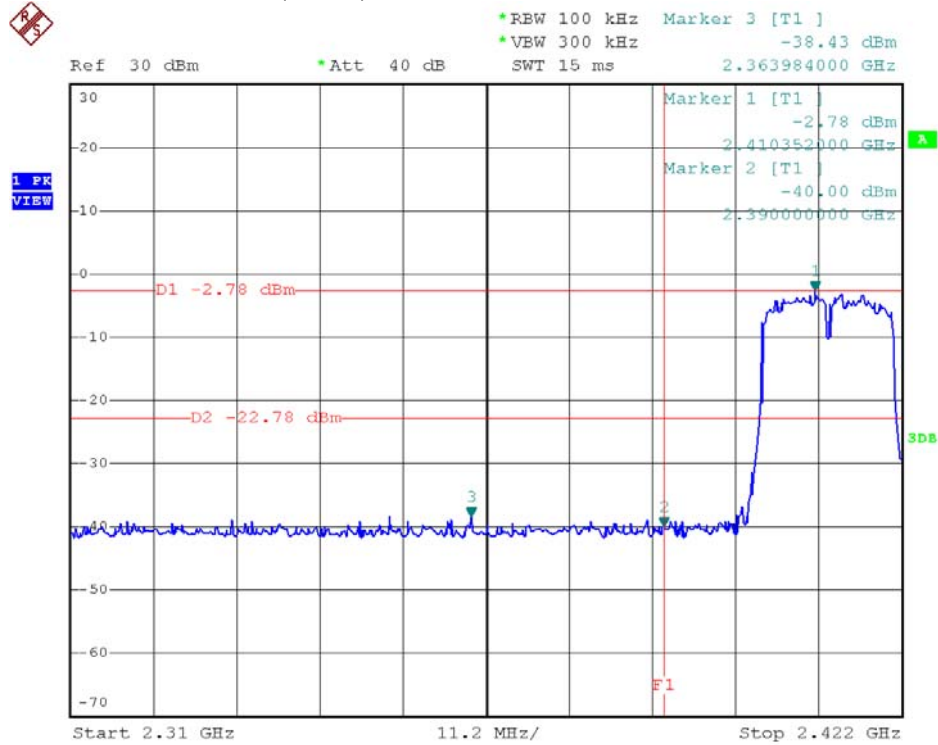

Test Mode: 802.11n (HT20)---High

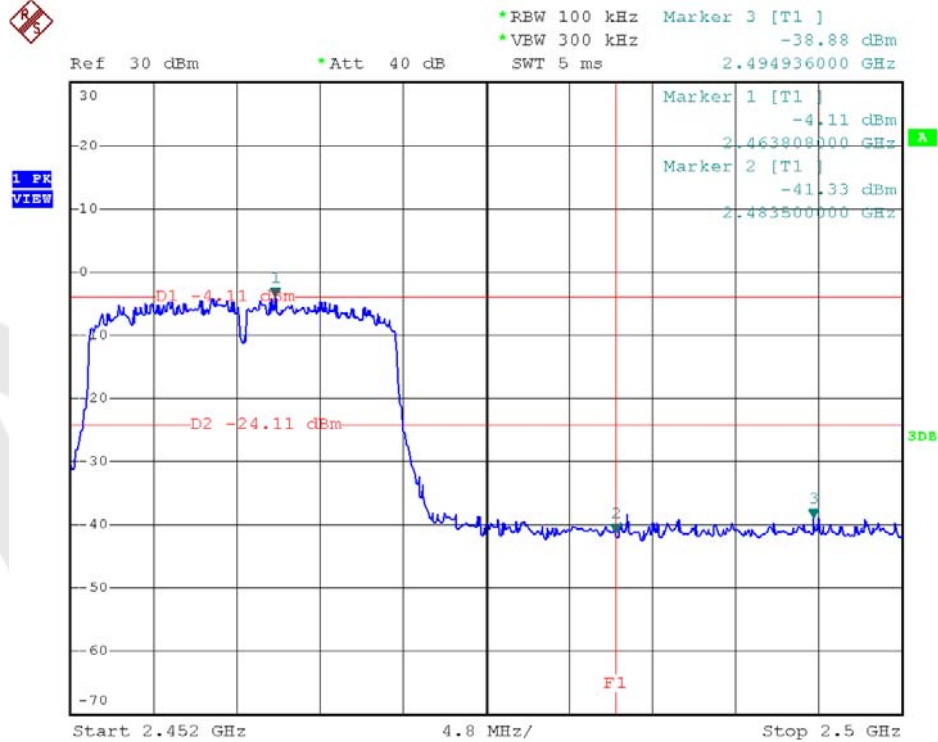

Test Mode: 802.11n (HT40) ---Low

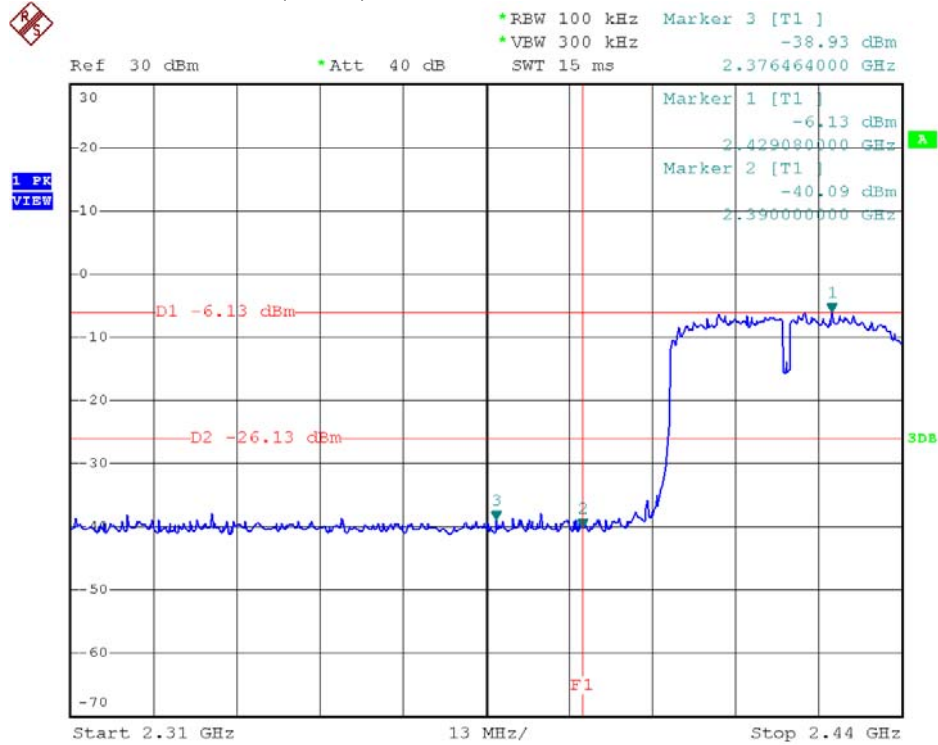

Test Mode: 802.11n (HT40) ---High

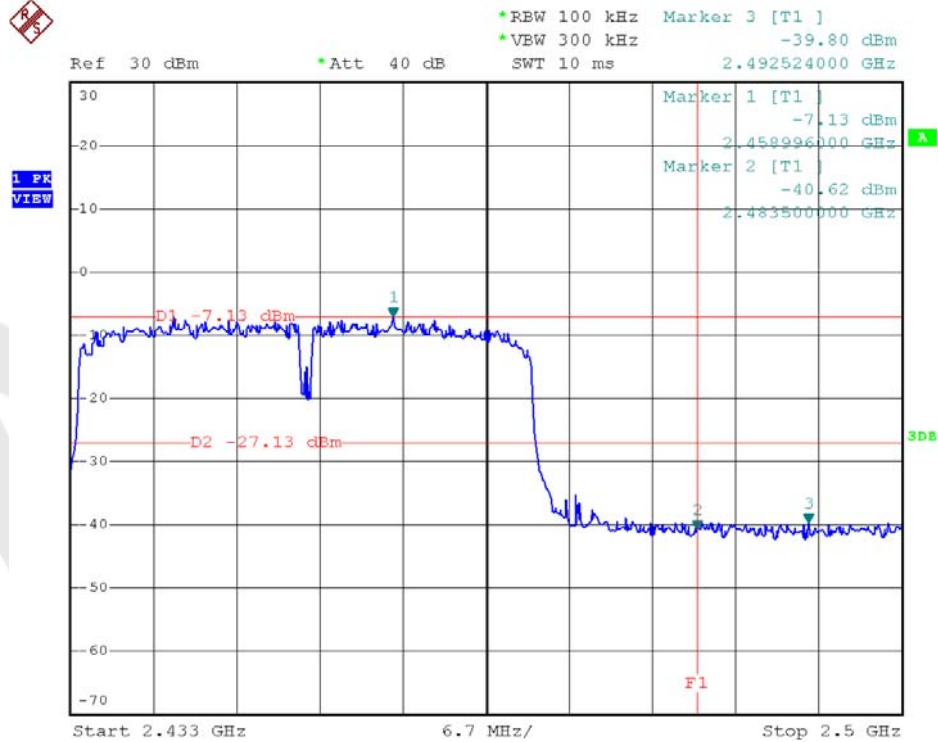

Test Mode: 802.11b
2412MHz
Horizontal-PEAK:

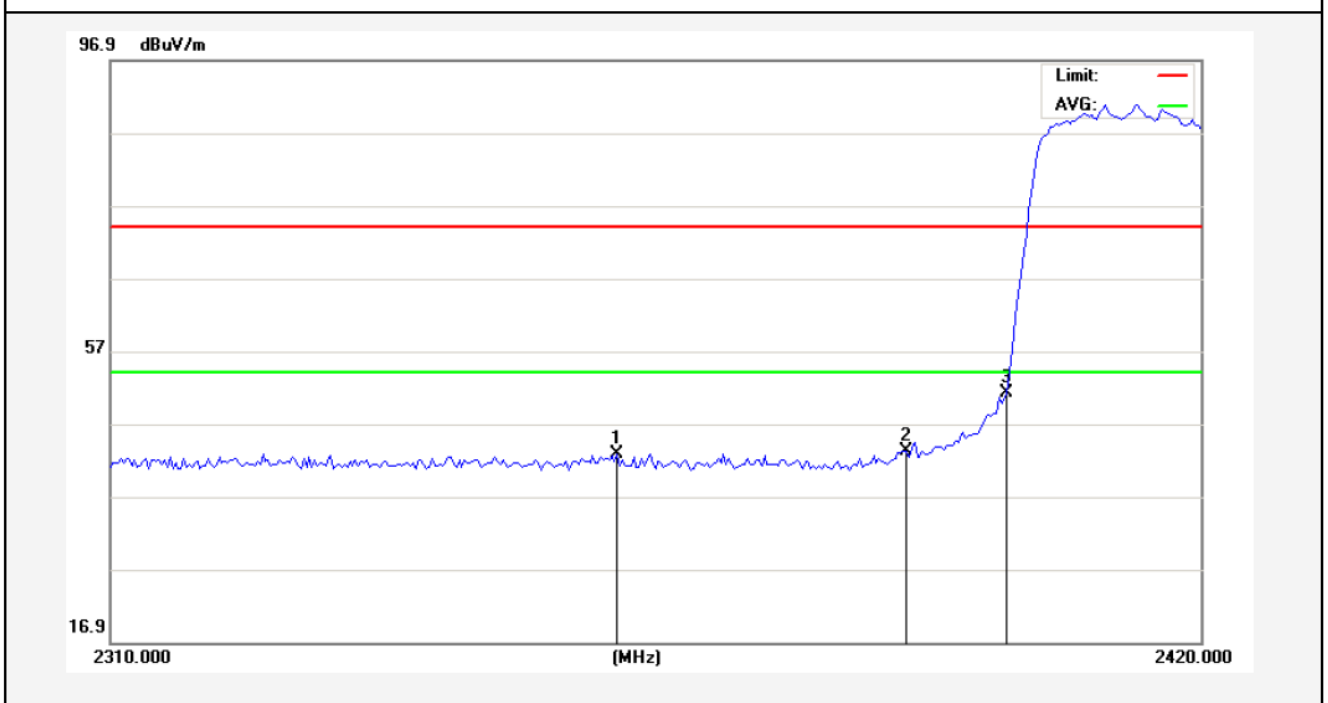

No.	Freq. (MHz)	Reading (dBuV/m)	Factor (dB/m)	Result (dBuV/m)	Limit (dBuV/)	Over Limit (dB)	Detector	Height (cm)	degree (deg)	Remark
1	2360.600	45.43	-2.58	42.85	74.00	-31.15	peak			
2	2390.000	45.77	-2.51	43.26	74.00	-30.74	peak			
3	2400.000	53.78	-2.49	51.29	74.00	-22.71	peak			

AMB

Horizontal-AV:

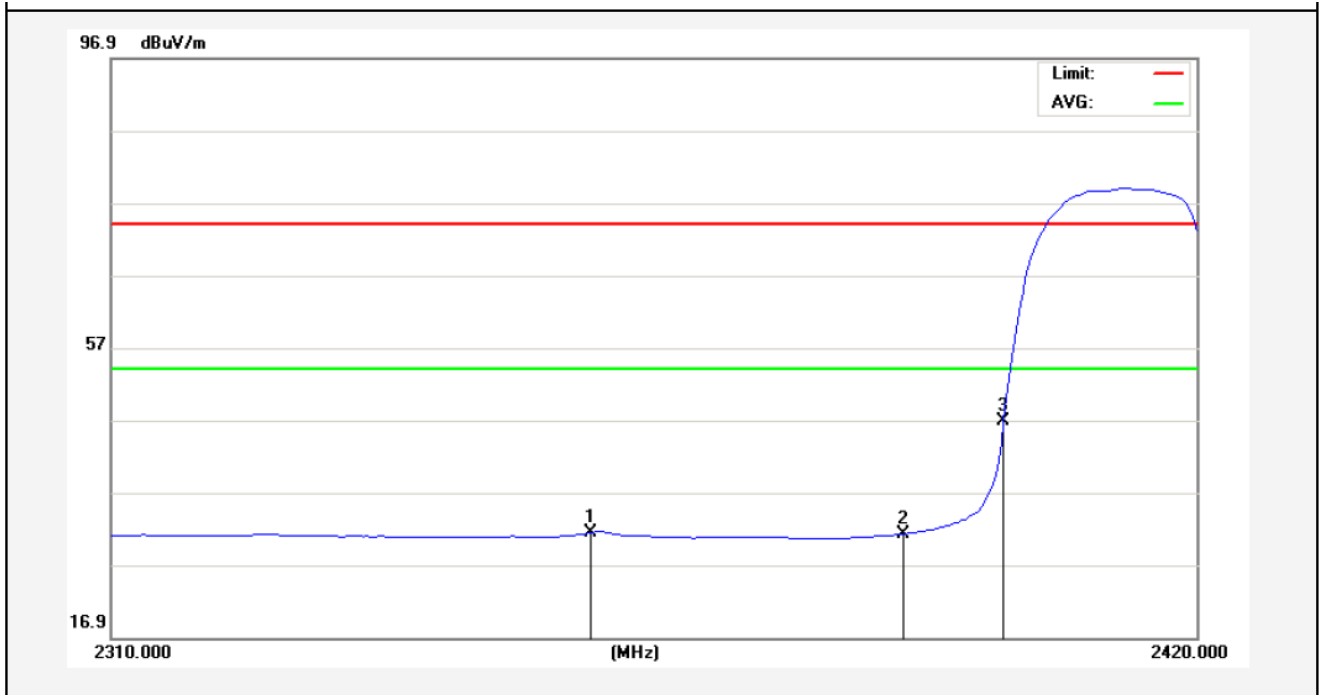

No.	Freq. (MHz)	Reading (dBUV/m)	Factor (dB/m)	Result (dBUV/m)	Limit (dBUV/)	Over Limit (dB)	Detector	Height (cm)	degree (deg)	Remark
1	2357.850	33.93	-2.59	31.34	54.00	-22.66	AVG			
2	2390.000	33.72	-2.51	31.21	54.00	-22.79	AVG			
3	2400.000	49.34	-2.49	46.85	54.00	-7.15	AVG			

Anbotek

Test Mode: 802.11b
2412MHz
Vertical-PEAK:

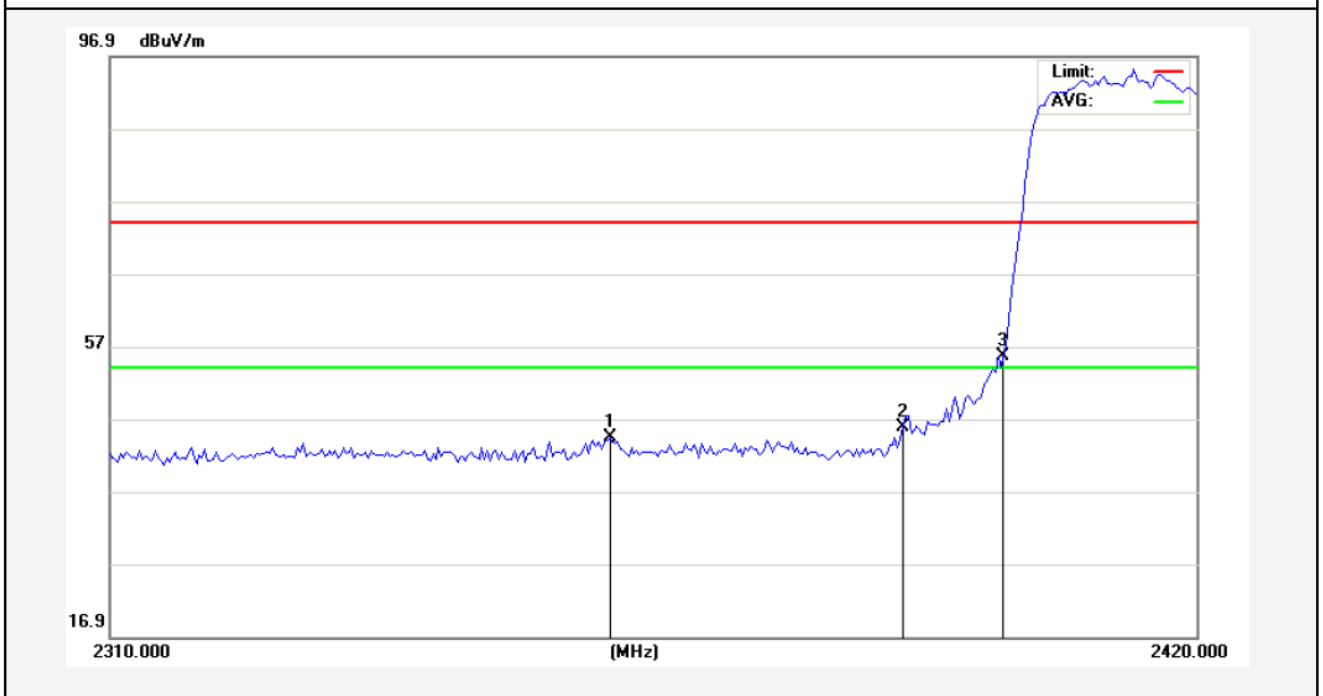

No.	Freq. (MHz)	Reading (dBuV/m)	Factor (dB/m)	Result (dBuV/m)	Limit (dBuV/)	Over Limit (dB)	Detector	Height (cm)	degree (deg)	Remark
1	2360.050	46.91	-2.58	44.33	74.00	-29.67	peak			
2	2390.000	48.22	-2.51	45.71	74.00	-28.29	peak			
3	2400.000	58.01	-2.49	55.52	74.00	-18.48	peak			

AMB

Vertical-AV:

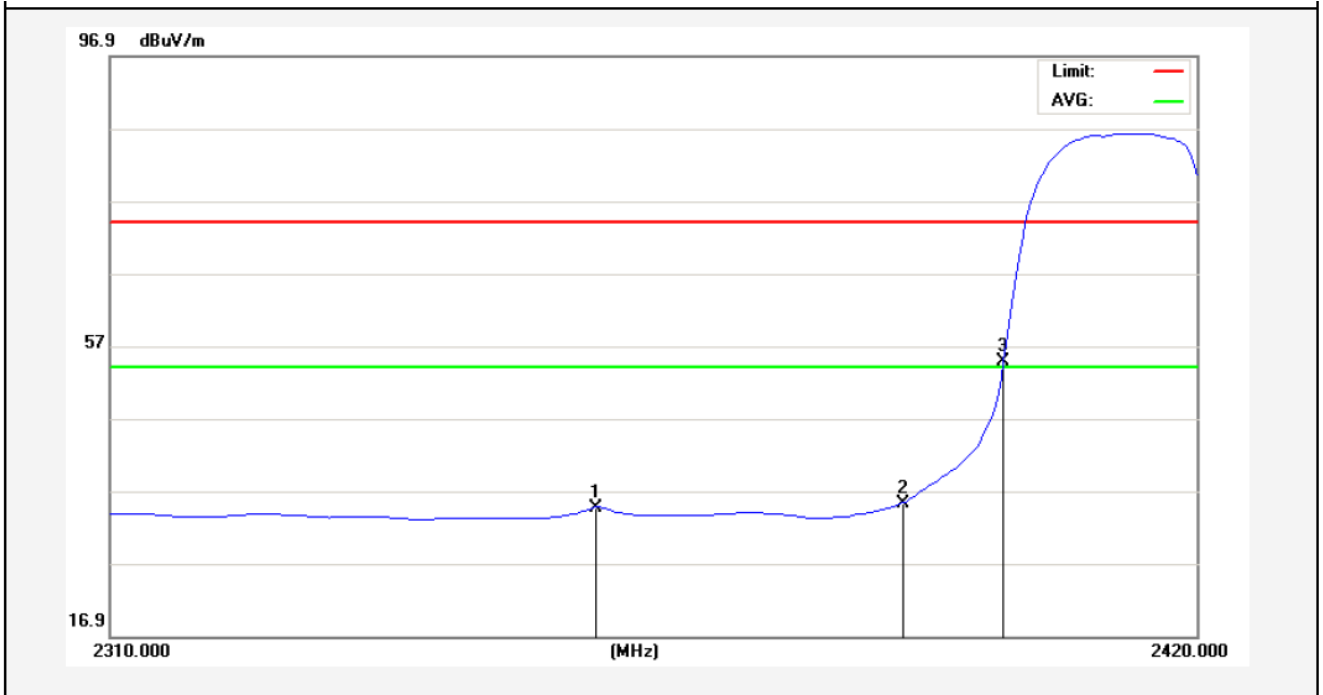

No.	Freq. (MHz)	Reading (dBuV/m)	Factor (dB/m)	Result (dBuV/m)	Limit (dBuV/)	Over Limit (dB)	Detector	Height (cm)	degree (deg)	Remark
1	2358.675	37.28	-2.58	34.70	54.00	-19.30	AVG			
2	2390.000	37.81	-2.51	35.30	54.00	-18.70	AVG			
3	2400.000	57.21	-2.49	54.72	54.00	0.72	AVG			

Anbotek

Test Mode: 802.11b
2462MHz
Horizontal-PEAK:

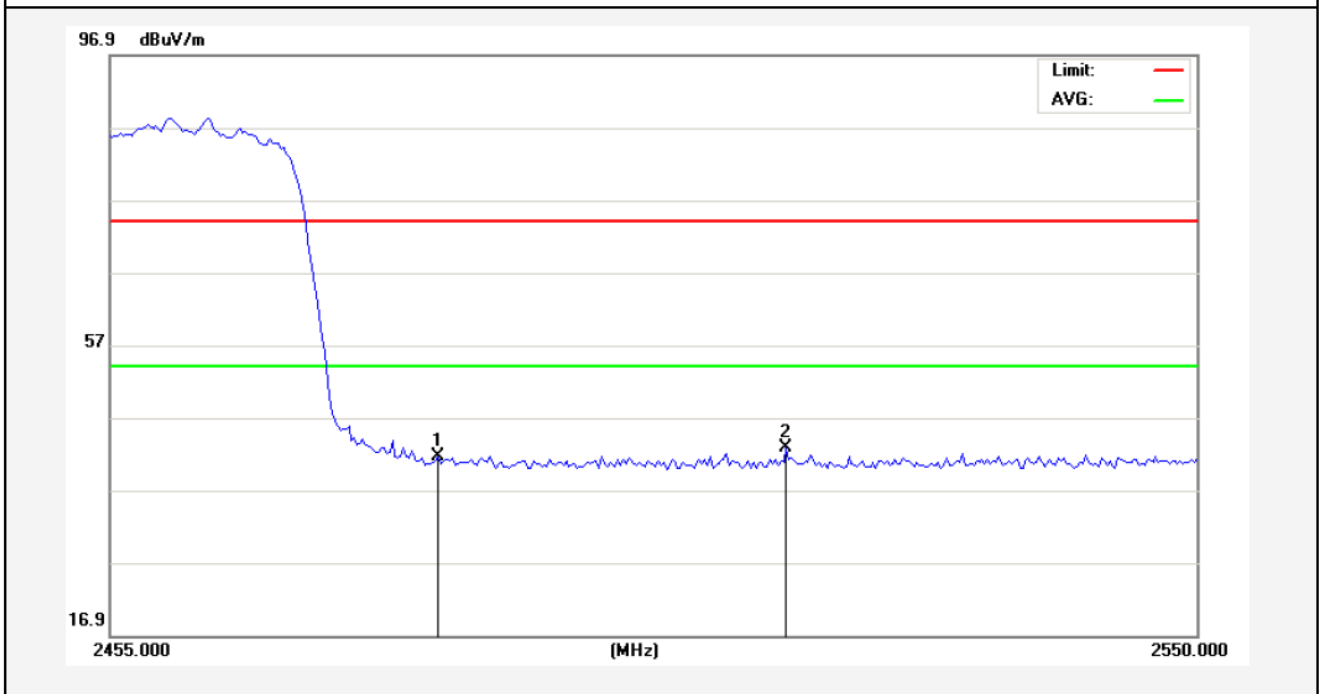

No.	Freq. (MHz)	Reading (dBuV/m)	Factor (dB/m)	Result (dBuV/m)	Limit (dBuV/)	Over Limit (dB)	Detector	Height (cm)	degree (deg)	Remark
1	2483.500	43.90	-2.31	41.59	74.00	-32.41	peak			
2	2513.900	44.99	-2.20	42.79	74.00	-31.21	peak			

Anbotek

Horizontal-AV:

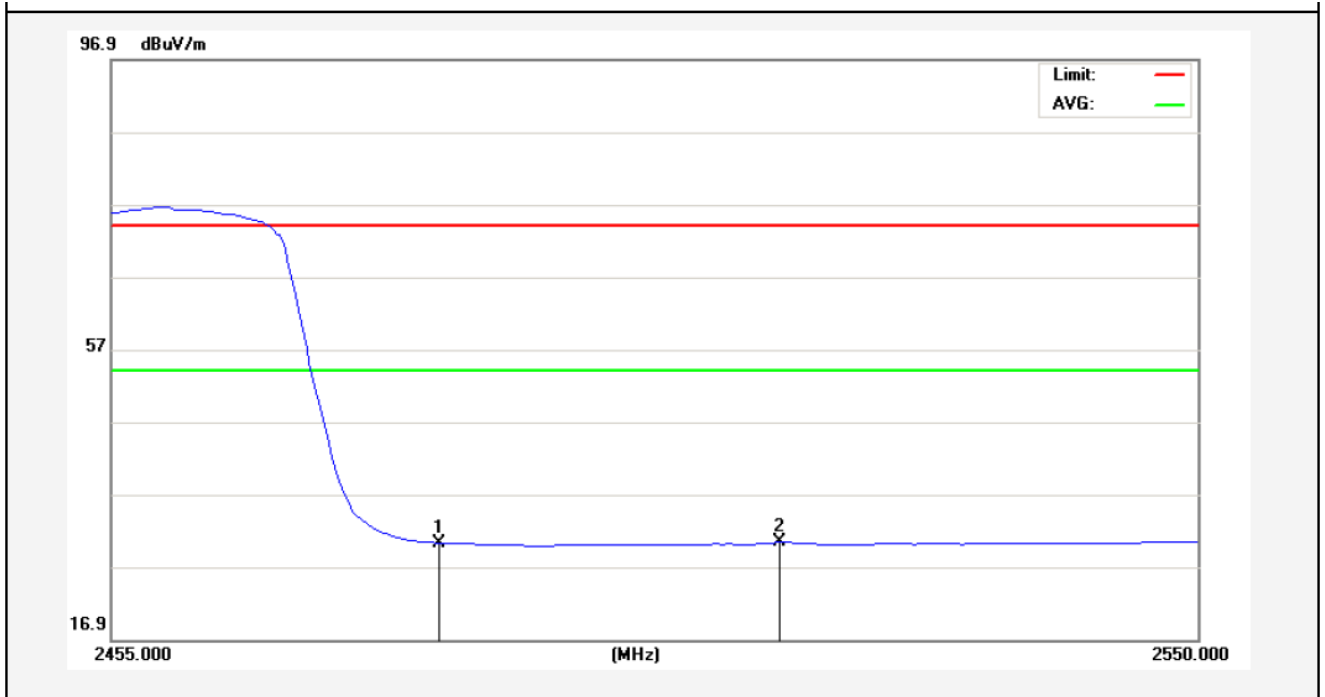

No.	Freq. (MHz)	Reading (dBuV/m)	Factor (dB/m)	Result (dBuV/m)	Limit (dBuV/)	Over Limit (dB)	Detector	Height (cm)	degree (deg)	Remark
1	2483.500	32.57	-2.31	30.26	54.00	-23.74	AVG			
2	2512.950	32.53	-2.21	30.32	54.00	-23.68	AVG			

Anbotek

Test Mode: 802.11b
2462MHz
Vertical-PEAK:

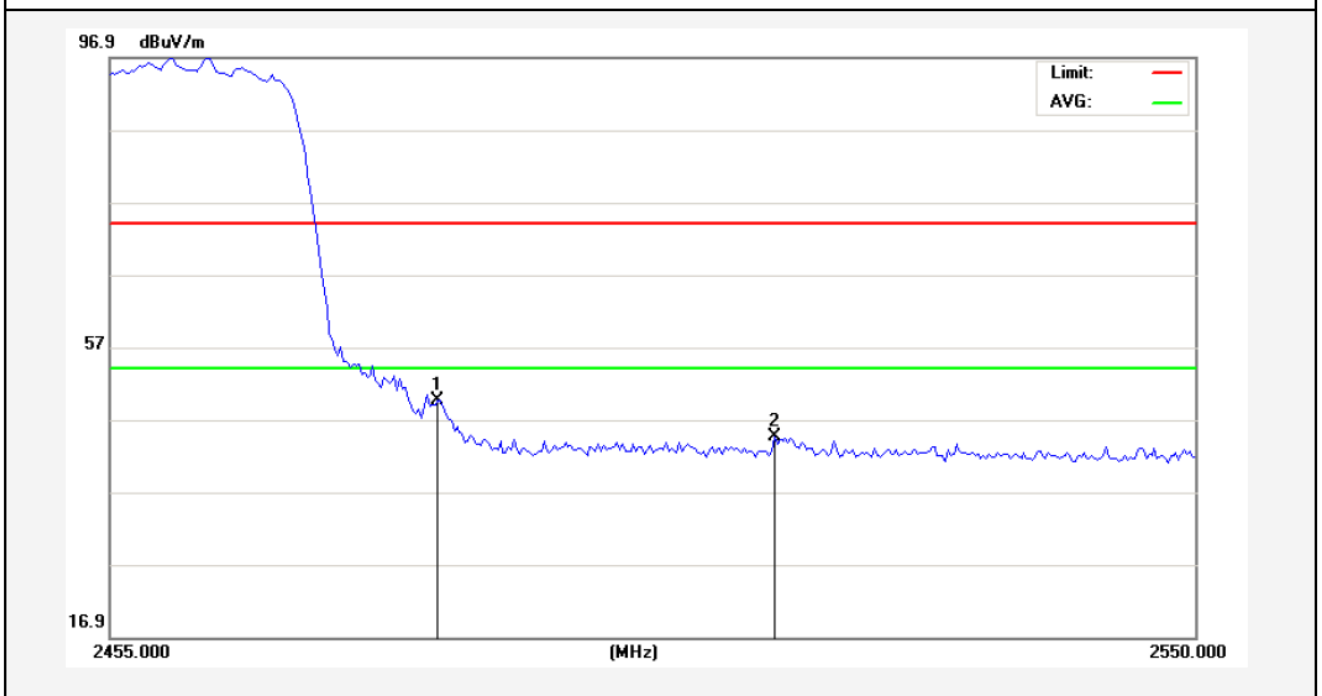

No.	Freq. (MHz)	Reading (dBuV/m)	Factor (dB/m)	Result (dBuV/m)	Limit (dBuV/)	Over Limit (dB)	Detector	Height (cm)	degree (deg)	Remark
1	2483.500	51.84	-2.31	49.53	74.00	-24.47	peak			
2	2512.950	46.85	-2.21	44.64	74.00	-29.36	peak			

Anbotek

Vertical-AV:

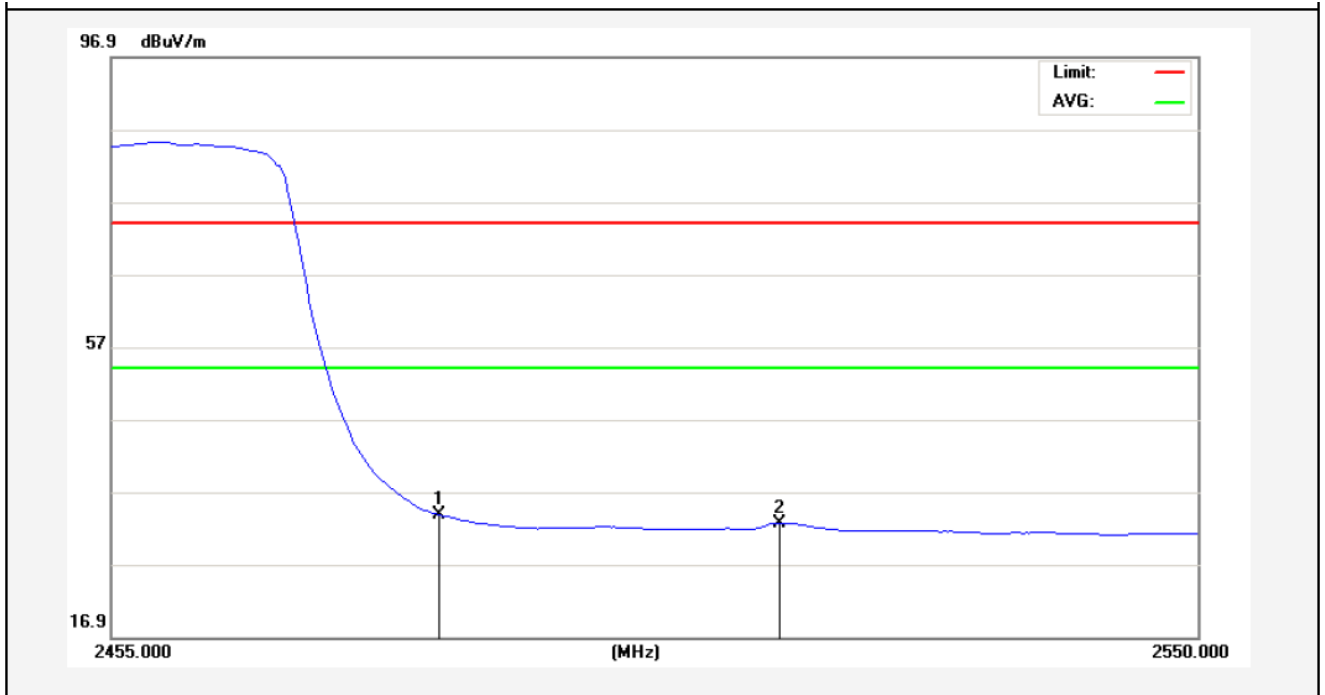

No.	Freq. (MHz)	Reading (dBuV/m)	Factor (dB/m)	Result (dBuV/m)	Limit (dBuV/)	Over Limit (dB)	Detector	Height (cm)	degree (deg)	Remark
1	2483.500	36.07	-2.31	33.76	54.00	-20.24	AVG			
2	2513.188	34.90	-2.21	32.69	54.00	-21.31	AVG			

Test Mode: 802.11g
2412MHz
Horizontal-PEAK:

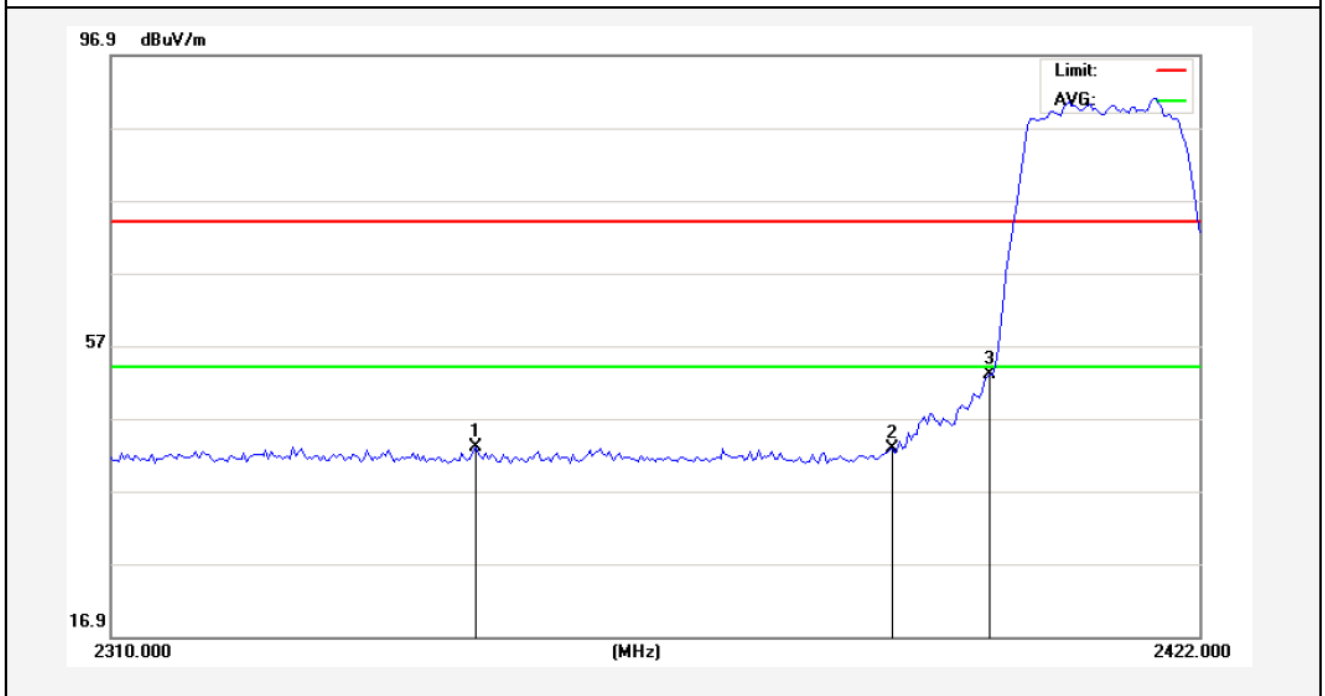

No.	Freq. (MHz)	Reading (dBuV/m)	Factor (dB/m)	Result (dBuV/m)	Limit (dBuV/)	Over Limit (dB)	Detector	Height (cm)	degree (deg)	Remark
1	2346.960	45.66	-2.61	43.05	74.00	-30.95	peak			
2	2390.000	45.34	-2.51	42.83	74.00	-31.17	peak			
3	2400.000	55.42	-2.49	52.93	74.00	-21.07	peak			

AMB

Horizontal-AV:

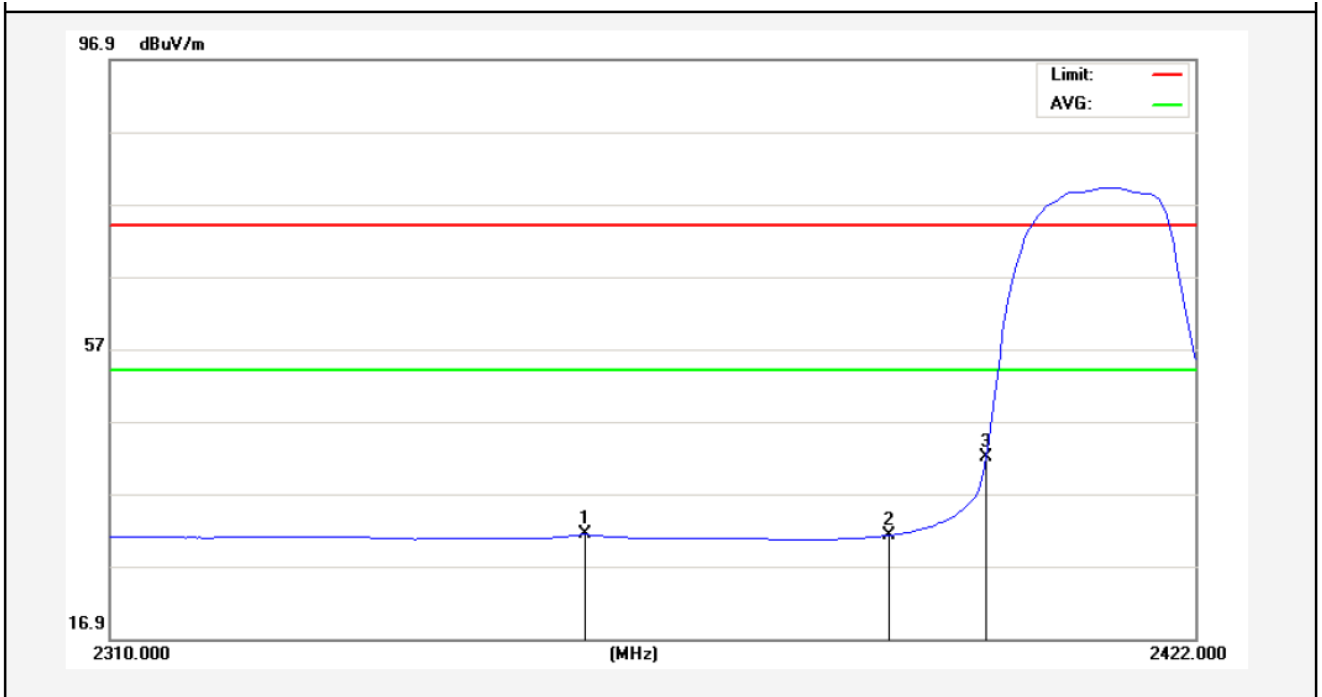

No.	Freq. (MHz)	Reading (dBuV/m)	Factor (dB/m)	Result (dBuV/m)	Limit (dBuV/)	Over Limit (dB)	Detector	Height (cm)	degree (deg)	Remark
1	2358.440	33.93	-2.58	31.35	54.00	-22.65	AVG			
2	2390.000	33.69	-2.51	31.18	54.00	-22.82	AVG			
3	2400.000	44.41	-2.49	41.92	54.00	-12.08	AVG			

Anbotek

Test Mode: 802.11g
2412MHz
Vertical-PEAK:

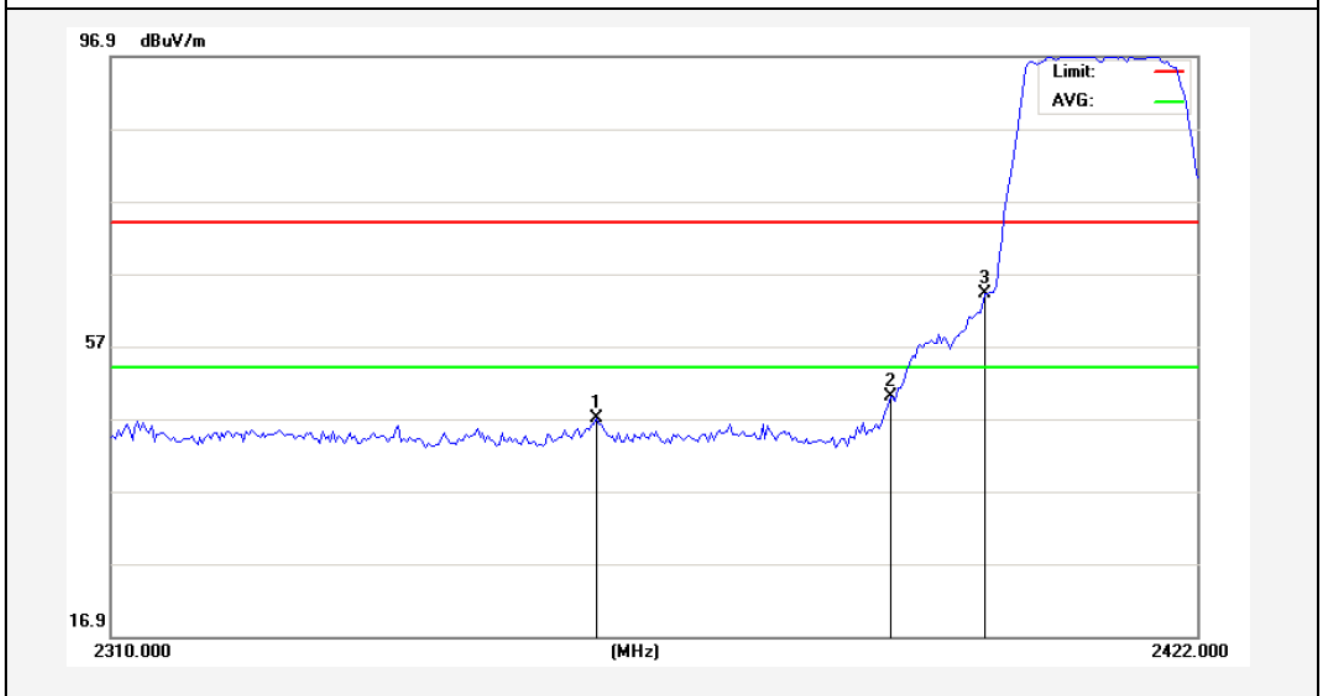

No.	Freq. (MHz)	Reading (dBuV/m)	Factor (dB/m)	Result (dBuV/m)	Limit (dBuV/)	Over Limit (dB)	Detector	Height (cm)	degree (deg)	Remark
1	2359.560	49.66	-2.58	47.08	74.00	-26.92	peak			
2	2390.000	52.45	-2.51	49.94	74.00	-24.06	peak			
3	2400.000	66.61	-2.49	64.12	74.00	-9.88	peak			

AMB

Vertical-AV:

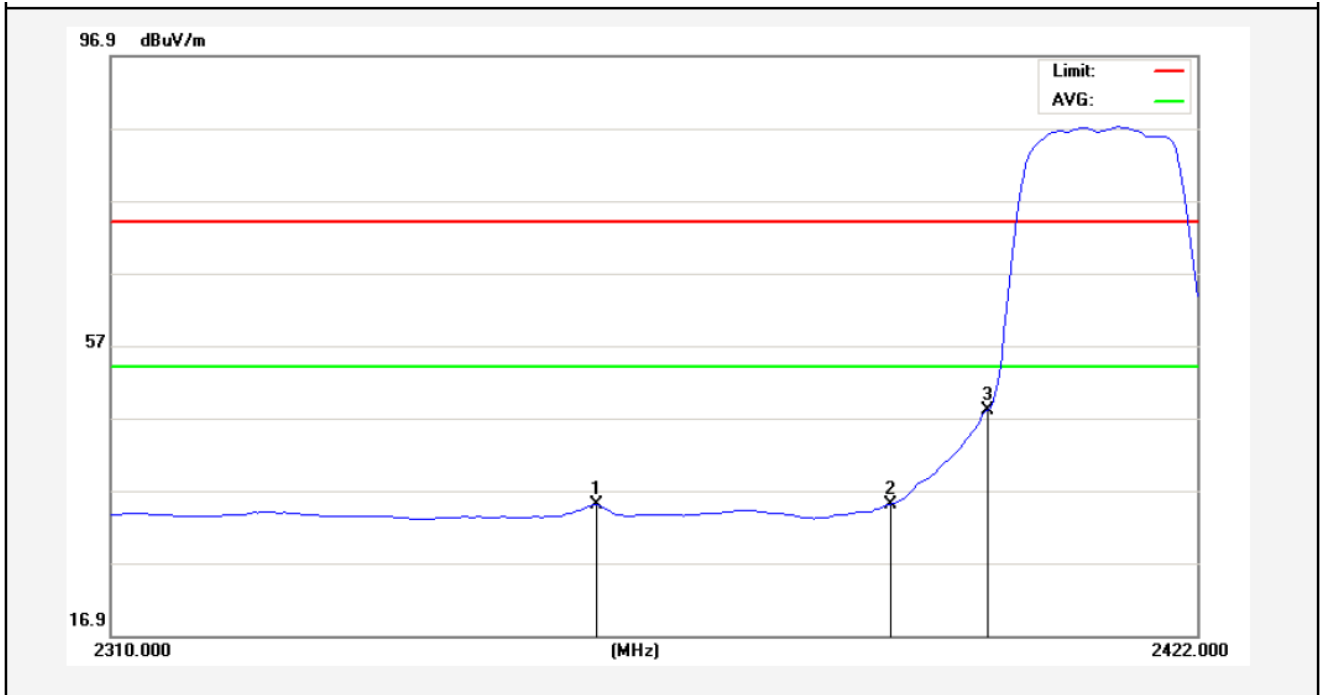

No.	Freq. (MHz)	Reading (dBuV/m)	Factor (dB/m)	Result (dBuV/m)	Limit (dBuV/)	Over Limit (dB)	Detector	Height (cm)	degree (deg)	Remark
1	2359.560	37.62	-2.58	35.04	54.00	-18.96	AVG			
2	2390.000	37.54	-2.51	35.03	54.00	-18.97	AVG			
3	2400.000	50.47	-2.49	47.98	54.00	-6.02	AVG			

Anbotek

Test Mode: 802.11g
2462MHz
Horizontal-PEAK:

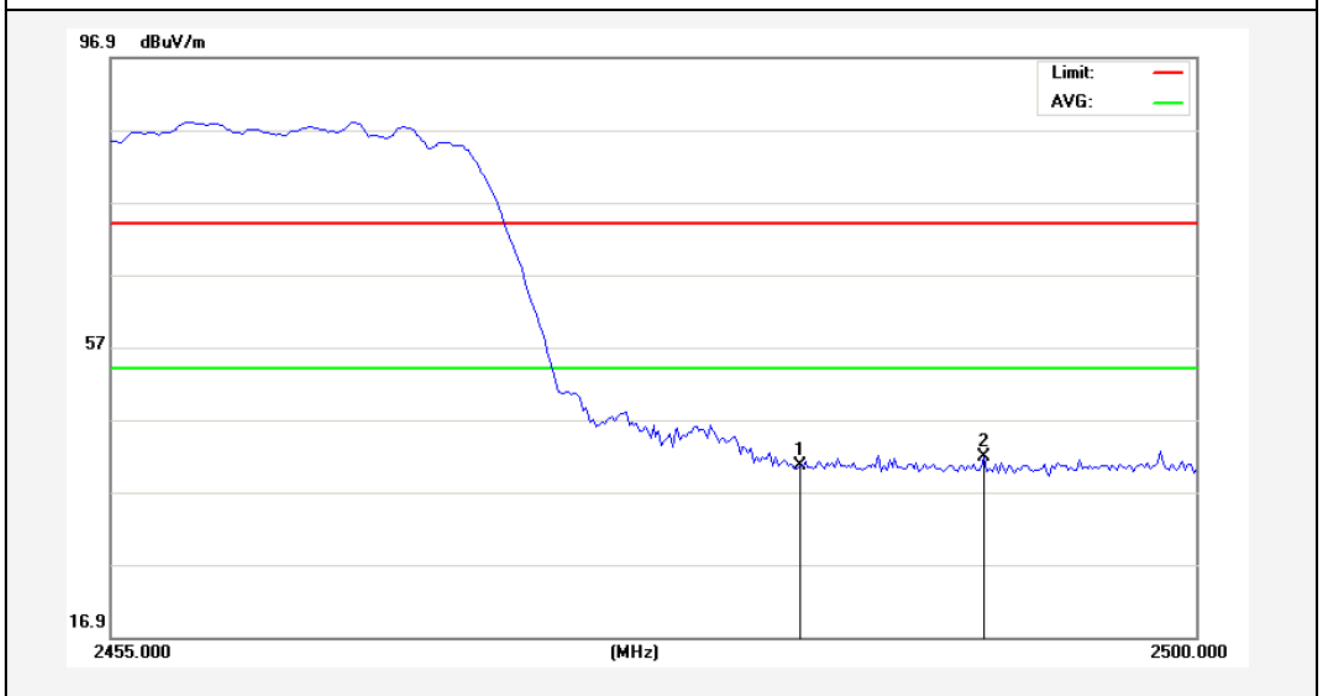

No.	Freq. (MHz)	Reading (dBuV/m)	Factor (dB/m)	Result (dBuV/m)	Limit (dBuV/)	Over Limit (dB)	Detector	Height (cm)	degree (deg)	Remark
1	2483.500	42.87	-2.31	40.56	74.00	-33.44	peak			
2	2491.225	44.16	-2.29	41.87	74.00	-32.13	peak			

Anbotek

Horizontal-AV:

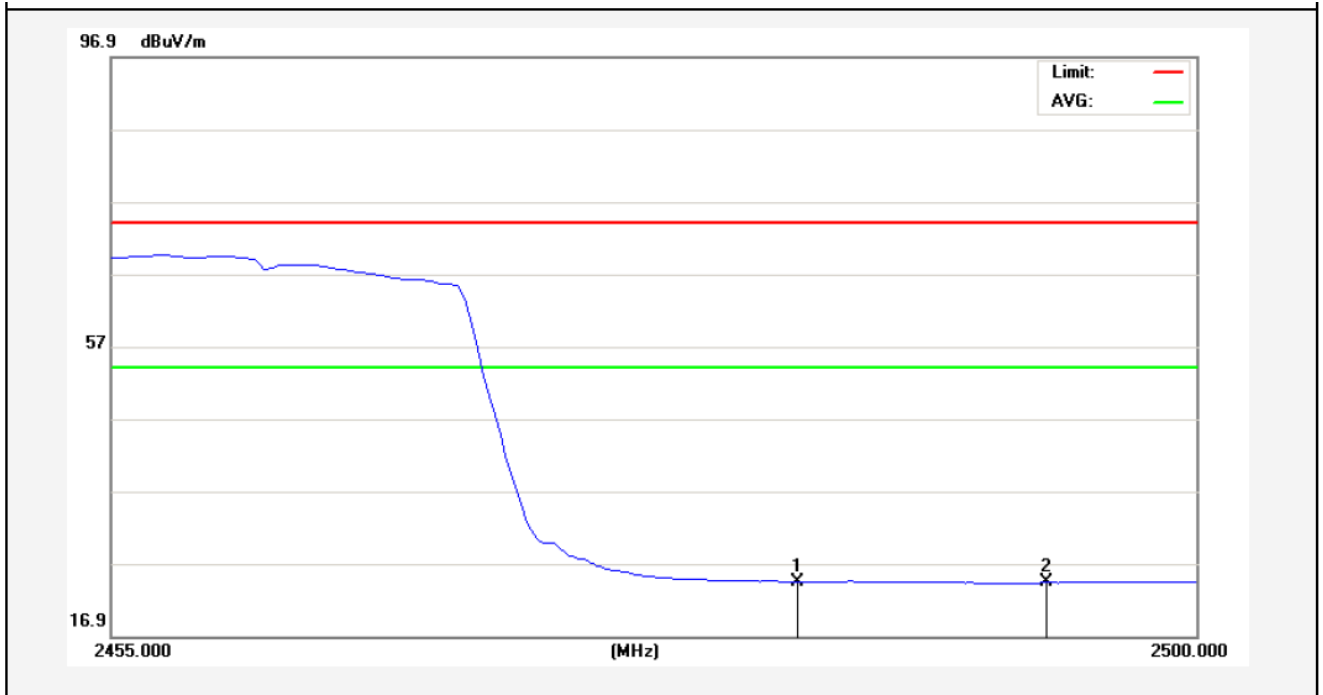

No.	Freq. (MHz)	Reading (dBuV/m)	Factor (dB/m)	Result (dBuV/m)	Limit (dBuV/)	Over Limit (dB)	Detector	Height (cm)	degree (deg)	Remark
1	2483.500	26.75	-2.31	24.44	54.00	-29.56	AVG			
2	2493.813	26.62	-2.28	24.34	54.00	-29.66	AVG			

Anbotek

Test Mode: 802.11g
2462MHz
Vertical-PEAK:

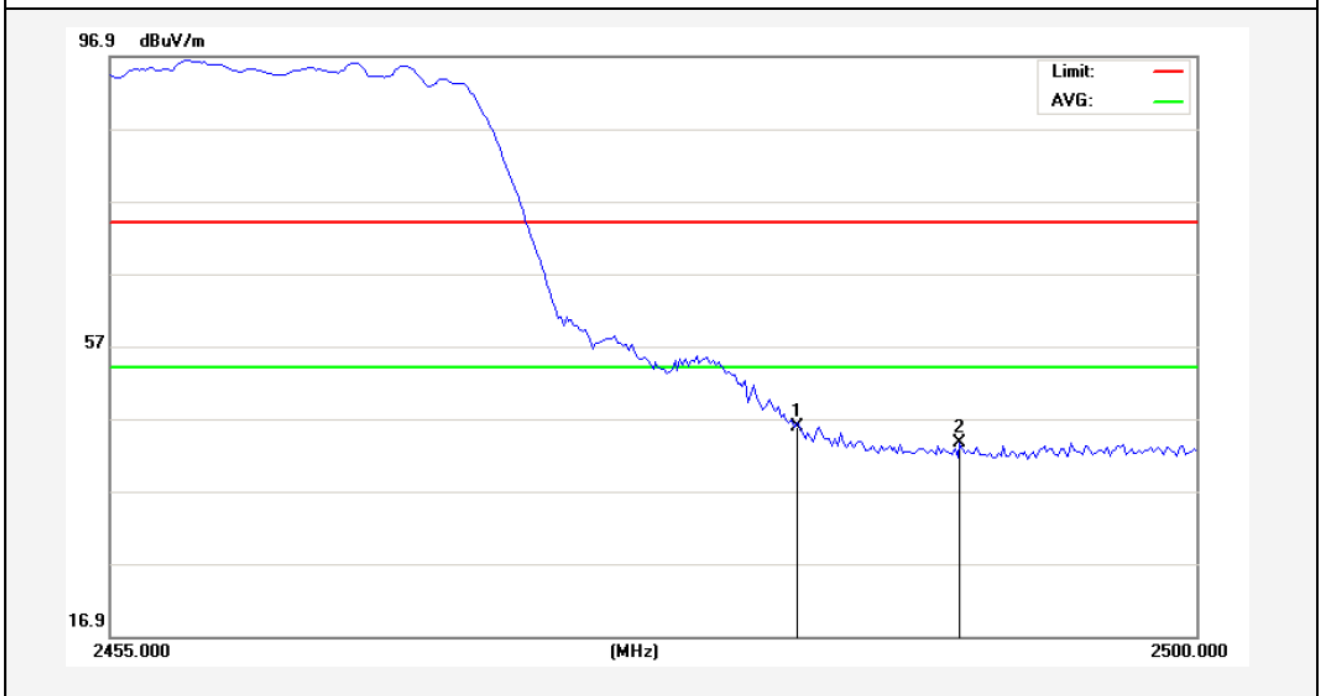

No.	Freq. (MHz)	Reading (dBuV/m)	Factor (dB/m)	Result (dBuV/m)	Limit (dBuV/)	Over Limit (dB)	Detector	Height (cm)	degree (deg)	Remark
1	2483.500	48.02	-2.31	45.71	74.00	-28.29	peak			
2	2490.213	45.88	-2.29	43.59	74.00	-30.41	peak			

Anbotek

Vertical-AV:

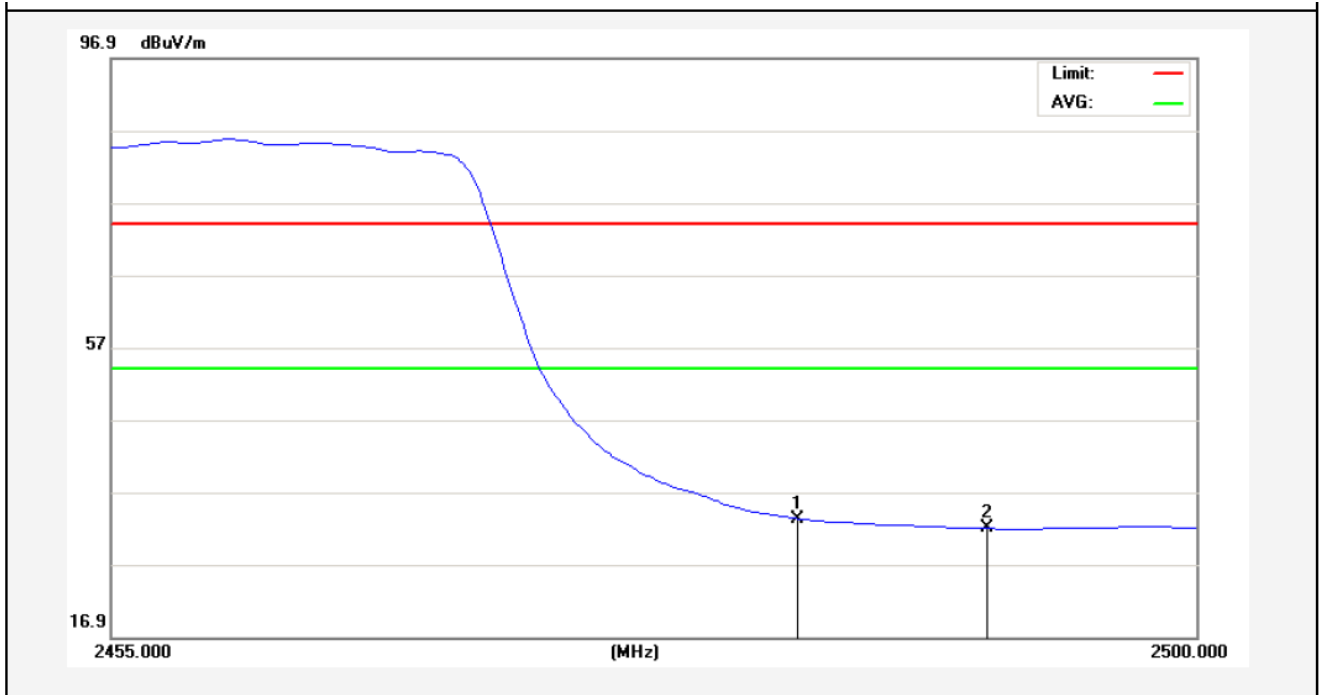

No.	Freq. (MHz)	Reading (dBuV/m)	Factor (dB/m)	Result (dBuV/m)	Limit (dBuV/)	Over Limit (dB)	Detector	Height (cm)	degree (deg)	Remark
1	2483.500	35.54	-2.31	33.23	54.00	-20.77	AVG			
2	2491.338	34.25	-2.29	31.96	54.00	-22.04	AVG			

Anbotek

Test Mode: 802.11n (HT20)
2412MHz
Horizontal-PEAK:

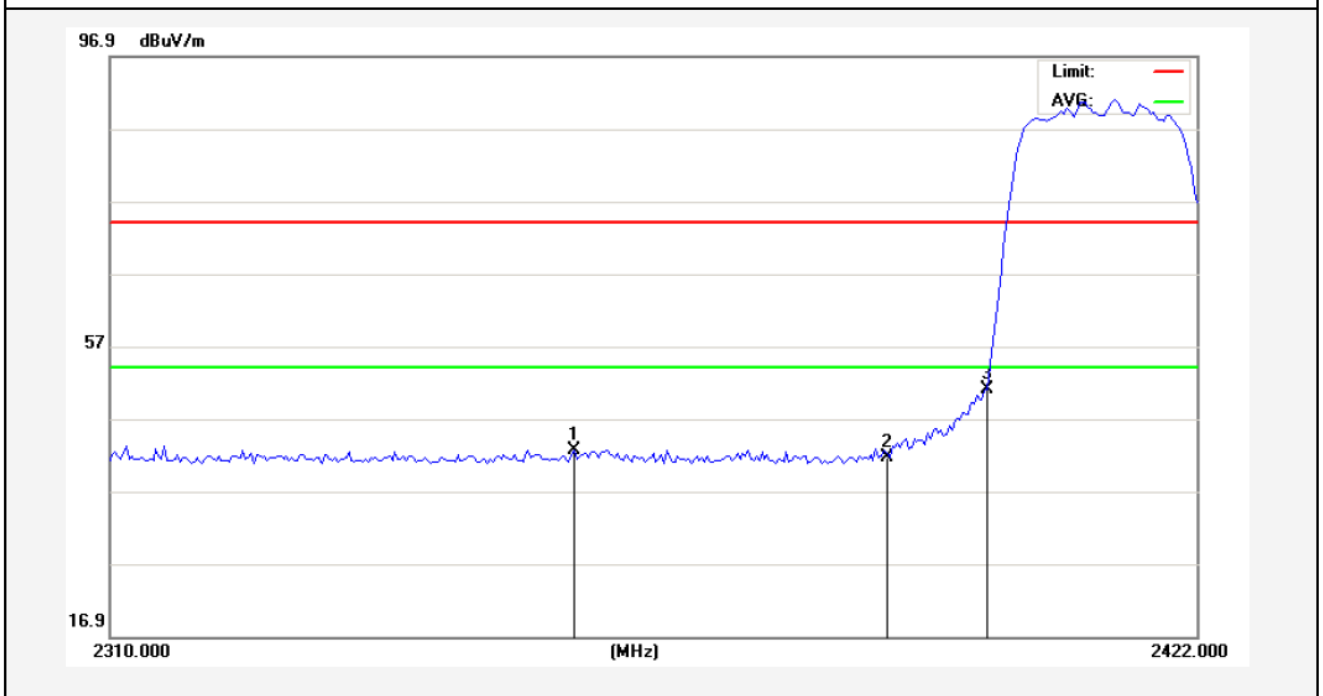

No.	Freq. (MHz)	Reading (dBuV/m)	Factor (dB/m)	Result (dBuV/m)	Limit (dBuV/)	Over Limit (dB)	Detector	Height (cm)	degree (deg)	Remark
1	2357.320	45.24	-2.59	42.65	74.00	-31.35	peak			
2	2390.000	44.14	-2.51	41.63	74.00	-32.37	peak			
3	2400.000	53.55	-2.49	51.06	74.00	-22.94	peak			

AMB

Horizontal-AV:

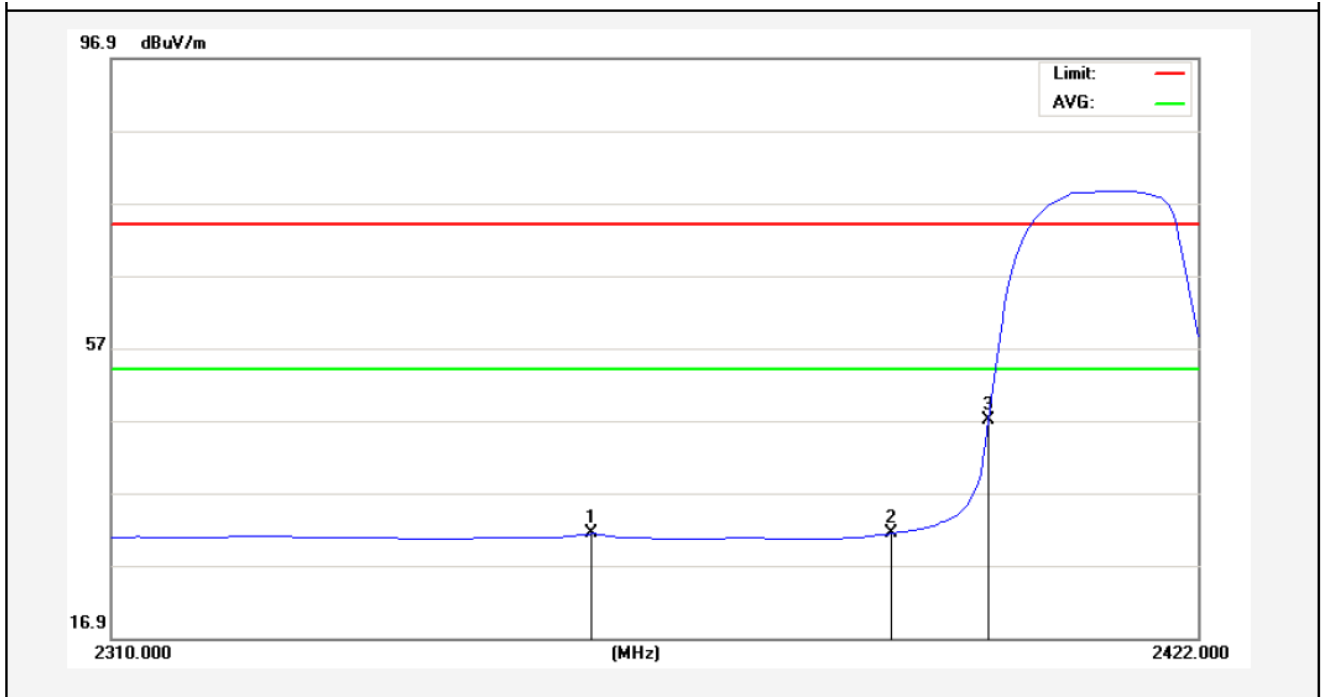

No.	Freq. (MHz)	Reading (dBuV/m)	Factor (dB/m)	Result (dBuV/m)	Limit (dBuV/)	Over Limit (dB)	Detector	Height (cm)	degree (deg)	Remark
1	2359.000	33.91	-2.58	31.33	54.00	-22.67	AVG			
2	2390.000	33.83	-2.51	31.32	54.00	-22.68	AVG			
3	2400.000	49.41	-2.49	46.92	54.00	-7.08	AVG			

Anbotek

Test Mode: 802.11n (HT20)
2412MHz
Vertical-PEAK:

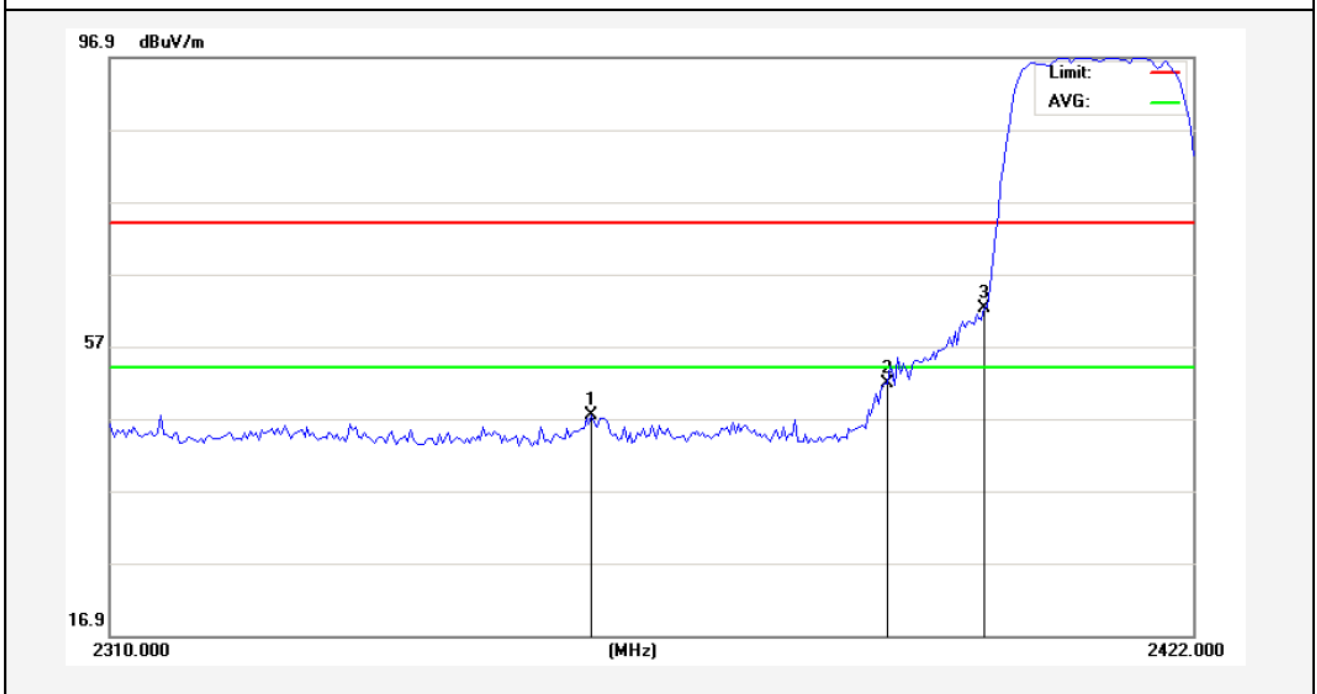

No.	Freq. (MHz)	Reading (dBuV/m)	Factor (dB/m)	Result (dBuV/m)	Limit (dBuV/)	Over Limit (dB)	Detector	Height (cm)	degree (deg)	Remark
1	2359.280	49.89	-2.58	47.31	74.00	-26.69	peak			
2	2390.000	54.29	-2.51	51.78	74.00	-22.22	peak			
3	2400.000	64.74	-2.49	62.25	74.00	-11.75	peak			

AMB

Vertical-AV:

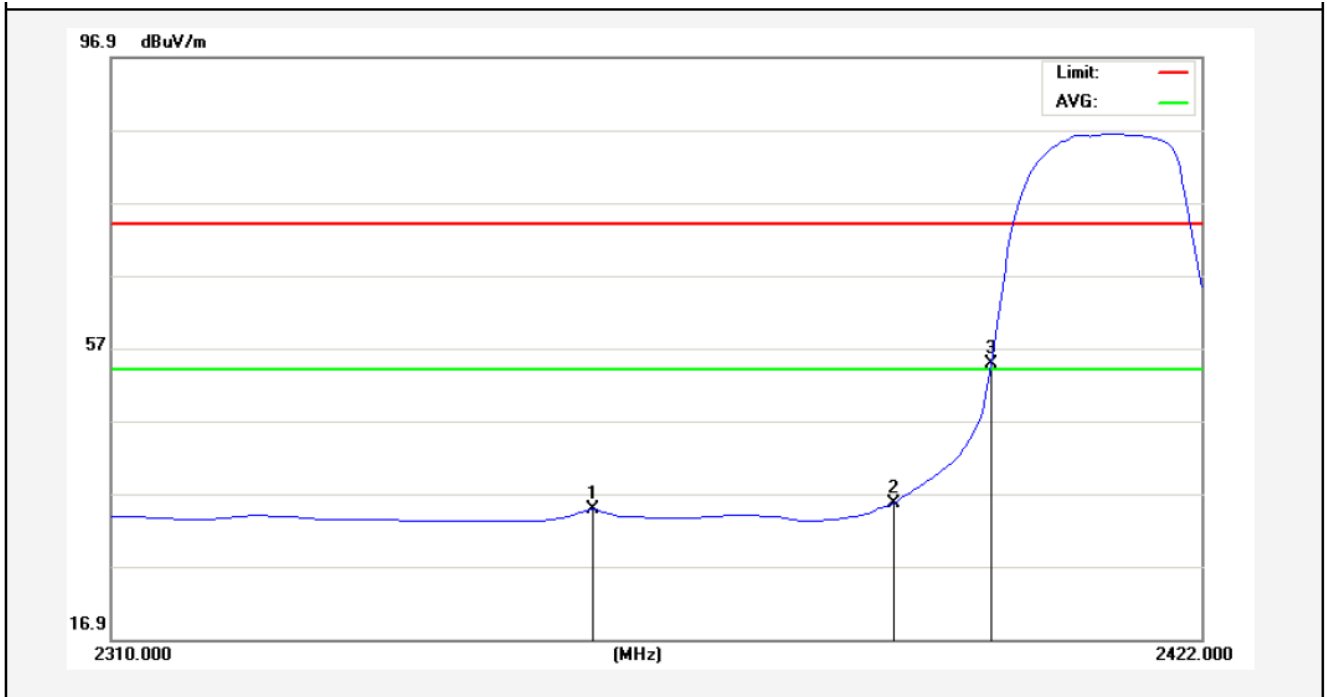

No.	Freq. (MHz)	Reading (dBuV/m)	Factor (dB/m)	Result (dBuV/m)	Limit (dBuV/)	Over Limit (dB)	Detector	Height (cm)	degree (deg)	Remark
1	2359.000	37.37	-2.58	34.79	54.00	-19.21	AVG			
2	2390.000	38.09	-2.51	35.58	54.00	-18.42	AVG			
3	2400.000	57.28	-2.49	54.79	54.00	0.79	AVG			

Anbotek

Test Mode: 802.11n (HT20)
2462MHz
Horizontal-PEAK:

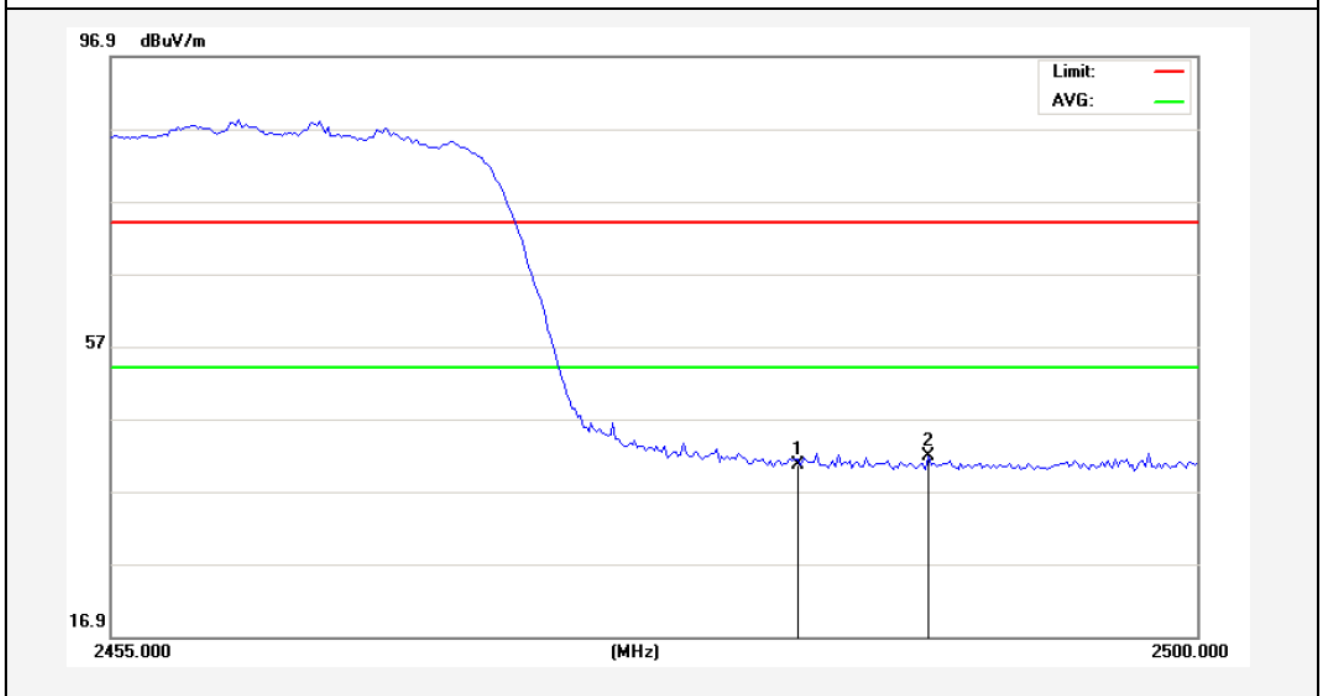

No.	Freq. (MHz)	Reading (dBuV/m)	Factor (dB/m)	Result (dBuV/m)	Limit (dBuV/)	Over Limit (dB)	Detector	Height (cm)	degree (deg)	Remark
1	2483.500	42.84	-2.31	40.53	74.00	-33.47	peak			
2	2488.863	44.08	-2.29	41.79	74.00	-32.21	peak			

Anbotek

Horizontal-AV:

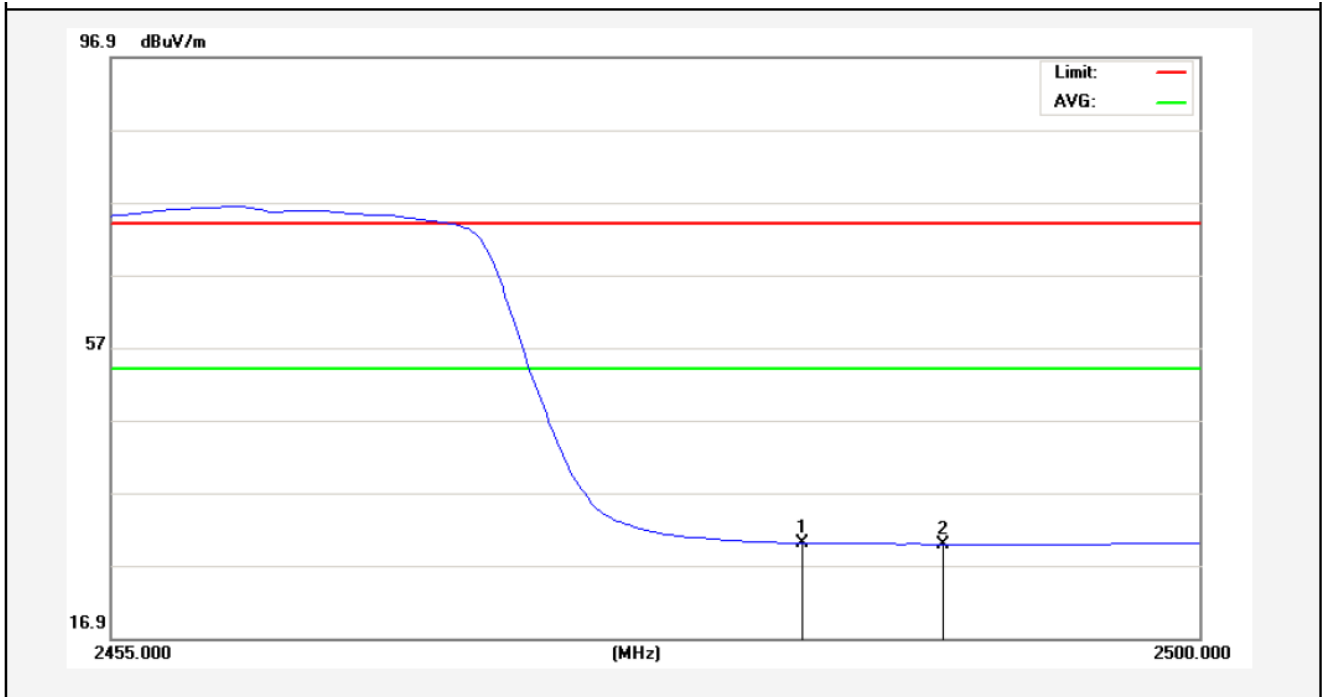

No.	Freq. (MHz)	Reading (dBuV/m)	Factor (dB/m)	Result (dBuV/m)	Limit (dBuV/)	Over Limit (dB)	Detector	Height (cm)	degree (deg)	Remark
1	2483.500	32.35	-2.31	30.04	54.00	-23.96	AVG			
2	2489.537	32.13	-2.29	29.84	54.00	-24.16	AVG			

Anbotek

Test Mode: 802.11n (HT20)
2462MHz
Vertical-PEAK:

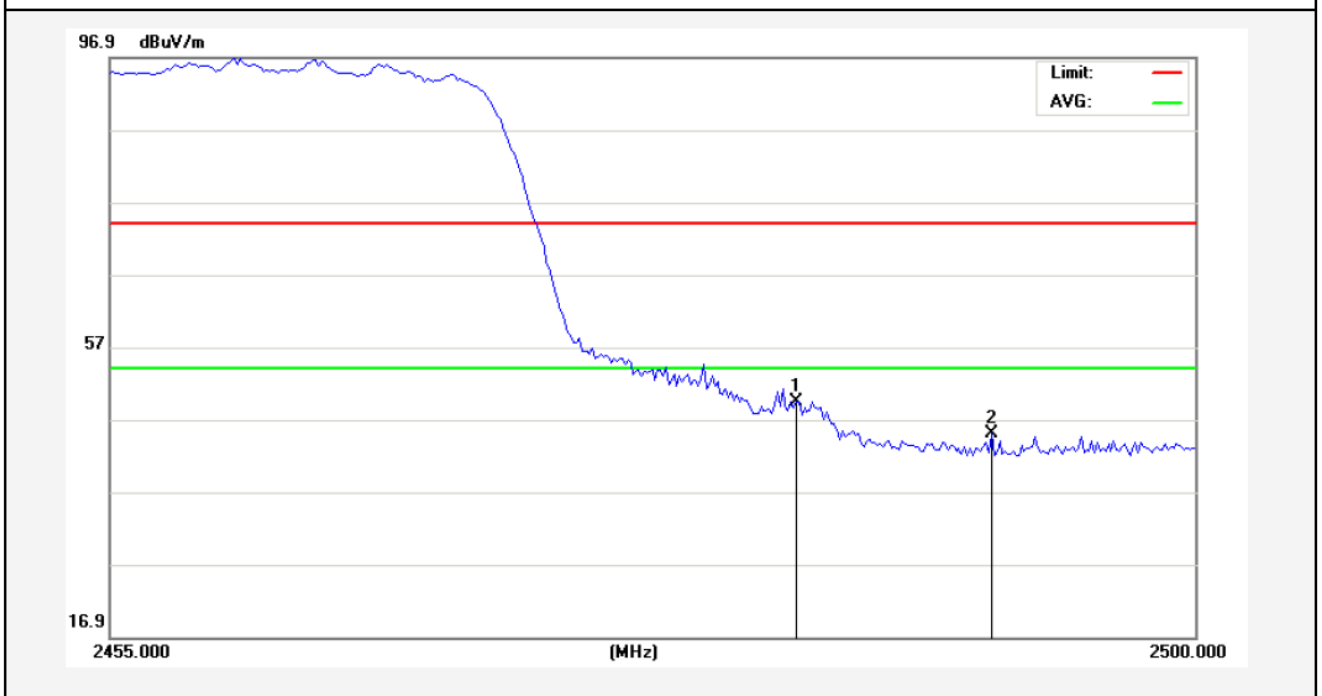

No.	Freq. (MHz)	Reading (dBuV/m)	Factor (dB/m)	Result (dBuV/m)	Limit (dBuV/)	Over Limit (dB)	Detector	Height (cm)	degree (deg)	Remark
1	2483.500	51.78	-2.31	49.47	74.00	-24.53	peak			
2	2491.563	47.27	-2.29	44.98	74.00	-29.02	peak			

Anbotek

Vertical-AV:

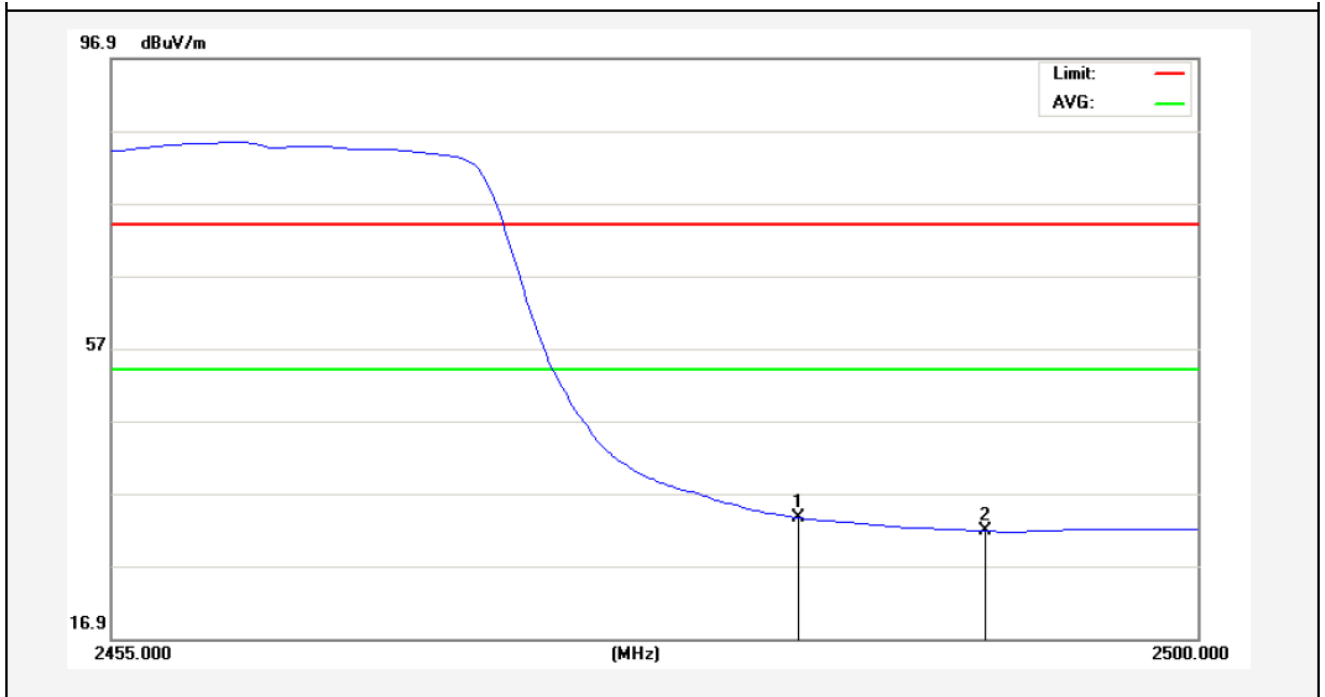

No.	Freq. (MHz)	Reading (dBuV/m)	Factor (dB/m)	Result (dBuV/m)	Limit (dBuV/)	Over Limit (dB)	Detector	Height (cm)	degree (deg)	Remark
1	2483.500	35.85	-2.31	33.54	54.00	-20.46	AVG			
2	2491.225	34.07	-2.29	31.78	54.00	-22.22	AVG			

Anbotek

Test Mode: 802.11n (HT40)
2422MHz
Horizontal-PEAK:

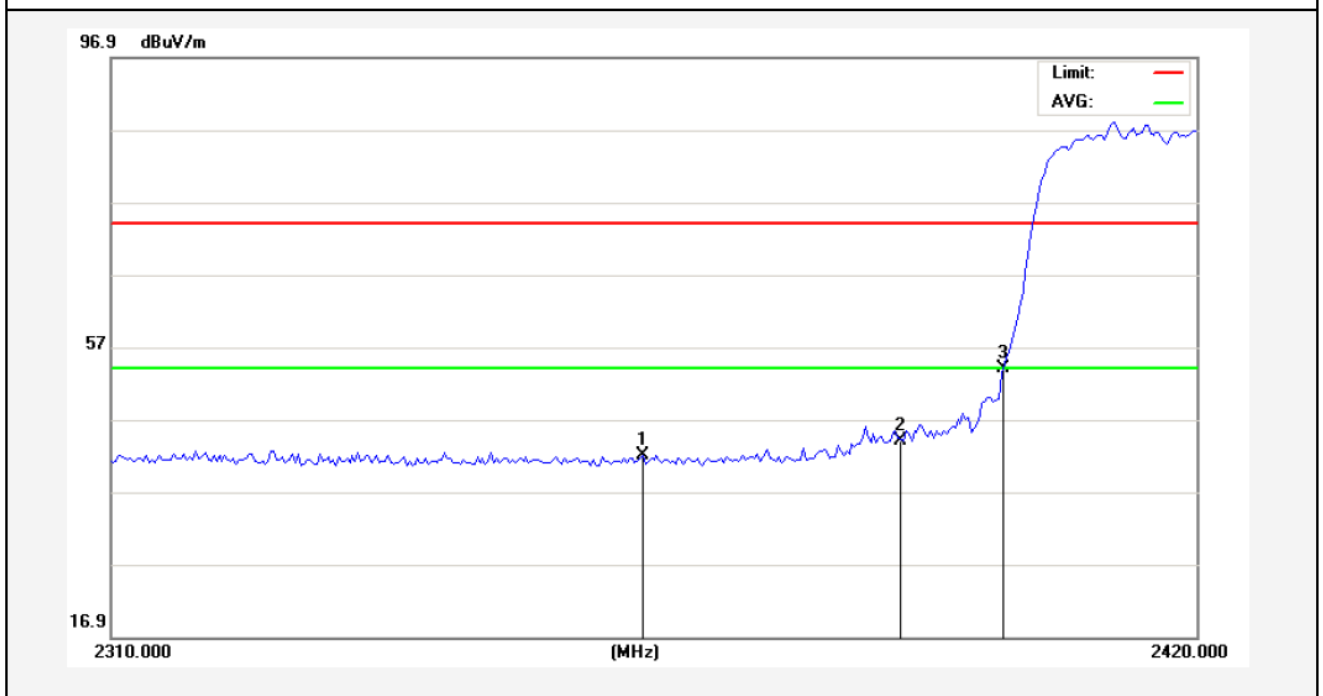

No.	Freq. (MHz)	Reading (dBuV/m)	Factor (dB/m)	Result (dBuV/m)	Limit (dBuV/)	Over Limit (dB)	Detector	Height (cm)	degree (deg)	Remark
1	2363.350	44.61	-2.57	42.04	74.00	-31.96	peak			
2	2390.000	46.60	-2.51	44.09	74.00	-29.91	peak			
3	2400.000	56.56	-2.49	54.07	74.00	-19.93	peak			

AMB

Horizontal-AV:

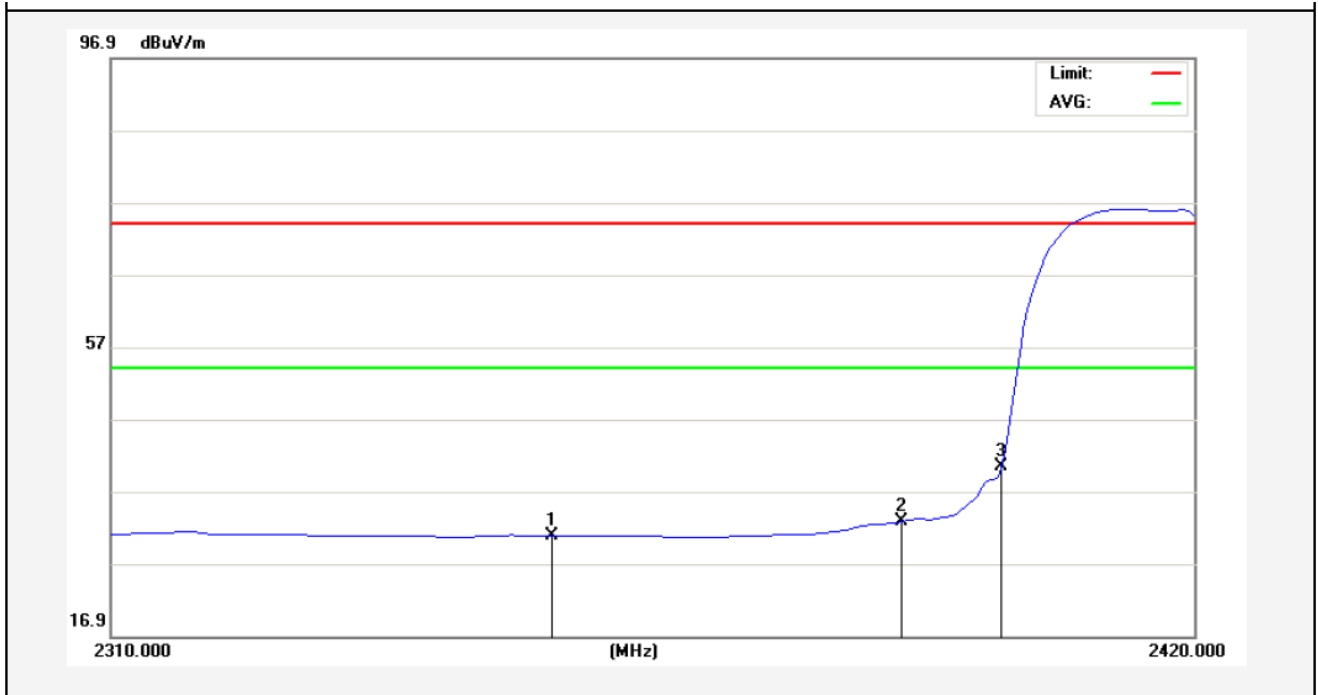

No.	Freq. (MHz)	Reading (dBuV/m)	Factor (dB/m)	Result (dBuV/m)	Limit (dBuV/)	Over Limit (dB)	Detector	Height (cm)	degree (deg)	Remark
1	2354.275	33.41	-2.59	30.82	54.00	-23.18	AVG			
2	2390.000	35.29	-2.51	32.78	54.00	-21.22	AVG			
3	2400.000	42.80	-2.49	40.31	54.00	-13.69	AVG			

Anbotek

Test Mode: 802.11n (HT40)
2422MHz
Vertical-PEAK:

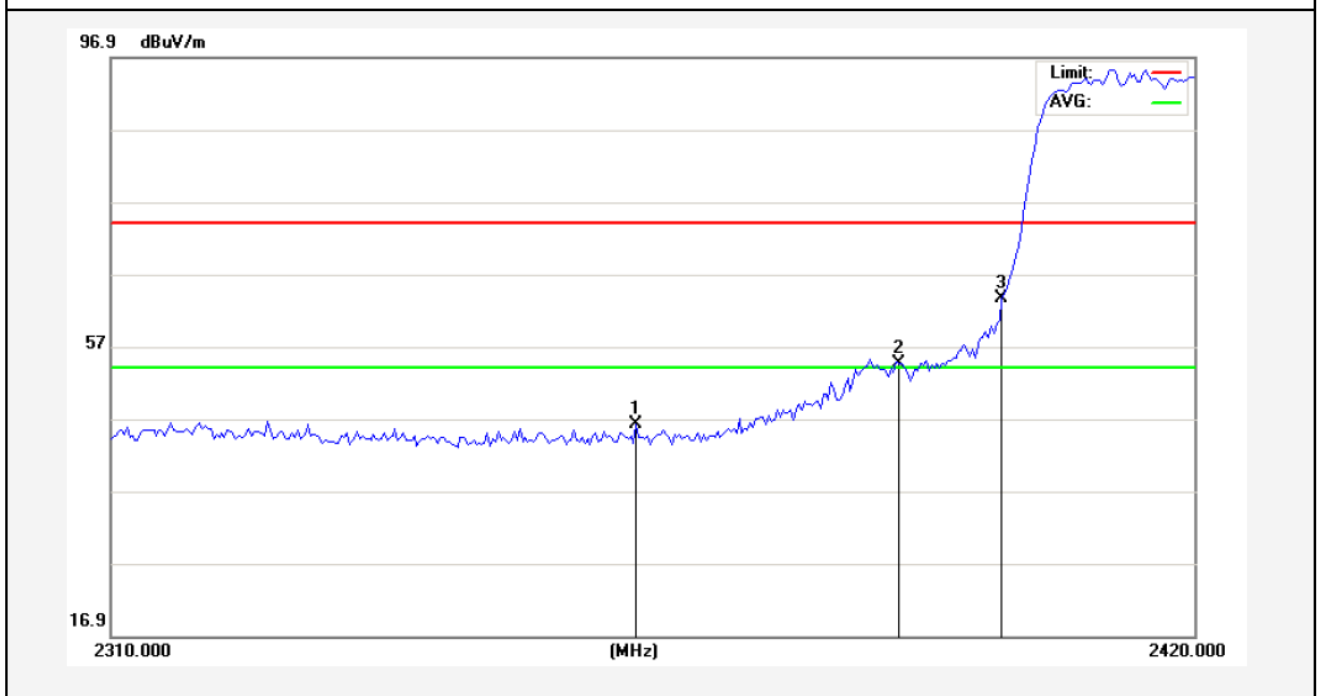

No.	Freq. (MHz)	Reading (dBuV/m)	Factor (dB/m)	Result (dBuV/m)	Limit (dBuV/)	Over Limit (dB)	Detector	Height (cm)	degree (deg)	Remark
1	2362.800	48.68	-2.57	46.11	74.00	-27.89	peak			
2	2390.000	57.03	-2.51	54.52	74.00	-19.48	peak			
3	2400.000	66.06	-2.49	63.57	74.00	-10.43	peak			

AMB

Vertical-AV:

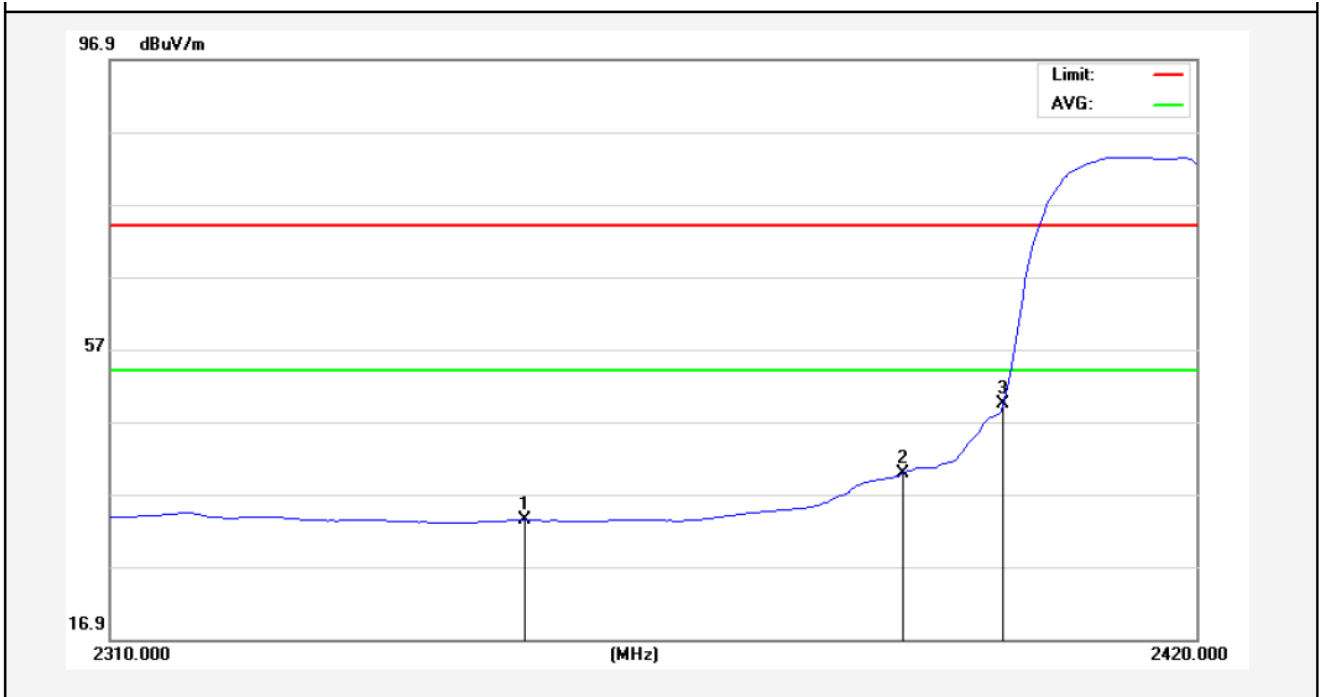

No.	Freq. (MHz)	Reading (dBuV/m)	Factor (dB/m)	Result (dBuV/m)	Limit (dBuV/)	Over Limit (dB)	Detector	Height (cm)	degree (deg)	Remark
1	2351.525	35.96	-2.60	33.36	54.00	-20.64	AVG			
2	2390.000	42.24	-2.51	39.73	54.00	-14.27	AVG			
3	2400.000	51.94	-2.49	49.45	54.00	-4.55	AVG			

Anbotek

Test Mode: 802.11n (HT40)
2452MHz
Horizontal-PEAK:

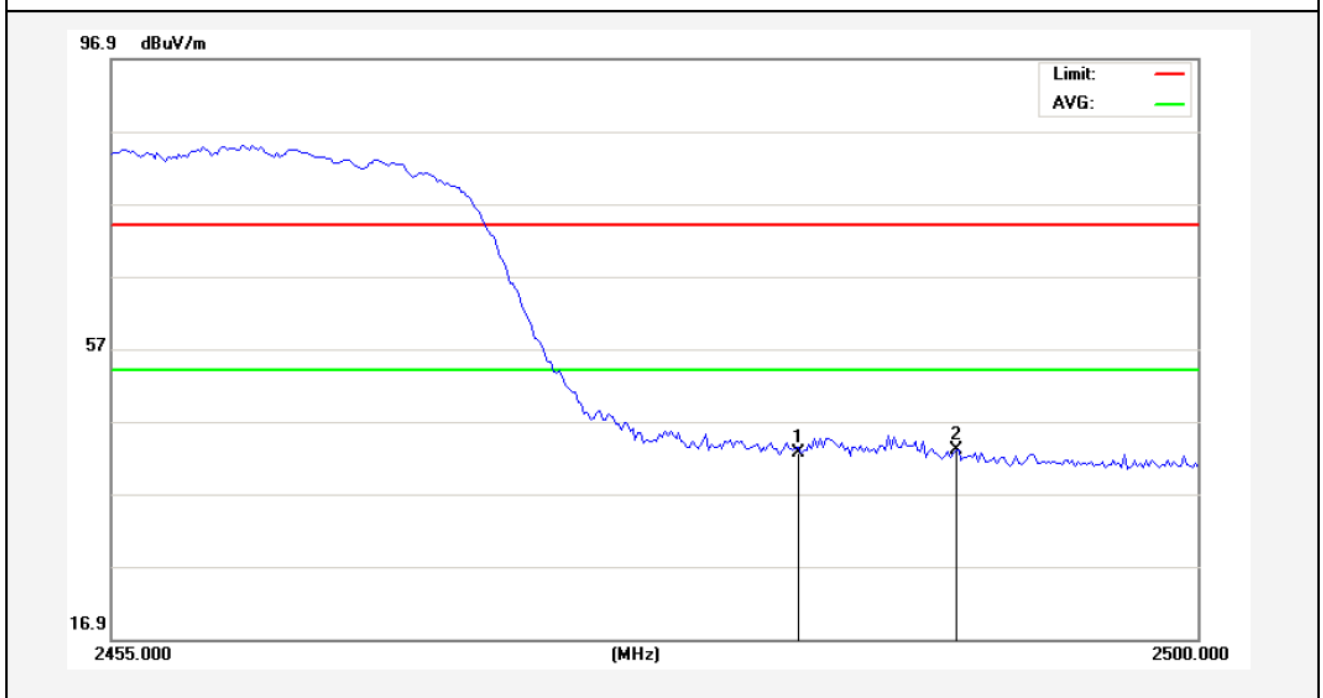

No.	Freq. (MHz)	Reading (dBuV/m)	Factor (dB/m)	Result (dBuV/m)	Limit (dBuV/)	Over Limit (dB)	Detector	Height (cm)	degree (deg)	Remark
1	2483.500	44.86	-2.31	42.55	74.00	-31.45	peak			
2	2489.988	45.36	-2.29	43.07	74.00	-30.93	peak			

Anbotek

Horizontal-AV:

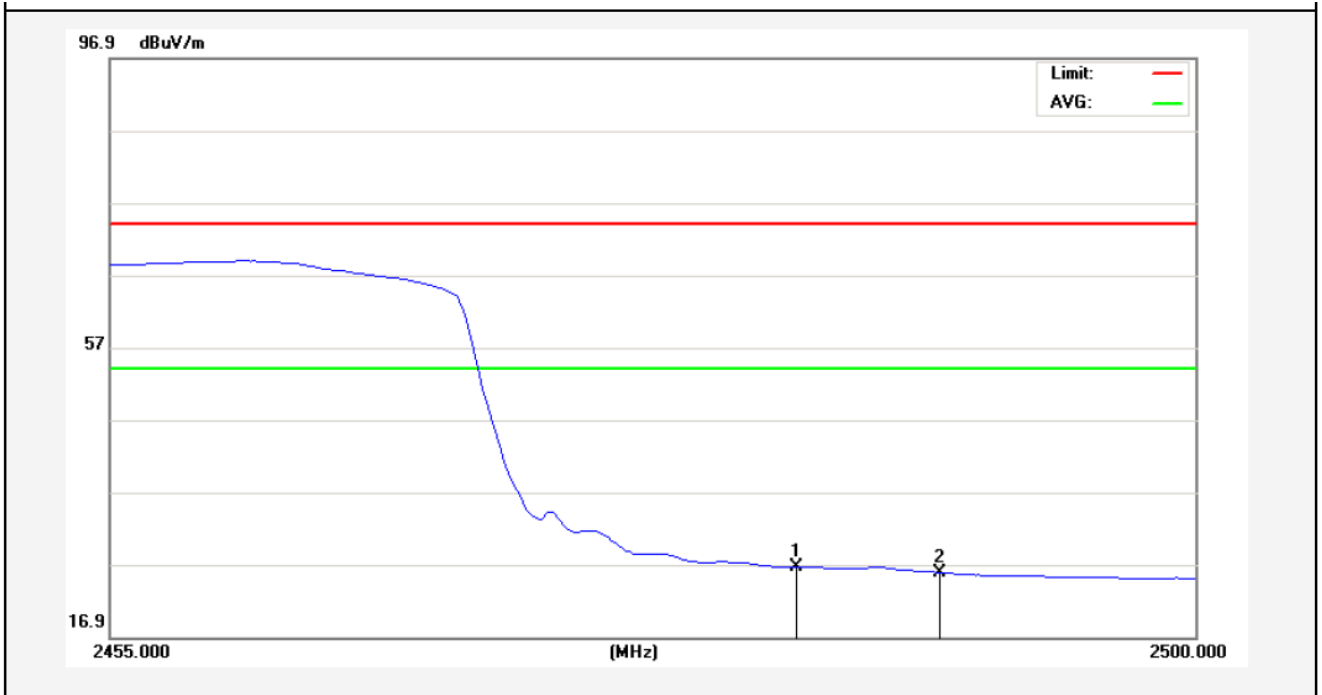

No.	Freq. (MHz)	Reading (dBuV/m)	Factor (dB/m)	Result (dBuV/m)	Limit (dBuV/)	Over Limit (dB)	Detector	Height (cm)	degree (deg)	Remark
1	2483.500	28.95	-2.31	26.64	54.00	-27.36	AVG			
2	2489.425	28.12	-2.29	25.83	54.00	-28.17	AVG			

Anbotek

Test Mode: 802.11n (HT40)
2452MHz
Vertical-PEAK:

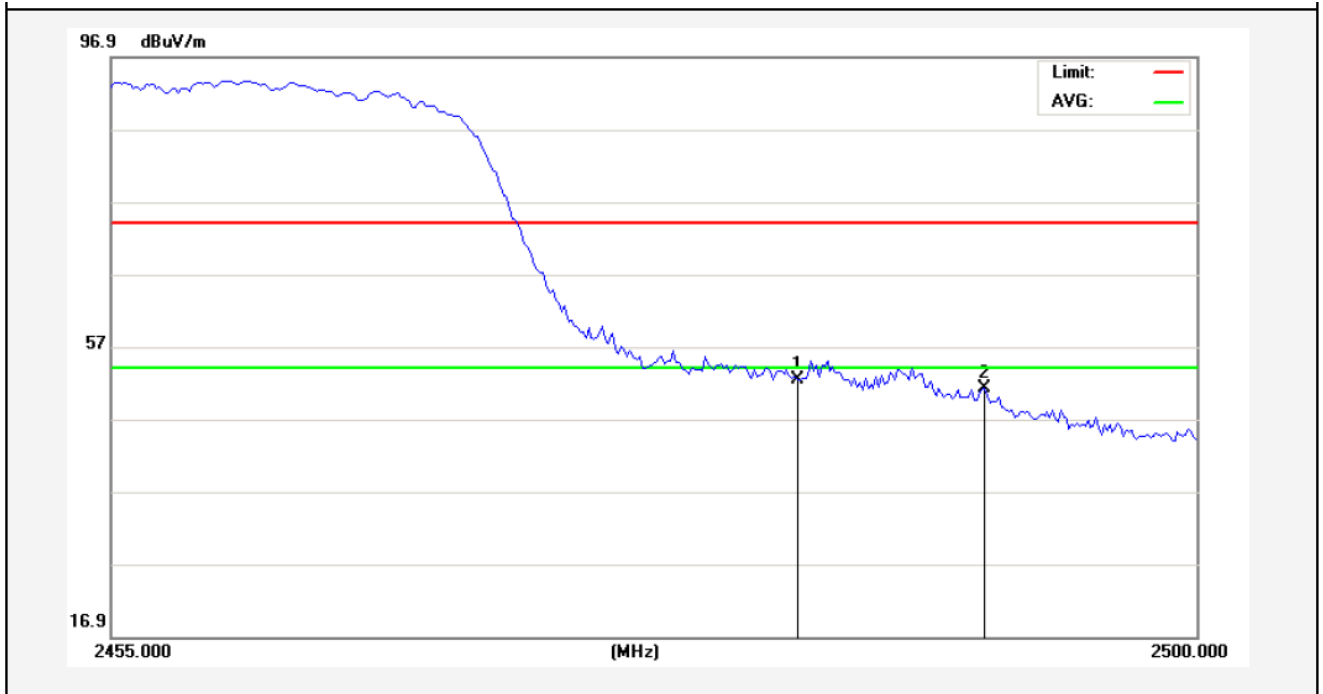

No.	Freq. (MHz)	Reading (dBuV/m)	Factor (dB/m)	Result (dBuV/m)	Limit (dBuV/)	Over Limit (dB)	Detector	Height (cm)	degree (deg)	Remark
1	2483.500	54.76	-2.31	52.45	74.00	-21.55	peak			
2	2491.225	53.46	-2.29	51.17	74.00	-22.83	peak			

Anbotek

Vertical-AV:

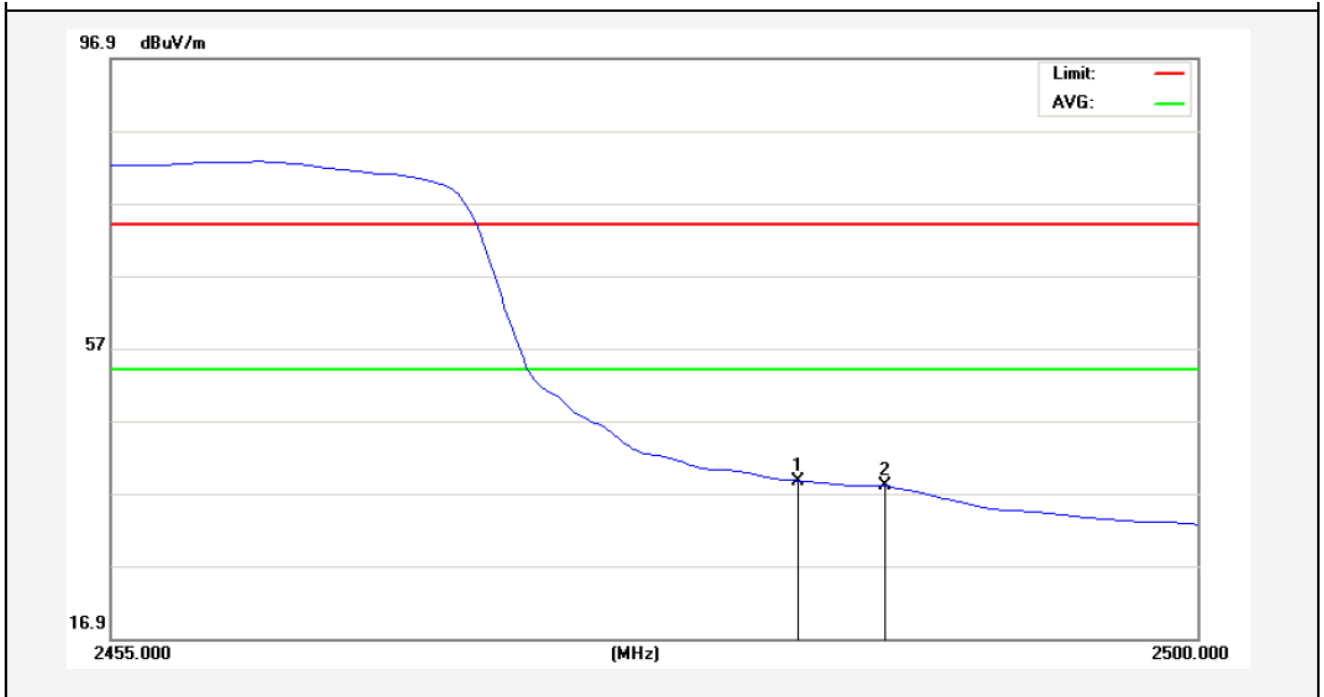

No.	Freq. (MHz)	Reading (dBuV/m)	Factor (dB/m)	Result (dBuV/m)	Limit (dBuV/)	Over Limit (dB)	Detector	Height (cm)	degree (deg)	Remark
1	2483.500	40.97	-2.31	38.66	54.00	-15.34	AVG			
2	2487.063	40.25	-2.30	37.95	54.00	-16.05	AVG			

Anbotek

4.5. Peak Power Spectral Density

a. Limit

1. For direct sequence systems, the peak power spectral density conducted from the intentional radiator to the antenna shall not be greater than 8dBm in any 3kHz band during any time interval of continuous transmission.
2. The direct sequence operating of the hybrid system, with the frequency hopping operation turned off, shall comply with the power density requirements of paragraph (d) of this section.

b. Test Procedure

1. Place the EUT on the table and set it in transmitting mode. Remove the antenna from the EUT and then connect a low loss RF cable from the antenna port to the spectrum analyzer.
2. Set the spectrum analyzer as RBW = 3kHz, VBW = 10kHz, Span = 1.5MHz, Sweep=500s
3. Record the max. reading.
4. Repeat the above procedure until the measurements for all frequencies are completed.

c. Test Equipment

Same as the equipment listed in 4.2.

d. Test Setup

See 4.1

e. Test Results

Pass

f. Test Data

Please refer to the following data.

g. Test Plot

See the following pages

Test mode: IEEE 802.11b

Channel	Frequency (MHz)	PPSD (dBm/3KHz)	ΣPPSD (dBm/3KHz)	Limit (dBm)	Result
Low	2412	-12.06	-	8.00	Pass
Mid	2437	-12.46	-		Pass
High	2462	-13.43	-		Pass

Test mode: IEEE 802.11g

Channel	Frequency (MHz)	PPSD (dBm)	ΣPPSD (dBm)	Limit (dBm)	Result
Low	2412	-16.43	-	8.00	Pass
Mid	2437	-16.81	-		Pass
High	2462	-17.88	-		Pass

Test mode: IEEE 802.11n (HT20)

Channel	Frequency (MHz)	PPSD (dBm/3KHz)	ΣPPSD (dBm/3KHz)	Limit (dBm)	Result
Low	2412	-17.23	-	8.00	Pass
Mid	2437	-17.62	-		Pass
High	2462	-18.48	-		Pass

Test mode: IEEE 802.11n (HT40)

Channel	Frequency (MHz)	PPSD (dBm/3KHz)	ΣPPSD (dBm/3KHz)	Limit (dBm)	Result
Low	2422	-18.36	-	8.00	Pass
Mid	2437	-18.44	-		Pass
High	2452	-18.73	-		Pass

802.11 b CH--Low

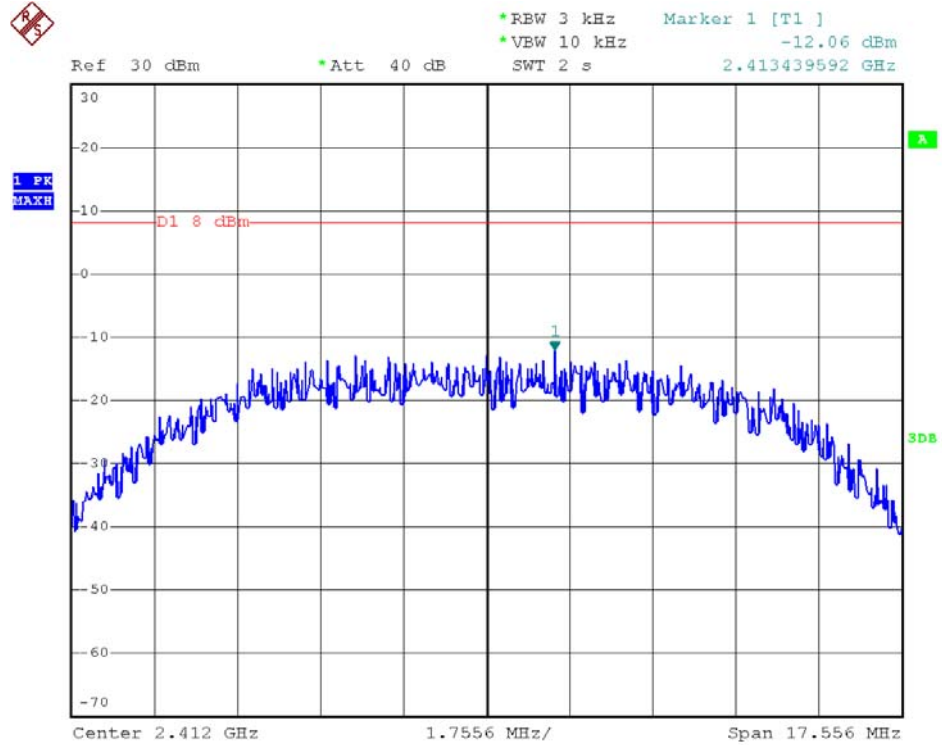

802.11 b CH--Mid

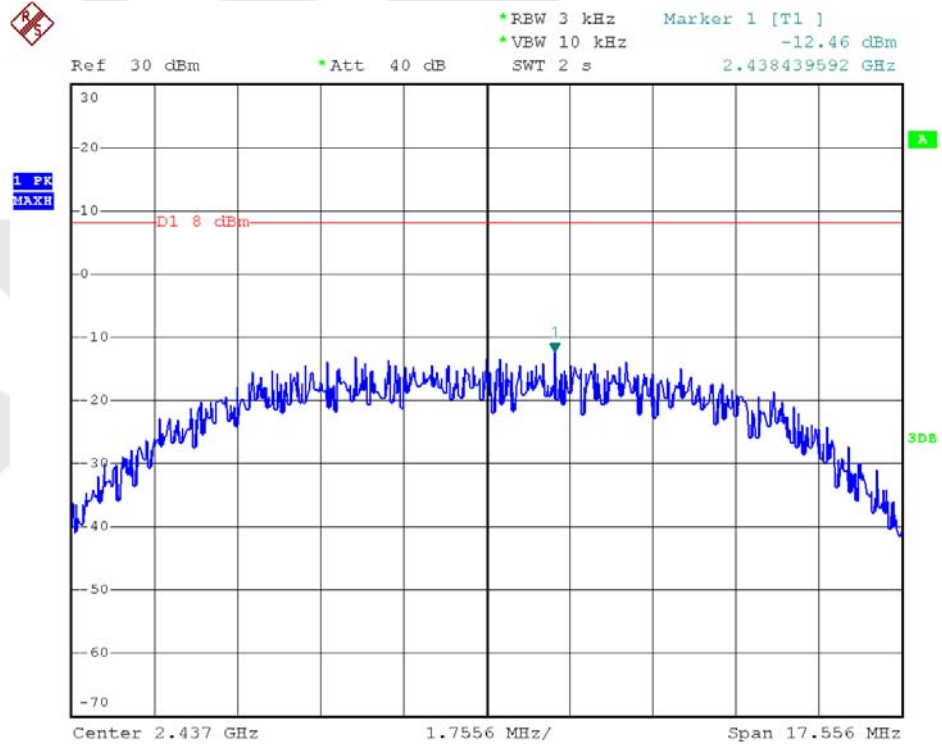

802.11 b CH--High

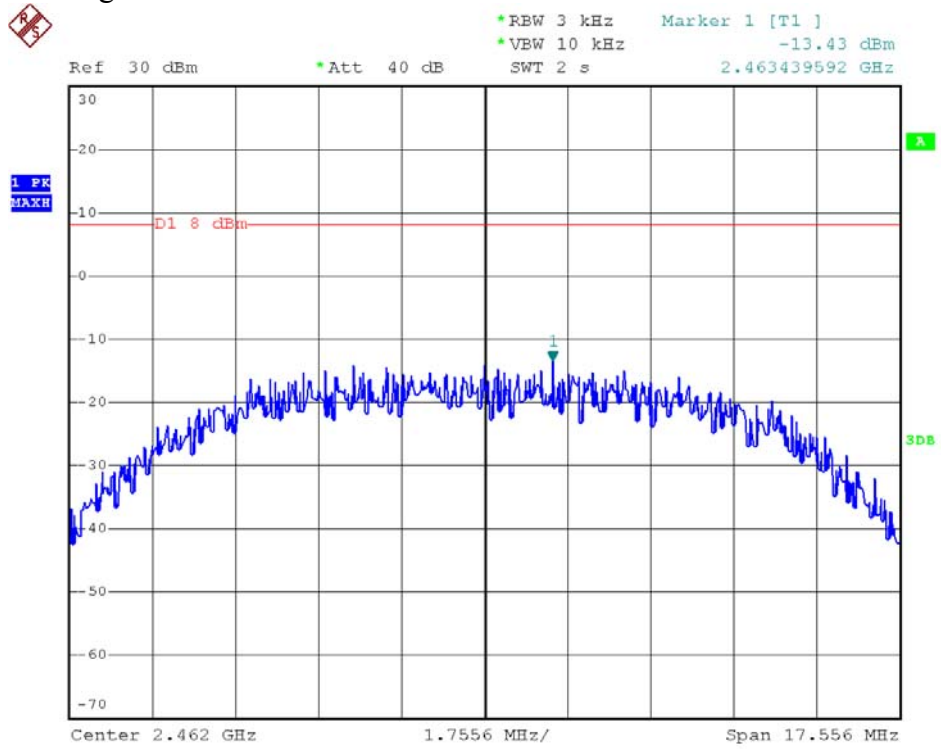

802.11g CH--Low

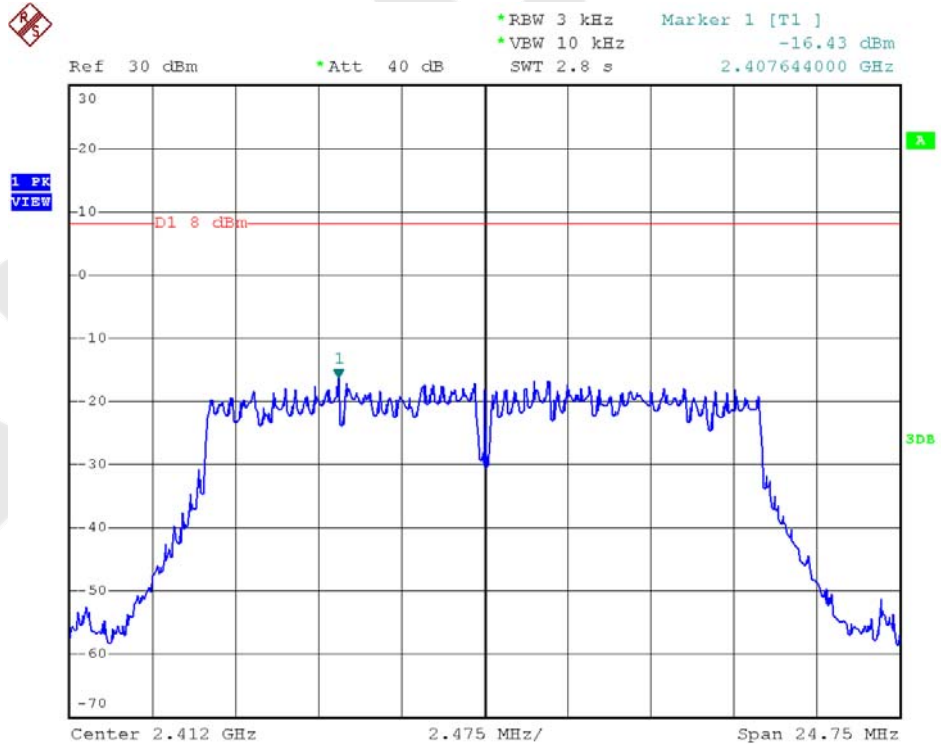

802.11g CH--Mid

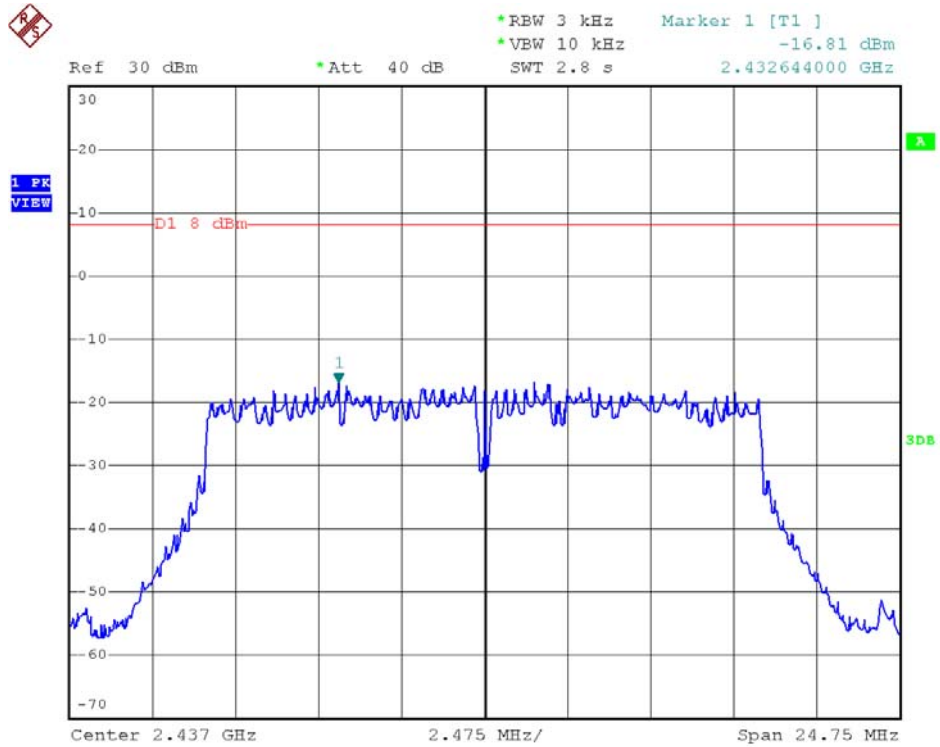

802.11g CH--High

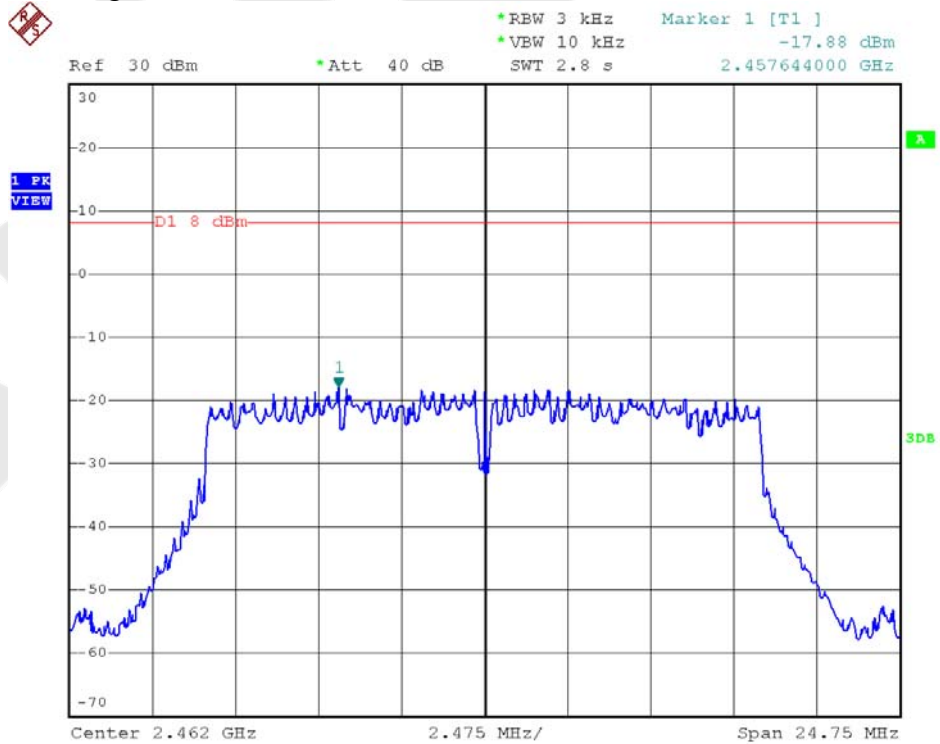

802.11n (HT20) CH—Low

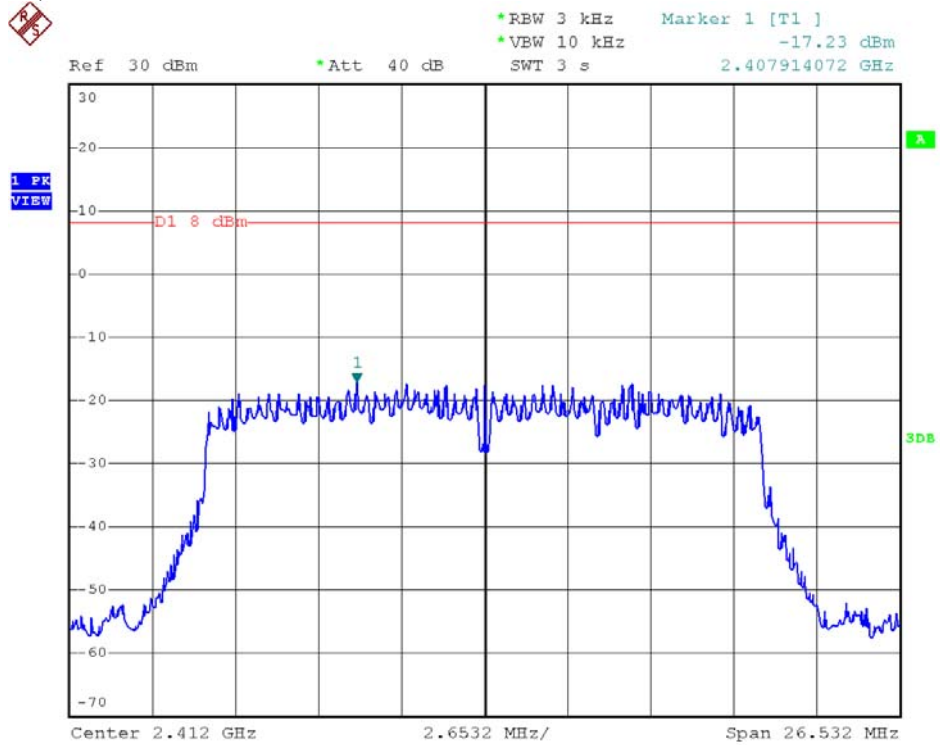

802.11n (HT20) CH—Mid

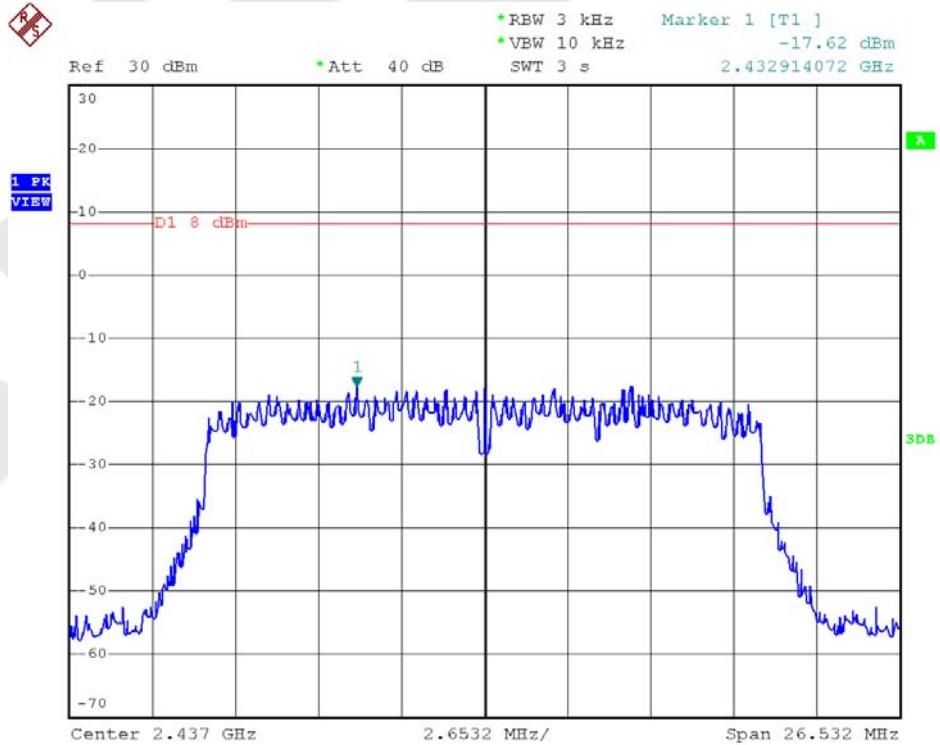

802.11n (HT20) CH—High

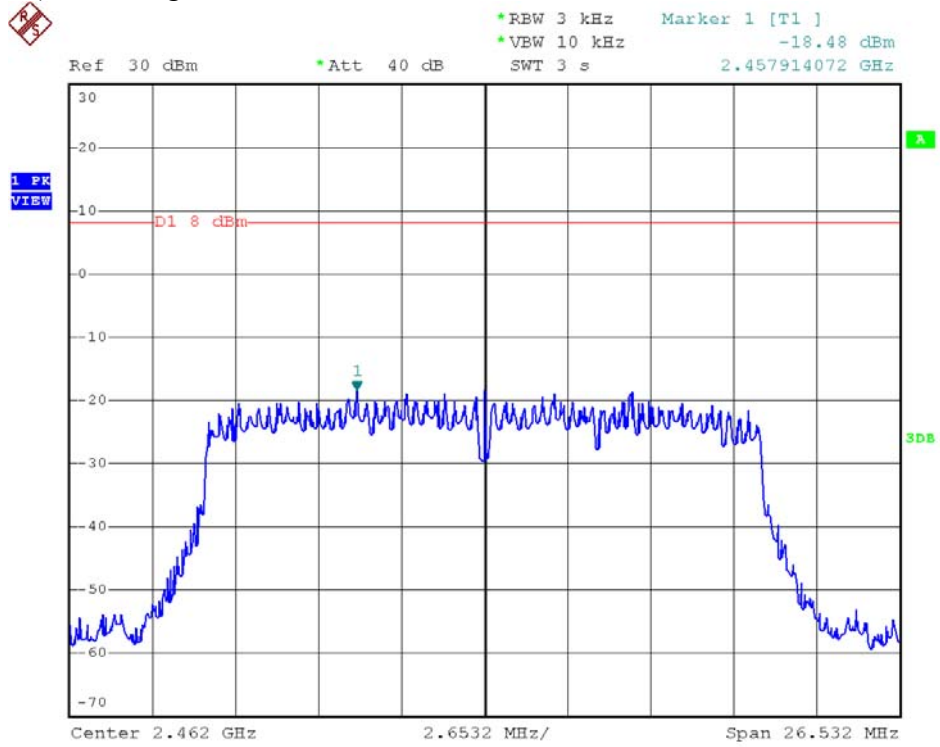

802.11n (HT40) CH—Low

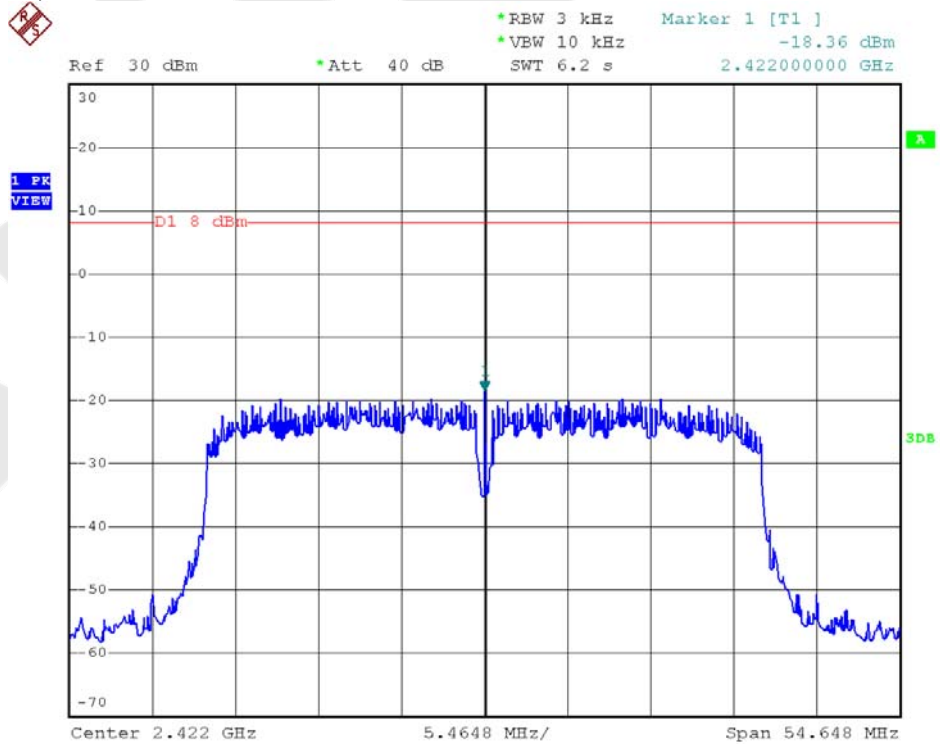

802.11n (HT40) CH—Mid

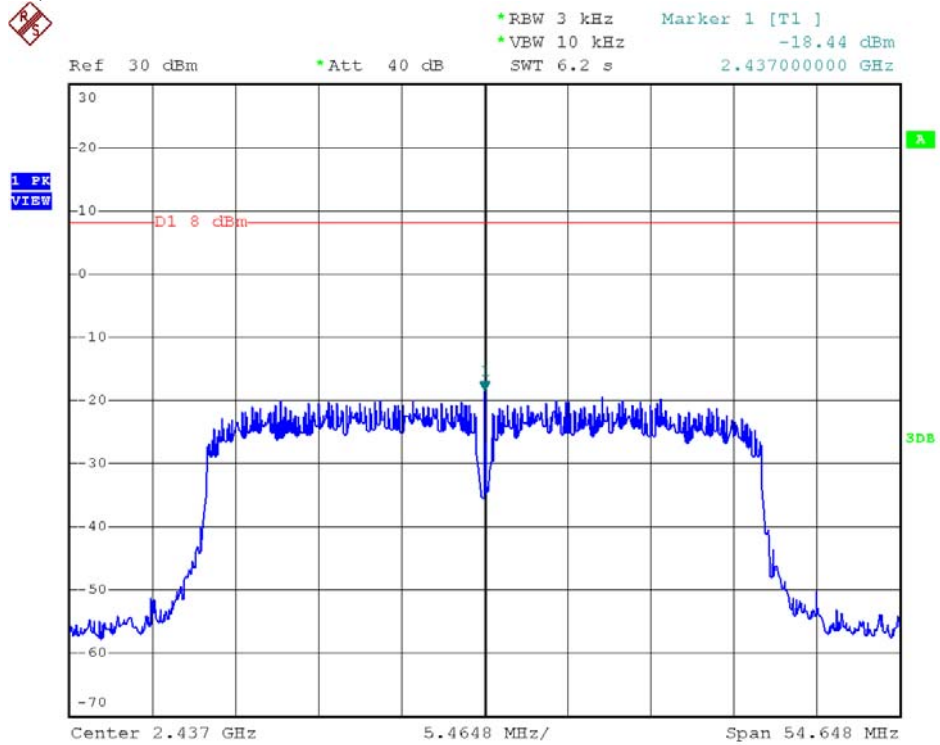

802.11n (HT40) CH—High

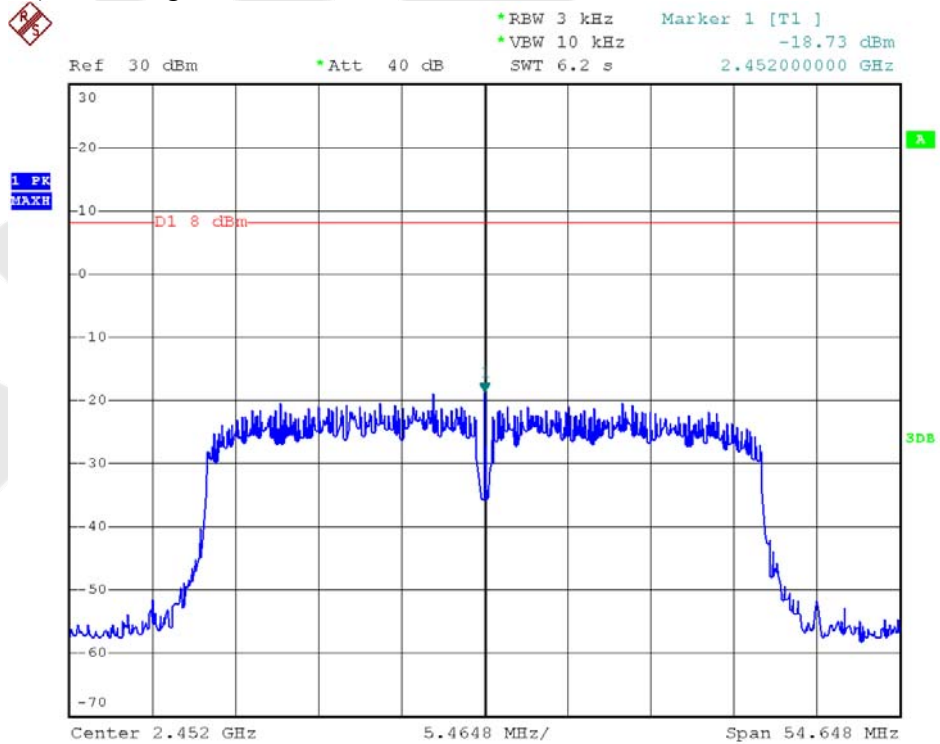

4.6. Radiated Emissions

4.6.1.1. Test Limits (< 30 MHz)

Frequency (MHz)	Field Strength (microvolts/meter)	Measurement Distance (meter)
0.009-0.490	2400/F(kHz)	300
0.490-1.705	24000/F(kHz)	30
1.705-30.0	30	30

4.6.1.2. Test Limits (\geq 30 MHz)

FIELD STRENGTH of Fundamental: @3M	FIELD STRENGTH of Harmonics	S15.209	
902-928 MHz		30 - 88 MHz	40 dBuV/m
2.4-2.4835 GHz		88 - 216 MHz	43.5
94 dB μ V/m @3m	54 dB μ V/m @3m	216 - 960 MHz	46
		ABOVE 960 MHz	54dBuV/m

In any 100 kHz bandwidth outside the frequency band in which the spread spectrum or digitally modulated intentional radiator is operating, the radio frequency power that is produced by the intentional radiator shall be at least 20 dB below that in the 100 kHz bandwidth within the band that contains the highest level of the desired power, based on either an RF conducted or a radiated measurement. Attenuation below the general limits specified in Section 15.209(a) is not required. In addition, radiated emissions which fall in the restricted bands, as defined in Section 15.205(a), must also comply with the radiated emission limits specified in Section 15.209(a) (see Section 15.205(c)).

Test Equipment

Item	Equipment	Manufacturer	Model No.	Serial No.	Last Cal.	Cal. Interval
1.	Preamplifier	Instruments corporation	EMC011830	980100	Aug. 09, 2014	1 Year
2.	EMI Test Receiver	Rohde & Schwarz	ESPI	101604	Apr. 23, 2014	1 Year
3.	Double Ridged Horn Antenna	Instruments corporation	GTH-0118	351600	Aug. 09, 2013	3 Year
4.	Bilog Broadband Antenna	Schwarzbeck	VULB9163	VULB 9163-289	Apr. 23, 2013	3 Year
5.	Pre-amplifier	SONOMA	310N	186860	Apr. 23, 2014	1 Year
6.	EMI Test Software EZ-EMC	SHURPLE	N/A	N/A	N/A	N/A

4.6.2. Test Configuration:

4.6.2.1. 9k to 30MHz emissions:

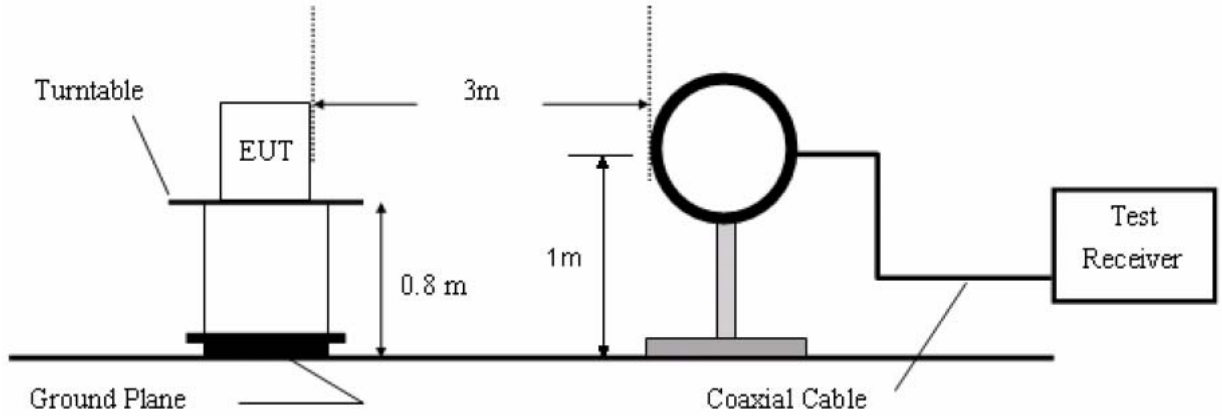

4.6.2.2. 30M to 1G emissions:

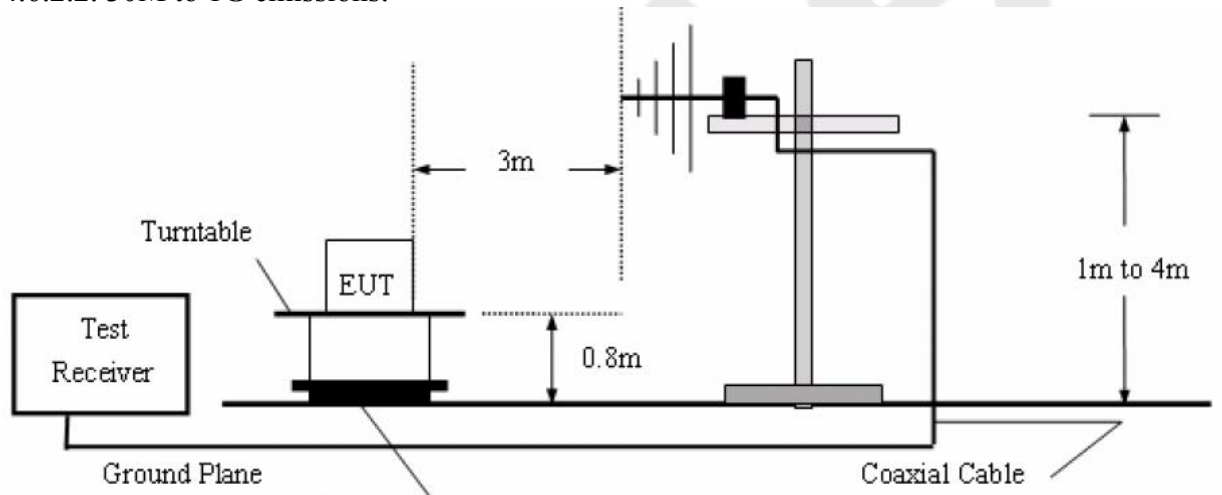

4.6.2.3. 1G to 40G emissions:

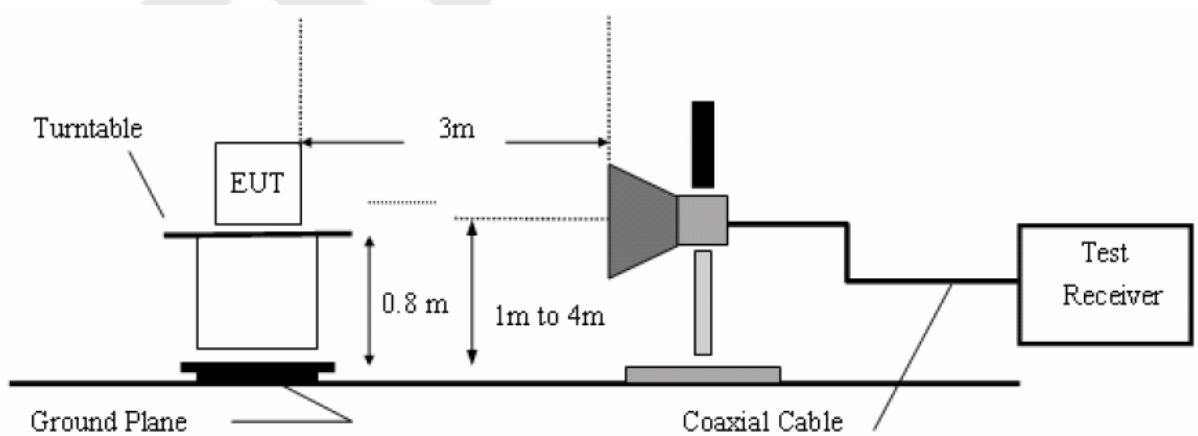

4.6.3. Test Procedure

The EUT is placed on a turn table which is 0.8 meter high above the ground. The turn table can rotate 360 degrees to determine the position of the maximum emission level. The EUT is set 3 meters away from the receiving antenna which is mounted on a antenna tower. The antenna can be moved up and down from 1 to 4 meters to find out the maximum emission level. Both horizontal and vertical polarization of the antenna are set on test.

Measurements are made on 9KHz to 30MHz and 30MHz to 26GHz range with the transmitter set to the lowest, middle, and highest channels.

All readings from 30MHz to 1GHz are quasi-peak values with a resolution bandwidth of 120kHz. All reading are above 1GHz, peak & average values with a resolution bandwidth of 1MHz.

The EUT is tested in 9*6*6 Chamber.

The test results are listed in Section 4.6.4.

4.6.4. Test Results

The EUT was tested on (WiFi Mode, RJ45 Mode) modes, only the worst data of (WiFi Mode) is attached in the following pages.

Job No.:	011407005E	Polarization:	Horizontal
Standard:	(RE)FCC PART15 C _3m	Power Source:	AC 120V/60Hz for Adapter
Test item:	Radiation Test	Temp.(C)/Hum.(%RH):	24.3(C)/55%RH
Test Mode:	WiFi Mode	Distance:	3m

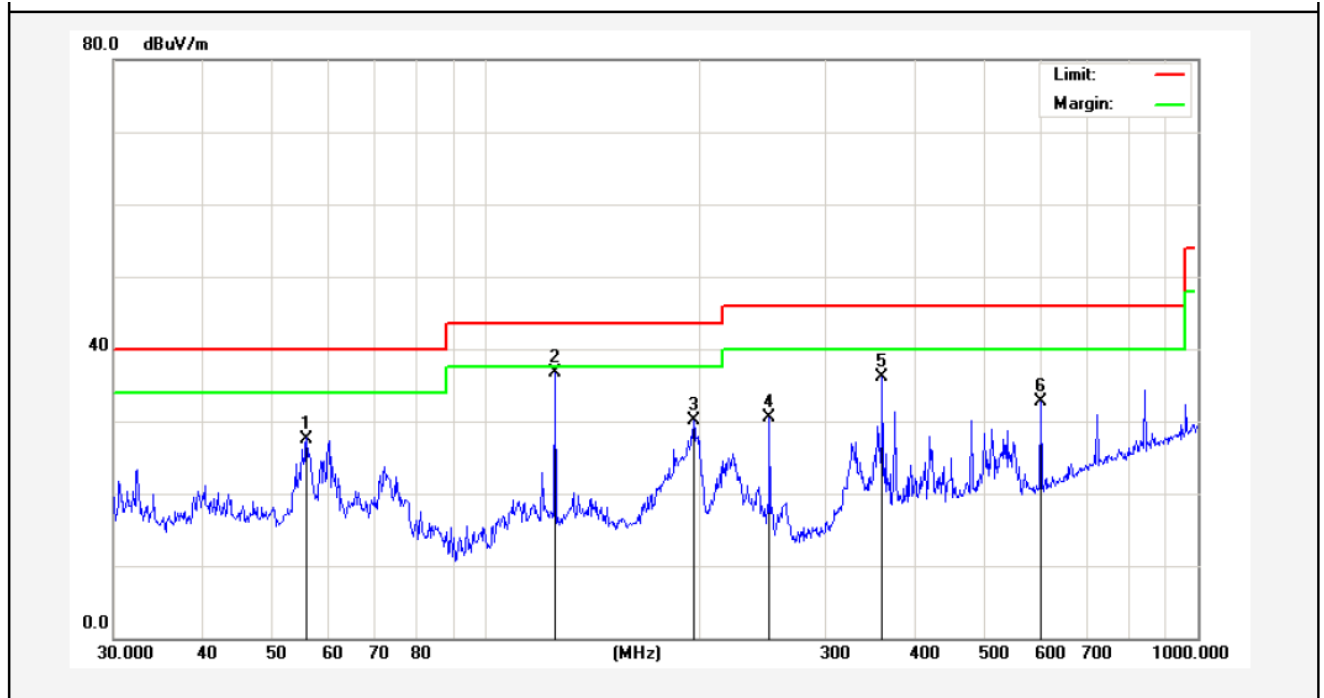

No.	Freq. (MHz)	Reading (dBuV/m)	Factor (dB/m)	Result (dBuV/m)	Limit (dBuV/)	Over Limit (dB)	Detector	Height (cm)	degree (deg)	Remark
1	56.0007	42.63	-15.03	27.60	40.00	-12.40	peak			
2	125.0066	58.75	-22.08	36.67	43.50	-6.83	peak			
3	195.8220	51.05	-20.89	30.16	43.50	-13.34	peak			
4	250.3012	49.14	-18.56	30.58	46.00	-15.42	peak			
5	360.4476	49.83	-13.65	36.18	46.00	-9.82	peak			
6	601.4265	43.98	-11.20	32.78	46.00	-13.22	peak			

Job No.:	011407005E	Polarization:	Vertical
Standard:	(RE)FCC PART15 C_3m	Power Source:	AC 120V/60Hz for Adapter
Test item:	Radiation Test	Temp.(C)/Hum.(%RH):	24.3(C)/55%RH
Test Mode:	WiFi Mode	Distance:	3m

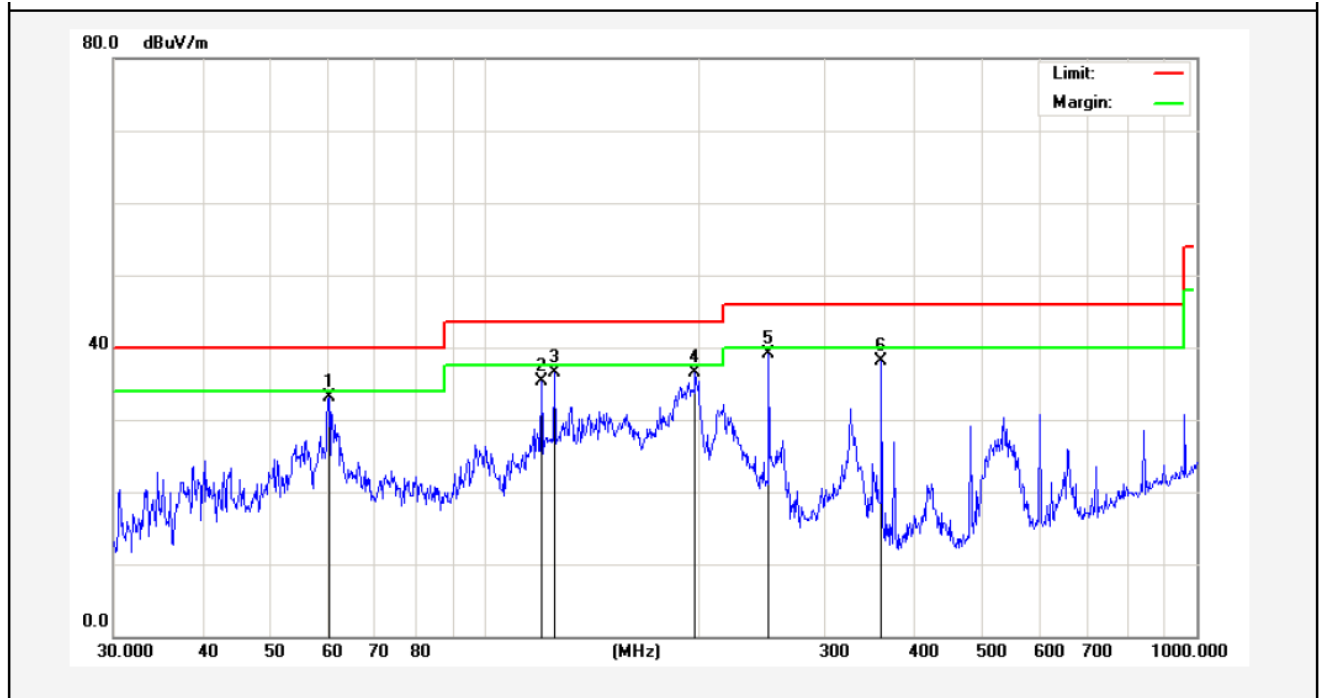

No.	Freq. (MHz)	Reading (dBuV/m)	Factor (dB/m)	Result (dBuV/m)	Limit (dBuV/)	Over Limit (dB)	Detector	Height (cm)	degree (deg)	Remark
1	60.2800	48.60	-15.51	33.09	40.00	-6.91	peak			
2	119.8555	51.63	-16.32	35.31	43.50	-8.19	peak			
3	125.0066	53.55	-17.08	36.47	43.50	-7.03	peak			
4	197.2000	52.47	-15.89	36.58	43.50	-6.92	peak			
5	250.3011	53.19	-14.04	39.15	46.00	-6.85	peak			
6	360.4476	50.84	-12.65	38.19	46.00	-7.81	peak			

Job No.:	011407005E	Polarization:	Horizontal
Standard:	(RE)FCC PART15 C _3m	Power Source:	AC 120V/60Hz for Adapter
Test item:	Radiation Test	Temp.(C)/Hum.(%RH):	24.3(C)/55%RH
Note:	802.11b(2412MHz)	Distance:	3m

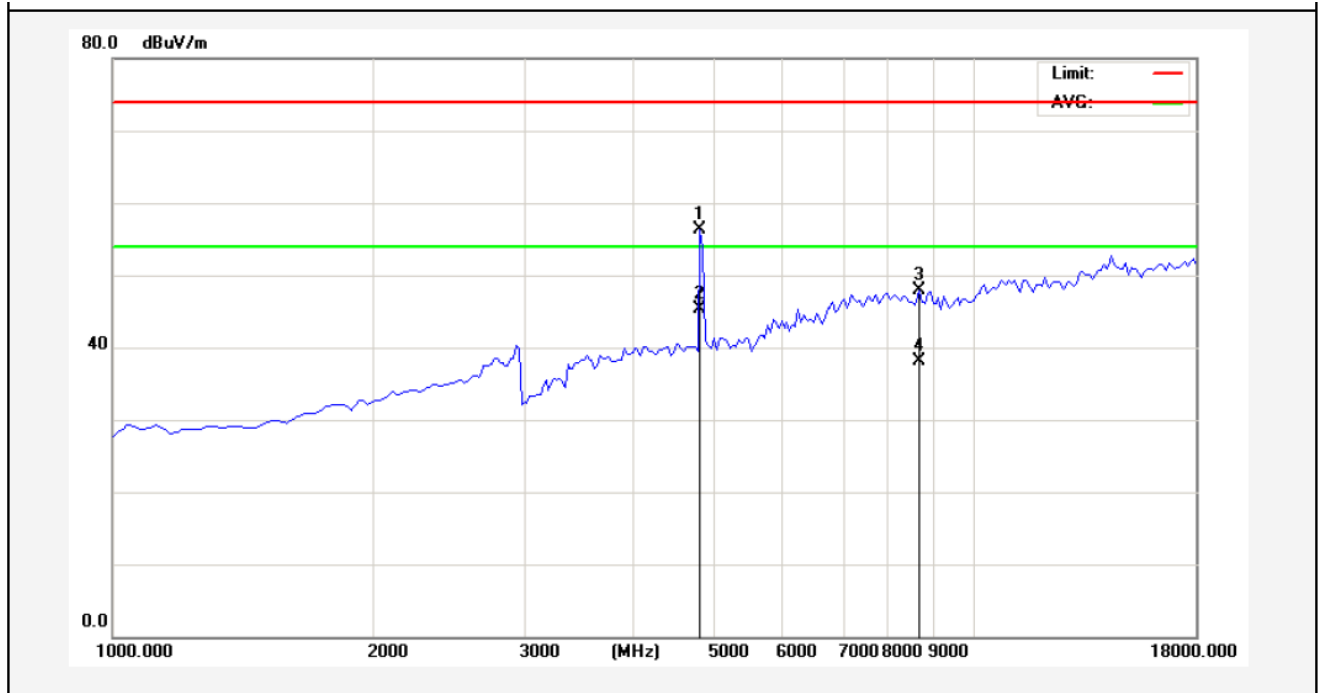

No.	Freq. (MHz)	Reading (dBuV/m)	Factor (dB/m)	Result (dBuV/m)	Limit (dBuV/)	Over Limit (dB)	Detector	Height (cm)	degree (deg)	Remark
1	4825.000	52.87	3.34	56.21	74.00	-17.79	peak			
2	4825.000	41.95	3.34	45.29	54.00	-8.71	AVG			
3	8650.000	38.17	9.66	47.83	74.00	-26.17	peak			
4	8650.000	28.45	9.66	38.11	54.00	-15.89	AVG			

Job No.:	011407005E	Polarization:	Vertical
Standard:	(RE)FCC PART15 C_3m	Power Source:	AC 120V/60Hz for Adapter
Test item:	Radiation Test	Temp.(C)/Hum.(%RH):	24.3(C)/55%RH
Note:	802.11b(2412MHz)	Distance:	3m

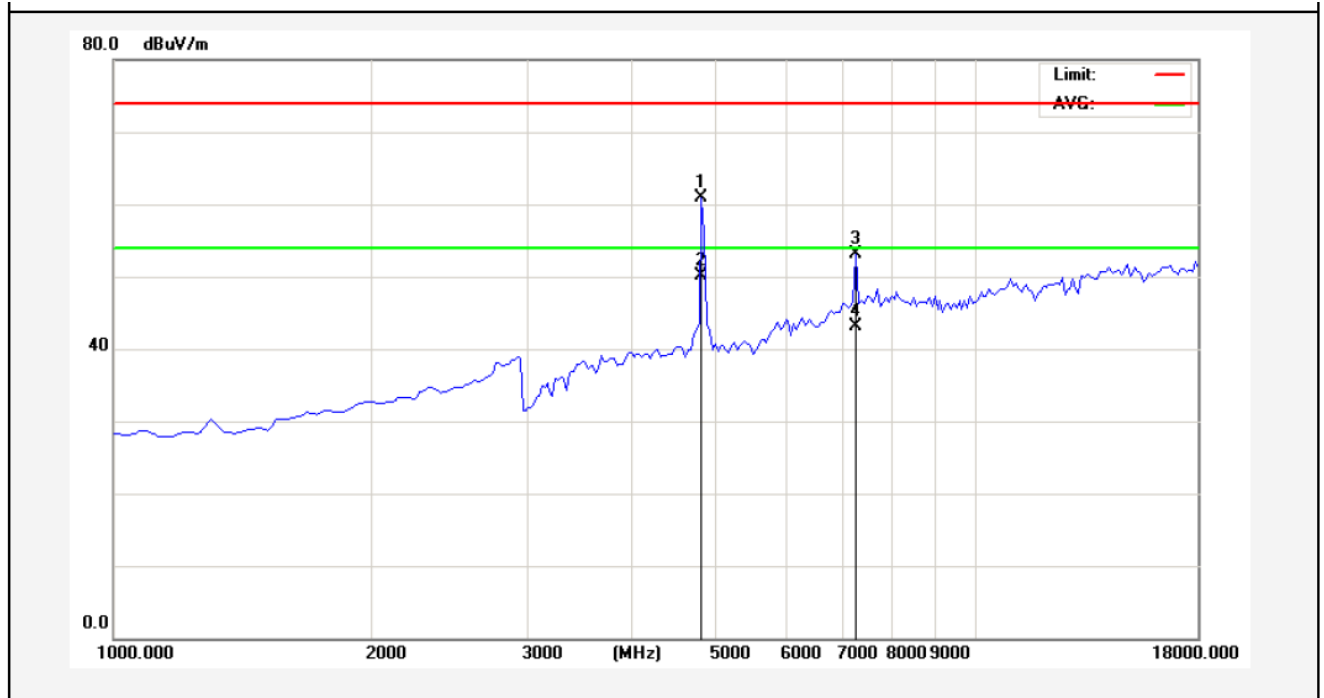

No.	Freq. (MHz)	Reading (dBuV/m)	Factor (dB/m)	Result (dBuV/m)	Limit (dBuV/)	Over Limit (dB)	Detector	Height (cm)	degree (deg)	Remark
1	4825.000	57.47	3.34	60.81	74.00	-13.19	peak			
2	4825.000	46.78	3.34	50.12	54.00	-3.88	AVG			
3	7247.500	44.64	8.48	53.12	74.00	-20.88	peak			
4	7247.500	34.62	8.48	43.10	54.00	-10.90	AVG			

Job No.:	011407005E	Polarization:	Horizontal
Standard:	(RE)FCC PART15 C_3m	Power Source:	AC 120V/60Hz for Adapter
Test item:	Radiation Test	Temp.(C)/Hum.(%RH):	24.3(C)/55%RH
Note:	802.11b(2437MHz)	Distance:	3m

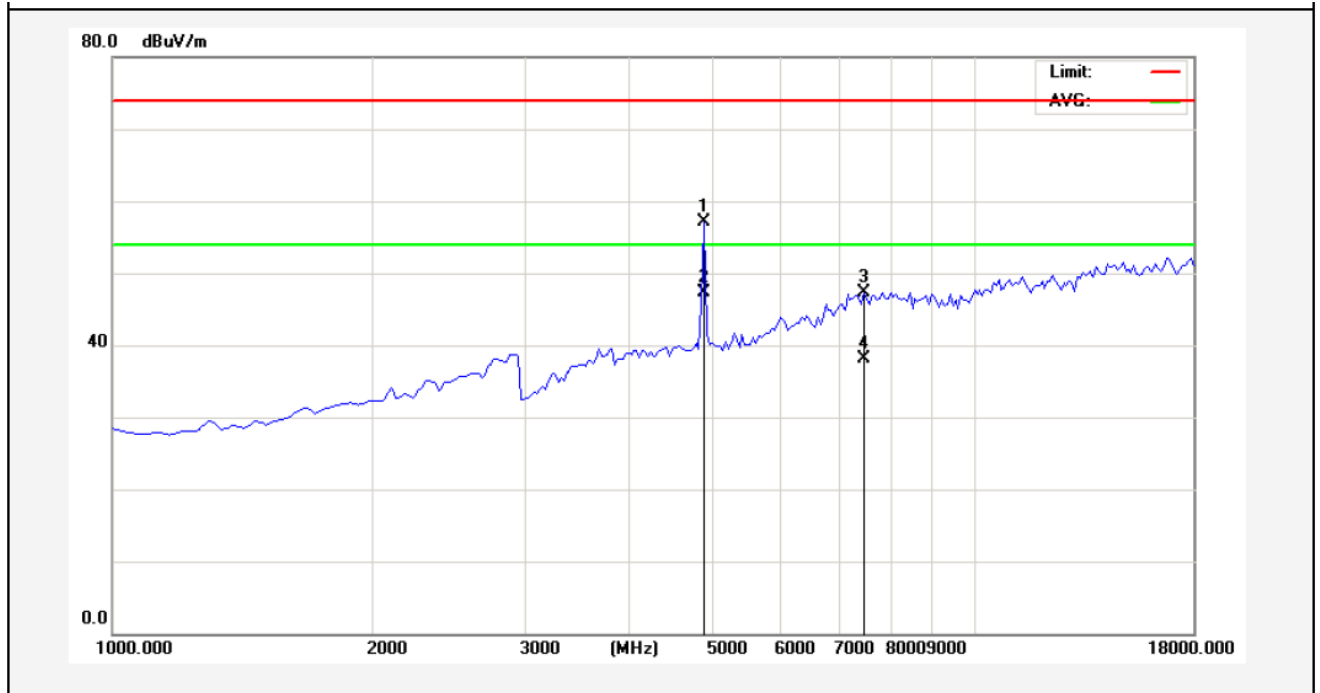

No.	Freq. (MHz)	Reading (dBuV/m)	Factor (dB/m)	Result (dBuV/m)	Limit (dBuV/)	Over Limit (dB)	Detector	Height (cm)	degree (deg)	Remark
1	4867.500	53.74	3.41	57.15	74.00	-16.85	peak			
2	4867.500	43.81	3.41	47.22	54.00	-6.78	AVG			
3	7502.500	38.52	8.78	47.30	74.00	-26.70	peak			
4	7502.500	29.39	8.78	38.17	54.00	-15.83	AVG			

Job No.:	011407005E	Polarization:	Vertical
Standard:	(RE)FCC PART15 C _3m	Power Source:	AC 120V/60Hz for Adapter
Test item:	Radiation Test	Temp.(C)/Hum.(%RH):	24.3(C)/55%RH
Note:	802.11b(2437MHz)	Distance:	3m

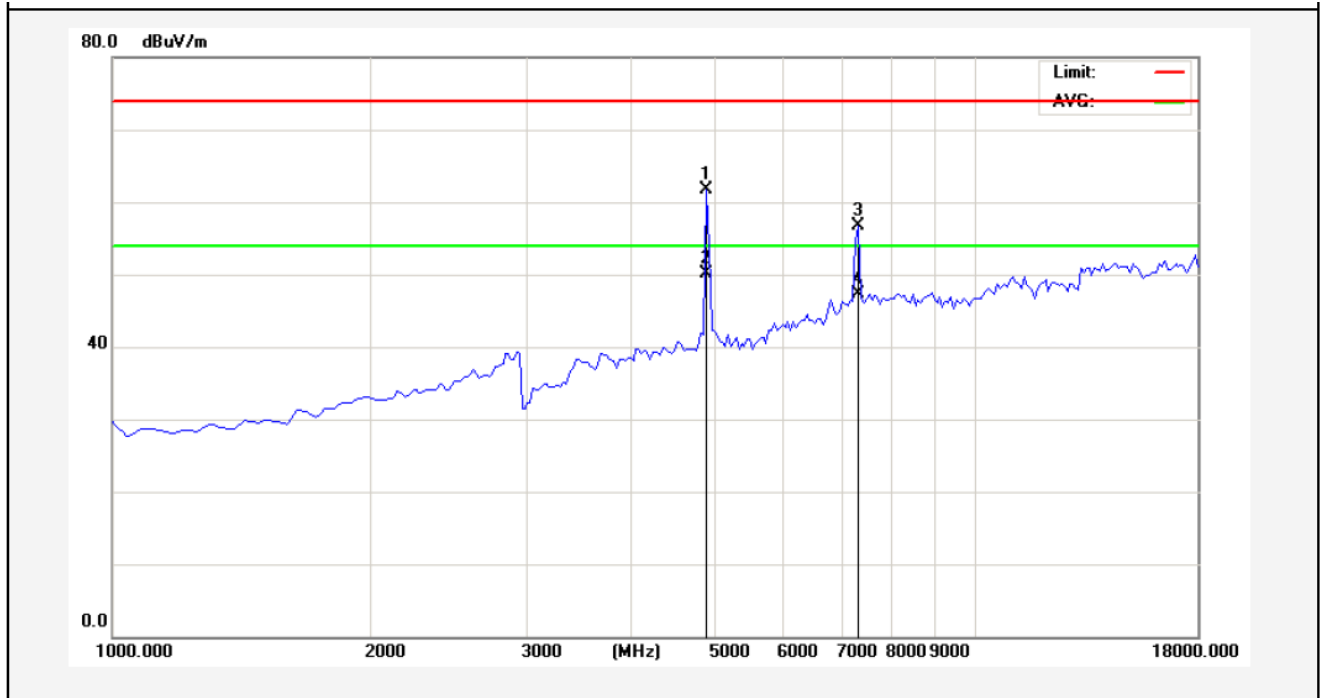

No.	Freq. (MHz)	Reading (dBuV/m)	Factor (dB/m)	Result (dBuV/m)	Limit (dBuV/)	Over Limit (dB)	Detector	Height (cm)	degree (deg)	Remark
1	4867.500	58.34	3.41	61.75	74.00	-12.25	peak			
2	4867.500	46.70	3.41	50.11	54.00	-3.89	AVG			
3	7332.500	48.05	8.58	56.63	74.00	-17.37	peak			
4	7332.500	38.77	8.58	47.35	54.00	-6.65	AVG			

Job No.:	011407005E	Polarization:	Horizontal
Standard:	(RE)FCC PART15 C_3m	Power Source:	AC 120V/60Hz for Adapter
Test item:	Radiation Test	Temp.(C)/Hum.(%RH):	24.3(C)/55%RH
Note:	802.11b(2462MHz)	Distance:	3m

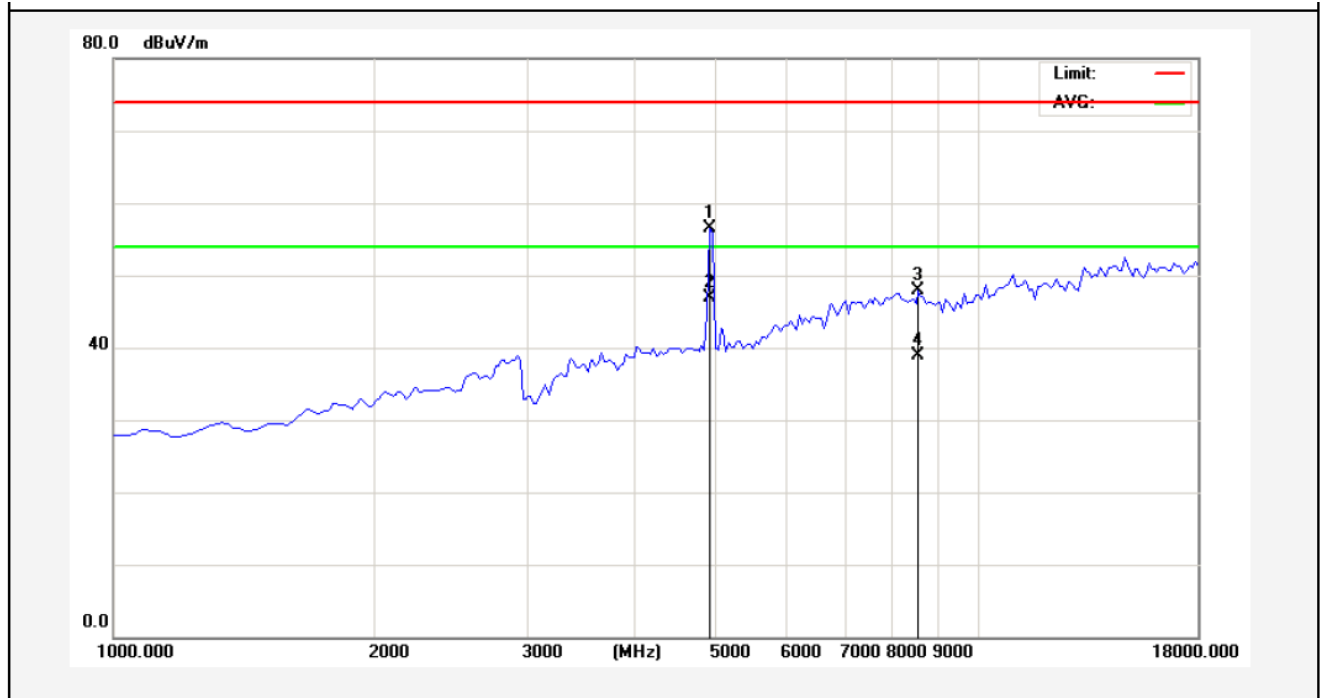

No.	Freq. (MHz)	Reading (dBuV/m)	Factor (dB/m)	Result (dBuV/m)	Limit (dBuV/)	Over Limit (dB)	Detector	Height (cm)	degree (deg)	Remark
1	4910.000	52.93	3.49	56.42	74.00	-17.58	peak			
2	4910.000	43.36	3.49	46.85	54.00	-7.15	AVG			
3	8565.000	38.22	9.65	47.87	74.00	-26.13	peak			
4	8565.000	29.31	9.65	38.96	54.00	-15.04	AVG			

Job No.:	011407005E	Polarization:	Vertical
Standard:	(RE)FCC PART15 C_3m	Power Source:	AC 120V/60Hz for Adapter
Test item:	Radiation Test	Temp.(C)/Hum.(%RH):	24.3(C)/55%RH
Note:	802.11b(2462MHz)	Distance:	3m

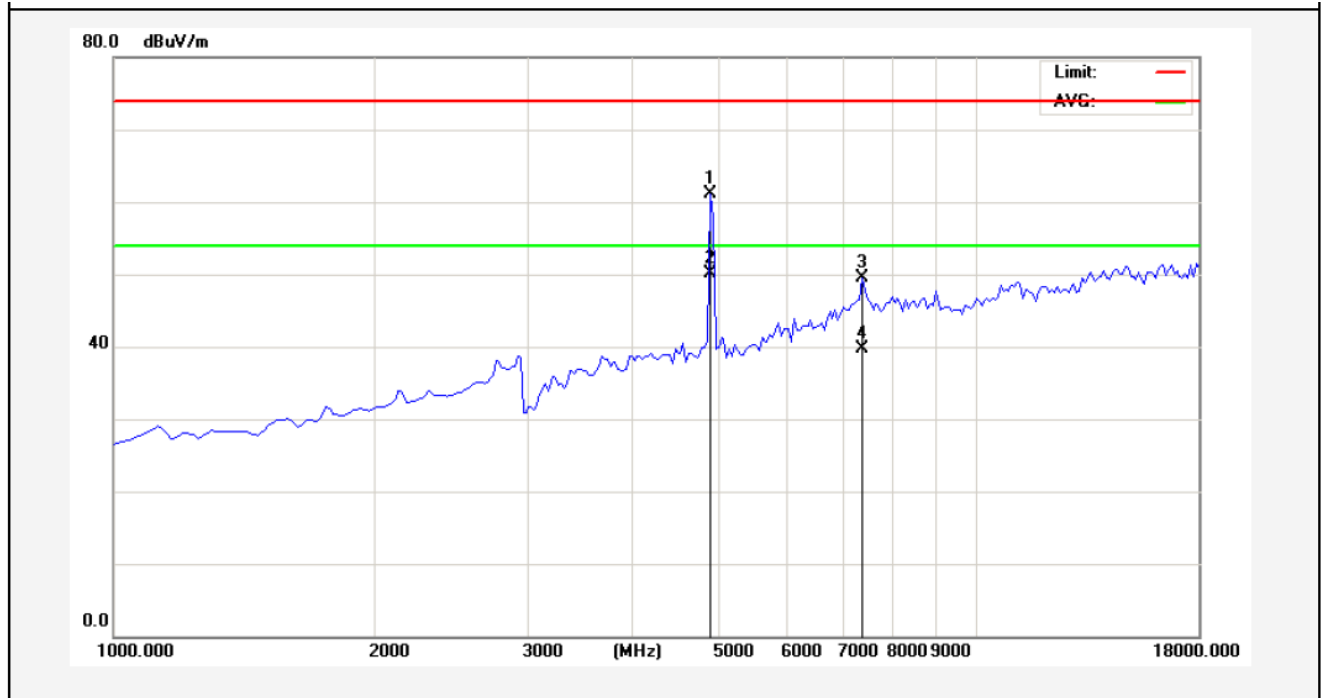

No.	Freq. (MHz)	Reading (dBuV/m)	Factor (dB/m)	Result (dBuV/m)	Limit (dBuV/)	Over Limit (dB)	Detector	Height (cm)	degree (deg)	Remark
1	4910.000	57.53	3.49	61.02	74.00	-12.98	peak			
2	4910.000	46.62	3.49	50.11	54.00	-3.89	AVG			
3	7375.000	40.95	8.63	49.58	74.00	-24.42	peak			
4	7375.000	31.01	8.63	39.64	54.00	-14.36	AVG			

5. PHOTOGRAPH

5.1. Photo of Conducted Emission Measurement



5.2. Photo of Radiation Emission Test

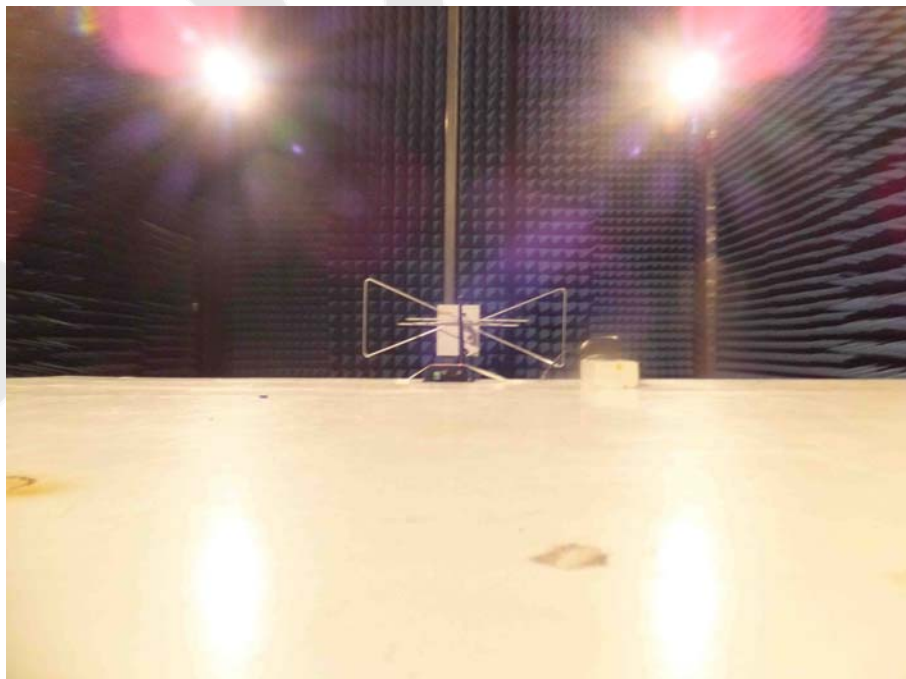

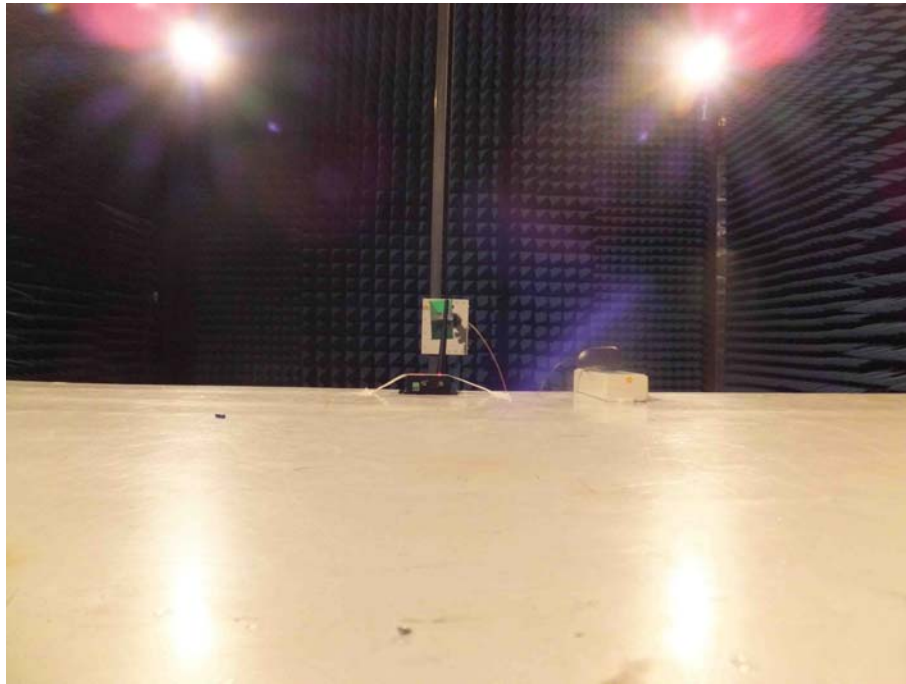

Anbotek

APPENDIX I (EXTERNAL PHOTOS)

Figure 1
The EUT-Overall View



Figure 2
The EUT-Top View



Figure 3
The EUT-Bottom View



Figure 4
The EUT-Left View

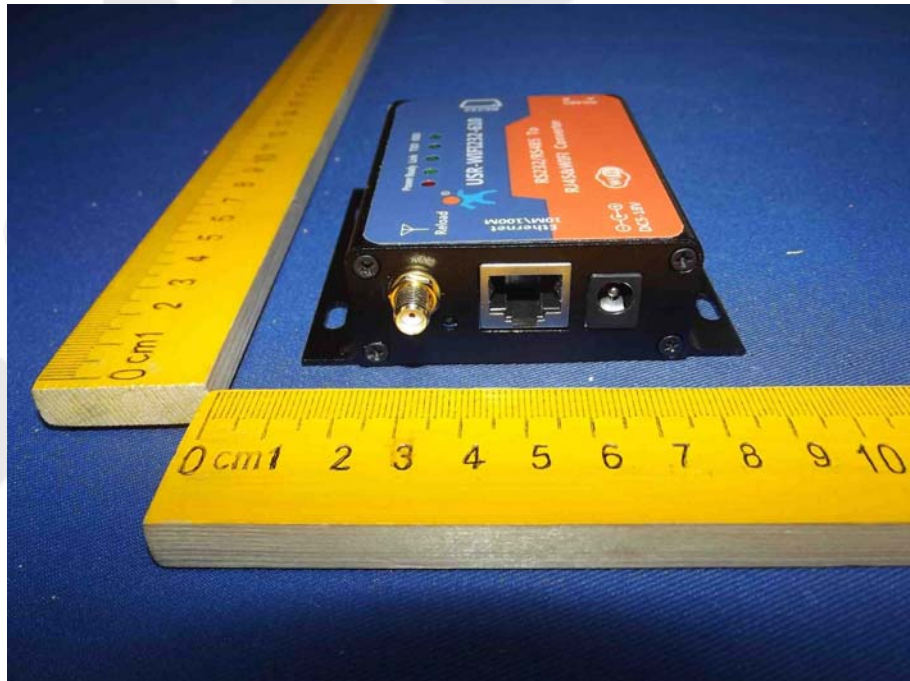

Figure 5
The EUT-Right View

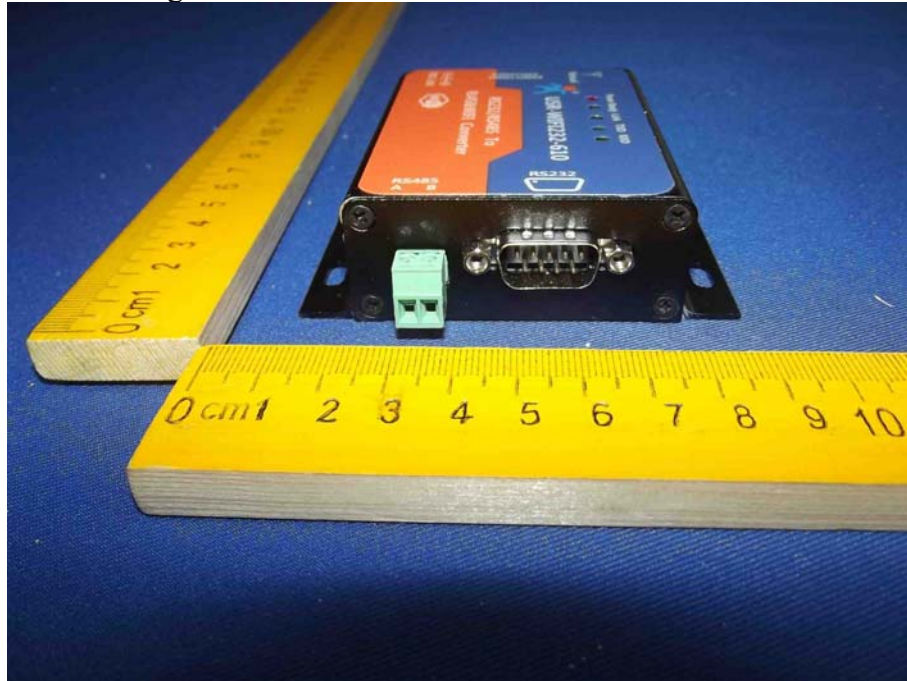

Figure 6
The EUT-Front View



Figure 7
The EUT-Back View



Anbotek

APPENDIX II (INTERNAL PHOTOS)

Figure 8
The EUT-Inside View

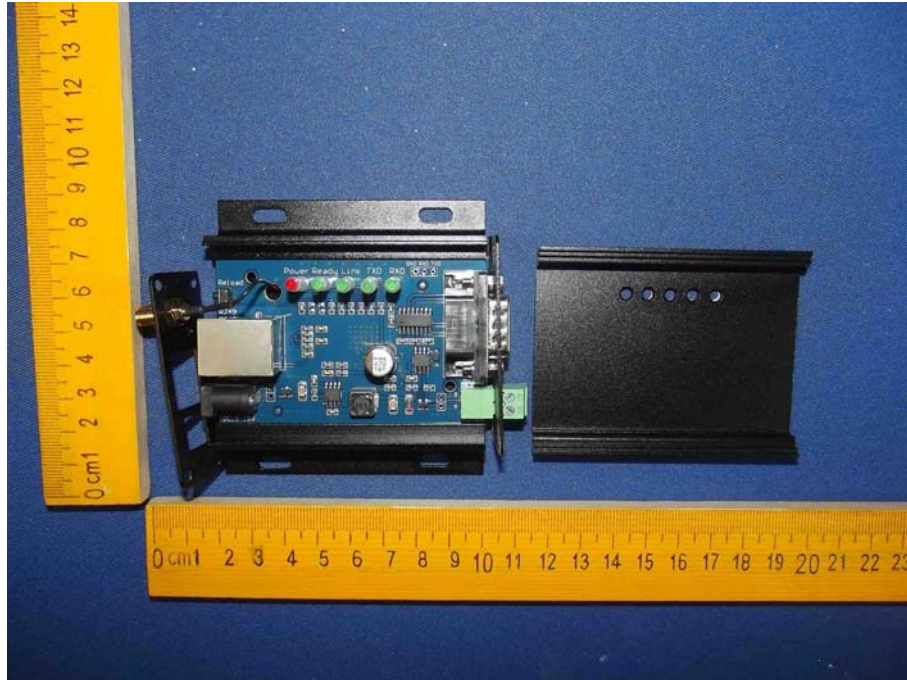

Figure 9
PCB of The EUT-Front View

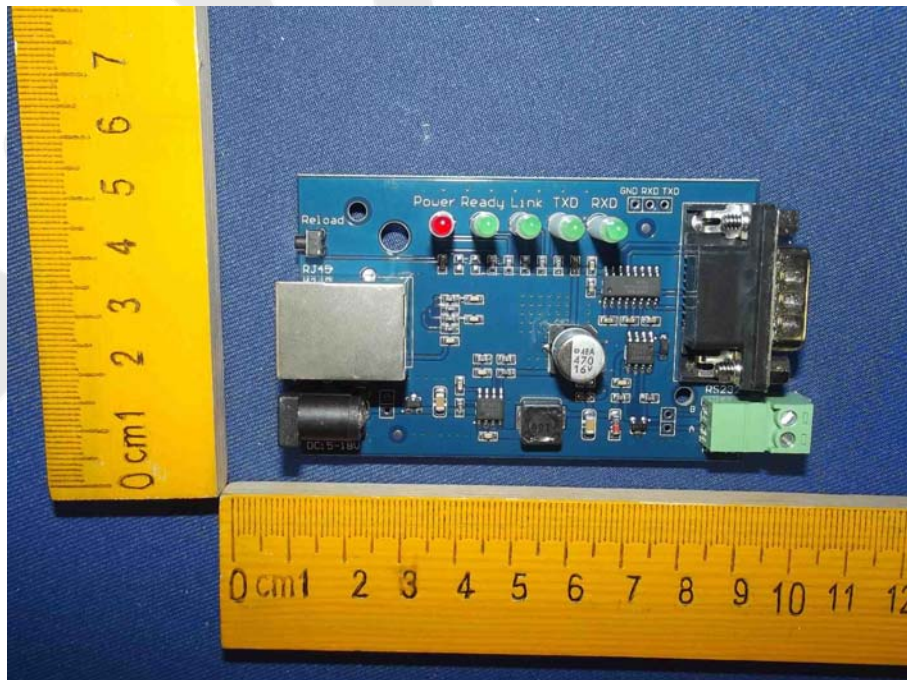

Figure 10
PCB of The EUT-Back View

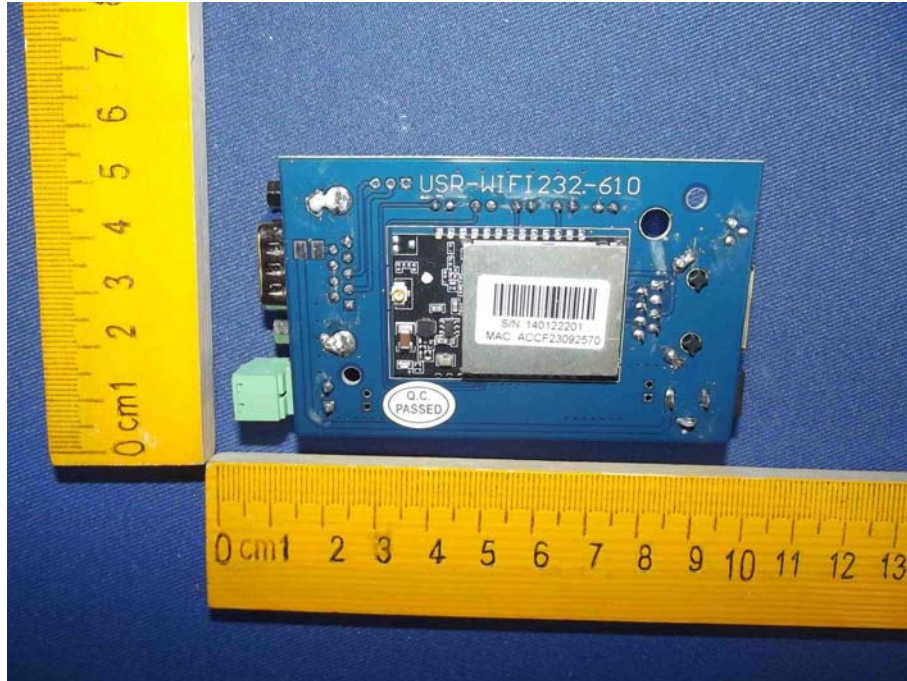

Figure 11
PCB of The EUT-Back View

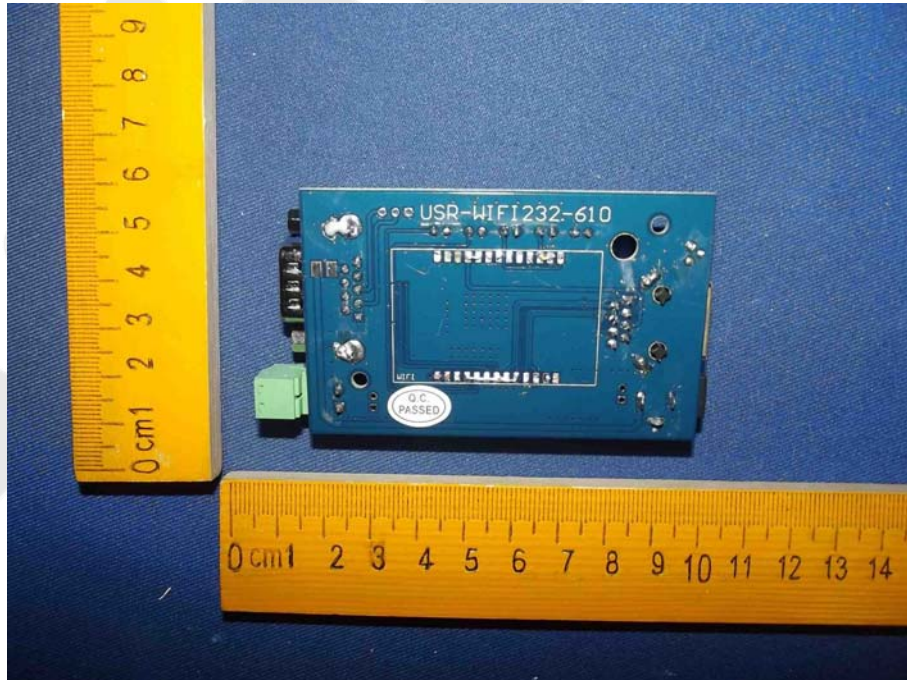

Figure 12
PCB of The EUT-Front View (WiFi Module With Shielding)



Figure 13
PCB of The EUT-Front View (WiFi Module Without Shielding)



Figure 14
PCB of The EUT-Back View (WiFi Module)

