

FCC TEST REPORT
for
Jinan USR IOT Technology Limited

WIFI Remote control device
Model No.: USR-WP1, USR-WM1s, USR-WM1h,
USR-WL1, USR-WP3, USR-HTW, USR-WIFIIO-83,
USR-WSA, USR-WSC, USR-R16

Prepared for : Jinan USR IOT Technology Limited
Address : #1-724~729, Huizhan Guoji Cheng, Gaoxin District, Jinan City,
Shandong Province, 250101, China

Prepared By : Shenzhen Anbotek Compliance Laboratory Limited
Address : 1/F., Building 1, SEC Industrial Park, No.0409 Qianhai Road,
Nanshan District, Shenzhen, Guangdong, China
Tel: (86) 755-26066544
Fax: (86) 755-26014772

Report Number : R011408277E
Date of Test : Aug. 21~ Sept. 26, 2014
Date of Report : Sept. 28, 2014

TABLE OF CONTENT

Description	Page
Test Report	
1. GENERAL INFORMATION.....	4
1.1. Description of Device (EUT).....	4
1.2. Auxiliary Equipment Used during Test.....	5
1.3. Description of Test Facility.....	5
1.4. Measurement Uncertainty.....	5
2. TEST METHODOLOGY.....	6
2.1. Summary of Test Results.....	6
2.2. Description of Test Modes.....	6
2.3. List of channels:.....	7
3. CONDUCTED EMISSION TEST.....	8
3.1. Block Diagram of Test Setup.....	8
3.2. Power Line Conducted Emission Measurement Limits (15.207).....	8
3.3. Configuration of EUT on Measurement.....	8
3.4. Operating Condition of EUT.....	8
3.5. Test Procedure.....	9
3.6. Test equipment.....	9
3.7. Power Line Conducted Emission Measurement Results.....	9
4. FCC PART 15.247 REQUIREMENTS FOR DSSS & OFDM MODULATION.....	12
4.1 Test Setup.....	12
4.2 6dB Bandwidth.....	12
4.3. Maximum Peak output power test.....	20
4.4. Band Edges Measurement.....	28
4.5. Peak Power Spectral Density.....	65
4.6. Radiated Emissions.....	73
5. PHOTOGRAPH.....	84
5.1. Photo of Conducted Emission Measurement.....	84
5.2. Photo of Radiation Emission Test.....	84
APPENDIX I (EXTERNAL PHOTOS).....	86
APPENDIX II (INTERNAL PHOTOS).....	89

Appendix I (3 Pages)

Appendix II (4 Pages)

TEST REPORT

Applicant : Jinan USR IOT Technology Limited
Manufacturer : Jinan USR IOT Technology Limited
EUT : WIFI Remote control device
Model No. : USR-WP1, USR-WM1s, USR-WM1h, USR-WL1, USR-WP3,
USR-HTW, USR-WIFIIO-83, USR-WSA, USR-WSC, USR-R16
Serial No. : N.A.
Trade Mark : USR IOT
Rating : AC 100-240V, 50/60Hz, 10A

Measurement Procedure Used:
FCC Part15 Subpart C, Paragraph 15.247

The device described above is tested by Shenzhen Anbotek Compliance Laboratory Limited to determine the maximum emission levels emanating from the device and the severe levels of the device can endure and its performance criterion. The measurement results are contained in this test report and Shenzhen Anbotek Compliance Laboratory Limited is assumed full of responsibility for the accuracy and completeness of these measurements. Also, this report shows that the EUT (Equipment Under Test) is technically compliant with the FCC Part 15 Subpart C requirements.

This report applies to above tested sample only and shall not be reproduced in part without written approval of Shenzhen Anbotek Compliance Laboratory Limited.

Date of Test : Aug. 21~ Sept. 26, 2014

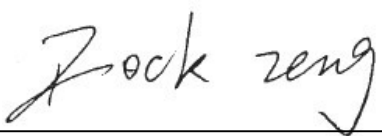
Prepared by : 
(Tested Engineer / Rock Zeng)

Reviewer : 
(Project Manager / Amy Ding)

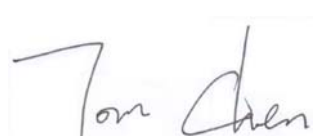
Approved & Authorized Signer : 
(Manager / Tom Chen)

1. GENERAL INFORMATION

1.1. Description of Device (EUT)

EUT	: WIFI Remote control device
Model Number	: USR-WP1, USR-WM1s, USR-WM1h, USR-WL1, USR-WP3, USR-HTW, USR-WIFIIO-83, USR-WSA, USR-WSC, USR-R16 (Note: All samples are the same except the model number and appearance, so we prepare "USR-WP1" for EMC test only.)
Test Power Supply	: AC 120V, 60Hz
RF Transmission Frequency	: 2412MHz~2462MHz (802.11b/802.11g/802.11n(HT20)) 2422MHz~2452MHz (802.11n(HT40))
Channels	: 11 For (802.11b/802.11g/802.11n(HT20)) 7 For (802.11n(HT40))
Modulation	: 802.11b CCK 802.11g OFDM 802.11n MCS
Antenna Gain:	: 1.5dBi
Applicant Address	: Jinan USR IOT Technology Limited #1-724~729, Huizhan Guoji Cheng, Gaoxin District, Jinan City, Shandong Province, 250101, China
Manufacturer Address	: Jinan USR IOT Technology Limited #1-724~729, Huizhan Guoji Cheng, Gaoxin District, Jinan City, Shandong Province, 250101, China
Factory Address	: Jinan USR IOT Technology Limited #1-724~729, Huizhan Guoji Cheng, Gaoxin District, Jinan City, Shandong Province, 250101, China
Date of receipt	: Aug. 21, 2014
Date of Test	: Aug. 21~ Sept. 26, 2014

1.2. Auxiliary Equipment Used during Test

N/A

1.3. Description of Test Facility

The test facility is recognized, certified, or accredited by the following organizations:

CNAS - LAB Code: L3503

Shenzhen Anbotek Compliance Laboratory Limited., Laboratory has been assessed and in compliance with CNAS/CL01: 2006 accreditation criteria for testing laboratories (identical to ISO/IEC 17025:2005 General Requirements) for the Competence of Testing Laboratories.

FCC-Registration No.: 752021

Shenzhen Anbotek Compliance Laboratory Limited, EMC Laboratory has been registered and fully described in a report filed with the (FCC) Federal Communications Commission. The acceptance letter from the FCC is maintained in our files. Registration 752021, July 10, 2013.

IC-Registration No.: 8058A-1

Shenzhen Anbotek Compliance Laboratory Limited., EMC Laboratory has been registered and fully described in a report filed with the (IC) Industry Canada. The acceptance letter from the IC is maintained in our files. Registration 8058A, February 22, 2013.

Test Location

All Emissions tests were performed at
Shenzhen Anbotek Compliance Laboratory Limited. at 1/F., Building 1, SEC Industrial Park, No.0409 Qianhai Road, Nanshan District, Shenzhen, Guangdong, China

1.4. Measurement Uncertainty

Radiation Uncertainty : Ur = 4.3dB

Conduction Uncertainty : Uc = 3.4dB

2. TEST METHODOLOGY

The tests documented in this report were performed in accordance with ANSI C63.4: 2009 and FCC Part 15, Paragraph 15.247.

2.1. Summary of Test Results

The EUT has been tested according to the following specifications:

Standard	Test Type	Result	Notes
FCC Part 15, Paragraph 15.107, 15.207	Conducted Emission Test	PASS	Complies
FCC Part 15, Paragraph 15.247(b)(1)	Peak Output Power	PASS	Complies
FCC Part 15, Paragraph 15.247(a)(2)	6dB Bandwidth	PASS	Complies
FCC Part 15, Paragraph 15.247(c)	100kHz Bandwidth of Frequency Band Edges	PASS	Complies
FCC Part 15, Paragraph 15.209(a)(f)	Spurious Emission	PASS	Complies
FCC Part 15, Paragraph 15.247(a)(1)	Frequency Separation	-	N/A
FCC Part 15, Paragraph 15.247(a)(1)(iii)	Number of Hopping Frequency	-	N/A
FCC Part 15, Paragraph 15.247(a)(1)(iii)	Time of Occupancy	-	N/A
FCC Part 15, Paragraph 15.247(c)	Peak Power Density	PASS	Complies

2.2. Description of Test Modes

The EUT has been tested under operating condition.

Software used to control the EUT for staying in continuous transmitting and receiving mode is programmed.

IEEE802.11b: Channel 1(2412MHz), Channel 6(2437MHz) and Channel 11(2462MHz) with 1 Mbps lowest data rate (worst case) are chosen for the final testing.

IEEE802.11g: Channel 1(2412MHz), Channel 6(2437MHz) and Channel 11(2462MHz) with 6 Mbps lowest data rate (the worst case) are chosen for the final testing.

IEEE802.11n (HT20): Channel 1(2412MHz), Channel 6(2437MHz) and Channel 11(2462MHz) with MCS 0 Mbps lowest data rate (the worst case) are chosen for the final testing.

IEEE802.11n (HT40): Channel 3(2422MHz), Channel 6(2437MHz) and Channel 9(2452MHz) with MCS 0 Mbps lowest data rate (the worst case) are chosen for the final testing.

2.3. List of channels:

√ - available

X - tested

Number	Frequency(MHz)		802.11 b/g/n (HT20)	802.11 b/g/n (HT40)
1	2412	√	X	
2	2417	√		
3	2422	√		X
4	2427	√		
5	2432	√		
6	2437	√	X	X
7	2442	√		
8	2447	√		
9	2452	√		X
10	2457	√		
11	2462	√	X	

3. Conducted Emission Test

3.1. Block Diagram of Test Setup

3.1.1. Block diagram of connection between the EUT and simulators

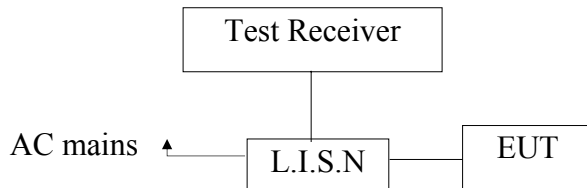

3.2. Power Line Conducted Emission Measurement Limits (15.207)

Frequency MHz	Limits dB(μV)	
	Quasi-peak Level	Average Level
0.15 ~ 0.50	66 ~ 56*	56 ~ 46*
0.50 ~ 5.00	56	46
5.00 ~ 30.00	60	50

- Notes: 1. *Decreasing linearly with logarithm of frequency.
2. The lower limit shall apply at the transition frequencies.

3.3. Configuration of EUT on Measurement

The following equipments are installed on Power Line Conducted Emission Measurement to meet the commission requirement and operating regulations in a manner which tends to maximize its emission characteristics in a normal application.

3.4. Operating Condition of EUT

- 3.4.1. Setup the EUT and simulator as shown as Section 3.1.
- 3.4.2. Turn on the power of all equipment.
- 3.4.3. Let the EUT work in test mode (On) and measure it.

3.5. Test Procedure

The EUT system is connected to the power mains through a line impedance stabilization network (L.I.S.N.). This provides a 50ohm coupling impedance for the EUT system. Please refer the block diagram of the test setup and photographs. Both sides of AC line are checked to find out the maximum conducted emission. In order to find the maximum emission levels, the relative positions of equipment and all of the interface cables shall be changed according to FCC ANSI C63.4-2003 on Conducted Emission Measurement.

The bandwidth of test receiver (ESCI) set at 9KHz.

The frequency range from 150KHz to 30MHz is checked.

The test results are reported on Section 3.6.

3.6. Test equipment

Item	Equipment	Manufacturer	Model No.	Serial No.	Last Cal.	Cal. Interval
1.	Two-Line V-network	Rohde & Schwarz	ENV216	100055	Apr. 23, 2014	1 Year
2.	EMI Test Receiver	Rohde & Schwarz	ESCI	100627	Apr. 23, 2014	1 Year
3.	RF Switching Unit	Compliance Direction	RSU-M2	38303	Apr. 23, 2014	1 Year

3.7. Power Line Conducted Emission Measurement Results

PASS.

The frequency range from 150KHz to 30 MHz is investigated.

Please refer the following pages.

CONDUCTED EMISSION TEST DATA

Test Site: 1# Shielded Room
 Operating Condition: On
 Test Specification: AC 120V, 60Hz
 Comment: Live Line
 Tem:25°C Hum:50%

SCAN TABLE: "Voltage (150K~30M) FIN"

Short Description: 150K-30M Disturbance Voltages

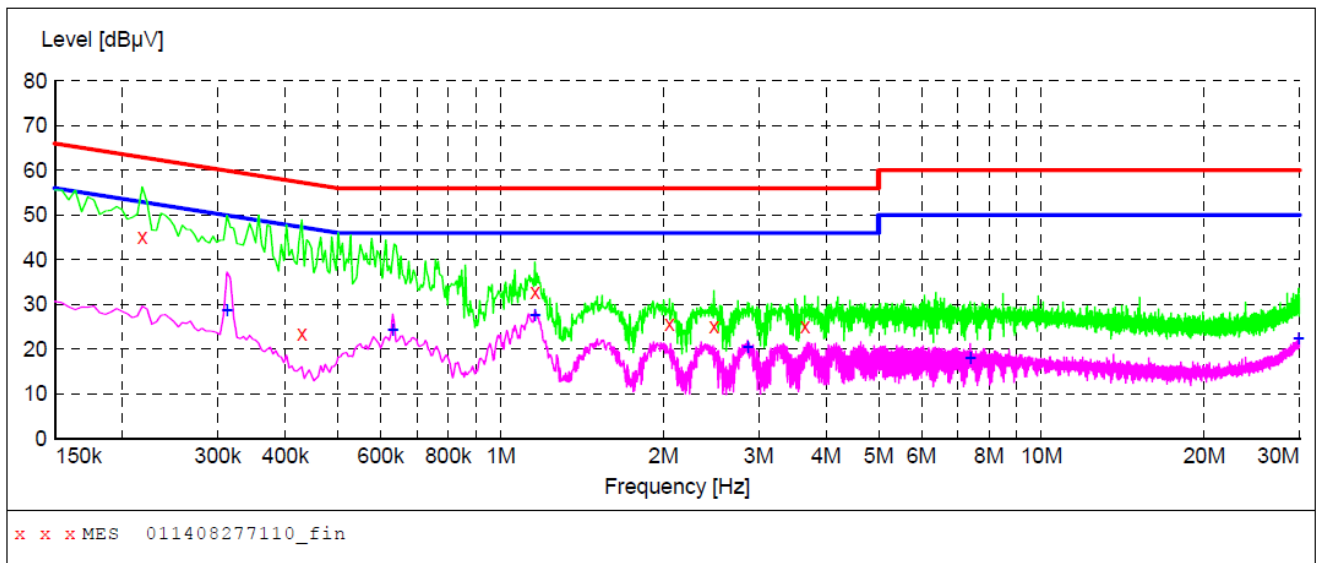

MEASUREMENT RESULT: "011408277110_fin"

8/22/2014 8:55AM

Frequency MHz	Level dBµV	Transd dB	Limit dBµV	Margin dB	Detector	Line	PE
0.217500	45.20	20.1	63	17.7	QP	L1	GND
0.429000	23.50	20.1	57	33.8	QP	L1	GND
1.157500	32.90	20.2	56	23.1	QP	L1	GND
2.053000	25.80	20.3	56	30.2	QP	L1	GND
2.480500	25.20	20.3	56	30.8	QP	L1	GND
3.655000	25.10	20.4	56	30.9	QP	L1	GND

MEASUREMENT RESULT: "011408277110_fin2"

8/22/2014 8:55AM

Frequency MHz	Level dBµV	Transd dB	Limit dBµV	Margin dB	Detector	Line	PE
0.312000	28.80	20.1	50	21.1	AV	L1	GND
0.631500	24.40	20.1	46	21.6	AV	L1	GND
1.157500	27.50	20.2	46	18.5	AV	L1	GND
2.863000	20.60	20.4	46	25.4	AV	L1	GND
7.390000	18.10	20.5	50	31.9	AV	L1	GND
29.899000	22.50	20.9	50	27.5	AV	L1	GND

CONDUCTED EMISSION TEST DATA

Test Site: 1# Shielded Room
 Operating Condition: On
 Test Specification: AC 120V, 60Hz
 Comment: Neutral Line
 Tem:25°C Hum:50%

SCAN TABLE: "Voltage (150K~30M) FIN"

Short Description: 150K-30M Disturbance Voltages

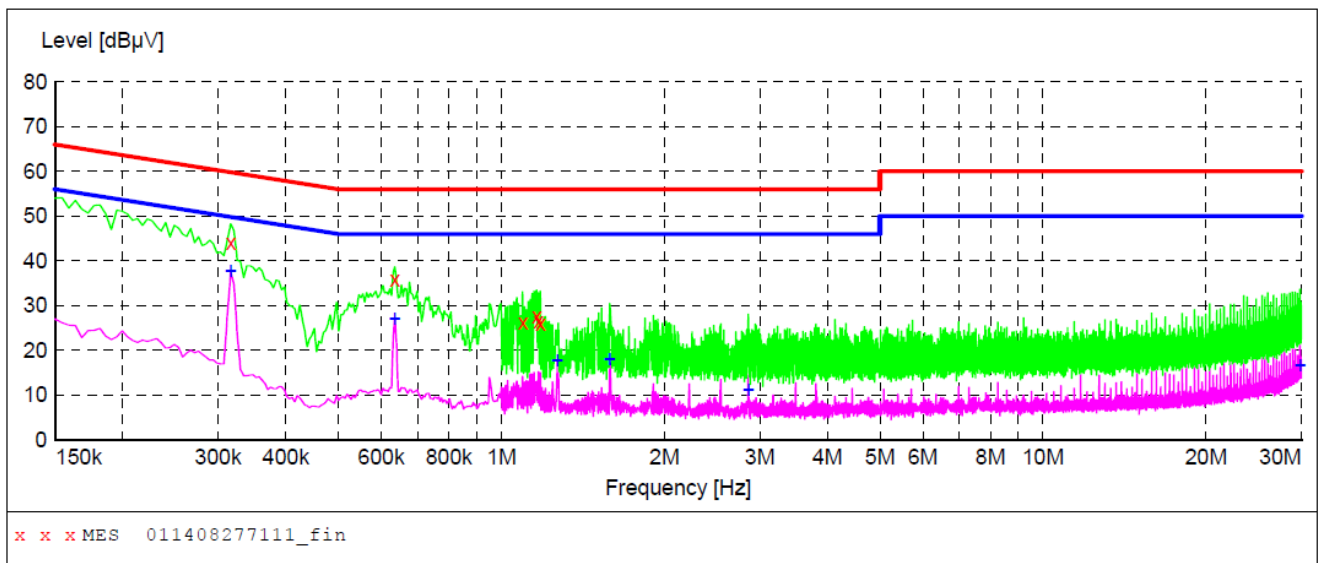

MEASUREMENT RESULT: "011408277111_fin"

8/22/2014 8:58AM

Frequency MHz	Level dBµV	Transd dB	Limit dBµV	Margin dB	Detector	Line	PE
0.316500	44.00	20.1	60	15.8	QP	N	GND
0.636000	35.70	20.1	56	20.3	QP	N	GND
1.094500	26.20	20.2	56	29.8	QP	N	GND
1.162000	27.70	20.2	56	28.3	QP	N	GND
1.171000	26.40	20.2	56	29.6	QP	N	GND
1.180000	25.90	20.2	56	30.1	QP	N	GND

MEASUREMENT RESULT: "011408277111_fin2"

8/22/2014 8:58AM

Frequency MHz	Level dBµV	Transd dB	Limit dBµV	Margin dB	Detector	Line	PE
0.316500	37.80	20.1	50	12.0	AV	N	GND
0.636000	27.00	20.1	46	19.0	AV	N	GND
1.270000	17.70	20.2	46	28.3	AV	N	GND
1.585000	17.90	20.3	46	28.1	AV	N	GND
2.858500	11.20	20.4	46	34.8	AV	N	GND
29.831500	16.70	20.9	50	33.3	AV	N	GND

4. FCC Part 15.247 Requirements for DSSS & OFDM Modulation

4.1 Test Setup

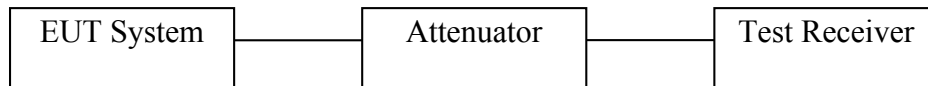

4.2 6dB Bandwidth

a. Limit

For the direct sequence systems, the minimum 6dB bandwidth shall be at least 500kHz.

b. Test Procedure

1. Place the EUT on the table and set it in the transmitting mode.
2. Remove the antenna from the EUT and then connect a low loss RF cable from the antenna port to the spectrum analyzer.
3. Set the spectrum analyzer as:
 RBW = 100kHz, VBW \geq 3*RBW = 300kHz,
 Detector= Peak
 Trace mode= Max hold.
 Sweep- auto couple.
4. Mark the peak frequency and -6dB (upper and lower) frequency.
5. Repeat until all the rest channels are investigated.

c. Test Setup See 4.1

d. Test Equipment

Item	Equipment	Manufacturer	Model No.	Serial No.	Last Cal.	Cal. Interval
1.	Spectrum Analysis	Agilent	E4407B	US39390582	Aug. 09, 2014	1 Year
2.	Preamplifier	Instruments corporation	EMC011830	980100	Aug. 09, 2014	1 Year
3.	EMI Test Receiver	Rohde & Schwarz	ESPI	101604	Apr. 23, 2014	1 Year
4.	Double Ridged Horn Antenna	Instruments corporation	GTH-0118	351600	Aug. 09, 2013	3 Year
5.	EMI Test Software EZ-EMC	SHURPLE	N/A	N/A	N/A	N/A

e. Test Results

Pass.

f. Test Data

Test mode: IEEE 802.11b

Channel	Frequency (MHz)	Bandwidth (MHz)	Limit (kHz)	Results
Low	2412	12.20		Pass
Mid	2437	12.20	>500	Pass
High	2462	12.20		Pass

Test mode: IEEE 802.11g

Channel	Frequency (MHz)	Bandwidth (MHz)	Limit (kHz)	Results
Low	2412	16.60		Pass
Mid	2437	16.60	>500	Pass
High	2462	16.60		Pass

Test mode: IEEE 802.11n (HT20)

Channel	Frequency (MHz)	Bandwidth (MHz)	Limit (kHz)	Results
Low	2412	17.60		Pass
Mid	2437	17.60	>500	Pass
High	2462	17.60		Pass

Test mode: IEEE 802.11n (HT40)

Channel	Frequency (MHz)	Bandwidth (MHz)	Limit (kHz)	Results
Low	2422	36.32		Pass
Mid	2437	36.16	>500	Pass
High	2452	36.36		Pass

Test Plots See the following page.

Test Mode: 802.11b---Low



*RBW 100 kHz Delta 1 [T1]
*VBW 300 kHz 0.16 dB
SWT 5 ms 12.20000000 MHz

Ref 20 dBm *Att 35 dB

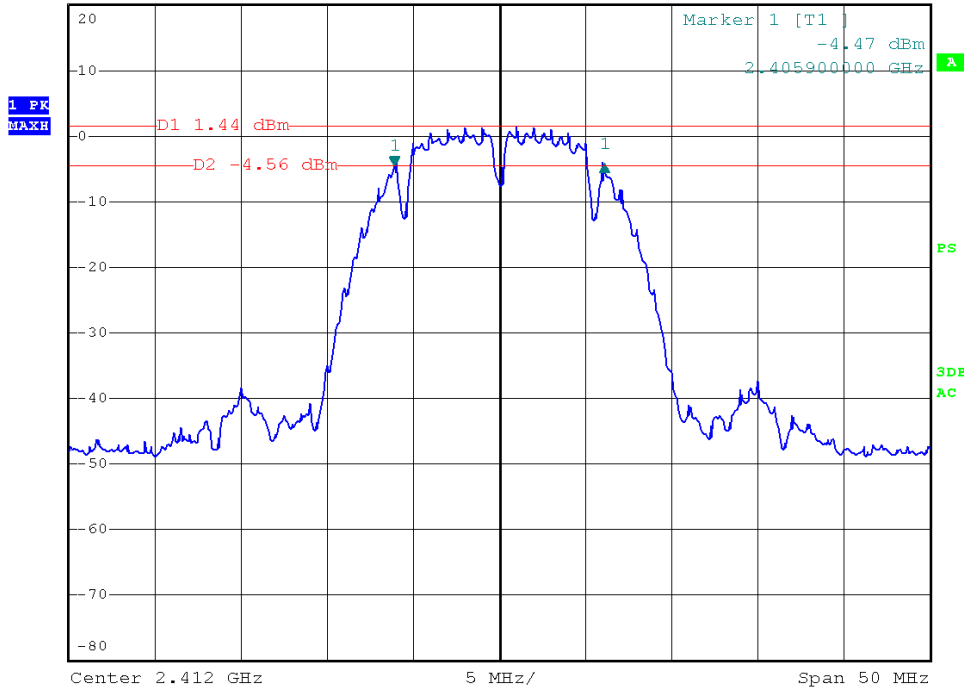

Test Mode: 802.11b---Mid



*RBW 100 kHz Delta 1 [T1]
*VBW 300 kHz -0.76 dB
SWT 5 ms 12.20000000 MHz

Ref 20 dBm *Att 35 dB

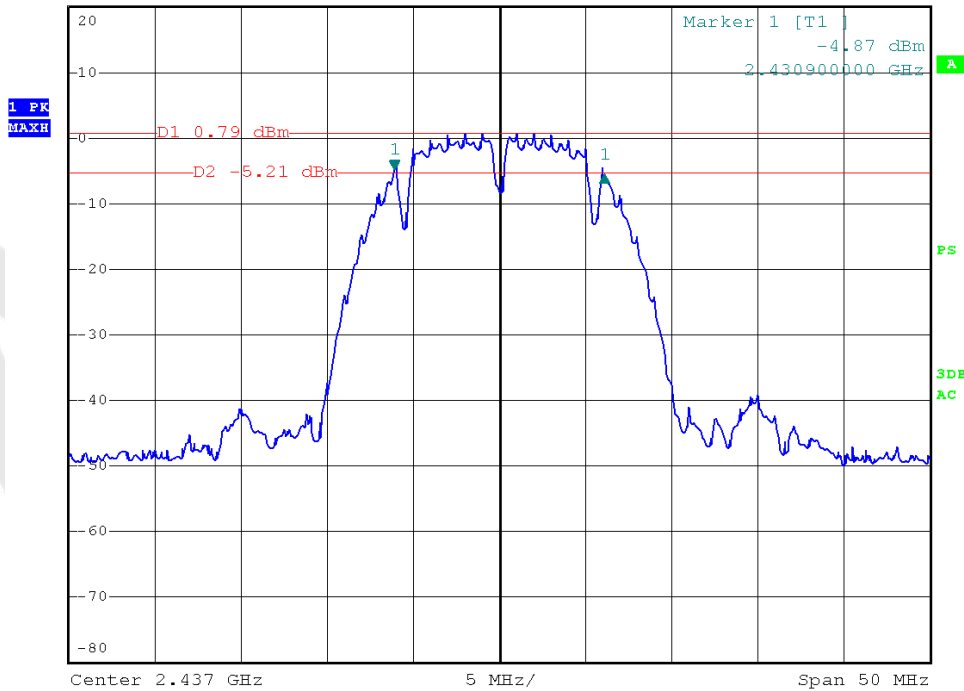

Test Mode: 802.11b---High



*RBW 100 kHz Delta 1 [T1]
*VBW 300 kHz -0.58 dB
SWT 5 ms 12.20000000 MHz

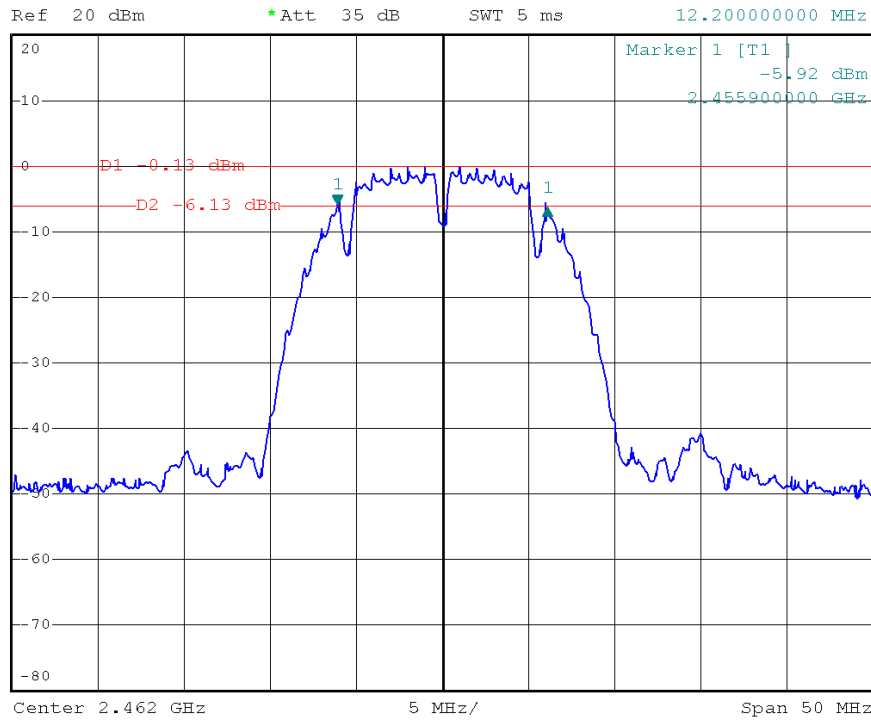

Test Mode: 802.11g---Low



*RBW 100 kHz Delta 1 [T1]
*VBW 300 kHz 0.26 dB
SWT 5 ms 16.60000000 MHz

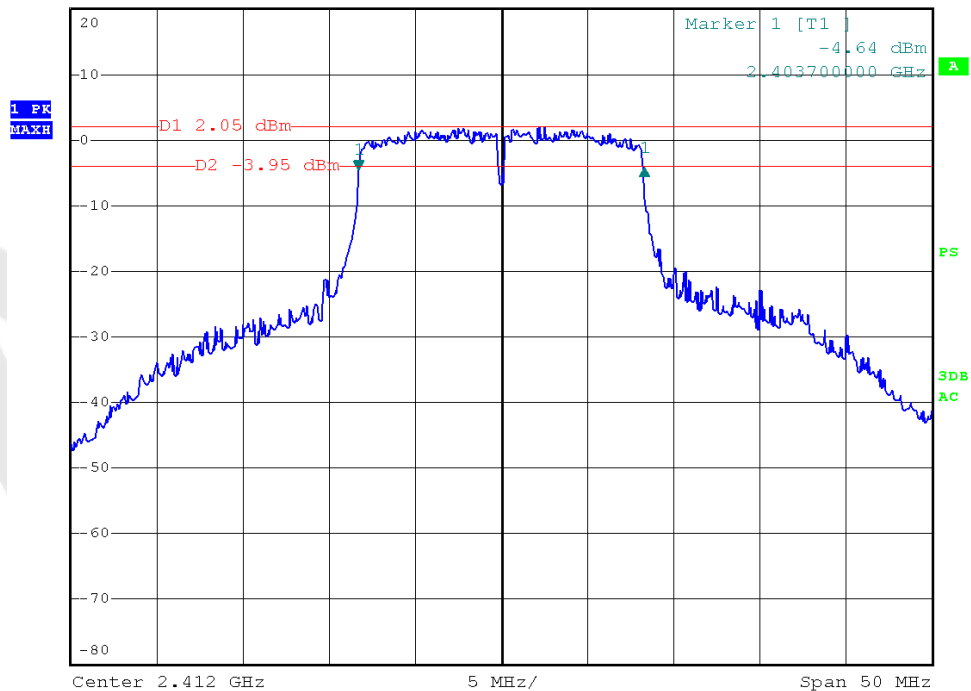

Test Mode: 802.11g---Mid



*RBW 100 kHz Delta 1 [T1]
*VBW 300 kHz 0.19 dB
SWT 5 ms 16.600000000 MHz

Ref 20 dBm *Att 35 dB

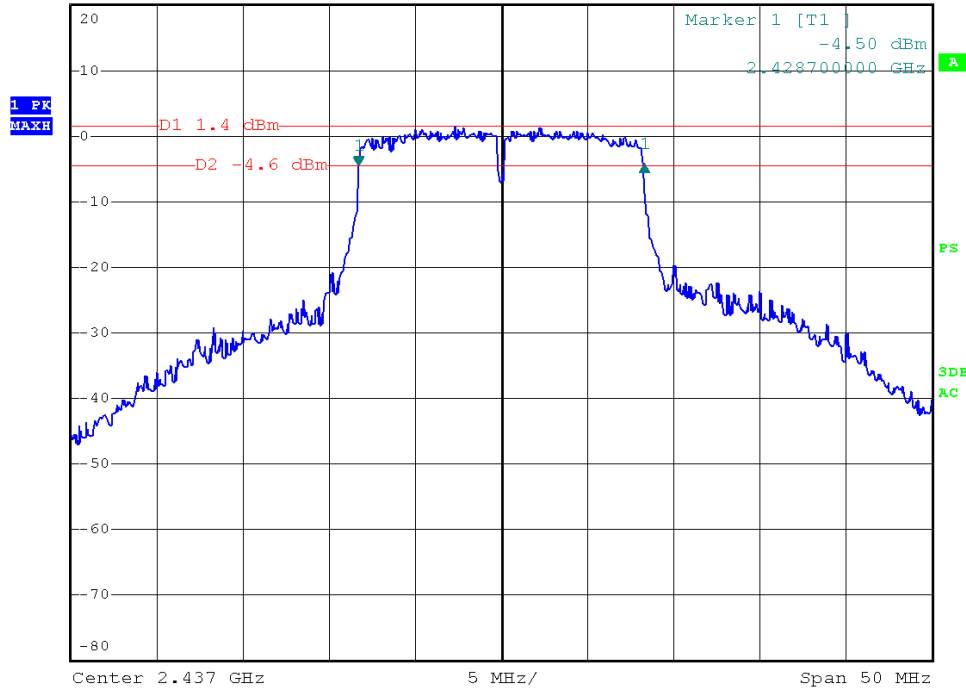

Test Mode: 802.11g---High



*RBW 100 kHz Delta 1 [T1]
*VBW 300 kHz -0.25 dB
SWT 5 ms 16.600000000 MHz

Ref 20 dBm *Att 35 dB

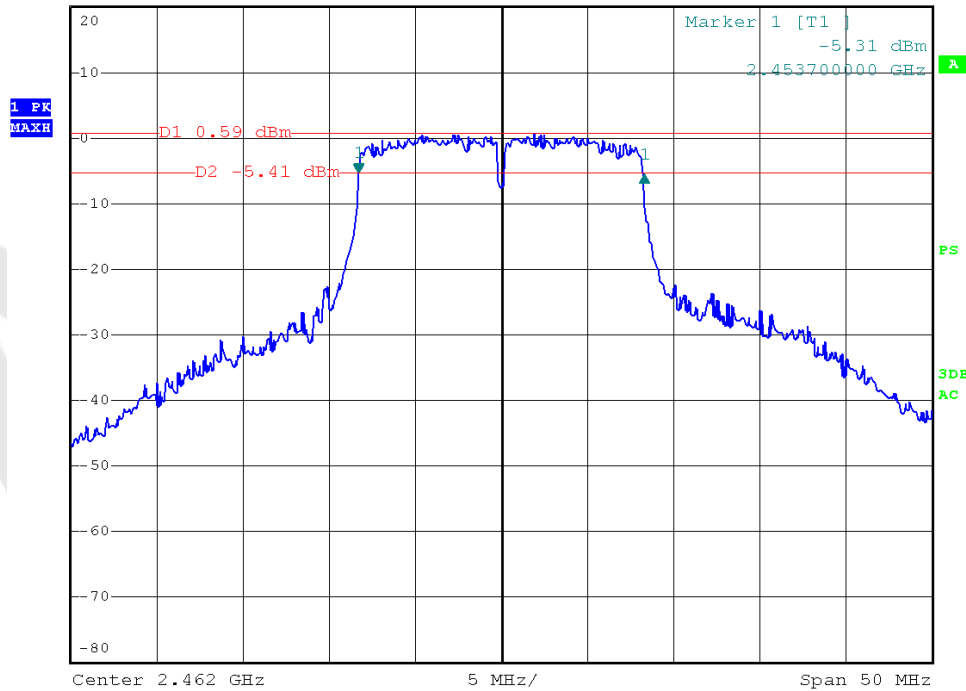

Test Mode: 802.11n (HT20)---Low

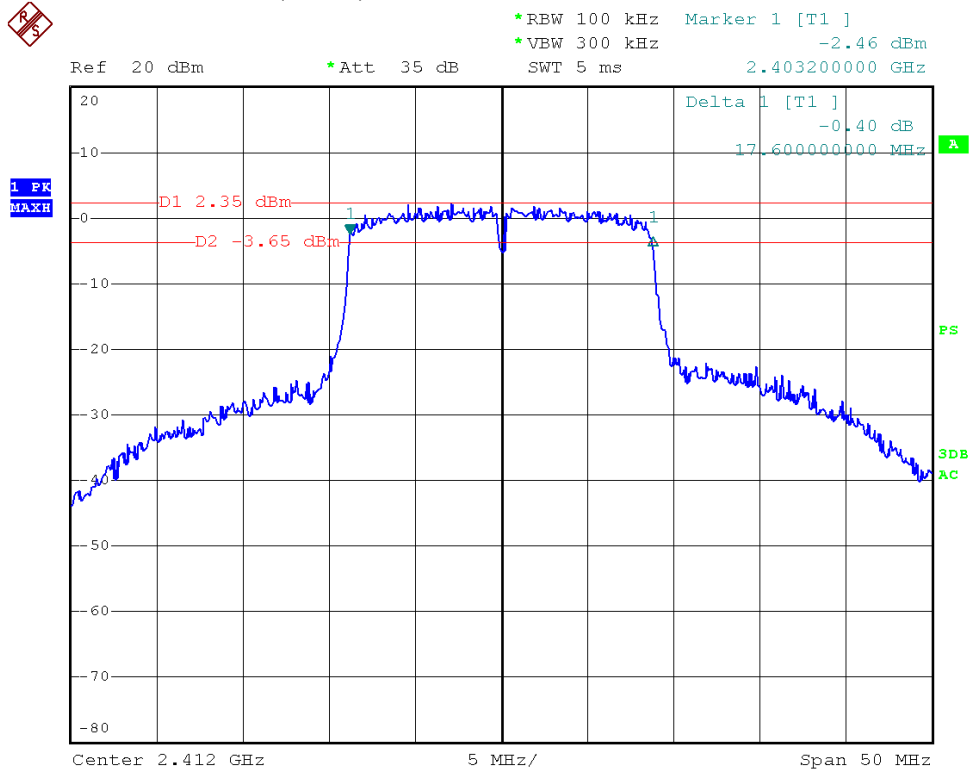

Test Mode: 802.11n (HT20)---Mid

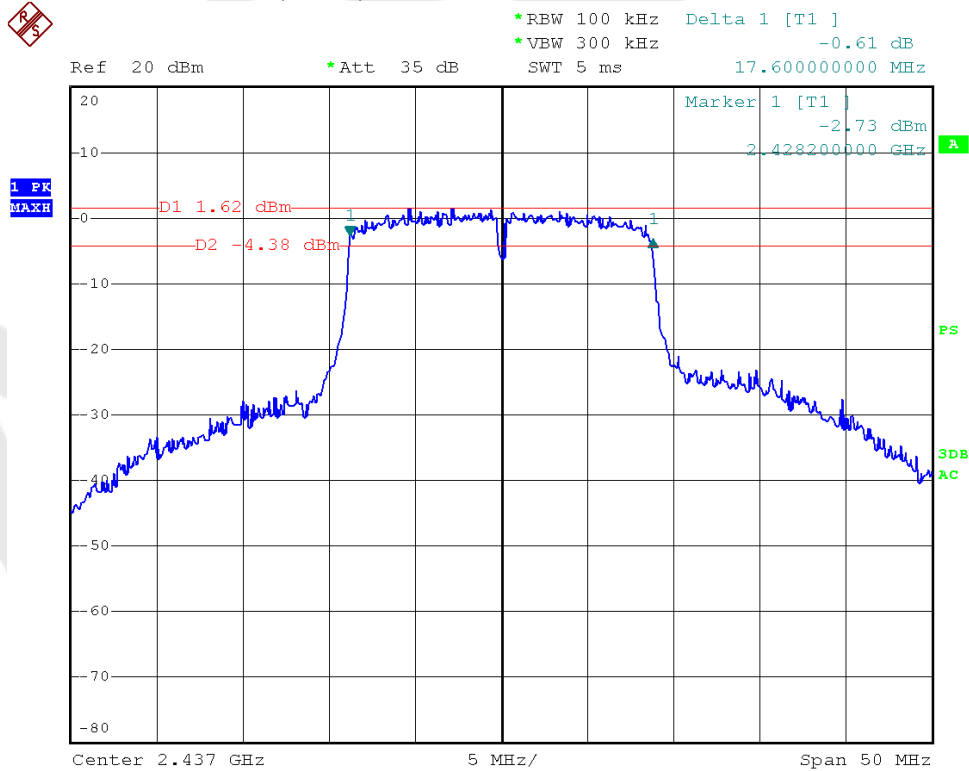

Test Mode: 802.11n (HT20)---High

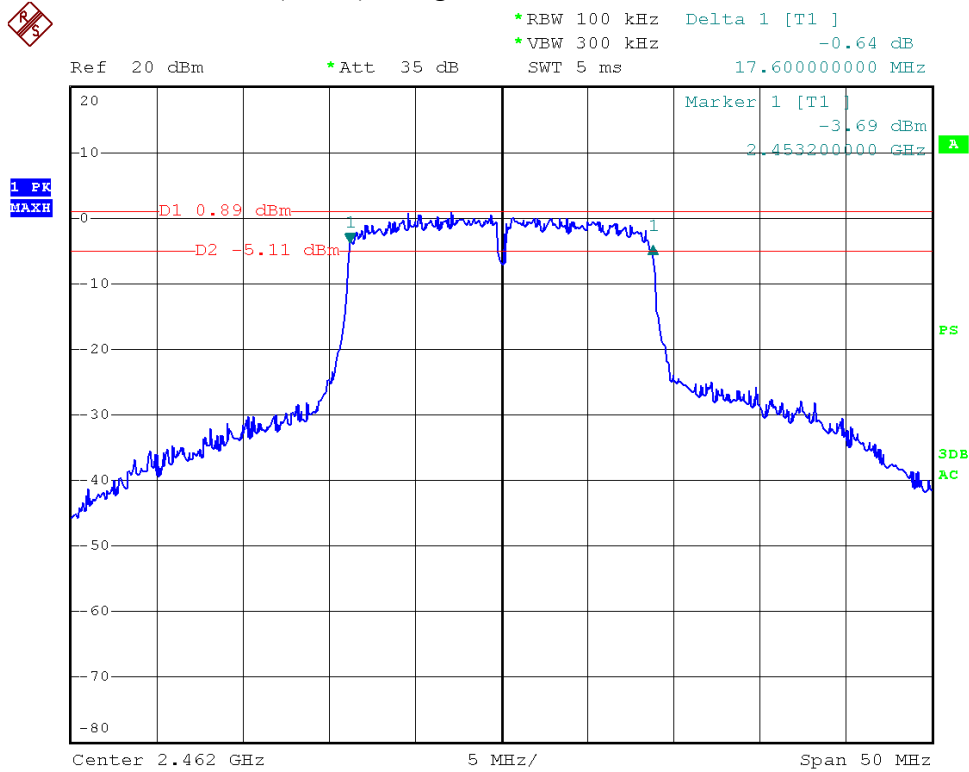

Test Mode: 802.11n (HT40)---Low

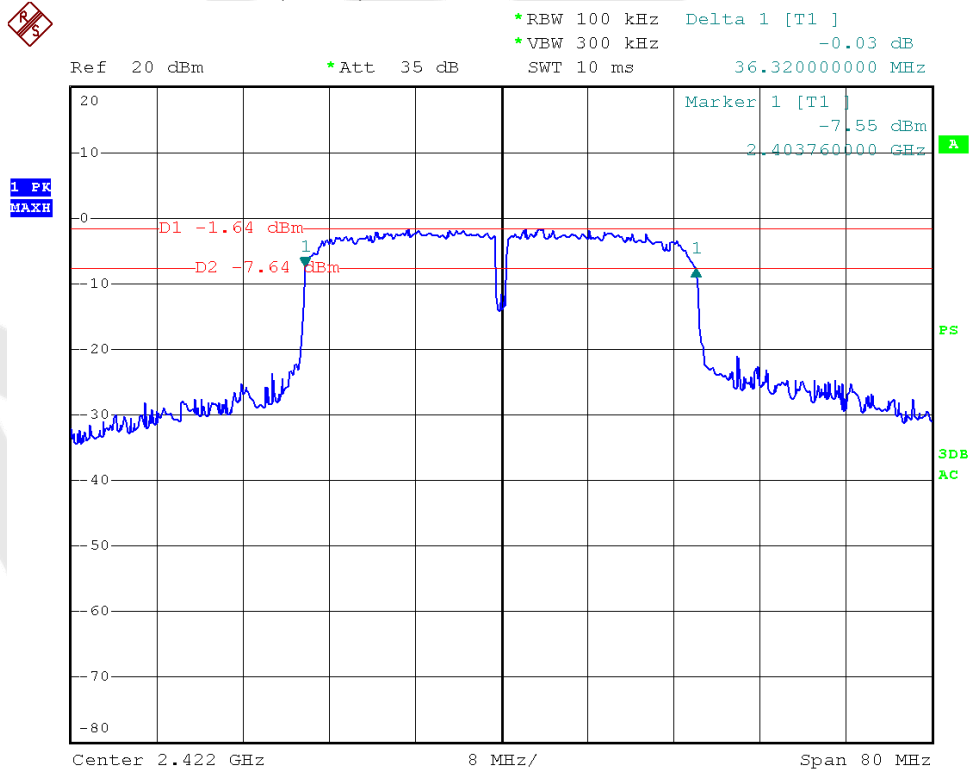

Test Mode: 802.11n (HT40)---Mid

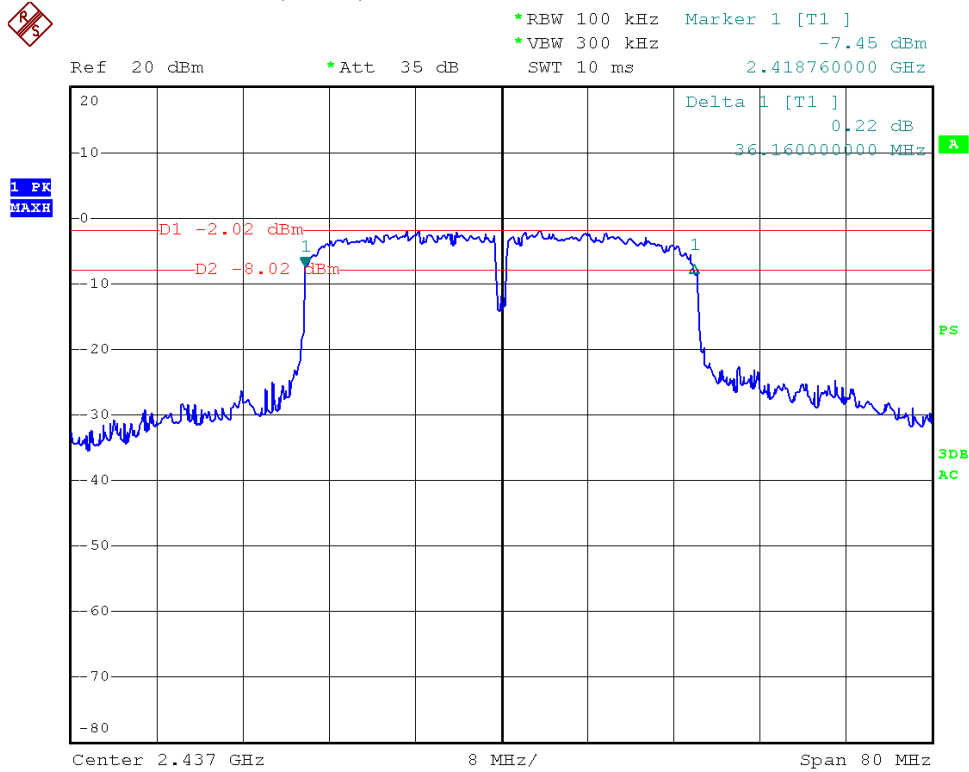

Test Mode: 802.11n (HT40)---High

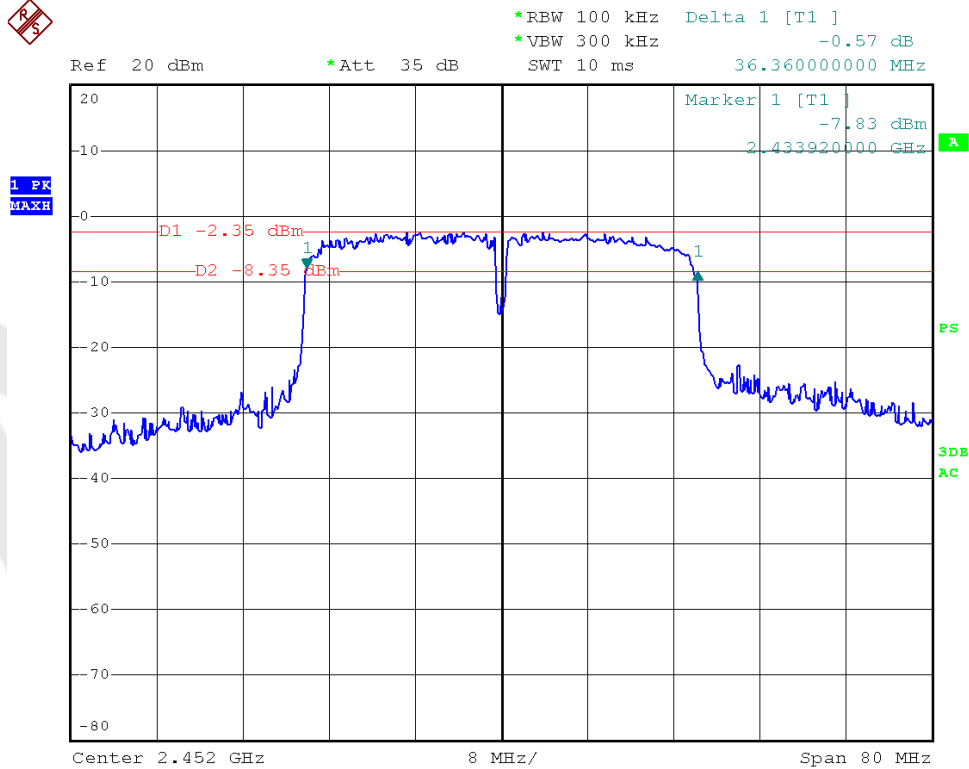

4.3. Maximum Peak output power test

a. Limit

The maximum peak output power of the intentional radiator shall not exceed the following:

1. For systems using digital modulation in the bands of 902-928 MHz, 2400-2483.5 MHz, and 5725-5850 MHz: 1 watt (30dBm).
2. Except as shown in paragraphs (b)(3) (i), (ii) and (iii) of this section, if transmitting antenna of directional gain greater than 6 dBi are used the peak output power from the intentional radiator shall be reduced below the stated values in paragraphs (b)(1) or (b)(2) of this section, as appropriate, by the amount in dB that the directional gain of the antenna exceeds 6 dBi.

b. Configuration of Measurement

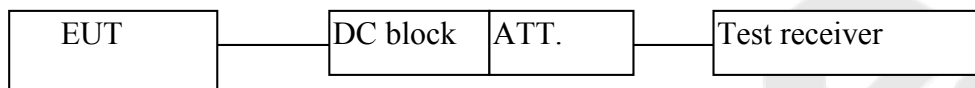

c. Data Rates

IEEE802.11b: Channel 1(2412MHz), Channel 6(2437MHz) and Channel 11(2462MHz) with 1 Mbps data rate (worst case) are chosen for the final testing.

IEEE802.11g: Channel 1(2412MHz), Channel 6(2437MHz) and Channel 11(2462MHz) with 6 Mbps data rate (the worst case) are chosen for the final testing.

IEEE802.11n (HT20: Channel 1(2412MHz), Channel 6(2437MHz) and Channel 11(2462MHz) with 6.5Mbps data rate (the worst case) are chosen for the final testing.

IEEE802.11n (HT40: Channel 3(2422MHz), Channel 6(2437MHz) and Channel 9(2452MHz) with 13.5Mbps data rate (the worst case) are chosen for the final testing.

d. Test Procedure

This test was according the kDB 558074 9.1.2:

1. This procedure may be used when the maximum available RBW of the measurement instrument is less than the DTS bandwidth.
2. Set the RBW = 1 MHz.
3. Set the VBW $\geq 3 * RBW = 3$ MHz.
4. Set the span $\geq 1.5 * DTS$ bandwidth.
5. Detector = peak.
6. Sweep time = auto couple.
7. Trace mode = max hold.
8. Allow trace to fully stabilize.
9. Use the instrument's band/channel power measurement function with the band limits set equal to the DTS bandwidth edges (for some instruments, this may require a manual override to select peak detector). If the instrument does not have a band power function, sum the spectrum levels (in linear power units) at intervals equal to the RBW extending across the DTS bandwidth.

e. Test Equipment

Same as the equipment listed in 4.2.

f. Test Results

Pass.

g. Test Data

Test mode: IEEE 802.11b

Channel	Frequency (MHz)	Maximum transmit power (dBm)	Limit		Result
			(dBm)	(watts)	
Low	2412	17.11	30	1	Pass
Mid	2437	16.33			Pass
High	2462	15.54			Pass

Test mode: IEEE 802.11g

Channel	Frequency (MHz)	Maximum transmit power (dBm)	Limit		Result
			(dBm)	(watts)	
Low	2412	17.67	30	1	Pass
Mid	2437	17.13			Pass
High	2462	16.39			Pass

Test mode: IEEE 802.11n (HT20)

Channel	Frequency (MHz)	Maximum transmit power (dBm)	Limit		Result
			(dBm)	(watts)	
Low	2412	18.01	30	1	Pass
Mid	2437	17.42			Pass
High	2462	14.48			Pass

Test mode: IEEE 802.11n (HT40)

Channel	Frequency (MHz)	Maximum transmit power (dBm)	Limit		Result
			(dBm)	(watts)	
Low	2422	17.39	30	1	Pass
Mid	2437	17.15			Pass
High	2452	16.87			Pass

Test Mode: 802.11b---Low



Ref 20 dBm *Att 35 dB *RBW 1 MHz VBW 3 MHz SWT 2.5 ms Marker 1 [T1]
8.31 dBm
2.413400000 GHz

1 PK
MAXH

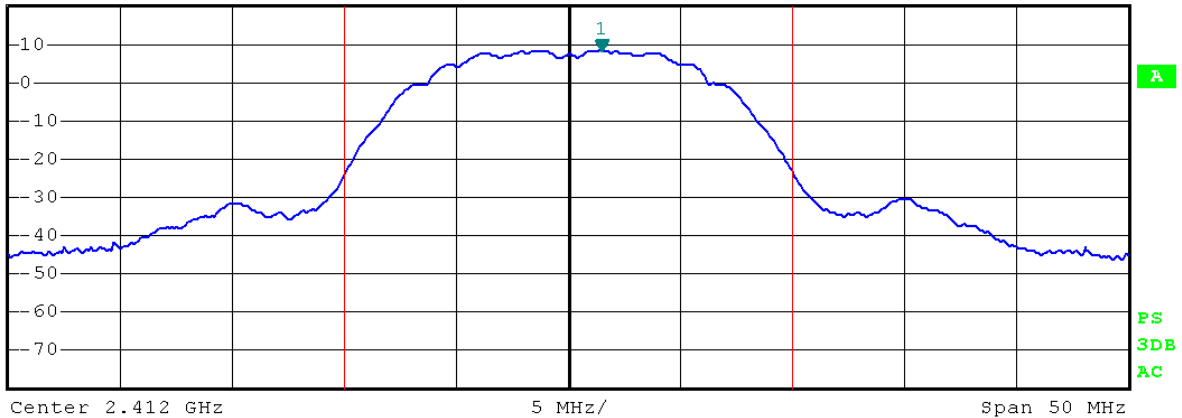

Tx Channel
Bandwidth 20 MHz Power 17.11 dBm

Test Mode: 802.11b---Mid



Ref 20 dBm *Att 35 dB *RBW 1 MHz VBW 3 MHz SWT 2.5 ms Marker 1 [T1]
7.50 dBm
2.438500000 GHz

1 PK
MAXH

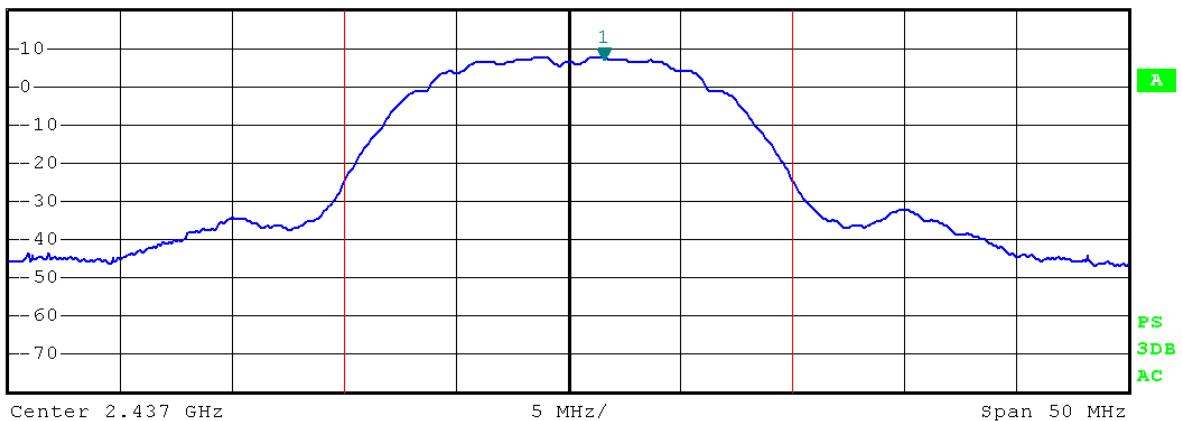

Tx Channel
Bandwidth 20 MHz Power 16.33 dBm

Test Mode: 802.11b---High



Ref 20 dBm *Att 35 dB *RBW 1 MHz VBW 3 MHz SWT 2.5 ms Marker 1 [T1] 6.68 dBm 2.463500000 GHz

1 PK
MAXH

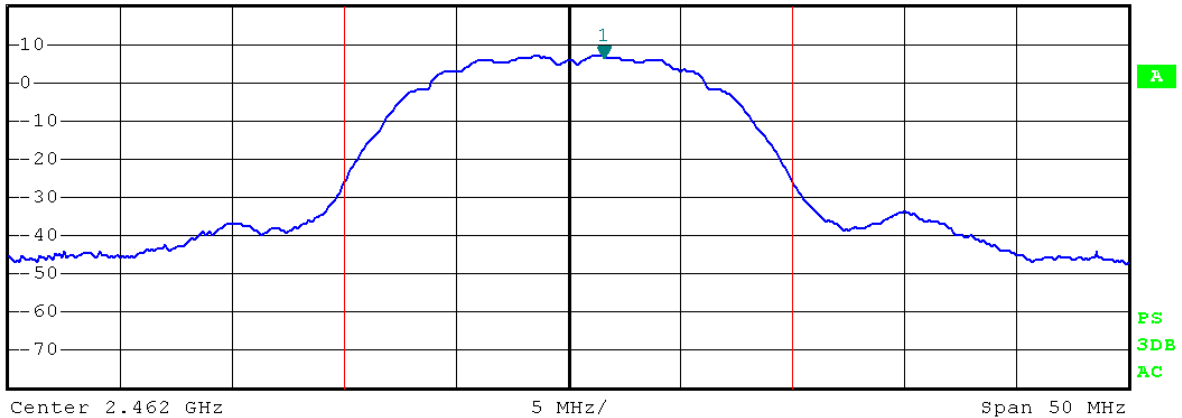

Tx Channel

Bandwidth

20 MHz

Power

15.54 dBm

Test Mode: 802.11g---Low



Ref 20 dBm *Att 35 dB *RBW 1 MHz VBW 3 MHz SWT 2.5 ms Marker 1 [T1] -43.39 dBm 2.437000000 GHz

1 PK
MAXH

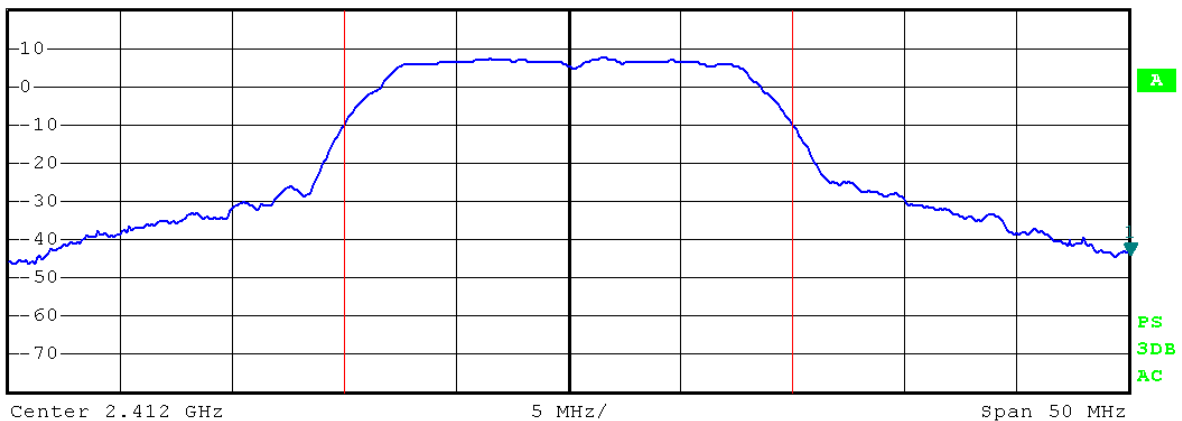

Tx Channel

Bandwidth

20 MHz

Power

17.67 dBm

Test Mode: 802.11g---Mid



*RBW 1 MHz
VBW 3 MHz
SWT 2.5 ms
Marker 1 [T1]
6.35 dBm
2.433100000 GHz

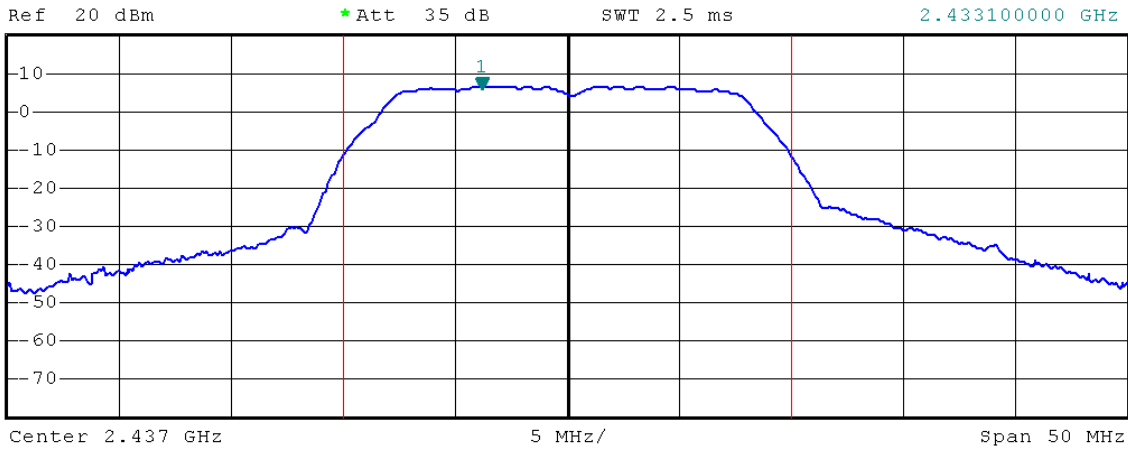

Tx Channel
Bandwidth 20 MHz Power 17.13 dBm

Test Mode: 802.11g---High



*RBW 1 MHz
VBW 3 MHz
SWT 2.5 ms
Marker 1 [T1]
5.75 dBm
2.458200000 GHz

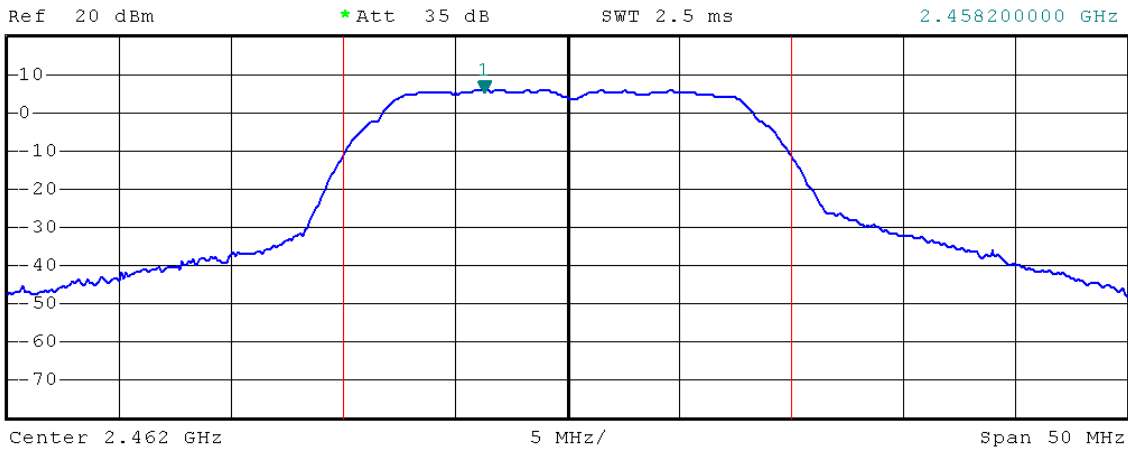

Tx Channel
Bandwidth 20 MHz Power 16.39 dBm

Test Mode: 802.11n(HT20)---Low



Ref 20 dBm *Att 35 dB *RBW 1 MHz VBW 3 MHz SWT 2.5 ms Marker 1 [T1] 7.13 dBm 2.415200000 GHz

1 PK
MAXH

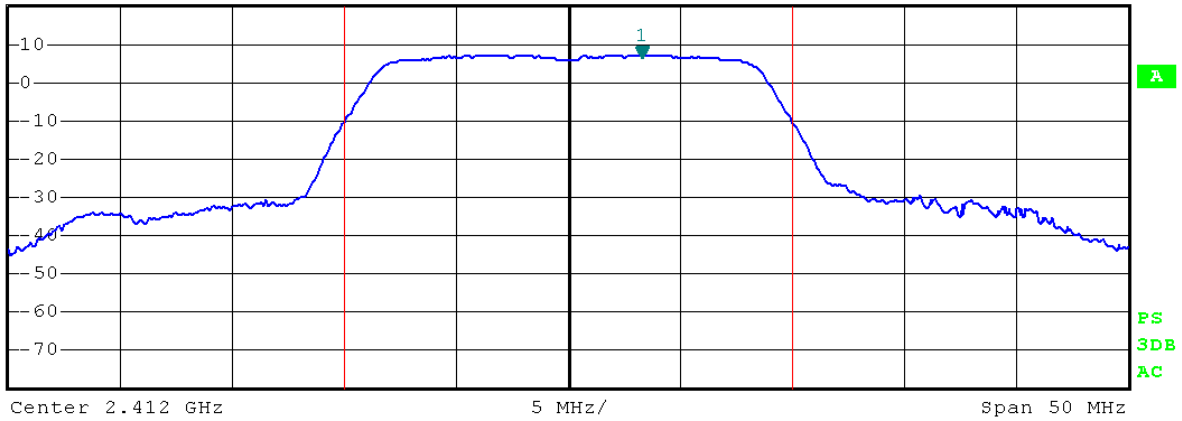

Tx Channel
Bandwidth 20 MHz Power 18.01 dBm

Test Mode: 802.11n(HT20)---Mid



Ref 20 dBm *Att 35 dB *RBW 1 MHz VBW 3 MHz SWT 2.5 ms Marker 1 [T1] 6.46 dBm 2.440400000 GHz

1 PK
MAXH

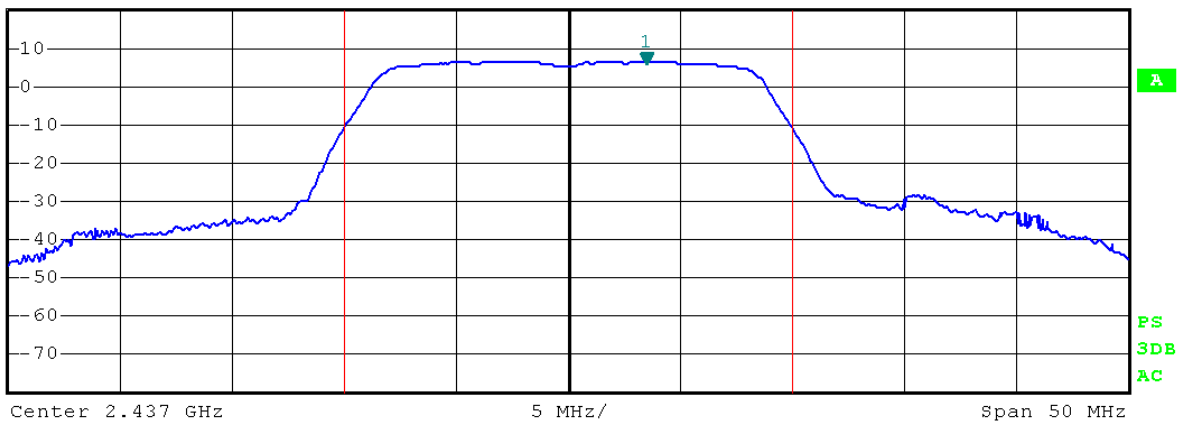

Tx Channel
Bandwidth 20 MHz Power 17.42 dBm

Test Mode: 802.11n(HT20)---High



*RBW 1 MHz
VBW 3 MHz
SWT 2.5 ms
Marker 1 [T1]
3.55 dBm
2.460000000 GHz

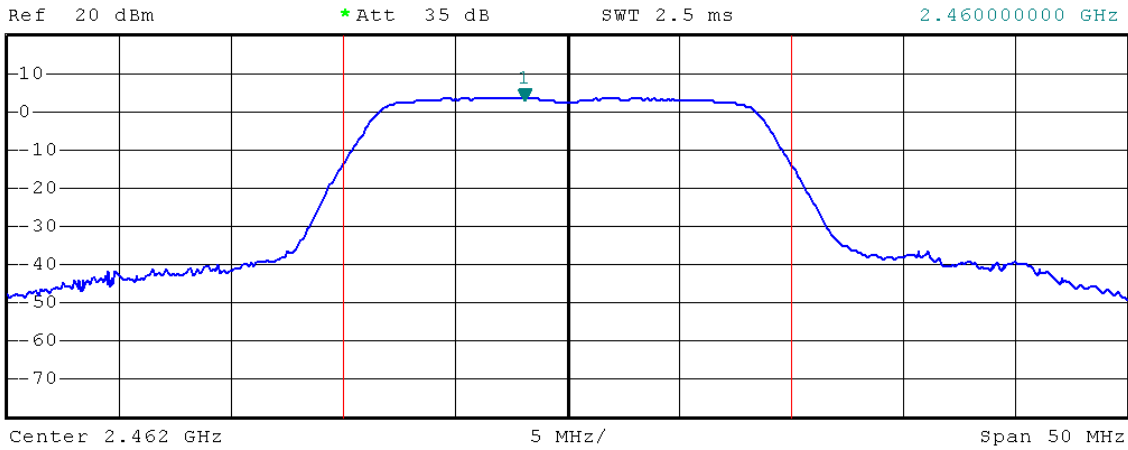

Tx Channel
Bandwidth 20 MHz Power 14.48 dBm

Test Mode: 802.11n(HT40)---Low



*RBW 1 MHz
VBW 3 MHz
SWT 5 ms
Marker 1 [T1]
3.47 dBm
2.430800000 GHz

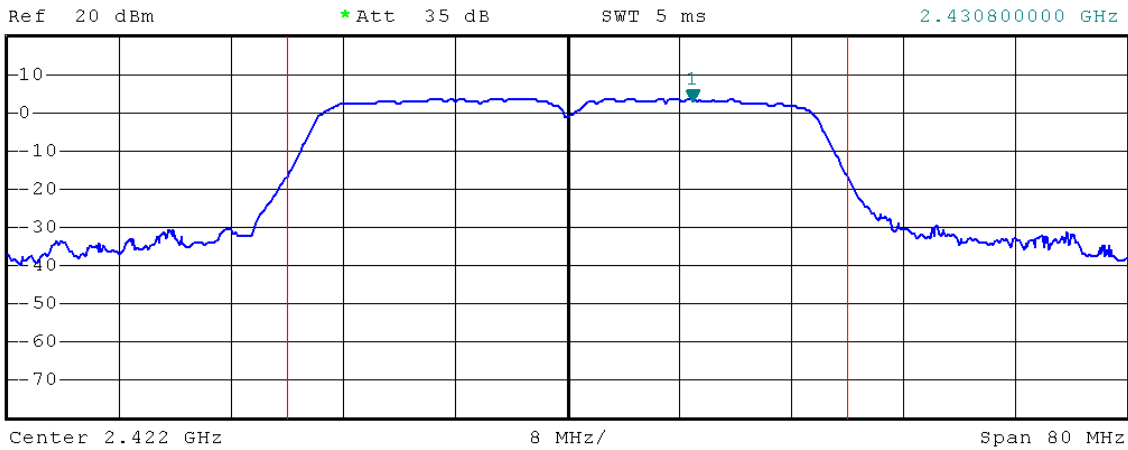

Tx Channel
Bandwidth 40 MHz Power 17.39 dBm

Test Mode: 802.11n(HT40)---Mid



*RBW 1 MHz
VBW 3 MHz
SWT 5 ms
Marker 1 [T1]
3.24 dBm
2.434600000 GHz

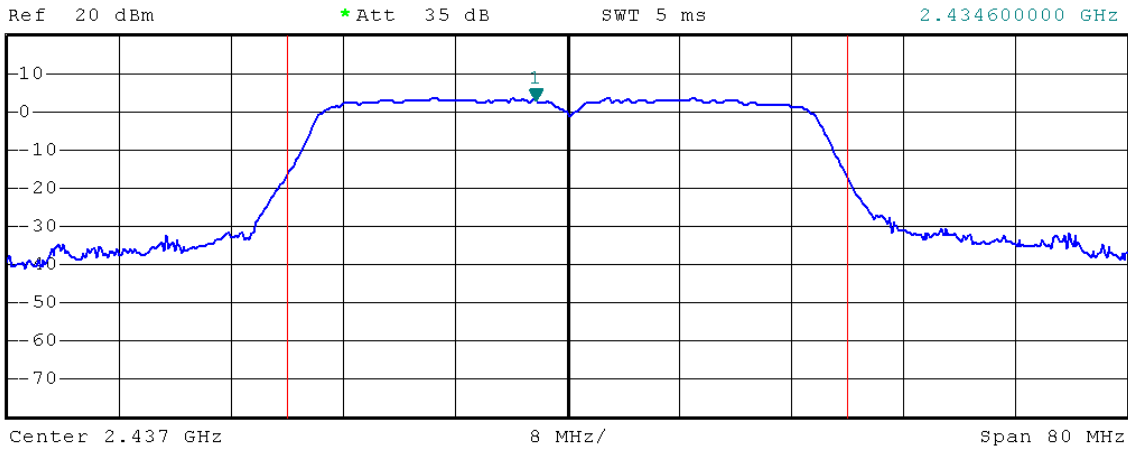

1 PK
MAXH

A

PS
3DB
AC

Tx Channel
Bandwidth 40 MHz Power 17.15 dBm

Test Mode: 802.11n(HT40)---High



*RBW 1 MHz
VBW 3 MHz
SWT 5 ms
Marker 1 [T1]
2.96 dBm
2.448480000 GHz

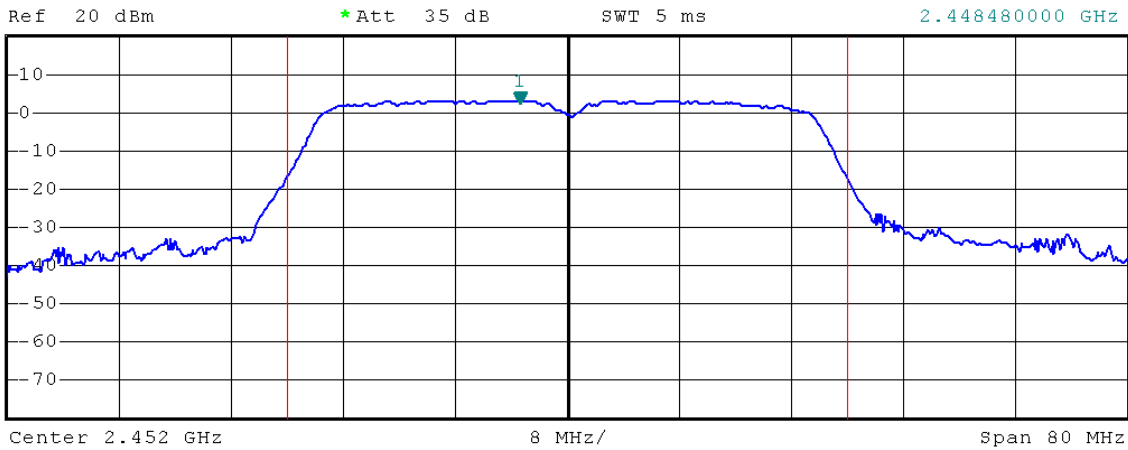

1 PK
MAXH

A

PS
3DB
AC

Tx Channel
Bandwidth 40 MHz Power 16.87 dBm

4.4. Band Edges Measurement

a. Limit

According to §15.247(c), in any 100 kHz bandwidth outside the frequency bands in which the spread spectrum intentional radiator is operating, the radio frequency power that is produced by the intentional radiator shall be at least 20dB below that in the 100kHz bandwidth within the band that contains the highest level of the desired power. In addition, radiated emissions which fall in the restricted bands, as defined in §15.205(a), must also comply with the radiated emission limits specified in §15.209(a).

b. Test Procedure

1. Conducted Method:

- 1) Set RBW=100KHz, VBW=300KHz
- 2) Detector=peak
- 3) Sweep time= auto
- 4) Trace mode=max hold.

2. Radiated Method:

- 1) The EUT is placed on a turntable, which is 0.8m above the ground plane.
- 2) The turntable shall be rotated for 360 degrees to determine the position of maximum emission level.
- 3) EUT is set 3m away from the receiving antenna, which is varied from 1m to 4m to find out the highest emission.
- 4) Peak detector: RBW=1MHz, VBW=3MHz, SWT=AUTO
Average detector: RBW=1MHz, VBW=10Hz, SWT=AUTO
The EUT is tested in 9*6*6 Chamber.
- 5) Repeat the procedures until all the PEAK and AVERAGE versus POLARIZATION are measured.

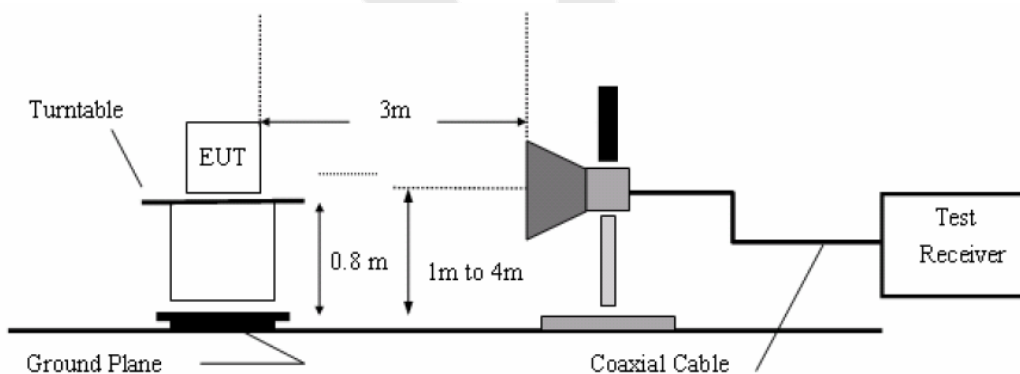

c. Test Equipment

Same as the equipment listed in 4.2.

d. Test Results

Pass.

e. Test Plots

See the following page.

Test Mode: 802.11b ---Low

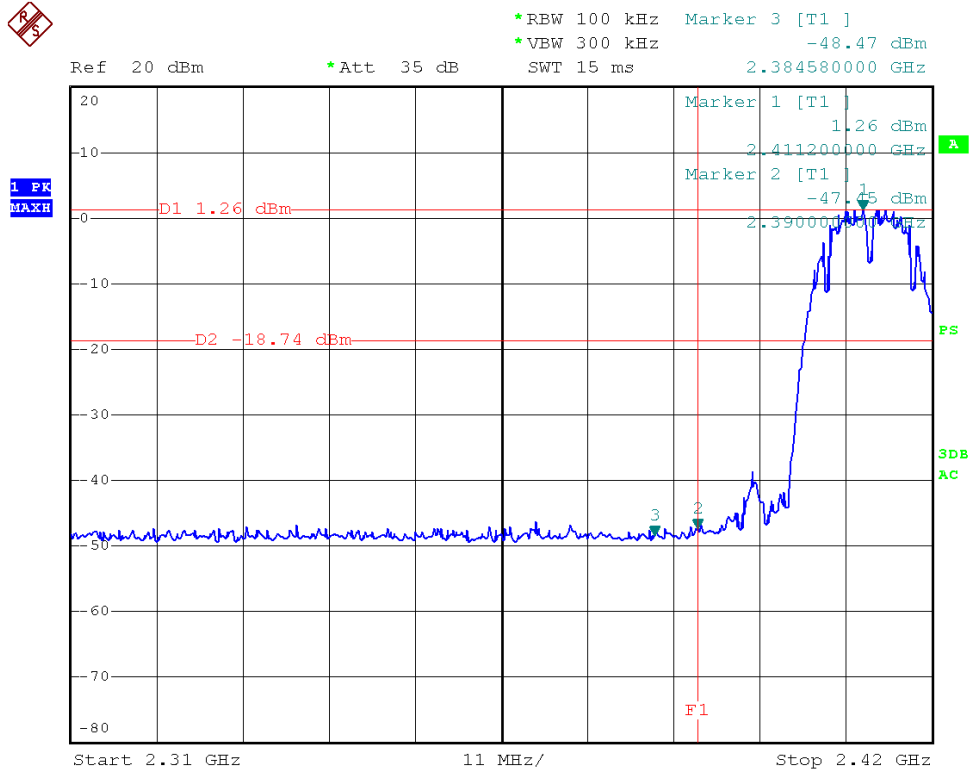

Test Mode: 802.11b ---High

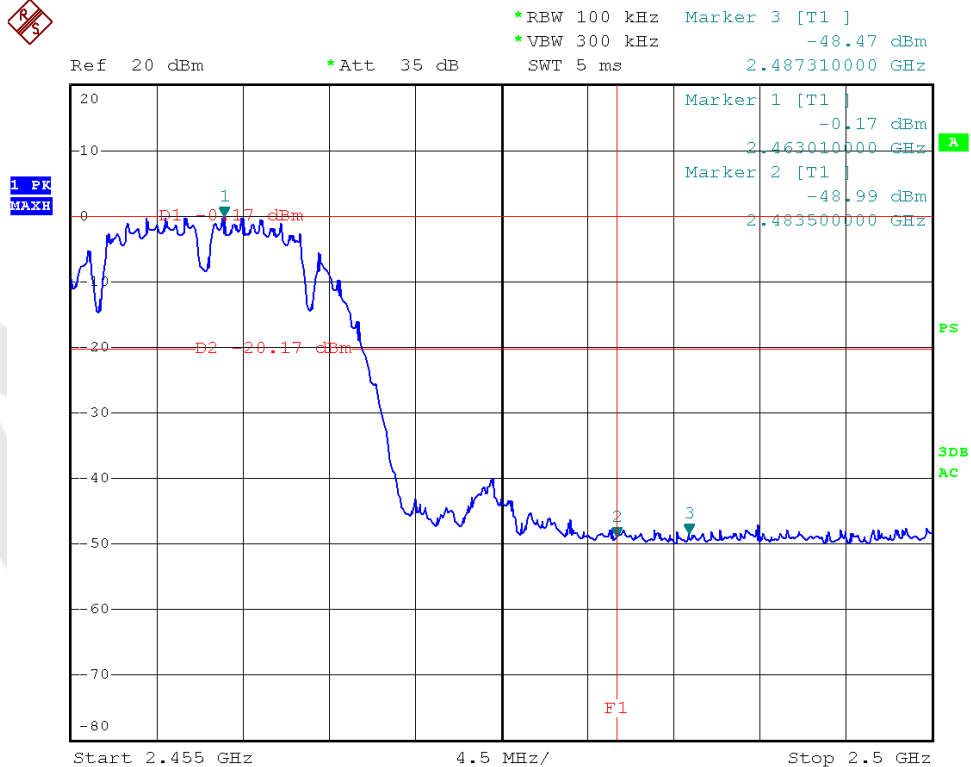

Test Mode: 802.11g ---Low

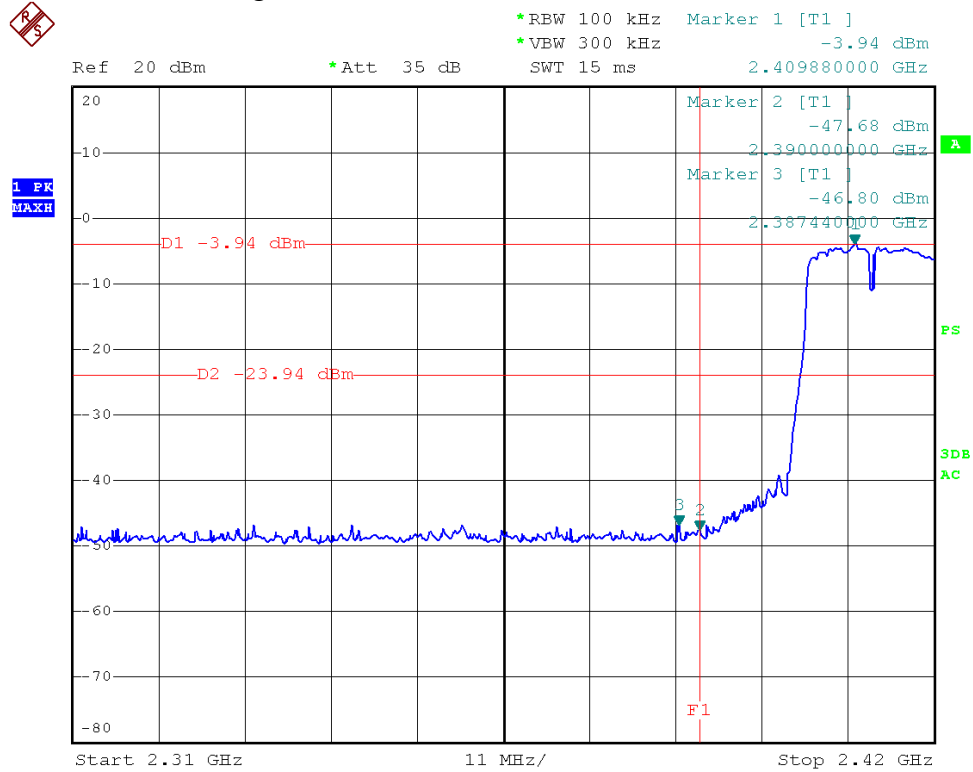

Test Mode: 802.11g ---High

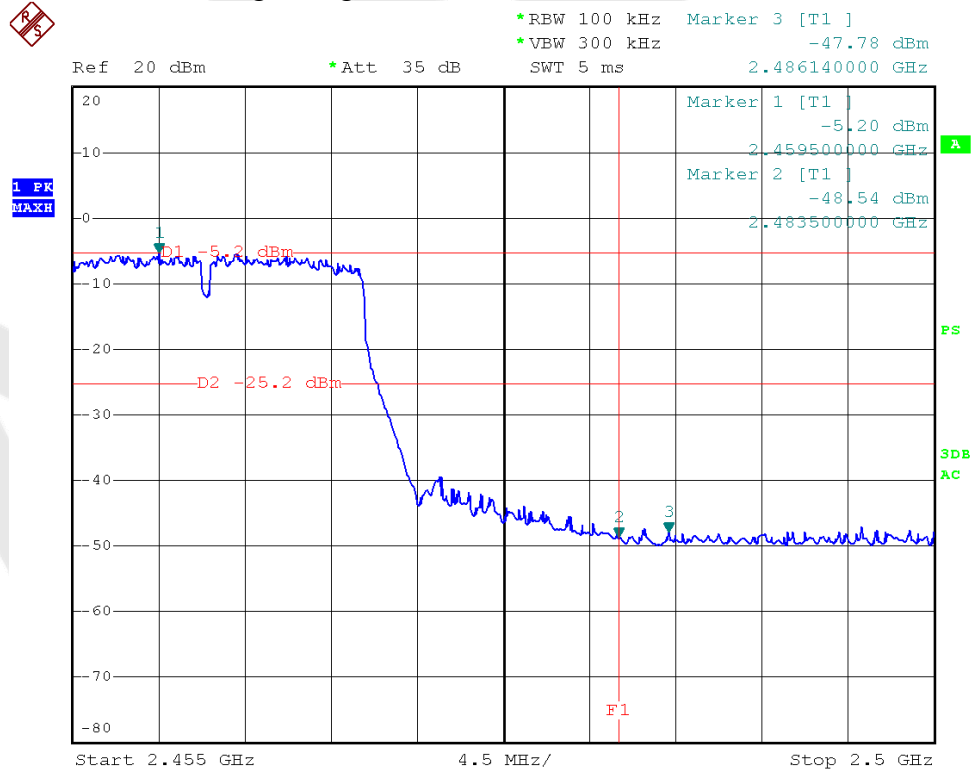

Test Mode: 802.11n (HT20) ---Low

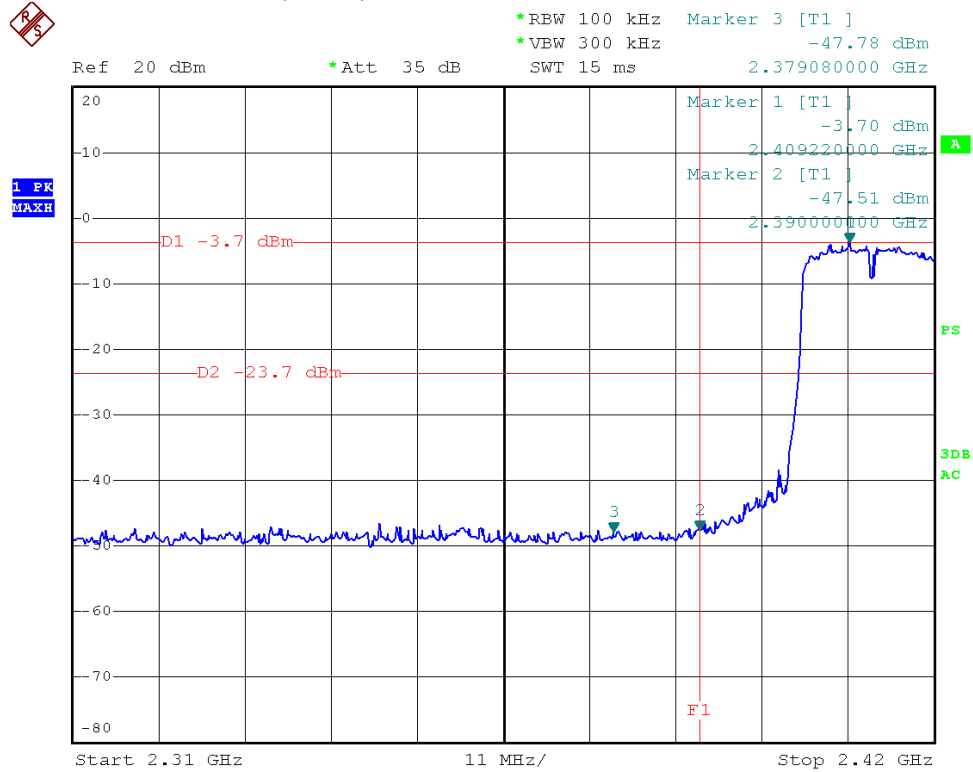

Test Mode: 802.11n (HT20)---High

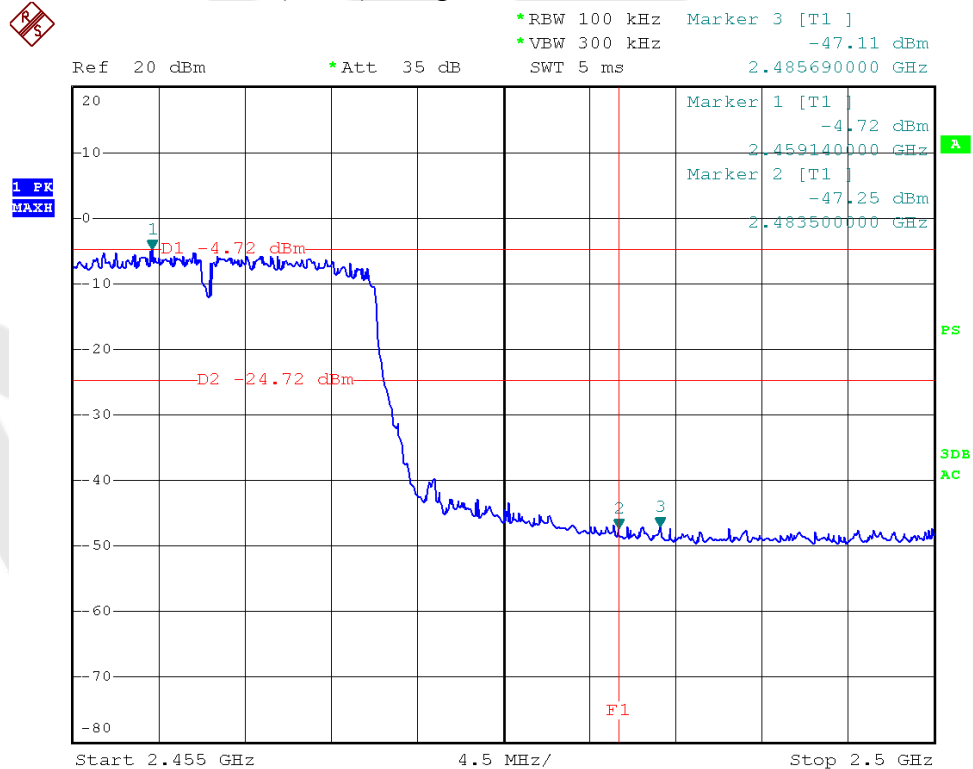

Test Mode: 802.11n (HT40) ---Low

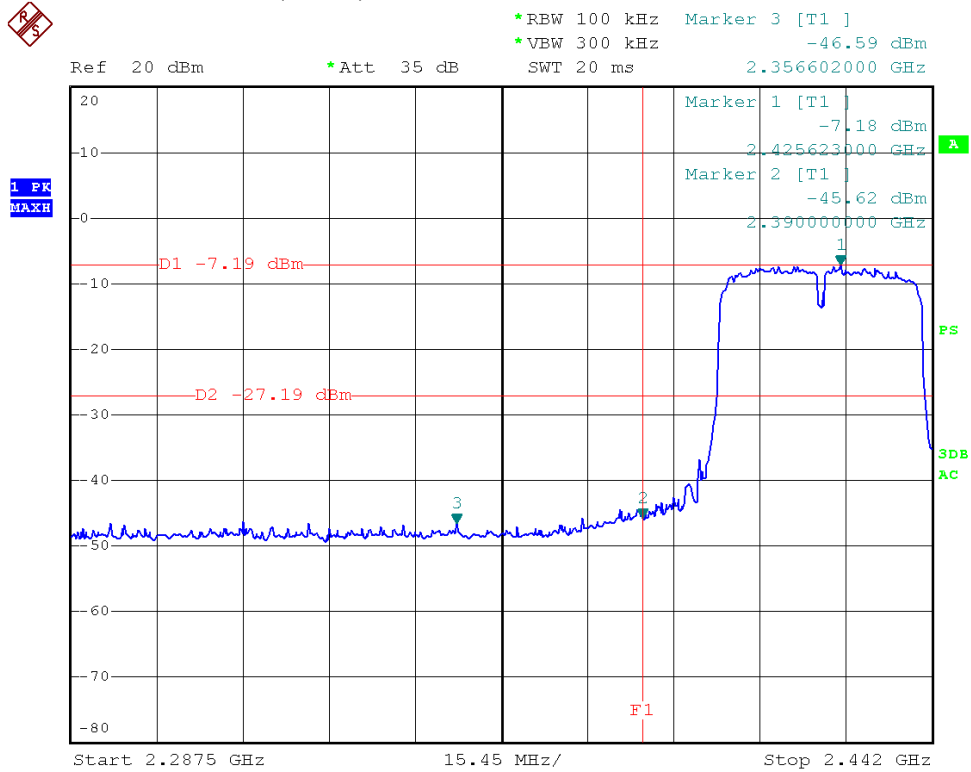

Test Mode: 802.11n (HT40) ---High

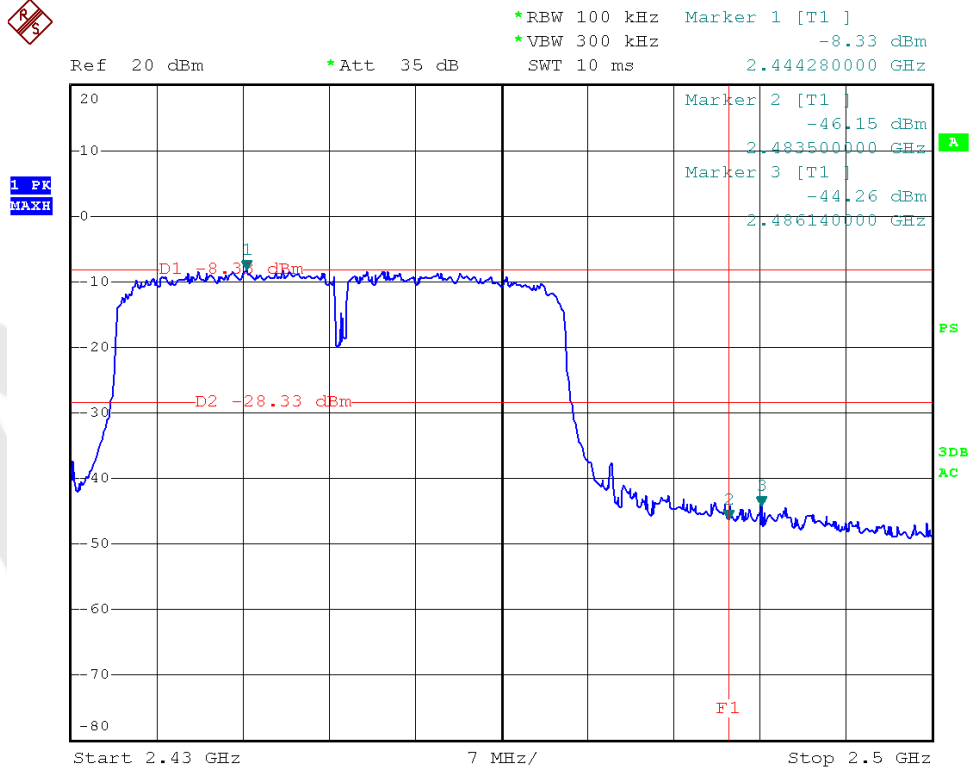

Test Mode: 802.11b
2412MHz
Horizontal-PEAK:

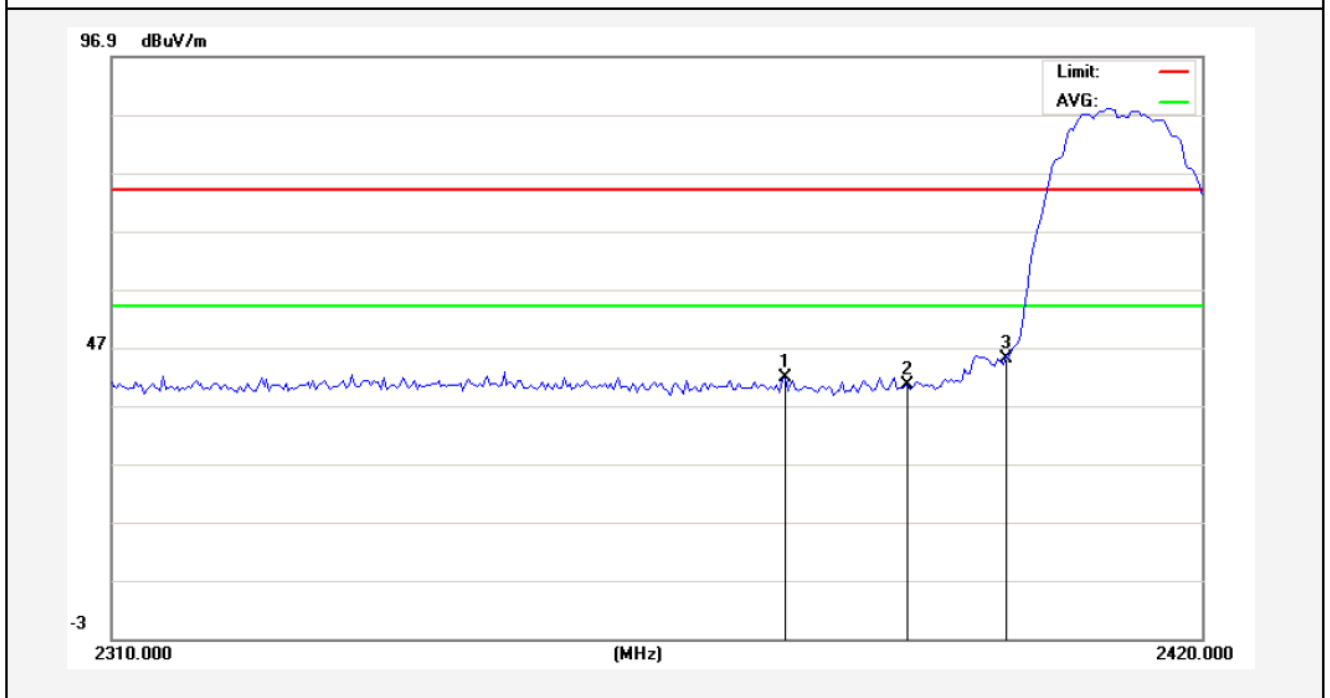

No.	Freq. (MHz)	Reading (dBuV/m)	Factor (dB/m)	Result (dBuV/m)	Limit (dBuV/)	Over Limit (dB)	Detector	Height (cm)	degree (deg)	Remark
1	2377.375	44.24	-2.54	41.70	74.00	-32.30	peak			
2	2390.000	42.96	-2.51	40.45	74.00	-33.55	peak			
3	2400.000	47.56	-2.49	45.07	74.00	-28.93	peak			

AMB

Horizontal-AV:

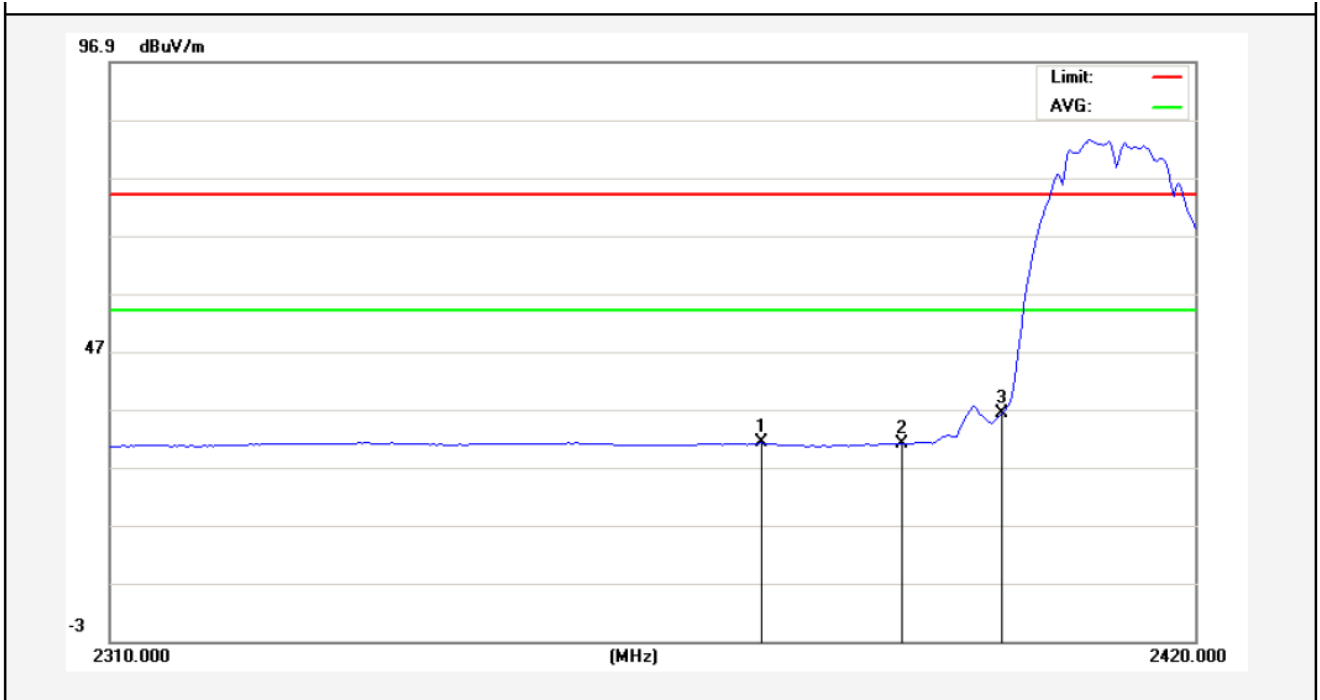

No.	Freq. (MHz)	Reading (dBuV/m)	Factor (dB/m)	Result (dBuV/m)	Limit (dBuV/)	Over Limit (dB)	Detector	Height (cm)	degree (deg)	Remark
1	2375.450	33.78	-2.55	31.23	54.00	-22.77	AVG			
2	2390.000	33.61	-2.51	31.10	54.00	-22.90	AVG			
3	2400.000	38.76	-2.49	36.27	54.00	-17.73	AVG			

Anbotek

Test Mode: 802.11b
2412MHz
Vertical-PEAK:

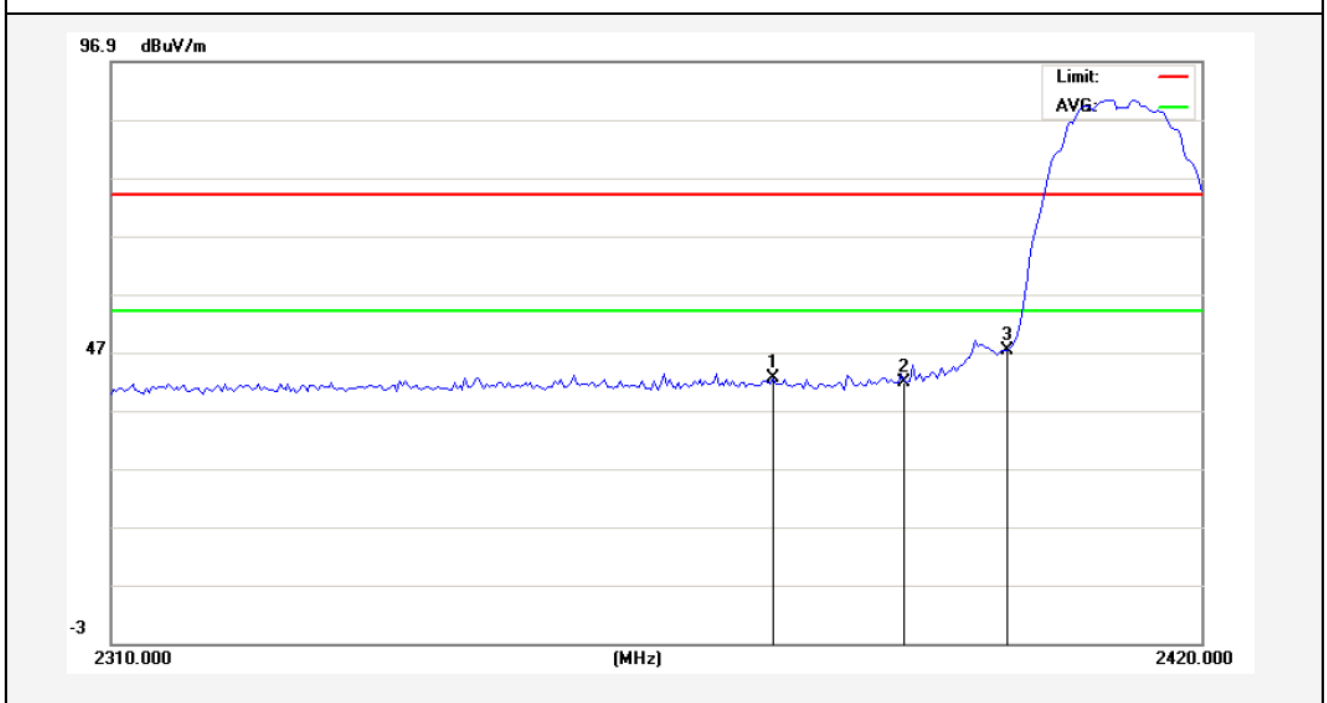

No.	Freq. (MHz)	Reading (dBuV/m)	Factor (dB/m)	Result (dBuV/m)	Limit (dBuV/)	Over Limit (dB)	Detector	Height (cm)	degree (deg)	Remark
1	2376.275	45.04	-2.54	42.50	74.00	-31.50	peak			
2	2390.000	44.34	-2.51	41.83	74.00	-32.17	peak			
3	2400.000	49.76	-2.49	47.27	74.00	-26.73	peak			

AMB

Vertical-AV:

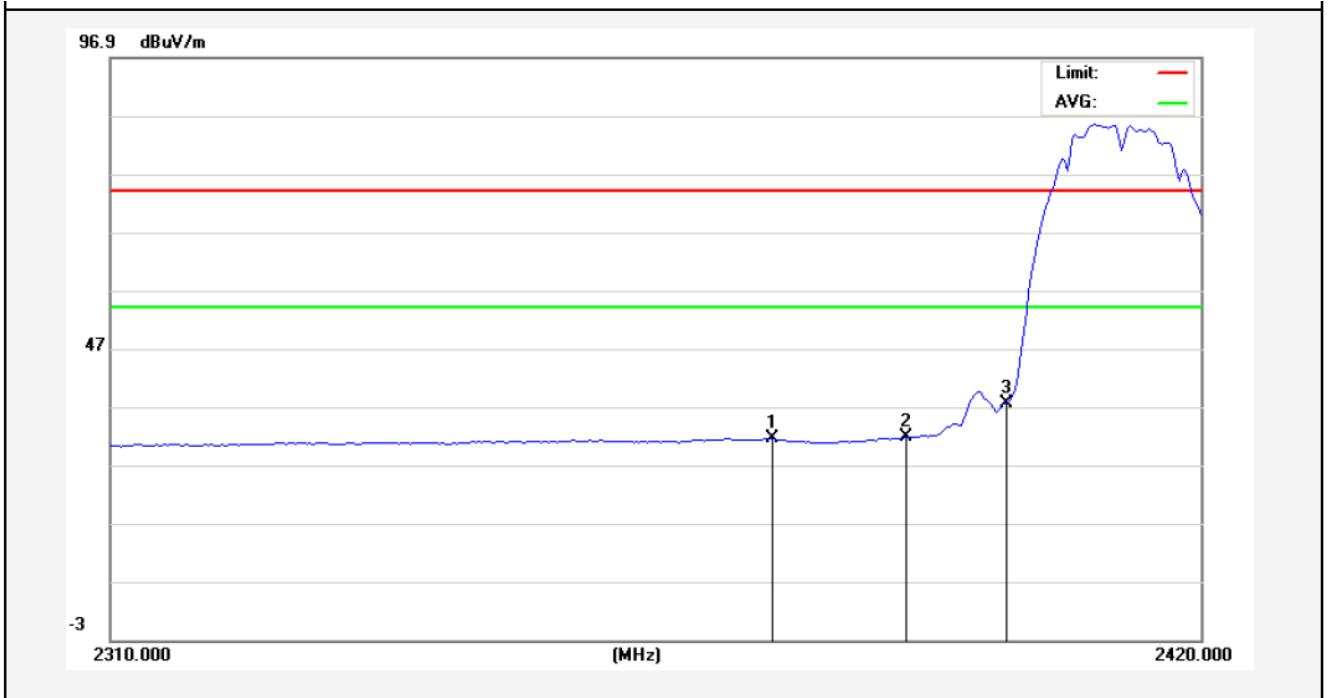

No.	Freq. (MHz)	Reading (dBuV/m)	Factor (dB/m)	Result (dBuV/m)	Limit (dBuV/)	Over Limit (dB)	Detector	Height (cm)	degree (deg)	Remark
1	2376.275	34.11	-2.54	31.57	54.00	-22.43	AVG			
2	2390.000	34.23	-2.51	31.72	54.00	-22.28	AVG			
3	2400.000	40.14	-2.49	37.65	54.00	-16.35	AVG			

Anbotek

Test Mode: 802.11b
2462MHz
Horizontal-PEAK:

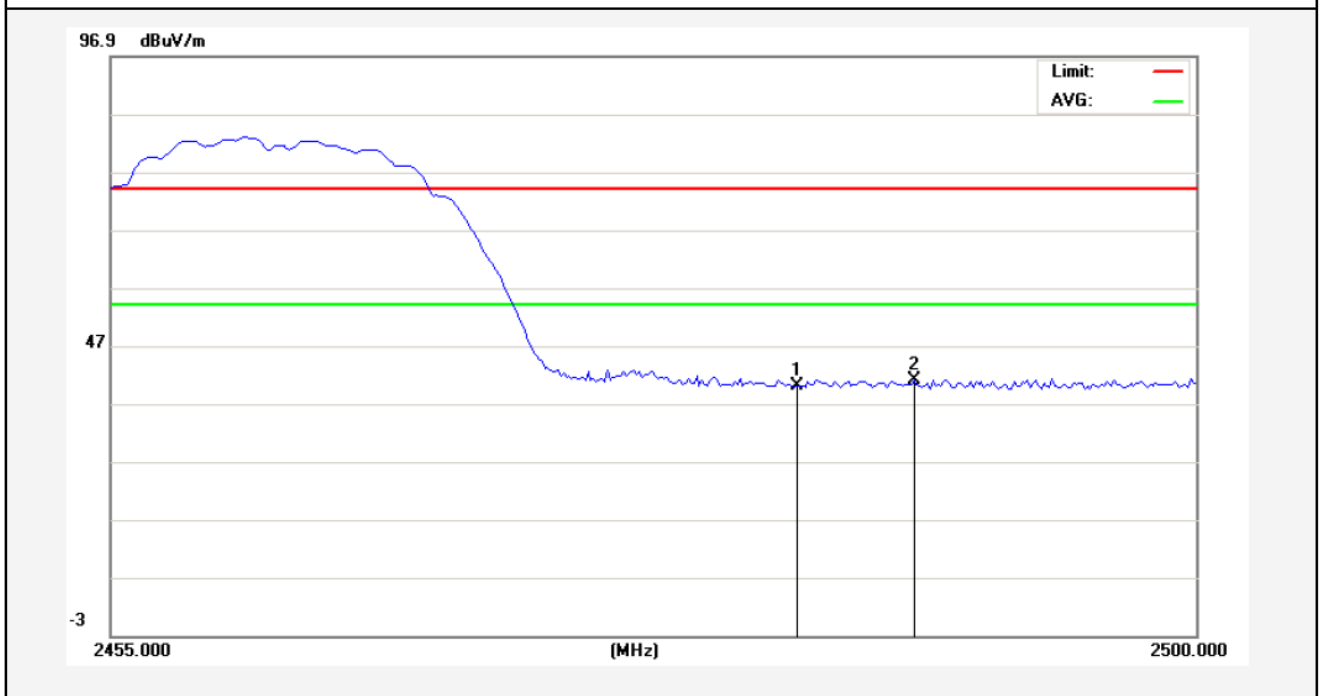

No.	Freq. (MHz)	Reading (dBuV/m)	Factor (dB/m)	Result (dBuV/m)	Limit (dBuV/)	Over Limit (dB)	Detector	Height (cm)	degree (deg)	Remark
1	2483.500	42.23	-2.31	39.92	74.00	-34.08	peak			
2	2488.300	43.29	-2.30	40.99	74.00	-33.01	peak			

Anbotek

Horizontal-AV:

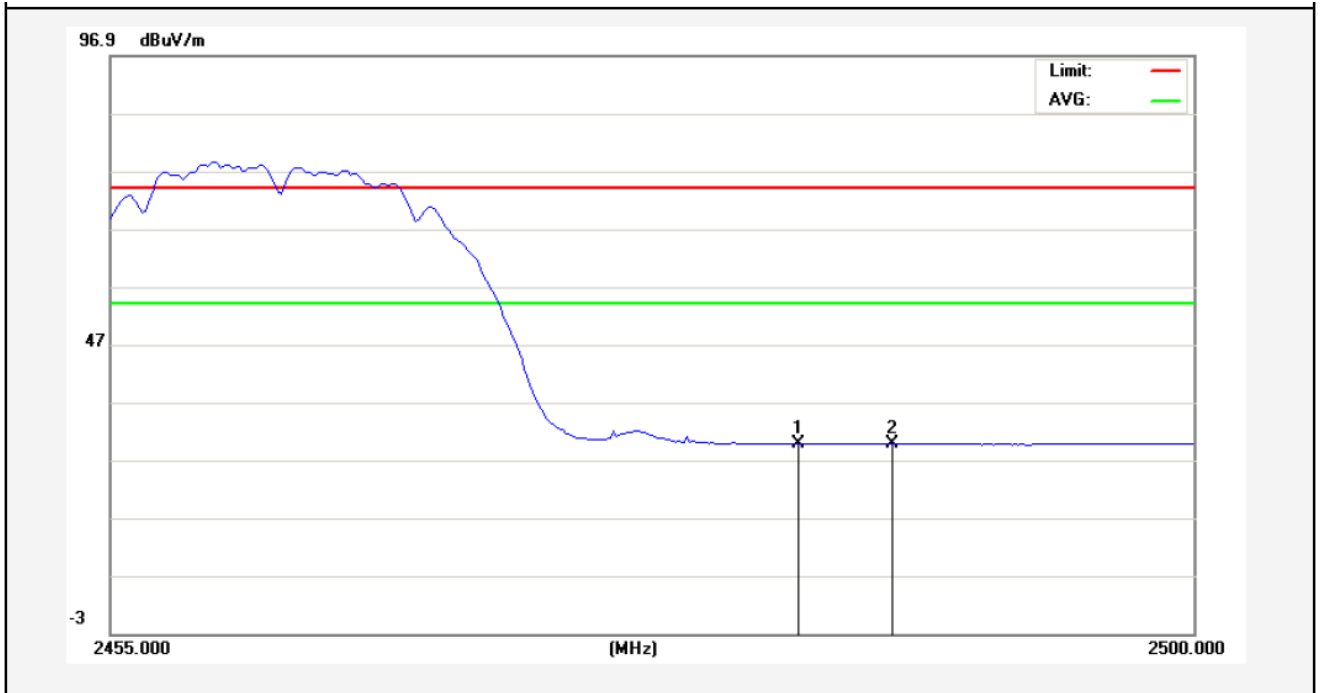

No.	Freq. (MHz)	Reading (dBuV/m)	Factor (dB/m)	Result (dBuV/m)	Limit (dBuV/)	Over Limit (dB)	Detector	Height (cm)	degree (deg)	Remark
1	2483.500	32.14	-2.31	29.83	54.00	-24.17	AVG			
2	2487.512	32.19	-2.30	29.89	54.00	-24.11	AVG			

Test Mode: 802.11b
2462MHz
Vertical-PEAK:

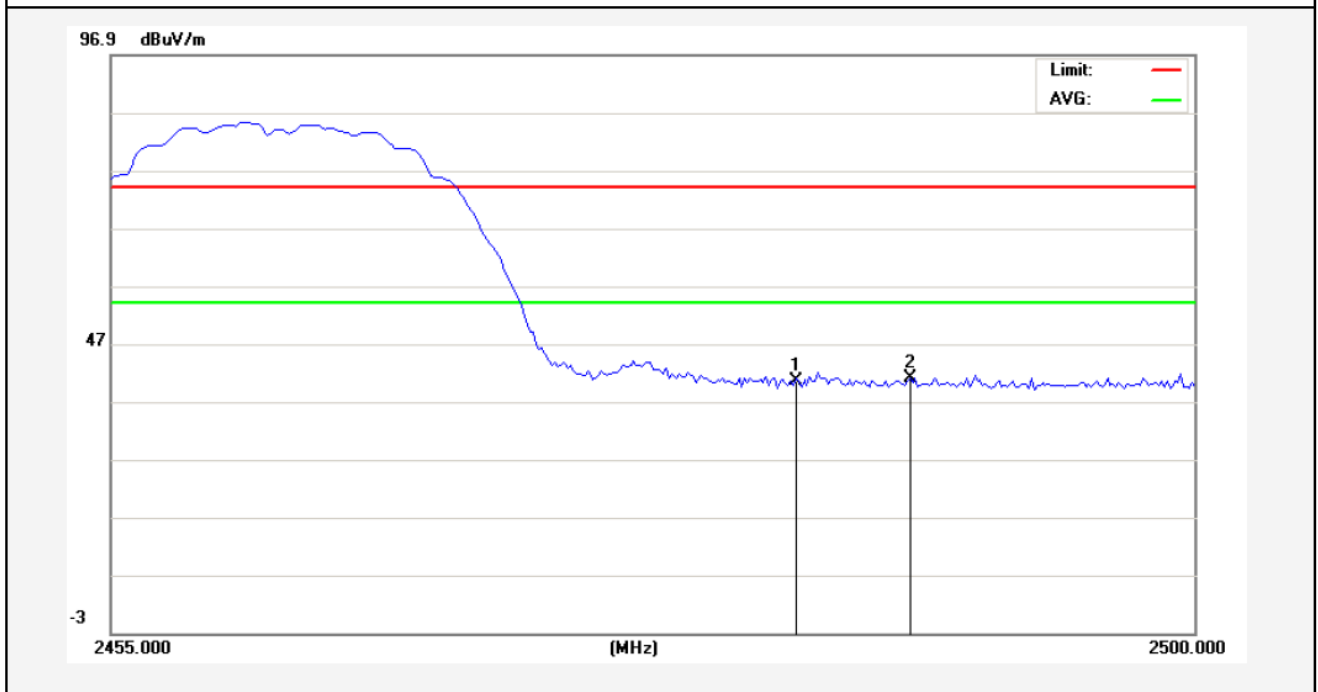

No.	Freq. (MHz)	Reading (dBuV/m)	Factor (dB/m)	Result (dBuV/m)	Limit (dBuV/)	Over Limit (dB)	Detector	Height (cm)	degree (deg)	Remark
1	2483.500	42.80	-2.31	40.49	74.00	-33.51	peak			
2	2488.188	43.35	-2.30	41.05	74.00	-32.95	peak			

Anbotek

Vertical-AV:

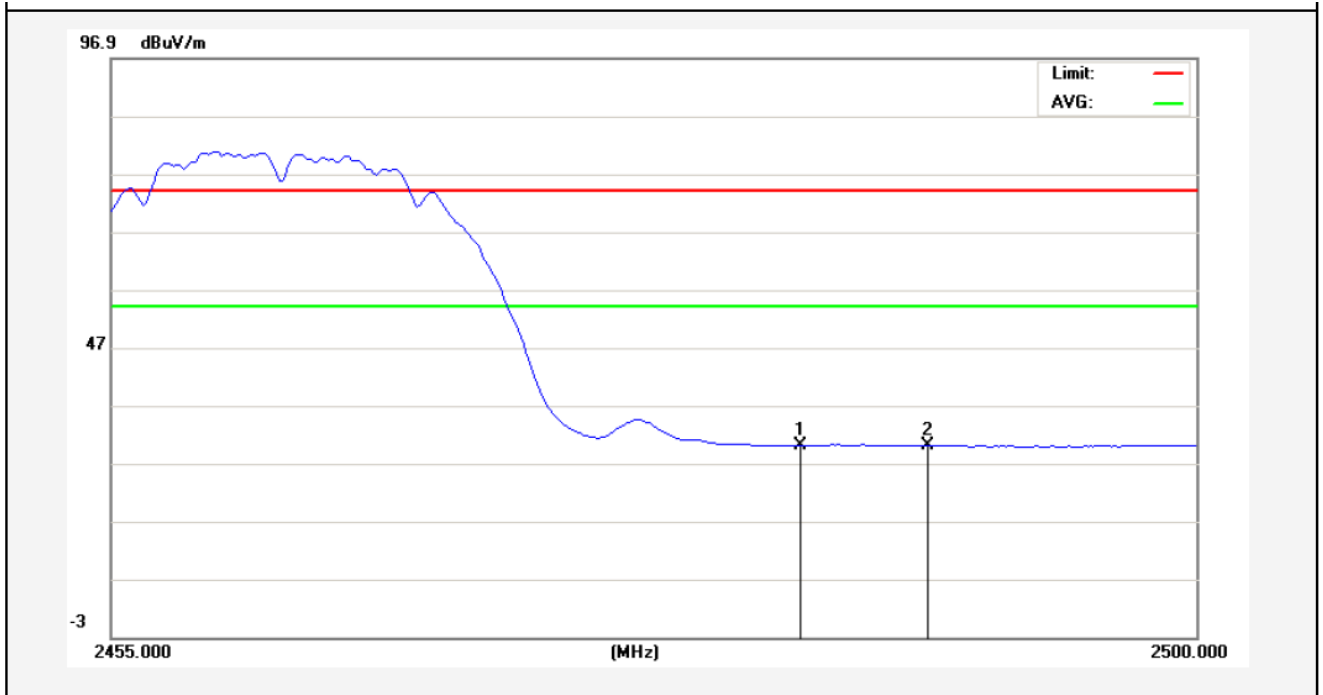

No.	Freq. (MHz)	Reading (dBuV/m)	Factor (dB/m)	Result (dBuV/m)	Limit (dBuV/)	Over Limit (dB)	Detector	Height (cm)	degree (deg)	Remark
1	2483.500	32.37	-2.31	30.06	54.00	-23.94	AVG			
2	2488.863	32.41	-2.29	30.12	54.00	-23.88	AVG			

Anbotek

Test Mode: 802.11g
2412MHz
Horizontal-PEAK:

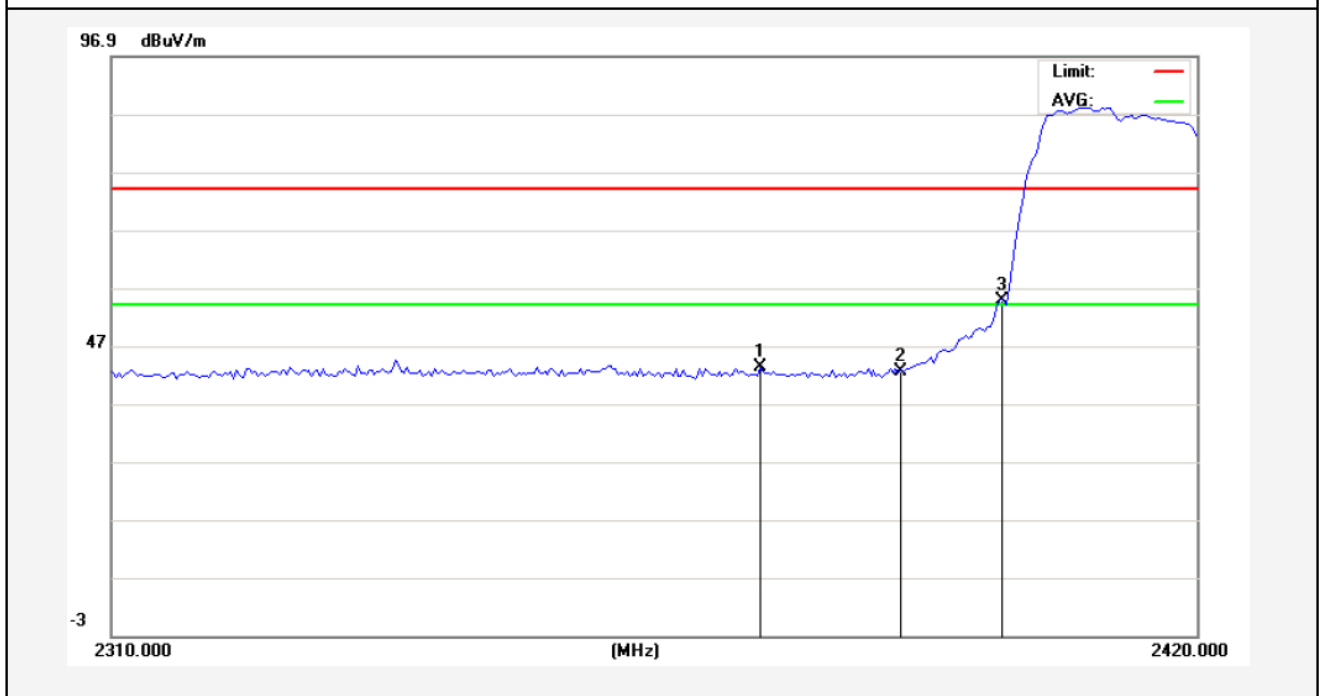

No.	Freq. (MHz)	Reading (dBuV/m)	Factor (dB/m)	Result (dBuV/m)	Limit (dBuV/)	Over Limit (dB)	Detector	Height (cm)	degree (deg)	Remark
1	2375.175	45.73	-2.55	43.18	74.00	-30.82	peak			
2	2390.000	45.05	-2.51	42.54	74.00	-31.46	peak			
3	2400.000	57.21	-2.49	54.72	74.00	-19.28	peak			

Anbotek

Horizontal-AV:

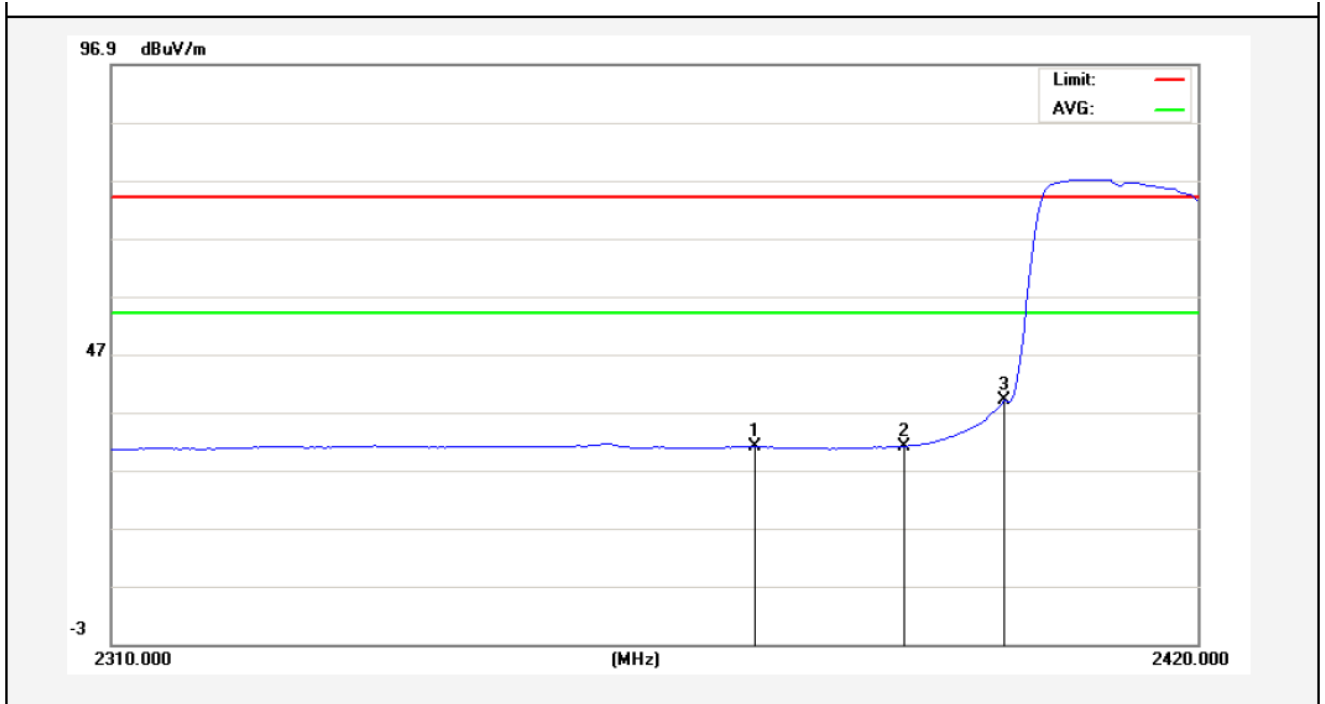

No.	Freq. (MHz)	Reading (dBuV/m)	Factor (dB/m)	Result (dBuV/m)	Limit (dBuV/)	Over Limit (dB)	Detector	Height (cm)	degree (deg)	Remark
1	2374.625	33.61	-2.55	31.06	54.00	-22.94	AVG			
2	2390.000	33.63	-2.51	31.12	54.00	-22.88	AVG			
3	2400.000	41.50	-2.49	39.01	54.00	-14.99	AVG			

Anbotek

Test Mode: 802.11g
2412MHz
Vertical-PEAK:

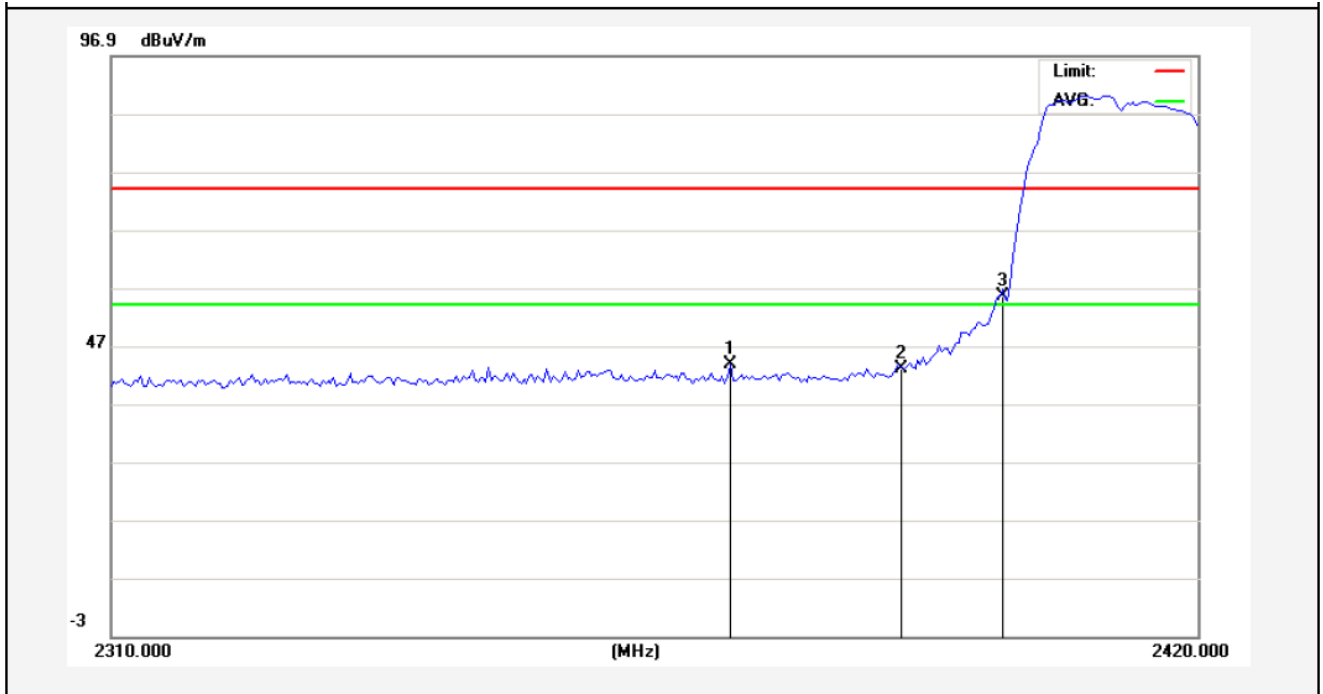

No.	Freq. (MHz)	Reading (dBuV/m)	Factor (dB/m)	Result (dBuV/m)	Limit (dBuV/)	Over Limit (dB)	Detector	Height (cm)	degree (deg)	Remark
1	2372.150	46.31	-2.55	43.76	74.00	-30.24	peak			
2	2390.000	45.53	-2.51	43.02	74.00	-30.98	peak			
3	2400.000	58.01	-2.49	55.52	74.00	-18.48	peak			

Anbotek

Vertical-AV:

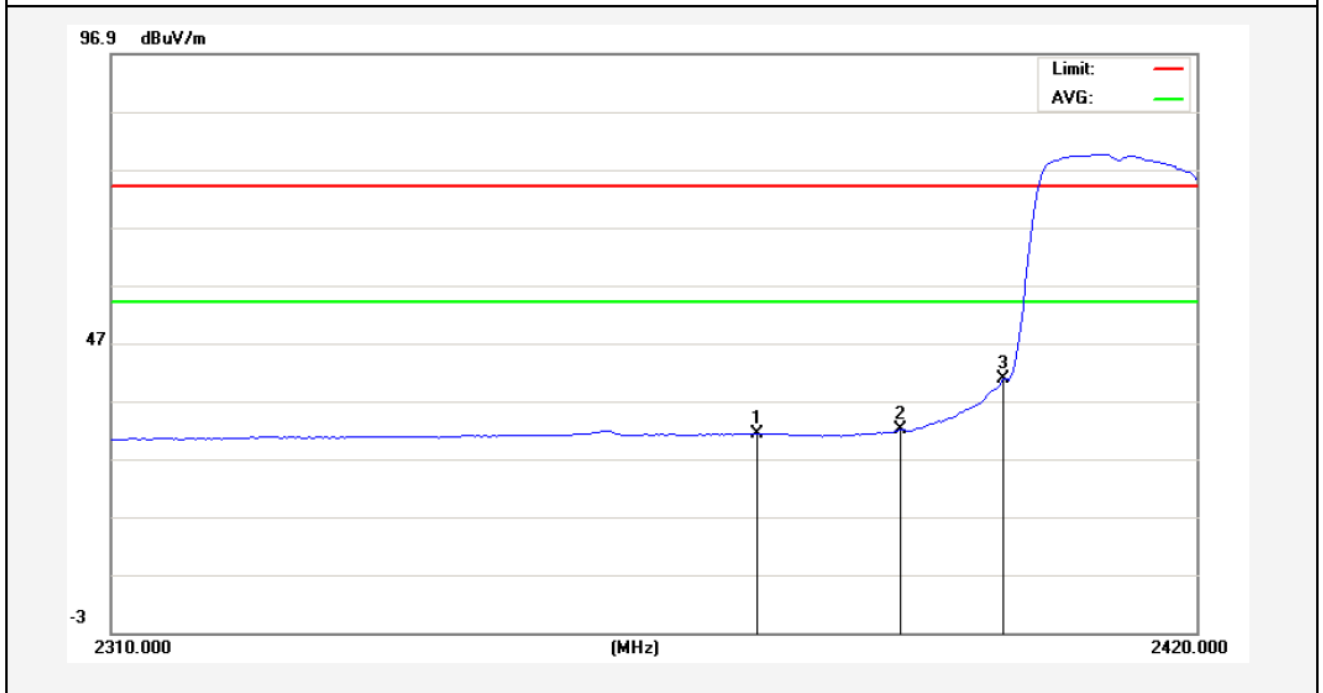

No.	Freq. (MHz)	Reading (dBuV/m)	Factor (dB/m)	Result (dBuV/m)	Limit (dBuV/)	Over Limit (dB)	Detector	Height (cm)	degree (deg)	Remark
1	2374.900	33.92	-2.55	31.37	54.00	-22.63	AVG			
2	2390.000	34.44	-2.51	31.93	54.00	-22.07	AVG			
3	2400.000	43.33	-2.49	40.84	54.00	-13.16	AVG			

Anbotek

Test Mode: 802.11g
2462MHz
Horizontal-PEAK:

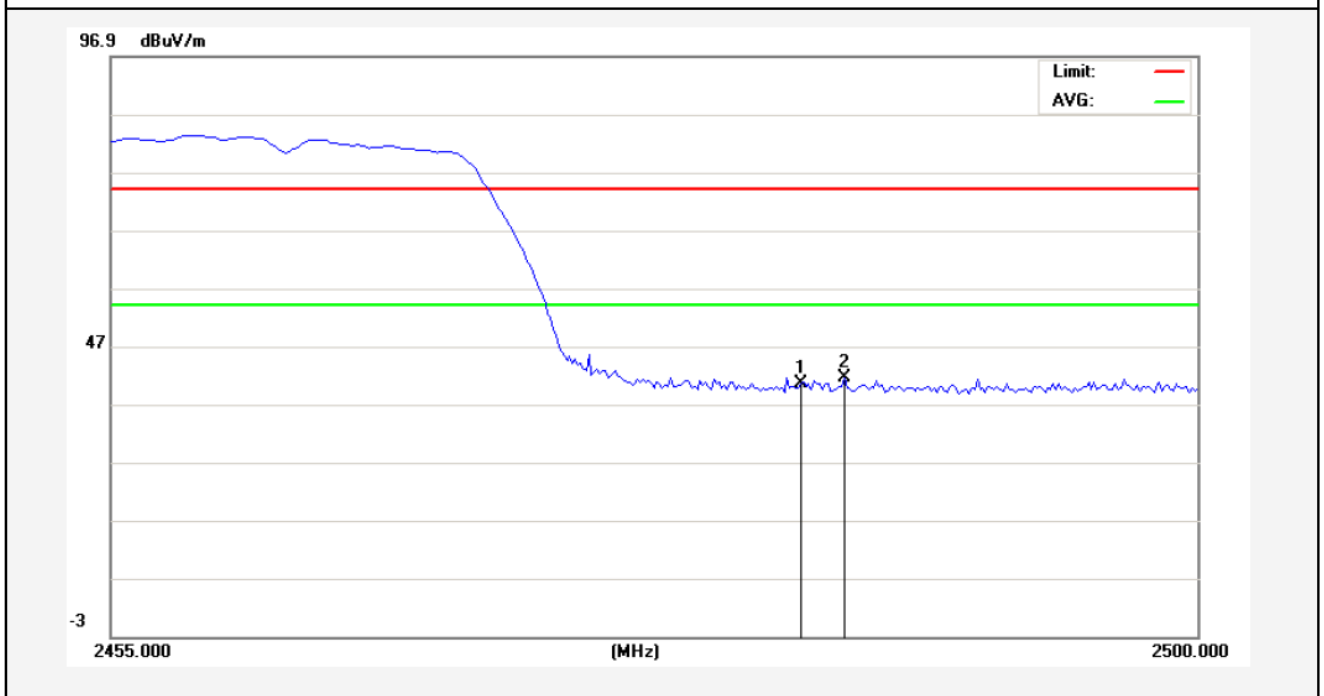

No.	Freq. (MHz)	Reading (dBuV/m)	Factor (dB/m)	Result (dBuV/m)	Limit (dBuV/)	Over Limit (dB)	Detector	Height (cm)	degree (deg)	Remark
1	2483.500	42.95	-2.31	40.64	74.00	-33.36	peak			
2	2485.375	43.81	-2.30	41.51	74.00	-32.49	peak			

Anbotek

Horizontal-AV:

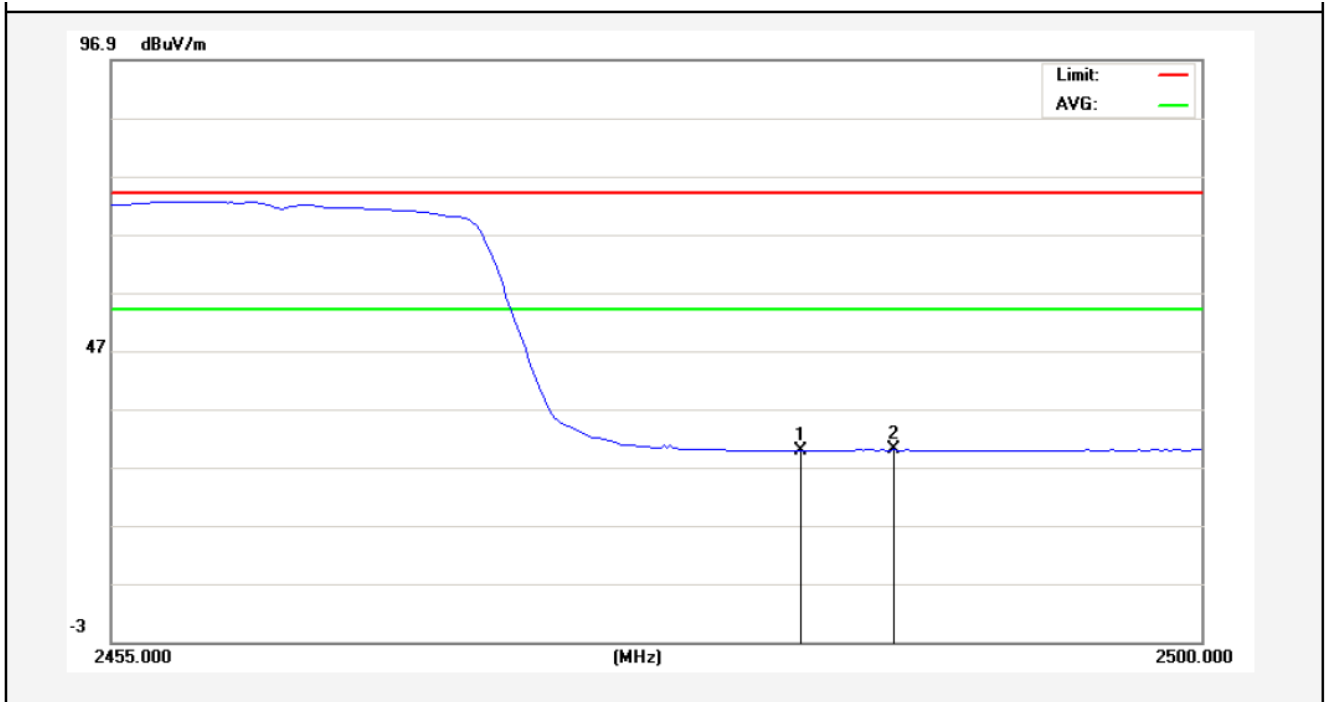

No.	Freq. (MHz)	Reading (dBuV/m)	Factor (dB/m)	Result (dBuV/m)	Limit (dBuV/)	Over Limit (dB)	Detector	Height (cm)	degree (deg)	Remark
1	2483.500	32.13	-2.31	29.82	54.00	-24.18	AVG			
2	2487.287	32.24	-2.30	29.94	54.00	-24.06	AVG			

Anbotek

Test Mode: 802.11g
2462MHz
Vertical-PEAK:

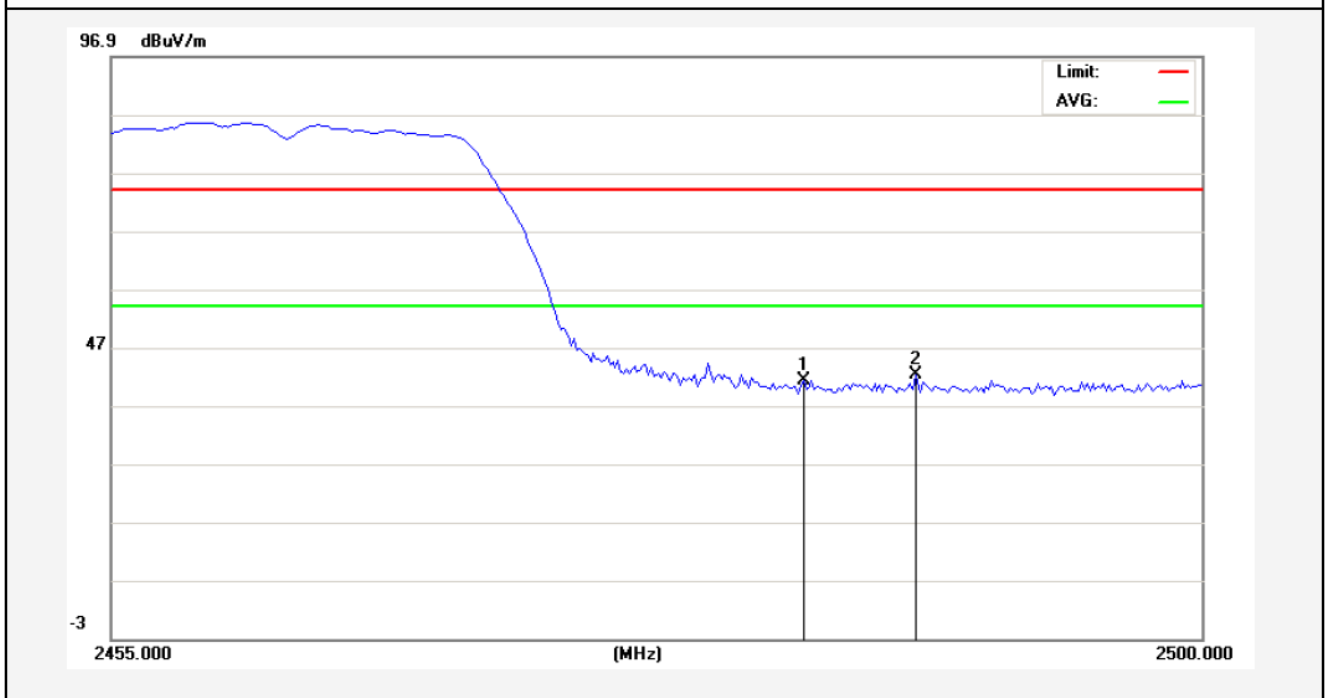

No.	Freq. (MHz)	Reading (dBuV/m)	Factor (dB/m)	Result (dBuV/m)	Limit (dBuV/)	Over Limit (dB)	Detector	Height (cm)	degree (deg)	Remark
1	2483.500	43.54	-2.31	41.23	74.00	-32.77	peak			
2	2488.188	44.52	-2.30	42.22	74.00	-31.78	peak			

Anbotek

Vertical-AV:

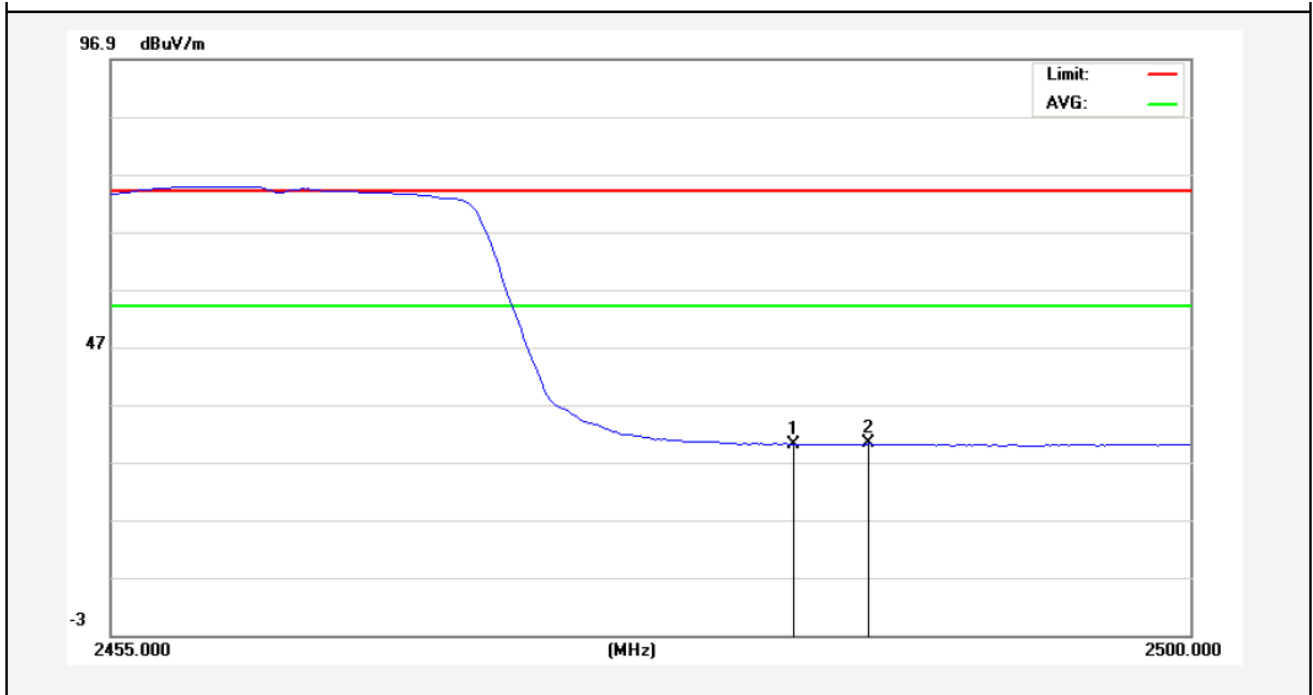

No.	Freq. (MHz)	Reading (dBuV/m)	Factor (dB/m)	Result (dBuV/m)	Limit (dBuV/)	Over Limit (dB)	Detector	Height (cm)	degree (deg)	Remark
1	2483.500	32.40	-2.31	30.09	54.00	-23.91	AVG			
2	2486.613	32.46	-2.30	30.16	54.00	-23.84	AVG			

Anbotek

Test Mode: 802.11n (HT20)
2412MHz
Horizontal-PEAK:

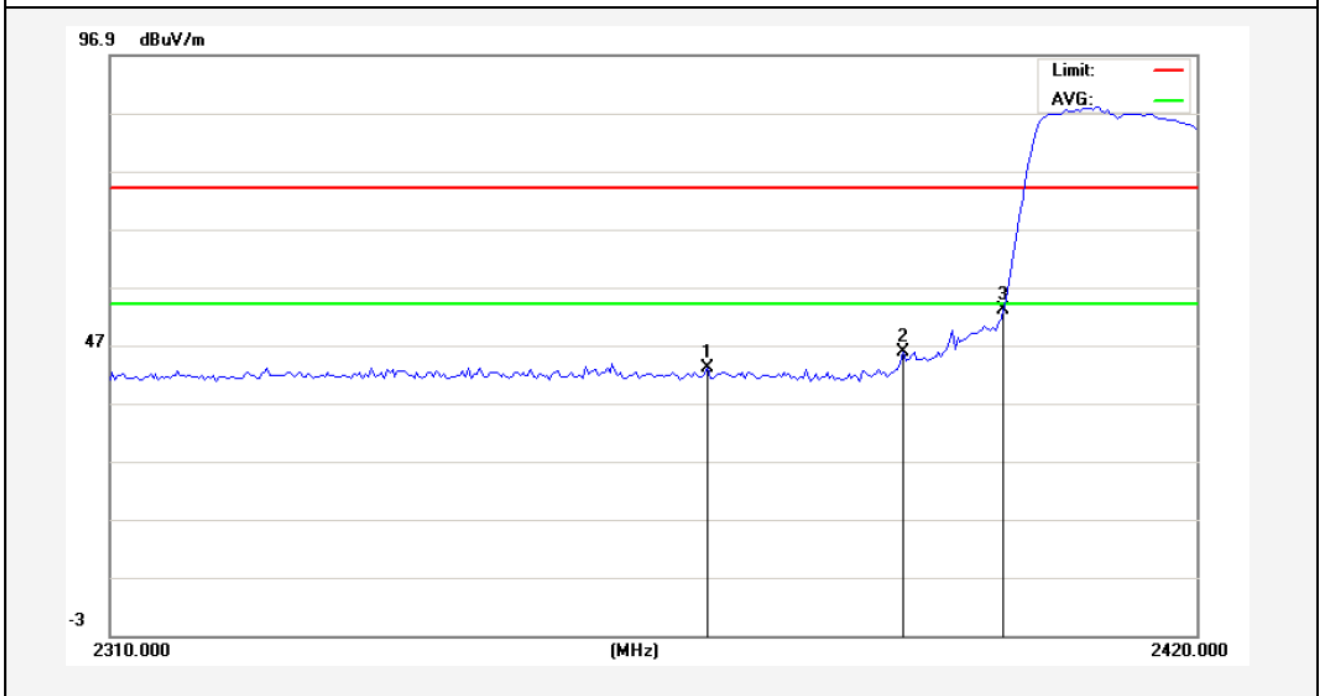

No.	Freq. (MHz)	Reading (dBuV/m)	Factor (dB/m)	Result (dBuV/m)	Limit (dBuV/)	Over Limit (dB)	Detector	Height (cm)	degree (deg)	Remark
1	2369.950	45.47	-2.56	42.91	74.00	-31.09	peak			
2	2390.000	48.39	-2.51	45.88	74.00	-28.12	peak			
3	2400.000	55.62	-2.49	53.13	74.00	-20.87	peak			

AMB

Horizontal-AV:

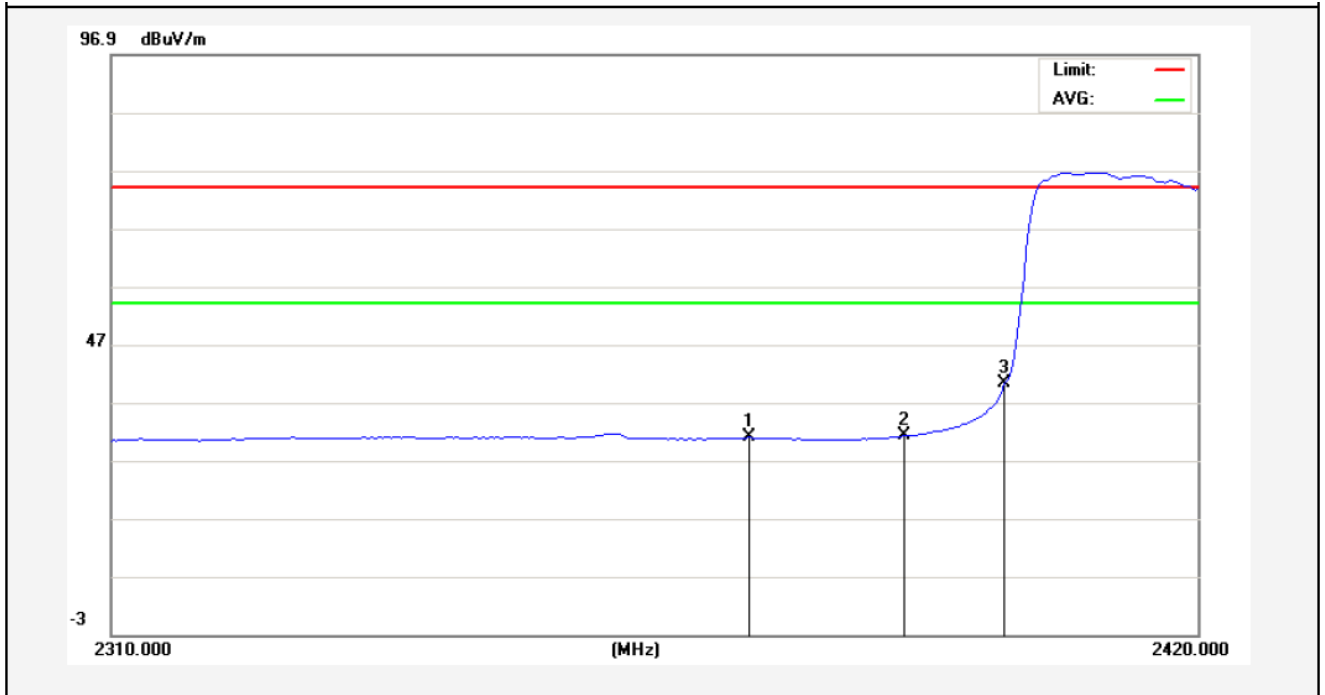

No.	Freq. (MHz)	Reading (dBuV/m)	Factor (dB/m)	Result (dBuV/m)	Limit (dBuV/)	Over Limit (dB)	Detector	Height (cm)	degree (deg)	Remark
1	2374.075	33.46	-2.55	30.91	54.00	-23.09	AVG			
2	2390.000	33.73	-2.51	31.22	54.00	-22.78	AVG			
3	2400.000	42.70	-2.49	40.21	54.00	-13.79	AVG			

Anbotek

Test Mode: 802.11n (HT20)
2412MHz
Vertical-PEAK:

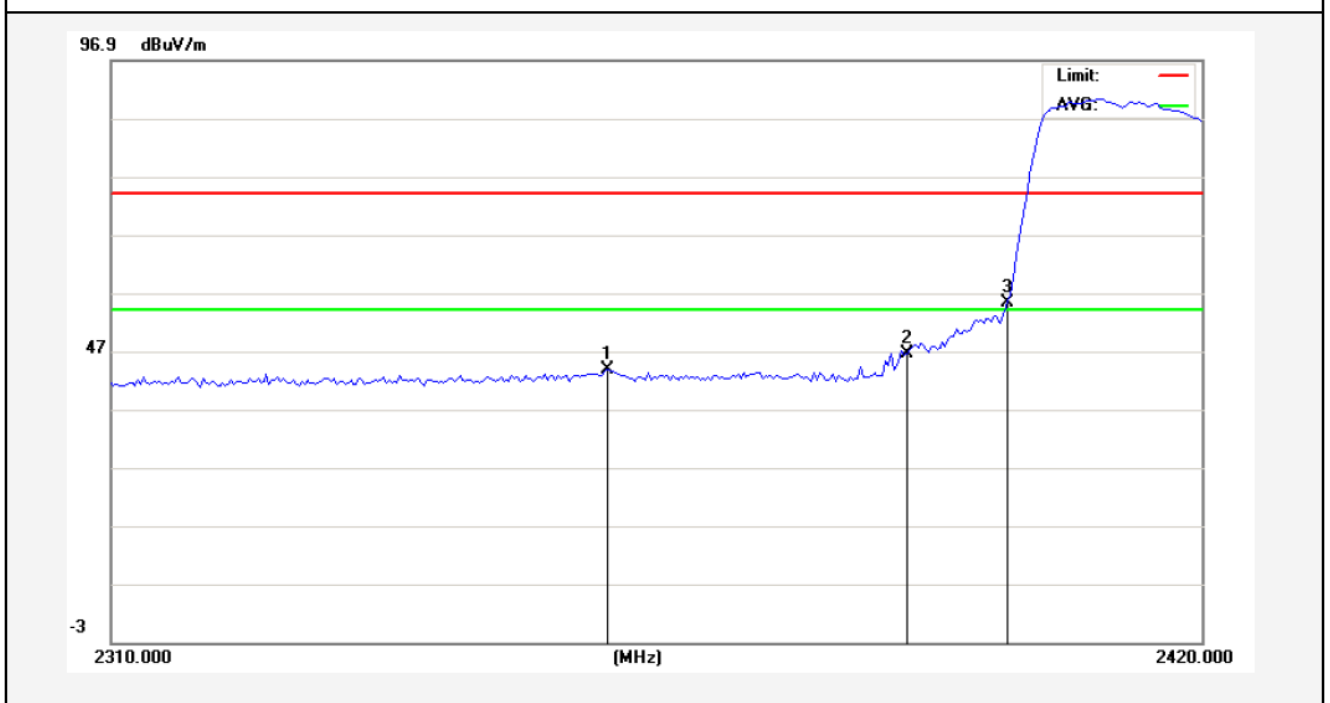

No.	Freq. (MHz)	Reading (dBuV/m)	Factor (dB/m)	Result (dBuV/m)	Limit (dBuV/)	Over Limit (dB)	Detector	Height (cm)	degree (deg)	Remark
1	2359.500	46.33	-2.58	43.75	74.00	-30.25	peak			
2	2390.000	49.16	-2.51	46.65	74.00	-27.35	peak			
3	2400.000	57.89	-2.49	55.40	74.00	-18.60	peak			

AMB

Vertical-AV:

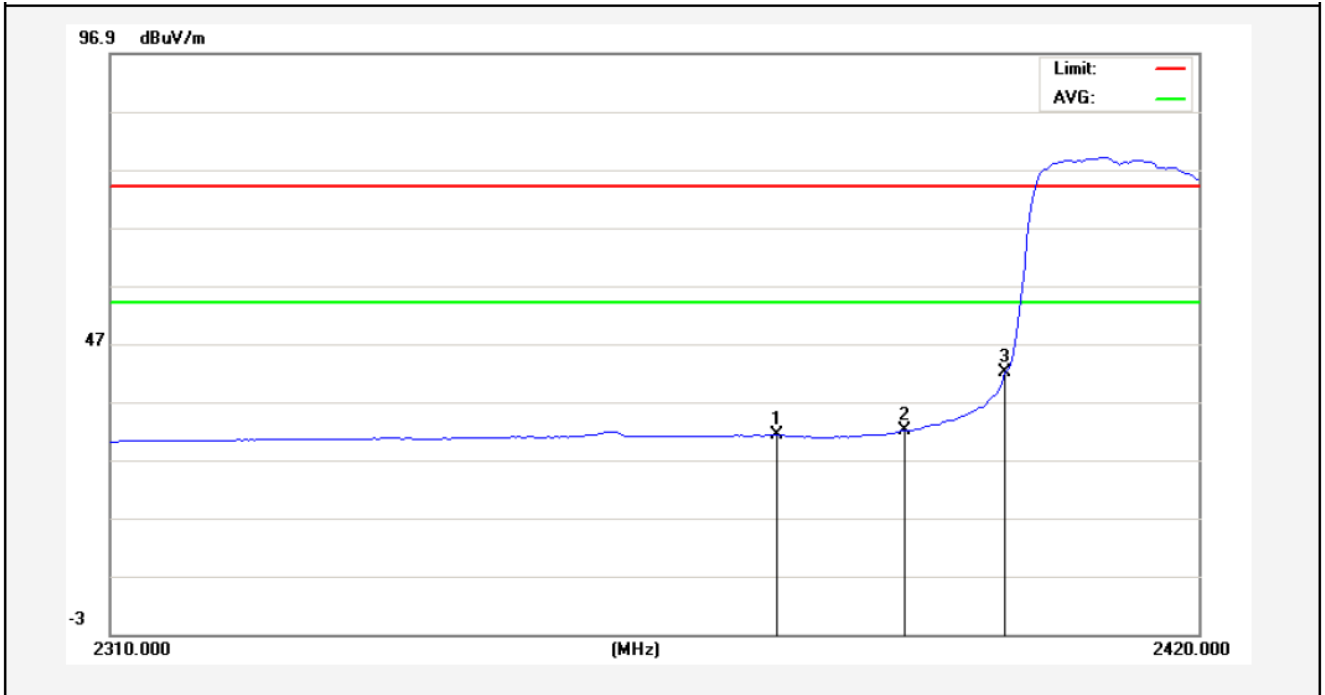

No.	Freq. (MHz)	Reading (dBuV/m)	Factor (dB/m)	Result (dBuV/m)	Limit (dBuV/)	Over Limit (dB)	Detector	Height (cm)	degree (deg)	Remark
1	2376.825	33.73	-2.54	31.19	54.00	-22.81	AVG			
2	2390.000	34.60	-2.51	32.09	54.00	-21.91	AVG			
3	2400.000	44.47	-2.49	41.98	54.00	-12.02	AVG			

Anbotek

Test Mode: 802.11n (HT20)
2462MHz
Horizontal-PEAK:

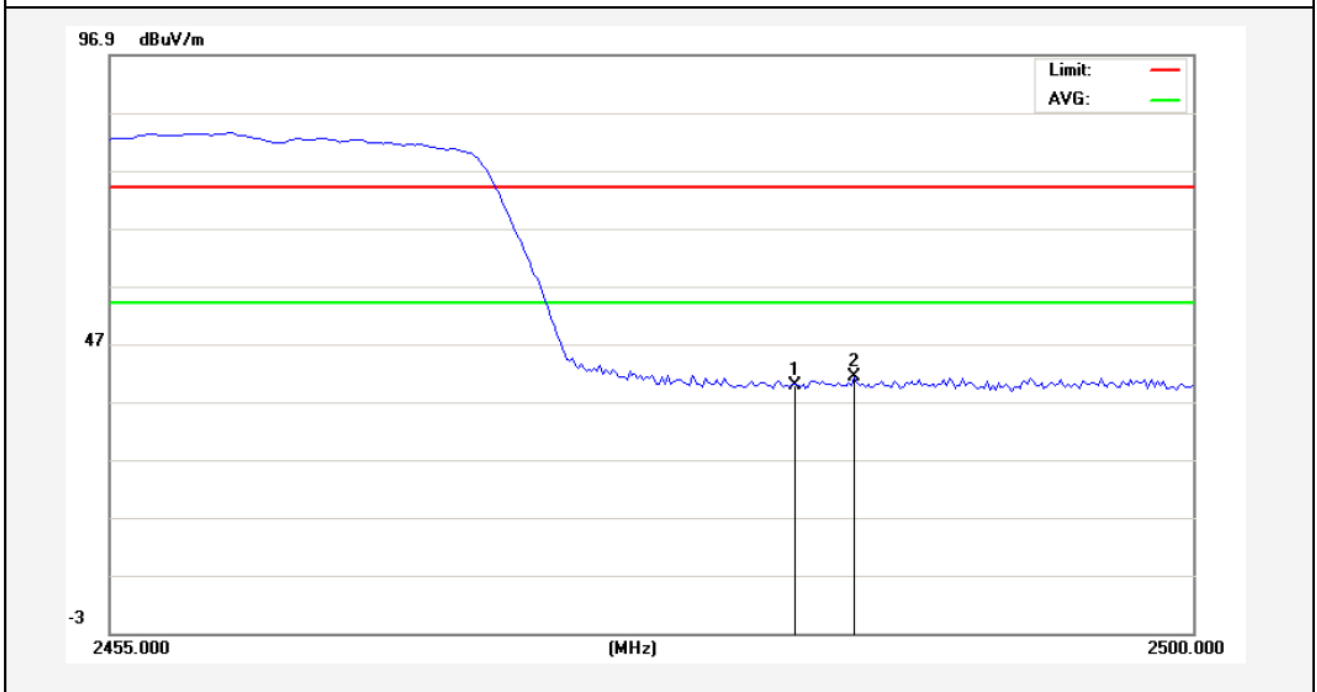

No.	Freq. (MHz)	Reading (dBuV/m)	Factor (dB/m)	Result (dBuV/m)	Limit (dBuV/)	Over Limit (dB)	Detector	Height (cm)	degree (deg)	Remark
1	2483.500	42.19	-2.31	39.88	74.00	-34.12	peak			
2	2485.938	43.54	-2.30	41.24	74.00	-32.76	peak			

Anbotek

Horizontal-AV:

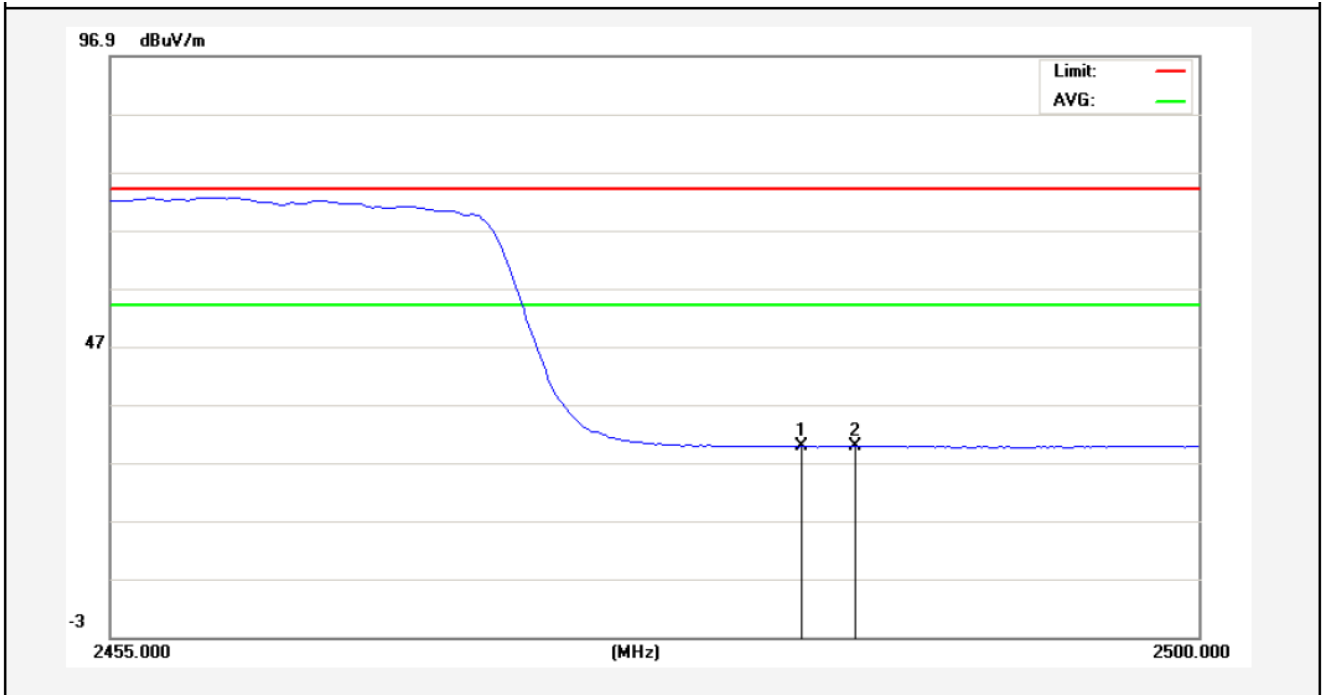

No.	Freq. (MHz)	Reading (dBuV/m)	Factor (dB/m)	Result (dBuV/m)	Limit (dBuV/)	Over Limit (dB)	Detector	Height (cm)	degree (deg)	Remark
1	2483.500	32.03	-2.31	29.72	54.00	-24.28	AVG			
2	2485.825	32.17	-2.30	29.87	54.00	-24.13	AVG			

Anbotek

Test Mode: 802.11n (HT20)
2462MHz
Vertical-PEAK:

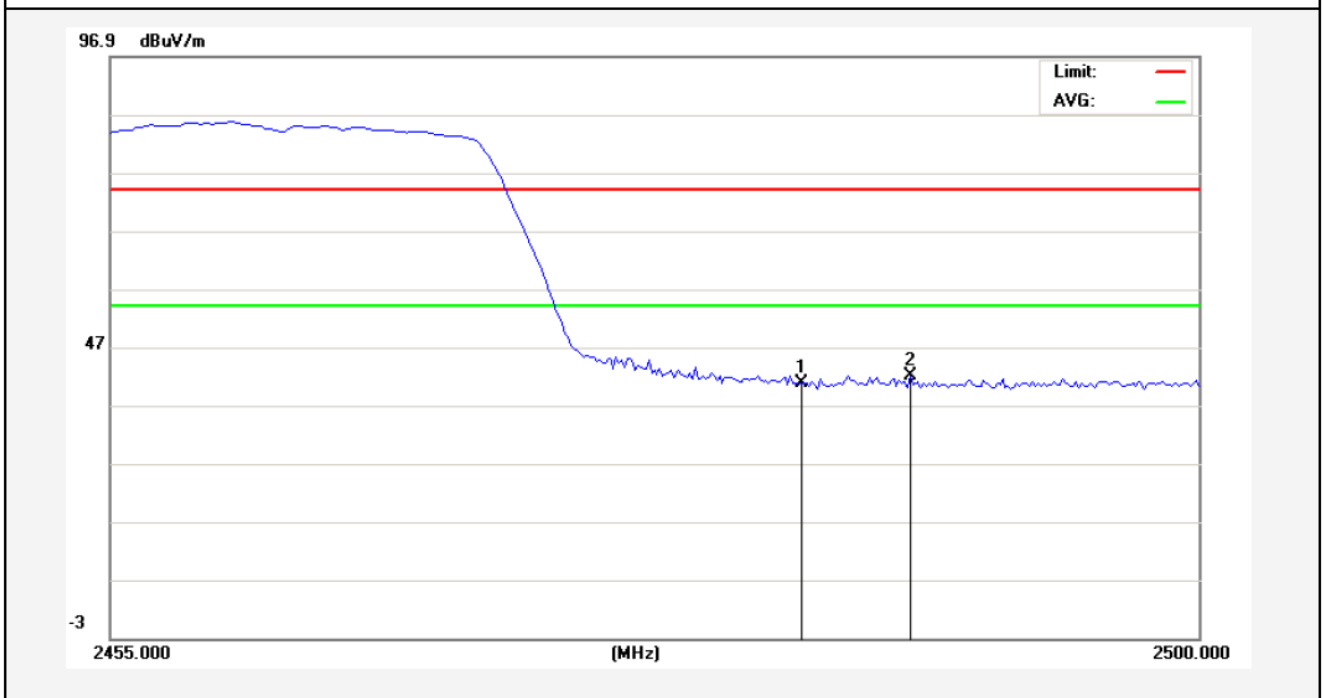

No.	Freq. (MHz)	Reading (dBuV/m)	Factor (dB/m)	Result (dBuV/m)	Limit (dBuV/)	Over Limit (dB)	Detector	Height (cm)	degree (deg)	Remark
1	2483.500	43.13	-2.31	40.82	74.00	-33.18	peak			
2	2488.075	44.28	-2.30	41.98	74.00	-32.02	peak			

Anbotek

Vertical-AV:

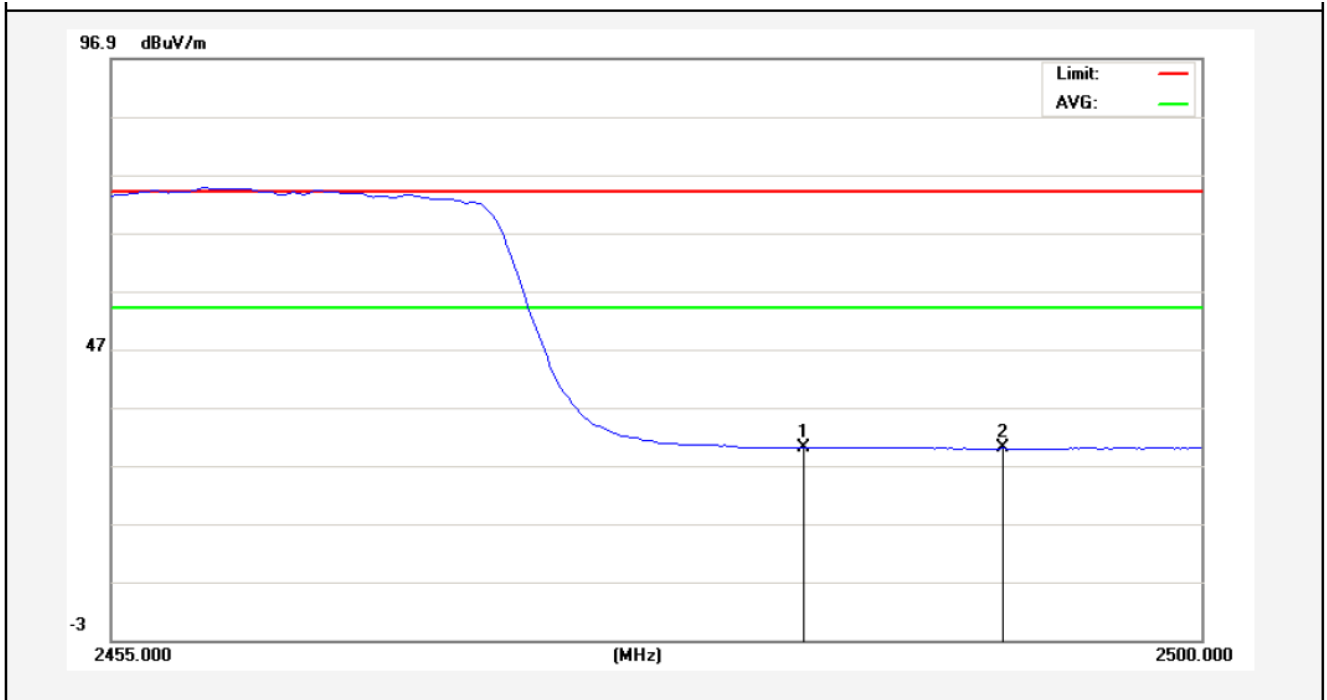

No.	Freq. (MHz)	Reading (dBuV/m)	Factor (dB/m)	Result (dBuV/m)	Limit (dBuV/)	Over Limit (dB)	Detector	Height (cm)	degree (deg)	Remark
1	2483.500	32.42	-2.31	30.11	54.00	-23.89	AVG			
2	2491.787	32.30	-2.29	30.01	54.00	-23.99	AVG			

Anbotek

Test Mode: 802.11n (HT40)
2422MHz
Horizontal-PEAK:

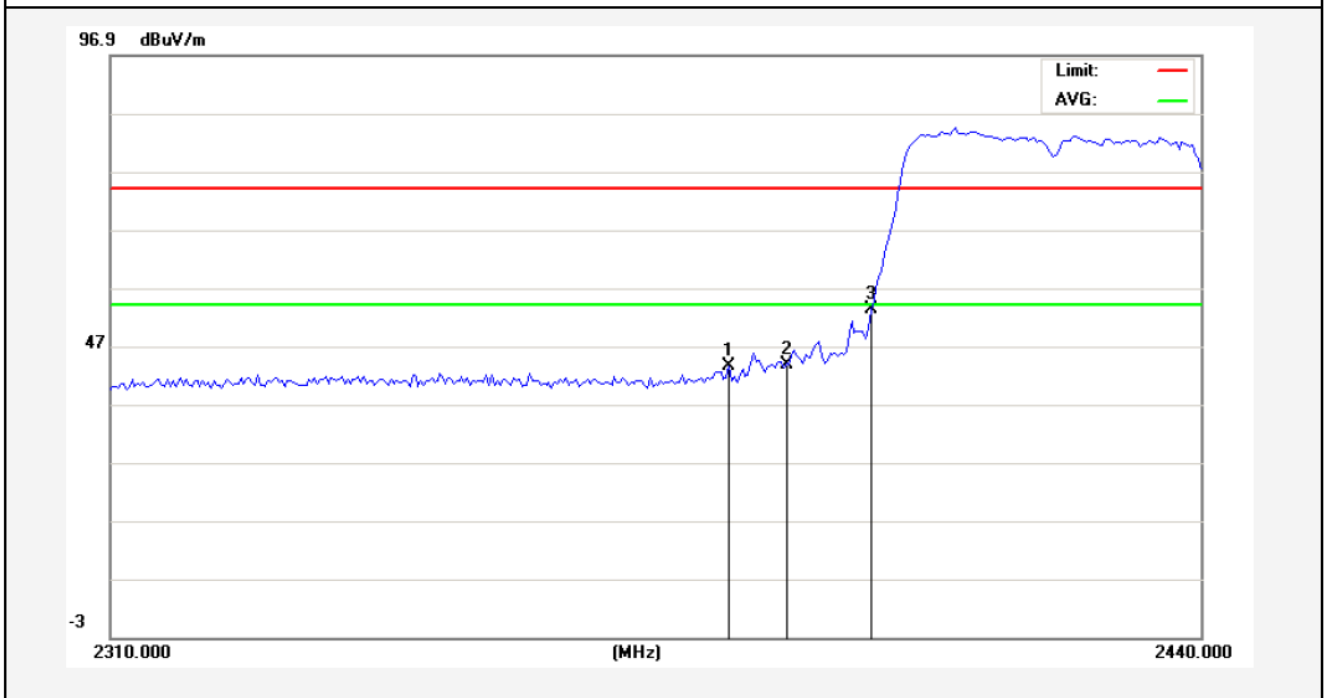

No.	Freq. (MHz)	Reading (dBuV/m)	Factor (dB/m)	Result (dBuV/m)	Limit (dBuV/)	Over Limit (dB)	Detector	Height (cm)	degree (deg)	Remark
1	2383.125	46.16	-2.53	43.63	74.00	-30.37	peak			
2	2390.000	46.40	-2.51	43.89	74.00	-30.11	peak			
3	2400.000	55.73	-2.49	53.24	74.00	-20.76	peak			

AMB

Horizontal-AV:

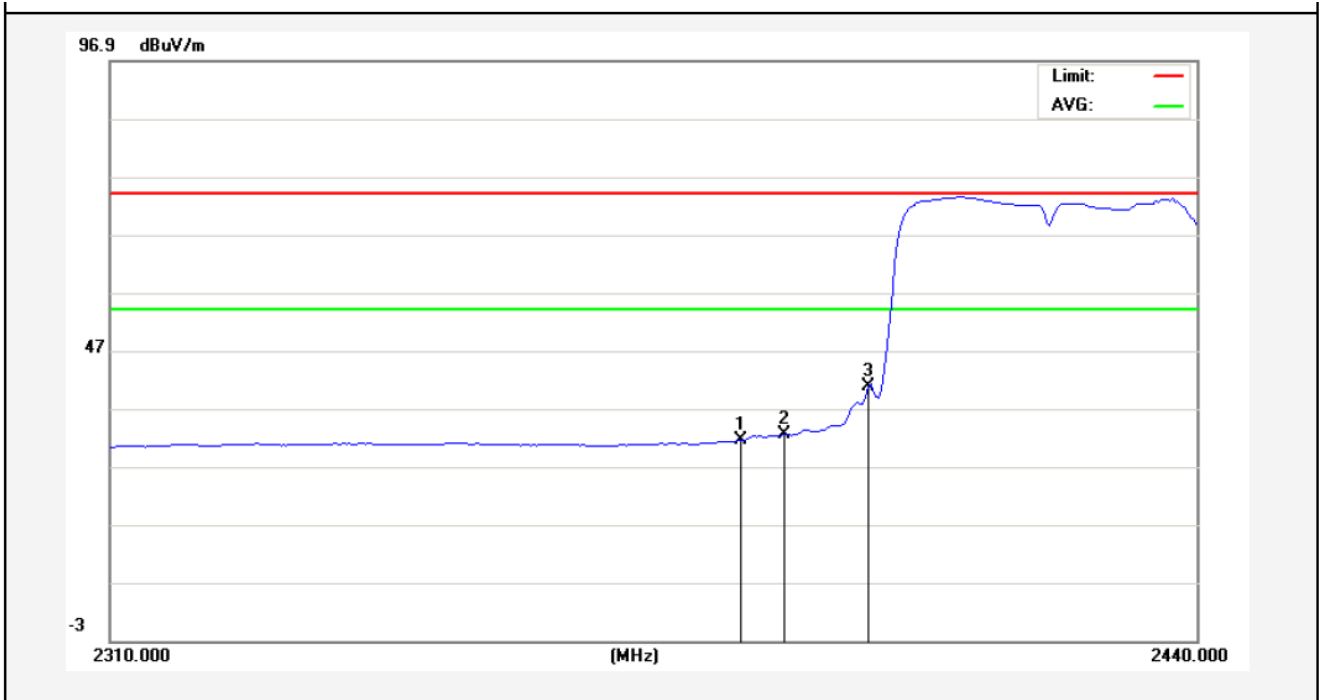

No.	Freq. (MHz)	Reading (dBuV/m)	Factor (dB/m)	Result (dBuV/m)	Limit (dBuV/)	Over Limit (dB)	Detector	Height (cm)	degree (deg)	Remark
1	2384.750	34.10	-2.53	31.57	54.00	-22.43	AVG			
2	2390.000	34.98	-2.51	32.47	54.00	-21.53	AVG			
3	2400.000	43.29	-2.49	40.80	54.00	-13.20	AVG			

Test Mode: 802.11n (HT40)
2422MHz
Vertical-PEAK:

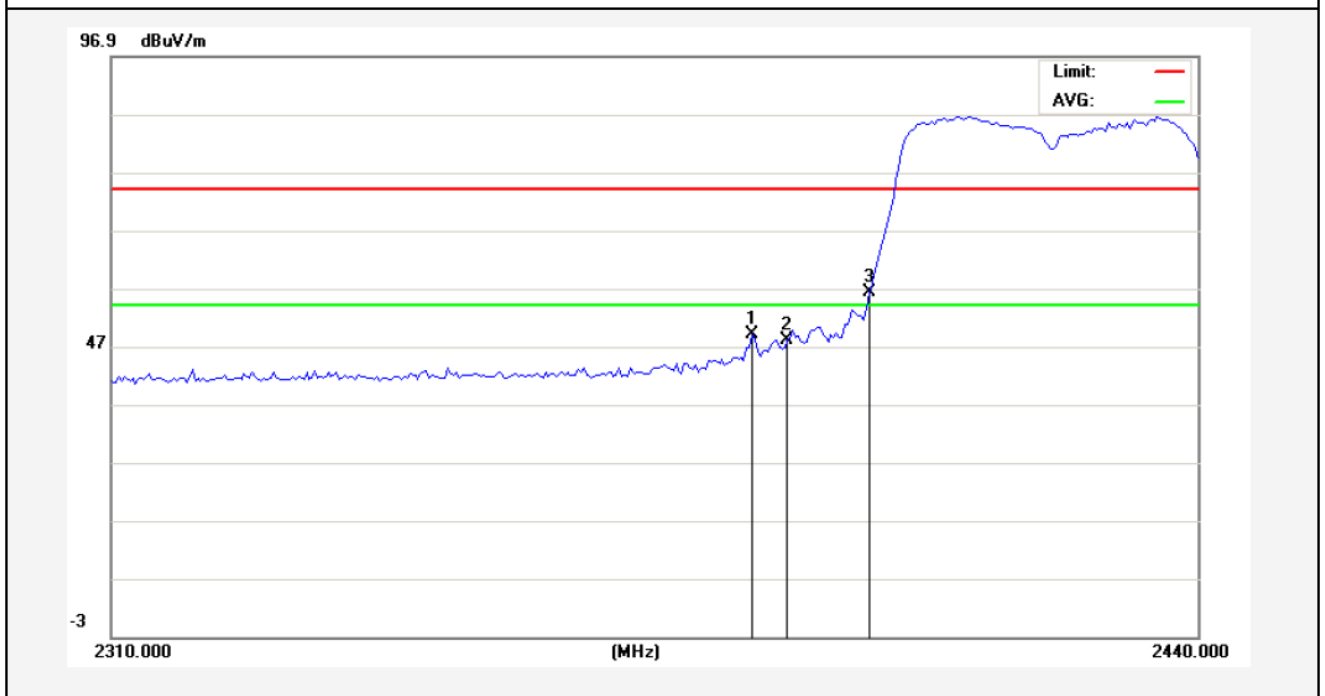

No.	Freq. (MHz)	Reading (dBuV/m)	Factor (dB/m)	Result (dBuV/m)	Limit (dBuV/)	Over Limit (dB)	Detector	Height (cm)	degree (deg)	Remark
1	2386.050	51.50	-2.52	48.98	74.00	-25.02	peak			
2	2390.000	50.63	-2.51	48.12	74.00	-25.88	peak			
3	2400.000	58.87	-2.49	56.38	74.00	-17.62	peak			

Anbotek

Vertical-AV:

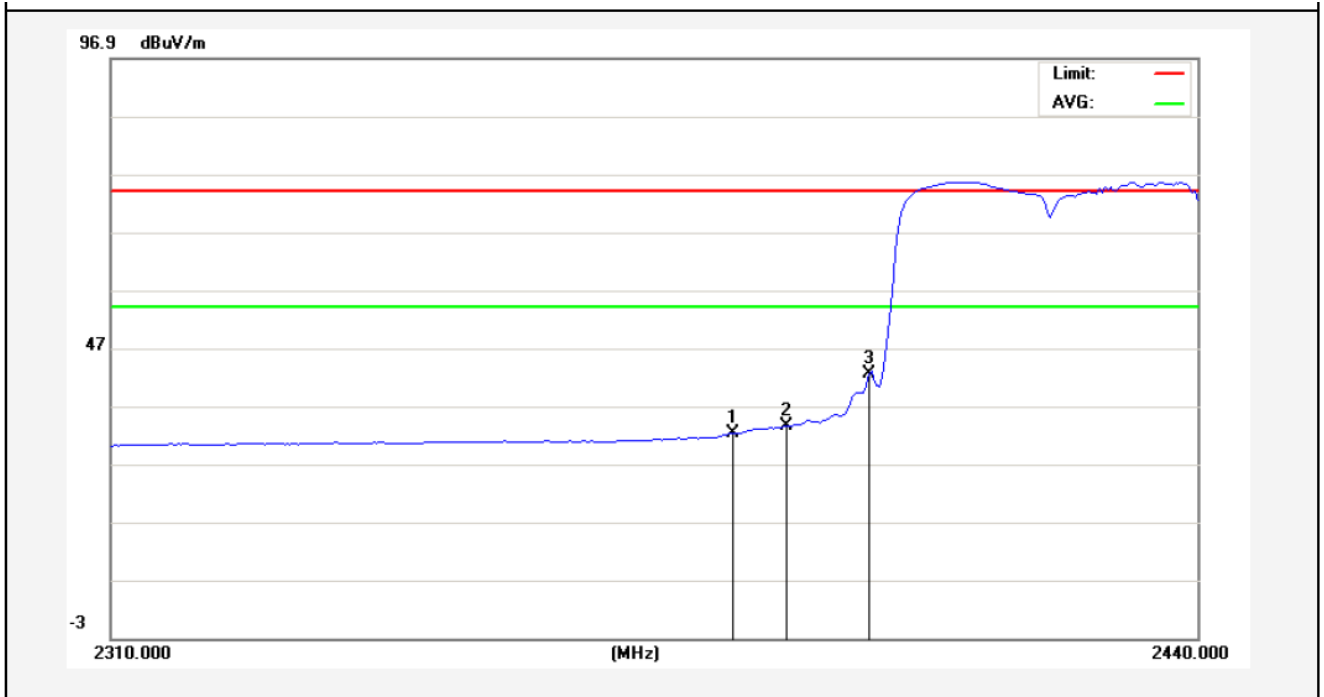

No.	Freq. (MHz)	Reading (dBuV/m)	Factor (dB/m)	Result (dBuV/m)	Limit (dBuV/)	Over Limit (dB)	Detector	Height (cm)	degree (deg)	Remark
1	2383.775	34.84	-2.53	32.31	54.00	-21.69	AVG			
2	2390.000	35.96	-2.51	33.45	54.00	-20.55	AVG			
3	2400.000	44.92	-2.49	42.43	54.00	-11.57	AVG			

Anbotek

Test Mode: 802.11n (HT40)
2452MHz
Horizontal-PEAK:

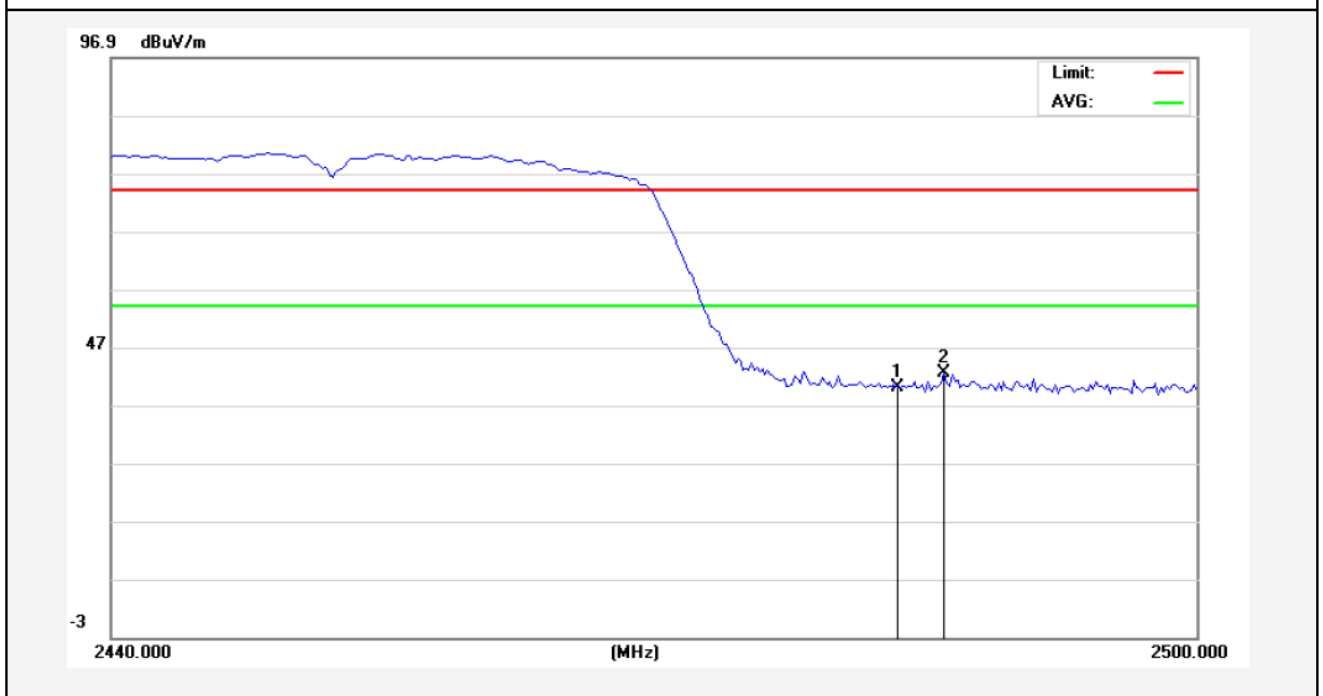

No.	Freq. (MHz)	Reading (dBuV/m)	Factor (dB/m)	Result (dBuV/m)	Limit (dBuV/)	Over Limit (dB)	Detector	Height (cm)	degree (deg)	Remark
1	2483.500	42.30	-2.31	39.99	74.00	-34.01	peak			
2	2486.050	44.90	-2.30	42.60	74.00	-31.40	peak			

Anbotek

Horizontal-AV:

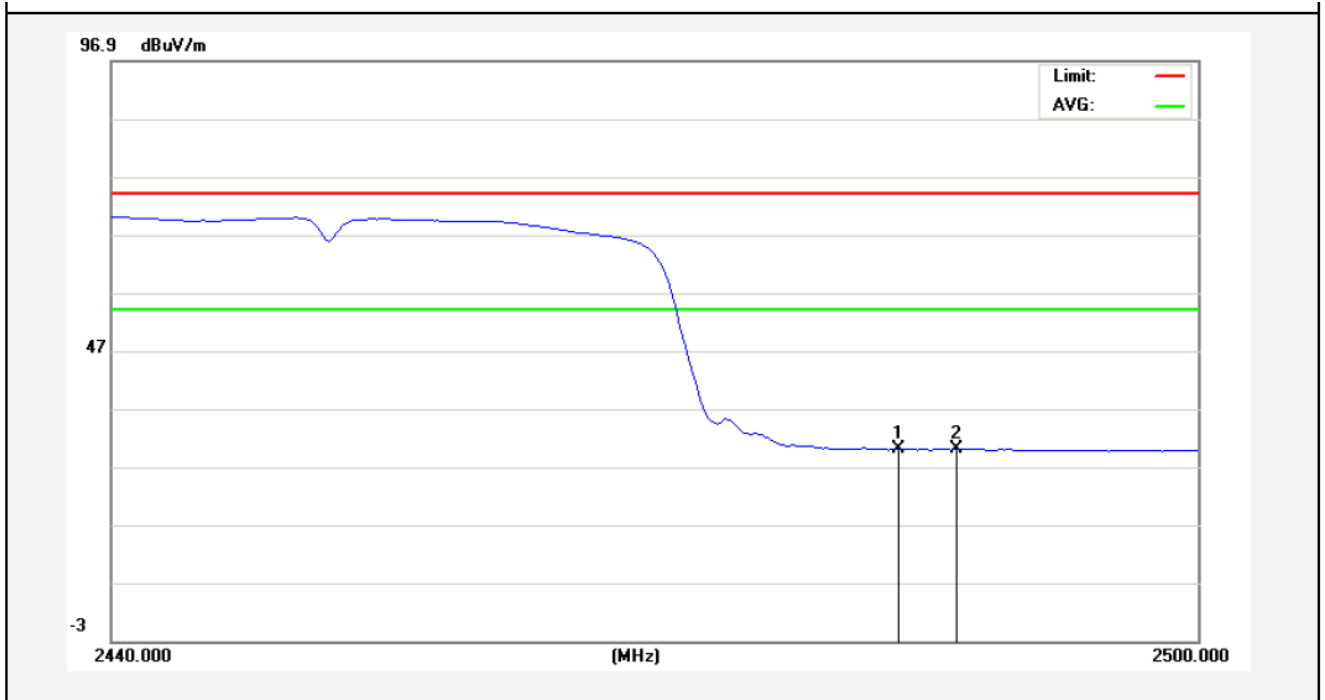

No.	Freq. (MHz)	Reading (dBuV/m)	Factor (dB/m)	Result (dBuV/m)	Limit (dBuV/)	Over Limit (dB)	Detector	Height (cm)	degree (deg)	Remark
1	2483.500	32.22	-2.31	29.91	54.00	-24.09	AVG			
2	2486.650	32.36	-2.30	30.06	54.00	-23.94	AVG			

Anbotek

Test Mode: 802.11n (HT40)
2452MHz
Vertical-PEAK:

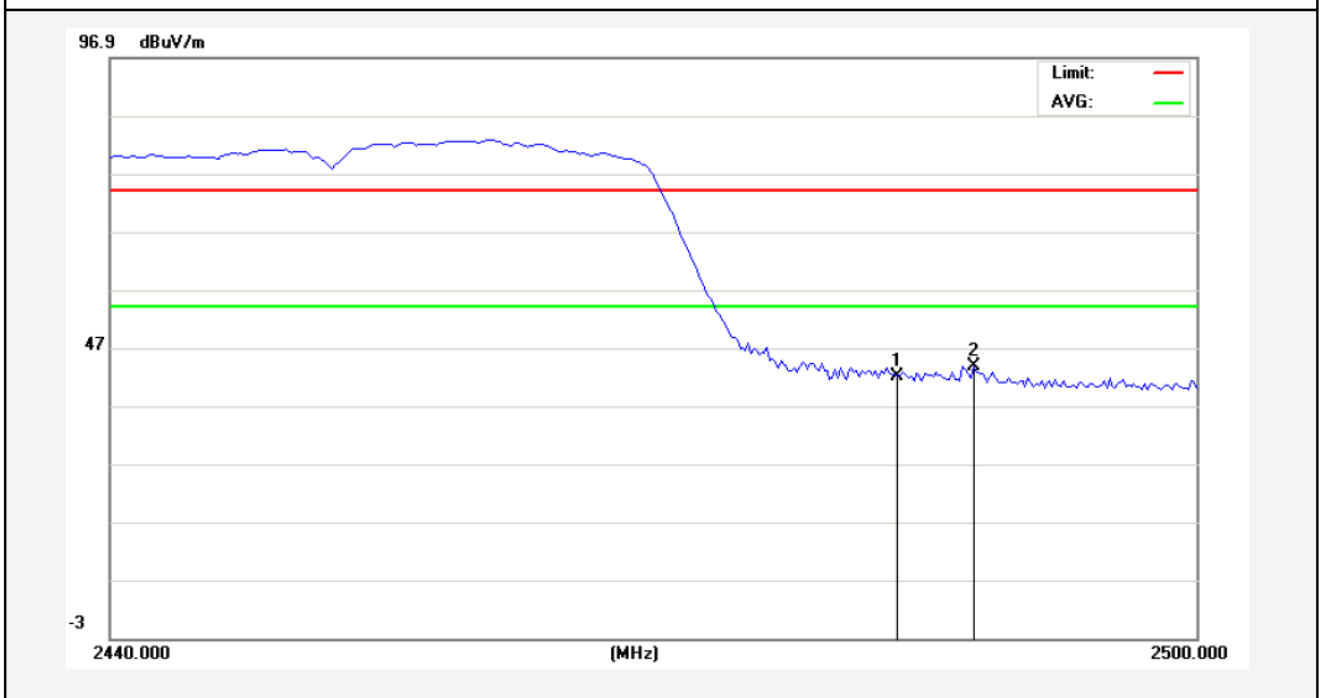

No.	Freq. (MHz)	Reading (dBuV/m)	Factor (dB/m)	Result (dBuV/m)	Limit (dBuV/)	Over Limit (dB)	Detector	Height (cm)	degree (deg)	Remark
1	2483.500	44.37	-2.31	42.06	74.00	-31.94	peak			
2	2487.700	46.08	-2.30	43.78	74.00	-30.22	peak			

Anbotek

Vertical-AV:

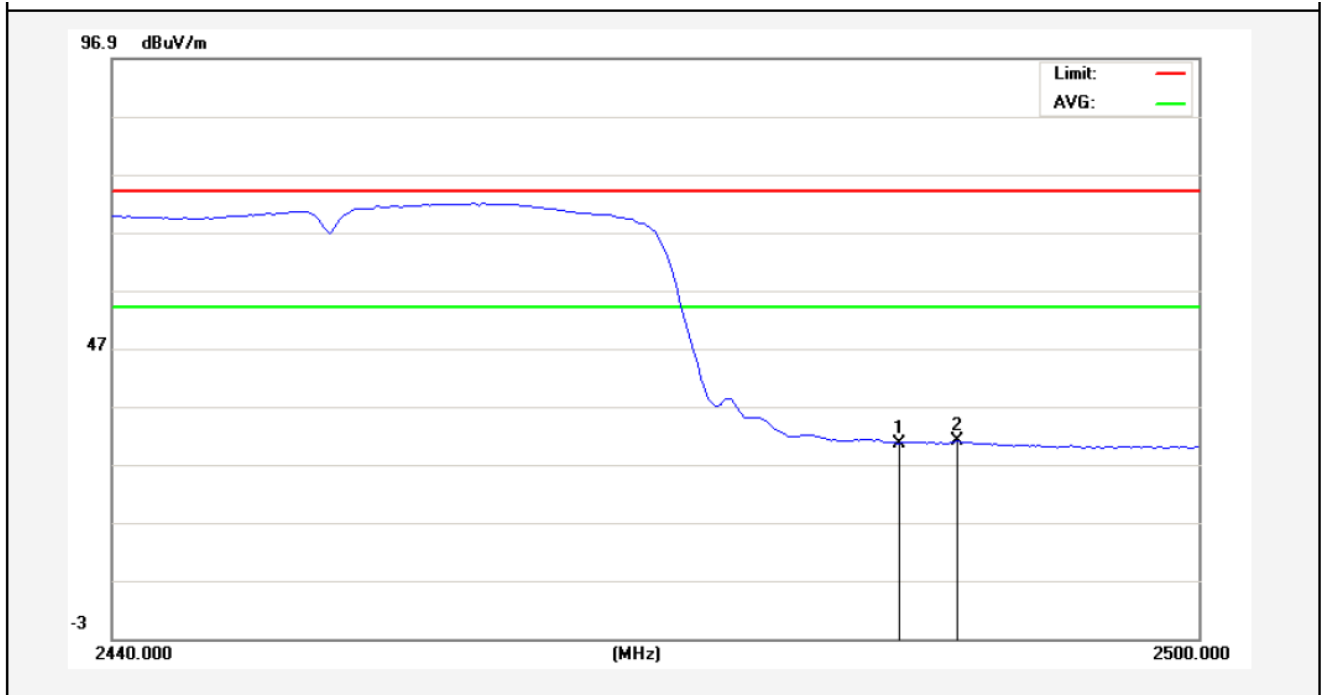

No.	Freq. (MHz)	Reading (dBuV/m)	Factor (dB/m)	Result (dBuV/m)	Limit (dBuV/)	Over Limit (dB)	Detector	Height (cm)	degree (deg)	Remark
1	2483.500	32.84	-2.31	30.53	54.00	-23.47	AVG			
2	2486.650	33.21	-2.30	30.91	54.00	-23.09	AVG			

Anbotek

4.5. Peak Power Spectral Density

a. Limit

1. For direct sequence systems, the peak power spectral density conducted from the intentional radiator to the antenna shall not be greater than 8dBm in any 3kHz band during any time interval of continuous transmission.
2. The direct sequence operating of the hybrid system, with the frequency hopping operation turned off, shall comply with the power density requirements of paragraph (d) of this section.

b. Test Procedure

1. Place the EUT on the table and set it in transmitting mode. Remove the antenna from the EUT and then connect a low loss RF cable from the antenna port to the spectrum analyzer.
2. Set the spectrum analyzer as RBW = 3kHz, VBW = 10kHz, Span = 1.5MHz, Sweep=500s
3. Record the max. reading.
4. Repeat the above procedure until the measurements for all frequencies are completed.

c. Test Equipment

Same as the equipment listed in 4.2.

d. Test Setup

See 4.1

e. Test Results

Pass

f. Test Data

Please refer to the following data.

g. Test Plot

 See the following pages

Test mode: IEEE 802.11b

Channel	Frequency (MHz)	PPSD (dBm/3KHz)	ΣPPSD (dBm/3KHz)	Limit (dBm)	Result
Low	2412	-16.97	-	8.00	Pass
Mid	2437	-17.48	-		Pass
High	2462	-18.03	-		Pass

Test mode: IEEE 802.11g

Channel	Frequency (MHz)	PPSD (dBm)	ΣPPSD (dBm)	Limit (dBm)	Result
Low	2412	-12.69	-	8.00	Pass
Mid	2437	-12.75	-		Pass
High	2462	-13.39	-		Pass

Test mode: IEEE 802.11n (HT20)

Channel	Frequency (MHz)	PPSD (dBm/3KHz)	ΣPPSD (dBm/3KHz)	Limit (dBm)	Result
Low	2412	-12.76	-	8.00	Pass
Mid	2437	-12.86	-		Pass
High	2462	-13.18	-		Pass

Test mode: IEEE 802.11n (HT40)

Channel	Frequency (MHz)	PPSD (dBm/3KHz)	ΣPPSD (dBm/3KHz)	Limit (dBm)	Result
Low	2422	-14.28	-	8.00	Pass
Mid	2437	-13.89	-		Pass
High	2452	-15.50	-		Pass

802.11 b CH--Low



*RBW 3 kHz Marker 1 [T1]
*VBW 10 kHz -16.97 dBm
SWT 2.05 s 2.411268000 GHz

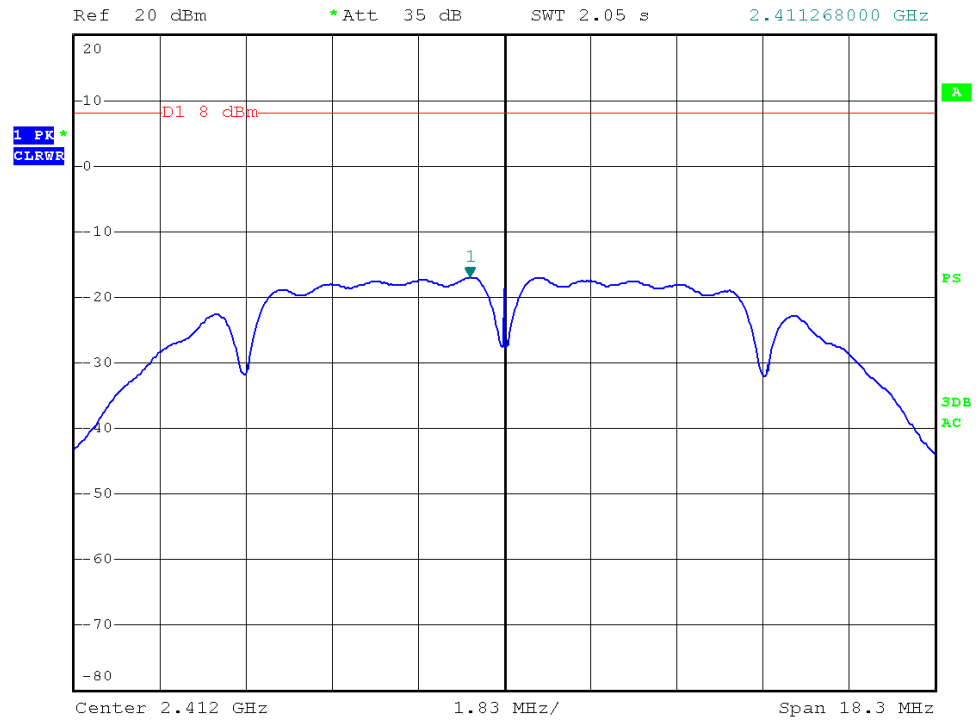

802.11 b CH--Mid



*RBW 3 kHz Marker 1 [T1]
*VBW 10 kHz -17.48 dBm
SWT 2.05 s 2.436304600 GHz

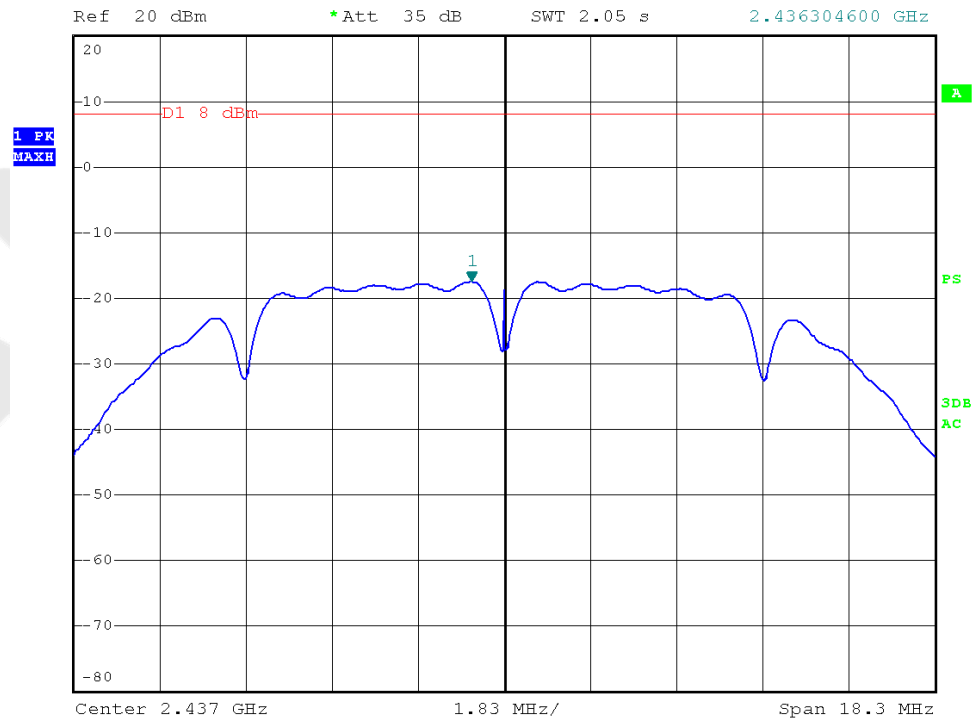

802.11 b CH--High

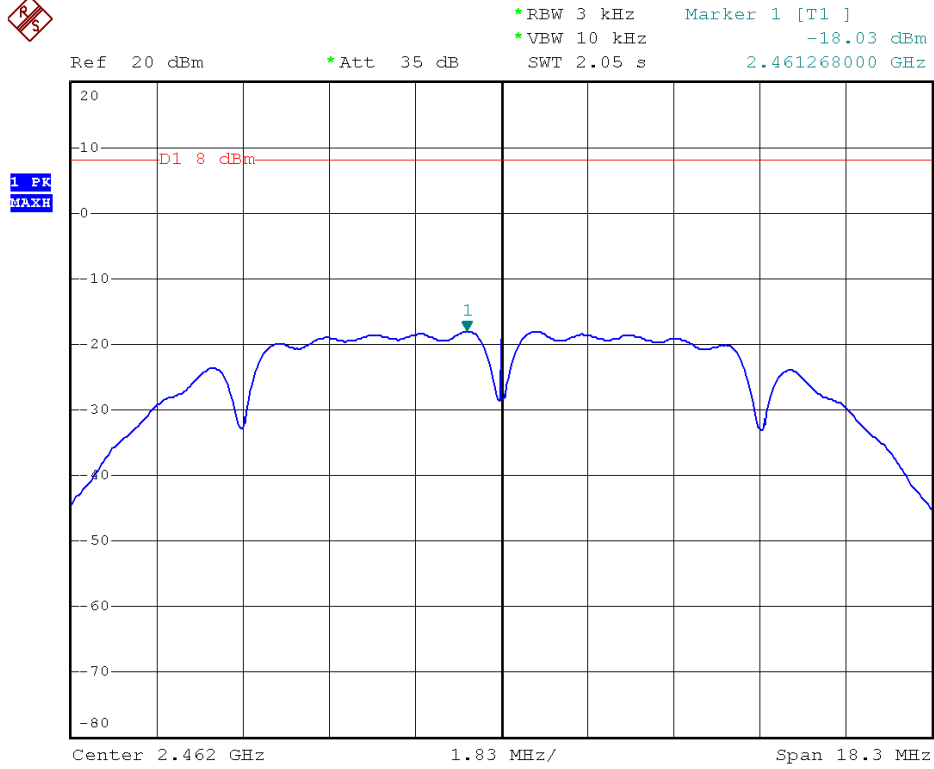

802.11g CH--Low

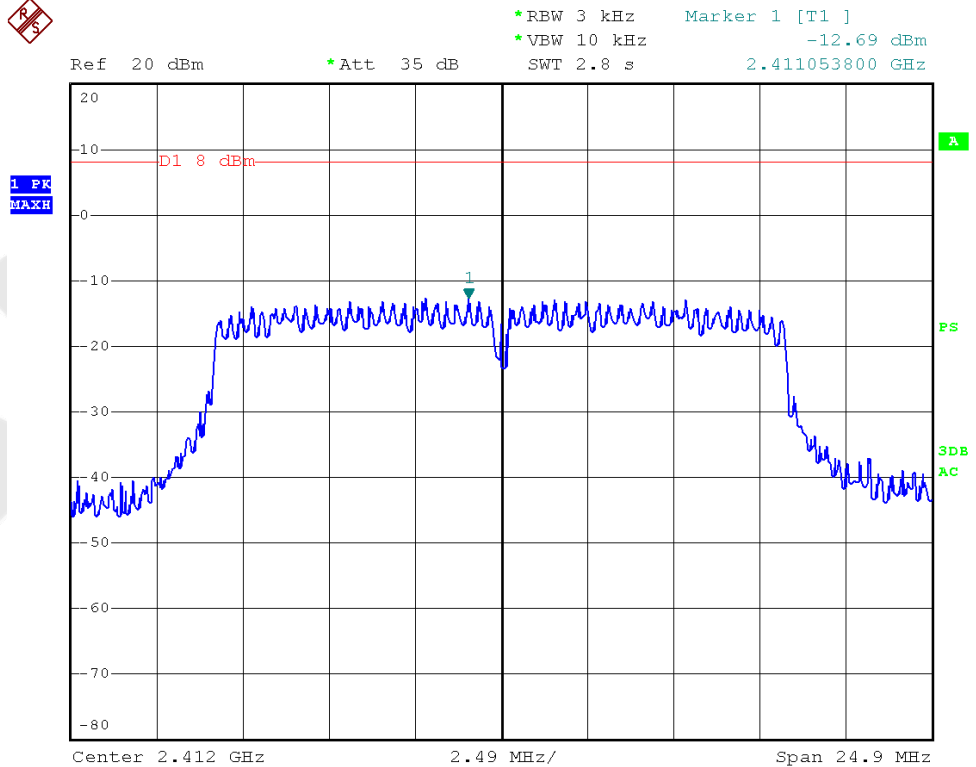

802.11g CH--Mid



*RBW 3 kHz Marker 1 [T1]
*VBW 10 kHz -12.75 dBm
SWT 2.8 s 2.436053800 GHz

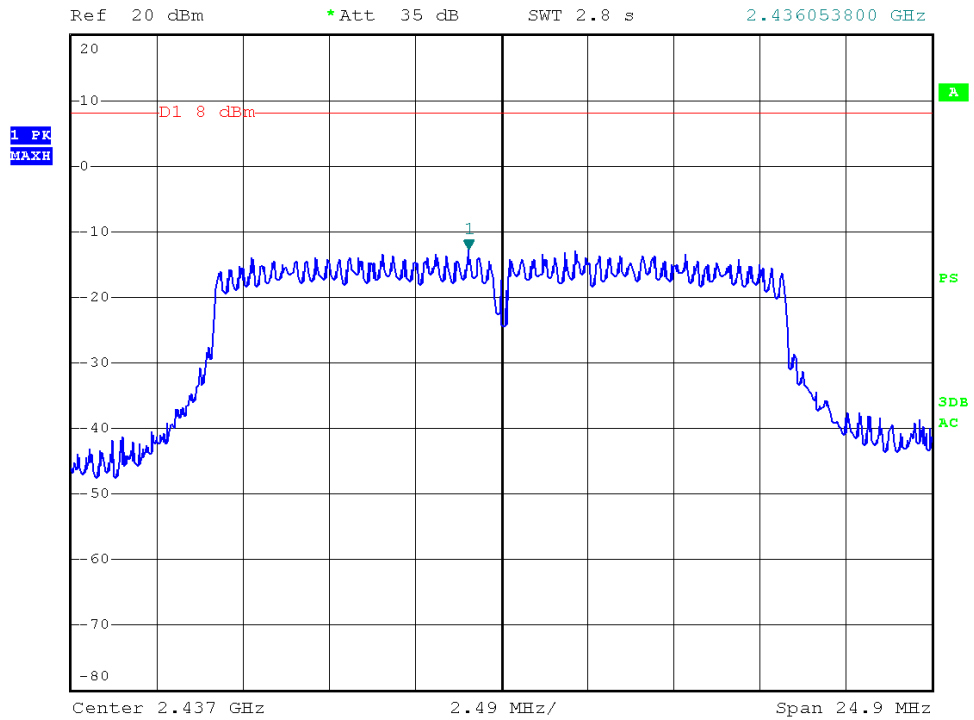

802.11g CH--High



*RBW 3 kHz Marker 1 [T1]
*VBW 10 kHz -13.39 dBm
SWT 2.8 s 2.461053800 GHz

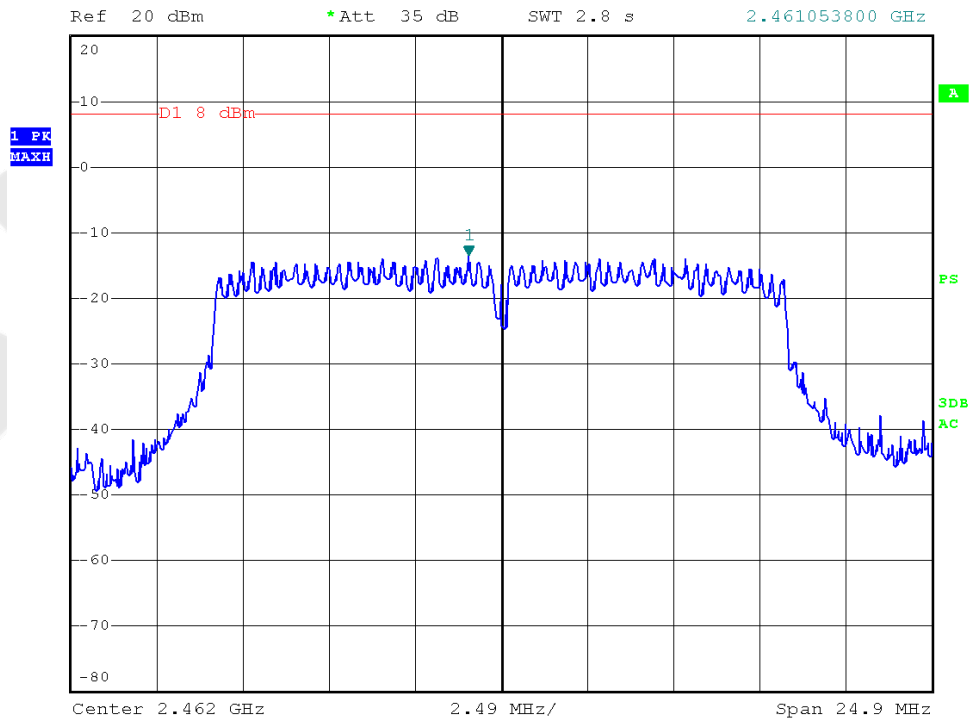

802.11n (HT20) CH—Low

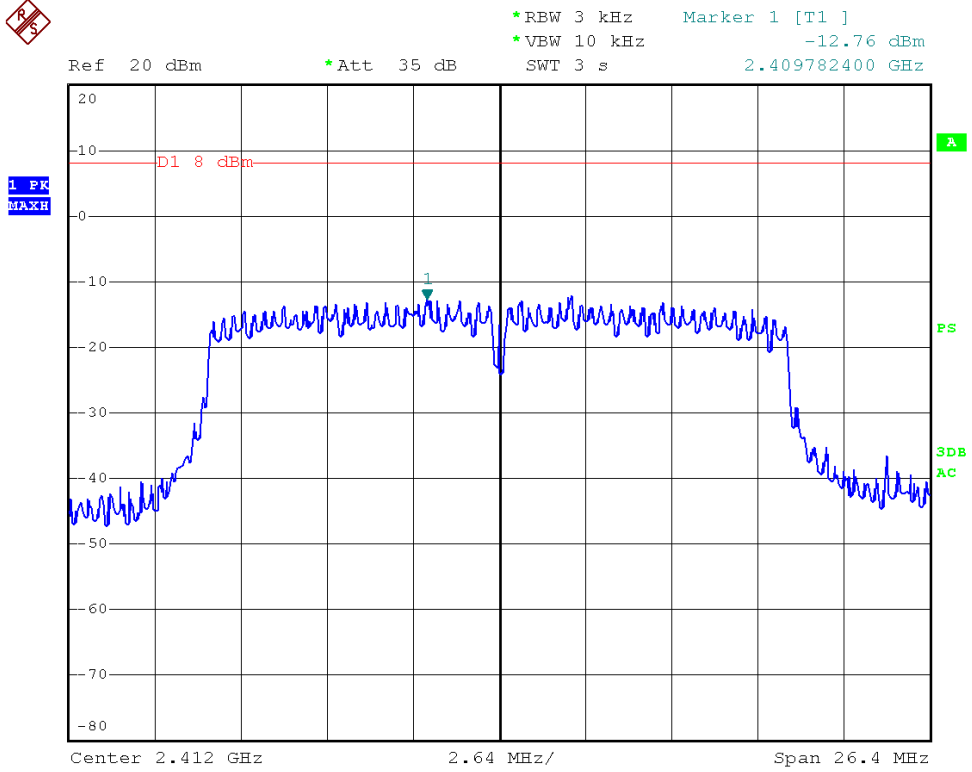

802.11n (HT20) CH—Mid

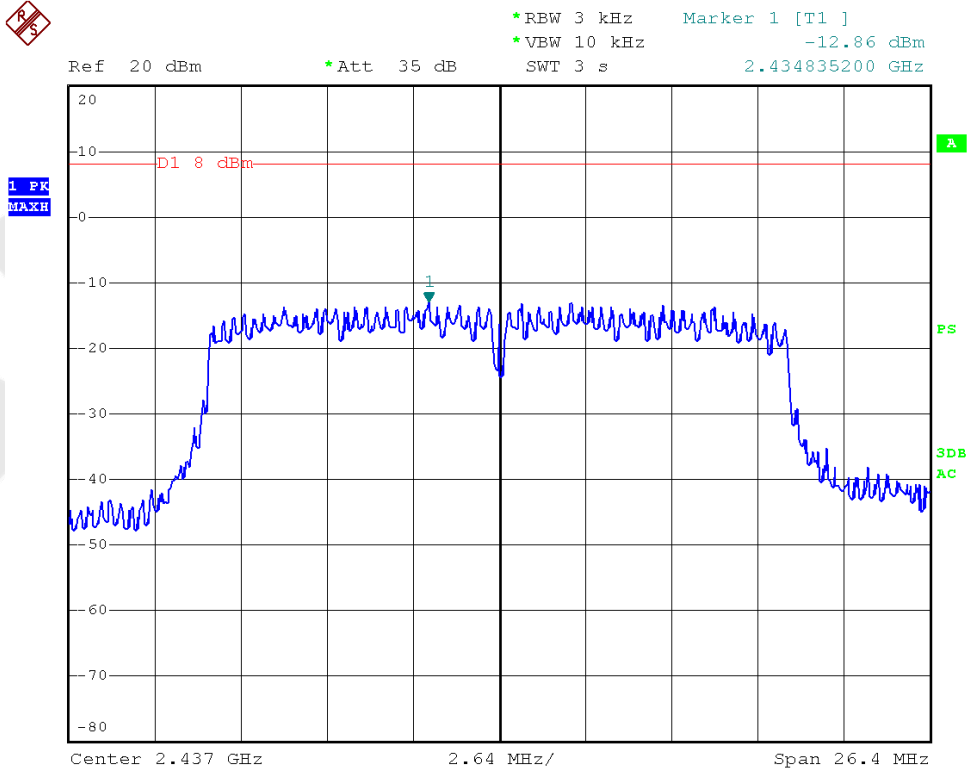

802.11n (HT20) CH—High

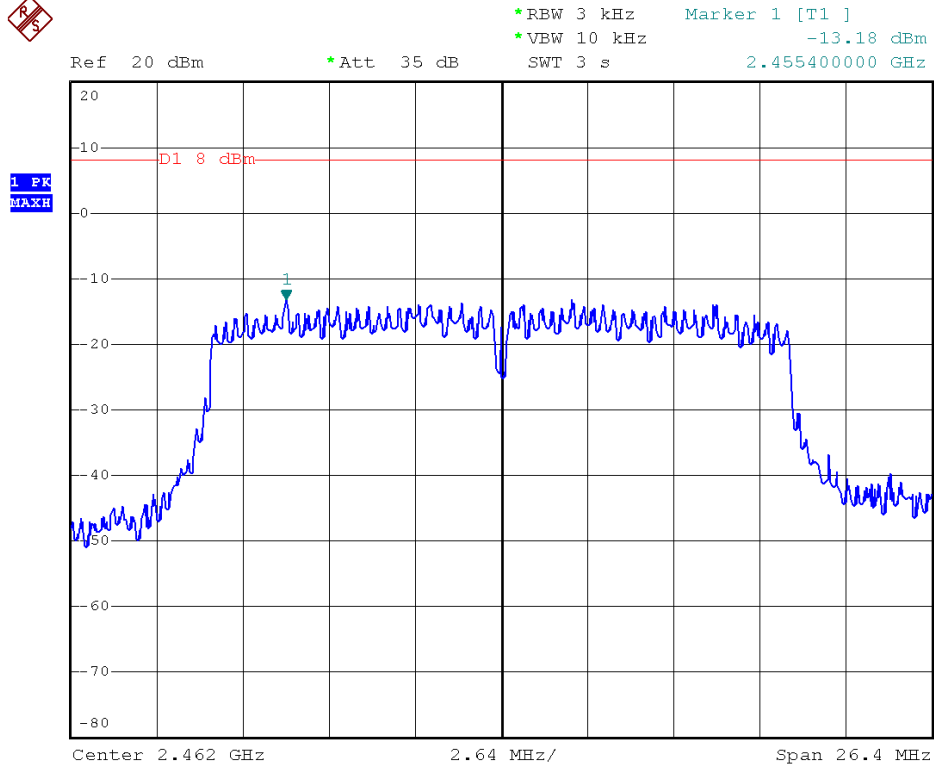

802.11n (HT40) CH—Low

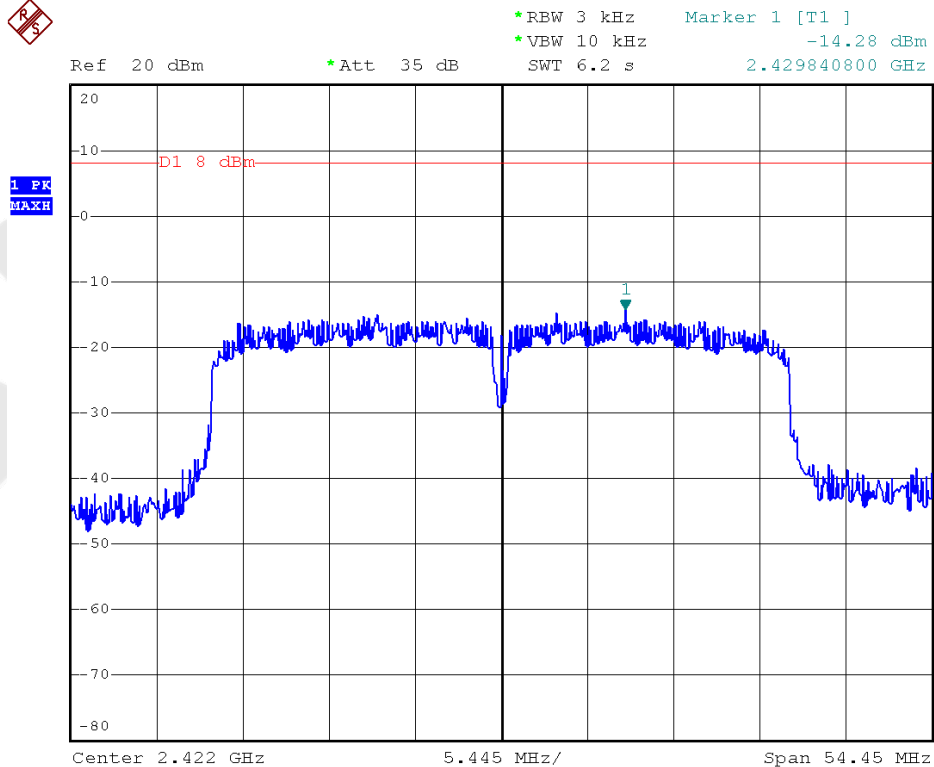

802.11n (HT40) CH—Mid

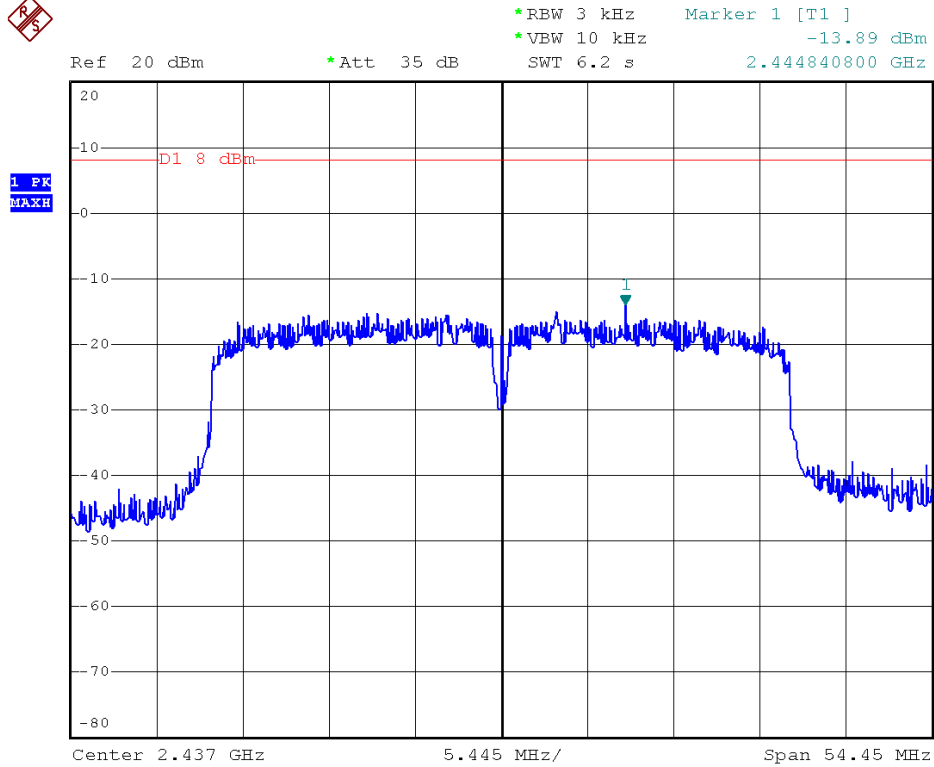

802.11n (HT40) CH—High

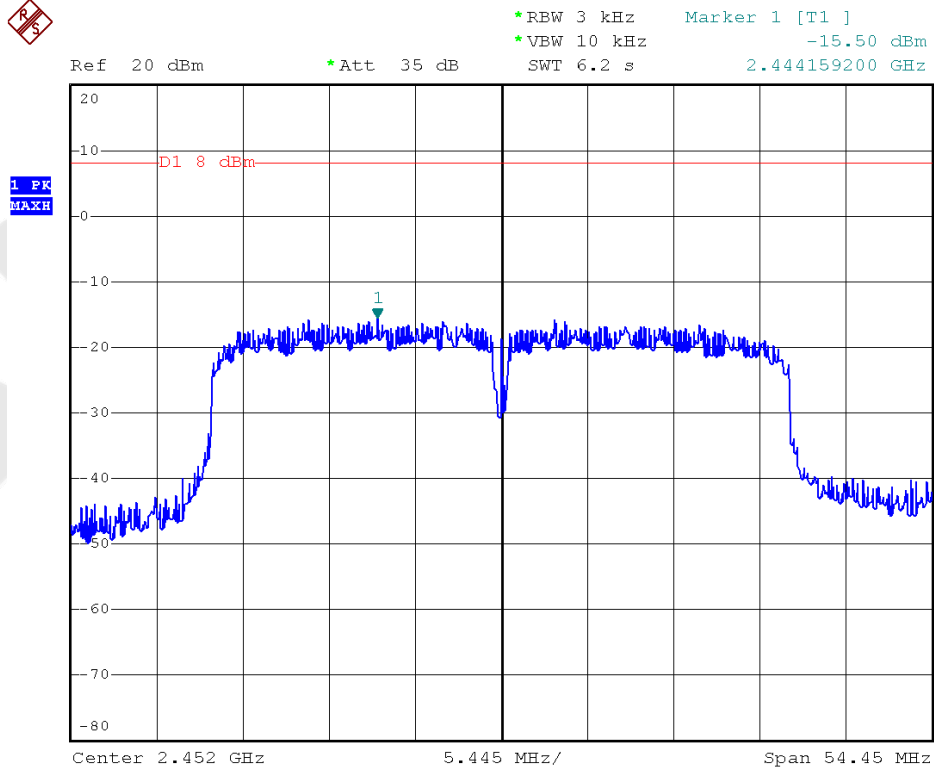

4.6. Radiated Emissions

4.6.1.1. Test Limits (< 30 MHz)

Frequency (MHz)	Field Strength (microvolts/meter)	Measurement Distance (meter)
0.009-0.490	2400/F(kHz)	300
0.490-1.705	24000/F(kHz)	30
1.705-30.0	30	30

4.6.1.2. Test Limits (≥ 30 MHz)

FIELD STRENGTH of Fundamental: @3M	FIELD STRENGTH of Harmonics	S15.209	
902-928 MHz		30 - 88 MHz	40 dBuV/m
2.4-2.4835 GHz		88 - 216 MHz	43.5
94 dBμV/m @3m	54 dBμV/m @3m	216 - 960 MHz	46
		ABOVE 960 MHz	54dBuV/m

In any 100 kHz bandwidth outside the frequency band in which the spread spectrum or digitally modulated intentional radiator is operating, the radio frequency power that is produced by the intentional radiator shall be at least 20 dB below that in the 100 kHz bandwidth within the band that contains the highest level of the desired power, based on either an RF conducted or a radiated measurement. Attenuation below the general limits specified in Section 15.209(a) is not required. In addition, radiated emissions which fall in the restricted bands, as defined in Section 15.205(a), must also comply with the radiated emission limits specified in Section 15.209(a) (see Section 15.205(c)).

Test Equipment

Item	Equipment	Manufacturer	Model No.	Serial No.	Last Cal.	Cal. Interval
1.	Preamplifier	Instruments corporation	EMC011830	980100	Aug. 09, 2014	1 Year
2.	EMI Test Receiver	Rohde & Schwarz	ESPI	101604	Apr. 23, 2014	1 Year
3.	Double Ridged Horn Antenna	Instruments corporation	GTH-0118	351600	Aug. 09, 2013	3 Year
4.	Bilog Broadband Antenna	Schwarzbeck	VULB9163	VULB 9163-289	Apr. 23, 2013	3 Year
5.	Pre-amplifier	SONOMA	310N	186860	Apr. 23, 2014	1 Year
6.	EMI Test Software EZ-EMC	SHURPLE	N/A	N/A	N/A	N/A

4.6.2. Test Configuration:

4.6.2.1. 9k to 30MHz emissions:

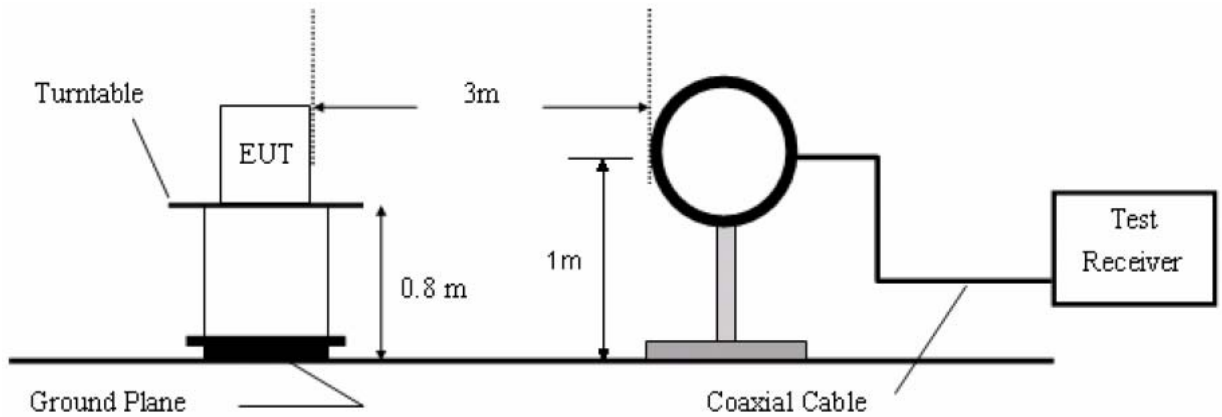

4.6.2.2. 30M to 1G emissions:

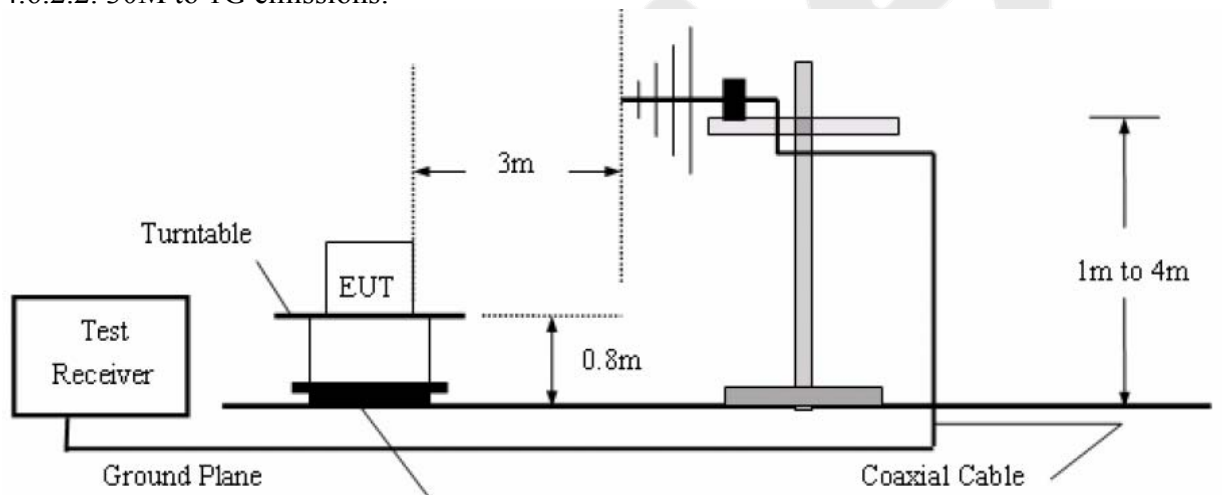

4.6.2.3. 1G to 40G emissions:

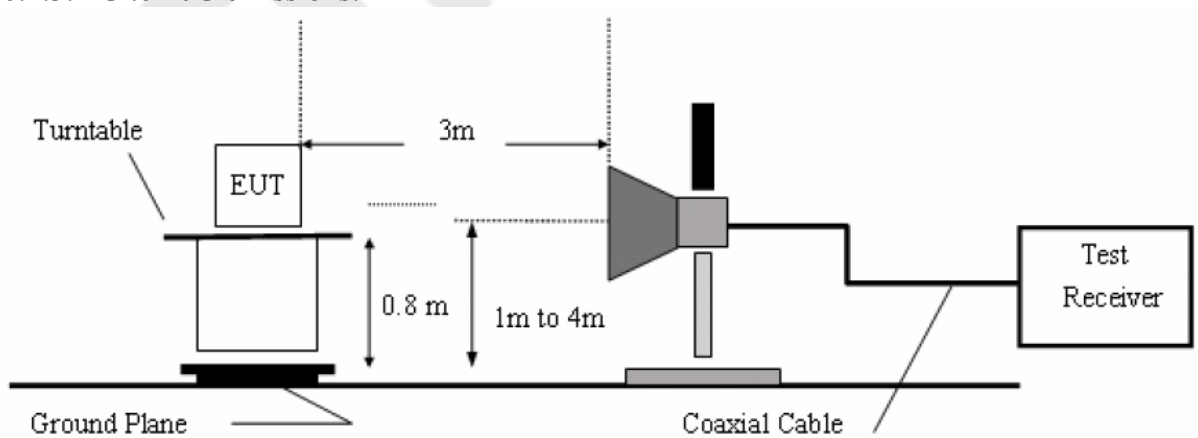

4.6.3. Test Procedure

The EUT is placed on a turn table which is 0.8 meter high above the ground. The turn table can rotate 360 degrees to determine the position of the maximum emission level. The EUT is set 3 meters away from the receiving antenna which is mounted on a antenna tower. The antenna can be moved up and down from 1 to 4 meters to find out the maximum emission level. Both horizontal and vertical polarization of the antenna are set on test.

Measurements are made on 9KHz to 30MHz and 30MHz to 26GHz range with the transmitter set to the lowest, middle, and highest channels.

All readings from 30MHz to 1GHz are quasi-peak values with a resolution bandwidth of 120kHz. All reading are above 1GHz, peak & average values with a resolution bandwidth of 1MHz.

The EUT is tested in 9*6*6 Chamber.

The test results are listed in Section 4.6.4.

4.6.4. Test Results

Please refer to the following pages.

Job No.:	011408277E	Polarization:	Horizontal
Standard:	(RE)FCC PART15 C _3m	Power Source:	AC 120V, 60Hz
Test item:	Radiation Test	Temp.(C)/Hum.(%RH):	24.3(C)/55%RH
Test Mode:	On	Distance:	3m

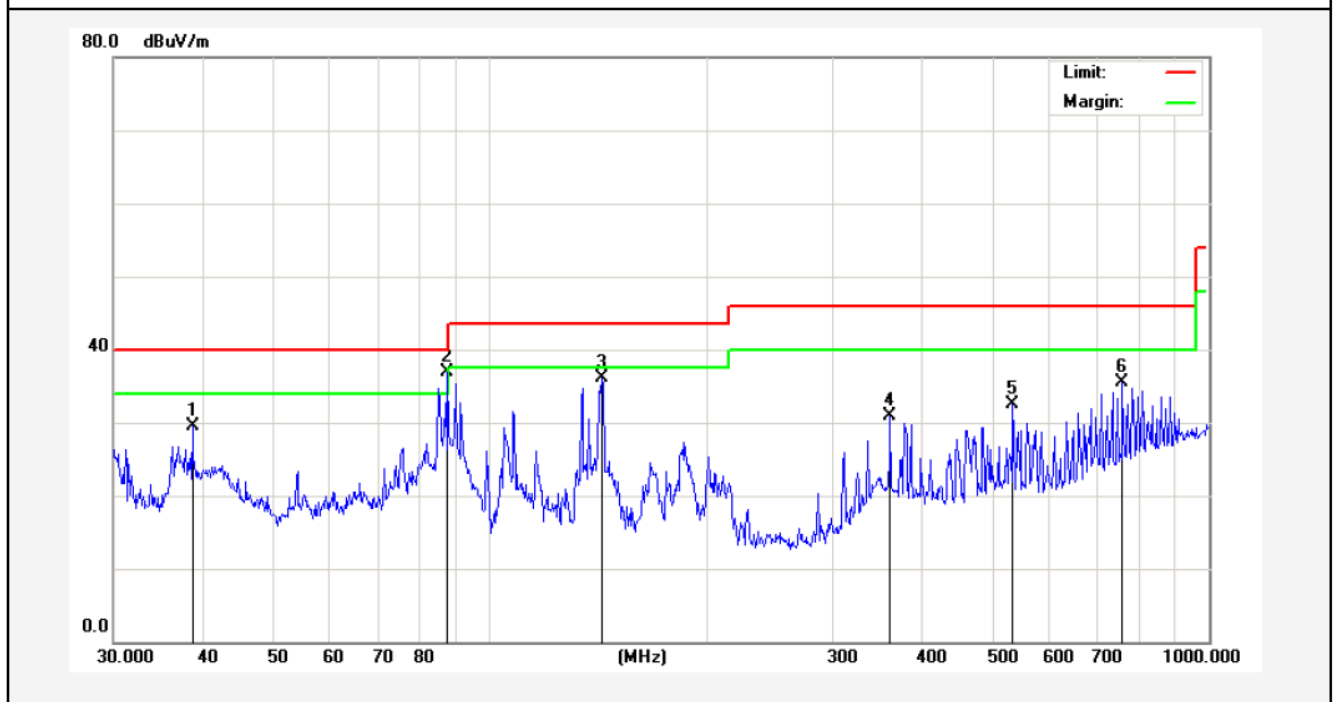

No.	Freq. (MHz)	Reading (dBuV/m)	Factor (dB/m)	Result (dBuV/m)	Limit (dBuV/)	Over Limit (dB)	Detector	Height (cm)	degree (deg)	Remark
1	38.6160	40.88	-11.45	29.43	40.00	-10.57	peak			
2	87.4177	58.51	-21.57	36.94	40.00	-3.06	peak			
3	143.3261	59.49	-23.44	36.05	43.50	-7.45	peak			
4	360.4476	44.60	-13.65	30.95	46.00	-15.05	peak			
5	533.8321	43.56	-11.05	32.51	46.00	-13.49	peak			
6	758.0408	42.76	-7.35	35.41	46.00	-10.59	peak			

Job No.:	011408277E	Polarization:	Vertical
Standard:	(RE)FCC PART15 C_3m	Power Source:	AC 120V, 60Hz
Test item:	Radiation Test	Temp.(C)/Hum.(%RH):	24.3(C)/55%RH
Test Mode:	On	Distance:	3m

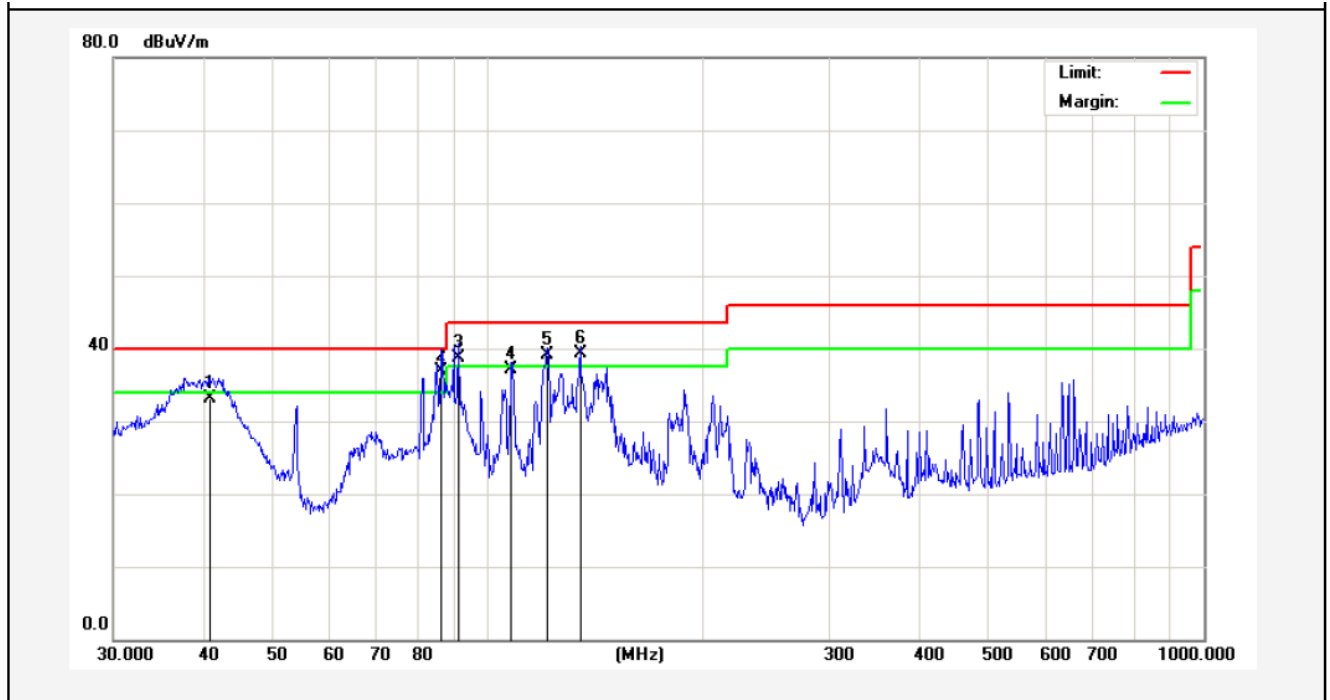

No.	Freq. (MHz)	Reading (dBuV/m)	Factor (dB/m)	Result (dBuV/m)	Limit (dBuV/)	Over Limit (dB)	Detector	Height (cm)	degree (deg)	Remark
1	40.9881	43.87	-10.77	33.10	40.00	-6.90	QP	100	360	
2	86.2001	55.09	-18.23	36.86	40.00	-3.14	QP	100	0	
3	90.8554	56.29	-17.57	38.72	43.50	-4.78	QP	100	360	
4	107.8876	52.70	-15.66	37.04	43.50	-6.46	QP	100	0	
5	121.1230	55.59	-16.49	39.10	43.50	-4.40	QP	100	360	
6	134.5592	57.48	-18.12	39.36	43.50	-4.14	QP	100	0	

Job No.:	011408277E	Polarization:	Horizontal
Standard:	(RE)FCC PART15 C _3m	Power Source:	AC 120V, 60Hz
Test item:	Radiation Test	Temp.(C)/Hum.(%RH):	24.3(C)/55%RH
Note:	802.11b(2412MHz)	Distance:	3m

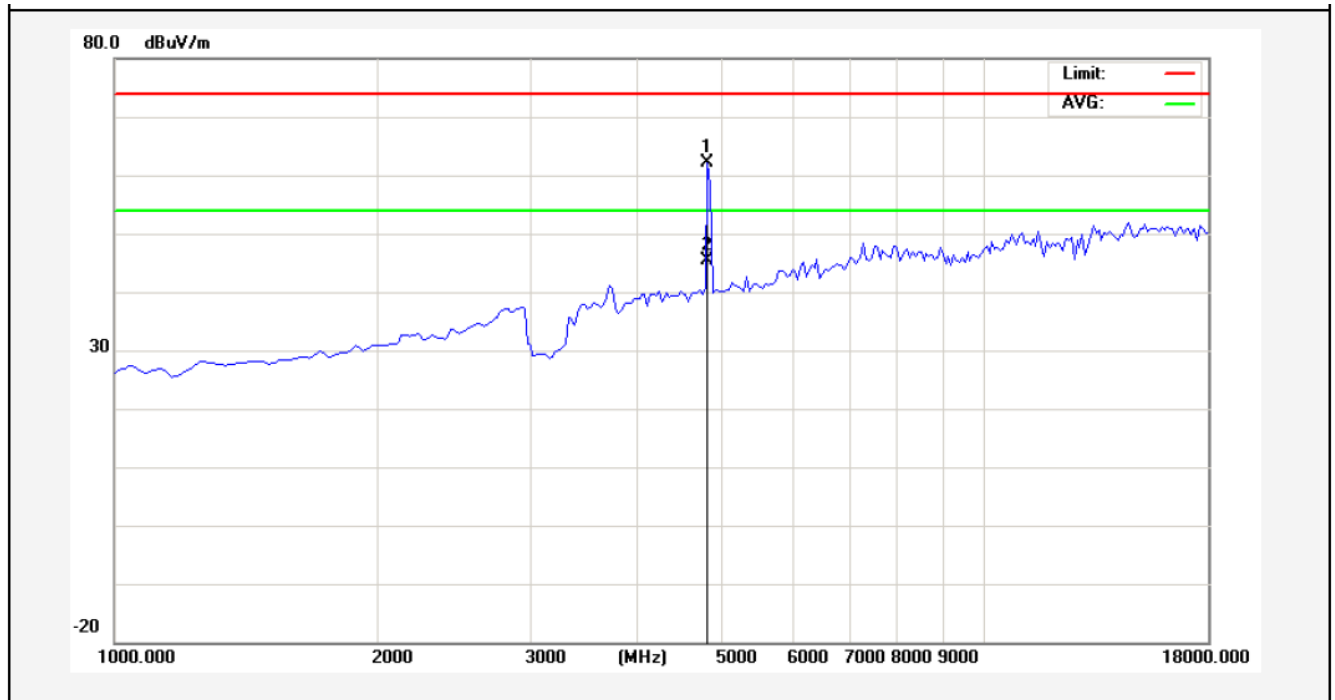

No.	Freq. (MHz)	Reading (dBuV/m)	Factor (dB/m)	Result (dBuV/m)	Limit (dBuV/)	Over Limit (dB)	Detector	Height (cm)	degree (deg)	Remark
1	4825.000	58.79	3.34	62.13	74.00	-11.87	peak			
2	4825.000	42.00	3.34	45.34	54.00	-8.66	AVG			

A.M.

Job No.:	011408277E	Polarization:	Vertical
Standard:	(RE)FCC PART15 C_3m	Power Source:	AC 120V, 60Hz
Test item:	Radiation Test	Temp.(C)/Hum.(%RH):	24.3(C)/55%RH
Note:	802.11b(2412MHz)	Distance:	3m

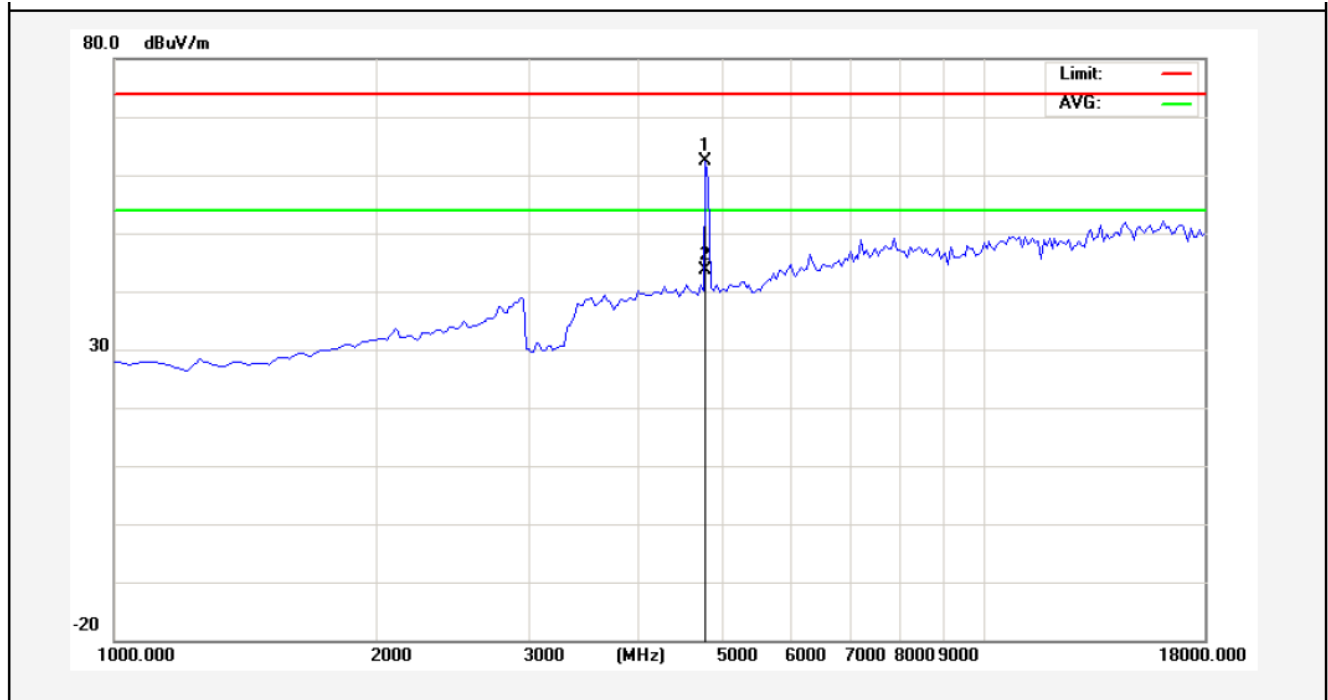

No.	Freq. (MHz)	Reading (dBuV/m)	Factor (dB/m)	Result (dBuV/m)	Limit (dBuV/)	Over Limit (dB)	Detector	Height (cm)	degree (deg)	Remark
1	4825.000	59.01	3.34	62.35	74.00	-11.65	peak			
2	4825.000	40.35	3.34	43.69	54.00	-10.31	AVG			

Job No.:	011408277E	Polarization:	Horizontal
Standard:	(RE)FCC PART15 C_3m	Power Source:	AC 120V, 60Hz
Test item:	Radiation Test	Temp.(C)/Hum.(%RH):	24.3(C)/55%RH
Note:	802.11b(2437MHz)	Distance:	3m

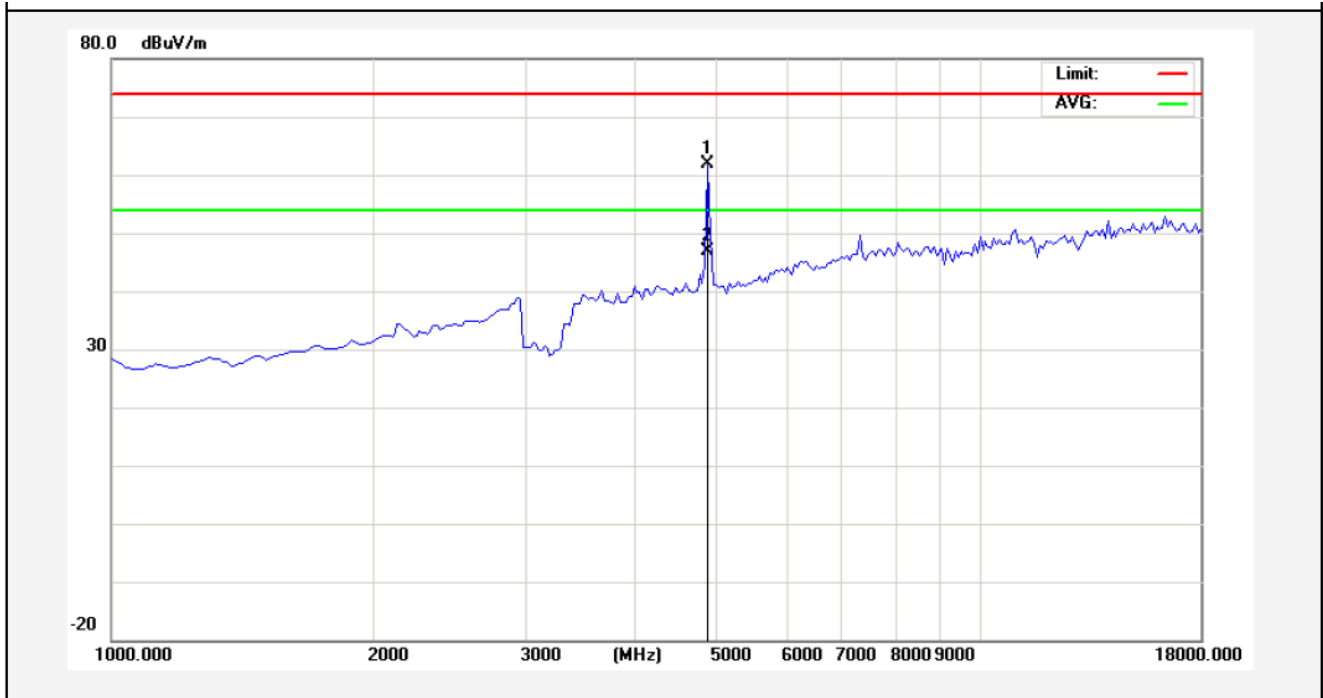

No.	Freq. (MHz)	Reading (dBuV/m)	Factor (dB/m)	Result (dBuV/m)	Limit (dBuV/)	Over Limit (dB)	Detector	Height (cm)	degree (deg)	Remark
1	4867.500	58.53	3.41	61.94	74.00	-12.06	peak			
2	4867.500	43.38	3.41	46.79	54.00	-7.21	AVG			



Job No.:	011408277E	Polarization:	Vertical
Standard:	(RE)FCC PART15 C _3m	Power Source:	AC 120V, 60Hz
Test item:	Radiation Test	Temp.(C)/Hum.(%RH):	24.3(C)/55%RH
Note:	802.11b(2437MHz)	Distance:	3m

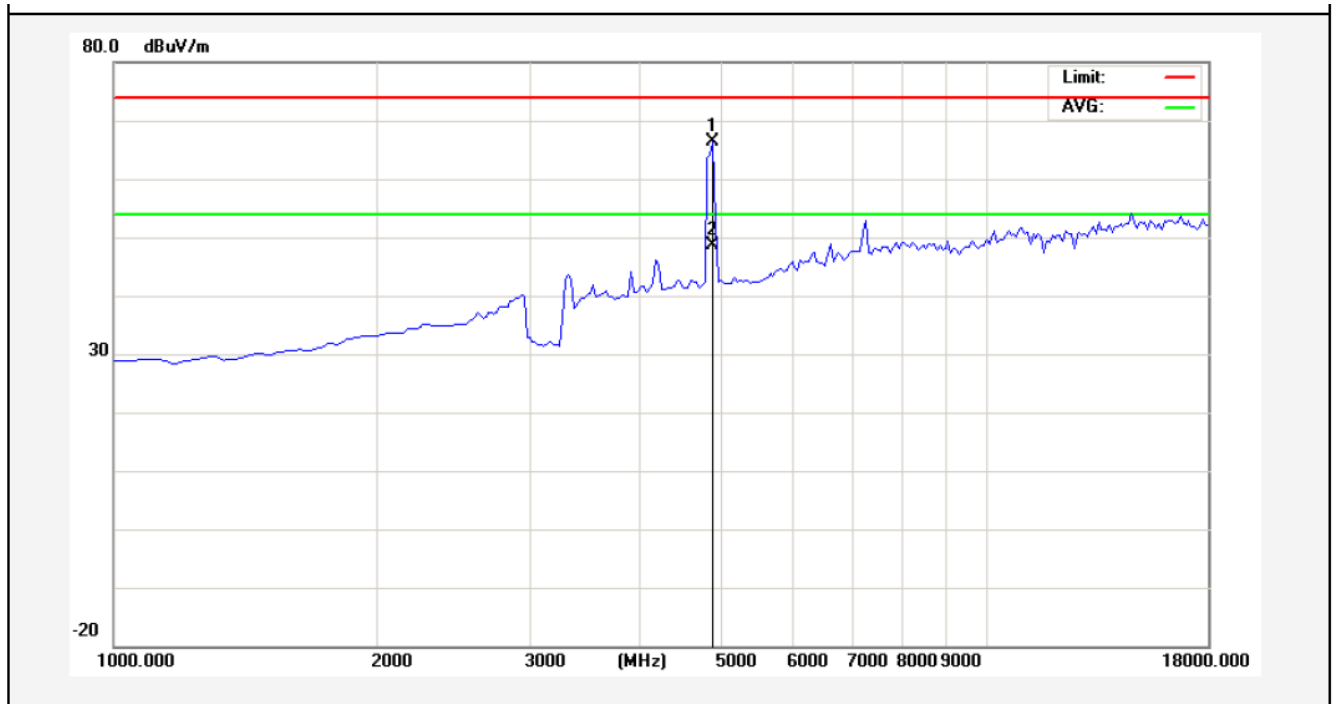

No.	Freq. (MHz)	Reading (dBuV/m)	Factor (dB/m)	Result (dBuV/m)	Limit (dBuV/)	Over Limit (dB)	Detector	Height (cm)	degree (deg)	Remark
1	4867.500	62.97	3.41	66.38	74.00	-7.62	peak			
2	4867.500	45.24	3.41	48.65	54.00	-5.35	AVG			

Job No.:	011408277E	Polarization:	Horizontal
Standard:	(RE)FCC PART15 C_3m	Power Source:	AC 120V, 60Hz
Test item:	Radiation Test	Temp.(C)/Hum.(%RH):	24.3(C)/55%RH
Note:	802.11b(2462MHz)	Distance:	3m

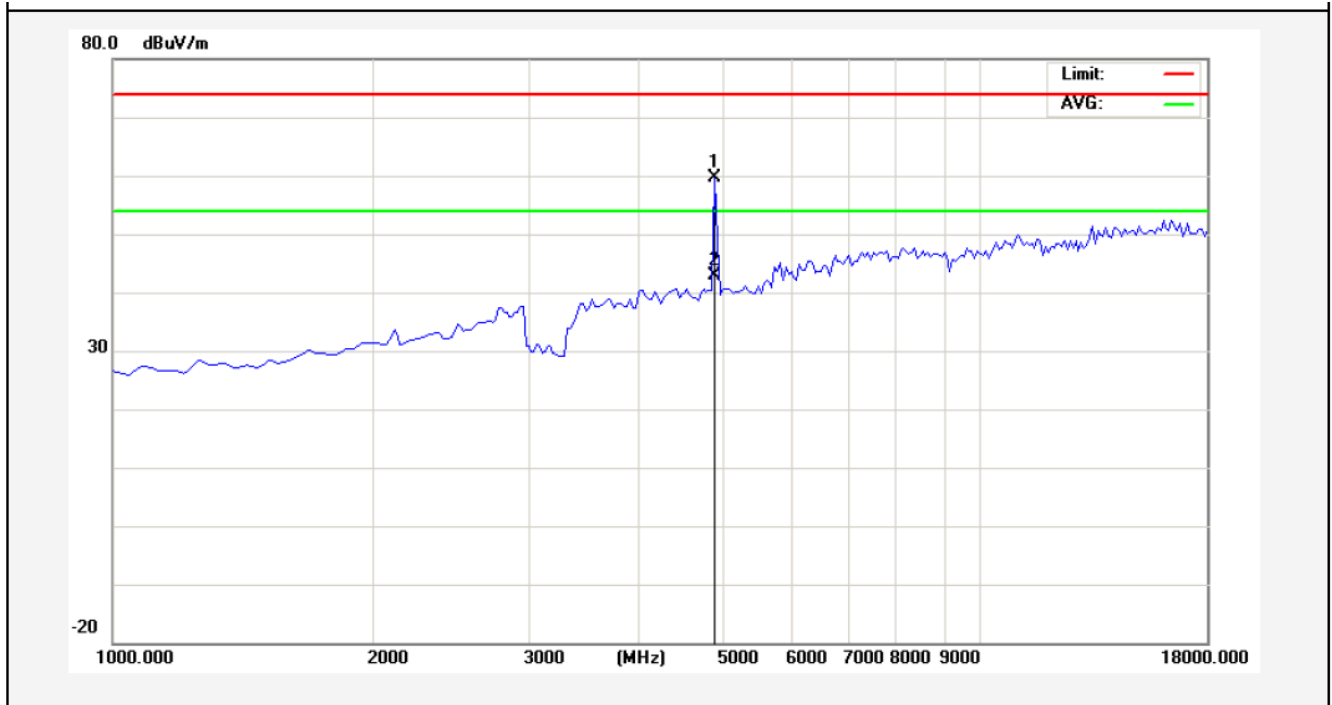

No.	Freq. (MHz)	Reading (dBuV/m)	Factor (dB/m)	Result (dBuV/m)	Limit (dBuV/)	Over Limit (dB)	Detector	Height (cm)	degree (deg)	Remark
1	4910.000	56.25	3.49	59.74	74.00	-14.26	peak			
2	4910.000	39.37	3.49	42.86	54.00	-11.14	AVG			

AM

Job No.:	011408277E	Polarization:	Vertical
Standard:	(RE)FCC PART15 C _3m	Power Source:	AC 120V, 60Hz
Test item:	Radiation Test	Temp.(C)/Hum.(%RH):	24.3(C)/55%RH
Note:	802.11b(2462MHz)	Distance:	3m

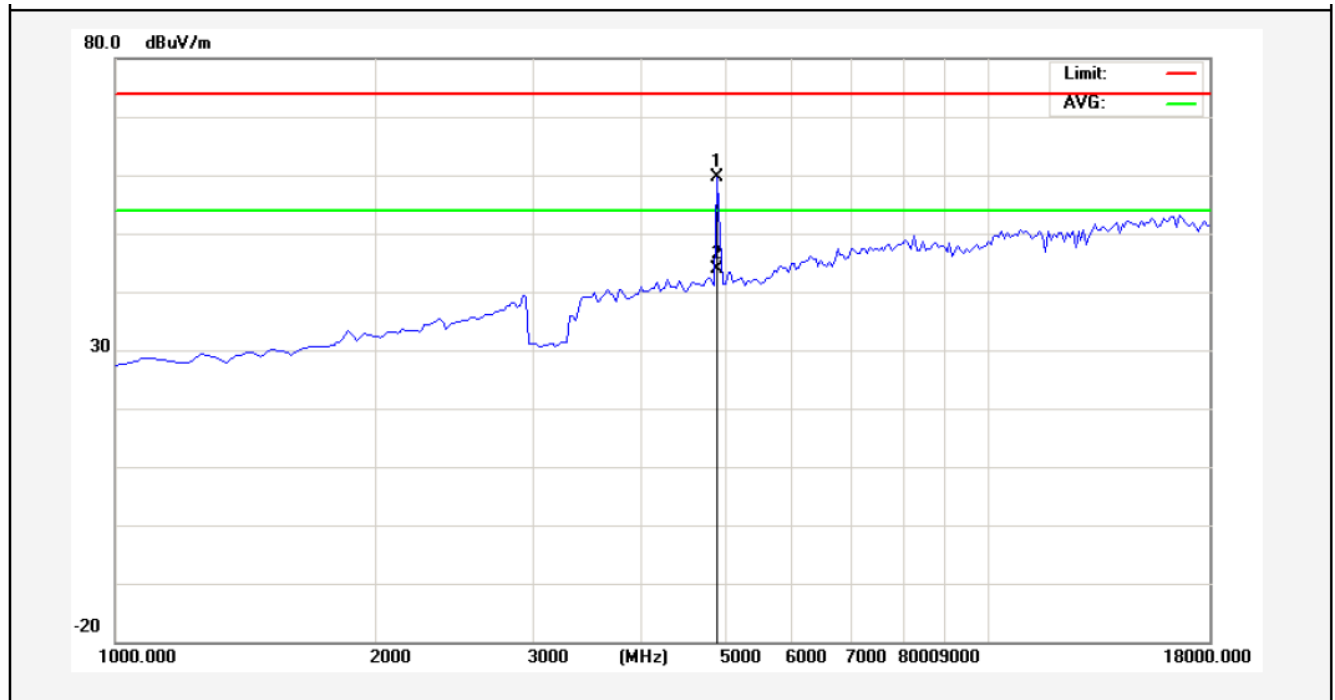

No.	Freq. (MHz)	Reading (dBuV/m)	Factor (dB/m)	Result (dBuV/m)	Limit (dBuV/)	Over Limit (dB)	Detector	Height (cm)	degree (deg)	Remark
1	4910.000	56.09	3.49	59.58	74.00	-14.42	peak			
2	4910.000	40.37	3.49	43.86	54.00	-10.14	AVG			

5. PHOTOGRAPH

5.1. Photo of Conducted Emission Measurement



5.2. Photo of Radiation Emission Test





Anbotek

APPENDIX I (EXTERNAL PHOTOS)

Figure 1
The EUT-Top View



Figure 2
The EUT-Bottom View



Figure 3
The EUT-Left View



Figure 4
The EUT-Right View

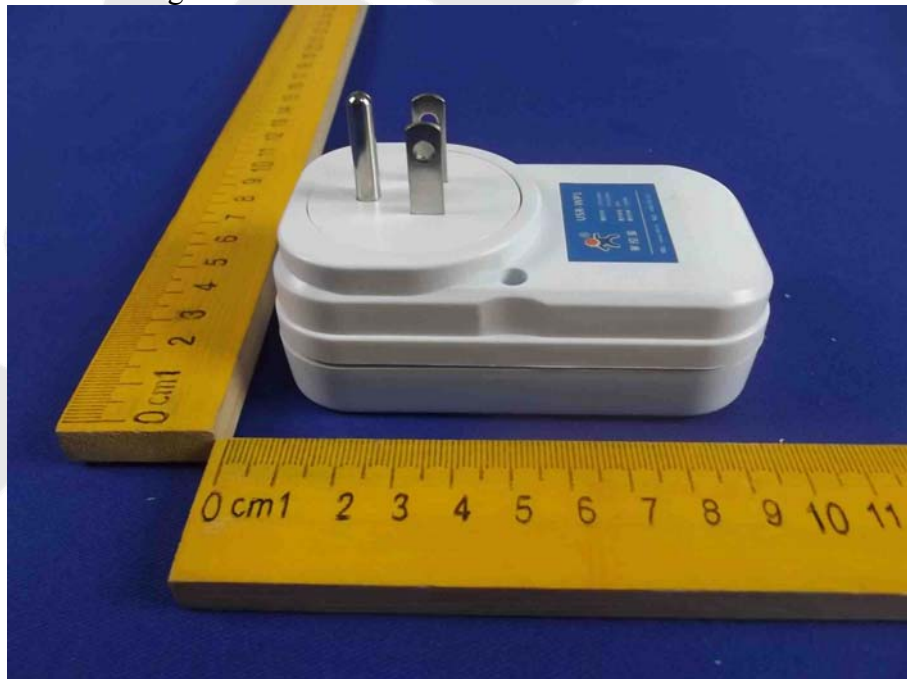
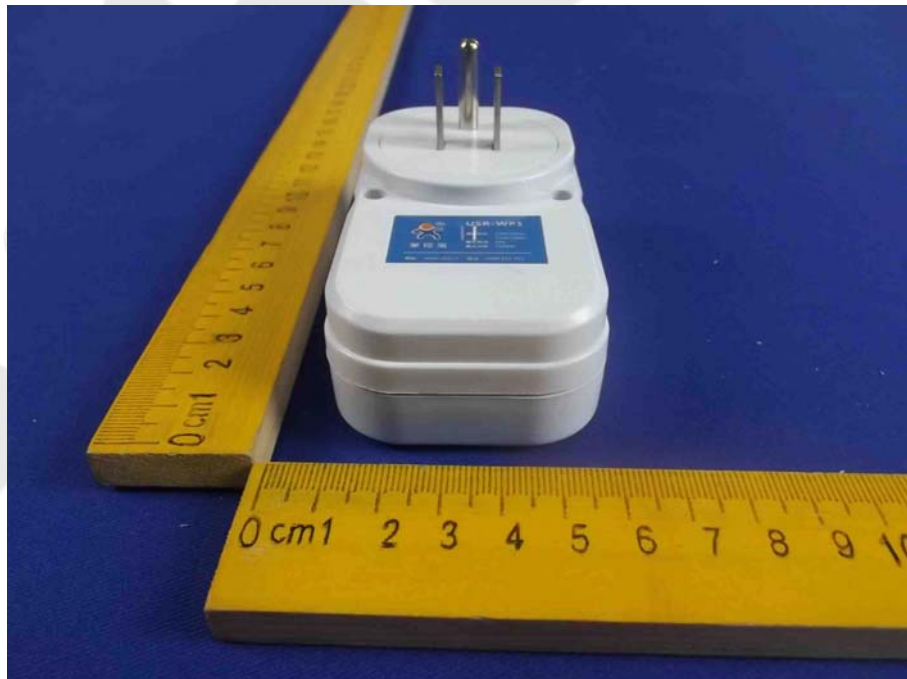

Figure 5
The EUT-Front View



Figure 6
The EUT-Back View



APPENDIX II (INTERNAL PHOTOS)

Figure 7
The EUT-Inside View



Figure 8
PCB of The EUT-Front View

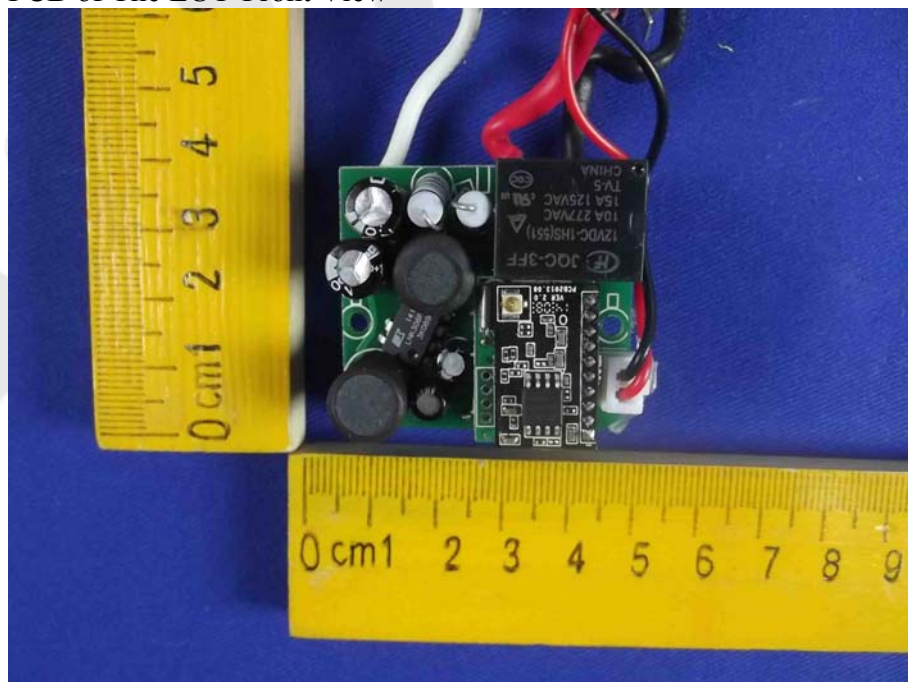

Figure 9
PCB of The EUT-Front View

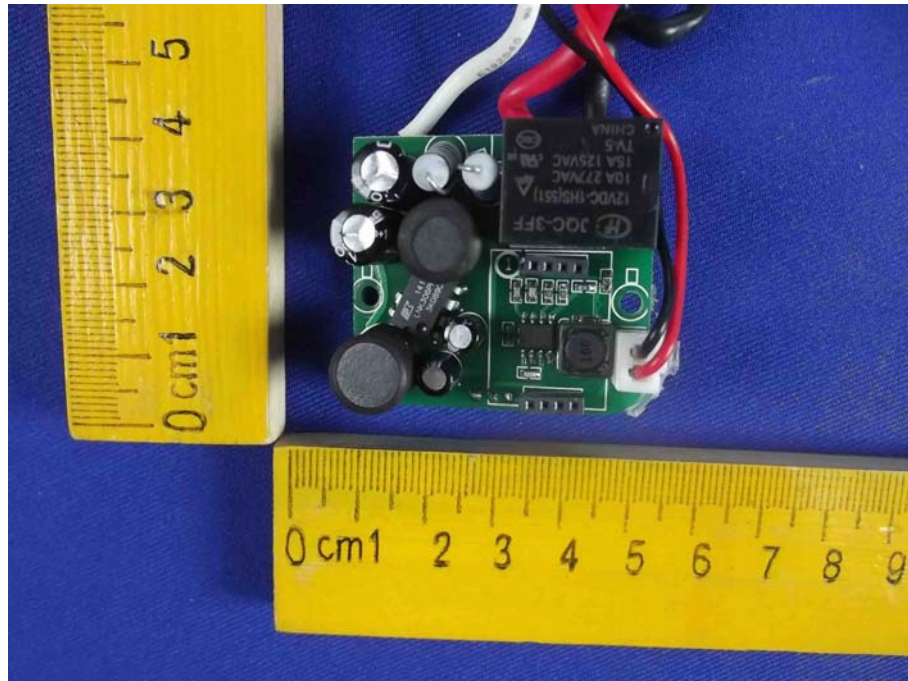

Figure 10
PCB of The EUT-Back View

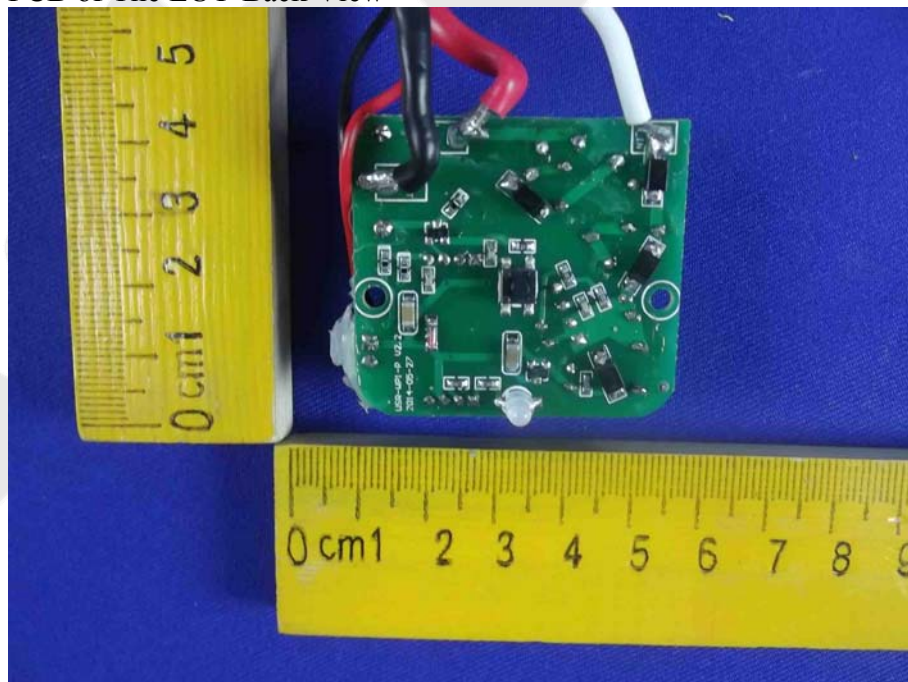

Figure 11
PCB of The EUT-Front View



Figure 12
PCB of The EUT-Back View



Figure 13
PCB of The EUT-Front View



Figure 14
PCB of The EUT-Back View

