

FCC TEST REPORT  
for  
Jinan USR IOT Technology Limited

Serial to WIFI Module  
Model No.: USR-C320, USR-C321, USR-C322, USR-C323,  
USR-C324, USR-C325, USR-C326, USR-C327, USR-C328, USR-C329

Prepared for : Jinan USR IOT Technology Limited  
Address : 11#1103, Building 1, Aosheng Building, No. 1166 Xinluo Street,  
Gaoxin Qu, Jinan, Shandong, 250101, China

Prepared By : Shenzhen Anbotek Compliance Laboratory Limited  
Address : 1/F., Building 1, SEC Industrial Park, No.0409 Qianhai Road,  
Nanshan District, Shenzhen, Guangdong, China  
Tel: (86) 755-26066544  
Fax: (86) 755-26014772

Report Number : R011506757I  
Date of Test : Jun. 23~ Jul. 28 ,2015  
Date of Report : Jul. 29 ,2015

## TABLE OF CONTENT

Description	Page
Test Report	
<b>1. GENERAL INFORMATION.....</b>	<b>4</b>
1.1. Description of Device (EUT).....	4
1.2. Auxiliary Equipment Used during Test.....	5
1.3. Description of Test Facility.....	5
1.4. Measurement Uncertainty.....	5
<b>2. TEST METHODOLOGY.....</b>	<b>6</b>
2.1. Summary of Test Results.....	6
2.2. Description of Test Modes.....	6
2.3. List of channels:.....	7
<b>3. CONDUCTED EMISSION TEST.....</b>	<b>8</b>
3.1. Block Diagram of Test Setup.....	8
3.2. Power Line Conducted Emission Measurement Limits (15.207).....	8
3.3. Configuration of EUT on Measurement.....	8
3.4. Operating Condition of EUT.....	8
3.5. Test Procedure.....	9
3.6. Test equipment.....	9
3.7. Power Line Conducted Emission Measurement Results.....	9
<b>4. FCC PART 15.247 REQUIREMENTS FOR DSSS &amp; OFDM MODULATION.....</b>	<b>14</b>
4.1 Test Setup.....	14
4.2 6dB Bandwidth.....	14
4.3. Maximum Output Power Test.....	22
4.4. Band Edges Measurement.....	26
4.5. Peak Power Spectral Density.....	62
4.6. Radiated Emissions.....	66
<b>5. ANTENNA APPLICATION.....</b>	<b>77</b>
5.1. Antenna requirement.....	77
5.2. Result.....	77
<b>6. PHOTOGRAPH.....</b>	<b>78</b>
6.1. Photo of Conducted Emission Measurement.....	78
6.2. Photo of Radiation Emission Test.....	78
<b>APPENDIX I (EXTERNAL PHOTOS).....</b>	<b>80</b>
<b>APPENDIX II (INTERNAL PHOTOS).....</b>	<b>82</b>

## TEST REPORT

Applicant : Jinan USR IOT Technology Limited  
Manufacturer : Jinan USR IOT Technology Limited  
EUT : Serial to WIFI Module  
Model No. : USR-C320, USR-C321, USR-C322, USR-C323, USR-C324,  
USR-C325, USR-C326, USR-C327, USR-C328, USR-C329  
Serial No. : N.A.  
Trade Mark : USR IOT  
Rating : DC 3.3V, 500mA

Measurement Procedure Used:  
FCC Part15 Subpart C 2014, Paragraph 15.247

The device described above is tested by Shenzhen Anbotek Compliance Laboratory Limited to determine the maximum emission levels emanating from the device and the severe levels of the device can endure and its performance criterion. The measurement results are contained in this test report and Shenzhen Anbotek Compliance Laboratory Limited is assumed full of responsibility for the accuracy and completeness of these measurements. Also, this report shows that the EUT (Equipment Under Test) is technically compliant with the FCC Part 15 Subpart C requirements.

This report applies to above tested sample only and shall not be reproduced in part without written approval of Shenzhen Anbotek Compliance Laboratory Limited.

Date of Test : Jun. 23~ Jul. 28 ,2015

Prepared by : *Kebo Zhang*  
(Tested Engineer / Kebo Zhang)

Reviewer : *Amy Ding*  
(Project Manager / Amy Ding)

Approved & Authorized Signer : *Tom Chen*  
(Manager / Tom Chen)

## 1. GENERAL INFORMATION

### 1.1. Description of Device (EUT)

EUT	: Serial to WIFI Module
Model Number	: USR-C320, USR-C321, USR-C322, USR-C323, USR-C324, USR-C325, USR-C326, USR-C327, USR-C328, USR-C329 (Note: All samples are the same except the model number and colour, so we prepare “USR-C322” for test only.)
Test Power Supply	: AC 120V, 60Hz and AC 240V, 60Hz for adapter
Adapter	: Model: FLDS1003-0501000C Input: AC 100-240V, 50/60Hz, 0.15A Max Output: DC 5V, 1.0A
RF Transmission Frequency	: 2412MHz~2462MHz (802.11b/802.11g/802.11n(HT20)) 2422MHz~2452MHz ( 802.11n(HT40))
Channels	: 11 For (802.11b/802.11g/802.11n(HT20)) 7 For (802.11n(HT40))
Modulation	: 802.11b CCK; 802.11g OFDM; 802.11n MCS
Antenna Gain:	: 0.5dBi
Applicant Address	: Jinan USR IOT Technology Limited 11#1103, Building 1, Aosheng Building, No. 1166 Xinluo Street, Gaoxin Qu, Jinan, Shandong, 250101, China
Manufacturer Address	: Jinan USR IOT Technology Limited 11#1103, Building 1, Aosheng Building, No. 1166 Xinluo Street, Gaoxin Qu, Jinan, Shandong, 250101, China
Factory Address	: Jinan USR IOT Technology Limited 11#1103, Building 1, Aosheng Building, No. 1166 Xinluo Street, Gaoxin Qu, Jinan, Shandong, 250101, China
Date of receipt	: Jun. 23, 2015
Date of Test	: Jun. 23~ Jul. 28 ,2015

## 1.2. Auxiliary Equipment Used during Test

N/A

## 1.3. Description of Test Facility

The test facility is recognized, certified, or accredited by the following organizations:

### **CNAS - LAB Code: L3503**

Shenzhen Anbotek Compliance Laboratory Limited., Laboratory has been assessed and in compliance with CNAS/CL01: 2006 accreditation criteria for testing laboratories (identical to ISO/IEC 17025:2005 General Requirements) for the Competence of Testing Laboratories.

### **FCC-Registration No.: 752021**

Shenzhen Anbotek Compliance Laboratory Limited, EMC Laboratory has been registered and fully described in a report filed with the (FCC) Federal Communications Commission. The acceptance letter from the FCC is maintained in our files. Registration 752021, July 10, 2013.

### **IC-Registration No.: 8058A-1**

Shenzhen Anbotek Compliance Laboratory Limited., EMC Laboratory has been registered and fully described in a report filed with the (IC) Industry Canada. The acceptance letter from the IC is maintained in our files. Registration 8058A, February 22, 2013.

### **Test Location**

All Emissions tests were performed at  
Shenzhen Anbotek Compliance Laboratory Limited. at 1/F., Building 1, SEC Industrial Park, No.0409 Qianhai Road, Nanshan District, Shenzhen, Guangdong, China

## 1.4. Measurement Uncertainty

Radiation Uncertainty : Ur = 4.1 dB (Horizontal)  
Ur = 4.3 dB (Vertical)

Conduction Uncertainty : Uc = 3.4dB

## 2. TEST METHODOLOGY

The tests documented in this report were performed in accordance with ANSI C63.10: 2013 and FCC Part 15, Paragraph 15.247.

### 2.1. Summary of Test Results

The EUT has been tested according to the following specifications:

Standard	Test Type	Result	Notes
FCC Part 15, Paragraph 15.107, 15.207	Conducted Emission Test	PASS	Complies
FCC Part 15, Paragraph 15.247(b)(1)	Maximum Output Power	PASS	Complies
FCC Part 15, Paragraph 15.247(a)(2)	6dB Bandwidth	PASS	Complies
FCC Part 15, Paragraph 15.247(c)	100kHz Bandwidth of Frequency Band Edges	PASS	Complies
FCC Part 15, Paragraph 15.209(a)(f)	Spurious Emission	PASS	Complies
FCC Part 15, Paragraph 15.247(a)(1)	Frequency Separation	-	N/A
FCC Part 15, Paragraph 15.247(a)(1)(iii)	Number of Hopping Frequency	-	N/A
FCC Part 15, Paragraph 15.247(a)(1)(iii)	Time of Occupancy	-	N/A
FCC Part 15, Paragraph 15.247(c)	Peak Power Density	PASS	Complies

### 2.2. Description of Test Modes

The EUT has been tested under operating condition.

Software used to control the EUT for staying in continuous transmitting and receiving mode is programmed.

IEEE802.11b: Channel 1(2412MHz), Channel 6(2437MHz) and Channel 11(2462MHz) with 1 Mbps lowest data rate (worst case) are chosen for the final testing.

IEEE802.11g: Channel 1(2412MHz), Channel 6(2437MHz) and Channel 11(2462MHz) with 6 Mbps lowest data rate (the worst case) are chosen for the final testing.

IEEE802.11n (HT20): Channel 1(2412MHz), Channel 6(2437MHz) and Channel 11(2462MHz) with MCS 0 Mbps lowest data rate (the worst case) are chosen for the final testing.

IEEE802.11n (HT40): Channel 3(2422MHz), Channel 6(2437MHz) and Channel 9(2452MHz) with MCS 0 Mbps lowest data rate (the worst case) are chosen for the final testing.

### 2.3. List of channels:

√ - available

X - tested

Number	Frequency(MHz)		802.11 b/g/n (HT20)	802.11 b/g/n (HT40)
1	2412	√	X	
2	2417	√		
3	2422	√		X
4	2427	√		
5	2432	√		
6	2437	√	X	X
7	2442	√		
8	2447	√		
9	2452	√		X
10	2457	√		
11	2462	√	X	

### 3. Conducted Emission Test

#### 3.1. Block Diagram of Test Setup

##### 3.1.1. Block diagram of connection between the EUT and simulators

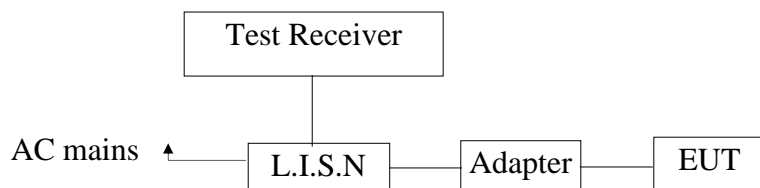

#### 3.2. Power Line Conducted Emission Measurement Limits (15.207)

Frequency MHz	Limits dB(μV)	
	Quasi-peak Level	Average Level
0.15 ~ 0.50	66 ~ 56*	56 ~ 46*
0.50 ~ 5.00	56	46
5.00 ~ 30.00	60	50

- Notes: 1. \*Decreasing linearly with logarithm of frequency.  
2. The lower limit shall apply at the transition frequencies.

#### 3.3. Configuration of EUT on Measurement

The following equipments are installed on Power Line Conducted Emission Measurement to meet the commission requirement and operating regulations in a manner which tends to maximize its emission characteristics in a normal application.

#### 3.4. Operating Condition of EUT

- 3.4.1. Setup the EUT and simulator as shown as Section 3.1.
- 3.4.2. Turn on the power of all equipment.
- 3.4.3. Let the EUT work in test mode (ON) and measure it.



### 3.5. Test Procedure

The EUT system is connected to the power mains through a line impedance stabilization network (L.I.S.N.). This provides a 50ohm coupling impedance for the EUT system. Please refer the block diagram of the test setup and photographs. Both sides of AC line are checked to find out the maximum conducted emission. In order to find the maximum emission levels, the relative positions of equipment and all of the interface cables shall be changed according to FCC ANSI C63.10-2013 on Conducted Emission Measurement.

The bandwidth of test receiver (ESCI) set at 9KHz.

The frequency range from 150KHz to 30MHz is checked.

The test results are reported on Section 3.6.

### 3.6. Test equipment

Item	Equipment	Manufacturer	Model No.	Serial No.	Last Cal.	Cal. Interval
1.	Two-Line V-network	Rohde & Schwarz	ENV216	100055	Apr. 17, 2015	1 Year
2.	EMI Test Receiver	Rohde & Schwarz	ESCI	100627	Apr. 17, 2015	1 Year
3.	RF Switching Unit	Compliance Direction	RSU-M2	38303	Apr. 17, 2015	1 Year

### 3.7. Power Line Conducted Emission Measurement Results

**PASS.**

The frequency range from 150KHz to 30 MHz is investigated.

Please refer the following pages.

**CONDUCTED EMISSION TEST DATA**

Test Site: 1# Shielded Room  
 Operating Condition: ON  
 Test Specification: AC 120V, 60Hz for adapter  
 Comment: Live Line  
 Tem.:24°C Hum.:52%

**SCAN TABLE: "Voltage (150K~30M) FIN"**  
 Short Description: 150K-30M Disturbance Voltages

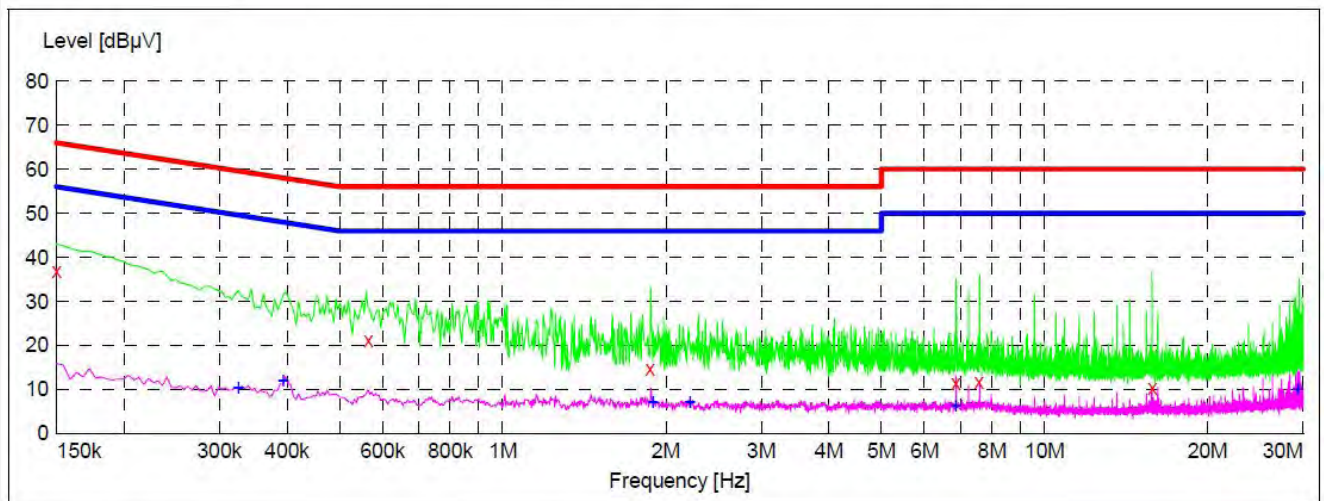

Frequency MHz	Level dBµV	Transd dB	Limit dBµV	Margin dB	Detector	Line	PE
0.150000	37.00	20.1	66	29.0	QP	L1	GND
0.564000	21.30	20.1	56	34.7	QP	L1	GND
1.868500	14.60	20.3	56	41.4	QP	L1	GND
6.854500	11.40	20.5	60	48.6	QP	L1	GND
7.556500	11.70	20.5	60	48.3	QP	L1	GND
15.809500	10.40	20.7	60	49.6	QP	L1	GND

Frequency MHz	Level dBµV	Transd dB	Limit dBµV	Margin dB	Detector	Line	PE
0.325500	10.30	20.1	50	39.3	AV	L1	GND
0.393000	12.00	20.1	48	36.0	AV	L1	GND
1.895500	7.10	20.3	46	38.9	AV	L1	GND
2.215000	7.10	20.3	46	38.9	AV	L1	GND
6.845500	6.30	20.5	50	43.7	AV	L1	GND
29.305000	10.10	20.9	50	39.9	AV	L1	GND

**CONDUCTED EMISSION TEST DATA**

Test Site: 1# Shielded Room  
 Operating Condition: ON  
 Test Specification: AC 120V, 60Hz for adapter  
 Comment: Neutral Line  
 Tem.:24°C Hum.:52%

**SCAN TABLE: "Voltage (150K~30M) FIN"**

Short Description: 150K-30M Disturbance Voltages

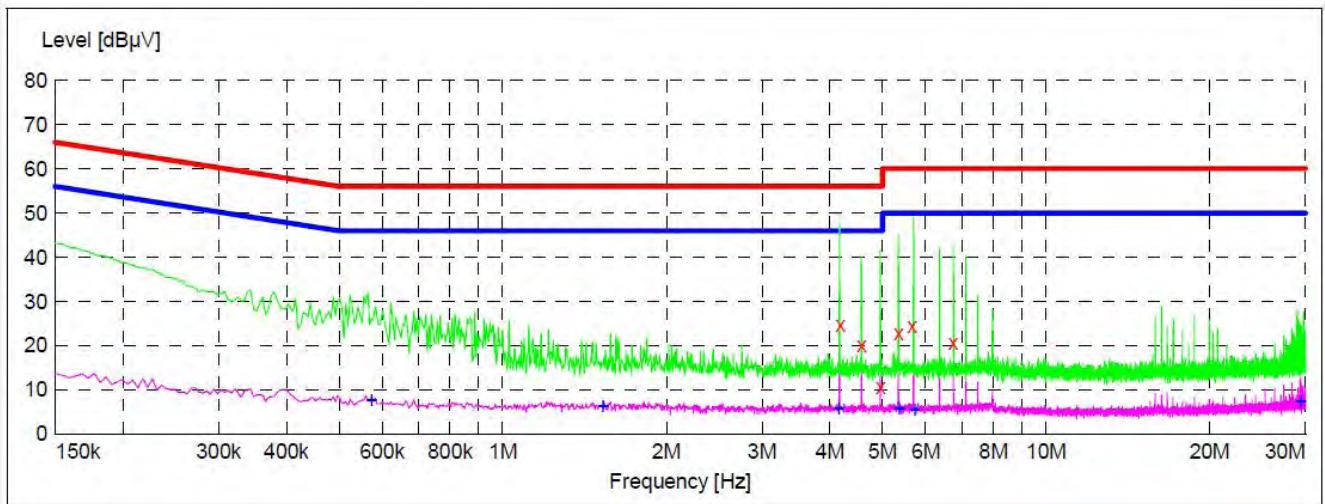

Frequency MHz	Level dBµV	Transd dB	Limit dBµV	Margin dB	Detector	Line	PE
4.181500	24.80	20.5	56	31.2	QP	N	GND
4.573000	20.00	20.5	56	36.0	QP	N	GND
4.955500	10.60	20.5	56	45.4	QP	N	GND
5.356000	22.70	20.5	60	37.3	QP	N	GND
5.675500	24.60	20.5	60	35.4	QP	N	GND
6.742000	20.70	20.5	60	39.3	QP	N	GND

Frequency MHz	Level dBµV	Transd dB	Limit dBµV	Margin dB	Detector	Line	PE
0.573000	7.70	20.1	46	38.3	AV	N	GND
1.526500	6.40	20.3	46	39.6	AV	N	GND
4.145500	5.70	20.5	46	40.3	AV	N	GND
5.365000	5.70	20.5	50	44.3	AV	N	GND
5.725000	5.60	20.5	50	44.4	AV	N	GND
29.404000	7.30	20.9	50	42.7	AV	N	GND

**CONDUCTED EMISSION TEST DATA**

Test Site: 1# Shielded Room  
 Operating Condition: ON  
 Test Specification: AC 240V, 60Hz for adapter  
 Comment: Live Line  
 Tem.:24°C Hum.:52%

**SCAN TABLE: "Voltage (150K~30M) FIN"**

Short Description: 150K-30M Disturbance Voltages

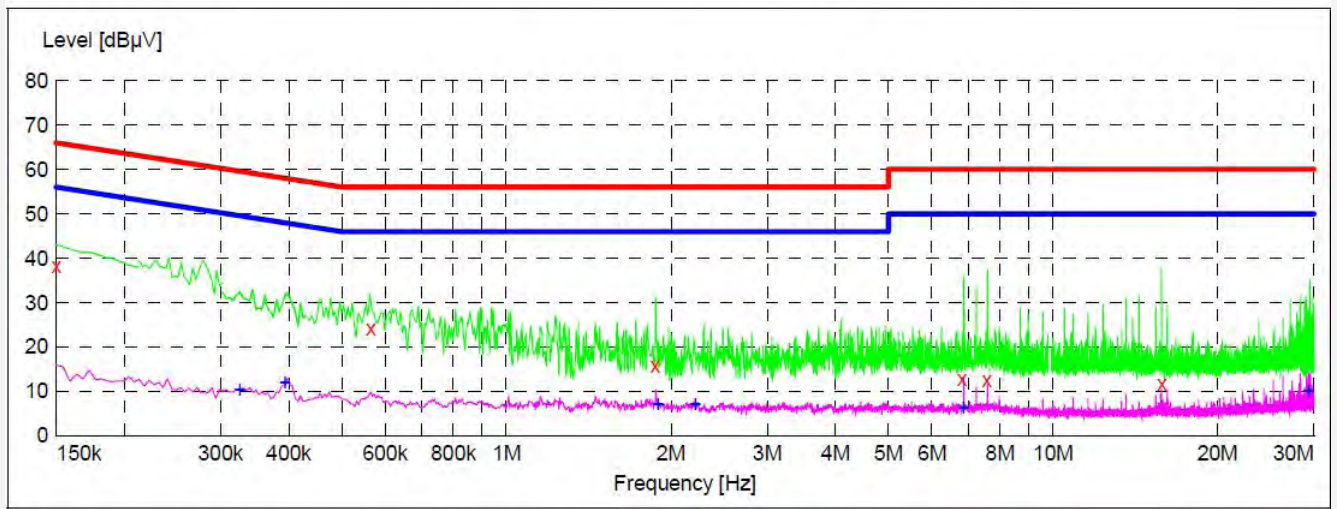

Frequency MHz	Level dBµV	Transd dB	Limit dBµV	Margin dB	Detector	Line	PE
0.143450	38.00	20.1	66	28.0	QP	L1	GND
0.545600	22.40	20.1	56	33.6	QP	L1	GND
1.875600	17.50	20.3	56	39.5	QP	L1	GND
6.756000	12.20	20.5	60	47.8	QP	L1	GND
7.754500	13.50	20.5	60	46.5	QP	L1	GND
15.786500	11.40	20.7	60	48.6	QP	L1	GND

Frequency MHz	Level dBµV	Transd dB	Limit dBµV	Margin dB	Detector	Line	PE
0.354400	10.40	20.1	50	39.6	AV	L1	GND
0.375000	11.80	20.1	48	35.2	AV	L1	GND
1.867800	7.50	20.3	46	38.5	AV	L1	GND
2.146500	7.40	20.3	46	38.6	AV	L1	GND
6.785000	6.80	20.5	50	43.2	AV	L1	GND
29.356700	10.40	20.9	50	39.6	AV	L1	GND

**CONDUCTED EMISSION TEST DATA**

Test Site: 1# Shielded Room  
 Operating Condition: ON  
 Test Specification: AC 240V, 60Hz for adapter  
 Comment: Neutral Line  
 Tem.:24°C Hum.:52%

**SCAN TABLE: "Voltage (150K~30M) FIN"**

Short Description: 150K-30M Disturbance Voltages

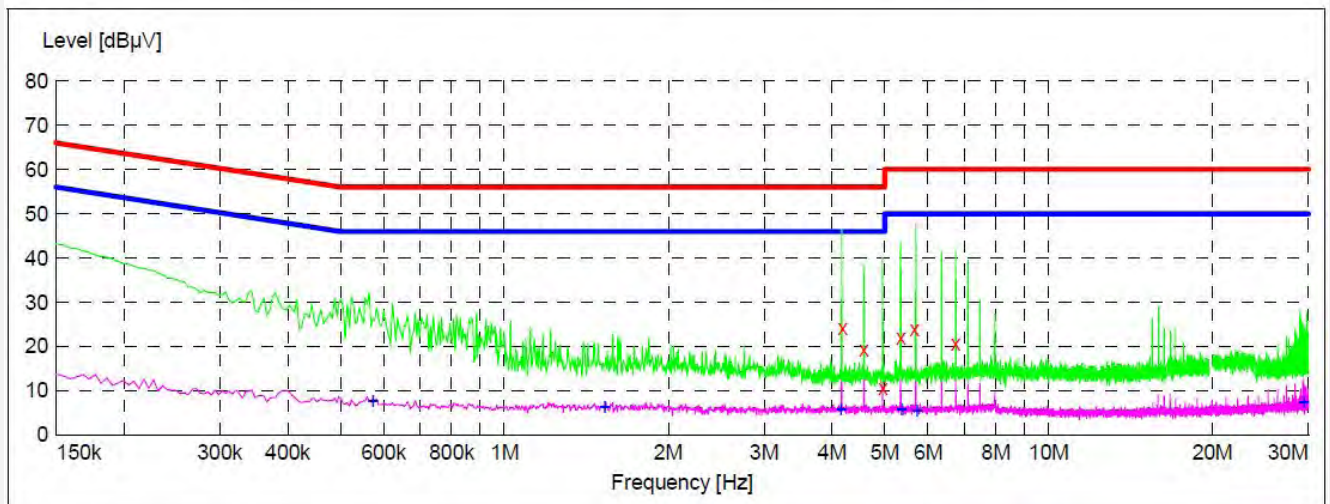

Frequency MHz	Level dBµV	Transd dB	Limit dBµV	Margin dB	Detector	Line	PE
4.421500	23.80	20.5	56	32.2	QP	N	GND
4.424000	20.50	20.5	56	35.5	QP	N	GND
4.865200	11.50	20.5	56	44.5	QP	N	GND
5.265700	21.60	20.5	60	38.4	QP	N	GND
5.865200	23.40	20.5	60	36.6	QP	N	GND
6.654800	20.50	20.5	60	39.5	QP	N	GND

Frequency MHz	Level dBµV	Transd dB	Limit dBµV	Margin dB	Detector	Line	PE
0.535740	7.60	20.1	46	38.4	AV	N	GND
1.545300	6.70	20.3	46	39.3	AV	N	GND
4.135400	4.90	20.5	46	41.1	AV	N	GND
5.345600	5.60	20.5	50	44.4	AV	N	GND
5.645100	5.70	20.5	50	44.3	AV	N	GND
29.342000	7.80	20.9	50	42.2	AV	N	GND

## 4. FCC Part 15.247 Requirements for DSSS & OFDM Modulation

### 4.1 Test Setup

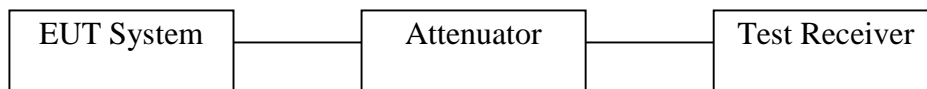

### 4.2 6dB Bandwidth

#### a. Limit

For the direct sequence systems, the minimum 6dB bandwidth shall be at least 500kHz.

#### b. Test Procedure

1. Place the EUT on the table and set it in the transmitting mode.
2. Remove the antenna from the EUT and then connect a low loss RF cable from the antenna port to the spectrum analyzer.
3. Set the spectrum analyzer as:  
RBW = 100kHz, VBW  $\geq 3 \times$  RBW = 300kHz,  
Detector= Peak  
Trace mode= Max hold.  
Sweep- auto couple.
4. Mark the peak frequency and -6dB (upper and lower) frequency.
5. Repeat until all the rest channels are investigated.

#### 20dB Bandwidth:

##### C63.10

#### Occupied Bandwidth (OBW=20dB Bandwidth)

1. Set RBW=1%~5% OBW
2. Set the VBW  $\geq 3 \times$  RBW
3. Set the span range between 2 times and 5 times of the OBW
4. Sweep Time= Auto  
Detector= Peak  
Trace= Max hold
5. Once the reference level is established, the equipment is conditioned with typical modulating signals to produce the worst case (i.e. the widest) bandwidth. Unless otherwise specified for an unlicensed wireless device, measure the bandwidth at the -20dB levels with respect to the reference level.

**c. Test Setup See 4.1**

**d. Test Equipment**

Item	Equipment	Manufacturer	Model No.	Serial No.	Last Cal.	Cal. Interval
1.	Spectrum Analysis	Agilent	E4407B	US39390582	Apr. 17, 2015	1 Year
2.	Preamplifier	Instruments corporation	EMC011830	980100	Apr. 17, 2015	1 Year
3.	EMI Test Receiver	Rohde & Schwarz	ESPI	101604	Apr. 17, 2015	1 Year
4.	Double Ridged Horn Antenna	Instruments corporation	GTH-0118	351600	Apr. 20, 2015	1 Year
5.	Bilog Broadband Antenna	Schwarzbeck	VULB9163	VULB 9163-289	Apr. 20, 2015	1 Year
6.	Pre-amplifier	SONOMA	310N	186860	Apr. 17, 2015	1 Year
7.	EMI Test Software EZ-EMC	SHURPLE	N/A	N/A	N/A	N/A

**e. Test Results**

Pass.

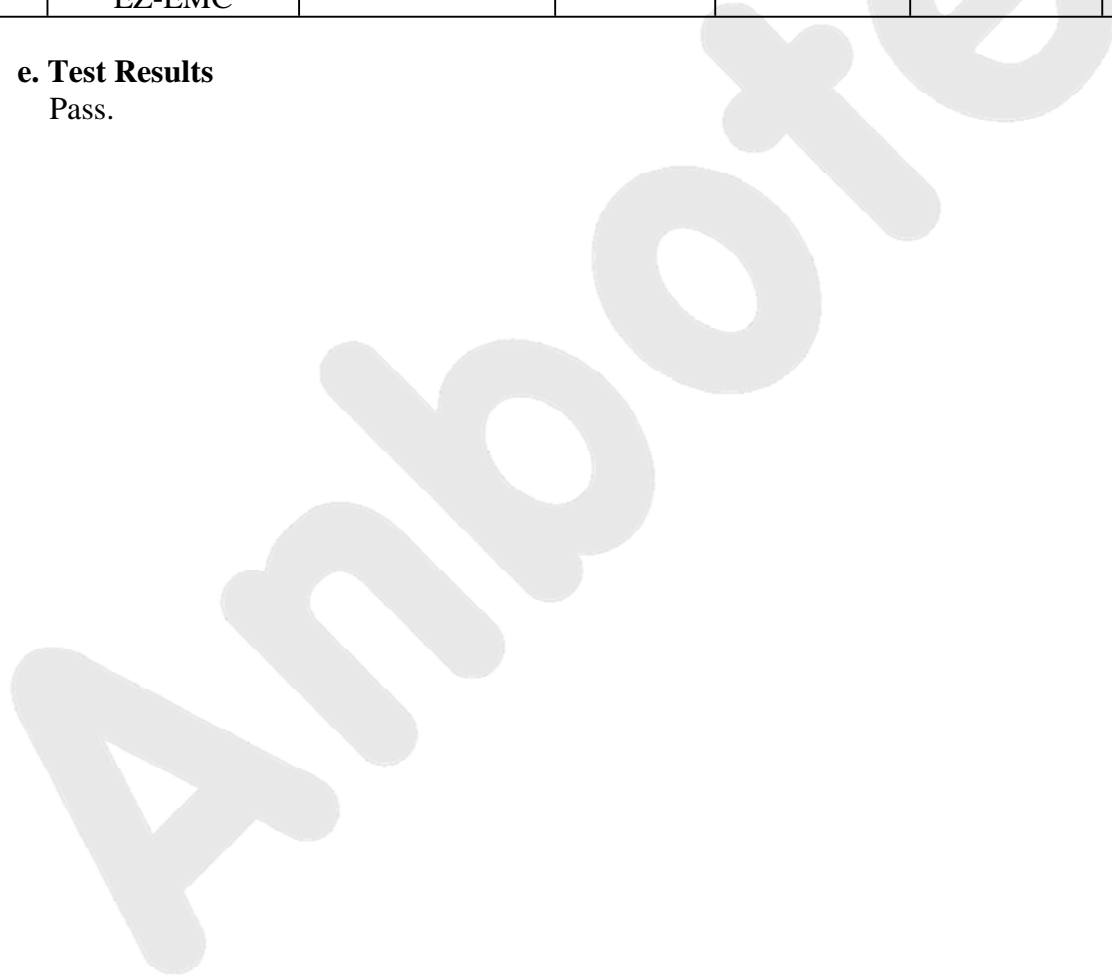

**f. Test Data**  
**6dB Bandwidth**

Test mode: IEEE 802.11b

Channel	Frequency (MHz)	Bandwidth (MHz)	Limit (kHz)	Results
Low	2412	9.076		Pass
Mid	2437	10.04	>500	Pass
High	2462	10.03		Pass

Test mode: IEEE 802.11g

Channel	Frequency (MHz)	Bandwidth (MHz)	Limit (kHz)	Results
Low	2412	15.46		Pass
Mid	2437	15.45	>500	Pass
High	2462	15.44		Pass

Test mode: IEEE 802.11n (HT20)

Channel	Frequency (MHz)	Bandwidth (MHz)	Limit (kHz)	Results
Low	2412	15.69		Pass
Mid	2437	15.70	>500	Pass
High	2462	16.78		Pass

Test mode: IEEE 802.11n (HT40)

Channel	Frequency (MHz)	Bandwidth (MHz)	Limit (kHz)	Results
Low	2422	35.47		Pass
Mid	2437	35.34	>500	Pass
High	2452	35.18		Pass

Test Plots See the following page.



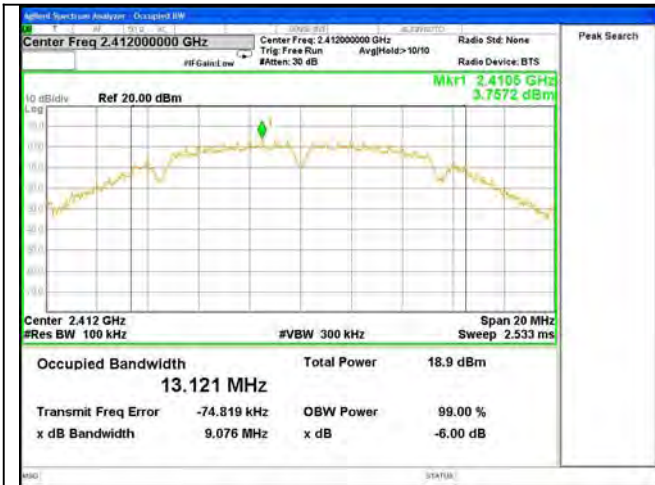

Test Mode: 802.11b---Low



Test Mode: 802.11b---Mid

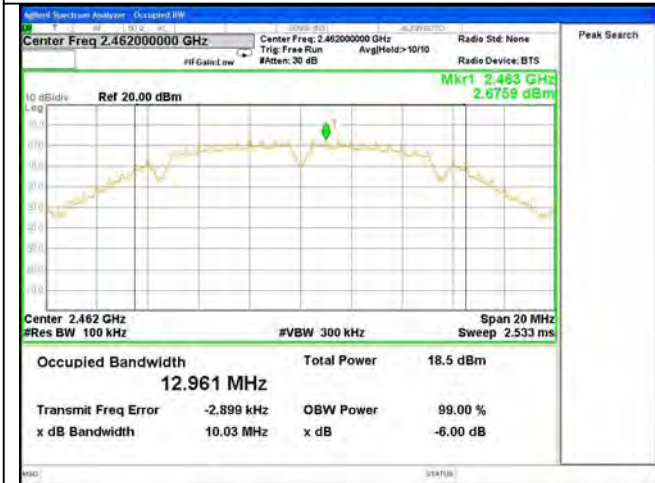

Test Mode: 802.11b---High



Test Mode: 802.11g---Low

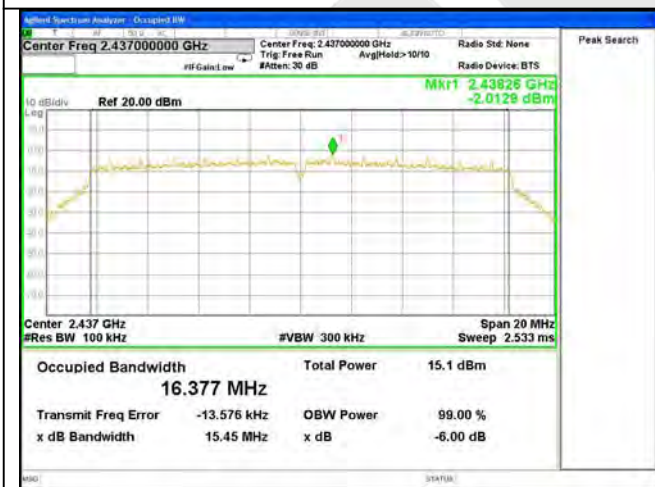

Test Mode: 802.11g---Mid



Test Mode: 802.11g---High



Test Mode: 802.11n20---Low



Test Mode: 802.11n20---Mid

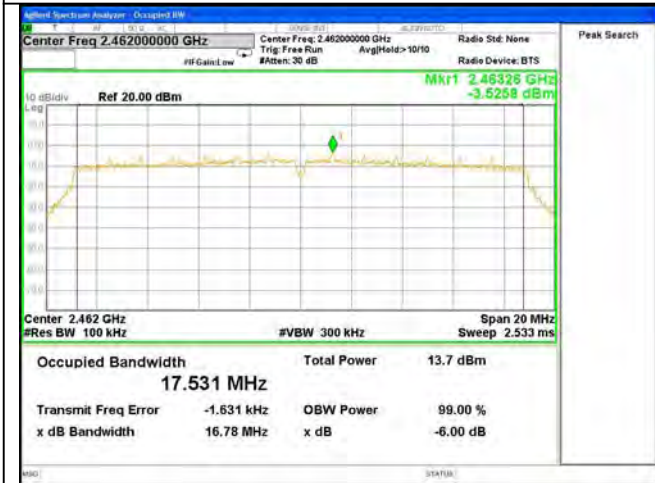

Test Mode: 802.11n20---High



Test Mode: 802.11n40---Low

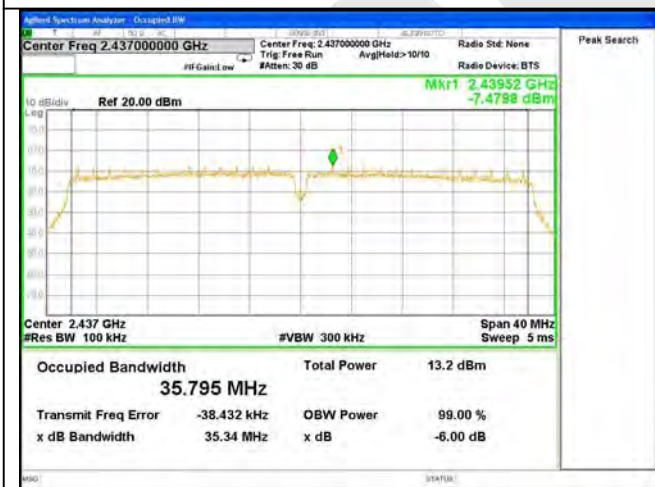

Test Mode: 802.11n40---Mid

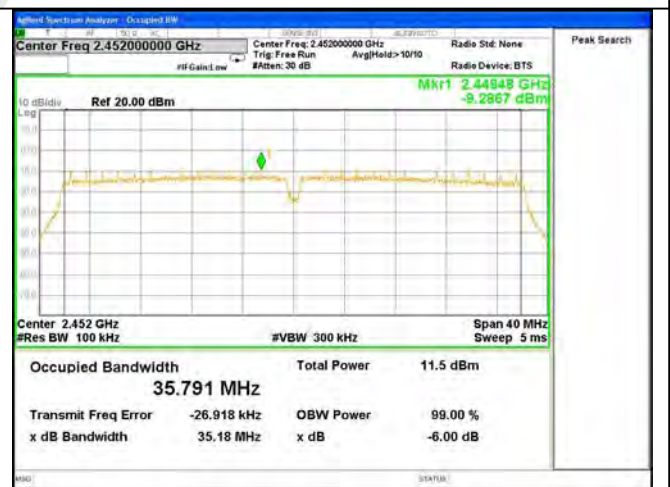

Test Mode: 802.11n40---High

**20dB Bandwidth**

Test mode: IEEE 802.11b

Channel	Frequency (MHz)	Bandwidth (MHz)	Results
Low	2412	14.72	Pass
Mid	2437	15.09	Pass
High	2462	15.17	Pass

Test mode: IEEE 802.11g

Channel	Frequency (MHz)	Bandwidth (MHz)	Results
Low	2412	18.63	Pass
Mid	2437	18.92	Pass
High	2462	18.82	Pass

Test mode: IEEE 802.11n (HT20)

Channel	Frequency (MHz)	Bandwidth (MHz)	Results
Low	2412	19.16	Pass
Mid	2437	19.24	Pass
High	2462	19.27	Pass

Test mode: IEEE 802.11n (HT40)

Channel	Frequency (MHz)	Bandwidth (MHz)	Results
Low	2422	38.00	Pass
Mid	2437	38.00	Pass
High	2452	37.92	Pass

Test Plots See the following page.



Test Mode: 802.11b---Low

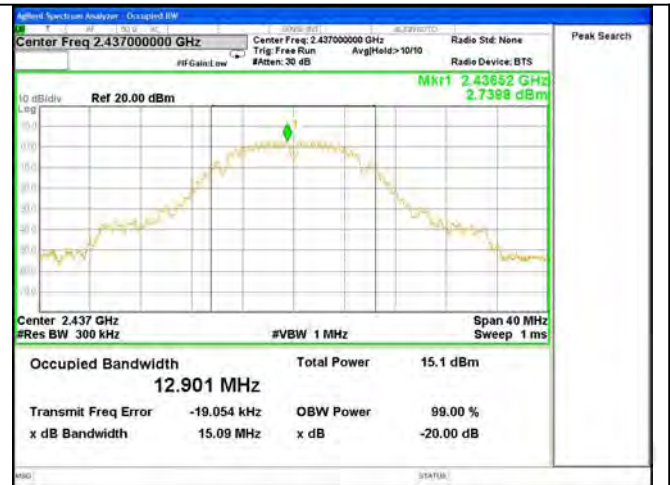

Test Mode: 802.11b---Mid

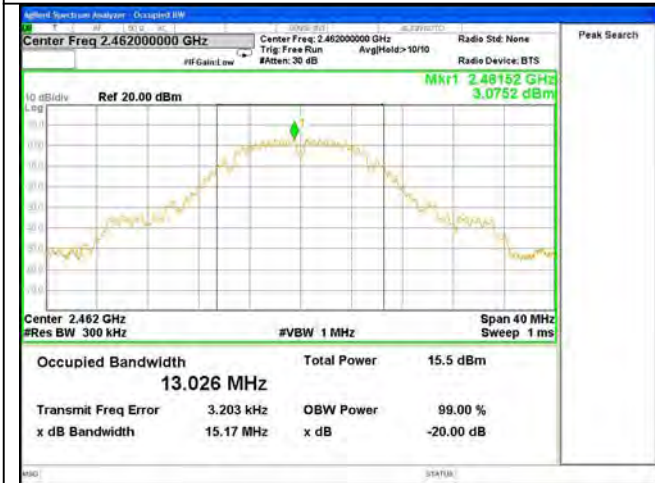

Test Mode: 802.11b---High

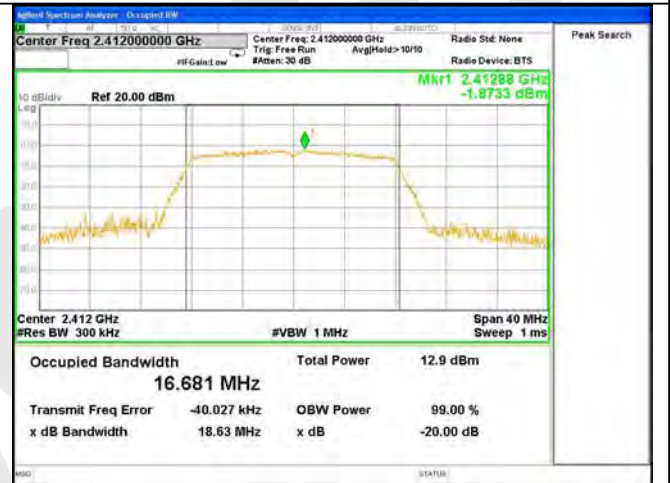

Test Mode: 802.11g---Low

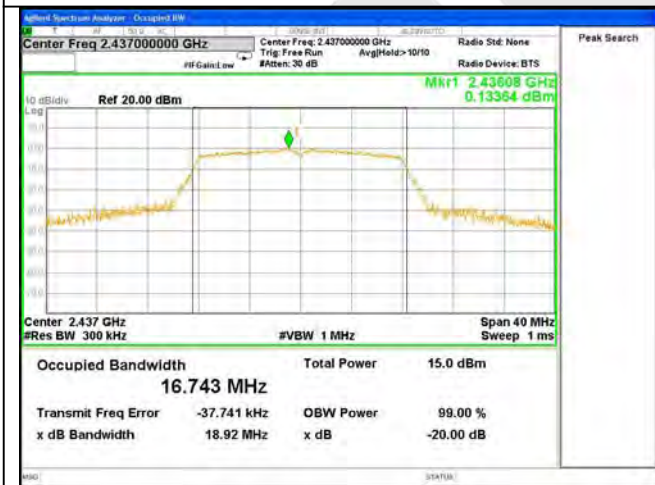

Test Mode: 802.11g---Mid



Test Mode: 802.11g---High

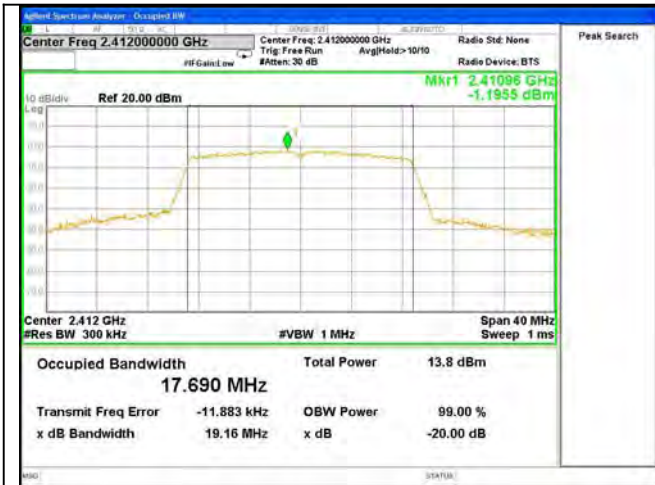

Test Mode: 802.11n20---Low

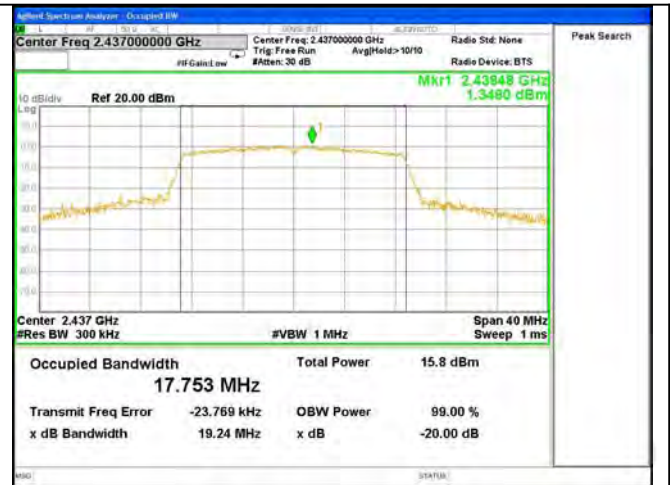

Test Mode: 802.11n20---Mid

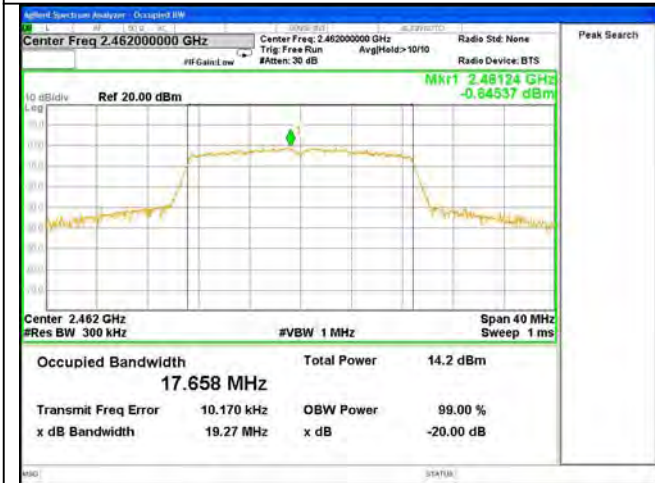

Test Mode: 802.11n20---High

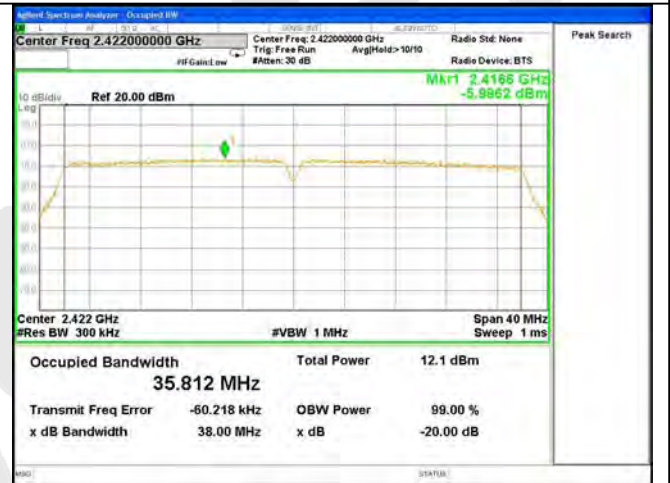

Test Mode: 802.11n40---Low

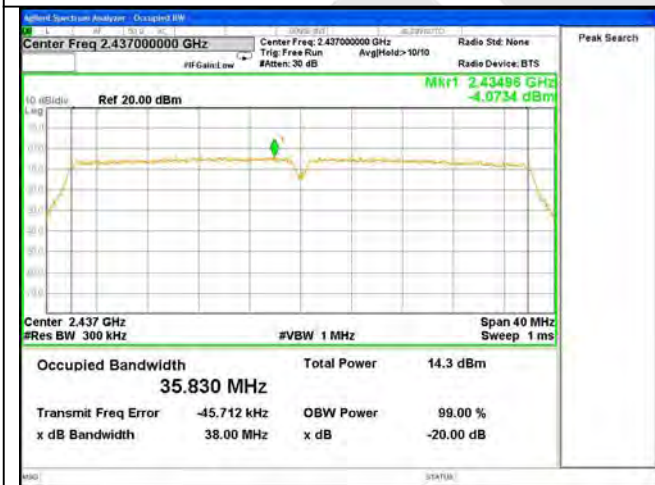

Test Mode: 802.11n40---Mid



Test Mode: 802.11n40---High

### 4.3. Maximum Output Power Test

#### a. Limit

The maximum output power of the intentional radiator shall not exceed the following:

1. For systems using digital modulation in the bands of 902-928 MHz, 2400-2483.5 MHz, and 5725-5850 MHz: 1 watt (30dBm).
2. Except as shown in paragraphs (b)(3) (i), (ii) and (iii) of this section, if transmitting antenna of directional gain greater than 6 dBi are used the peak output power from the intentional radiator shall be reduced below the stated values in paragraphs (b)(1) or (b)(2) of this section, as appropriate, by the amount in dB that the directional gain of the antenna exceeds 6 dBi.

#### b. Configuration of Measurement

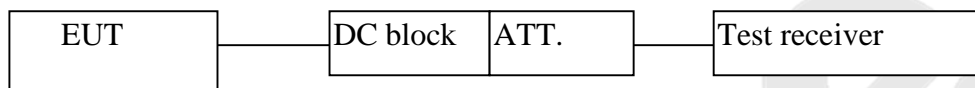

#### c. Data Rates

IEEE802.11b: Channel 1(2412MHz), Channel 6(2437MHz) and Channel 11(2462MHz) with 1 Mbps data rate (worst case) are chosen for the final testing.

IEEE802.11g: Channel 1(2412MHz), Channel 6(2437MHz) and Channel 11(2462MHz) with 6 Mbps data rate (the worst case) are chosen for the final testing.

IEEE802.11n (HT20: Channel 1(2412MHz), Channel 6(2437MHz) and Channel 11(2462MHz) with 6.5Mbps data rate (the worst case) are chosen for the final testing.

IEEE802.11n (HT40: Channel 3(2422MHz), Channel 6(2437MHz) and Channel 9(2452MHz) with 13.5Mbps data rate (the worst case) are chosen for the final testing.

#### d. Test Procedure

**This test was according the kDB 558074 9.2.2:**

1. Set span to at least 1.5 times the OBW.
2. Set the RBW =1~5% of the OBW, not to exceed 1MHz.
3. Set VBW  $\geq 3 * RBW$ .
4. Detector = Average.
5. Sweep time = auto couple.
6. Trace mode = max hold.
7. Allow trace to fully stabilize.

#### e. Test Equipment

Same as the equipment listed in 4.2.

#### f. Test Results

Pass.

**g. Test Data**

Test mode: IEEE 802.11b

Channel	Frequency (MHz)	Maximum transmit power (dBm)	Limit		Result
			(dBm)	(watts)	
Low	2412	15.21	30	1	Pass
Mid	2437	15.16			Pass
High	2462	15.57			Pass

Test mode: IEEE 802.11g

Channel	Frequency (MHz)	Maximum transmit power (dBm)	Limit		Result
			(dBm)	(watts)	
Low	2412	13.66	30	1	Pass
Mid	2437	15.65			Pass
High	2462	13.63			Pass

Test mode: IEEE 802.11n (HT20)

Channel	Frequency (MHz)	Maximum transmit power (dBm)	Limit		Result
			(dBm)	(watts)	
Low	2412	13.03	30	1	Pass
Mid	2437	15.32			Pass
High	2462	13.51			Pass

Test mode: IEEE 802.11n (HT40)

Channel	Frequency (MHz)	Maximum transmit power (dBm)	Limit		Result
			(dBm)	(watts)	
Low	2422	12.09	30	1	Pass
Mid	2437	14.36			Pass
High	2452	11.80			Pass

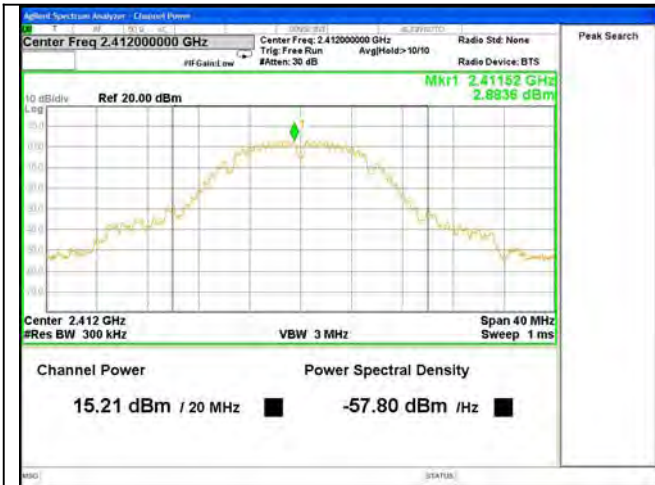

Test Mode: 802.11b---Low

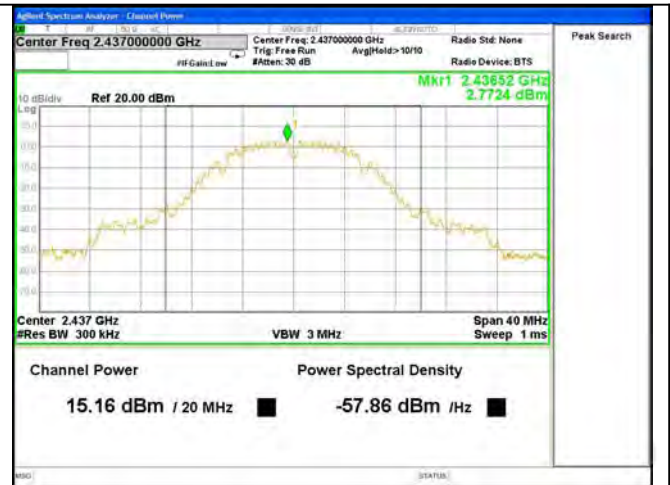

Test Mode: 802.11b---Mid

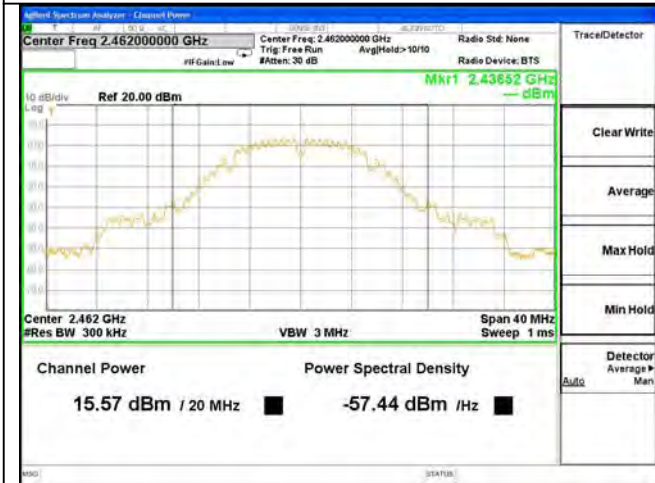

Test Mode: 802.11b---High



Test Mode: 802.11g---Low



Test Mode: 802.11g---Mid



Test Mode: 802.11g---High





Test Mode: 802.11n20---Low



Test Mode: 802.11n20---Mid



Test Mode: 802.11n20---High



Test Mode: 802.11n40---Low

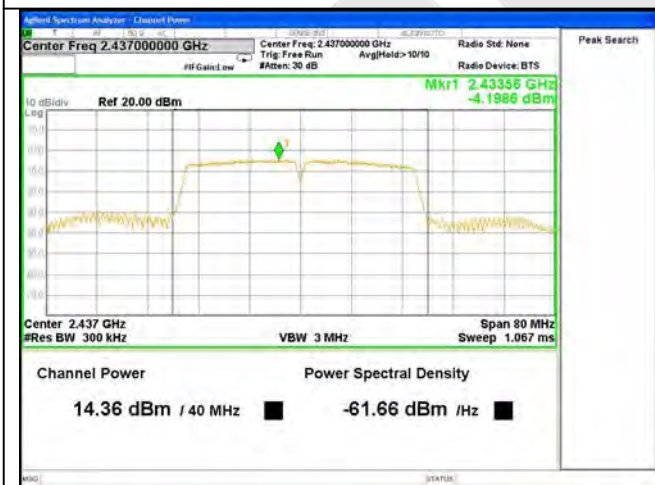

Test Mode: 802.11n40---Mid



Test Mode: 802.11n40---High

#### 4.4. Band Edges Measurement

##### a. Limit

According to §15.247(c), in any 100 kHz bandwidth outside the frequency bands in which the spread spectrum intentional radiator is operating, the radio frequency power that is produced by the intentional radiator shall be at least 20dB below that in the 100kHz bandwidth within the band that contains the highest level of the desired power, In addition, radiated emissions which fall in the restricted bands, as defined in §15.205(a), must also comply with the radiated emission limits specified in §15.209(a).

##### b. Test Procedure

###### 1. Conducted Method:

- 1) Set RBW=100KHz, VBW=300KHz
- 2) Detector=peak
- 3) Sweep time= auto
- 4) Trace mode=max hold.

###### 2. Radiated Method:

- 1) For below 1GHz: The EUT is placed on a turntable, which is 0.8m above the ground plane. The EUT is tested in 9\*6\*6 Chamber.  
For above 1GHz: The EUT is placed on a turntable, which is 1.5m above the ground plane. The EUT is tested in 9\*6\*6 Chamber.
- 2) The turntable shall be rotated for 360 degrees to determine the position of maximum emission level.
- 3) EUT is set 3m away from the receiving antenna, which is varied from 1m to 4m to find out the highest emission.
- 4) Peak detector: RBW=1MHz, VBW=3MHz, SWT=AUTO  
Average detector: RBW=1MHz, VBW=10Hz, SWT=AUTO  
The EUT is tested in 9\*6\*6 Chamber.
- 5) Repeat the procedures until all the PEAK and AVERAGE versus POLARIZATION are measured.

30M to 1G emissions:

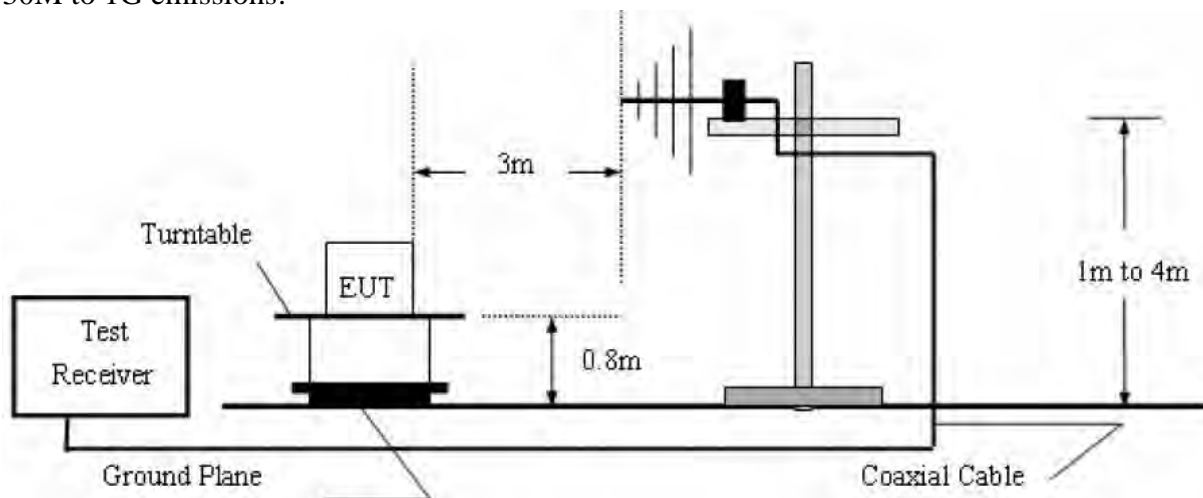

1G to 40G emissions:

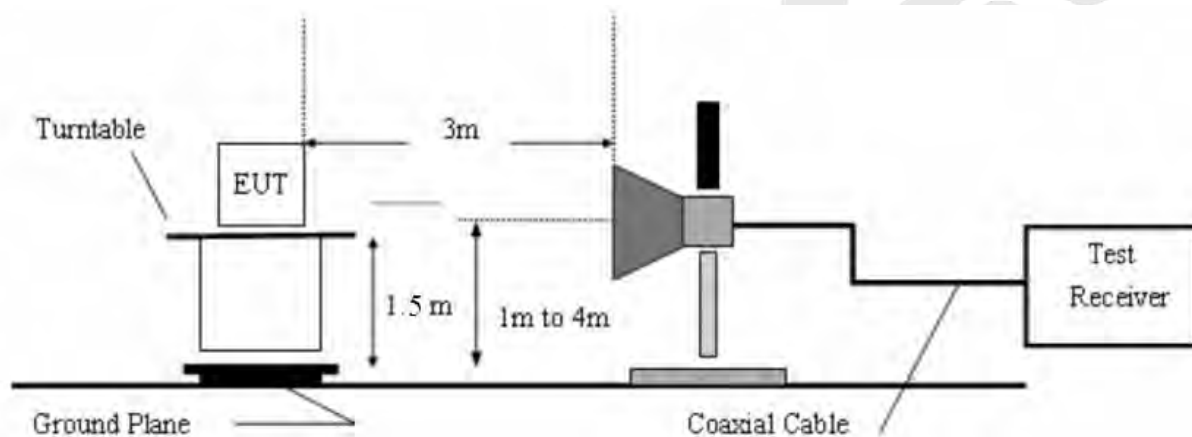

**c. Test Equipment**

Same as the equipment listed in 4.2.

**d. Test Results**

Pass.

**e. Test Plots**

See the following page.

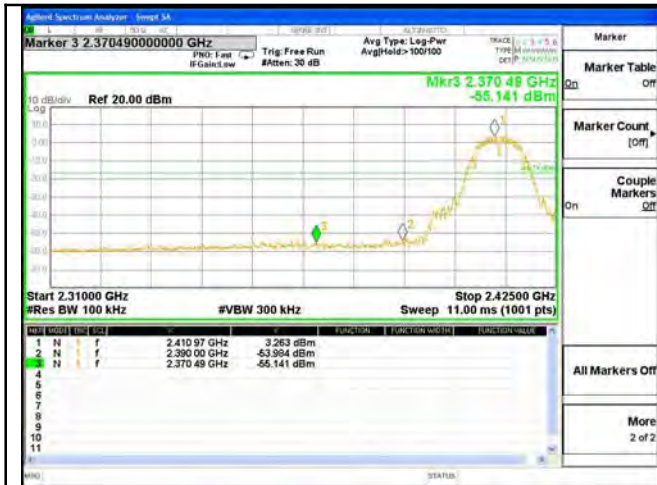

Test Mode: 802.11b---Low



Test Mode: 802.11b---High



Test Mode: 802.11g---Low



Test Mode: 802.11g---High



Test Mode: 802.11n20---Low



Test Mode: 802.11n20---High



Test Mode: 802.11n40---Low



Test Mode: 802.11n40---High

Anbotek

Test Mode: 802.11b  
2412MHz  
Horizontal-PEAK:

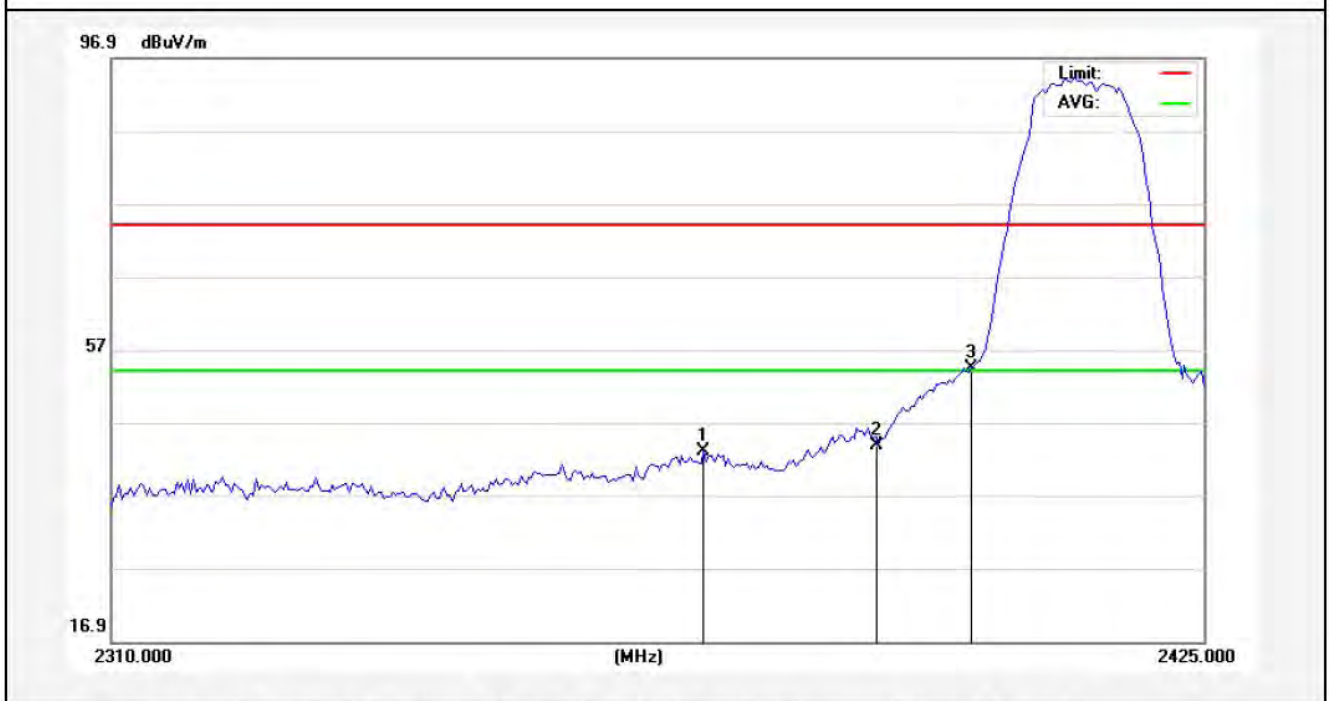

No.	Freq. (MHz)	Reading (dBuV/m)	Factor (dB/m)	Result (dBuV/m)	Limit (dBuV/)	Over Limit (dB)	Detector	Height (cm)	degree (deg)	Remark
1	2371.813	45.54	-2.55	42.99	74.00	-31.01	peak			
2	2390.000	46.38	-2.51	43.87	74.00	-30.13	peak			
3	2400.000	56.82	-2.49	54.33	74.00	-19.67	peak			

AMB

Horizontal-AV:

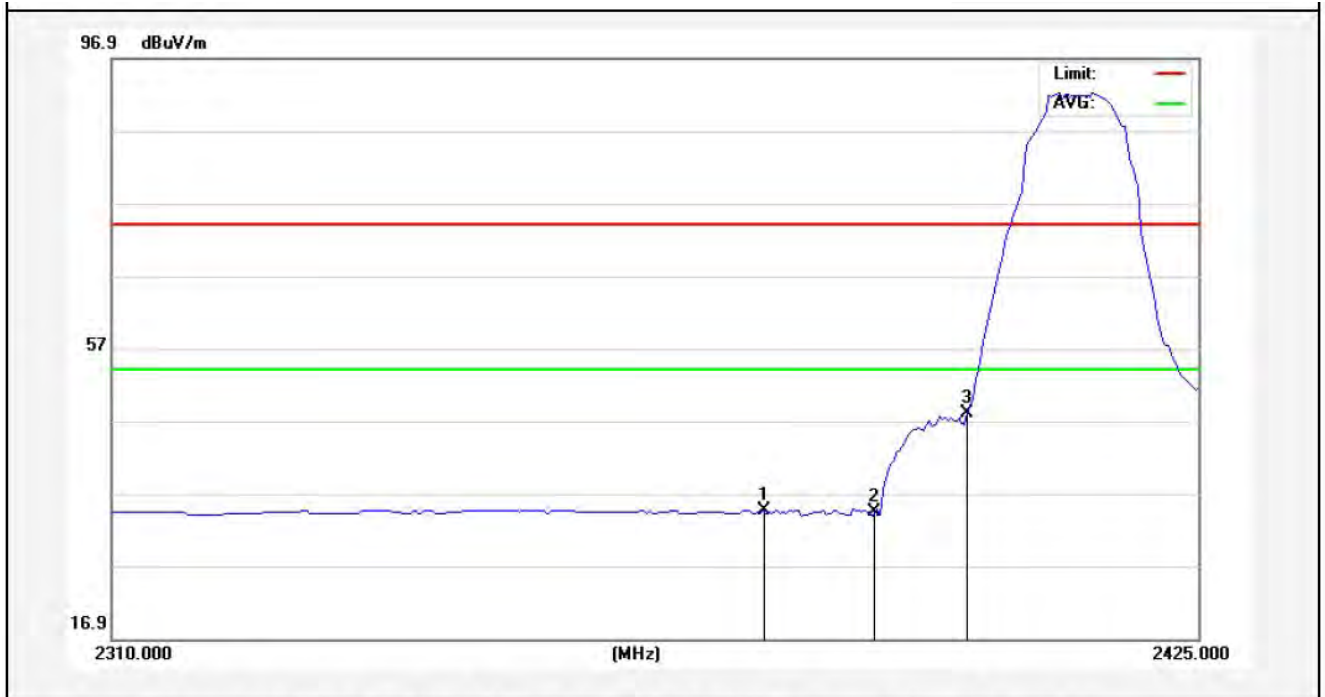

No.	Freq. (MHz)	Reading (dBuV/m)	Factor (dB/m)	Result (dBuV/m)	Limit (dBuV/)	Over Limit (dB)	Detector	Height (cm)	degree (deg)	Remark
1	2378.425	37.15	-2.54	34.61	54.00	-19.39	AVG			
2	2390.000	36.95	-2.51	34.44	54.00	-19.56	AVG			
3	2400.000	50.43	-2.49	47.94	54.00	-6.06	AVG			

Anbotek

Test Mode: 802.11b  
2412MHz  
Vertical-PEAK:

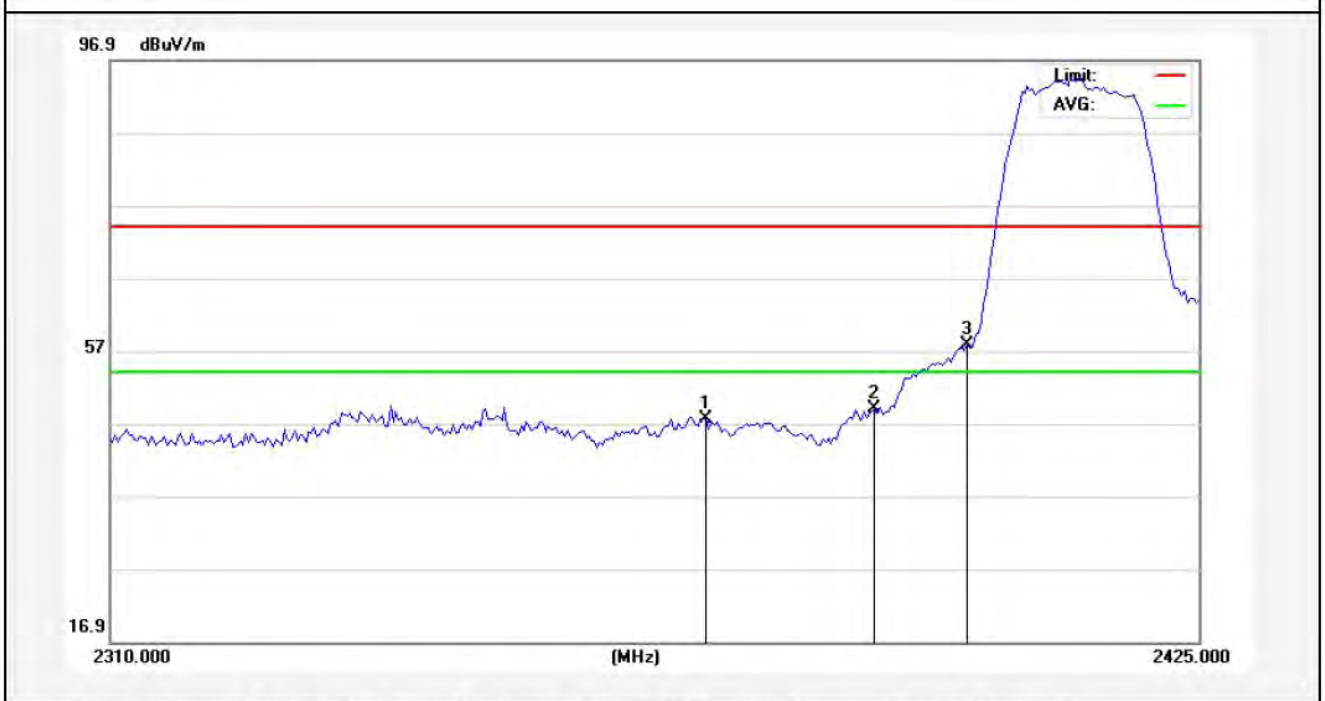

No.	Freq. (MHz)	Reading (dBuV/m)	Factor (dB/m)	Result (dBuV/m)	Limit (dBuV/)	Over Limit (dB)	Detector	Height (cm)	degree (deg)	Remark
1	2372.387	50.21	-2.55	47.66	74.00	-26.34	peak			
2	2390.000	51.61	-2.51	49.10	74.00	-24.90	peak			
3	2400.000	60.31	-2.49	57.82	74.00	-16.18	peak			

AMB



Vertical-AV:

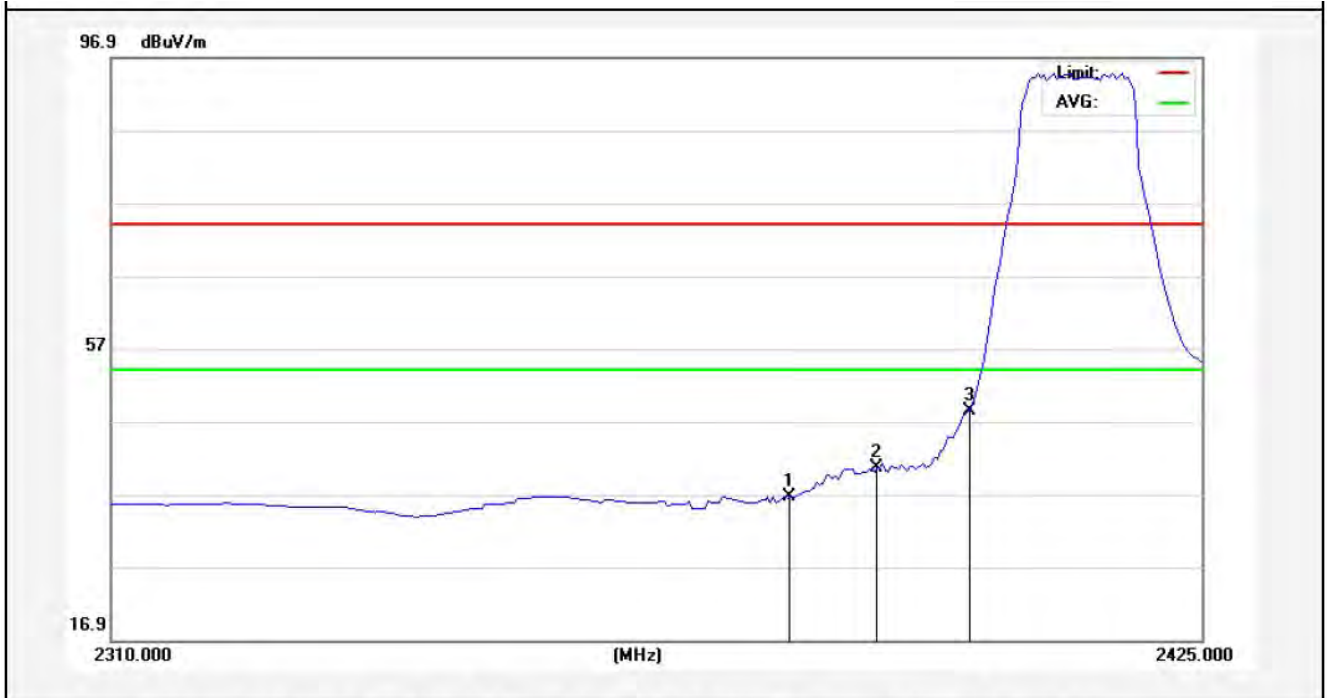

No.	Freq. (MHz)	Reading (dBuV/m)	Factor (dB/m)	Result (dBuV/m)	Limit (dBuV/)	Over Limit (dB)	Detector	Height (cm)	degree (deg)	Remark
1	2381.012	39.15	-2.53	36.62	54.00	-17.38	AVG			
2	2390.000	43.14	-2.51	40.63	54.00	-13.37	AVG			
3	2400.000	50.96	-2.49	48.47	54.00	-5.53	AVG			

Anbotek

Test Mode: 802.11b  
2462MHz  
Horizontal-PEAK:

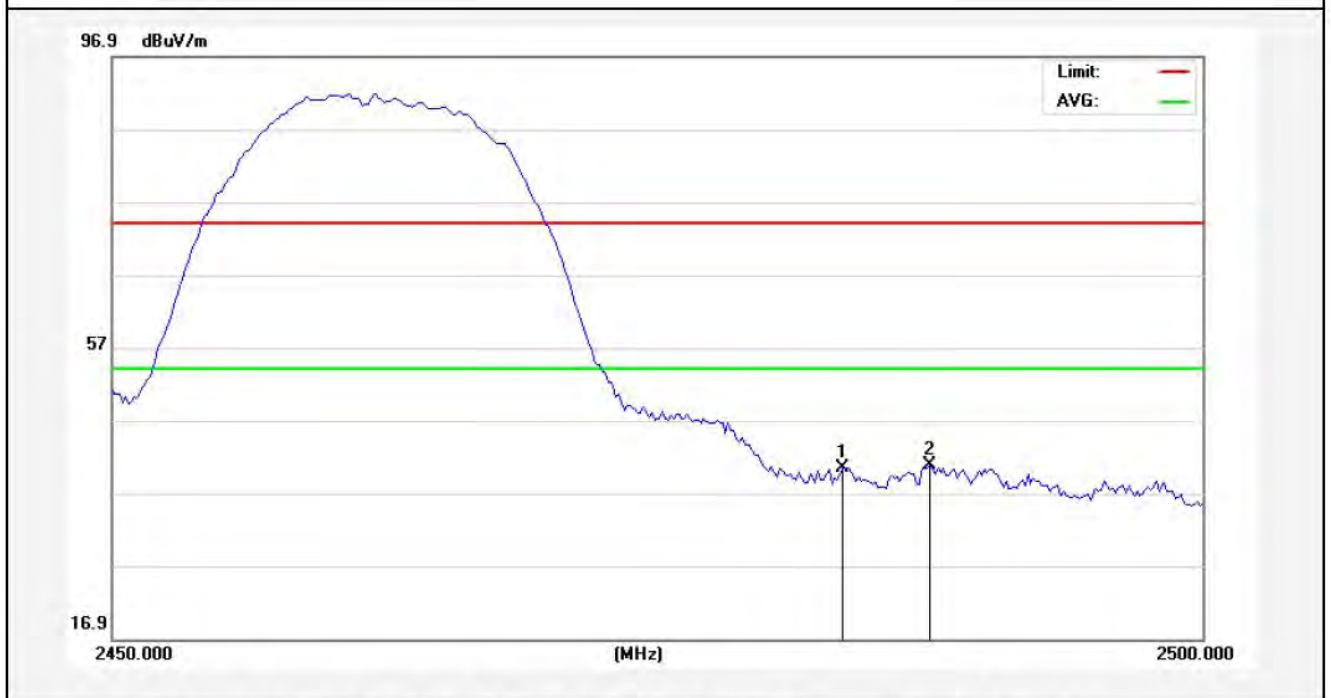

No.	Freq. (MHz)	Reading (dBuV/m)	Factor (dB/m)	Result (dBuV/m)	Limit (dBuV/)	Over Limit (dB)	Detector	Height (cm)	degree (deg)	Remark
1	2483.500	42.80	-2.31	40.49	74.00	-33.51	peak			
2	2487.500	43.03	-2.30	40.73	74.00	-33.27	peak			

Anbotek

Horizontal-AV:



No.	Freq. (MHz)	Reading (dBuV/m)	Factor (dB/m)	Result (dBuV/m)	Limit (dBuV/)	Over Limit (dB)	Detector	Height (cm)	degree (deg)	Remark
1	2483.500	37.26	-2.31	34.95	54.00	-19.05	AVG			
2	2485.875	36.77	-2.30	34.47	54.00	-19.53	AVG			

Anbotek

Test Mode: 802.11b  
2462MHz  
Vertical-PEAK:



No.	Freq. (MHz)	Reading (dBuV/m)	Factor (dB/m)	Result (dBuV/m)	Limit (dBuV/)	Over Limit (dB)	Detector	Height (cm)	degree (deg)	Remark
1	2483.500	44.53	-2.31	42.22	74.00	-31.78	peak			
2	2486.750	44.35	-2.30	42.05	74.00	-31.95	peak			

Anbotek

Vertical-AV:

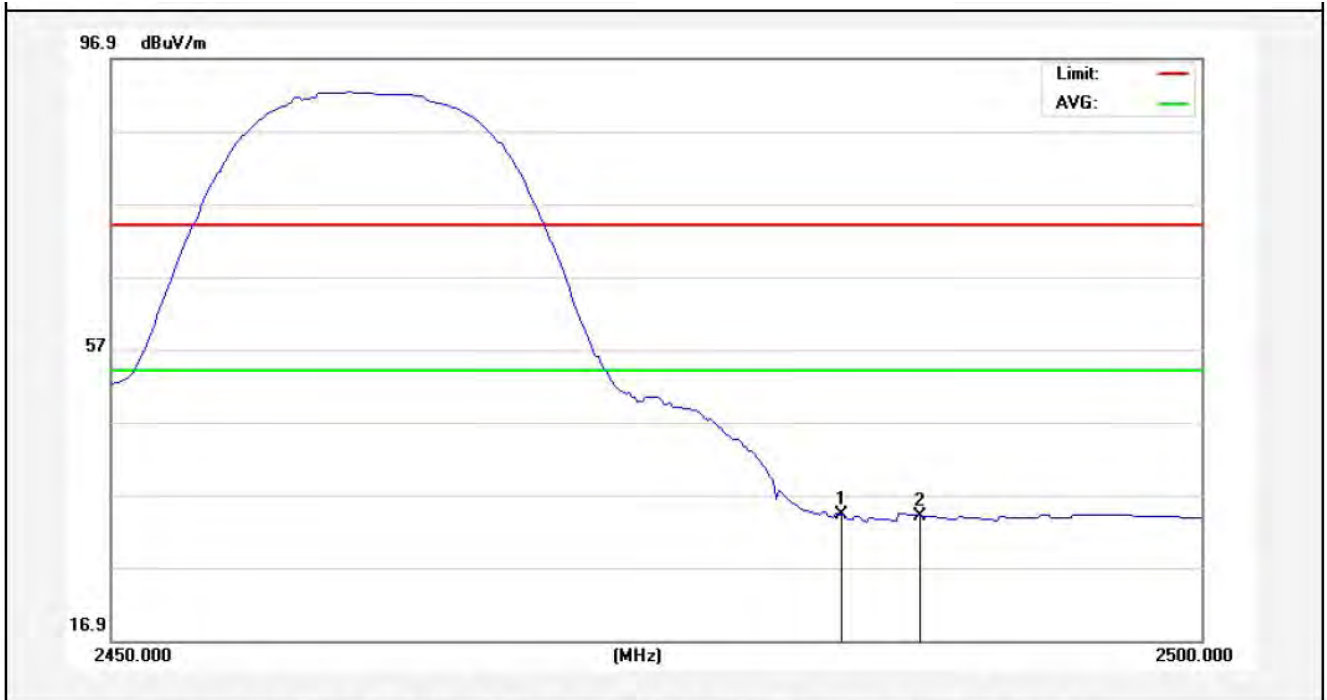

No.	Freq. (MHz)	Reading (dBuV/m)	Factor (dB/m)	Result (dBuV/m)	Limit (dBuV/)	Over Limit (dB)	Detector	Height (cm)	degree (deg)	Remark
1	2483.500	36.58	-2.31	34.27	54.00	-19.73	AVG			
2	2487.125	36.39	-2.30	34.09	54.00	-19.91	AVG			

Anbotek

Test Mode: 802.11g  
2412MHz  
Horizontal-PEAK:

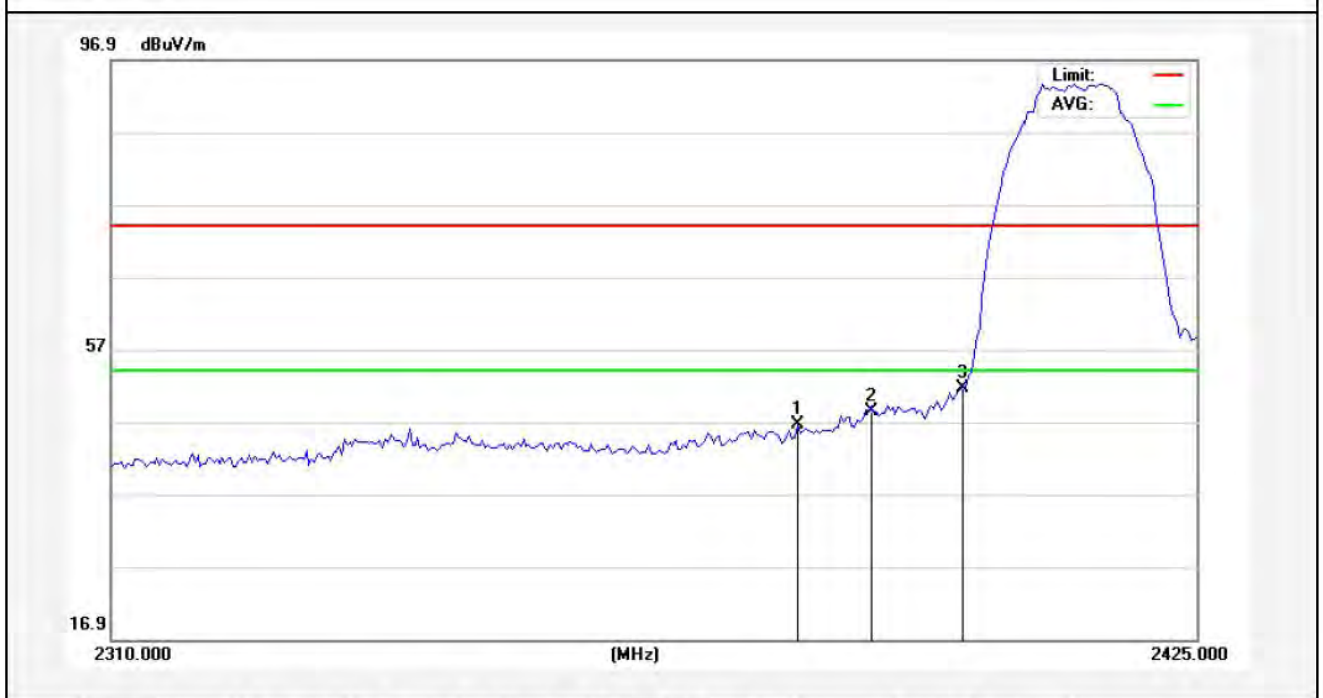

No.	Freq. (MHz)	Reading (dBuV/m)	Factor (dB/m)	Result (dBuV/m)	Limit (dBuV/)	Over Limit (dB)	Detector	Height (cm)	degree (deg)	Remark
1	2382.162	49.05	-2.53	46.52	74.00	-27.48	peak			
2	2390.000	50.86	-2.51	48.35	74.00	-25.65	peak			
3	2400.000	54.16	-2.49	51.67	74.00	-22.33	peak			

AMB

Horizontal-AV:

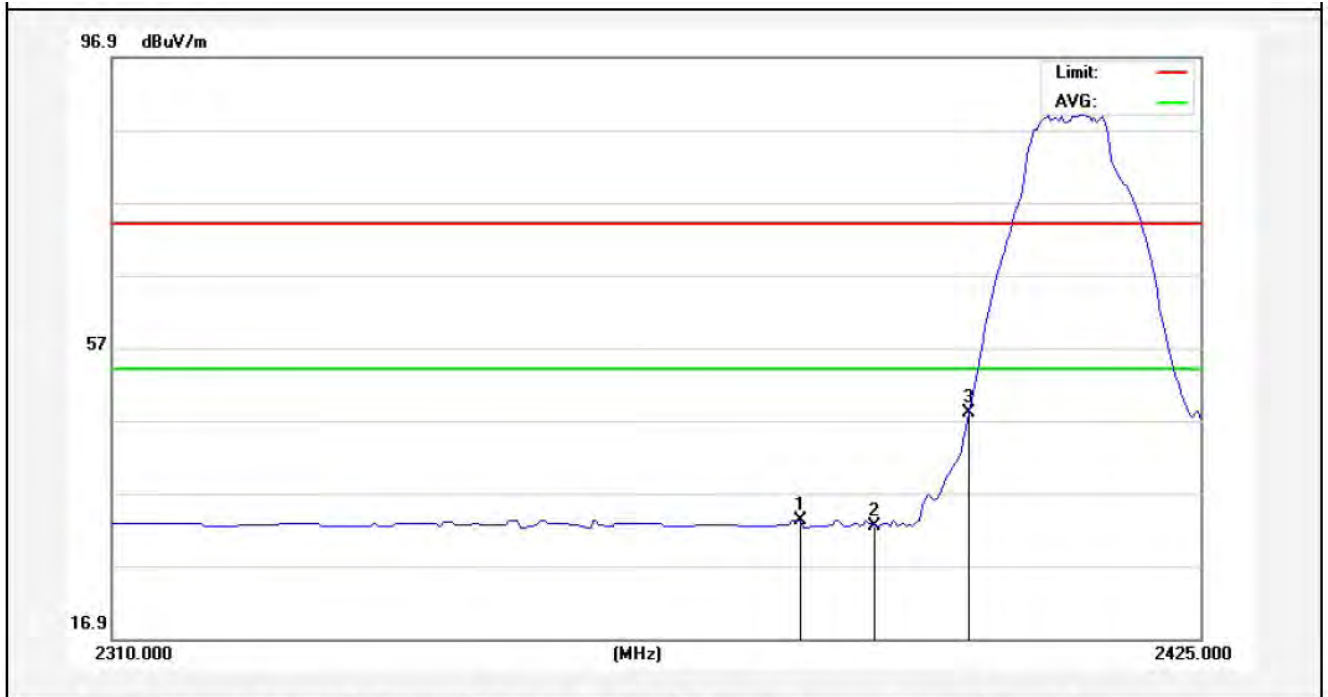

No.	Freq. (MHz)	Reading (dBuV/m)	Factor (dB/m)	Result (dBuV/m)	Limit (dBuV/)	Over Limit (dB)	Detector	Height (cm)	degree (deg)	Remark
1	2382.162	35.72	-2.53	33.19	54.00	-20.81	AVG			
2	2390.000	34.93	-2.51	32.42	54.00	-21.58	AVG			
3	2400.000	50.41	-2.49	47.92	54.00	-6.08	AVG			

Anbotek

Test Mode: 802.11g  
2412MHz  
Vertical-PEAK:

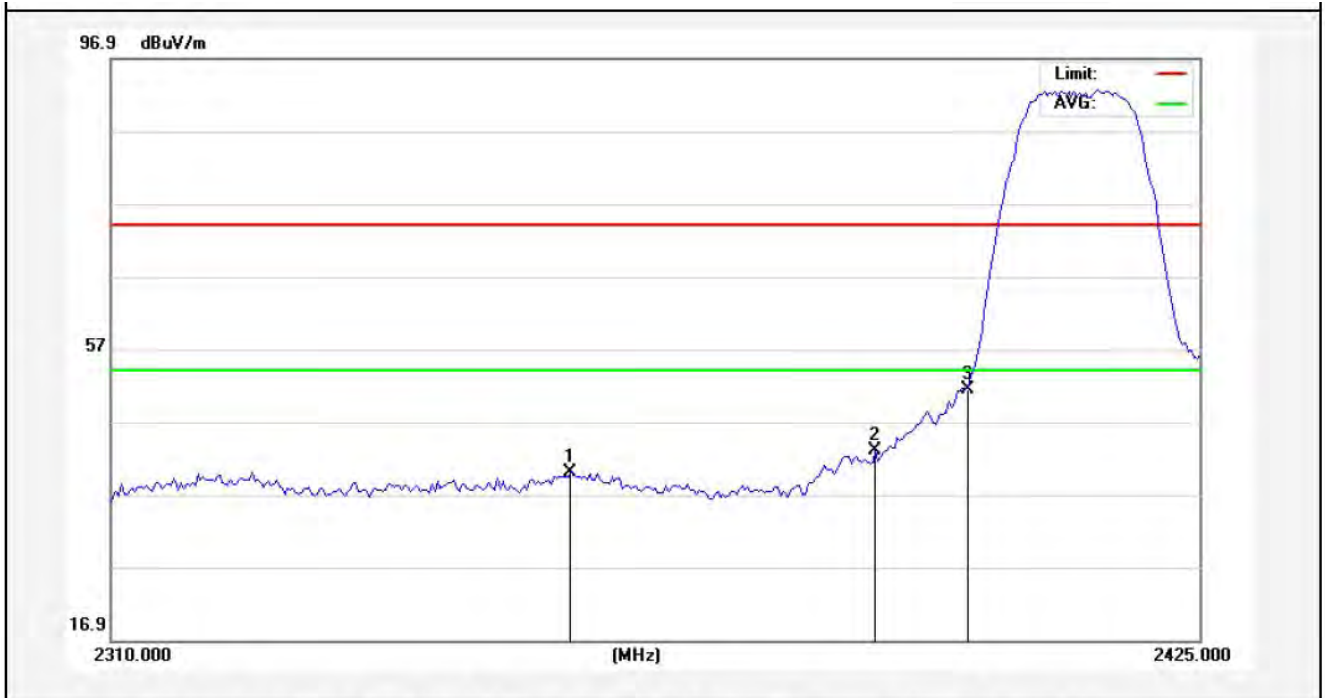

No.	Freq. (MHz)	Reading (dBuV/m)	Factor (dB/m)	Result (dBuV/m)	Limit (dBuV/)	Over Limit (dB)	Detector	Height (cm)	degree (deg)	Remark
1	2358.012	42.53	-2.59	39.94	74.00	-34.06	peak			
2	2390.000	45.55	-2.51	43.04	74.00	-30.96	peak			
3	2400.000	53.99	-2.49	51.50	74.00	-22.50	peak			

AMB



Vertical-AV:

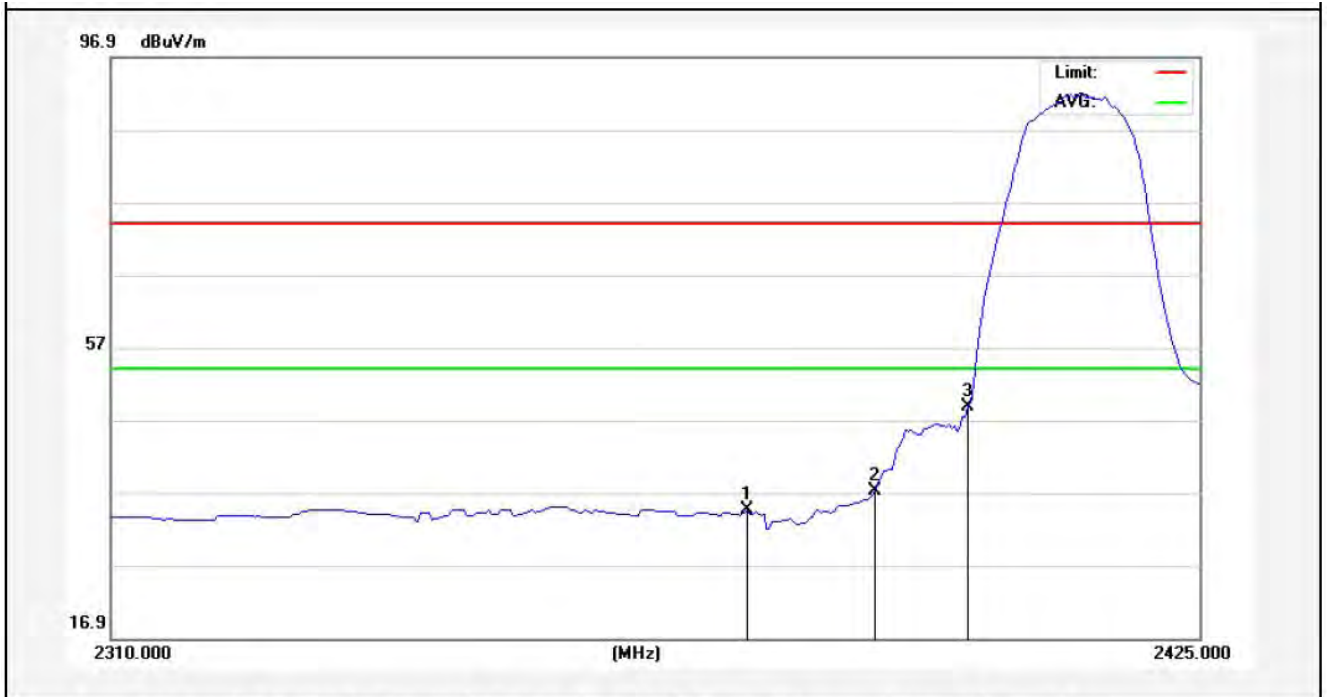

No.	Freq. (MHz)	Reading (dBuV/m)	Factor (dB/m)	Result (dBuV/m)	Limit (dBuV/)	Over Limit (dB)	Detector	Height (cm)	degree (deg)	Remark
1	2376.700	37.14	-2.54	34.60	54.00	-19.40	AVG			
2	2390.000	39.68	-2.51	37.17	54.00	-16.83	AVG			
3	2400.000	51.29	-2.49	48.80	54.00	-5.20	AVG			

Test Mode: 802.11g  
2462MHz  
Horizontal-PEAK:

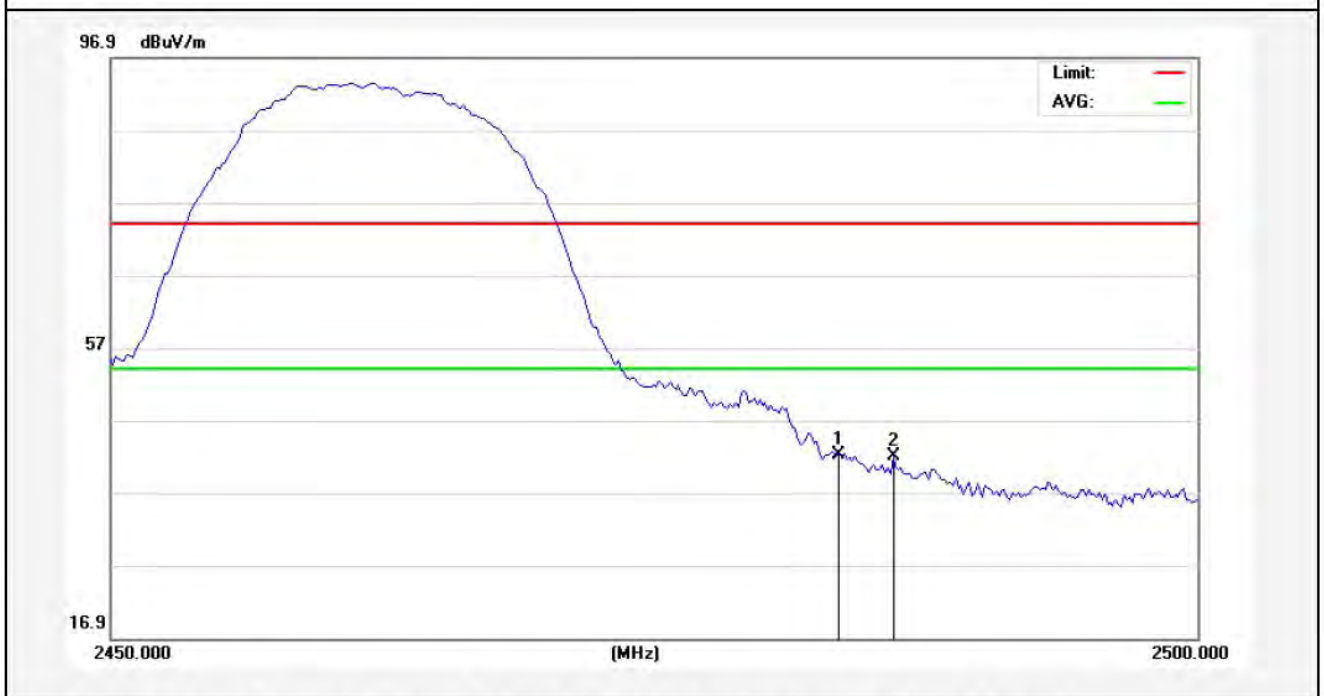

No.	Freq. (MHz)	Reading (dBuV/m)	Factor (dB/m)	Result (dBuV/m)	Limit (dBuV/)	Over Limit (dB)	Detector	Height (cm)	degree (deg)	Remark
1	2483.500	44.44	-2.31	42.13	74.00	-31.87	peak			
2	2486.000	44.31	-2.30	42.01	74.00	-31.99	peak			

Anbotek

Horizontal-AV:

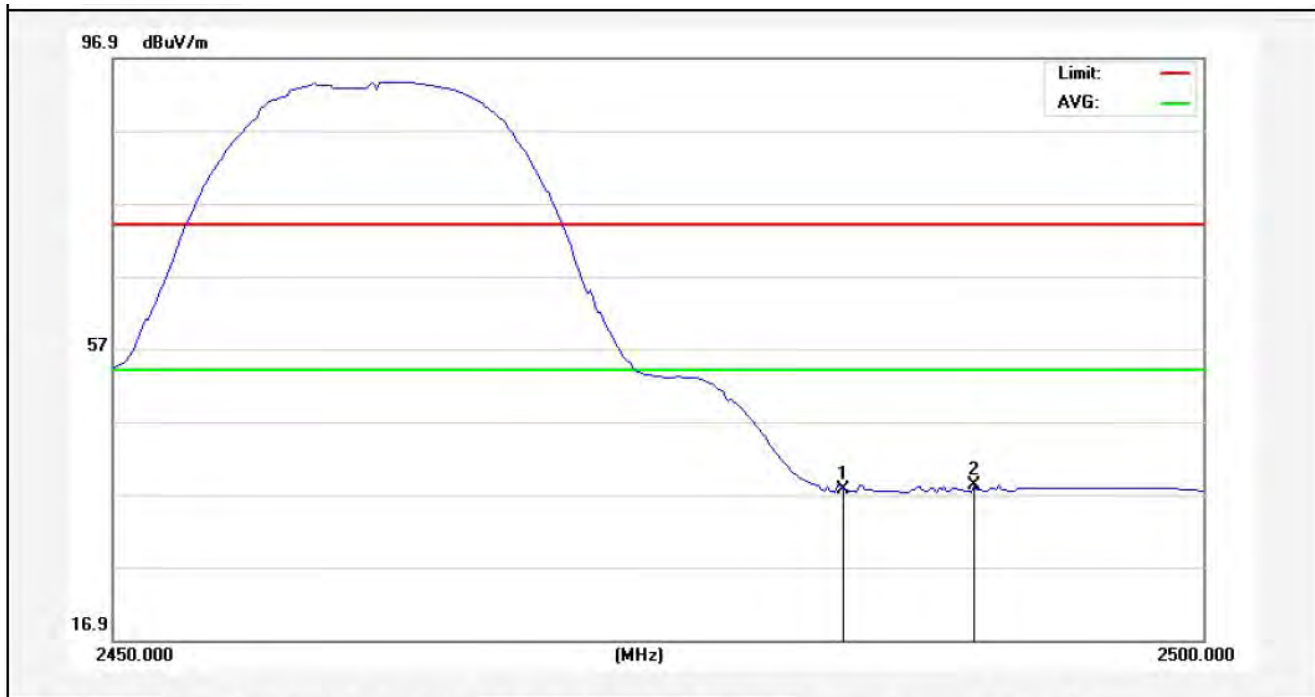

No.	Freq. (MHz)	Reading (dBuV/m)	Factor (dB/m)	Result (dBuV/m)	Limit (dBuV/)	Over Limit (dB)	Detector	Height (cm)	degree (deg)	Remark
1	2483.500	39.88	-2.31	37.57	54.00	-16.43	AVG			
2	2489.500	40.45	-2.29	38.16	54.00	-15.84	AVG			

Anbotek

Test Mode: 802.11g  
2462MHz  
Vertical-PEAK:

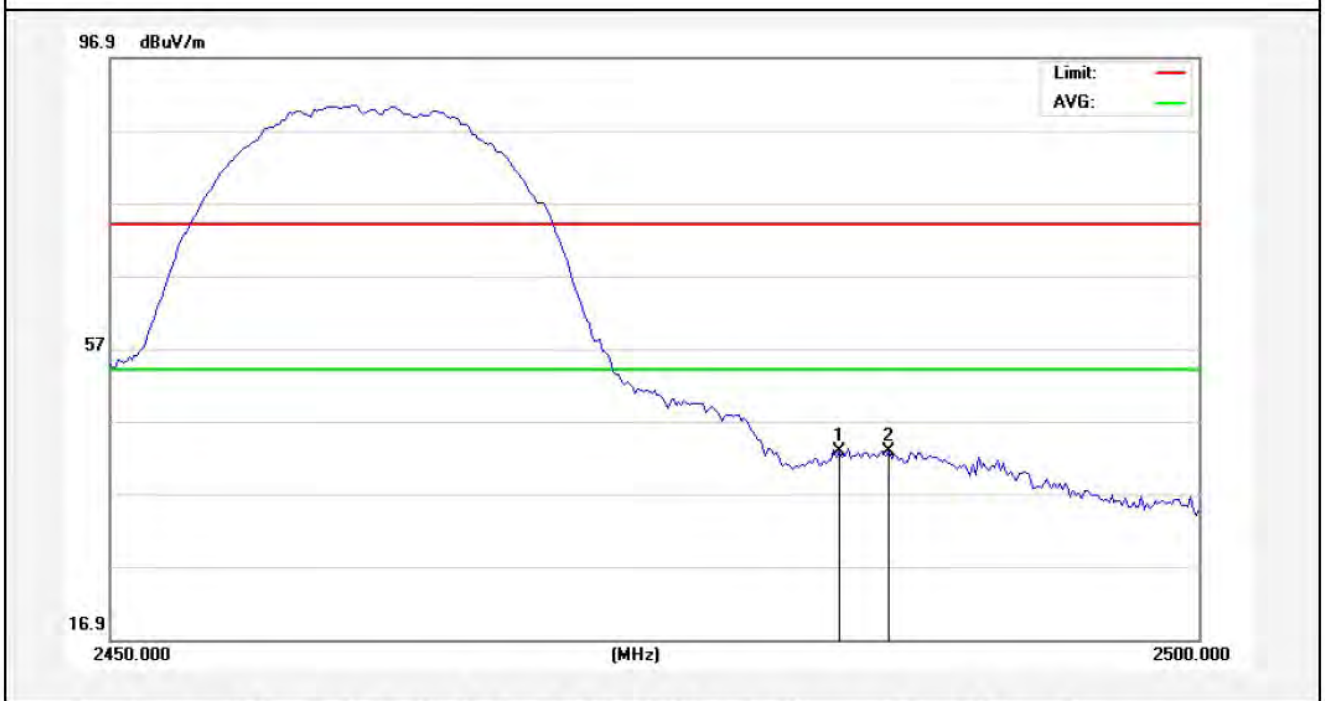

No.	Freq. (MHz)	Reading (dBuV/m)	Factor (dB/m)	Result (dBuV/m)	Limit (dBuV/)	Over Limit (dB)	Detector	Height (cm)	degree (deg)	Remark
1	2483.500	45.07	-2.31	42.76	74.00	-31.24	peak			
2	2485.750	45.10	-2.30	42.80	74.00	-31.20	peak			

Anbotek

Vertical-AV:

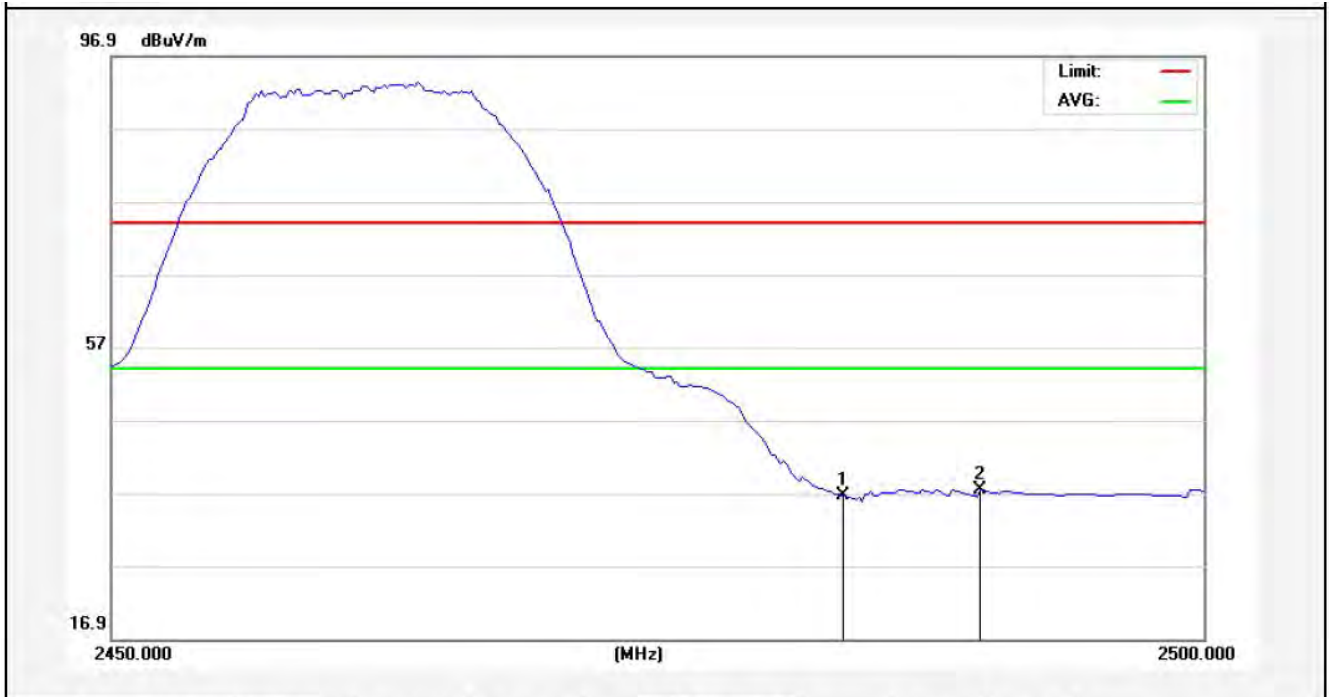

No.	Freq. (MHz)	Reading (dBuV/m)	Factor (dB/m)	Result (dBuV/m)	Limit (dBuV/)	Over Limit (dB)	Detector	Height (cm)	degree (deg)	Remark
1	2483.500	38.88	-2.31	36.57	54.00	-17.43	AVG			
2	2489.750	39.68	-2.29	37.39	54.00	-16.61	AVG			

Anbotek

Test Mode: 802.11n (HT20)  
2412MHz  
Horizontal-PEAK:

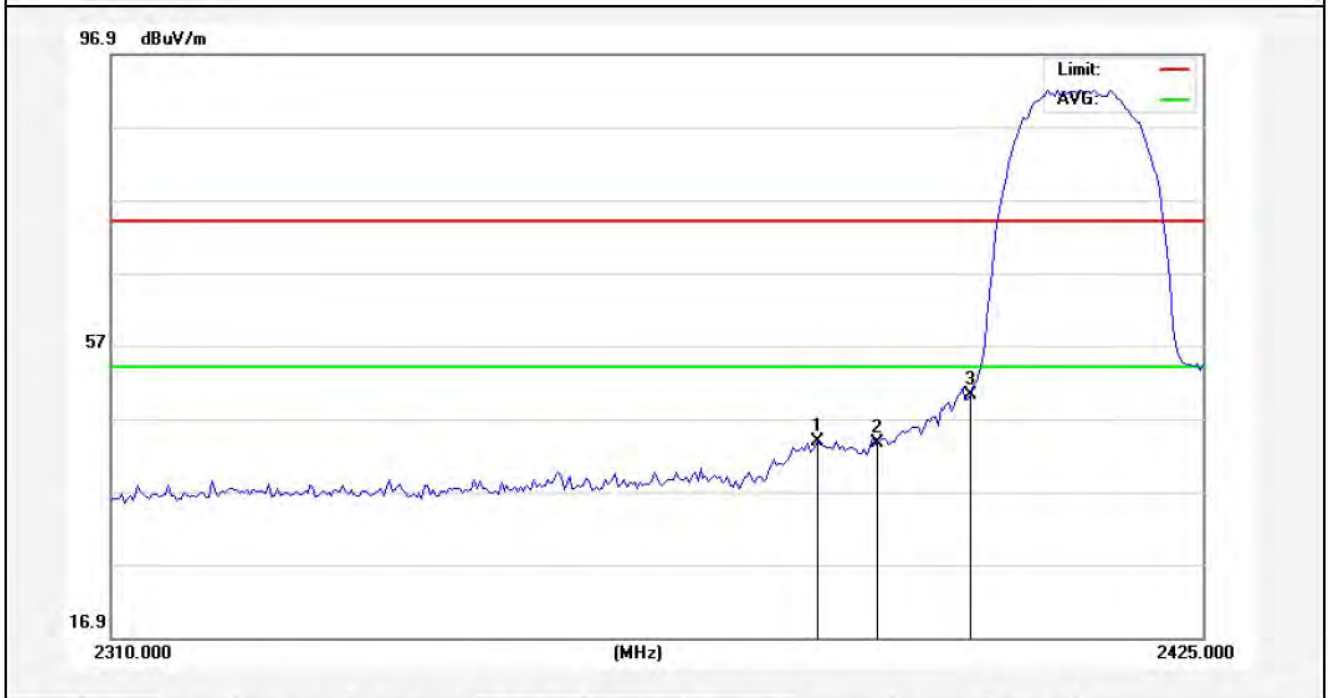

No.	Freq. (MHz)	Reading (dBuV/m)	Factor (dB/m)	Result (dBuV/m)	Limit (dBuV/)	Over Limit (dB)	Detector	Height (cm)	degree (deg)	Remark
1	2383.887	46.29	-2.53	43.76	74.00	-30.24	peak			
2	2390.000	46.13	-2.51	43.62	74.00	-30.38	peak			
3	2400.000	52.75	-2.49	50.26	74.00	-23.74	peak			

AMB

Horizontal-AV:

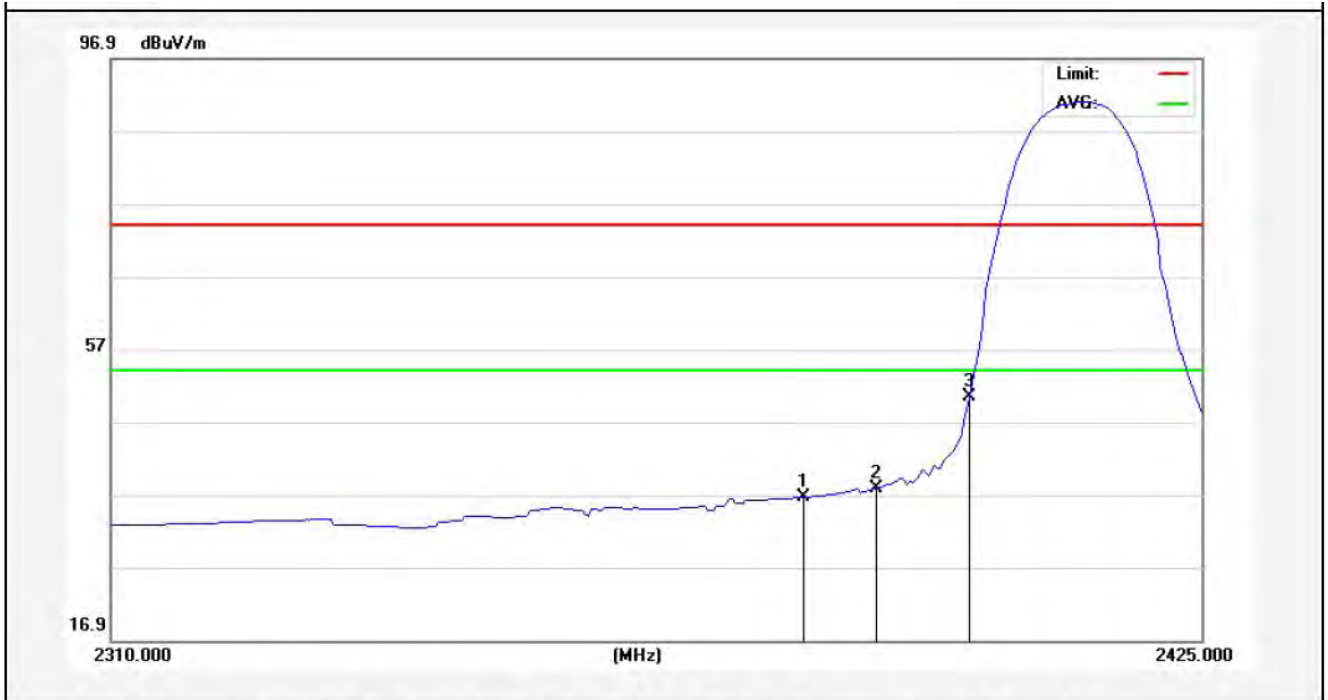

No.	Freq. (MHz)	Reading (dBuV/m)	Factor (dB/m)	Result (dBuV/m)	Limit (dBuV/)	Over Limit (dB)	Detector	Height (cm)	degree (deg)	Remark
1	2382.450	39.15	-2.53	36.62	54.00	-17.38	AVG			
2	2390.000	40.33	-2.51	37.82	54.00	-16.18	AVG			
3	2400.000	52.89	-2.49	50.40	54.00	-3.60	AVG			

Anbotek

Test Mode: 802.11n (HT20)  
2412MHz  
Vertical-PEAK:

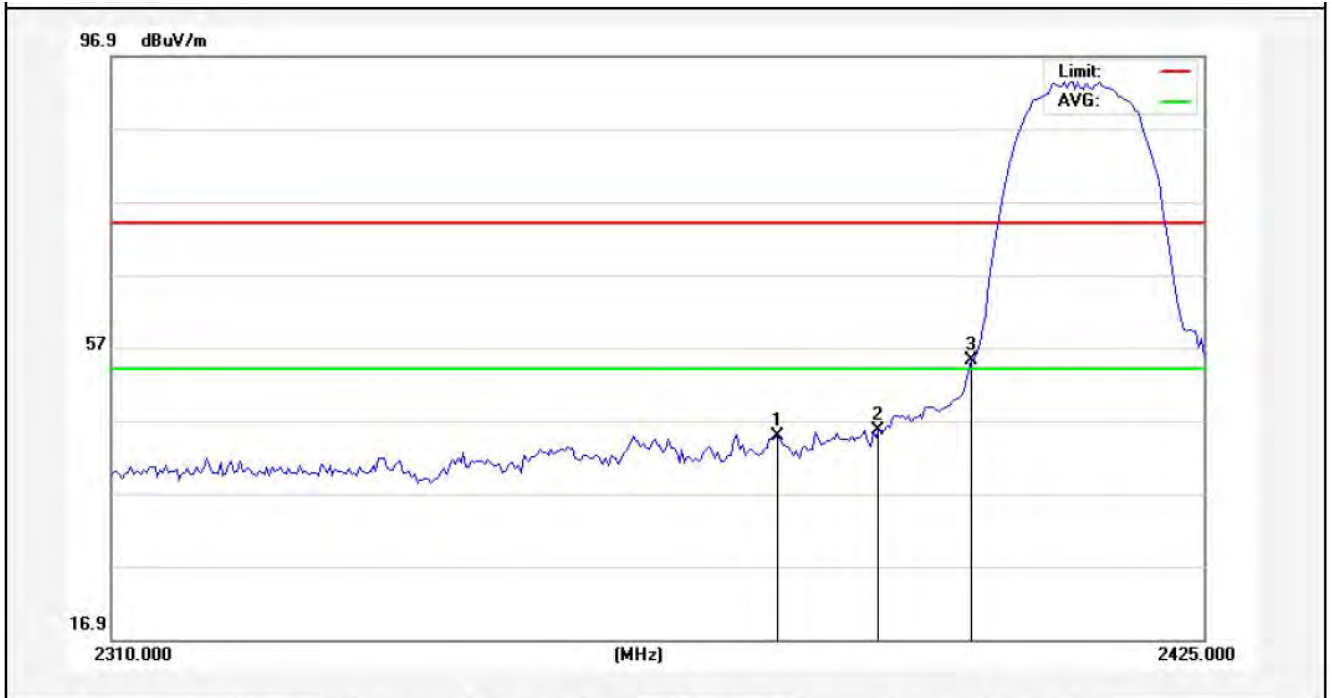

No.	Freq. (MHz)	Reading (dBuV/m)	Factor (dB/m)	Result (dBuV/m)	Limit (dBuV/)	Over Limit (dB)	Detector	Height (cm)	degree (deg)	Remark
1	2379.575	47.35	-2.54	44.81	74.00	-29.19	peak			
2	2390.000	48.13	-2.51	45.62	74.00	-28.38	peak			
3	2400.000	57.73	-2.49	55.24	74.00	-18.76	peak			

AMB



Vertical-AV:

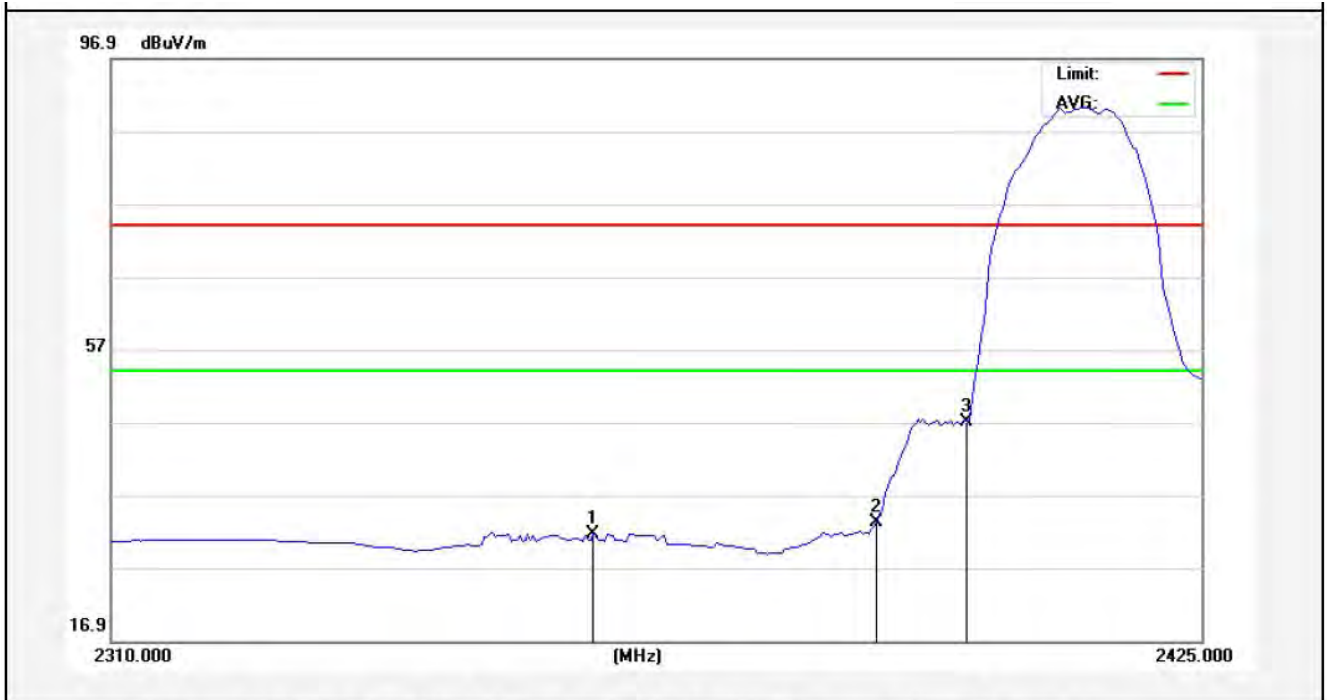

No.	Freq. (MHz)	Reading (dBuV/m)	Factor (dB/m)	Result (dBuV/m)	Limit (dBuV/)	Over Limit (dB)	Detector	Height (cm)	degree (deg)	Remark
1	2360.313	34.16	-2.58	31.58	54.00	-22.42	AVG			
2	2390.000	35.80	-2.51	33.29	54.00	-20.71	AVG			
3	2400.000	49.50	-2.49	47.01	54.00	-6.99	AVG			

Anbotek

Test Mode: 802.11n (HT20)  
2462MHz  
Horizontal-PEAK:

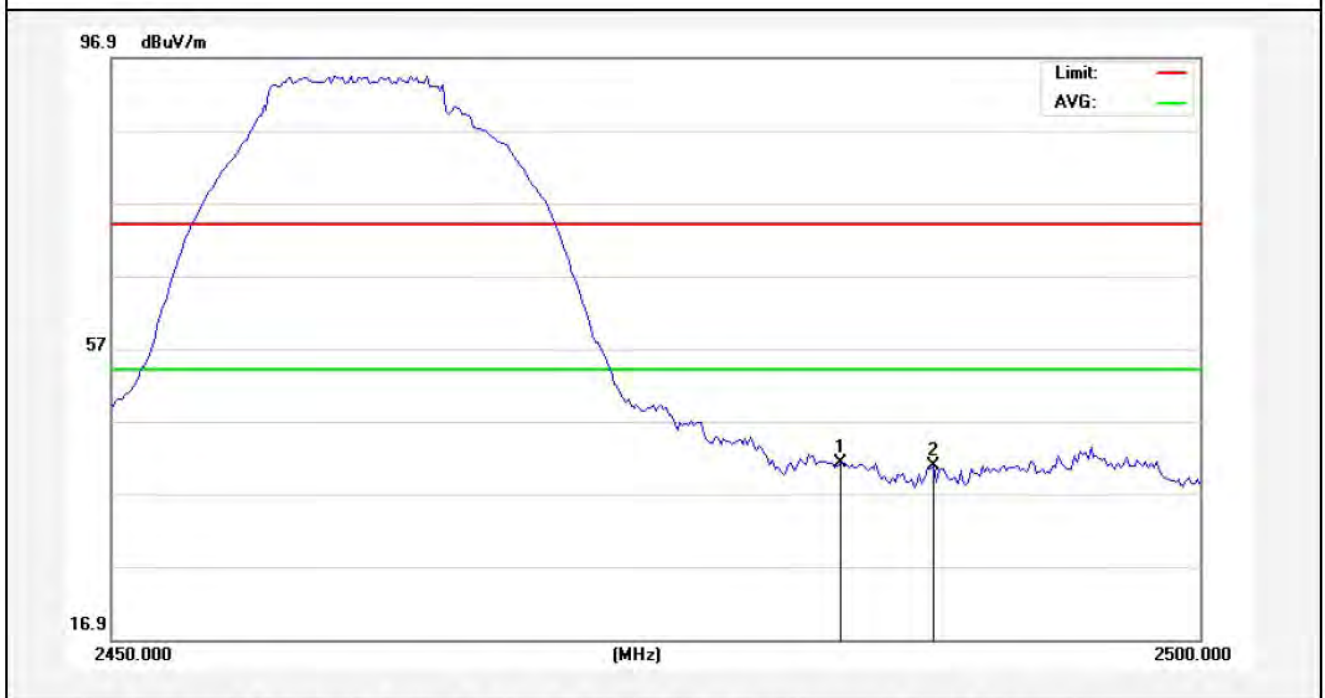

No.	Freq. (MHz)	Reading (dBuV/m)	Factor (dB/m)	Result (dBuV/m)	Limit (dBuV/)	Over Limit (dB)	Detector	Height (cm)	degree (deg)	Remark
1	2483.500	43.59	-2.31	41.28	74.00	-32.72	peak			
2	2487.750	43.15	-2.30	40.85	74.00	-33.15	peak			

Anbotek

Horizontal-AV:

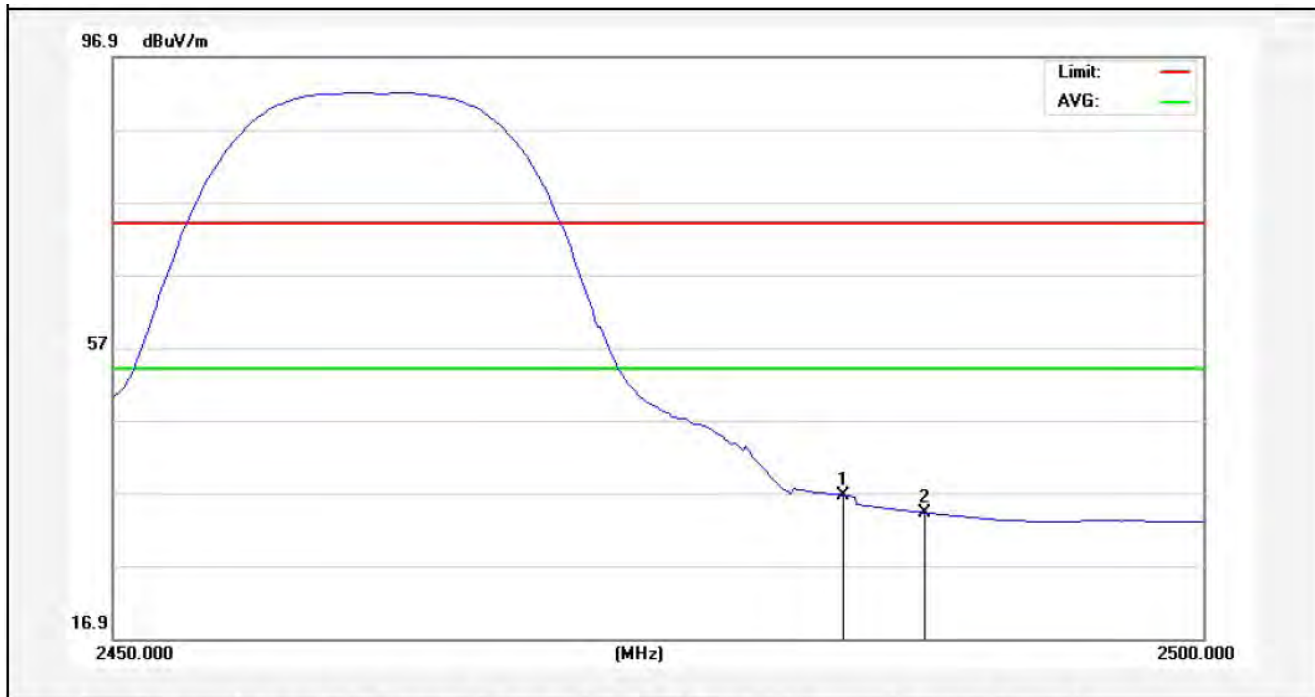

No.	Freq. (MHz)	Reading (dBuV/m)	Factor (dB/m)	Result (dBuV/m)	Limit (dBuV/)	Over Limit (dB)	Detector	Height (cm)	degree (deg)	Remark
1	2483.500	38.97	-2.31	36.66	54.00	-17.34	AVG			
2	2487.250	36.55	-2.30	34.25	54.00	-19.75	AVG			

Anbotek

Test Mode: 802.11n (HT20)  
2462MHz  
Vertical-PEAK:

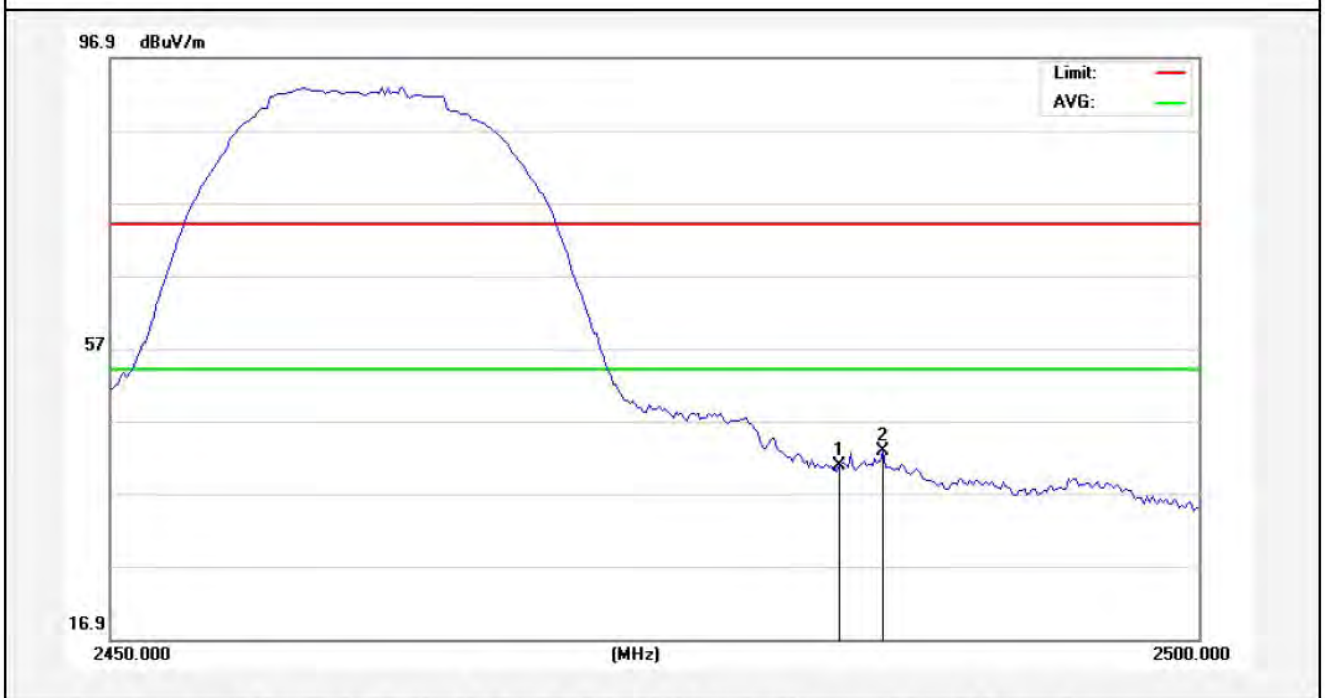

No.	Freq. (MHz)	Reading (dBuV/m)	Factor (dB/m)	Result (dBuV/m)	Limit (dBuV/)	Over Limit (dB)	Detector	Height (cm)	degree (deg)	Remark
1	2483.500	43.12	-2.31	40.81	74.00	-33.19	peak			
2	2485.500	45.16	-2.30	42.86	74.00	-31.14	peak			

Anbotek

Vertical-AV:

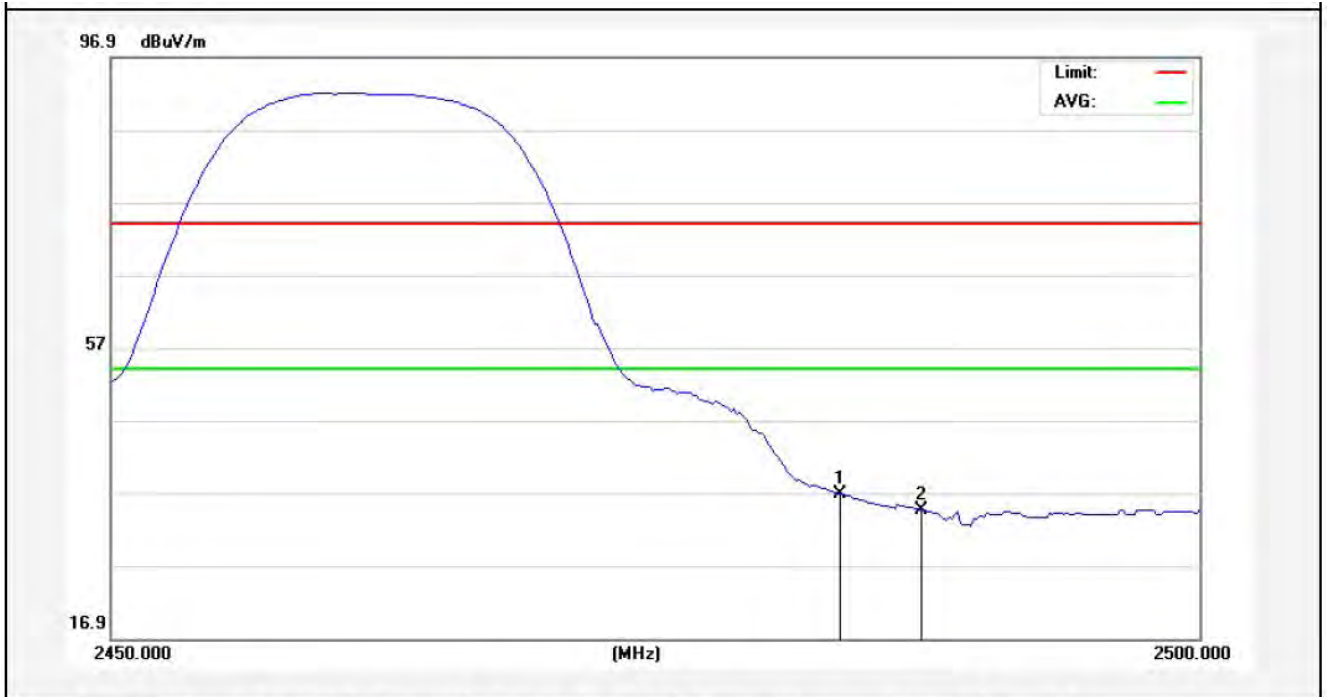

No.	Freq. (MHz)	Reading (dBuV/m)	Factor (dB/m)	Result (dBuV/m)	Limit (dBuV/)	Over Limit (dB)	Detector	Height (cm)	degree (deg)	Remark
1	2483.500	39.11	-2.31	36.80	54.00	-17.20	AVG			
2	2487.250	36.93	-2.30	34.63	54.00	-19.37	AVG			

Anbotek

Test Mode: 802.11n (HT40)  
2422MHz  
Horizontal-PEAK:

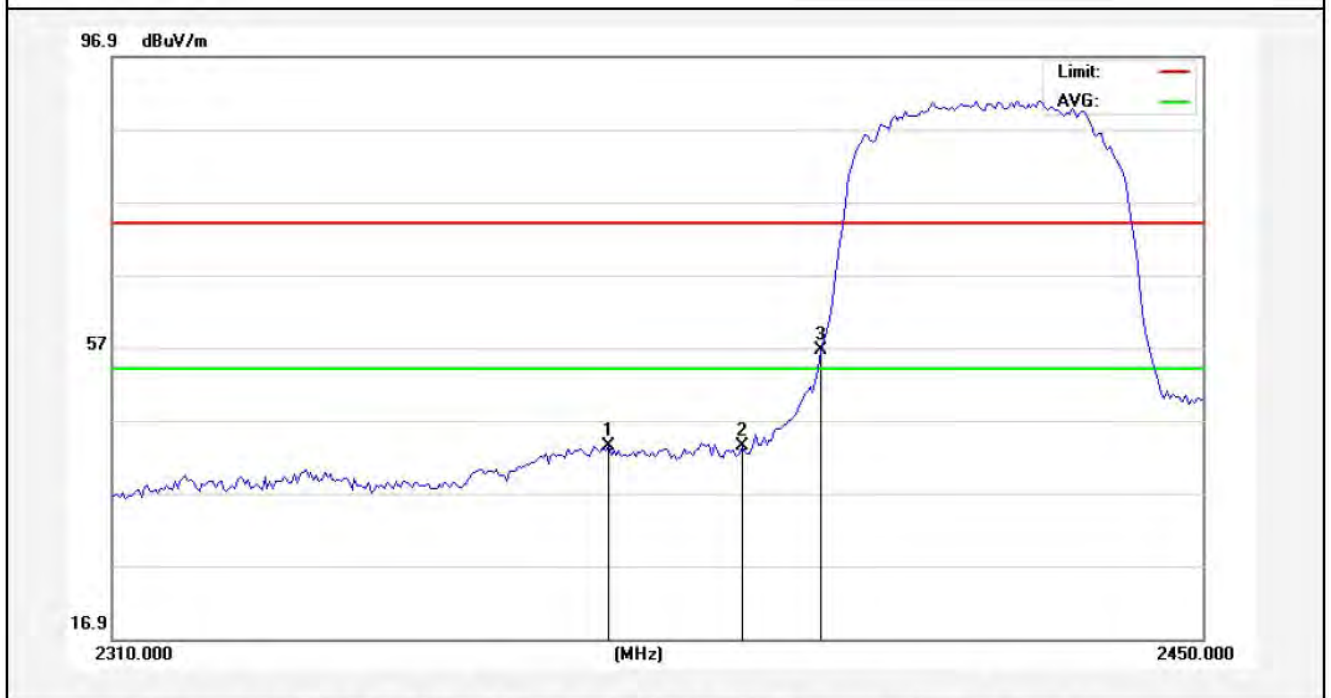

No.	Freq. (MHz)	Reading (dBuV/m)	Factor (dB/m)	Result (dBuV/m)	Limit (dBuV/)	Over Limit (dB)	Detector	Height (cm)	degree (deg)	Remark
1	2373.000	45.93	-2.55	43.38	74.00	-30.62	peak			
2	2390.000	46.01	-2.51	43.50	74.00	-30.50	peak			
3	2400.000	59.01	-2.49	56.52	74.00	-17.48	peak			

AMB

Horizontal-AV:

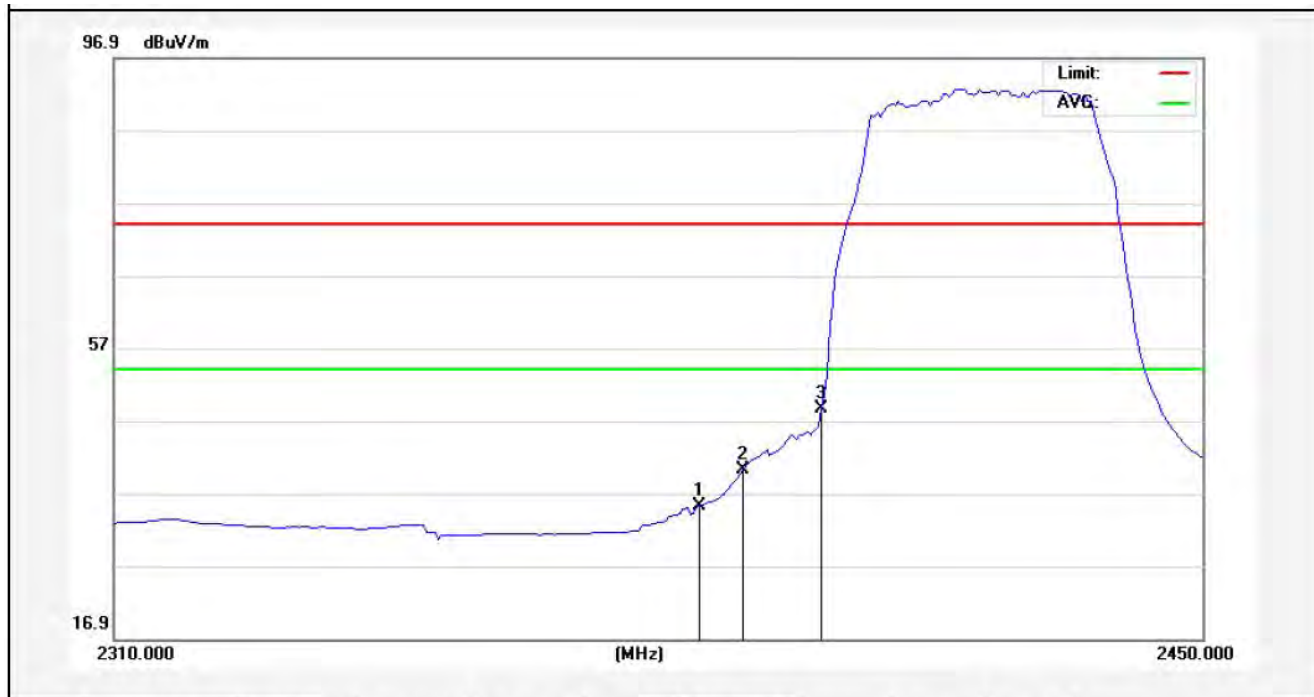

No.	Freq. (MHz)	Reading (dBuV/m)	Factor (dB/m)	Result (dBuV/m)	Limit (dBuV/)	Over Limit (dB)	Detector	Height (cm)	degree (deg)	Remark
1	2384.550	37.67	-2.53	35.14	54.00	-18.86	AVG			
2	2390.000	42.65	-2.51	40.14	54.00	-13.86	AVG			
3	2400.000	51.14	-2.49	48.65	54.00	-5.35	AVG			

Anbotek

Test Mode: 802.11n (HT40)  
2422MHz  
Vertical-PEAK:

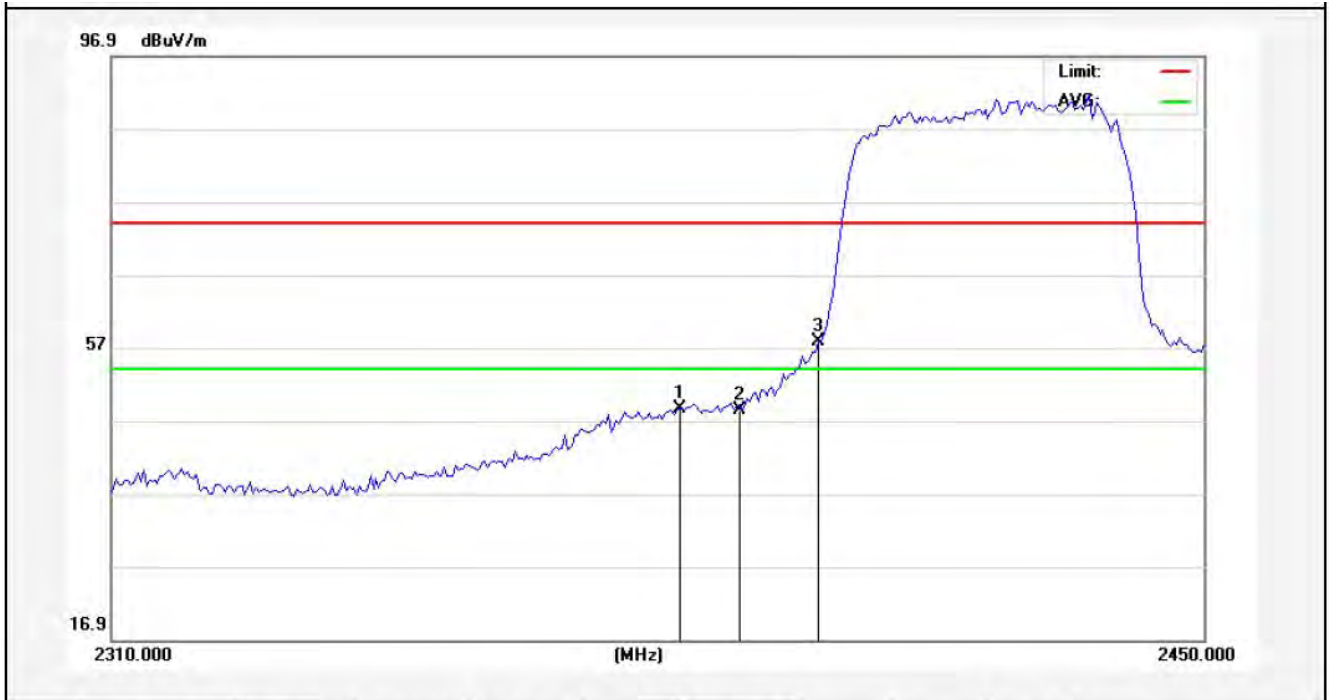

No.	Freq. (MHz)	Reading (dBuV/m)	Factor (dB/m)	Result (dBuV/m)	Limit (dBuV/)	Over Limit (dB)	Detector	Height (cm)	degree (deg)	Remark
1	2382.100	51.19	-2.53	48.66	74.00	-25.34	peak			
2	2390.000	50.96	-2.51	48.45	74.00	-25.55	peak			
3	2400.000	60.22	-2.49	57.73	74.00	-16.27	peak			

AMB



Vertical-AV:

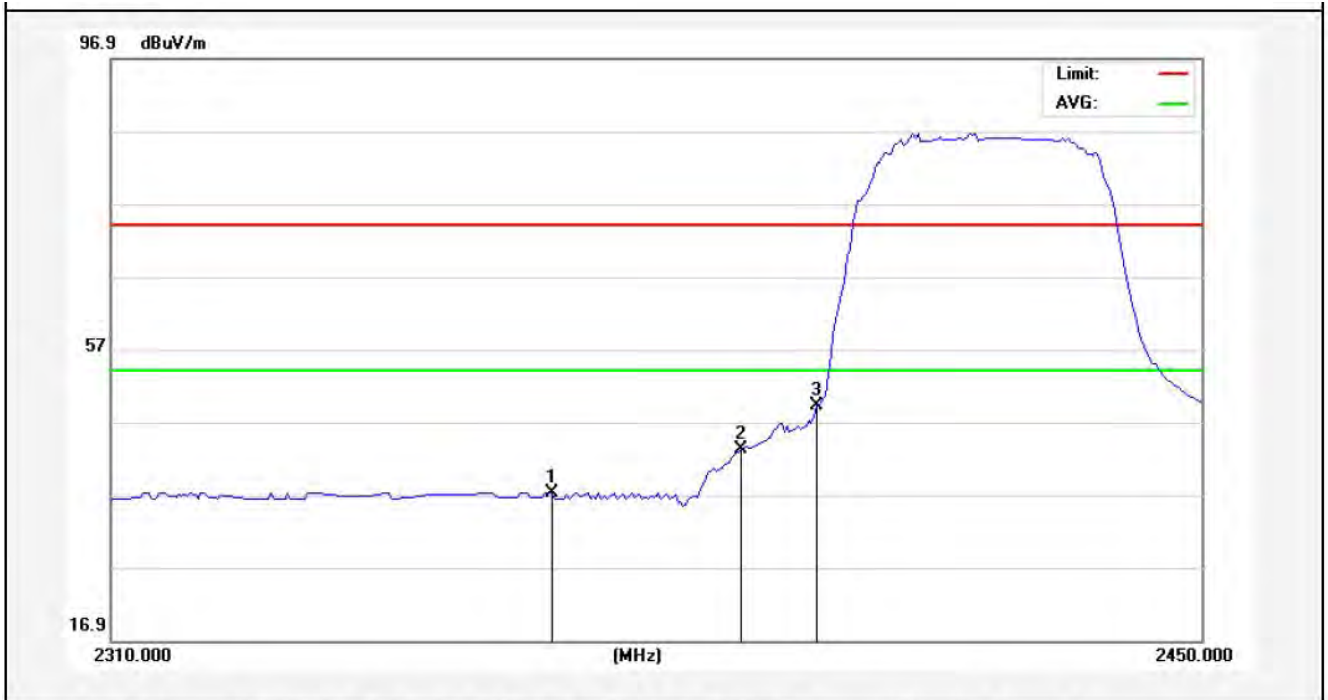

No.	Freq. (MHz)	Reading (dBuV/m)	Factor (dB/m)	Result (dBuV/m)	Limit (dBuV/)	Over Limit (dB)	Detector	Height (cm)	degree (deg)	Remark
1	2366.000	39.87	-2.57	37.30	54.00	-16.70	AVG			
2	2390.000	45.64	-2.51	43.13	54.00	-10.87	AVG			
3	2400.000	51.66	-2.49	49.17	54.00	-4.83	AVG			

Anbotek

Test Mode: 802.11n (HT40)  
2452MHz  
Horizontal-PEAK:

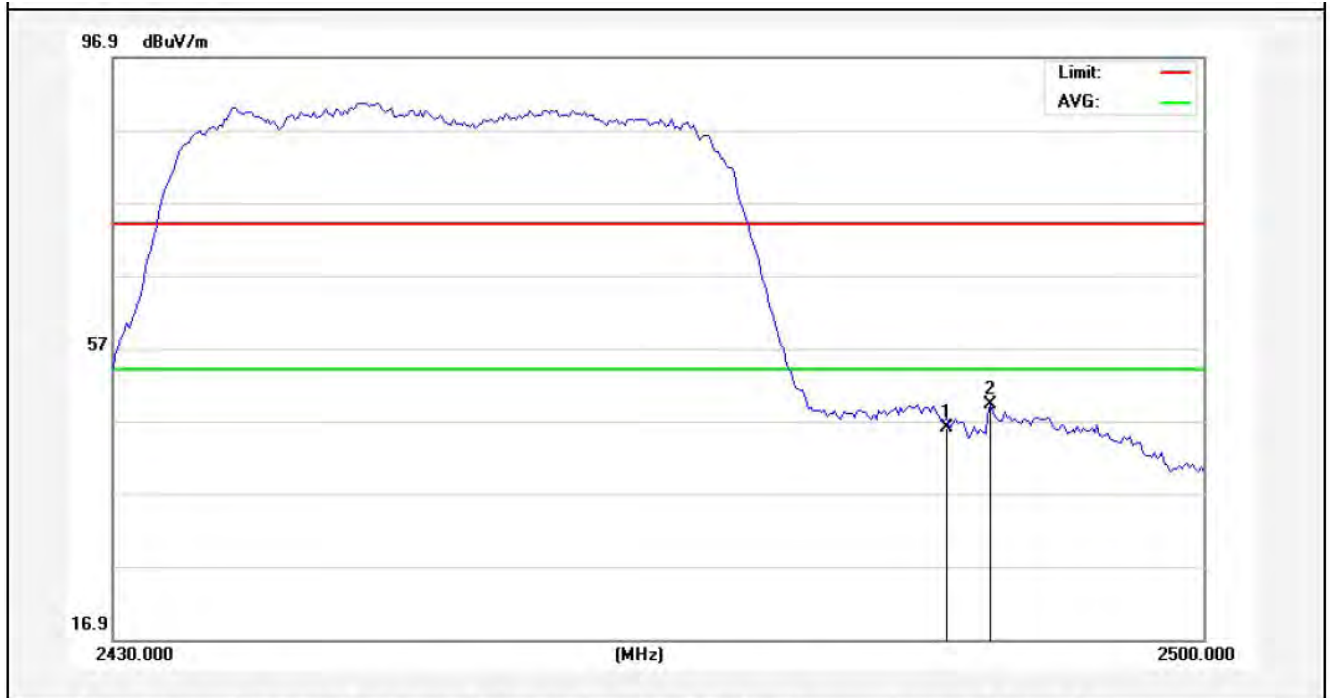

No.	Freq. (MHz)	Reading (dBuV/m)	Factor (dB/m)	Result (dBuV/m)	Limit (dBuV/)	Over Limit (dB)	Detector	Height (cm)	degree (deg)	Remark
1	2483.500	48.23	-2.31	45.92	74.00	-28.08	peak			
2	2486.350	51.50	-2.30	49.20	74.00	-24.80	peak			

Anbotek

Horizontal-AV:

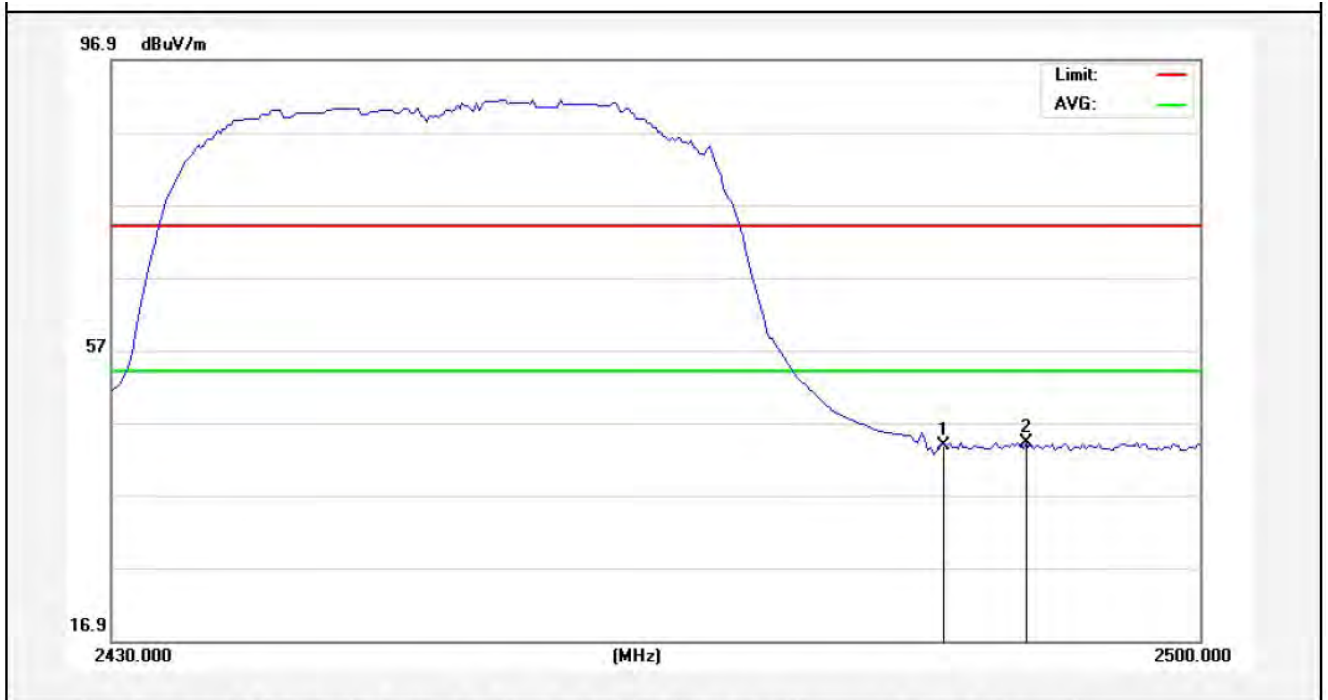

No.	Freq. (MHz)	Reading (dBuV/m)	Factor (dB/m)	Result (dBuV/m)	Limit (dBuV/)	Over Limit (dB)	Detector	Height (cm)	degree (deg)	Remark
1	2483.500	46.20	-2.31	43.89	54.00	-10.11	AVG			
2	2488.800	46.56	-2.29	44.27	54.00	-9.73	AVG			

Test Mode: 802.11n (HT40)  
2452MHz  
Vertical-PEAK:

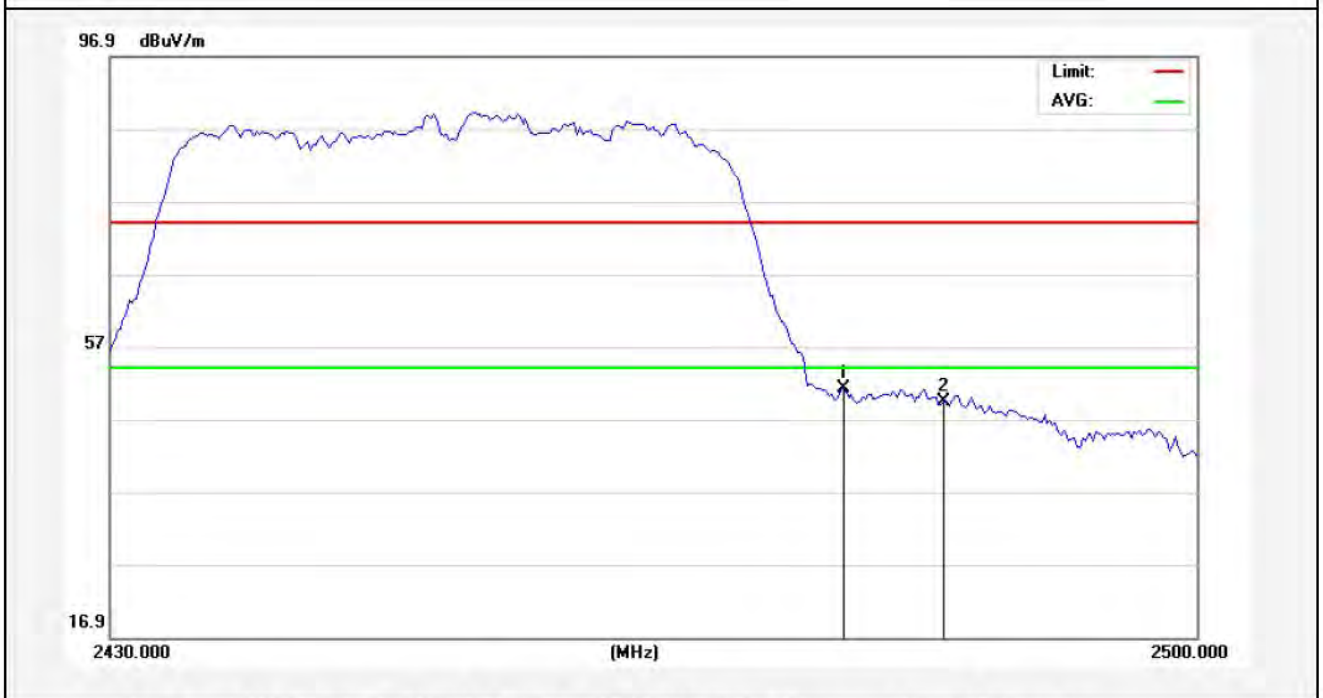

No.	Freq. (MHz)	Reading (dBuV/m)	Factor (dB/m)	Result (dBuV/m)	Limit (dBuV/)	Over Limit (dB)	Detector	Height (cm)	degree (deg)	Remark
1	2477.075	53.45	-2.32	51.13	74.00	-22.87	peak			
2	2483.500	51.81	-2.31	49.50	74.00	-24.50	peak			

Anbotek

Vertical-AV:

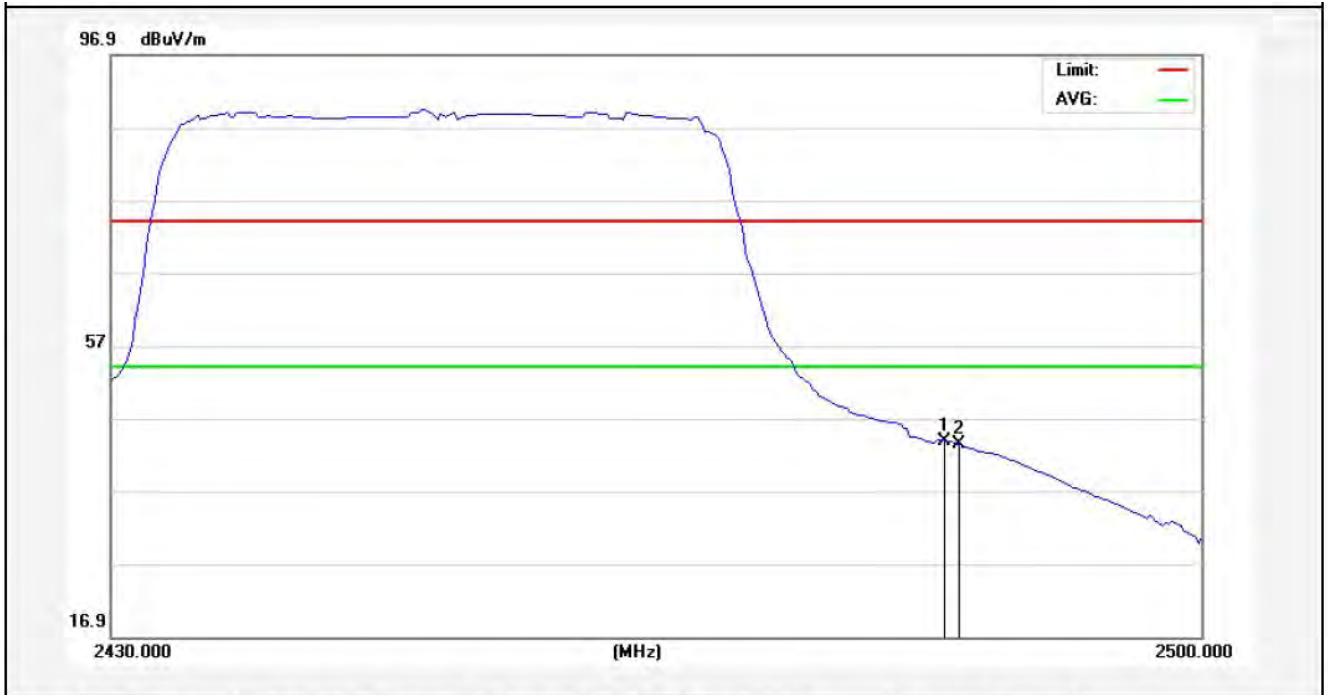

No.	Freq. (MHz)	Reading (dBuV/m)	Factor (dB/m)	Result (dBuV/m)	Limit (dBuV/)	Over Limit (dB)	Detector	Height (cm)	degree (deg)	Remark
1	2483.500	46.10	-2.31	43.79	54.00	-10.21	AVG			
2	2484.425	45.63	-2.30	43.33	54.00	-10.67	AVG			

Anbotek

#### 4.5. Peak Power Spectral Density

##### **a. Limit**

1. For direct sequence systems, the peak power spectral density conducted from the intentional radiator to the antenna shall not be greater than 8dBm in any 3kHz band during any time interval of continuous transmission.
2. The direct sequence operating of the hybrid system, with the frequency hopping operation turned off, shall comply with the power density requirements of paragraph (d) of this section.

##### **b. Test Procedure**

1. Place the EUT on the table and set it in transmitting mode. Remove the antenna from the EUT and then connect a low loss RF cable from the antenna port to the spectrum analyzer.
2. Set the spectrum analyzer as RBW = 3kHz, VBW = 10kHz, Span = 1.5 times DTS BW, Sweep=500s
3. Record the max. reading.
4. Repeat the above procedure until the measurements for all frequencies are completed.

##### **c. Test Equipment**

Same as the equipment listed in 4.2.

##### **d. Test Setup**

See 4.1

##### **e. Test Results**

Pass

##### **f. Test Data**

Please refer to the following data.

##### **g. Test Plot** See the following pages

Test mode: IEEE 802.11b

Channel	Frequency (MHz)	PPSD (dBm/3KHz)	ΣPPSD (dBm/3KHz)	Limit (dBm)	Result
Low	2412	-10.540	-	8.00	Pass
Mid	2437	-11.377	-		Pass
High	2462	-10.666	-		Pass

Test mode: IEEE 802.11g

Channel	Frequency (MHz)	PPSD (dBm)	ΣPPSD (dBm)	Limit (dBm)	Result
Low	2412	-17.109	-	8.00	Pass
Mid	2437	-15.224	-		Pass
High	2462	-16.142	-		Pass

Test mode: IEEE 802.11n (HT20)

Channel	Frequency (MHz)	PPSD (dBm/3KHz)	ΣPPSD (dBm/3KHz)	Limit (dBm)	Result
Low	2412	-17.216	-	8.00	Pass
Mid	2437	-15.040	-		Pass
High	2462	-15.781	-		Pass

Test mode: IEEE 802.11n (HT40)

Channel	Frequency (MHz)	PPSD (dBm/3KHz)	ΣPPSD (dBm/3KHz)	Limit (dBm)	Result
Low	2422	-22.919	-	8.00	Pass
Mid	2437	-20.472	-		Pass
High	2452	-21.018	-		Pass

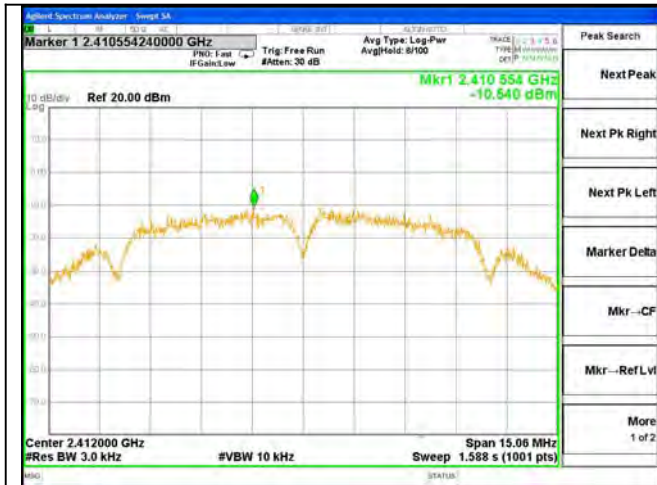

Test Mode: 802.11b---Low

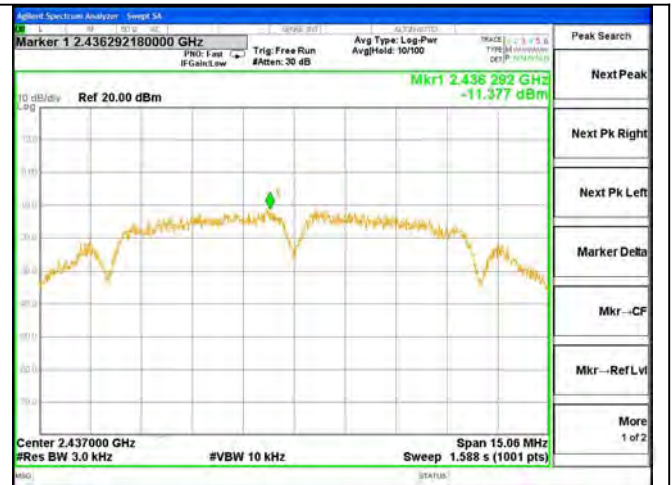

Test Mode: 802.11b---Mid



Test Mode: 802.11b---High

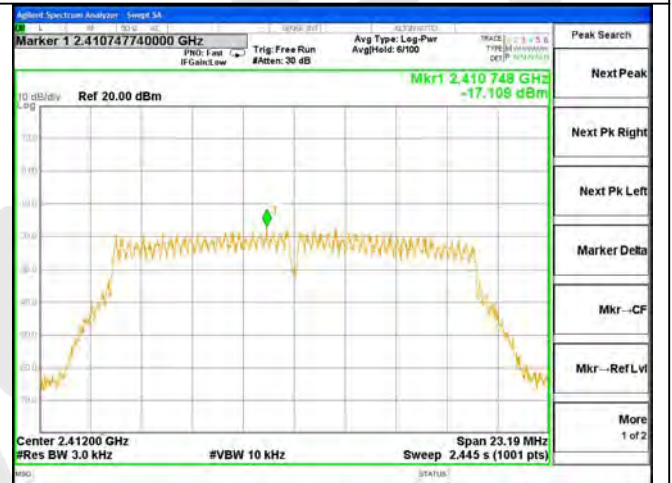

Test Mode: 802.11g---Low



Test Mode: 802.11g---Mid

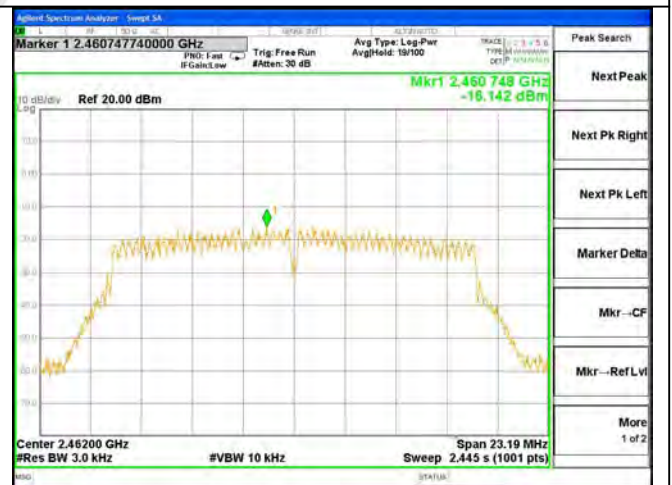

Test Mode: 802.11g---High



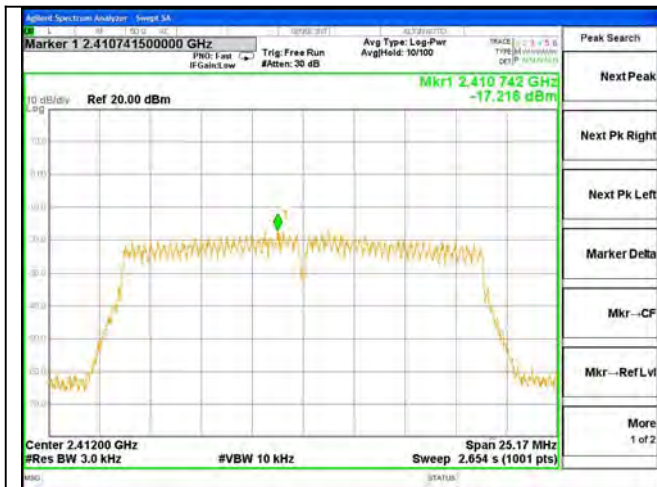

Test Mode: 802.11n20---Low



Test Mode: 802.11n20---Mid

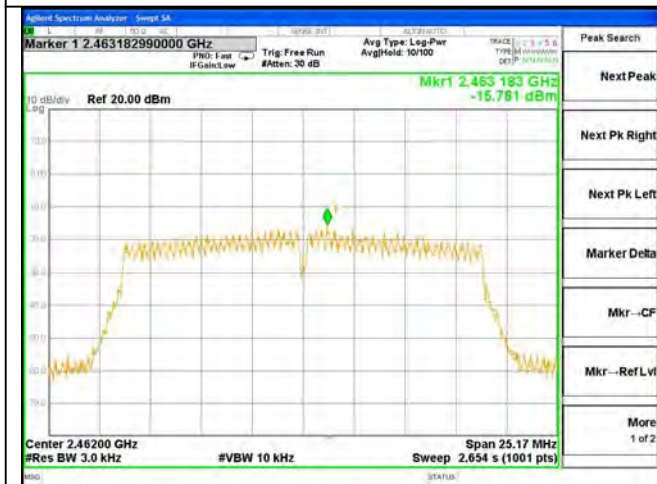

Test Mode: 802.11n20---High

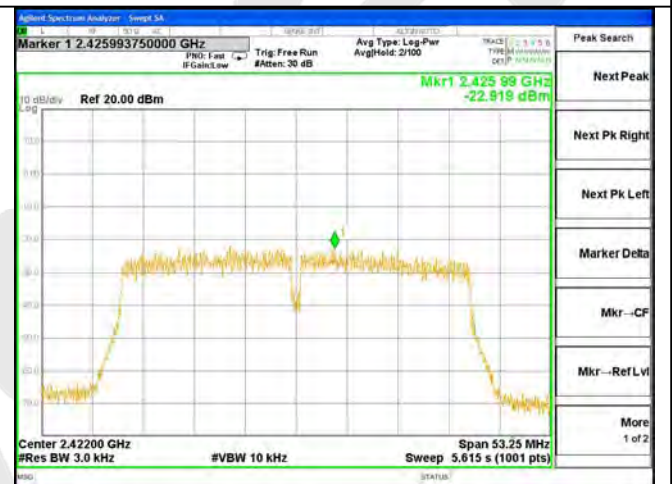

Test Mode: 802.11n40---Low

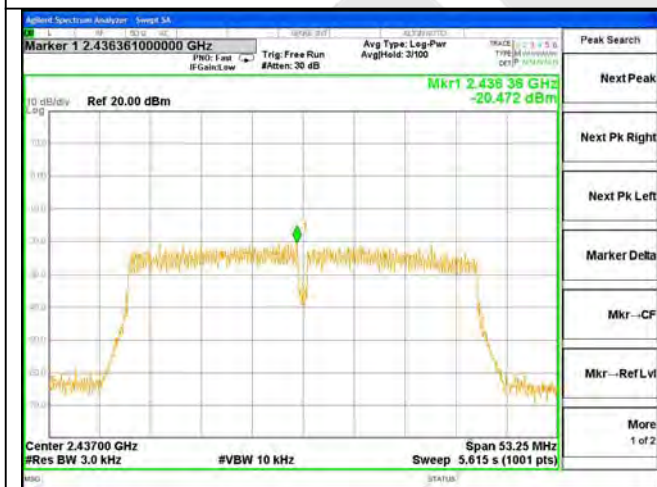

Test Mode: 802.11n40---Mid

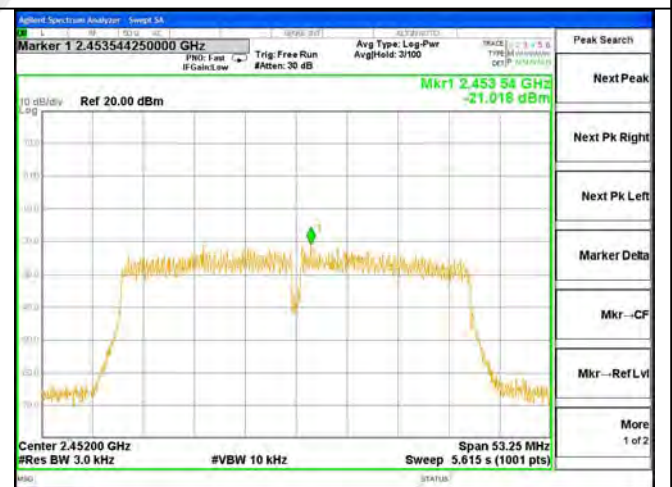

Test Mode: 802.11n40---High

#### 4.6. Radiated Emissions

##### 4.6.1.1. Test Limits (< 30 MHz)

Frequency (MHz)	Field Strength (microvolts/meter)	Measurement Distance (meter)
0.009-0.490	2400/F(kHz)	300
0.490-1.705	24000/F(kHz)	30
1.705-30.0	30	30

##### 4.6.1.2. Test Limits ( $\geq$ 30 MHz)

FIELD STRENGTH of Fundamental: @3M	FIELD STRENGTH of Harmonics	S15.209	
902-928 MHz		30 - 88 MHz	40 dBuV/m
2.4-2.4835 GHz		88 - 216 MHz	43.5
94 dB $\mu$ V/m @3m	54 dB $\mu$ V/m @3m	216 - 960 MHz	46
		ABOVE 960 MHz	54dBuV/m

In any 100 kHz bandwidth outside the frequency band in which the spread spectrum or digitally modulated intentional radiator is operating, the radio frequency power that is produced by the intentional radiator shall be at least 20 dB below that in the 100 kHz bandwidth within the band that contains the highest level of the desired power, based on either an RF conducted or a radiated measurement. Attenuation below the general limits specified in Section 15.209(a) is not required. In addition, radiated emissions which fall in the restricted bands, as defined in Section 15.205(a), must also comply with the radiated emission limits specified in Section 15.209(a) (see Section 15.205(c)).

#### Test Equipment

Item	Equipment	Manufacturer	Model No.	Serial No.	Last Cal.	Cal. Interval
1.	Spectrum Analysis	Agilent	E4407B	US39390582	Apr. 17, 2015	1 Year
2.	Preamplifier	Instruments corporation	EMC011830	980100	Apr. 17, 2015	1 Year
3.	EMI Test Receiver	Rohde & Schwarz	ESPI	101604	Apr. 17, 2015	1 Year
4.	Double Ridged Horn Antenna	Instruments corporation	GTH-0118	351600	Apr. 20, 2015	1 Year
5.	Bilog Broadband Antenna	Schwarzbeck	VULB9163	VULB 9163-289	Apr. 20, 2015	1 Year
6.	Pre-amplifier	SONOMA	310N	186860	Apr. 17, 2015	1 Year
7.	EMI Test Software EZ-EMC	SHURPLE	N/A	N/A	N/A	N/A

4.6.2. Test Configuration:

4.6.2.1. 9k to 30MHz emissions:

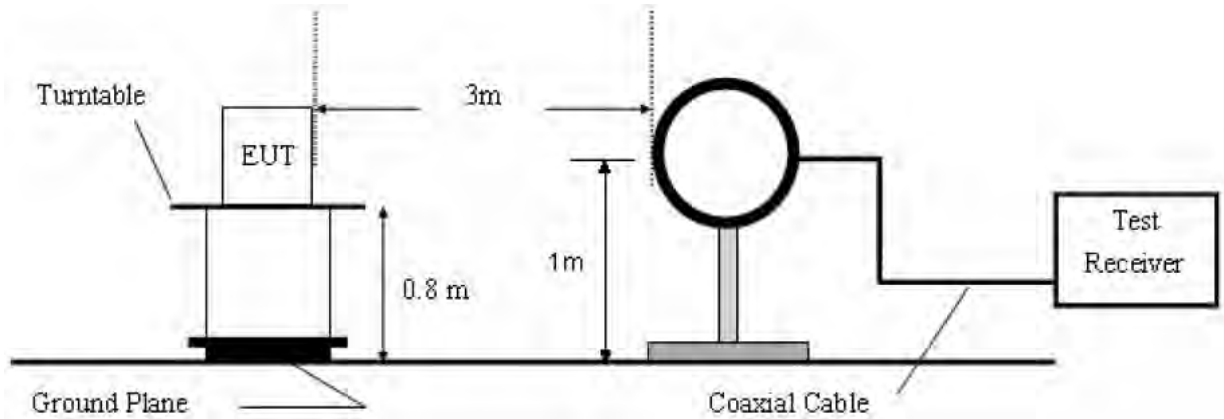

4.6.2.2. 30M to 1G emissions:

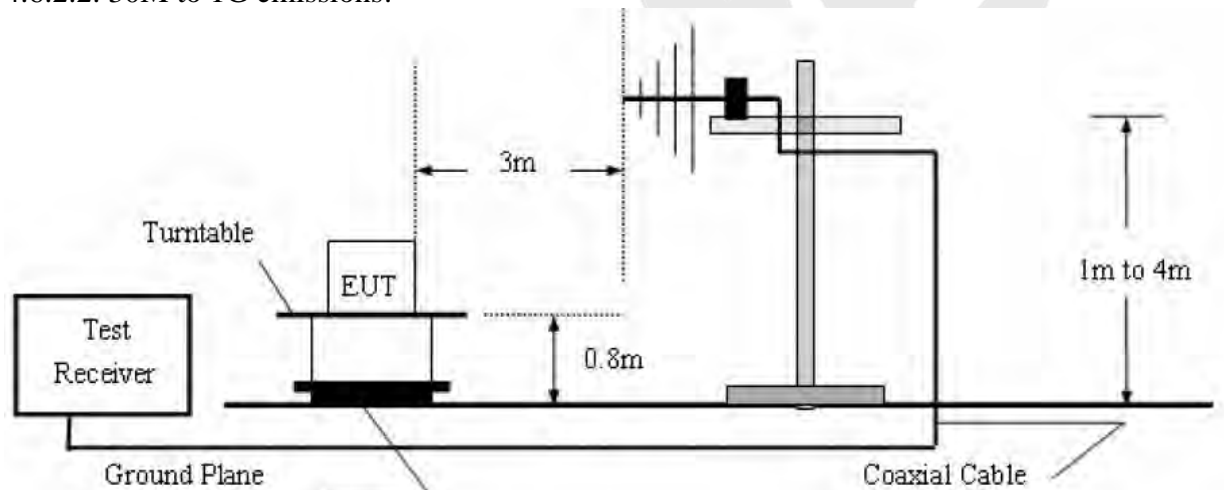

4.6.2.3. 1G to 40G emissions:

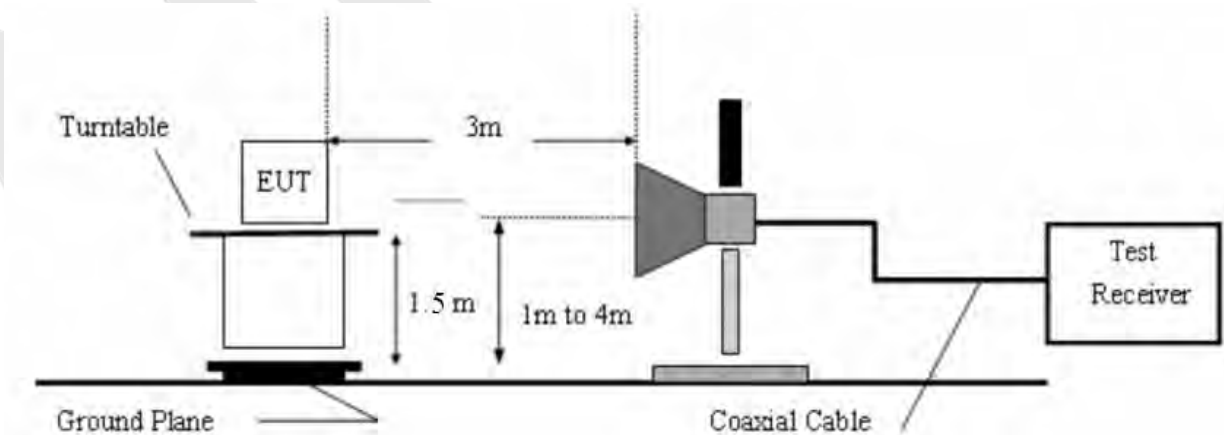

#### 4.6.3. Test Procedure

For below 1GHz: The EUT is placed on a turntable, which is 0.8m above the ground plane.  
For above 1GHz: The EUT is placed on a turntable, which is 1.5m above the ground plane.  
The turn table can rotate 360 degrees to determine the position of the maximum emission level.  
The EUT is set 3 meters away from the receiving antenna which is mounted on a antenna tower.  
The antenna can be moved up and down from 1 to 4 meters to find out the maximum emission level. Both horizontal and vertical polarization of the antenna are set on test.

Measurements are made on 9KHz to 30MHz and 30MHz to 26GHz range with the transmitter set to the lowest, middle, and highest channels.

All readings from 30MHz to 1GHz are quasi-peak values with a resolution bandwidth of 120kHz. All reading are above 1GHz, peak & average values with a resolution bandwidth of 1MHz.

The EUT is tested in 9\*6\*6 Chamber. The device is evaluated in xyz orientation.

The test results are listed in Section 4.6.4.

#### 4.6.4. Test Results

Please refer to the following pages.

Job No.:	011506757I	Polarization:	Horizontal
Standard:	(RE)FCC PART15 C _3m	Power Source:	AC 120V, 60Hz for adapter
Test item:	Radiation Test	Temp.(C)/Hum.(%RH):	24.5(C)/54%RH
Test Mode:	ON	Distance:	3m

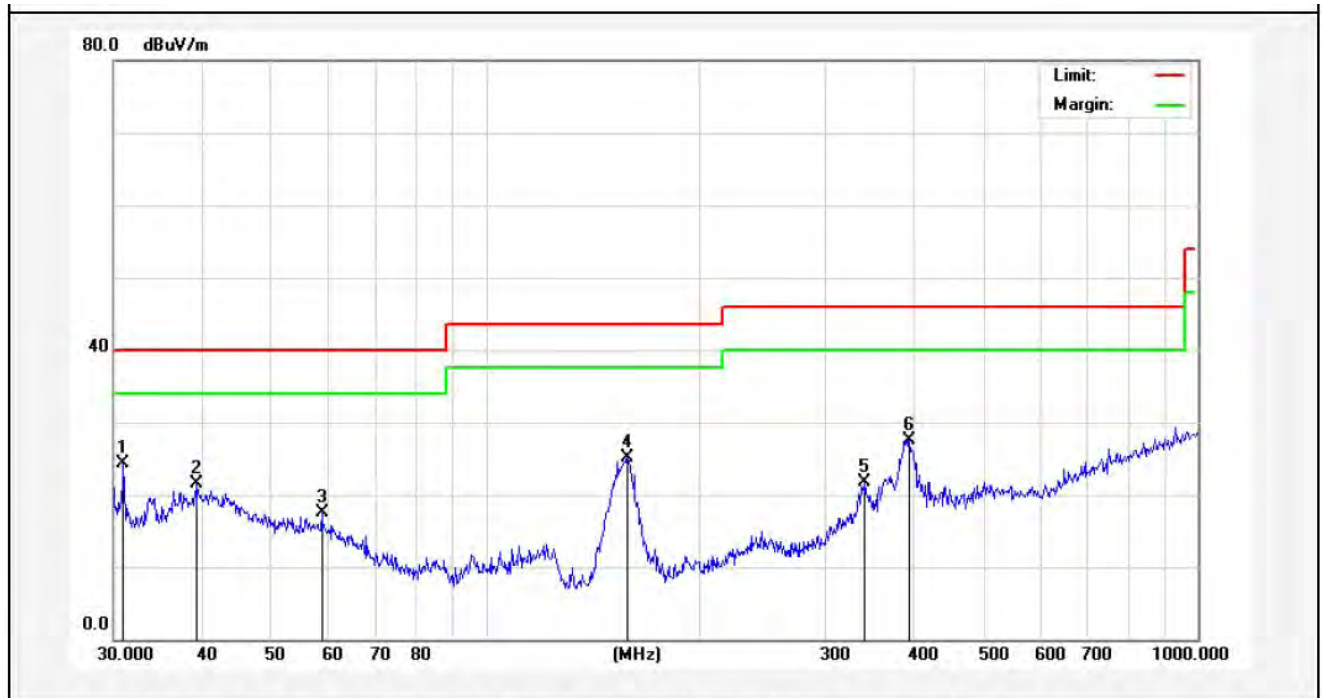

No.	Freq. (MHz)	Reading (dBuV/m)	Factor (dB/m)	Result (dBuV/m)	Limit (dBuV/)	Over Limit (dB)	Detector	Height (cm)	degree (deg)	Remark
1	30.9619	40.75	-16.44	24.31	40.00	-15.69	peak			
2	39.2991	32.35	-10.92	21.43	40.00	-18.57	peak			
3	58.8185	32.82	-15.28	17.54	40.00	-22.46	peak			
4	158.1123	48.12	-22.96	25.16	43.50	-18.34	peak			
5	340.7817	36.04	-14.27	21.77	46.00	-24.23	peak			
6	393.4723	40.53	-13.00	27.53	46.00	-18.47	peak			

Job No.:	011506757I	Polarization:	Vertical
Standard:	(RE)FCC PART15 C_3m	Power Source:	AC 120V, 60Hz for adapter
Test item:	Radiation Test	Temp.(C)/Hum.(%RH):	24.5(C)/54%RH
Test Mode:	ON	Distance:	3m



No.	Freq. (MHz)	Reading (dBuV/m)	Factor (dB/m)	Result (dBuV/m)	Limit (dBuV/)	Over Limit (dB)	Detector	Height (cm)	degree (deg)	Remark
1	38.2120	42.83	-11.77	31.06	40.00	-8.94	peak			
2	46.0164	38.98	-12.79	26.19	40.00	-13.81	peak			
3	63.0916	37.15	-16.67	20.48	40.00	-19.52	peak			
4	124.1330	46.07	-16.95	29.12	43.50	-14.38	peak			
5	157.0074	55.13	-18.00	37.13	43.50	-6.37	peak			
6	387.9920	34.18	-12.11	22.07	46.00	-23.93	peak			

Job No.:	011506757I	Polarization:	Horizontal
Standard:	(RE)FCC PART15 C_3m	Power Source:	AC 120V, 60Hz for adapter
Test item:	Radiation Test	Temp.(C)/Hum.(%RH):	24.5(C)/54%RH
Note:	802.11b(2412MHz)	Distance:	3m

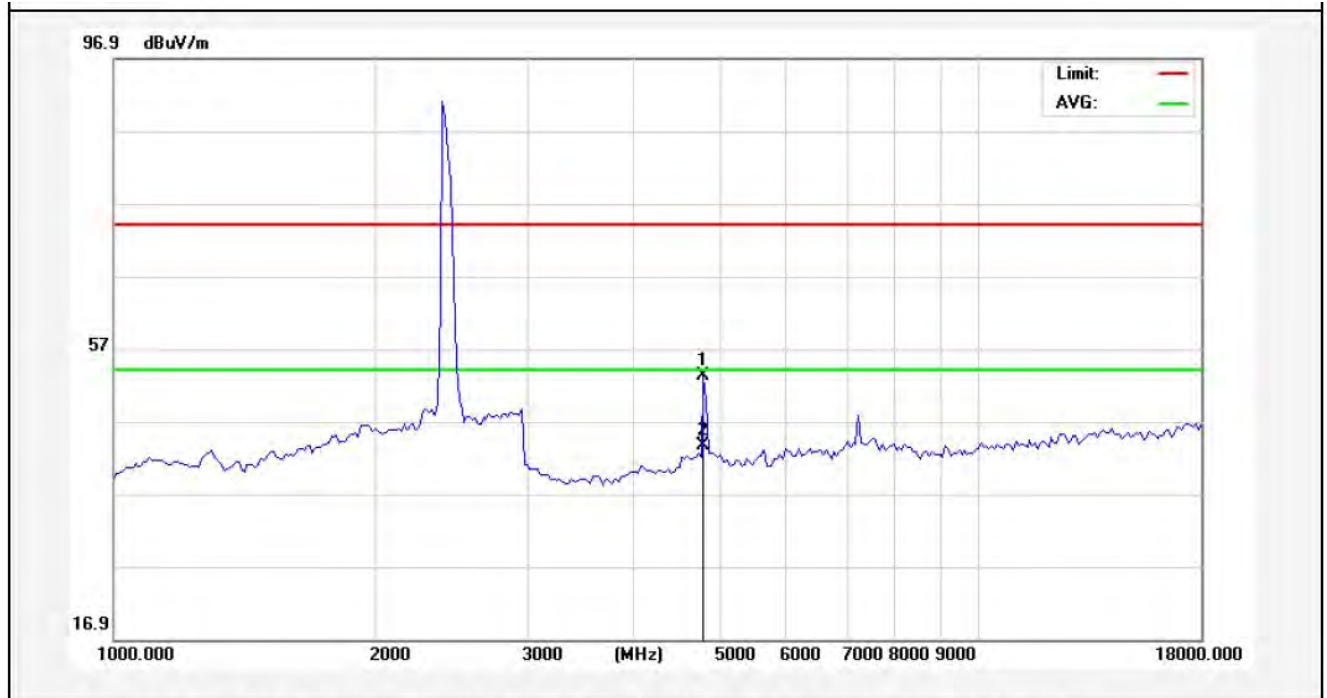

No.	Freq. (MHz)	Reading (dBuV/m)	Factor (dB/m)	Result (dBuV/m)	Limit (dBuV/)	Over Limit (dB)	Detector	Height (cm)	degree (deg)	Remark
1	4825.000	49.79	3.34	53.13	74.00	-20.87	peak			
2	4825.000	40.23	3.34	43.57	54.00	-10.43	AVG			

A.M.

Job No.:	011506757I	Polarization:	Vertical
Standard:	(RE)FCC PART15 C _3m	Power Source:	AC 120V, 60Hz for adapter
Test item:	Radiation Test	Temp.(C)/Hum.(%RH):	24.5(C)/54%RH
Note:	802.11b(2412MHz)	Distance:	3m

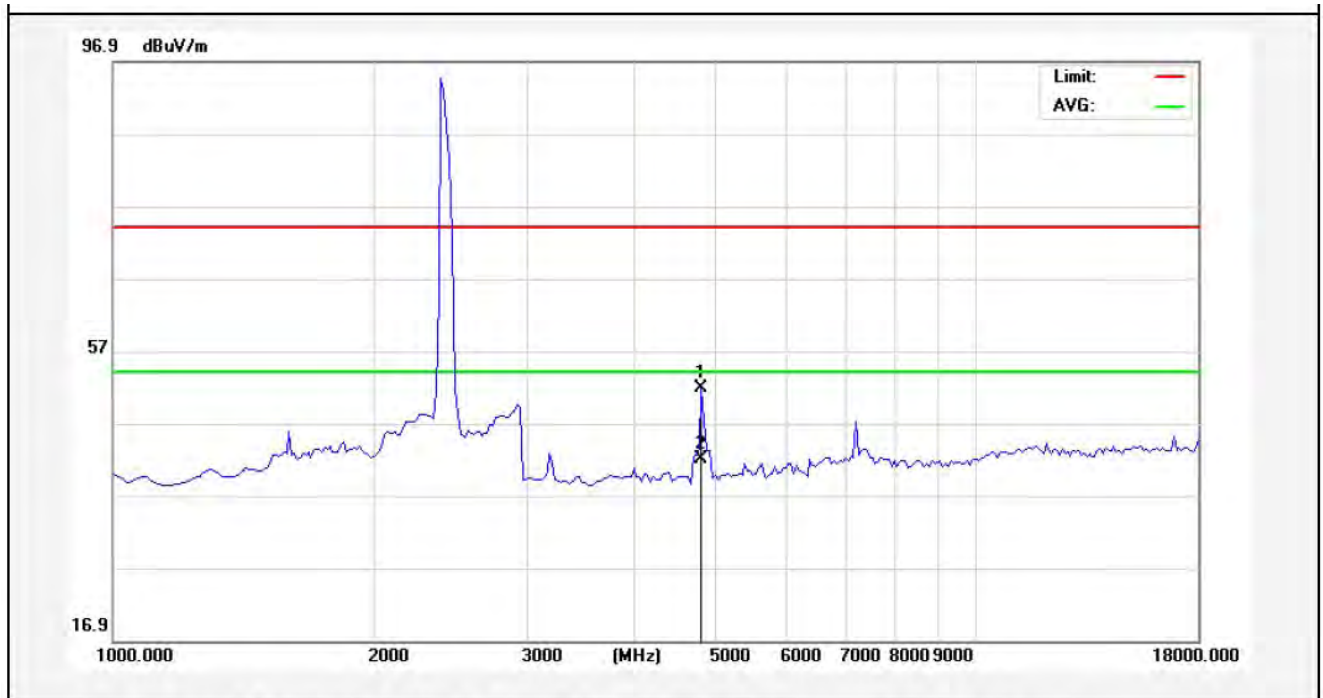

No.	Freq. (MHz)	Reading (dBuV/m)	Factor (dB/m)	Result (dBuV/m)	Limit (dBuV/)	Over Limit (dB)	Detector	Height (cm)	degree (deg)	Remark
1	4825.000	48.54	3.34	51.88	74.00	-22.12	peak			
2	4825.000	38.62	3.34	41.96	54.00	-12.04	AVG			

AM



Job No.:	0115067571	Polarization:	Horizontal
Standard:	(RE)FCC PART15 C_3m	Power Source:	AC 120V, 60Hz for adapter
Test item:	Radiation Test	Temp.(C)/Hum.(%RH):	24.5(C)/54%RH
Note:	802.11b(2437MHz)	Distance:	3m

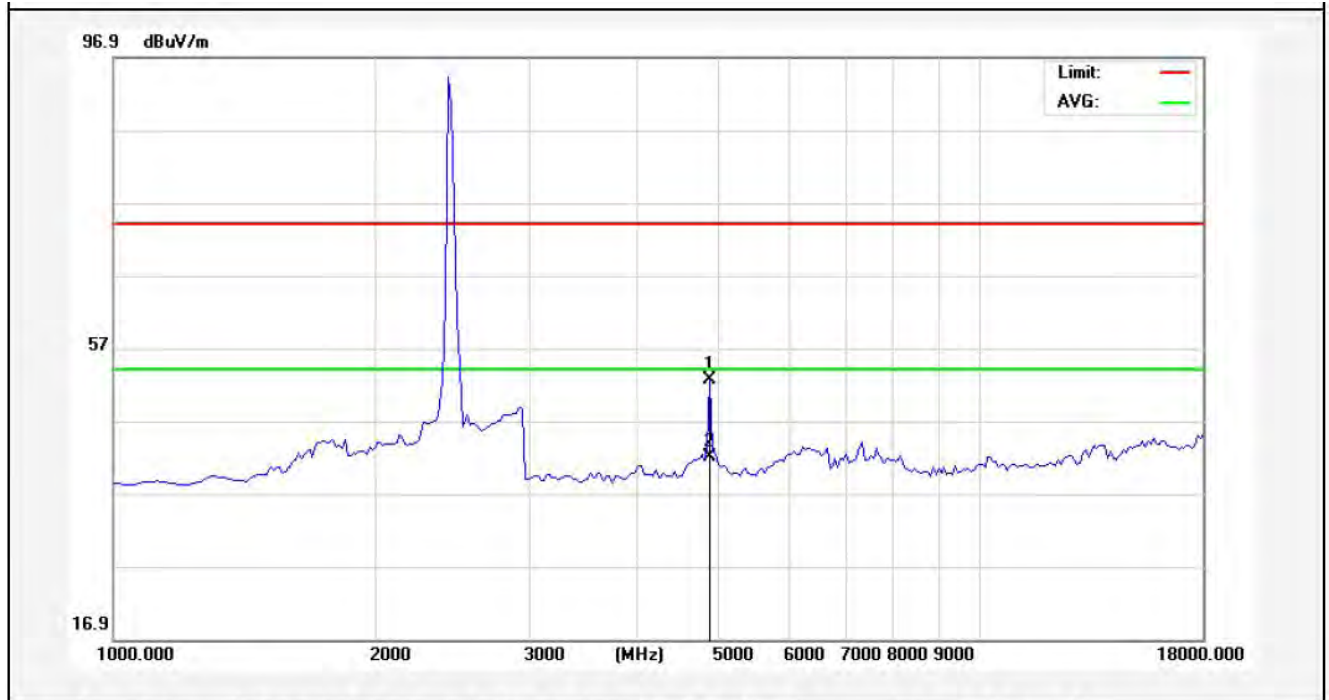

No.	Freq. (MHz)	Reading (dBuV/m)	Factor (dB/m)	Result (dBuV/m)	Limit (dBuV/)	Over Limit (dB)	Detector	Height (cm)	degree (deg)	Remark
1	4867.500	49.20	3.41	52.61	74.00	-21.39	peak			
2	4867.500	38.60	3.41	42.01	54.00	-11.99	AVG			

A.M.

<b>Job No.:</b>	<b>011506757I</b>	<b>Polarization:</b>	<b>Vertical</b>
<b>Standard:</b>	<b>(RE)FCC PART15 C _3m</b>	<b>Power Source:</b>	<b>AC 120V, 60Hz for adapter</b>
<b>Test item:</b>	<b>Radiation Test</b>	<b>Temp.(C)/Hum.(%RH):</b>	<b>24.5(C)/54%RH</b>
<b>Note:</b>	<b>802.11b(2437MHz)</b>	<b>Distance:</b>	<b>3m</b>

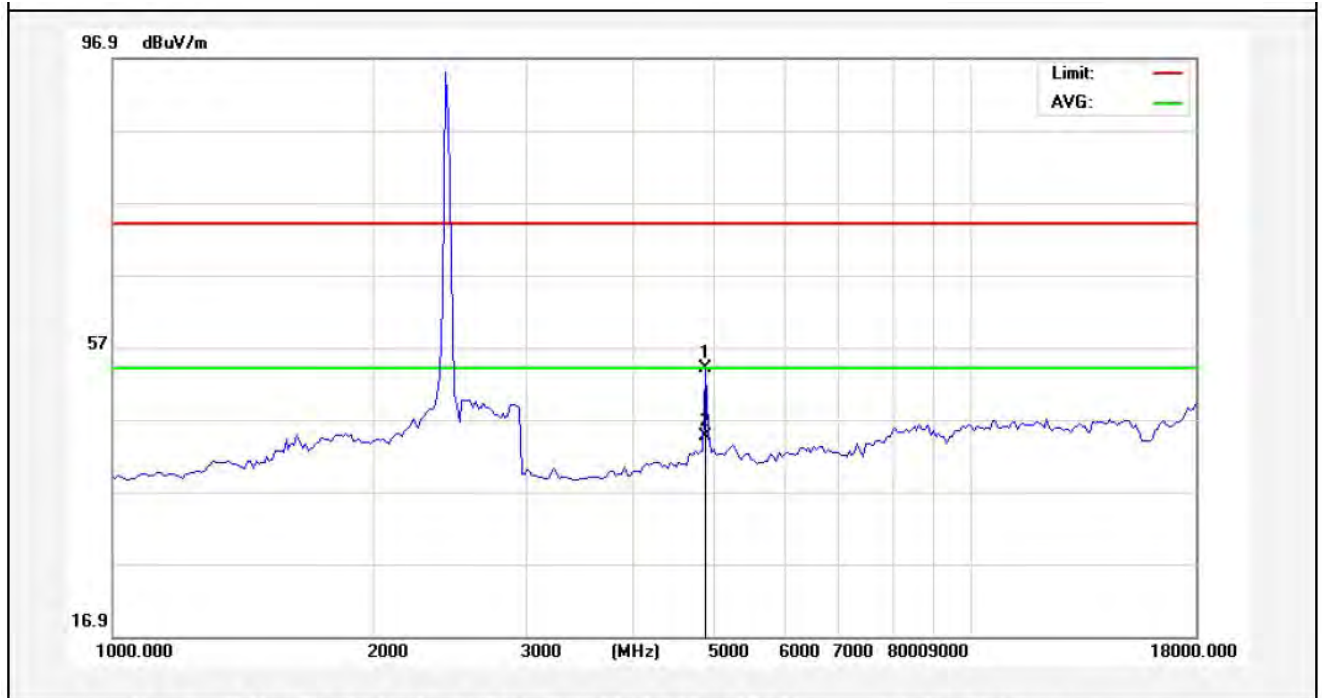

No.	Freq. (MHz)	Reading (dBuV/m)	Factor (dB/m)	Result (dBuV/m)	Limit (dBuV/)	Over Limit (dB)	Detector	Height (cm)	degree (deg)	Remark
1	4867.500	50.63	3.41	54.04	74.00	-19.96	peak			
2	4867.500	41.18	3.41	44.59	54.00	-9.41	AVG			



Job No.:	011506757I	Polarization:	Horizontal
Standard:	(RE)FCC PART15 C_3m	Power Source:	AC 120V, 60Hz for adapter
Test item:	Radiation Test	Temp.(C)/Hum.(%RH):	24.5(C)/54%RH
Note:	802.11b(2462MHz)	Distance:	3m

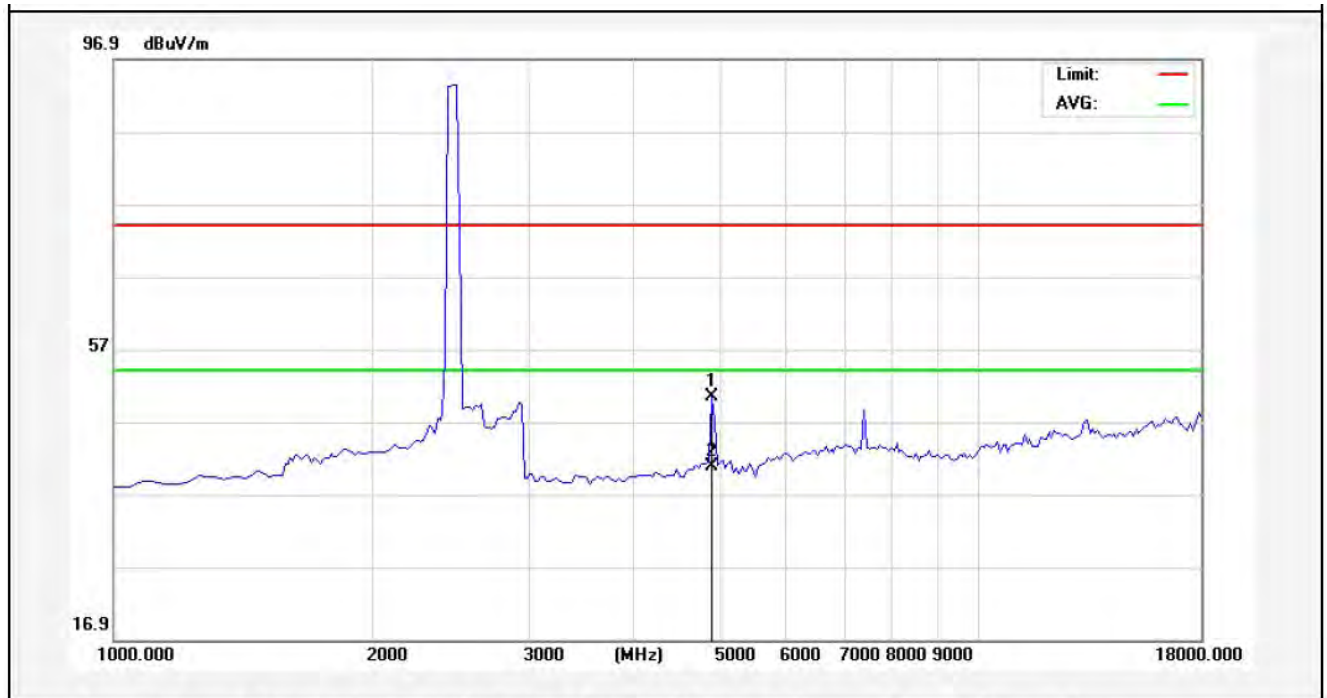

No.	Freq. (MHz)	Reading (dBuV/m)	Factor (dB/m)	Result (dBuV/m)	Limit (dBuV/)	Over Limit (dB)	Detector	Height (cm)	degree (deg)	Remark
1	4910.000	47.00	3.49	50.49	74.00	-23.51	peak			
2	4910.000	37.35	3.49	40.84	54.00	-13.16	AVG			

A.M.

Job No.:	011506757I	Polarization:	Vertical
Standard:	(RE)FCC PART15 C_3m	Power Source:	AC 120V, 60Hz for adapter
Test item:	Radiation Test	Temp.(C)/Hum.(%RH):	24.5(C)/54%RH
Note:	802.11b(2462MHz)	Distance:	3m

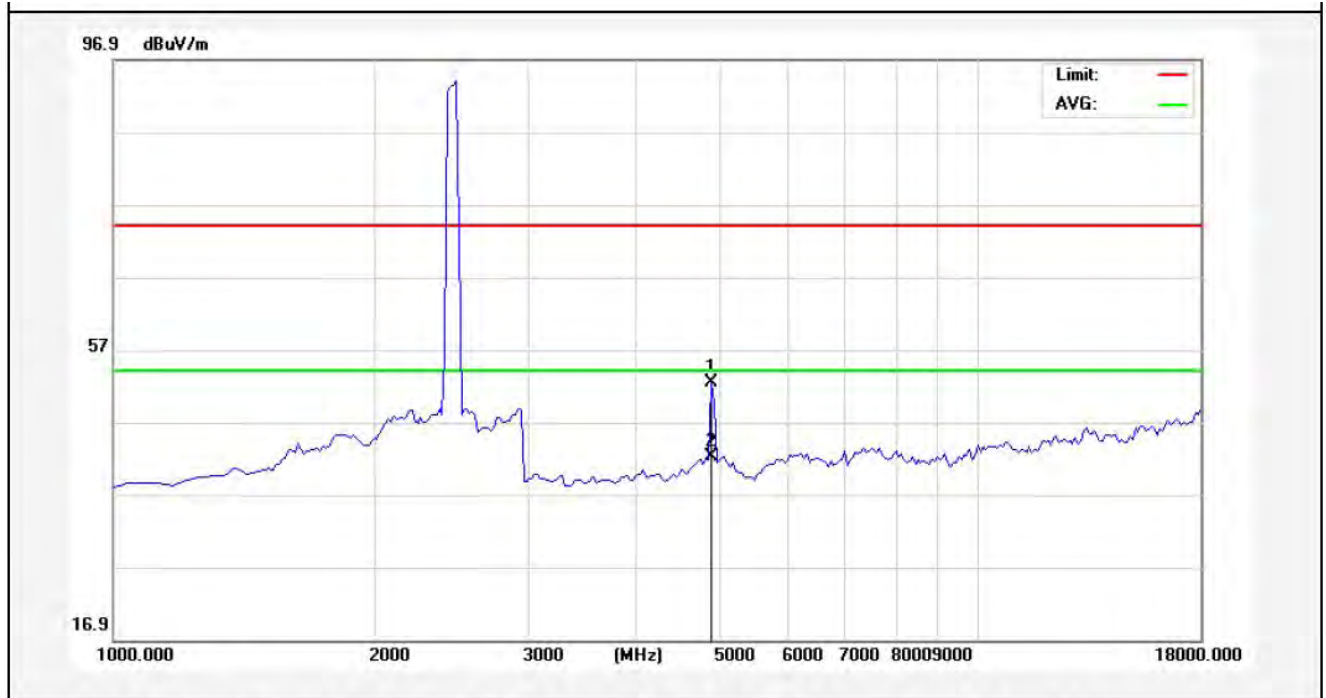

No.	Freq. (MHz)	Reading (dBuV/m)	Factor (dB/m)	Result (dBuV/m)	Limit (dBuV/)	Over Limit (dB)	Detector	Height (cm)	degree (deg)	Remark
1	4910.000	48.83	3.49	52.32	74.00	-21.68	peak			
2	4910.000	38.68	3.49	42.17	54.00	-11.83	AVG			

AM

## 5. ANTENNA APPLICATION

### 5.1. Antenna requirement

The EUT'S antenna is met the requirement of FCC part 15C section 15.203.

An intentional radiator shall be designed to ensure that no antenna other than that furnished by the responsible party shall be used with the device. The use of a permanently attached antenna or of an antenna that uses a unique coupling to the intentional radiator shall be considered sufficient to comply with the provisions of this section. The manufacturer may design the unit so that a broken antenna can be replaced by the user, but the use of a standard antenna jack or electrical connector is prohibited. This requirement does not apply to carrier current devices or to devices operated under the provisions of §15.211, §15.213, §15.217, §15.219, or §15.221. Further, this requirement does not apply to intentional radiators that must be professionally installed, such as perimeter protection systems and some field disturbance sensors, or to other intentional radiators which, in accordance with §15.31(d), must be measured at the installation site. However, the installer shall be responsible for ensuring that the proper antenna is employed so that the limits in this part are not exceeded.

### 5.2. Result

The EUT's antenna used a PCB antenna which is permanently attached, The antenna's gain is 0.5dBi and meets the requirement.

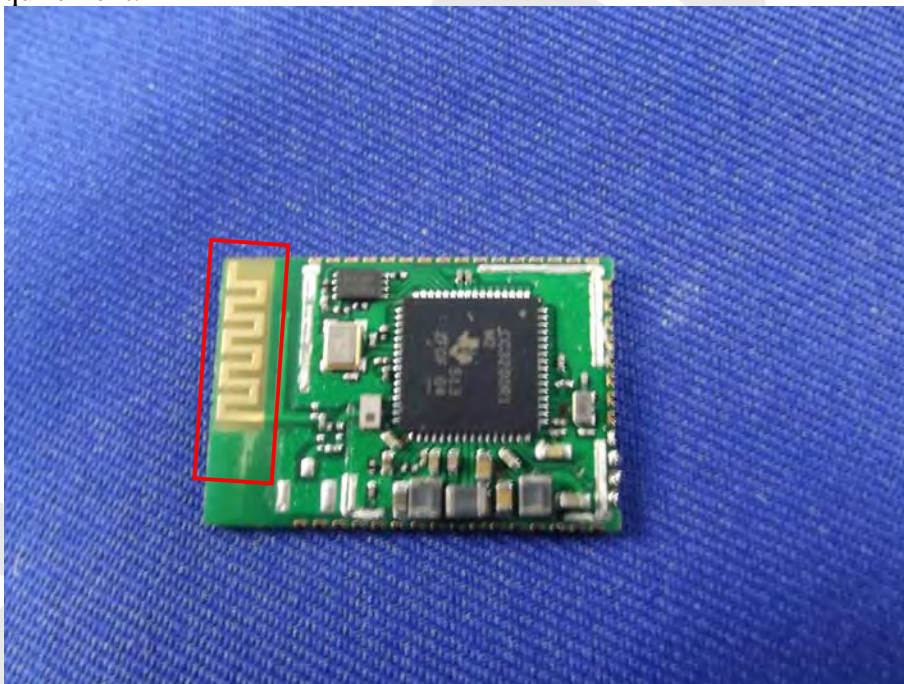

## 6. PHOTOGRAPH

### 6.1. Photo of Conducted Emission Measurement



### 6.2. Photo of Radiation Emission Test

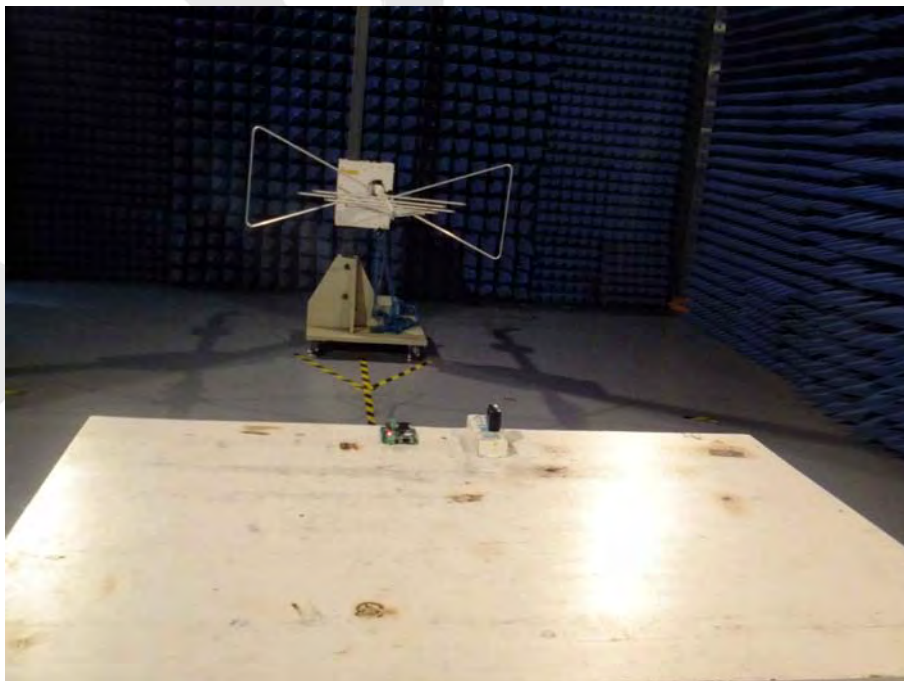

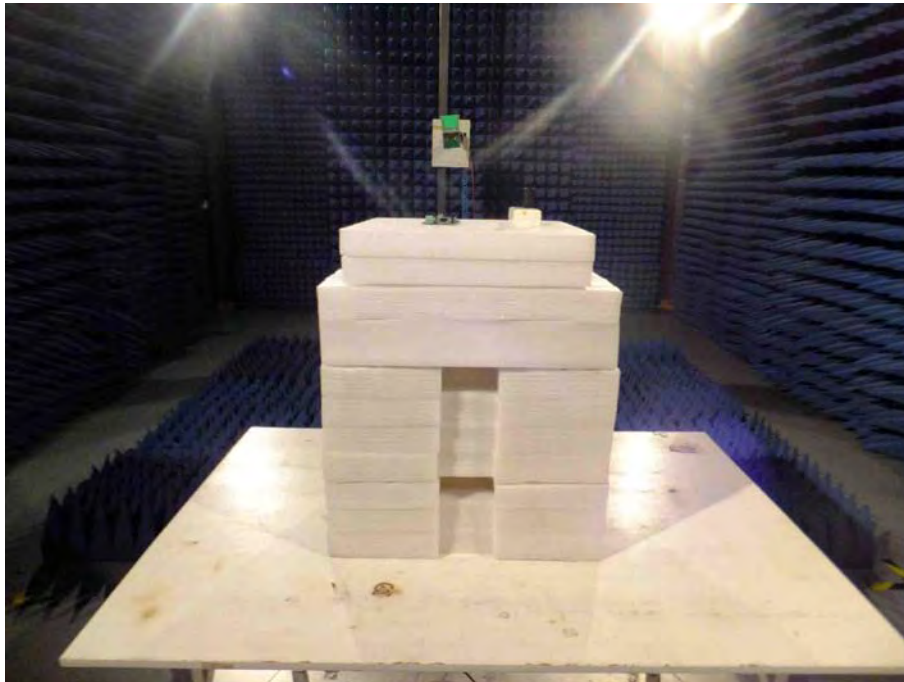

## APPENDIX I (EXTERNAL PHOTOS)

Figure 1  
The EUT-Front View

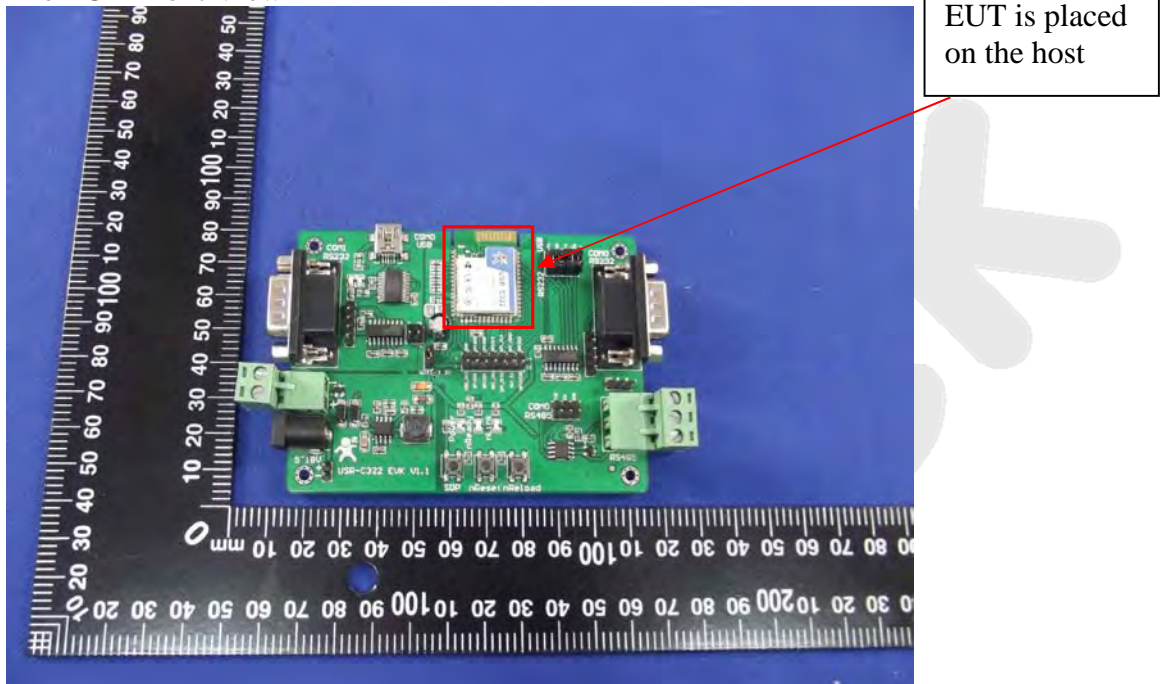

Figure 2  
The EUT-Back View

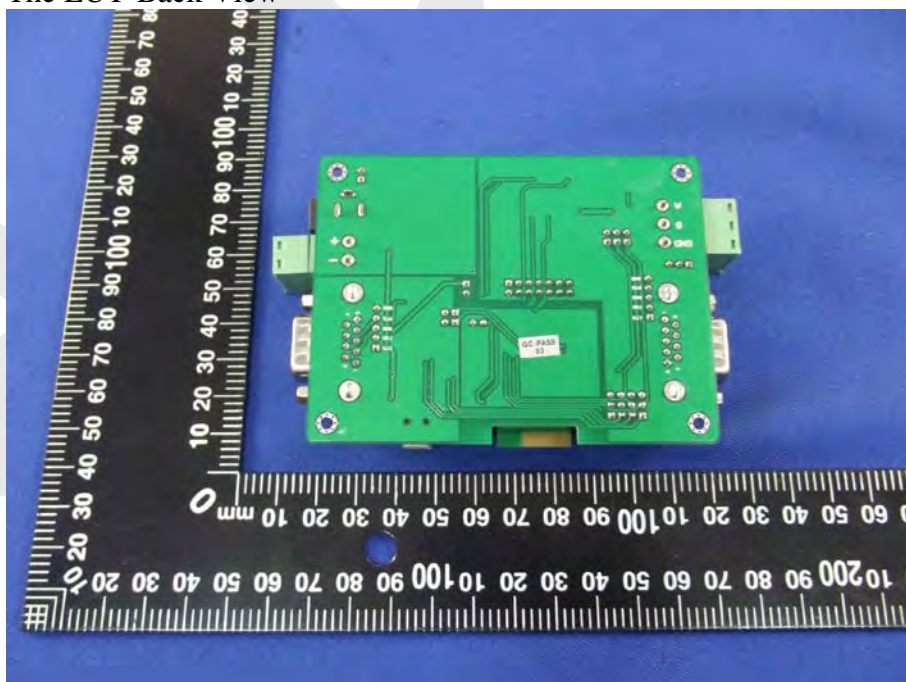



Figure 3  
The EUT-Front View

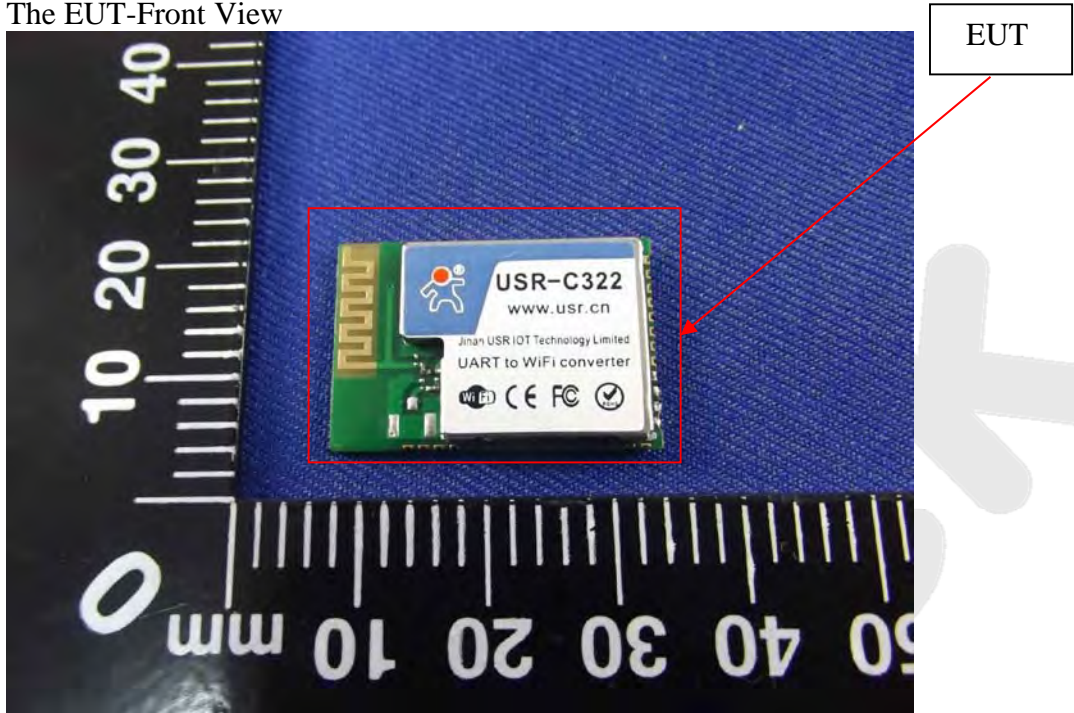
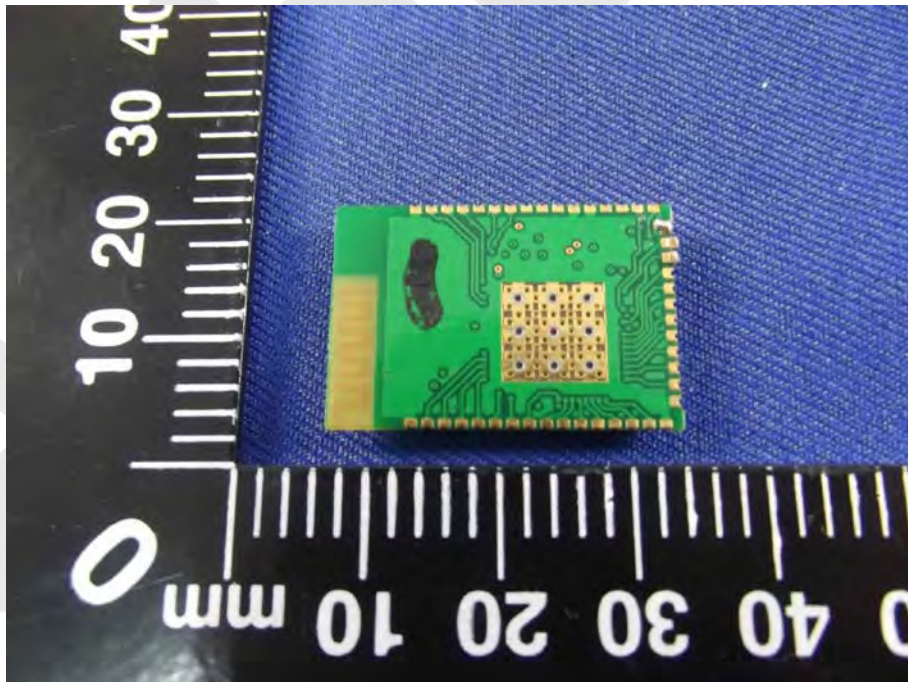

Figure 4  
The EUT-Back View



## APPENDIX II (INTERNAL PHOTOS)

Figure 5  
The EUT-Inside View



Figure 6  
The EUT-Inside View

