



FCC RADIO TEST REPORT

Applicant : SHENZHEN Hitevision Technology Co., Ltd.
Address : Honghe Mansion No. 1 Building A, 1 Danzi
North Road, Shatian, Kengzi Street,
Pingshan District, Shenzhen
Equipment : EDLA Android OPS Computer
Model No. : WB55860W
Trade Name : newline
FCC ID. : 2ACYT-RK3566
Standard : FCC part 15 Subpart C §15.247

I HEREBY CERTIFY THAT:

The sample was received on Oct. 12, 2023 and the testing was completed on Nov. 01, 2023 at CerpPASS Technology Corp. The test result refers exclusively to the test presented test model / sample. Without written approval of CerpPASS Technology Corp., the test report shall not be reproduced except in full.

Approved by:

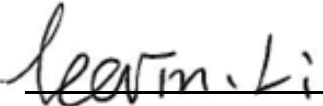

Leevin Li / Supervisor



CONTENTS

1. Summary of Test Procedure and Test Results	5
1.1 Applicable Standards	5
2. Test Configuration of Equipment under Test	6
2.1 Feature of Equipment under Test.....	6
2.2 Carrier Frequency of Channels	6
2.3 Test Mode and Test Software	8
2.4 Power Parameter Value of the test software	9
2.5 Description of Test System	10
2.6 General Information of Test	11
2.7 Measurement Uncertainty	11
3. Test Equipment and Ancillaries Used for Tests	12
4. Antenna Requirements	14
4.1 Standard Applicable	14
4.2 Antenna Construction and Directional Gain	14
5. Test of AC Power Line Conducted Emission	15
5.1 Test Limit	15
5.2 Test Procedures	15
5.3 Typical Test Setup	16
5.4 Test Result and Data	17
6. Test of Spurious Emission (Radiated)	19
6.1 Test Limit	19
6.2 Test Procedures	19
6.3 Typical Test Setup	20
6.4 Test Result and Data (9KHz ~ 30MHz)	21
6.5 Test Result and Data (30MHz ~ 1GHz).....	21
6.6 Test Result and Data (1GHz ~ 25GHz).....	23
6.7 Restricted Bands of Operation	59
6.8 Restrict Band Emission Measurement Data	60
7. Test of Conducted Spurious Emission	84
7.1 Test Limit	84
7.2 Test Procedure	84
7.3 Test Setup Layout.....	84
7.4 Test Result and Data	84
8. On Time, Duty Cycle and Measurement methods	97
8.1 Test Limit	97
8.2 Test Procedure	97
8.3 Test Setup Layout.....	97
8.4 Test Result and Data	98
9. 6dB Bandwidth Measurement Data	100
9.1 Test Limit	100
9.2 Test Procedures	100
9.3 Test Setup Layout.....	100
9.4 Test Result and Data	101
10.Maximum Peak Output Power	108



10.1 Test Limit 108

10.2 Test Procedures 108

10.3 Test Setup Layout..... 108

10.4 Test Result and Data 109

11. Power Spectral Density 110

11.1 Test Limit 110

11.2 Test Procedures 110

11.3 Test Setup Layout..... 110

11.4 Test Result and Data 111



History of this test report

Version No.	Report No	Date	Description
Rev.01	DEF12310054	Nov. 06, 2023	Initial Issue



1. Summary of Test Procedure and Test Results

1.1 Applicable Standards

ANSI C63.10:2013

FCC Rules and Regulations Part 15 Subpart C §15.247

FCC Rule	Description of Test	Result
FCC CFR Title 47 Part 15 Subpart C: Section 15.203/15.247 (b)	. Antenna Requirement	Pass
FCC CFR Title 47 Part 15 Subpart C: Section 15.207	. AC Power Line Conducted Emission	Pass
FCC CFR Title 47 Part 15 Subpart C: Section 15.205/15.209;	. Spurious Emission(Radiated)	Pass
FCC CFR Title 47 Part 15 Subpart C: Section 15.247(d);	. Spurious Emission(Conducted)	Pass
FCC CFR Title 47 Part 15 Subpart C: Section 15.247(a)(2);	. 6dB Bandwidth	Pass
FCC CFR Title 47 Part 15 Subpart C: Section 15.247(b);	. Maximum Peak Output Power	Pass
FCC CFR Title 47 Part 15 Subpart C: Section 15.247(e)	. Power Spectral Density	Pass
Note: Deviations Yes <input type="checkbox"/> No <input checked="" type="checkbox"/> *The lab has reduced the uncertainty risk factor from test equipment, environment and staff technicians which according to the standard on contract. Therefore, the test result will only be determined by standard requirement.		



2. Test Configuration of Equipment under Test

2.1 Feature of Equipment under Test

Equipment	EDLA Android OPS Computer
Model Name	WB55860W
Model Discrepancy	N/A
Chipset	RTL8852BU
Frequency Range	BT/BLE/ WIFI 2.4G: 2400MHz-2483.5MHz WIFI 5G: 5150MHz-5250MHz, 5725MHz -5850MHz
Modulation Type	BT: GFSK, $\pi/4$ -DQPSK, 8DPSK BLE: GFSK 2.4GHz 802.11b: CCK, DQPSK, DBPSK 802.11g/n: BPSK, QPSK, 16QAM, 64QAM 802.11ax: BPSK, QPSK, 16QAM, 64QAM, 256QAM, 1024QAM 5GHz 802.11a/n: BPSK, QPSK, 16QAM, 64QAM 802.11ac: BPSK, QPSK, 16QAM, 64QAM, 256QAM 802.11ax: BPSK, QPSK, 16QAM, 64QAM, 256QAM, 1024QAM
Data Rate	BT: GFSK:1Mbps, $\pi/4$ -DQPSK: 2Mbps, 8DPSK:3Mbps BLE: GFSK: 1Mbps, 2Mbps WIFI 2.4GHz: 802.11b: 1, 2, 5.5, 11Mbps 802.11g: 6, 9, 12, 18, 24, 36, 48, 54Mbps 802.11n: MCS0-MCS15, HT20/HT40 802.11ax: MCS0-MCS11, HE20/HE40 WIFI 5GHz: 802.11a: 6, 9, 12, 18, 24, 36, 48, 54Mbps 802.11n: MCS0-MCS15, HT20/HT40 802.11ac: MCS0-MCS9, VHT20/40/80 802.11ax: MCS0-MCS11, HE20/HE40/HE80
Antenna Type	Dipole Antenna
Antenna Gain	BT/BLE: 4.19dbi WiFi2.4GHz: Antenna A:4.19dbi; Antenna B:4.19dbi WiFi 5GHz BAND1: Antenna A: 4.26dbi; Antenna B:4.26dbi BAND4: Antenna A:4.46dbi; Antenna B:4.46dbi
Working Temperature	0°C to 40°C
Operating Voltage	DC 12V from Adapter

Note: 1) EUT supports CDD mode and 11AX supports FULL RU only.

2) For a more detailed features description, please refer to the manufacturer's specifications or the User's Manual.



2.2 Carrier Frequency of Channels

802.11b, 802.11g, 802.11n HT 20, 802.11ax HE20 (2412MHz~2462MHz)

Channel	Frequency(MHz)	Channel	Frequency(MHz)
*01	2412	07	2442
02	2417	08	2447
03	2422	09	2452
04	2427	10	2457
05	2432	*11	2462
*06	2437	---	---

802.11n HT40 , 802.11ax HE40 (2422MHz~2452MHz)

Channel	Frequency(MHz)	Channel	Frequency(MHz)
---	---	07	2442
---	---	08	2447
*03	2422	*09	2452
04	2427	---	---
05	2432	---	---
*06	2437	---	---

Note: Channels remarked * are selected to perform test.



2.3 Test Mode and Test Software

- a. During testing, the interface cables and equipment positions were varied according to ANSI C63.10.
- b. The complete test system included Notebook, adapter and EUT for the RF test.
- c. An executive program, "CMD.exe (Ver.: N/A)" under Windows 10 system was executed to transmit and receive data via WLAN.
- d. The following test modes were performed for the test:

Conducted Emissions from the AC mains power ports	
Test Mode	Operating Description
1	802.11b (1Mbps) for 120V
2	802.11g (6Mbps) for 120V
3	802.11n HT20 (6.5Mbps) for 120V
4	802.11n HT40 (13.5Mbps) for 120V
5	802.11ax HE20 (7.3Mbps) for 120V
6	802.11ax HE40 (14.6Mbps) for 120V
7	802.11g (6Mbps) for 240V
caused "Test Mode 2 at CH11:2462" generated the worst case, it was reported as the final data.	
Radiated emission (Below 1GHz)	
Test Mode	Operating Description
1	802.11b (1Mbps)
2	802.11g (6Mbps)
3	802.11n HT20 (6.5Mbps)
4	802.11n HT40 (13.5Mbps)
5	802.11ax HE20 (7.3Mbps)
6	802.11ax HE40 (14.6Mbps)
caused "Test Mode 2 at CH11:2462" generated the worst case, it was reported as the final data.	
Radiated emission (1GHz ~ 25GHz)	
1	802.11b (1Mbps)
2	802.11g (6Mbps)
3	802.11n HT20 (6.5Mbps)
4	802.11n HT40 (13.5Mbps)
5	802.11ax HE20 (7.3Mbps)
6	802.11ax HE40 (14.6Mbps)
caused "Test Mode 1~6" generated the worst case, it was reported as the final data.	

Modulation Type	TX CONFIGURATION
802.11b	2TX
802.11g	2TX
802.11n HT20	2TX
802.11n HT40	2TX
802.11ax HE20	2TX
802.11ax HE40	2TX



2.4 Power Parameter Value of the test software

Mode	Frequency (MHz)	Setting level			
		Ant 1	Ant 2	Ant 1+2	
				Ant 1	Ant 2
802.11b	2412	N/A	N/A	16	16
	2437	N/A	N/A	16	16
	2462	N/A	N/A	16	16
802.11g	2412	N/A	N/A	12	12
	2437	N/A	N/A	12	12
	2462	N/A	N/A	12	12
802.11n (20MHz)	2412	N/A	N/A	11	11
	2437	N/A	N/A	11	11
	2462	N/A	N/A	11	11
802.11n (40MHz)	2422	N/A	N/A	10	10
	2442	N/A	N/A	10	10
	2452	N/A	N/A	10	10
802.11ax (20MHz)	2412	N/A	N/A	11	11
	2437	N/A	N/A	11	11
	2462	N/A	N/A	11	11
802.11ax (40MHz)	2422	N/A	N/A	10	10
	2442	N/A	N/A	10	10
	2452	N/A	N/A	10	10



2.5 Description of Test System

Product	Manufacturer	Model No.	Power Cord
1 Notebook	SONY	PCG-71811P	Non-Shielded, 1.8m
2 Adapter	Mentech	MATH-120200	N/A

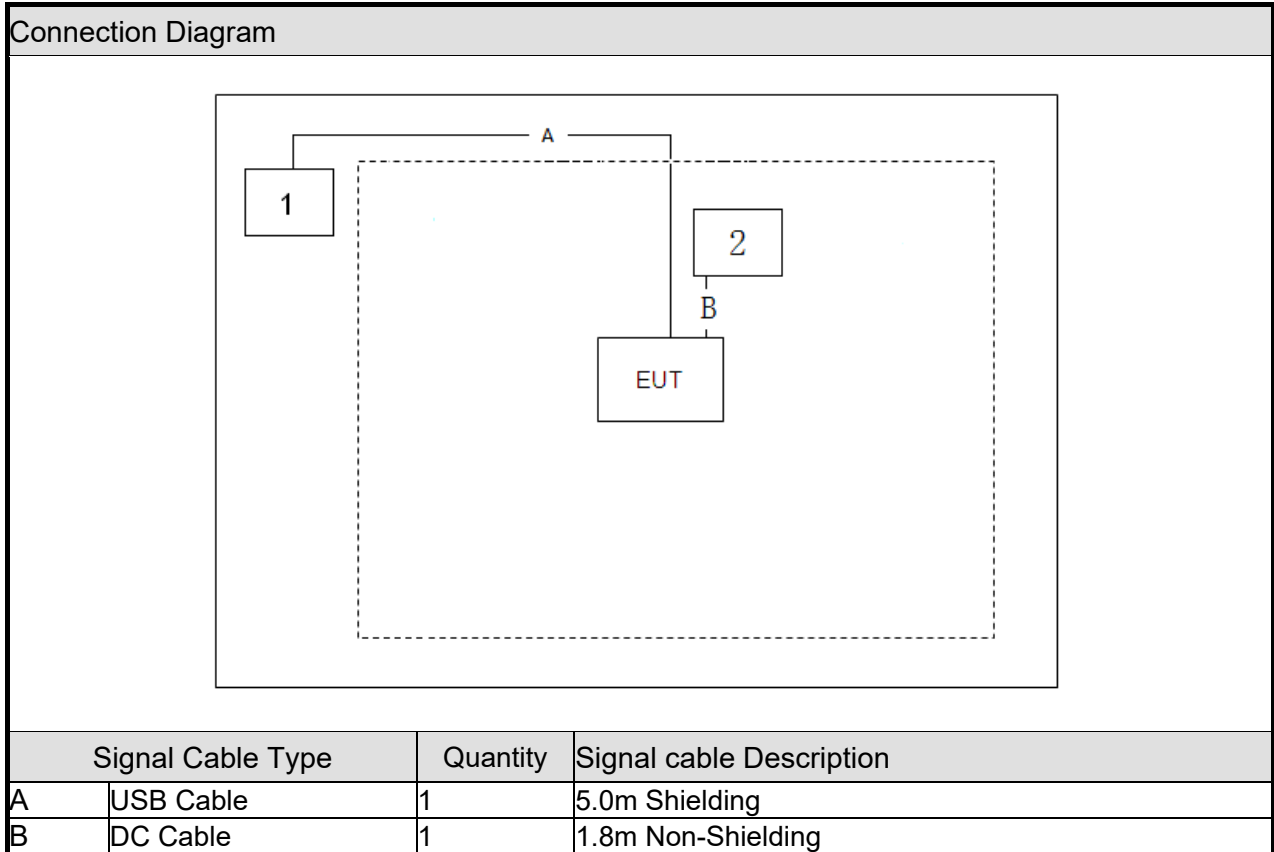



2.6 General Information of Test

Test Site	CerpPASS Technology Corporation(CerpPASS Laboratory) Address: Room 102, No. 5, Xing'an Road, Chang'an Town, Dongguan City, Guangdong Province Tel: +86-769-8547-1212 Fax: +86-769-8547-1912
FCC Designation No.:	CN1288
Frequency Range Investigated:	Conducted: from 150kHz to 30 MHz Radiation: from 9kHz to 25,000MHz
Test Distance:	The test distance of radiated emission from antenna to EUT is 3 M.

Test Item	Test Site	Test period	Environmental Conditions	Tested By
RF Conducted	RFCON01-DG	2023/10/26~2023/10/27	23~25°C / 52~55%	Amos Zhang
Radiated Emissions	3M02-DG	2023/10/25~2023/10/26	24~25°C / 53~54%	Amos Zhang
AC Power Line Conducted Emission	CON01-DG	2023/11/01	24°C / 51%	Amos Zhang

2.7 Measurement Uncertainty

ISO/IEC 17025 requires that an estimate of the measurement uncertainties associated with the emissions test results be included in the report. The measurement uncertainties given below are based on a 95% confidence level (based on a coverage factor (k=2)).

Measurement Item	Uncertainty
AC Power Line Conduction(150K~30MHz)	±2.60dB
Radiated Spurious Emission(9KHz~30MHz)	±4.10dB
Radiated Spurious Emission(30MHz~1GHz)	±4.51dB
Radiated Spurious Emission(1GHz~18GHz)	±5.36dB
Radiated Spurious Emission(18GHz~40GHz)	±5.43dB
6dB Bandwidth&20dB Bandwidth	±4.8%
Occupied Bandwidth	±4.5%
Peak Output Power(Conducted Power Meter)	±0.94dB
Power Spectral Density	±1.01dB
Dwell Time / Deactivation Time	±3.5%

**3. Test Equipment and Ancillaries Used for Tests**

AC Power Line Conducted Emission					
Test Site	CON01-DG				
Instrument/Ancillary	Manufacturer	Model No.	Serial No.	Calibration Date	Valid Date.
Test Receiver	R&S	ESCI	100564	2023/01/06	2024/01/05
LISN	SCHWARZBECK	NSLK 8127	8127749	2023/08/03	2024/08/02
LISN	R&S	ENV216	100024	2023/01/06	2024/01/05
Cable	Aoda	RG214	Cable-06	2023/01/06	2024/01/05
Pulse Limiter with 10dB Attenuation	SCHWARZBECK	VTSD 9561-F	9561-F106	2023/01/06	2024/01/05
Temperature/ Humidity Meter	GEMLEAD	STH200A	N/A	2023/08/03	2024/08/02

Radiated Emissions					
Test Site	3M01-DG				
Instrument	Manufacturer	Model No.	Serial No.	Calibration Date	Valid Date
EMI Test Receiver	R&S	ESCI	100565	2023/08/03	2024/08/02
Amplifier	EMCI	EMC330	980082	2023/05/06	2024/05/05
Loop Antenna	R&S	HFH2-Z2	100150	2022/05/11	2024/05/10
Bilog Antenna	Sunol Science	JB1	A072414-3	2022/06/09	2024/06/08
Preamplifier	Agilent	8449B	3008A02342	2023/08/03	2024/08/02
Preamplifier	COM-POWER	PA-840	711885	2023/05/06	2024/05/05
Broad-Band Horn Antenna	Schwarzbeck	BBHA9120 D	9120D-619	2022/05/22	2024/05/21
Standard Gain Horn Antenna	TRC	HA-2640	18050	2022/05/09	2024/05/08
Standard Gain Horn Antenna	TRC	HA-1726	18051	2022/05/09	2024/05/08
FSQ Signal Analyzer	R&S	FSQ40	200012	2023/05/06	2024/05/05
Cable	EMCI	EM104-NM SM-8.5M	Cable-03	2023/08/03	2024/08/02
Cable	Jiuzhoubona	T-SMA	SMA48AL-7000	2023/08/03	2024/08/02
Cable	CH-CoDesigh	CCXA40-2.92-2.92-1M	21071954	2023/08/03	2024/08/02
Cable	CH-CoDesigh	CCX40-2.92M-2.92M-9M	21070892	2023/08/03	2024/08/02
Temperature/ Humidity Meter	GEMLEAD	STH200A	N/A	2023/08/03	2024/08/02



RF Conducted					
Test Site	RFCON01-DG				
Instrument	Manufacturer	Model No.	Serial No.	Calibration Date	Valid Date
MXA Signal Analyzer	KEYSIGHT	N9020A	US46220290	2023/05/06	2024/05/05
EXA Signal Analyzer	KEYSIGHT	N9010A	MY53400169	2023/05/06	2024/05/05
ESG VECTOR SIGNAL GENERATOR	Agilent	E4438C	MY45092582	2023/05/06	2024/05/05
MXG VECTOR SIGNAL GENERATOR	Agilent	N5182B	MY53050127	2023/05/06	2024/05/05
USB Wideband Power Sensor	Boonton	55006	9778	2023/08/03	2024/08/02
Temperature/ Humidity Meter	mingle	ETH529	N/A	2023/01/06	2024/01/05



4. Antenna Requirements

4.1 Standard Applicable

For intentional device, according to FCC 47 CFR Section 15.203, an intentional radiator shall be designed to ensure that no antenna other than that furnished by the responsible party shall be used with the device.

And according to FCC 47 CFR Section 15.247 (b), if transmitting antennas of directional gain greater than 6dBi are used, the power shall be reduced by the amount in dB that the directional gain of the antenna exceeds 6dBi.

4.2 Antenna Construction and Directional Gain

WIFI 2.4G:

Antenna Type	Dipole Antenna
Antenna Gain	ANT A: 4.19dbi; Antenna B:4.19dBi
Connector	Reverse SMA

(Non-Beamforming)

2412-2462MHz

For Power directional gain= $G_{ant}= 4.19dBi$

For PSD directional gain= $G_{ant}= 7.20dBi$



5. Test of AC Power Line Conducted Emission

5.1 Test Limit

Conducted Emissions were measured from 150 kHz to 30 MHz with a bandwidth of 9 KHz on the 120 VAC power and return leads of the EUT according to the methods defined in ANSI C63.10-2013. The EUT was placed on a nonmetallic stand in a shielded room 0.8 meters above the ground plane as shown in section 6.2.2. The interface cables and equipment positioning were varied within limits of reasonable applications to determine the position produced maximum conducted emissions.

Frequency (MHz)	Quasi Peak (dB μ V)	Average (dB μ V)
0.15 – 0.5	66-56*	56-46*
0.5 – 5.0	56	46
5.0 – 30.0	60	50

*Decreases with the logarithm of the frequency.

5.2 Test Procedures

The EUT was setup according to ANSI C63.10, 2013 and tested according to DTS test procedure of Oct 2014 KDB558074 for compliance to FCC 47CFR 15.247 requirements. The EUT was placed on a platform of nominal size, 1 m by 1.5 m, raised 80 cm above the conducting ground plane. The vertical conducting plane was located 40 cm to the rear of the EUT. All other surfaces of EUT were at least 80 cm from any other grounded conducting surface. The EUT and simulators are connected to the main power through a line impedance stabilization network (LISN). The LISN provides a 50 ohm /50uH coupling impedance for the measuring equipment. The peripheral devices are also connected to the main power through a LISN. (Please refer to the block diagram of the test setup and photographs) Each current-carrying conductor of the EUT power cord, except the ground (safety) conductor, was individually connected through a LISN to the input power source. The excess length of the power cord between the EUT and the LISN receptacle were folded back and forth at the center of the lead to form a bundle not exceeding 40 cm in length. Conducted emissions were investigated over the frequency range from 0.15MHz to 30MHz using a receiver bandwidth of 9kHz.



5.3 Typical Test Setup

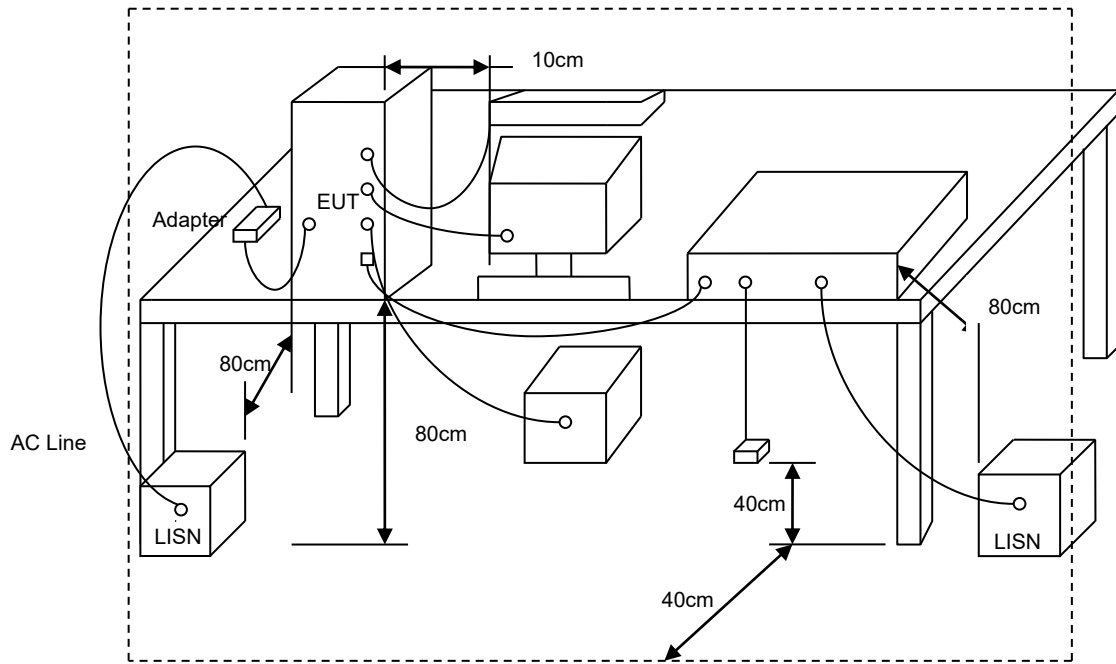



5.4 Test Result and Data

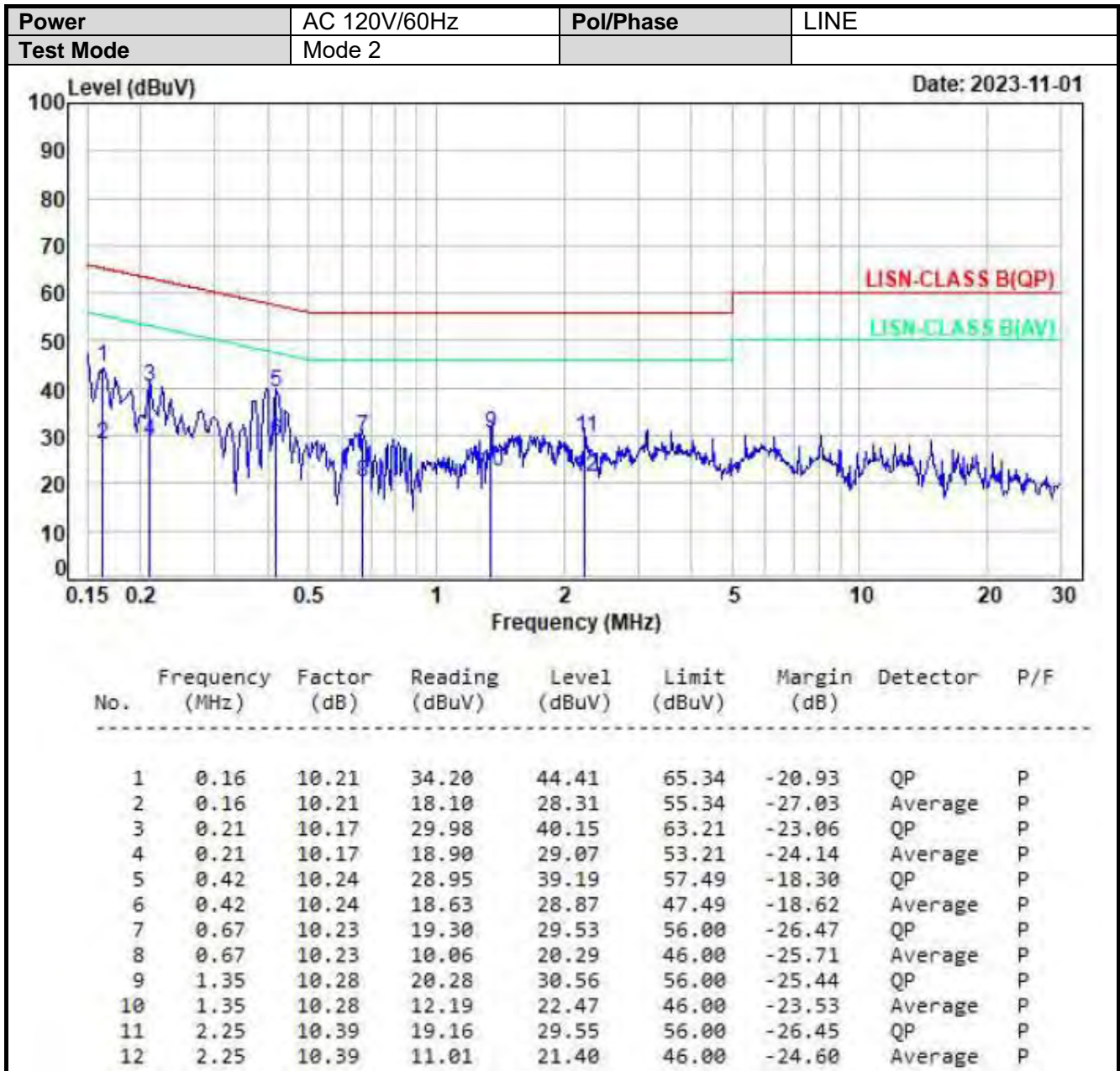

Note: Measurement Level = Reading Level + Correct Factor

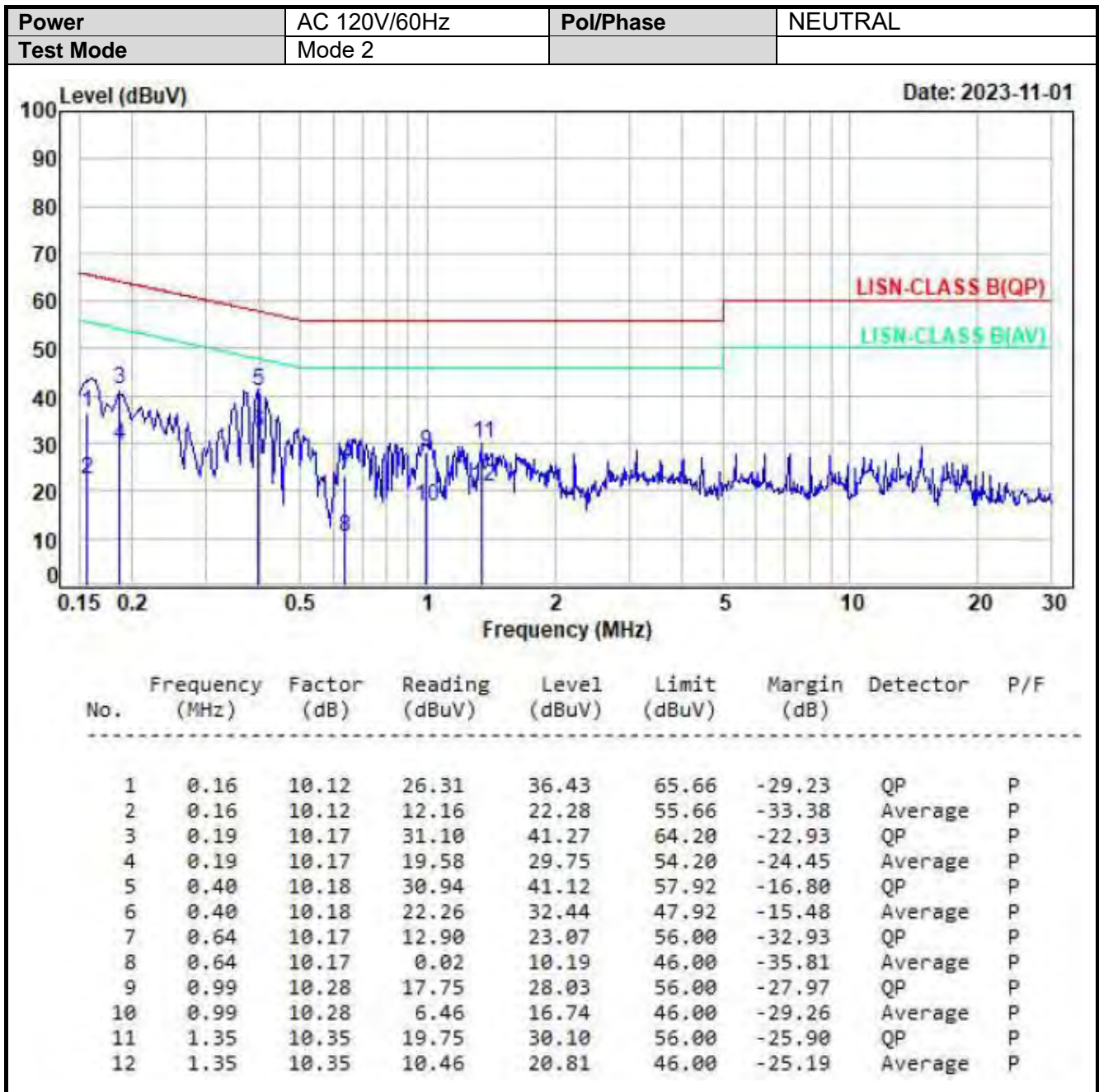

Note: Measurement Level = Reading Level + Correct Factor



6. Test of Spurious Emission (Radiated)

6.1 Test Limit

In any 100kHz bandwidth outside the frequency band in which the spread spectrum or digitally modulated intentional radiator is operating, the radio frequency power that is produced by the intentional radiator shall be at least 20dB below that in the 100kHz bandwidth within the band that contains the highest level of the desired power, based on either an RF conducted or a radiated measurement. If the transmitter measurement is based on the maximum conducted output power, the attenuation required under this paragraph shall be 30dB instead of 20dB. In addition, radiated emissions which fall in section 15.205(a) the restricted bands must also comply with the radiated emission limit specified in section 15.209(a).

FREQUENCIES(MHz)	FIELD STRENGTH (microvolts/meter)	MEASUREMENT DISTANCE(meters)
0.009~0.490	2400/F(kHz)	300
0.490~1.705	24000/F(kHz)	30
1.705~30.0	30	30
30~88	100	3
88~216	150	3
216~960	200	3
Above 960	500	3

6.2 Test Procedures

- The EUT was placed on a rotatable table top 0.8 meter for frequency below 1GHz and 1.5meter for frequency above 1GHz above ground.
- The EUT was set 3 meters from the interference receiving antenna which was mounted on the top of a variable height antenna tower.
- The table was rotated 360 degrees to determine the position of the highest radiation.
- The antenna is a broadband antenna and its height is varied between one meter and four meters above ground to find the maximum value of the field strength both horizontal polarization and vertical polarization of the antenna are set to make the measurement.
- For each suspected emission the EUT was arranged to its worst case and then tune the antenna tower (from 1 M to 4 M) and turn table (from 0 degree to 360 degrees) to find the maximum reading.
- Set the test-receiver system to Peak or CISPR quasi-peak Detect Function and specified bandwidth with Maximum Hold Mode.
- If the emission level of the EUT in peak mode was 3 dB lower than the limit specified, then testing will be stopped and peak values of EUT will be reported, otherwise, the emissions which do not have 3 dB margin will be repeated one by one using the quasi-peak method and reported.
- For testing above 1GHz, the emission level of the EUT in peak mode was 20dB lower than AVG limit (that means the emission level in peak mode also complies with the limit in AVG mode), then testing will be stopped and peak values of EUT will be reported, otherwise, the emissions will be measured in AVG mode again and reported.
- “Cone of radiation” has been considered to be 3dB bandwidth of the measurement antenna.
Note: The supporting fixture shall permit orientation of the EUT in each of three orthogonal axis positions sch that emissions from the EUT are maximized.

(X-AXIS is the worst.)



6.3 Typical Test Setup

Below 30MHz test setup

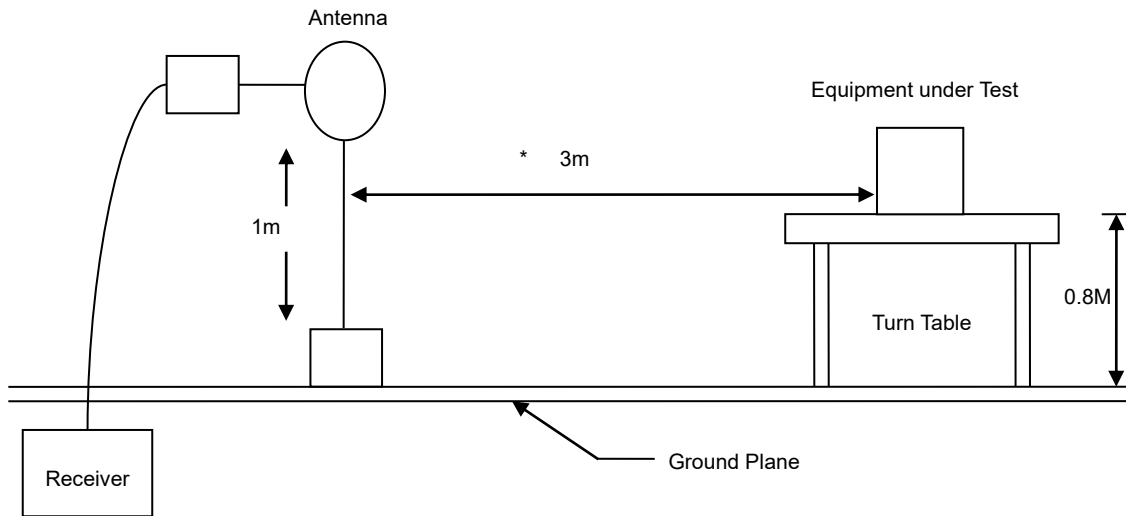

30MHz- 1GHz Test Setup

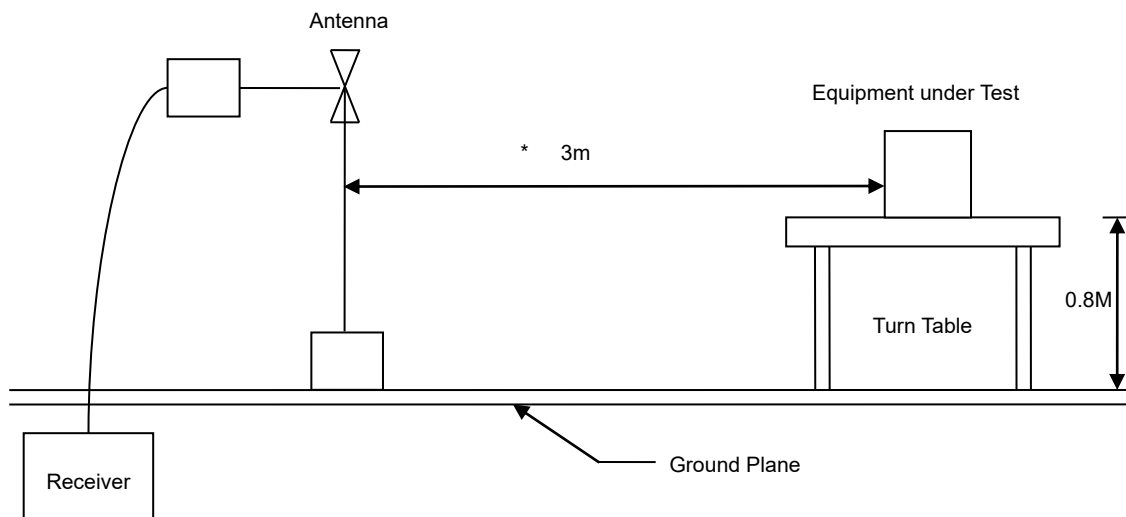

Above 1GHz Test Setup

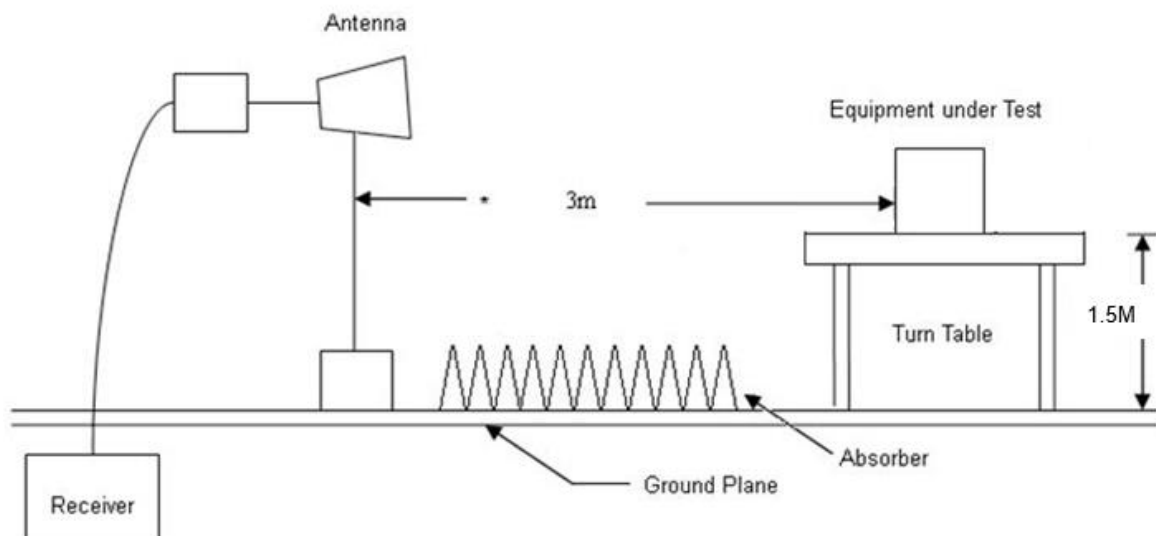



6.4 Test Result and Data (9KHz ~ 30MHz)

The 9kHz-30MHz spurious emission is under limit 20dB more.

6.5 Test Result and Data (30MHz ~ 1GHz)

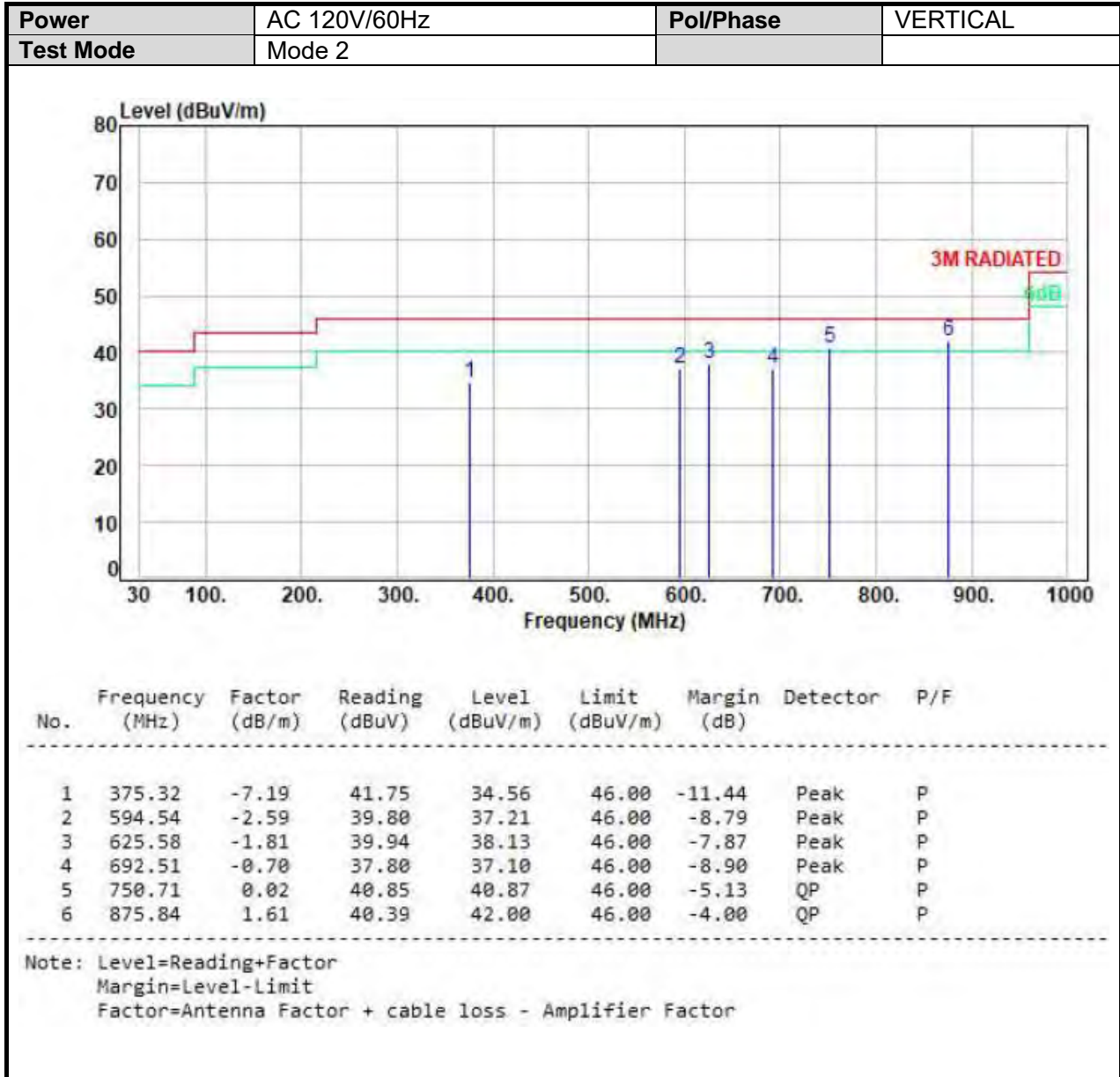

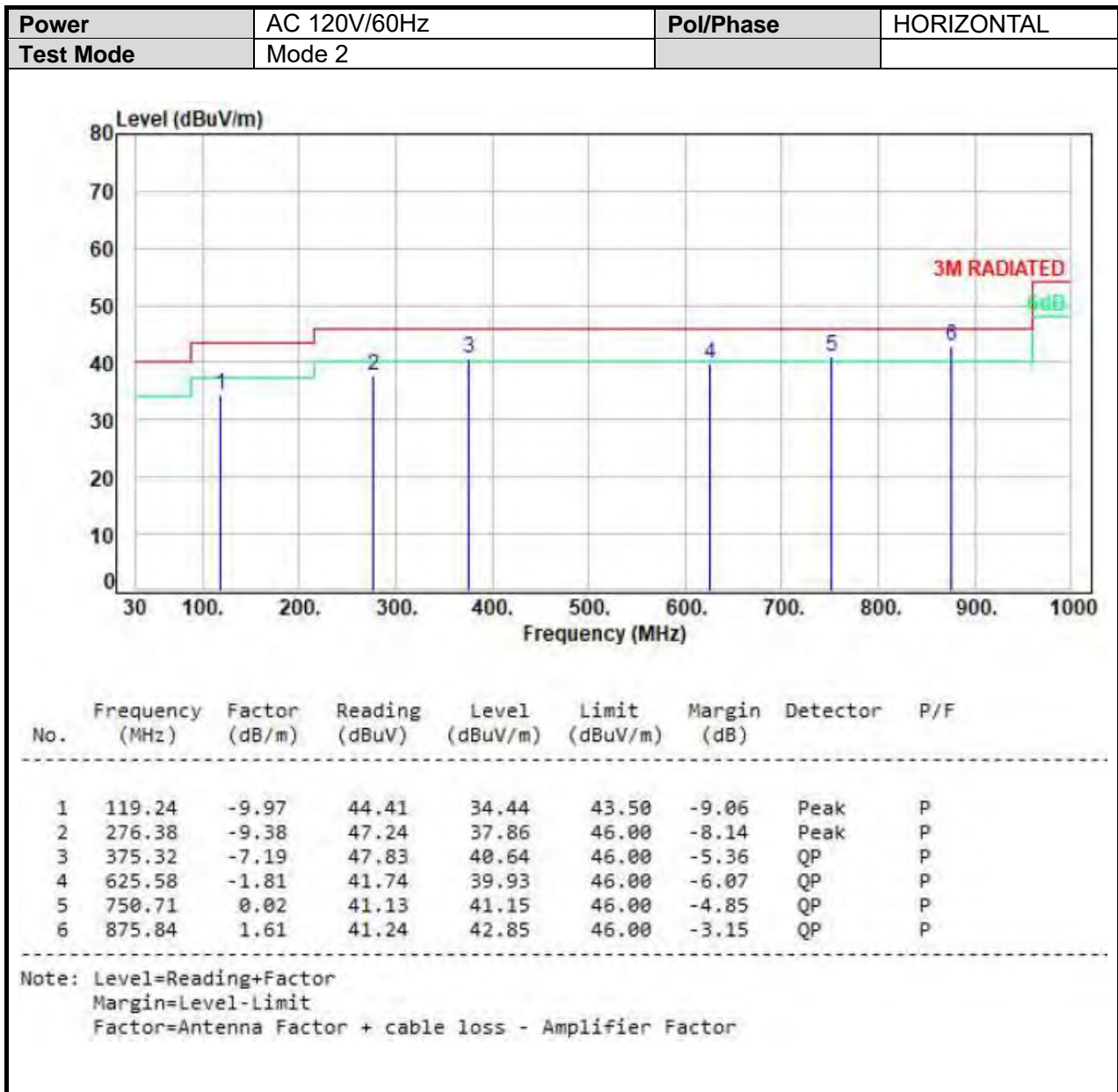



6.6 Test Result and Data (1GHz ~ 25GHz)

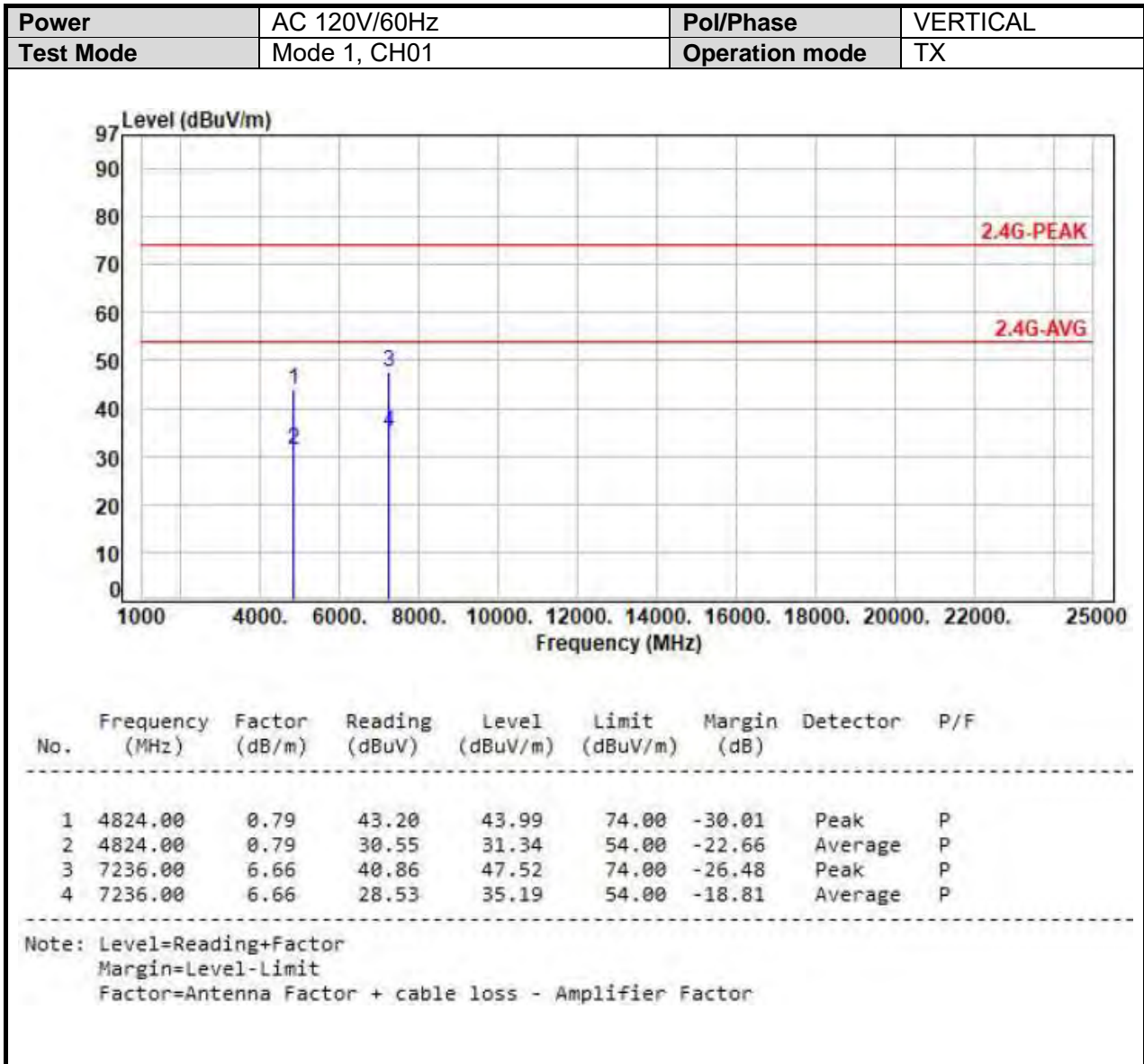



Power	AC 120V/60Hz	Pol/Phase	HORIZONTAL
Test Mode	Mode 1, CH01	Operation mode	TX

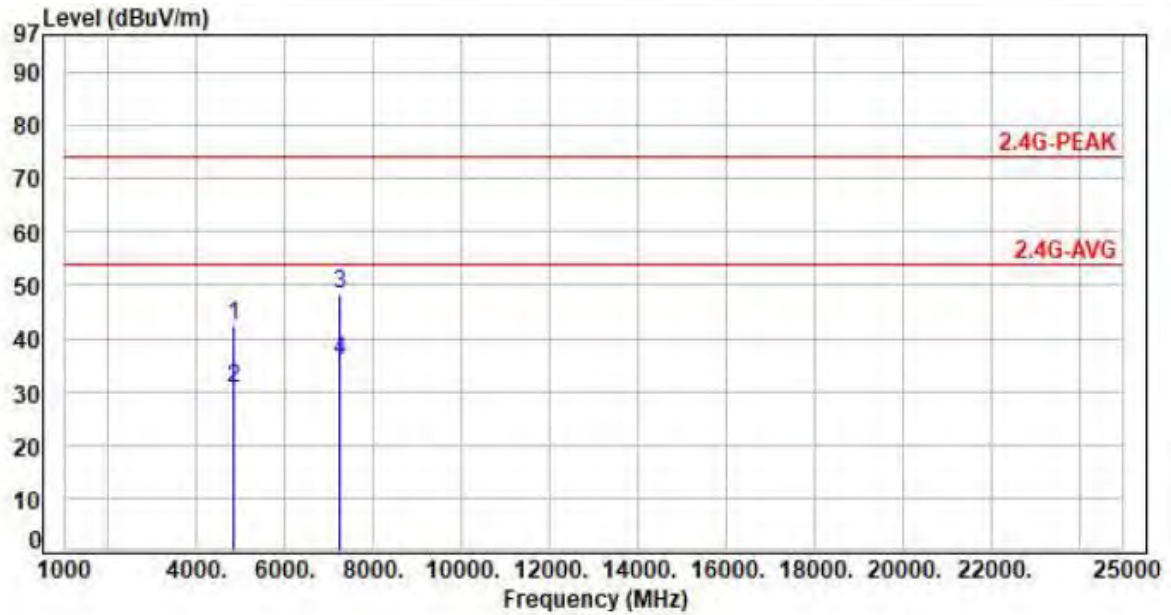

No.	Frequency (MHz)	Factor (dB/m)	Reading (dBuV)	Level (dBuV/m)	Limit (dBuV/m)	Margin (dB)	Detector	P/F
1	4824.00	0.79	41.52	42.31	74.00	-31.69	Peak	P
2	4824.00	0.79	29.93	30.72	54.00	-23.28	Average	P
3	7236.00	6.66	41.54	48.20	74.00	-25.80	Peak	P
4	7236.00	6.66	29.09	35.75	54.00	-18.25	Average	P

Note: Level=Reading+Factor
Margin=Level-Limit
Factor=Antenna Factor + cable loss - Amplifier Factor

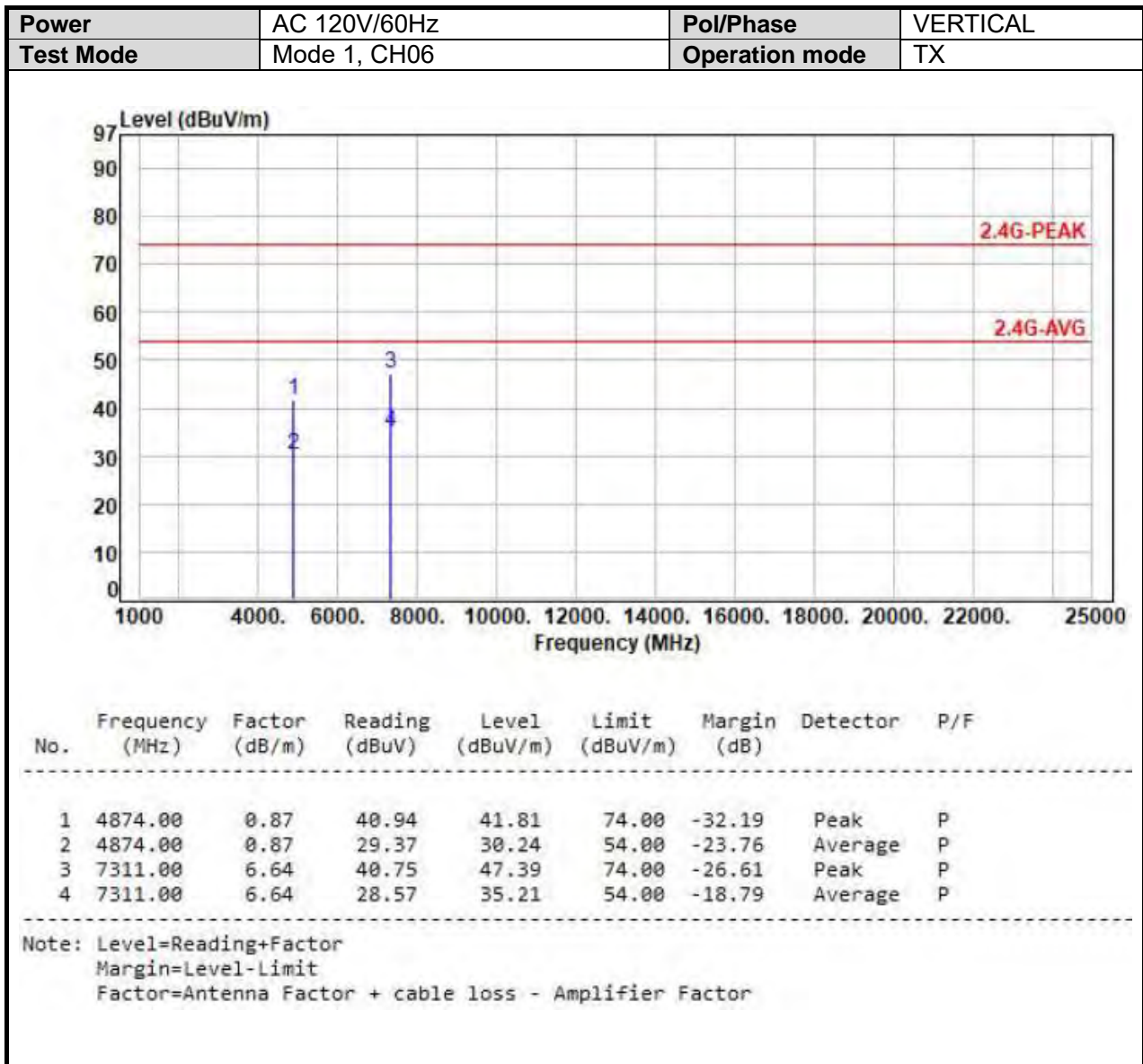



Power	AC 120V/60Hz	Pol/Phase	HORIZONTAL
Test Mode	Mode 1, CH06	Operation mode	TX

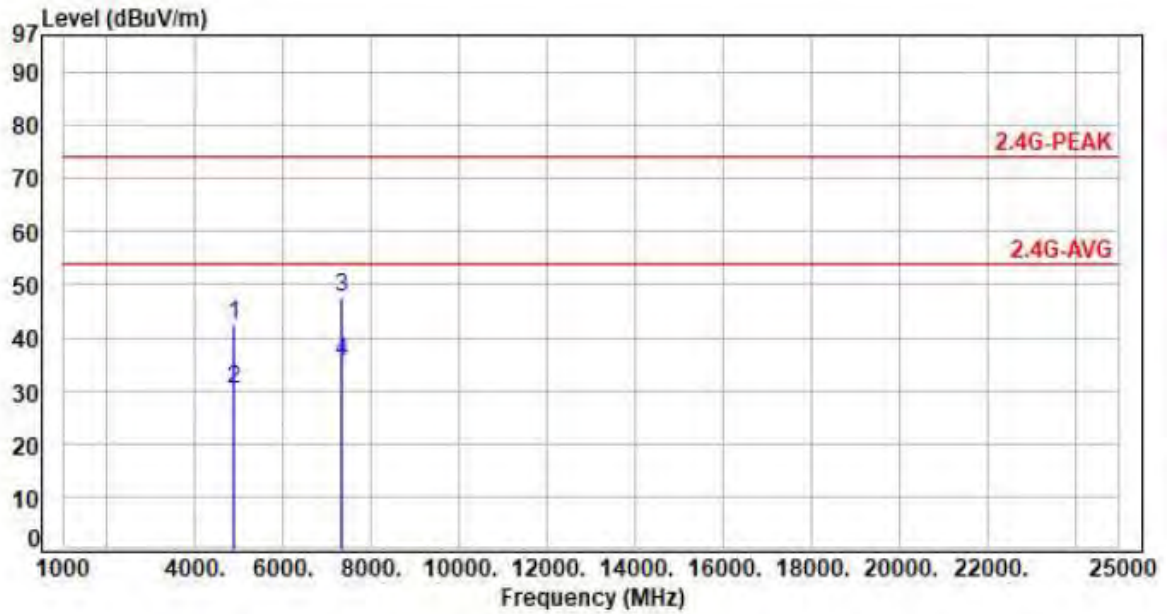

No.	Frequency (MHz)	Factor (dB/m)	Reading (dBuV)	Level (dBuV/m)	Limit (dBuV/m)	Margin (dB)	Detector	P/F
1	4874.00	0.87	41.69	42.56	74.00	-31.44	Peak	P
2	4874.00	0.87	29.51	30.38	54.00	-23.62	Average	P
3	7311.00	6.64	40.90	47.54	74.00	-26.46	Peak	P
4	7311.00	6.64	28.88	35.52	54.00	-18.48	Average	P

Note: Level=Reading+Factor
Margin=Level-Limit
Factor=Antenna Factor + cable loss - Amplifier Factor



Power	AC 120V/60Hz	Pol/Phase	VERTICAL
Test Mode	Mode 1, CH11	Operation mode	TX

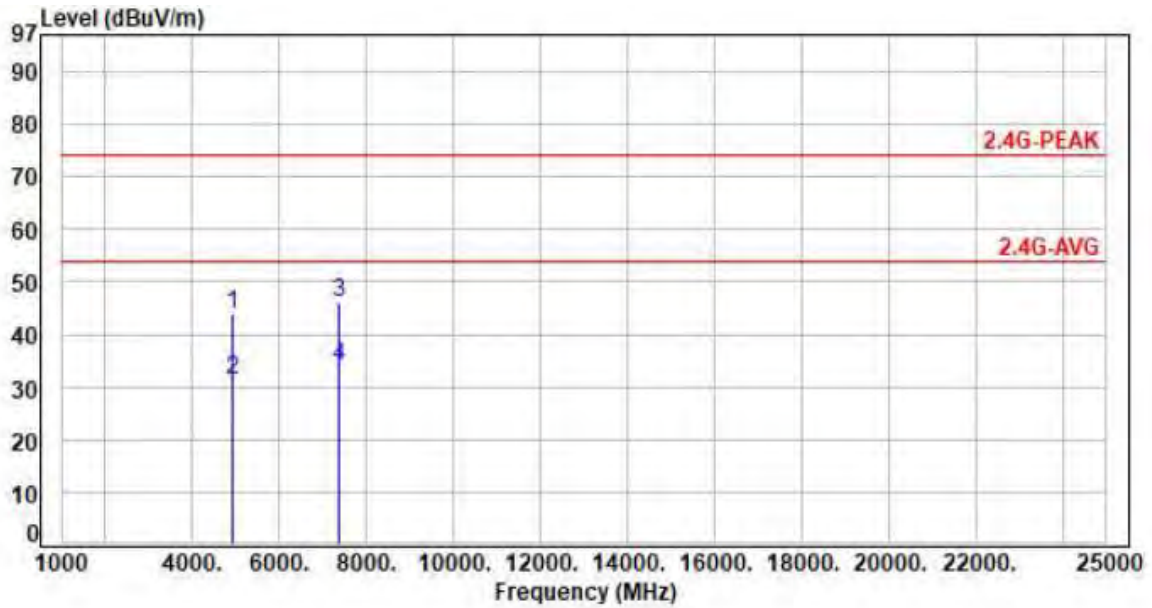

No.	Frequency (MHz)	Factor (dB/m)	Reading (dBuV)	Level (dBuV/m)	Limit (dBuV/m)	Margin (dB)	Detector	P/F
1	4924.00	0.95	42.82	43.77	74.00	-30.23	Peak	P
2	4924.00	0.95	30.42	31.37	54.00	-22.63	Average	P
3	7386.00	6.65	39.44	46.09	74.00	-27.91	Peak	P
4	7386.00	6.65	27.28	33.93	54.00	-20.07	Average	P

Note: Level=Reading+Factor
Margin=Level-Limit
Factor=Antenna Factor + cable loss - Amplifier Factor



Power	AC 120V/60Hz	Pol/Phase	HORIZONTAL
Test Mode	Mode 1, CH11	Operation mode	TX

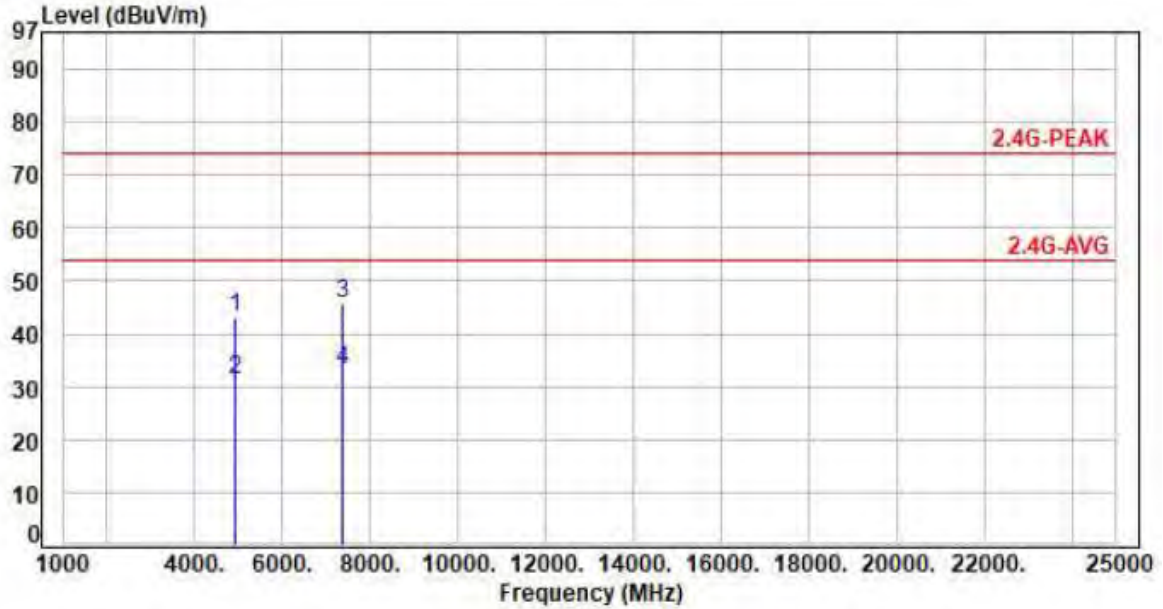

No.	Frequency (MHz)	Factor (dB/m)	Reading (dBuV)	Level (dBuV/m)	Limit (dBuV/m)	Margin (dB)	Detector	P/F
1	4924.00	0.95	42.03	42.98	74.00	-31.02	Peak	P
2	4924.00	0.95	30.33	31.28	54.00	-22.72	Average	P
3	7386.00	6.65	39.26	45.91	74.00	-28.09	Peak	P
4	7386.00	6.65	26.55	33.20	54.00	-20.80	Average	P

Note: Level=Reading+Factor
 Margin=Level-Limit
 Factor=Antenna Factor + cable loss - Amplifier Factor



Power	AC 120V/60Hz	Pol/Phase	VERTICAL
Test Mode	Mode 2, CH01	Operation mode	TX

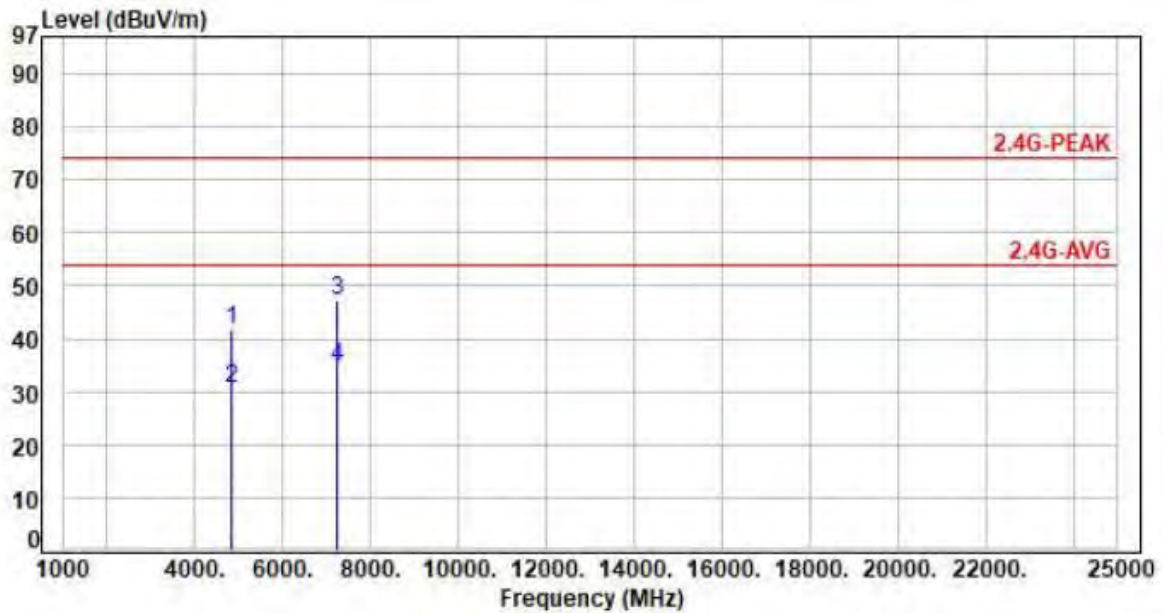

No.	Frequency (MHz)	Factor (dB/m)	Reading (dBuV)	Level (dBuV/m)	Limit (dBuV/m)	Margin (dB)	Detector	P/F
1	4824.00	0.79	40.89	41.68	74.00	-32.32	Peak	P
2	4824.00	0.79	29.75	30.54	54.00	-23.46	Average	P
3	7236.00	6.66	40.66	47.32	74.00	-26.68	Peak	P
4	7236.00	6.66	27.90	34.56	54.00	-19.44	Average	P

Note: Level=Reading+Factor
Margin=Level-Limit
Factor=Antenna Factor + cable loss - Amplifier Factor



Power	AC 120V/60Hz	Pol/Phase	HORIZONTAL
Test Mode	Mode 2, CH01	Operation mode	TX

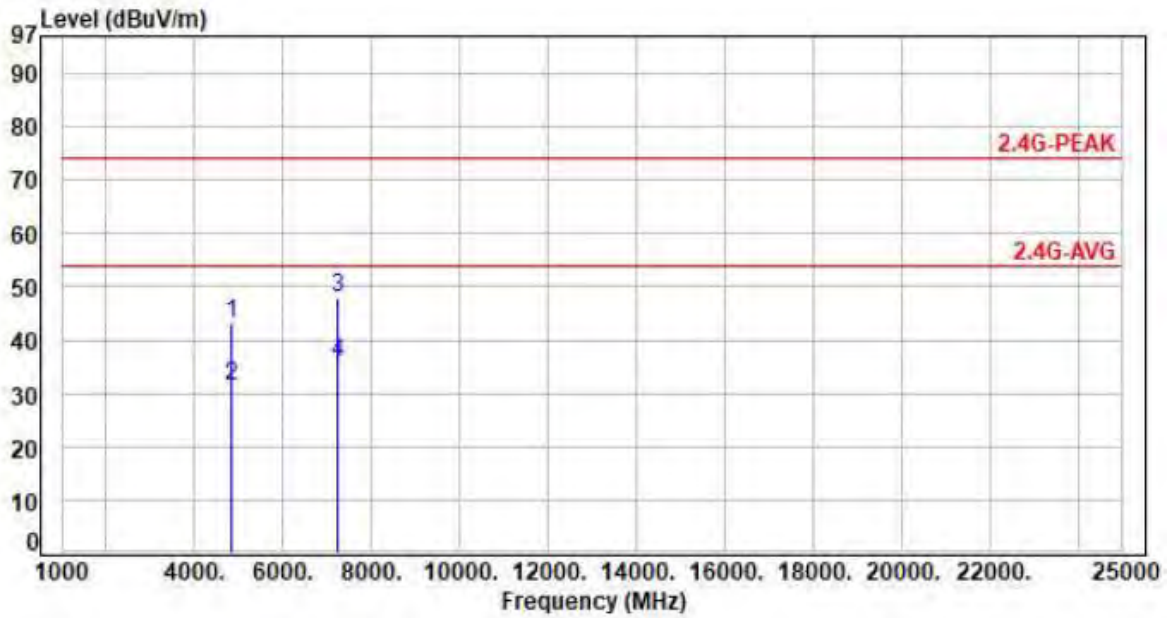

No.	Frequency (MHz)	Factor (dB/m)	Reading (dBuV)	Level (dBuV/m)	Limit (dBuV/m)	Margin (dB)	Detector	P/F
1	4824.00	0.79	42.37	43.16	74.00	-30.84	Peak	P
2	4824.00	0.79	30.41	31.20	54.00	-22.80	Average	P
3	7236.00	6.66	41.29	47.95	74.00	-26.05	Peak	P
4	7236.00	6.66	29.00	35.66	54.00	-18.34	Average	P

Note: Level=Reading+Factor
Margin=Level-Limit
Factor=Antenna Factor + cable loss - Amplifier Factor



Power	AC 120V/60Hz	Pol/Phase	VERTICAL
Test Mode	Mode 2, CH06	Operation mode	TX

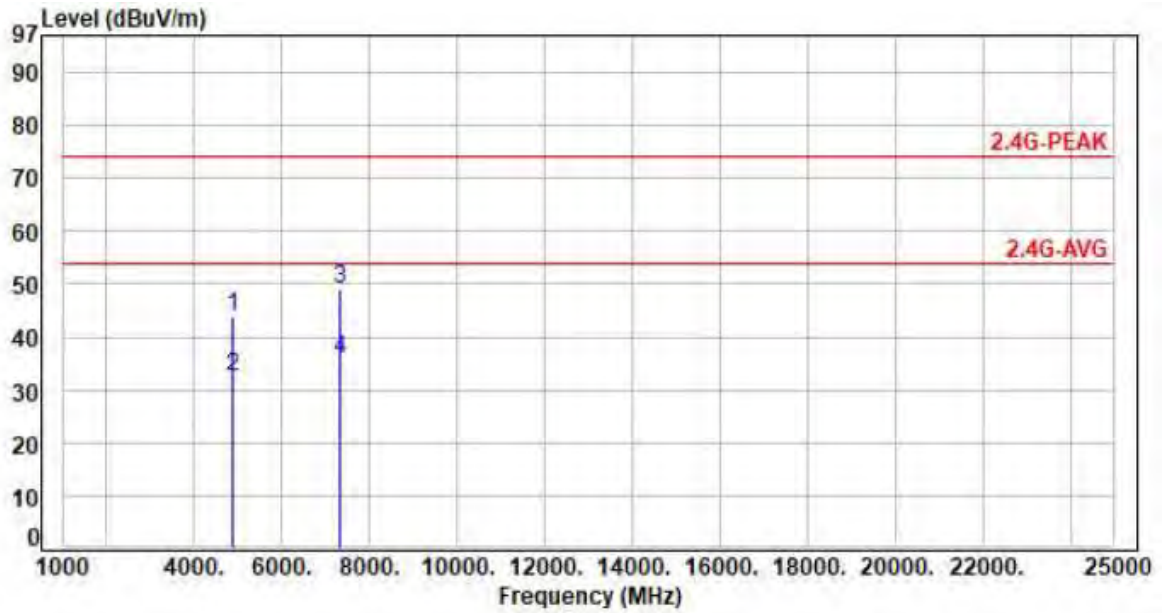

No.	Frequency (MHz)	Factor (dB/m)	Reading (dBuV)	Level (dBuV/m)	Limit (dBuV/m)	Margin (dB)	Detector	P/F
1	4874.00	0.87	42.88	43.75	74.00	-30.25	Peak	P
2	4874.00	0.87	31.65	32.52	54.00	-21.48	Average	P
3	7311.00	6.64	42.30	48.94	74.00	-25.06	Peak	P
4	7311.00	6.64	29.05	35.69	54.00	-18.31	Average	P

Note: Level=Reading+Factor
Margin=Level-Limit
Factor=Antenna Factor + cable loss - Amplifier Factor



Power	AC 120V/60Hz	Pol/Phase	HORIZONTAL
Test Mode	Mode 2, CH06	Operation mode	TX

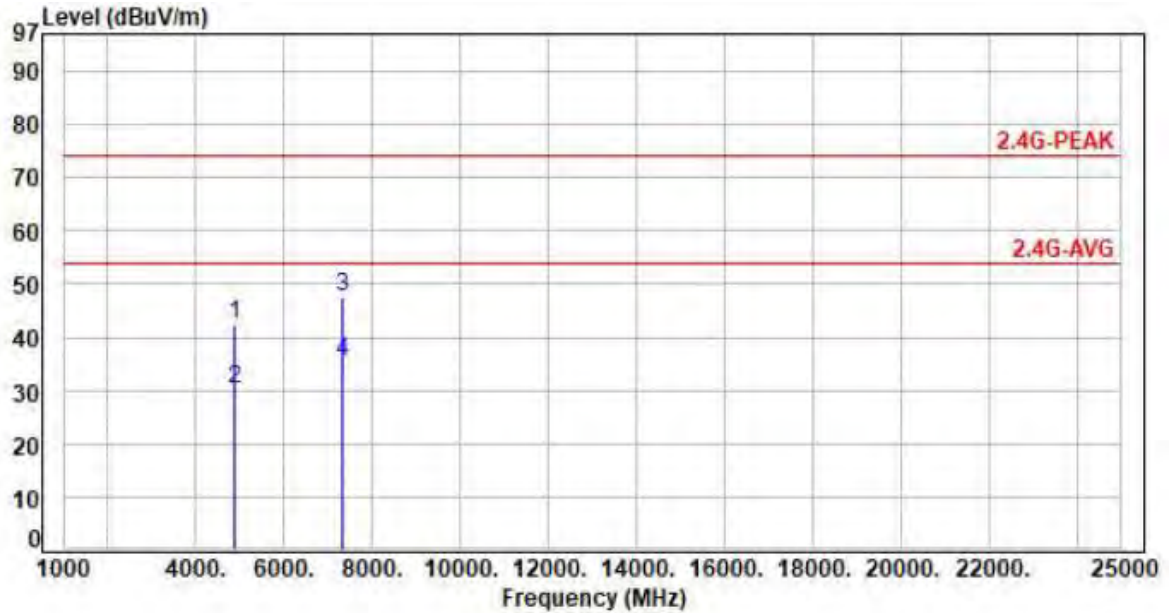

No.	Frequency (MHz)	Factor (dB/m)	Reading (dBuV)	Level (dBuV/m)	Limit (dBuV/m)	Margin (dB)	Detector	P/F
1	4874.00	0.87	41.66	42.53	74.00	-31.47	Peak	P
2	4874.00	0.87	29.48	30.35	54.00	-23.65	Average	P
3	7311.00	6.64	40.76	47.40	74.00	-26.60	Peak	P
4	7311.00	6.64	28.87	35.51	54.00	-18.49	Average	P

Note: Level=Reading+Factor
 Margin=Level-Limit
 Factor=Antenna Factor + cable loss - Amplifier Factor



Power	AC 120V/60Hz	Pol/Phase	VERTICAL
Test Mode	Mode 2, CH11	Operation mode	TX

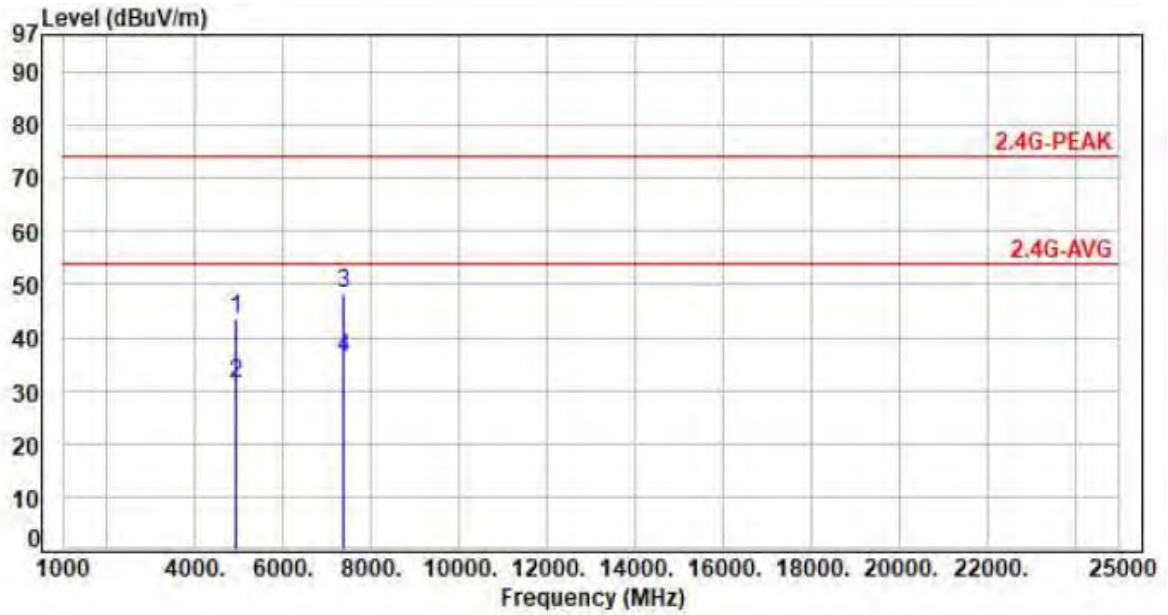

No.	Frequency (MHz)	Factor (dB/m)	Reading (dBuV)	Level (dBuV/m)	Limit (dBuV/m)	Margin (dB)	Detector	P/F
1	4924.00	0.95	42.45	43.40	74.00	-30.60	Peak	P
2	4924.00	0.95	30.40	31.35	54.00	-22.65	Average	P
3	7356.00	6.65	41.66	48.31	74.00	-25.69	Peak	P
4	7356.00	6.65	29.58	36.23	54.00	-17.77	Average	P

Note: Level=Reading+Factor
Margin=Level-Limit
Factor=Antenna Factor + cable loss - Amplifier Factor



Power	AC 120V/60Hz	Pol/Phase	HORIZONTAL
Test Mode	Mode 2, CH11	Operation mode	TX

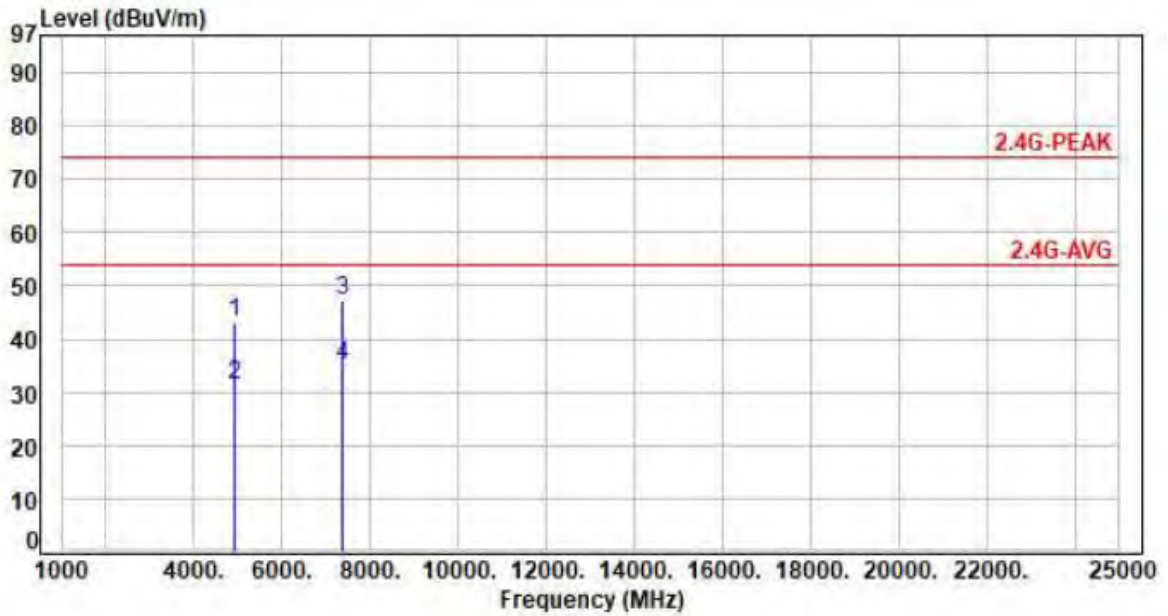

No.	Frequency (MHz)	Factor (dB/m)	Reading (dBuV)	Level (dBuV/m)	Limit (dBuV/m)	Margin (dB)	Detector	P/F
1	4924.00	0.95	42.15	43.10	74.00	-30.90	Peak	P
2	4924.00	0.95	30.32	31.27	54.00	-22.73	Average	P
3	7356.00	6.65	40.43	47.08	74.00	-26.92	Peak	P
4	7356.00	6.65	28.47	35.12	54.00	-18.88	Average	P

Note: Level=Reading+Factor
Margin=Level-Limit
Factor=Antenna Factor + cable loss - Amplifier Factor



Power	AC 120V/60Hz	Pol/Phase	VERTICAL
Test Mode	Mode 3, CH01	Operation mode	TX

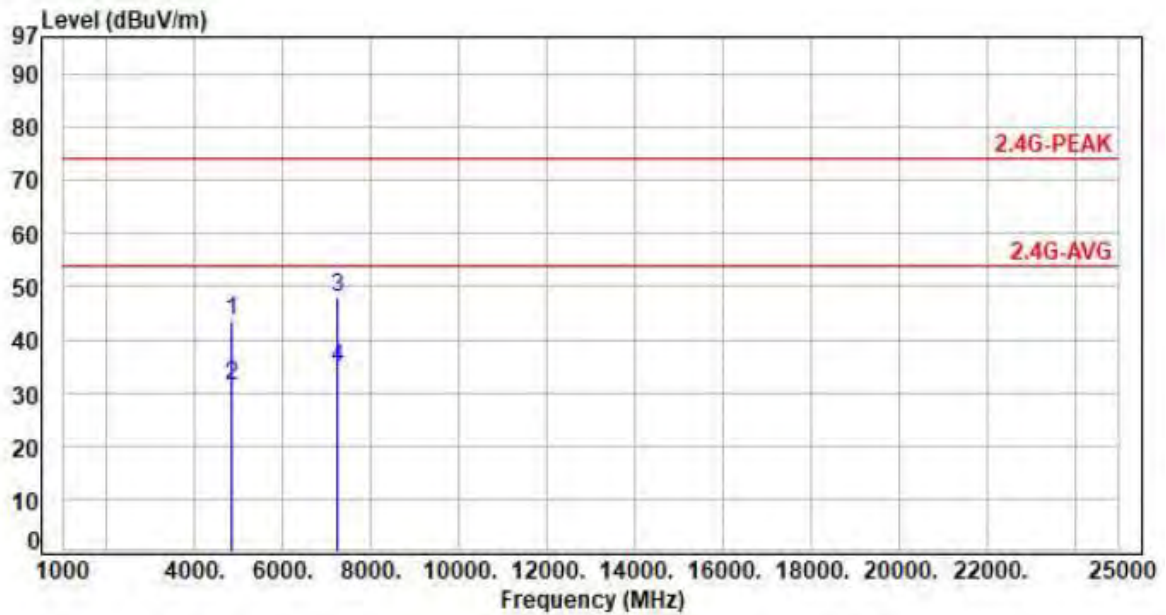

No.	Frequency (MHz)	Factor (dB/m)	Reading (dBuV)	Level (dBuV/m)	Limit (dBuV/m)	Margin (dB)	Detector	P/F
1	4824.00	0.79	42.78	43.57	74.00	-30.43	Peak	P
2	4824.00	0.79	30.57	31.36	54.00	-22.64	Average	P
3	7236.00	6.66	41.15	47.81	74.00	-26.19	Peak	P
4	7236.00	6.66	27.99	34.65	54.00	-19.35	Average	P

Note: Level=Reading+Factor
Margin=Level-Limit
Factor=Antenna Factor + cable loss - Amplifier Factor



Power	AC 120V/60Hz	Pol/Phase	HORIZONTAL
Test Mode	Mode 3, CH01	Operation mode	TX

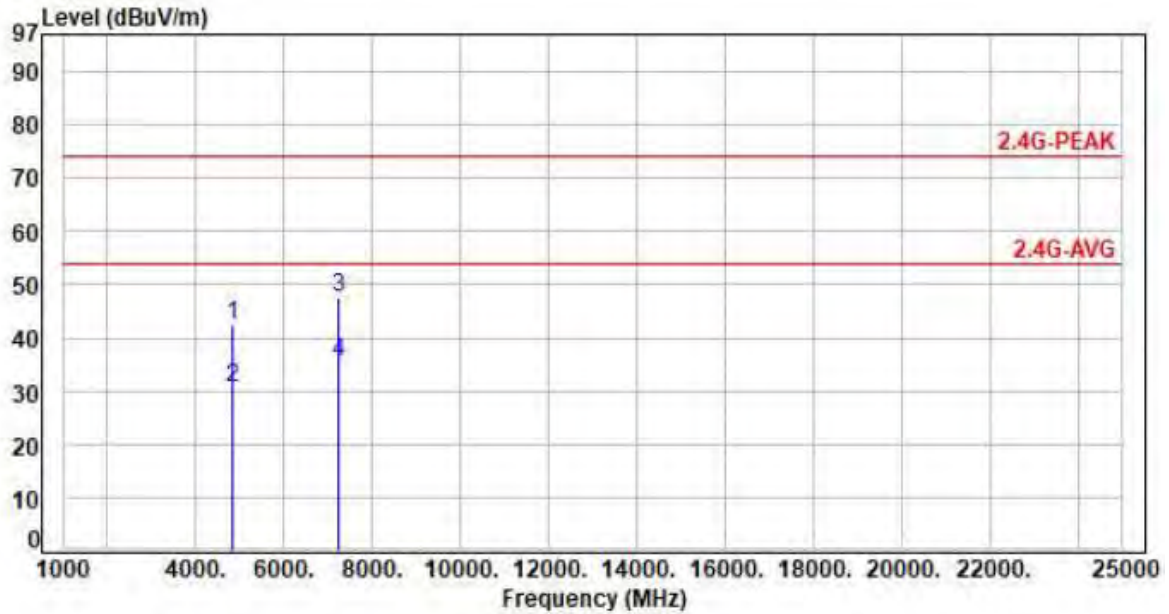

No.	Frequency (MHz)	Factor (dB/m)	Reading (dBuV)	Level (dBuV/m)	Limit (dBuV/m)	Margin (dB)	Detector	P/F
1	4824.00	0.79	41.76	42.55	74.00	-31.45	Peak	P
2	4824.00	0.79	29.82	30.61	54.00	-23.39	Average	P
3	7236.00	6.66	40.76	47.42	74.00	-26.58	Peak	P
4	7236.00	6.66	28.69	35.35	54.00	-18.65	Average	P

Note: Level=Reading+Factor
Margin=Level-Limit
Factor=Antenna Factor + cable loss - Amplifier Factor

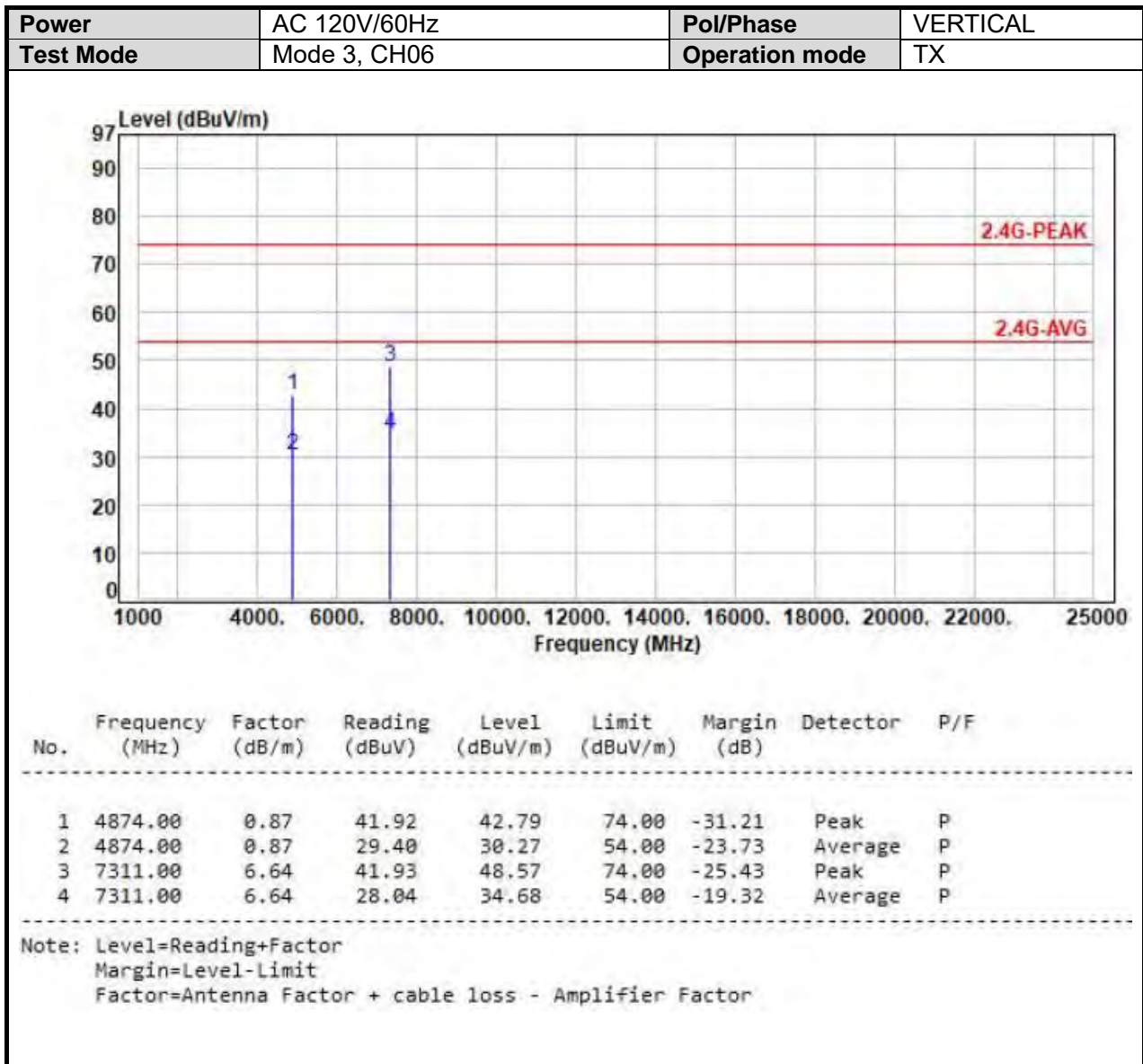



Power	AC 120V/60Hz	Pol/Phase	HORIZONTAL
Test Mode	Mode 3, CH06	Operation mode	TX

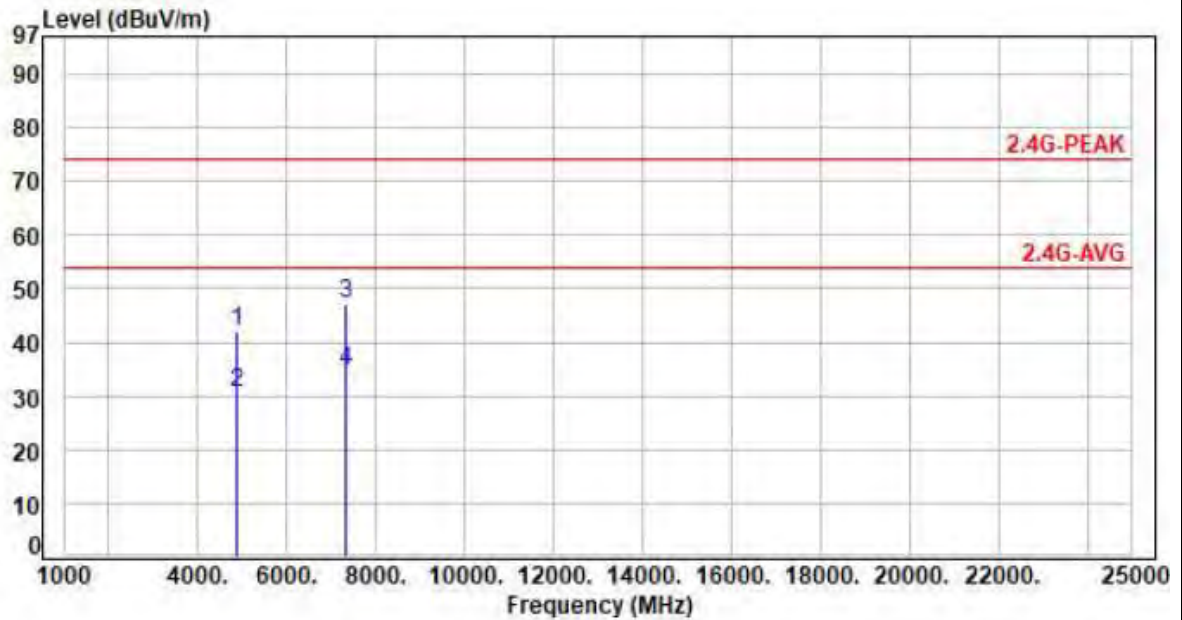

No.	Frequency (MHz)	Factor (dB/m)	Reading (dBuV)	Level (dBuV/m)	Limit (dBuV/m)	Margin (dB)	Detector	P/F
1	4874.00	0.87	41.36	42.23	74.00	-31.77	Peak	P
2	4874.00	0.87	29.68	30.55	54.00	-23.45	Average	P
3	7311.00	6.64	40.49	47.13	74.00	-26.87	Peak	P
4	7311.00	6.64	28.04	34.68	54.00	-19.32	Average	P

Note: Level=Reading+Factor
Margin=Level-Limit
Factor=Antenna Factor + cable loss - Amplifier Factor

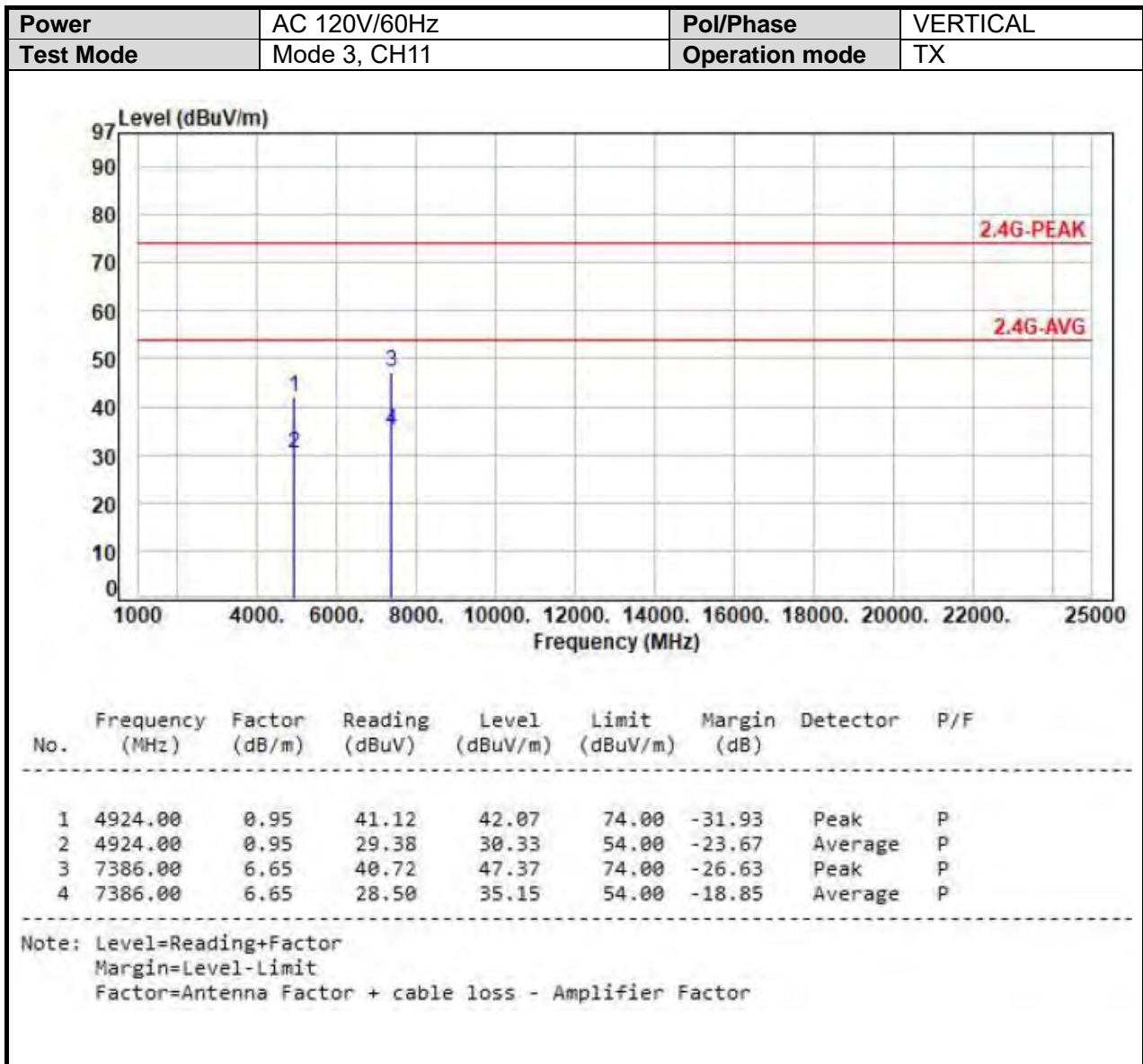



Power	AC 120V/60Hz	Pol/Phase	HORIZONTAL
Test Mode	Mode 3, CH11	Operation mode	TX

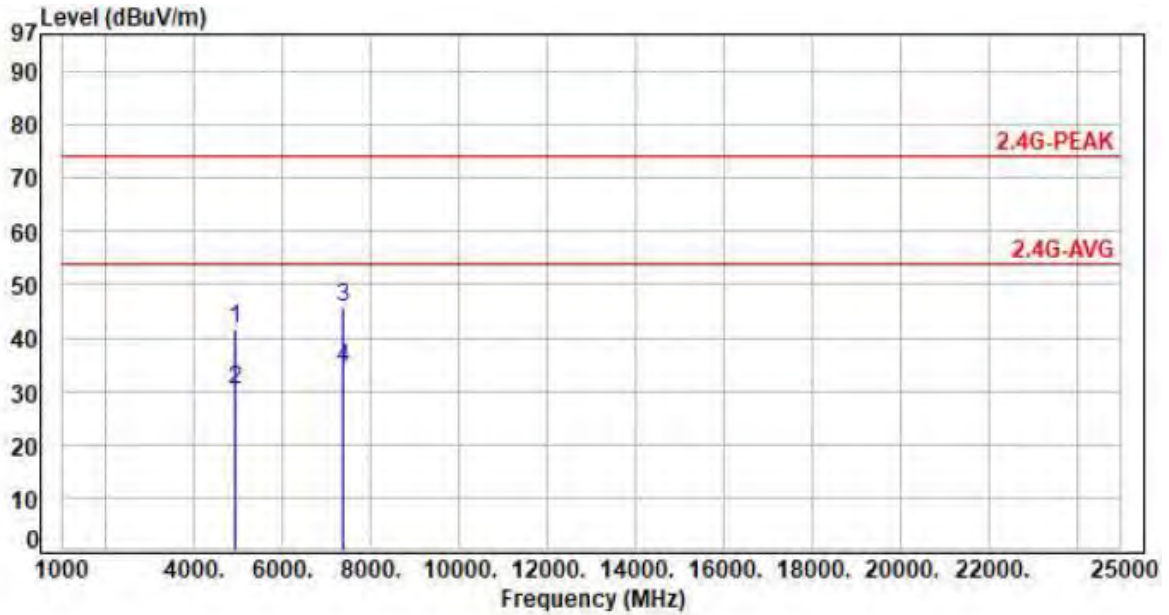

No.	Frequency (MHz)	Factor (dB/m)	Reading (dBuV)	Level (dBuV/m)	Limit (dBuV/m)	Margin (dB)	Detector	P/F
1	4924.00	0.95	40.57	41.52	74.00	-32.48	Peak	P
2	4924.00	0.95	29.43	30.38	54.00	-23.62	Average	P
3	7386.00	6.65	39.07	45.72	74.00	-28.28	Peak	P
4	7386.00	6.65	27.55	34.20	54.00	-19.80	Average	P

Note: Level=Reading+Factor
Margin=Level-Limit
Factor=Antenna Factor + cable loss - Amplifier Factor

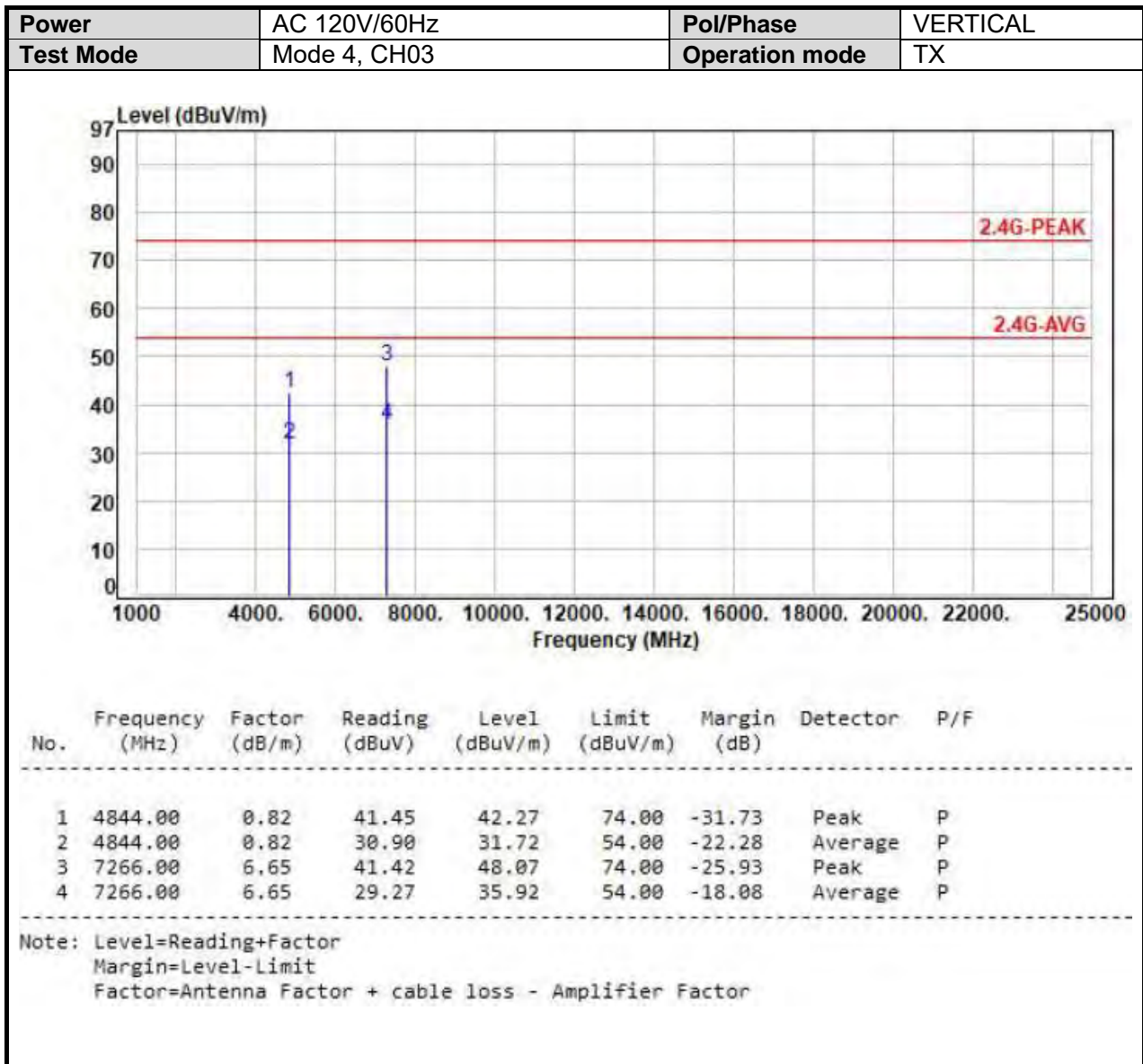



Power	AC 120V/60Hz	Pol/Phase	HORIZONTAL
Test Mode	Mode 4, CH03	Operation mode	TX

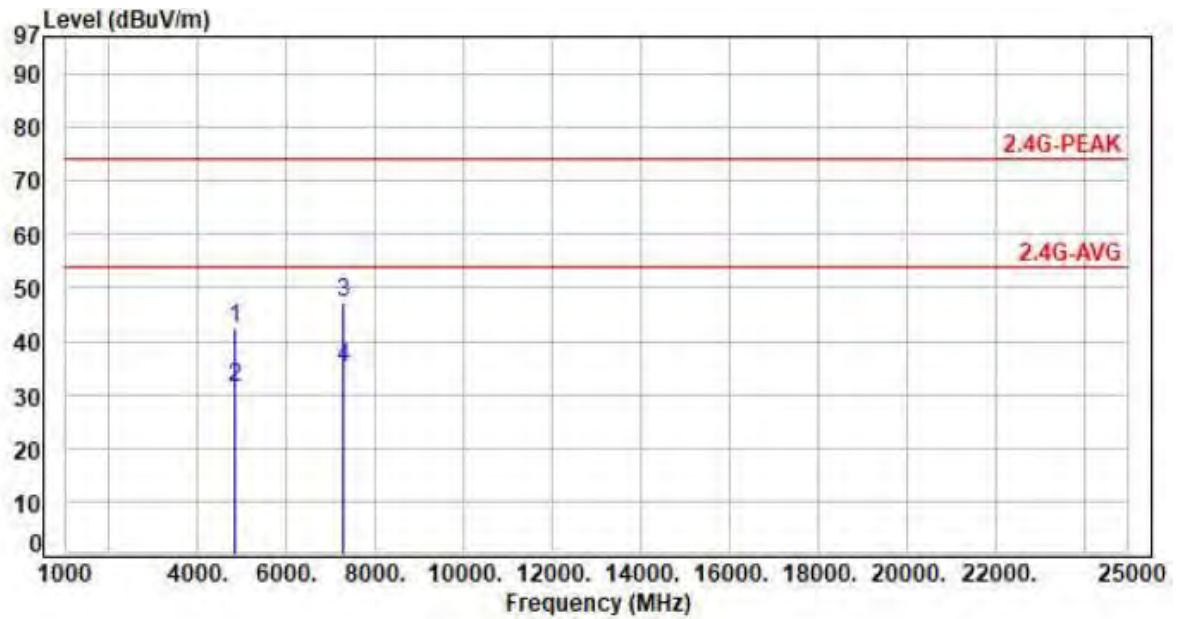

No.	Frequency (MHz)	Factor (dB/m)	Reading (dBuV)	Level (dBuV/m)	Limit (dBuV/m)	Margin (dB)	Detector	P/F
1	4844.00	0.82	41.48	42.30	74.00	-31.70	Peak	P
2	4844.00	0.82	30.42	31.24	54.00	-22.76	Average	P
3	7266.00	6.65	40.47	47.12	74.00	-26.88	Peak	P
4	7266.00	6.65	28.47	35.12	54.00	-18.88	Average	P

Note: Level=Reading+Factor
Margin=Level-Limit
Factor=Antenna Factor + cable loss - Amplifier Factor

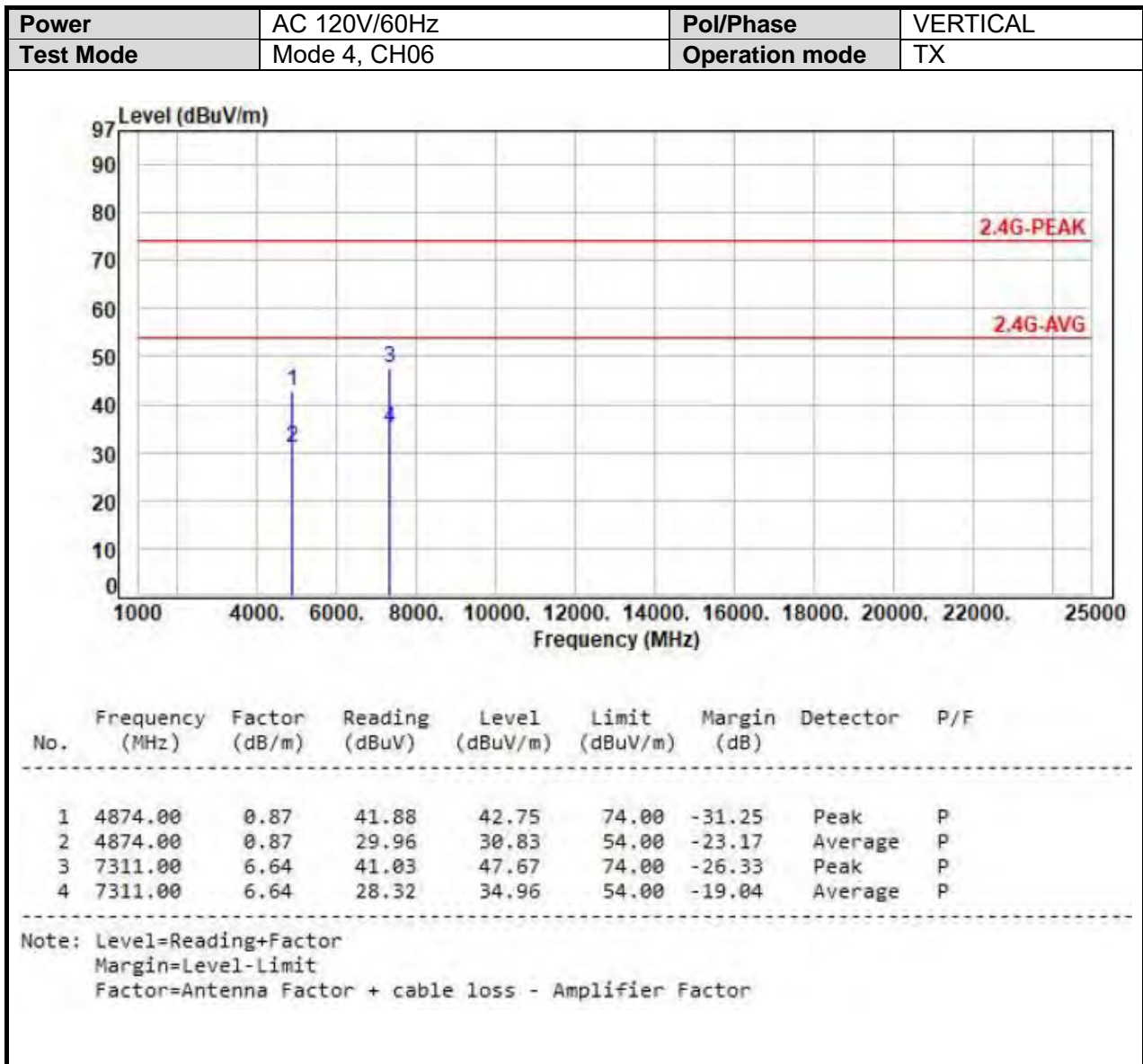



Power	AC 120V/60Hz	Pol/Phase	HORIZONTAL
Test Mode	Mode 4, CH06	Operation mode	TX

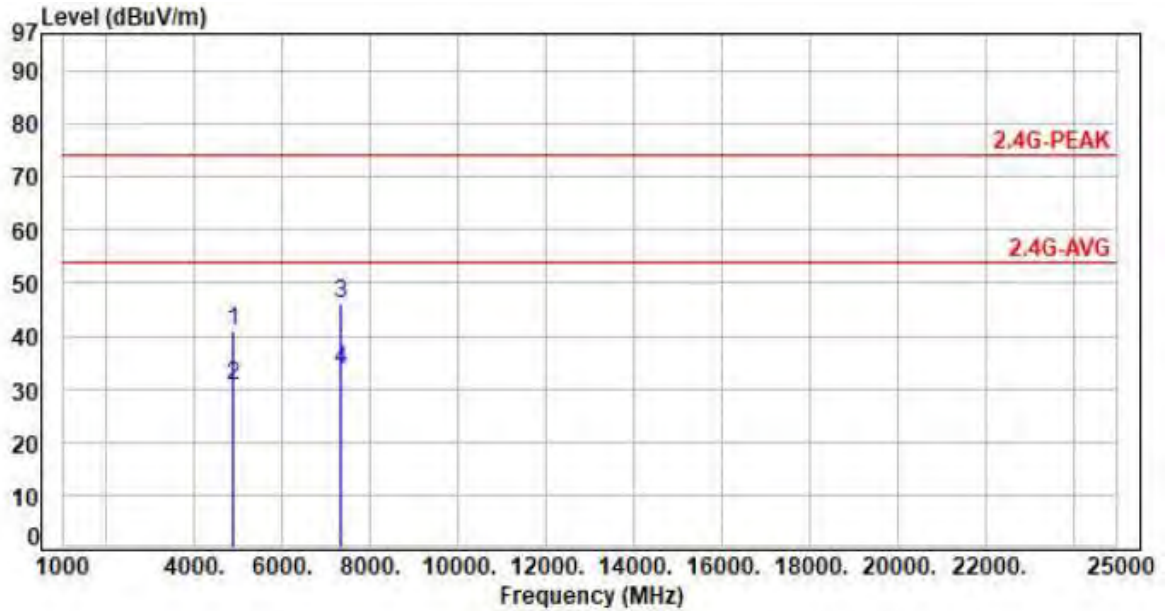

No.	Frequency (MHz)	Factor (dB/m)	Reading (dBuV)	Level (dBuV/m)	Limit (dBuV/m)	Margin (dB)	Detector	P/F
1	4874.00	0.87	40.24	41.11	74.00	-32.89	Peak	P
2	4874.00	0.87	29.56	30.43	54.00	-23.57	Average	P
3	7311.00	6.64	39.42	46.06	74.00	-27.94	Peak	P
4	7311.00	6.64	26.89	33.53	54.00	-20.47	Average	P

Note: Level=Reading+Factor
Margin=Level-Limit
Factor=Antenna Factor + cable loss - Amplifier Factor

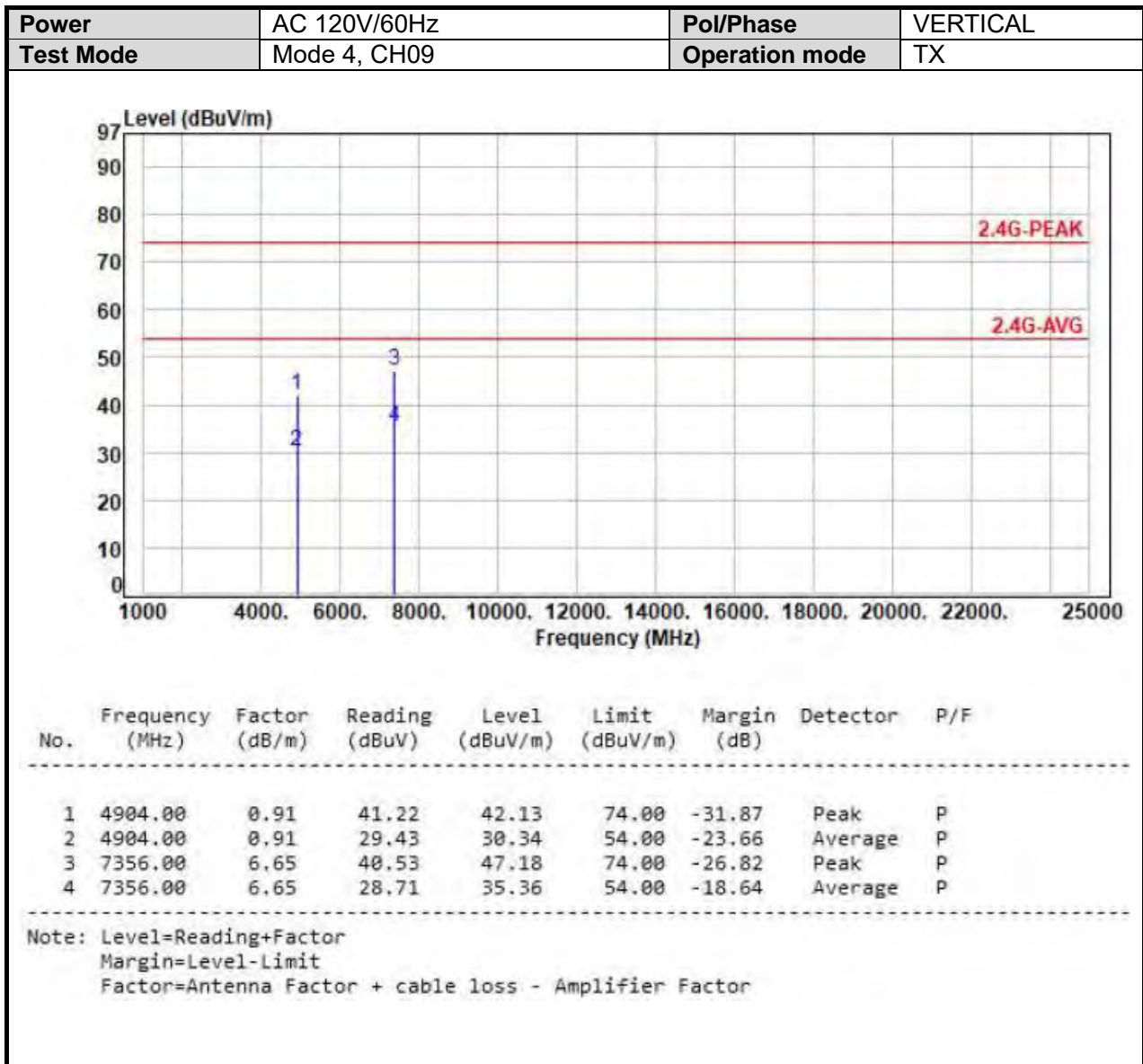



Power	AC 120V/60Hz	Pol/Phase	HORIZONTAL
Test Mode	Mode 4, CH09	Operation mode	TX

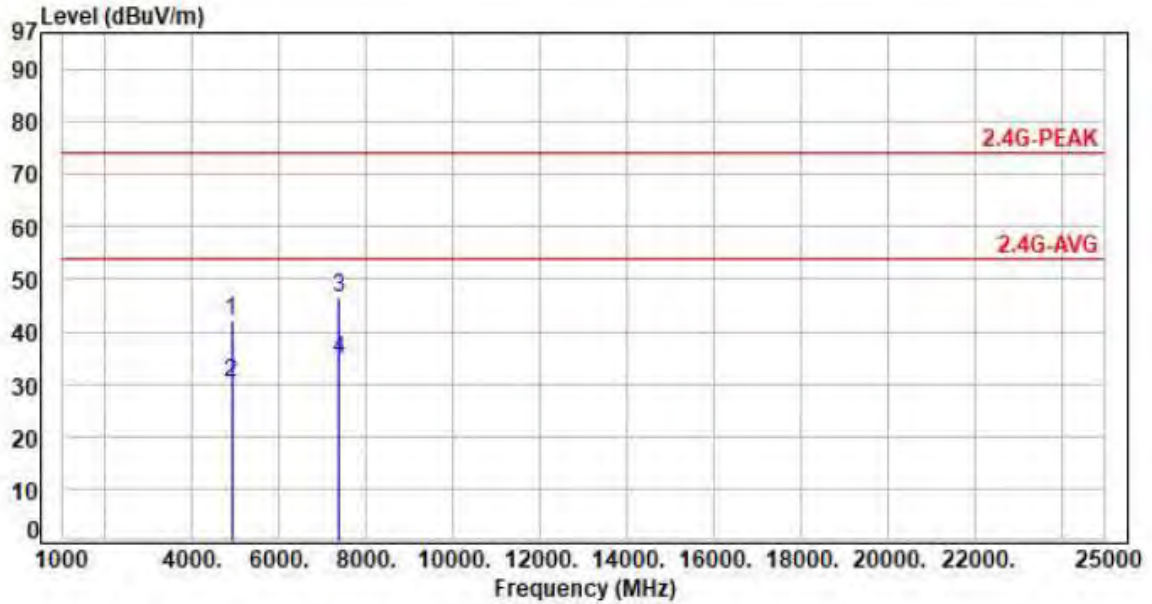

No.	Frequency (MHz)	Factor (dB/m)	Reading (dBuV)	Level (dBuV/m)	Limit (dBuV/m)	Margin (dB)	Detector	P/F
1	4904.00	0.91	41.03	41.94	74.00	-32.06	Peak	P
2	4904.00	0.91	29.33	30.24	54.00	-23.76	Average	P
3	7356.00	6.65	39.94	46.59	74.00	-27.41	Peak	P
4	7356.00	6.65	27.85	34.50	54.00	-19.50	Average	P

Note: Level=Reading+Factor
Margin=Level-Limit
Factor=Antenna Factor + cable loss - Amplifier Factor

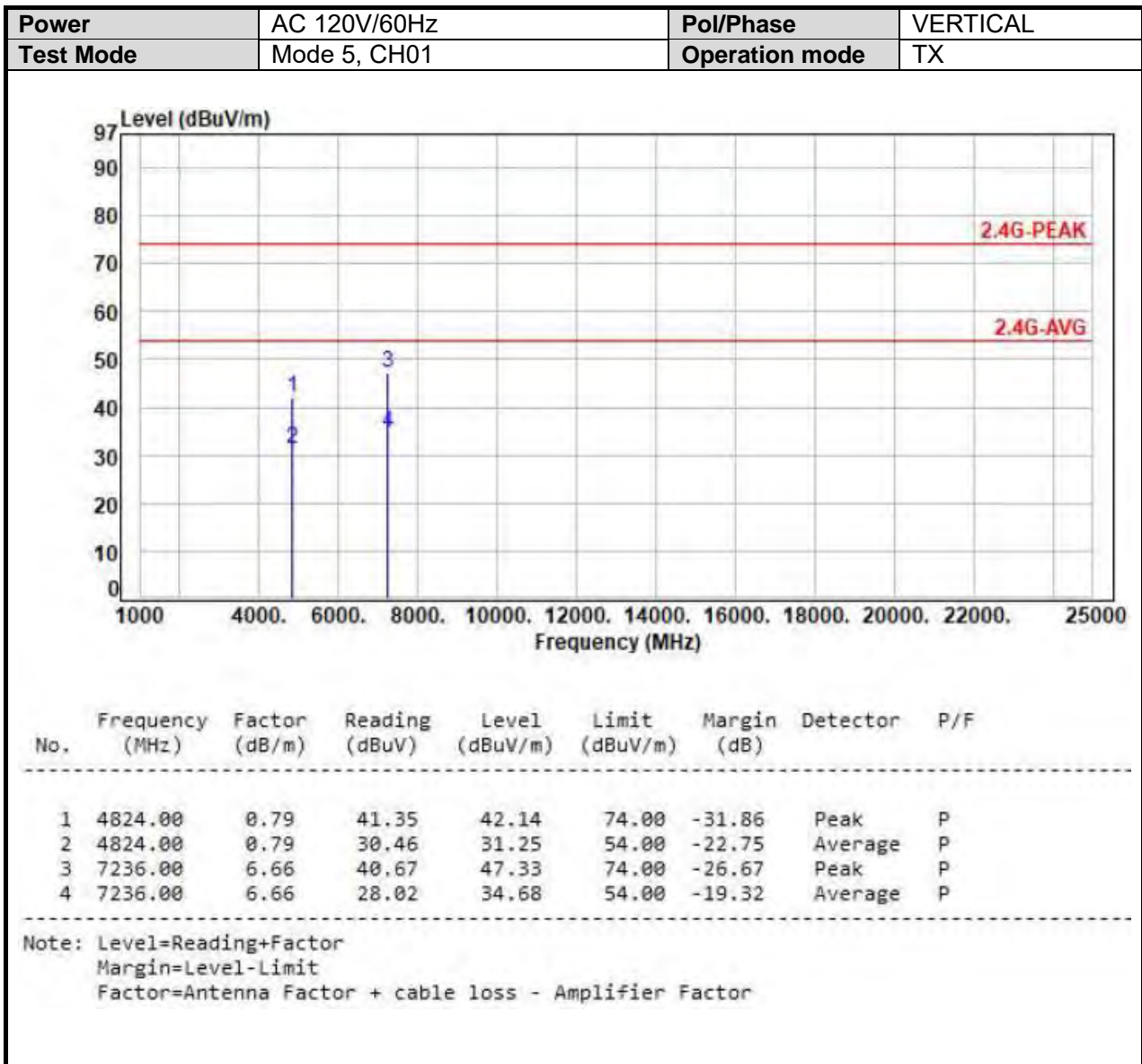



Power	AC 120V/60Hz	Pol/Phase	HORIZONTAL
Test Mode	Mode 5, CH01	Operation mode	TX

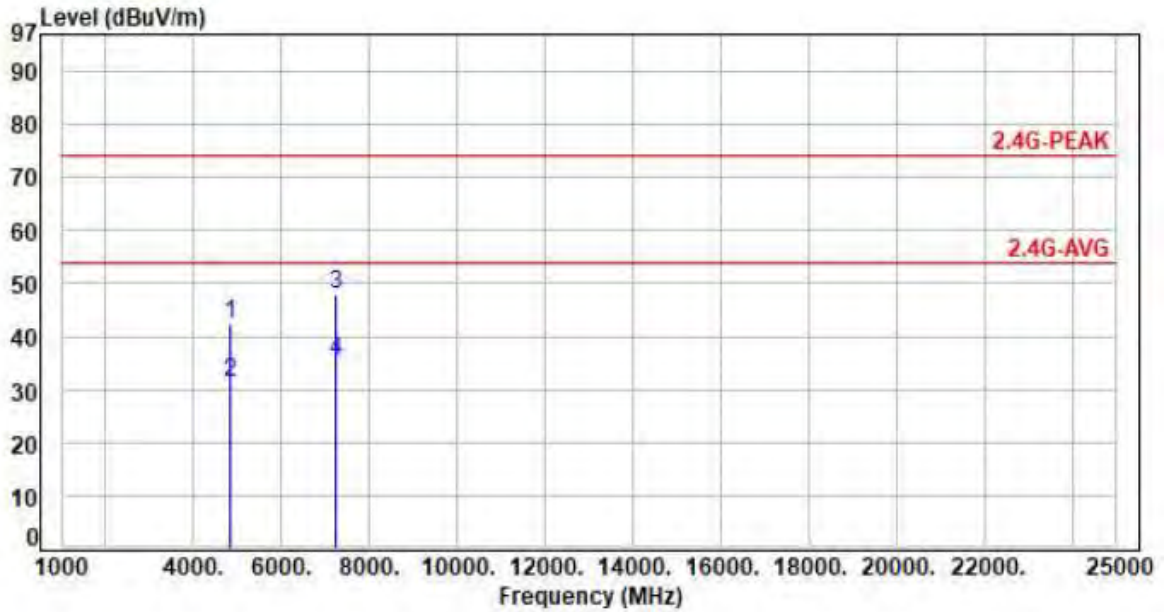

No.	Frequency (MHz)	Factor (dB/m)	Reading (dBuV)	Level (dBuV/m)	Limit (dBuV/m)	Margin (dB)	Detector	P/F
1	4824.00	0.79	41.50	42.29	74.00	-31.71	Peak	P
2	4824.00	0.79	30.45	31.24	54.00	-22.76	Average	P
3	7236.00	6.66	41.20	47.86	74.00	-26.14	Peak	P
4	7236.00	6.66	28.66	35.32	54.00	-18.68	Average	P

Note: Level=Reading+Factor
Margin=Level-Limit
Factor=Antenna Factor + cable loss - Amplifier Factor



Power	AC 120V/60Hz	Pol/Phase	VERTICAL
Test Mode	Mode 5, CH06	Operation mode	TX

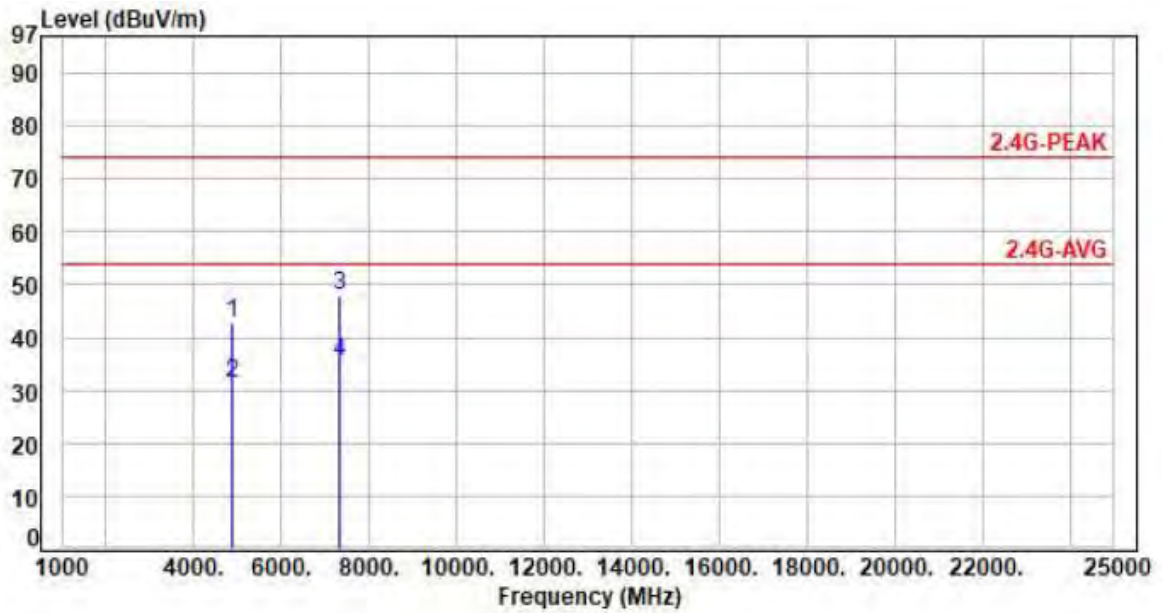

No.	Frequency (MHz)	Factor (dB/m)	Reading (dBUV)	Level (dBUV/m)	Limit (dBUV/m)	Margin (dB)	Detector	P/F
1	4874.00	0.87	42.01	42.88	74.00	-31.12	Peak	P
2	4874.00	0.87	30.64	31.51	54.00	-22.49	Average	P
3	7311.00	6.64	41.21	47.85	74.00	-26.15	Peak	P
4	7311.00	6.64	28.60	35.24	54.00	-18.76	Average	P

Note: Level=Reading+Factor
Margin=Level-Limit
Factor=Antenna Factor + cable loss - Amplifier Factor



Power	AC 120V/60Hz	Pol/Phase	HORIZONTAL
Test Mode	Mode 5, CH06	Operation mode	TX

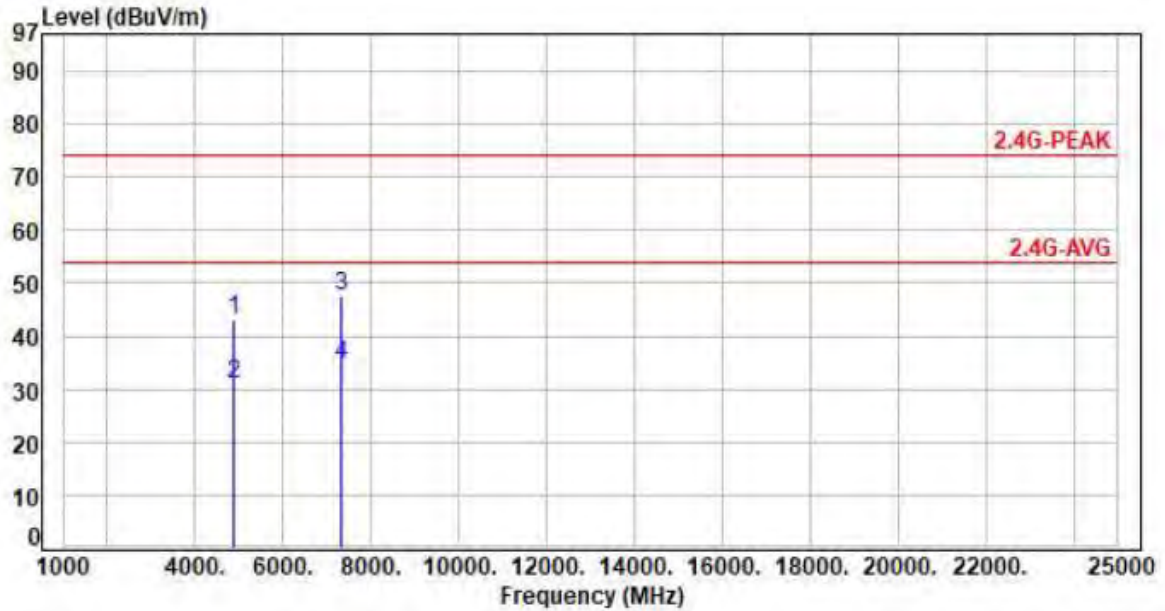

No.	Frequency (MHz)	Factor (dB/m)	Reading (dBuV)	Level (dBuV/m)	Limit (dBuV/m)	Margin (dB)	Detector	P/F
1	4874.00	0.87	42.15	43.02	74.00	-30.98	Peak	P
2	4874.00	0.87	30.18	31.05	54.00	-22.95	Average	P
3	7311.00	6.64	40.94	47.58	74.00	-26.42	Peak	P
4	7311.00	6.64	28.02	34.66	54.00	-19.34	Average	P

Note: Level=Reading+Factor
Margin=Level-Limit
Factor=Antenna Factor + cable loss - Amplifier Factor

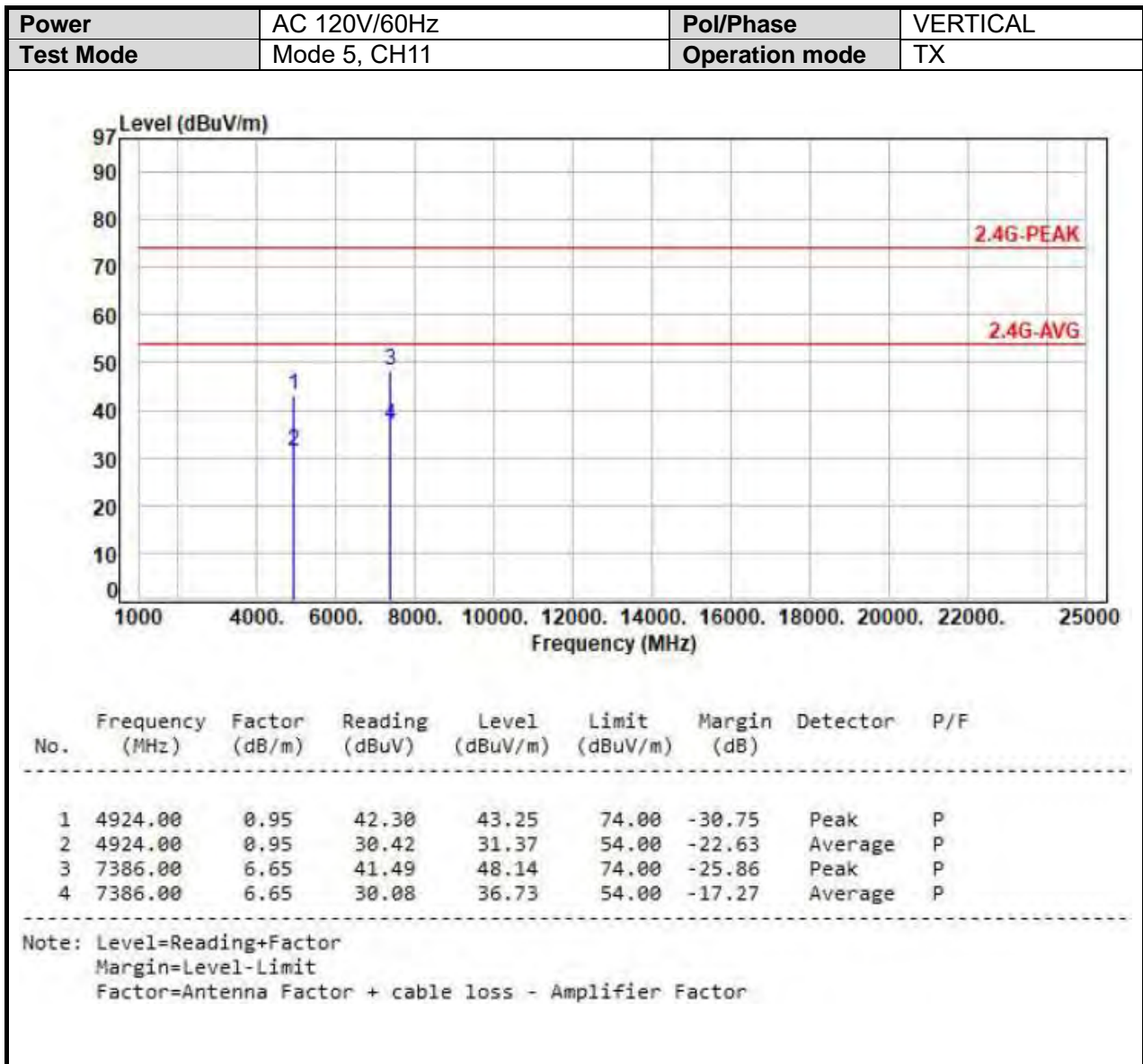



Power	AC 120V/60Hz	Pol/Phase	HORIZONTAL
Test Mode	Mode 5, CH11	Operation mode	TX

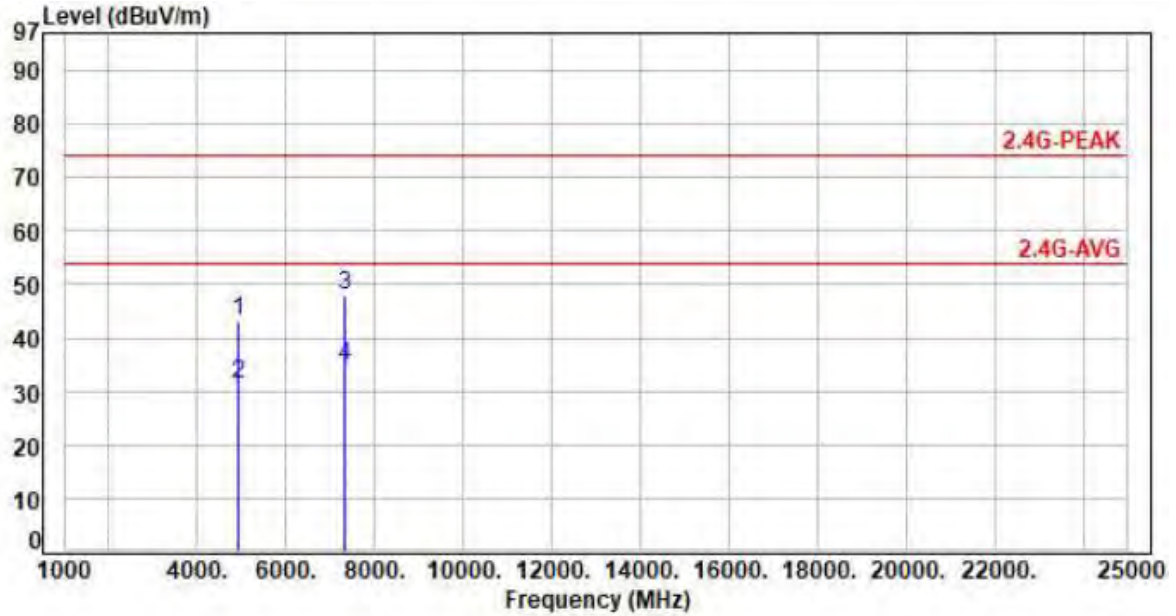

No.	Frequency (MHz)	Factor (dB/m)	Reading (dBuV)	Level (dBuV/m)	Limit (dBuV/m)	Margin (dB)	Detector	P/F
1	4924.00	0.95	42.37	43.32	74.00	-30.68	Peak	P
2	4924.00	0.95	30.52	31.47	54.00	-22.53	Average	P
3	7311.00	6.64	41.26	47.90	74.00	-26.10	Peak	P
4	7311.00	6.64	28.13	34.77	54.00	-19.23	Average	P

Note: Level=Reading+Factor
Margin=Level-Limit
Factor=Antenna Factor + cable loss - Amplifier Factor



Power	AC 120V/60Hz	Pol/Phase	VERTICAL
Test Mode	Mode 6, CH03	Operation mode	TX

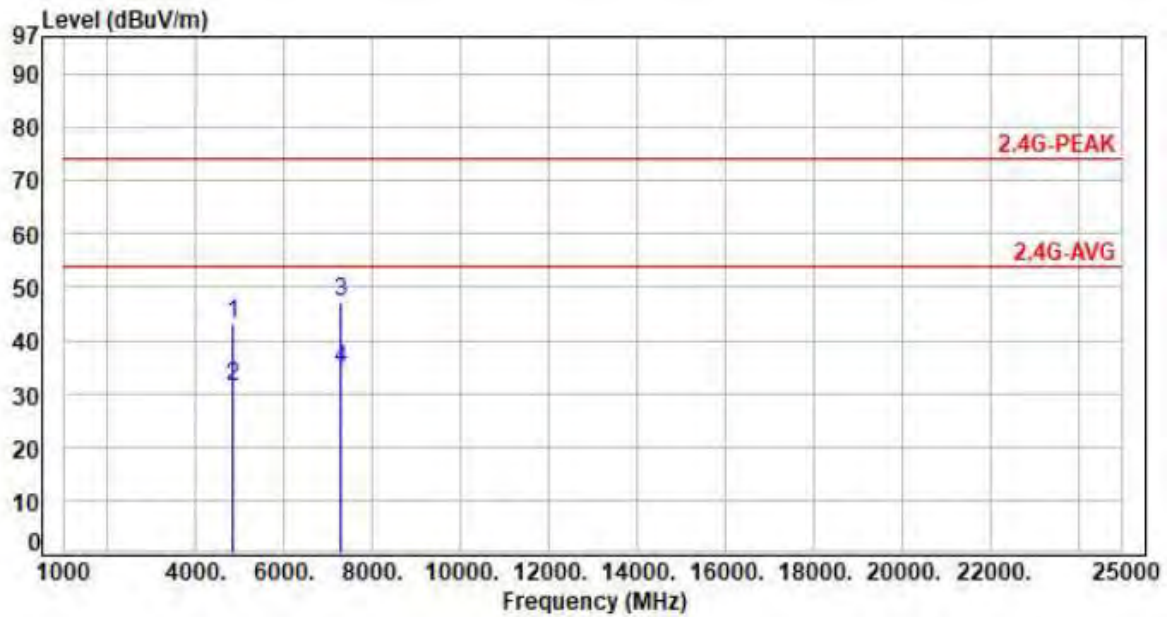

No.	Frequency (MHz)	Factor (dB/m)	Reading (dBuV)	Level (dBuV/m)	Limit (dBuV/m)	Margin (dB)	Detector	P/F
1	4844.00	0.82	42.18	43.00	74.00	-31.00	Peak	P
2	4844.00	0.82	30.70	31.52	54.00	-22.48	Average	P
3	7266.00	6.65	40.48	47.13	74.00	-26.87	Peak	P
4	7266.00	6.65	28.03	34.68	54.00	-19.32	Average	P

Note: Level=Reading+Factor
Margin=Level-Limit
Factor=Antenna Factor + cable loss - Amplifier Factor

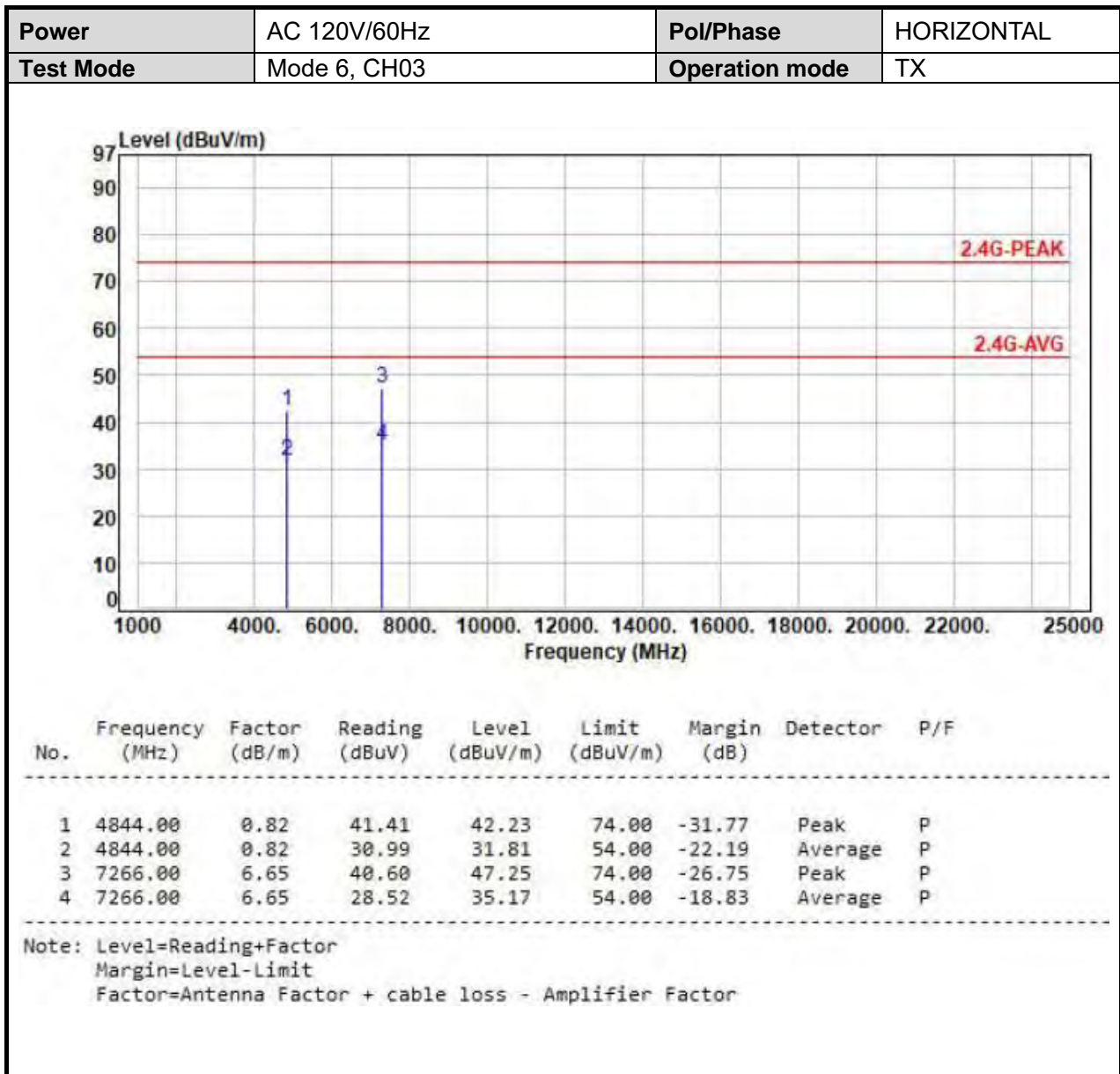

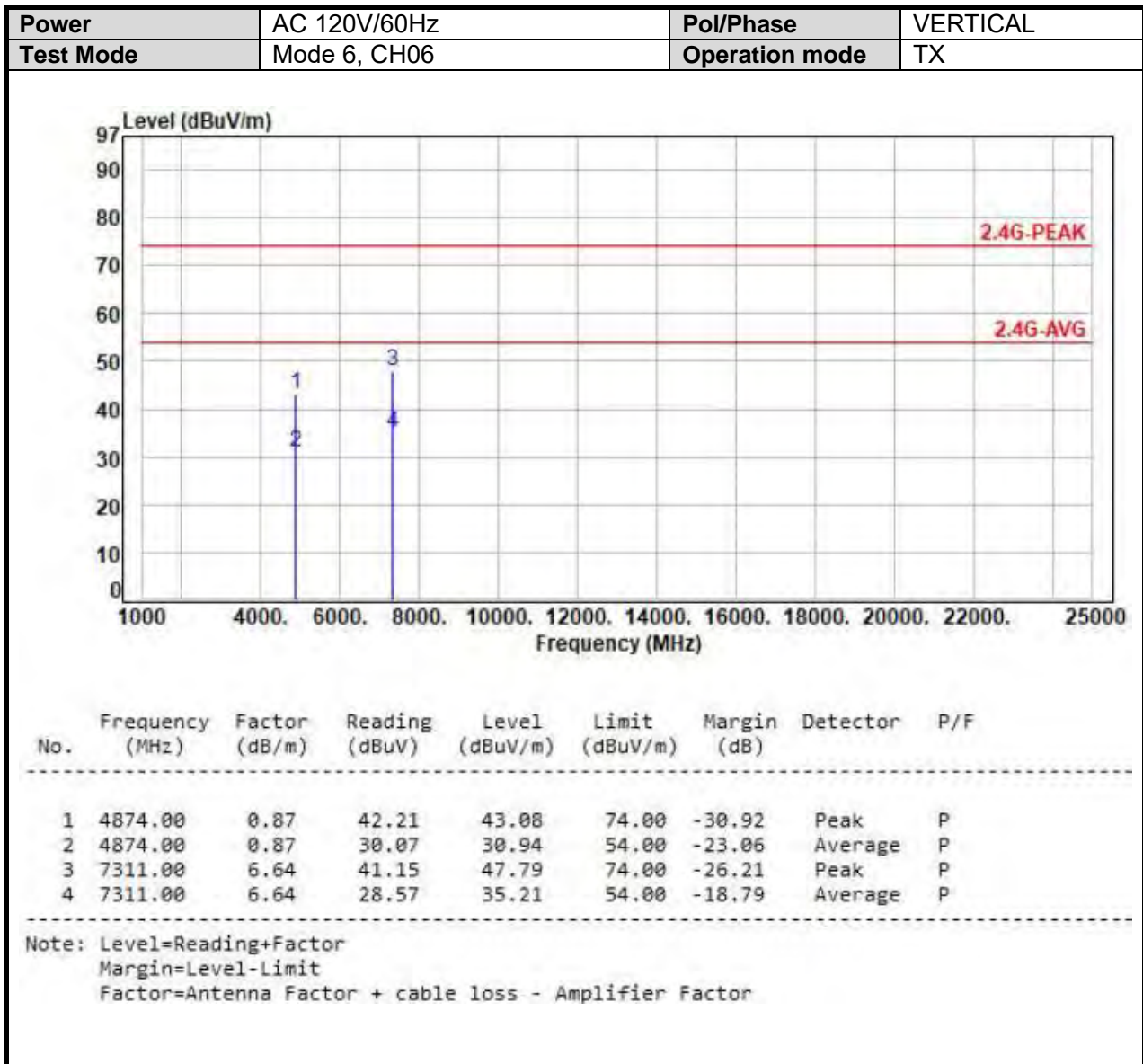



Power	AC 120V/60Hz	Pol/Phase	HORIZONTAL
Test Mode	Mode 6, CH06	Operation mode	TX

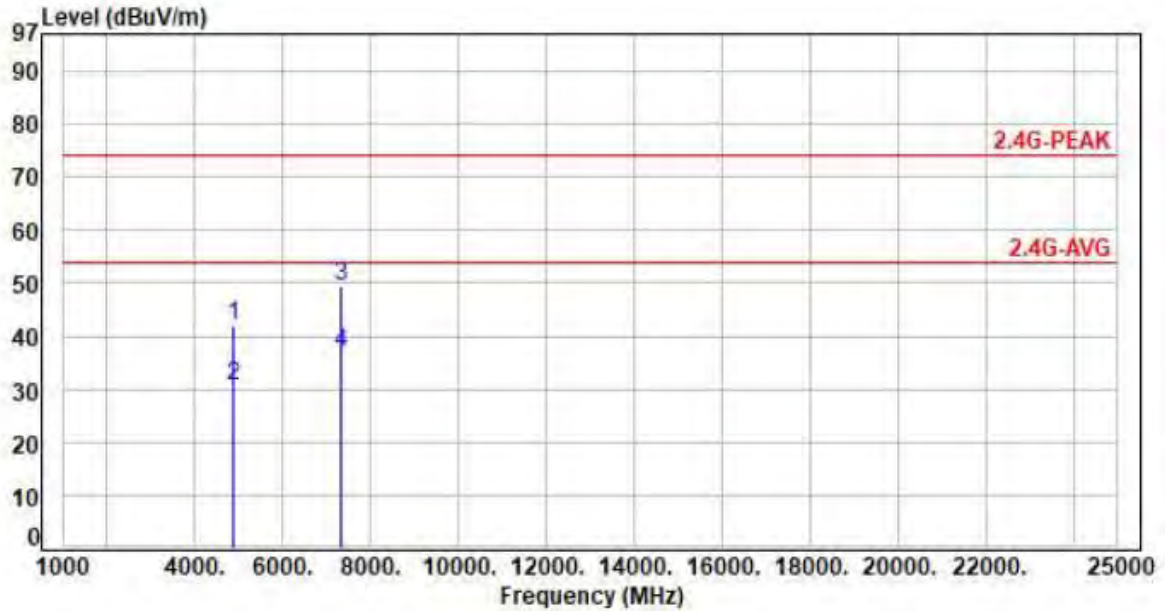

No.	Frequency (MHz)	Factor (dB/m)	Reading (dBuV)	Level (dBuV/m)	Limit (dBuV/m)	Margin (dB)	Detector	P/F
1	4874.00	0.87	41.28	42.15	74.00	-31.85	Peak	P
2	4874.00	0.87	29.69	30.56	54.00	-23.44	Average	P
3	7311.00	6.64	42.64	49.28	74.00	-24.72	Peak	P
4	7311.00	6.64	30.18	36.82	54.00	-17.18	Average	P

Note: Level=Reading+Factor
Margin=Level-Limit
Factor=Antenna Factor + cable loss - Amplifier Factor

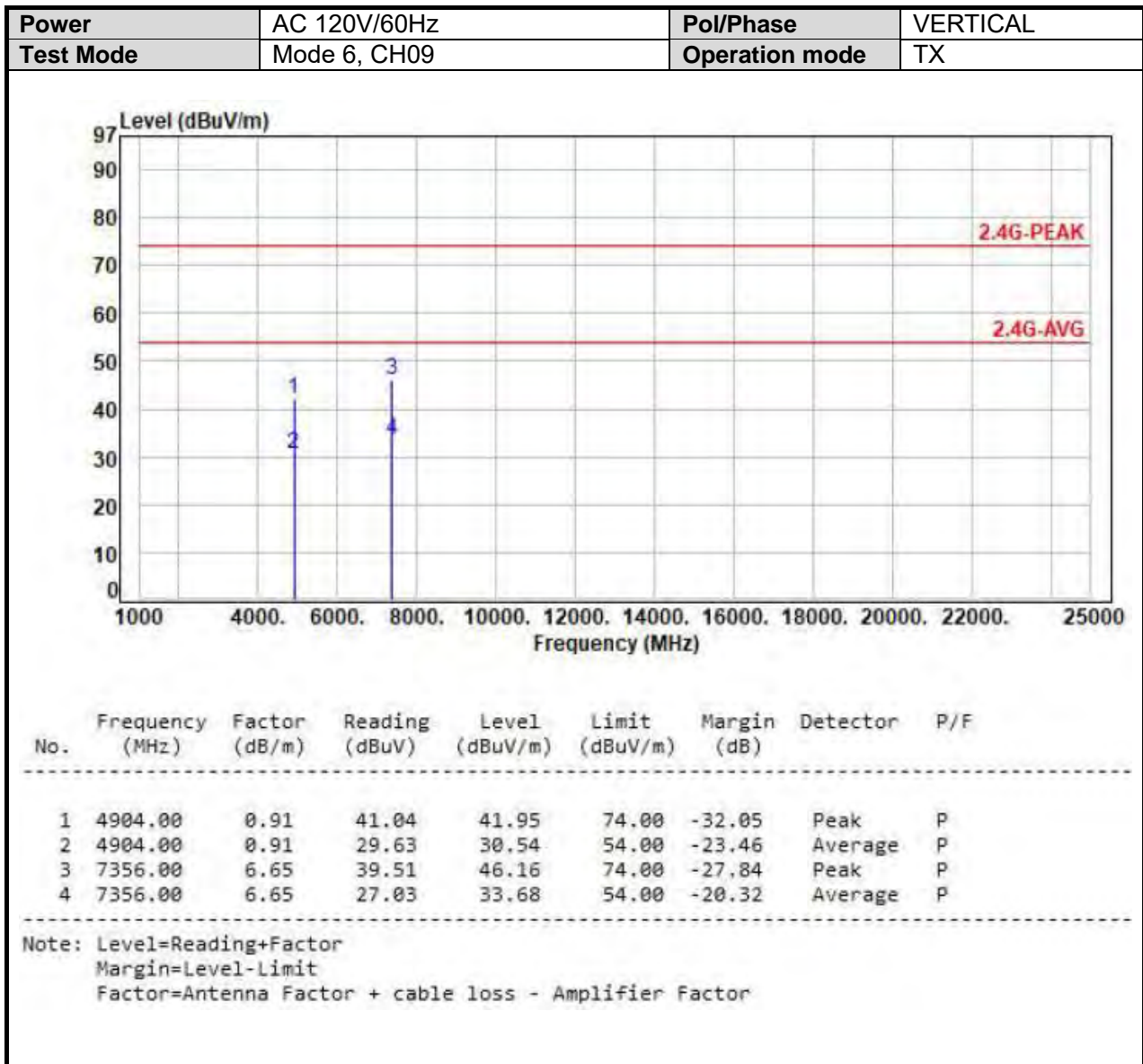



Power	AC 120V/60Hz	Pol/Phase	HORIZONTAL
Test Mode	Mode 6, CH09	Operation mode	TX

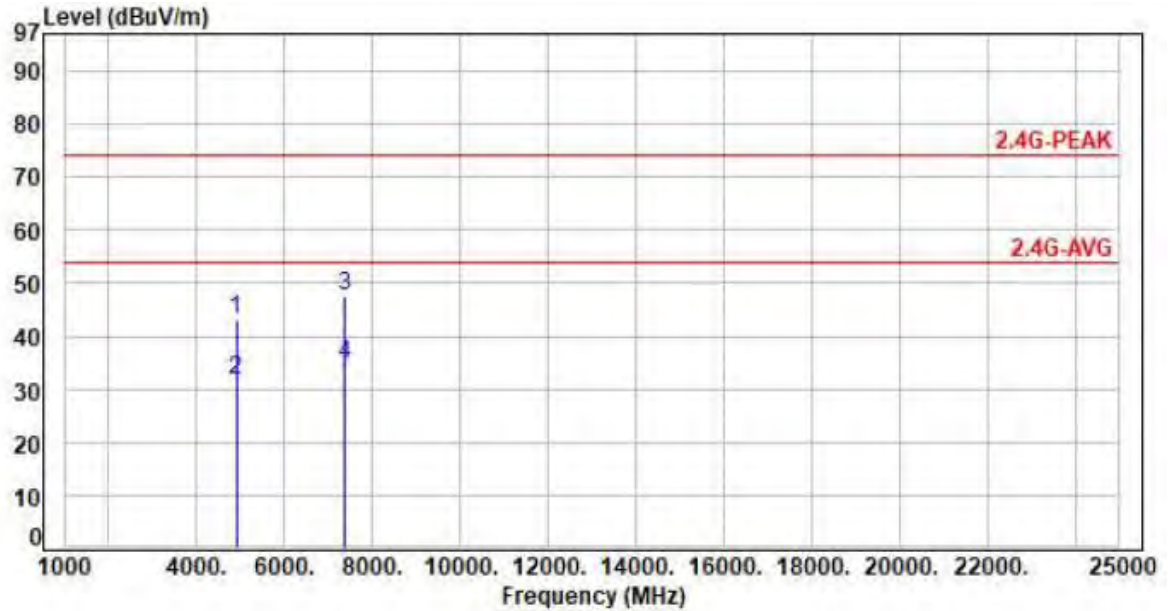

No.	Frequency (MHz)	Factor (dB/m)	Reading (dBuV)	Level (dBuV/m)	Limit (dBuV/m)	Margin (dB)	Detector	P/F
1	4904.00	0.91	42.39	43.30	74.00	-30.70	Peak	P
2	4904.00	0.91	30.71	31.62	54.00	-22.38	Average	P
3	7356.00	6.65	40.83	47.48	74.00	-26.52	Peak	P
4	7356.00	6.65	27.93	34.58	54.00	-19.42	Average	P

Note: Level=Reading+Factor
Margin=Level-Limit
Factor=Antenna Factor + cable loss - Amplifier Factor



6.7 Restricted Bands of Operation

Only spurious emissions are permitted in any of the frequency bands listed below:

MHz	MHz	MHz	GHz
0.09000 – 0.11000	16.42000 – 16.42300	399.9 – 410.0	4.500 – 5.250
0.49500 – 0.505**	16.69475 – 16.69525	608.0 – 614.0	5.350 – 5.460
2.17350 – 2.19050	16.80425 – 16.80475	960.0 – 1240.0	7.250 – 7.750
4.12500 – 4.12800	25.50000 – 25.67000	1300.0 – 1427.0	8.025 – 8.500
4.17725 – 4.17775	37.50000 – 38.25000	1435.0 – 1626.5	9.000 – 9.200
4.20725 – 4.20775	73.00000 – 74.60000	1645.5 – 1646.5	9.300 – 9.500
6.21500 – 6.21800	74.80000 – 75.20000	1660.0 – 1710.0	10.600 – 12.700
6.26775 – 6.26825	108.00000 – 121.94000	1718.8 – 1722.2	13.250 – 13.400
6.31175 – 6.31225	123.00000 – 138.00000	2200.0 – 2300.0	14.470 – 14.500
8.29100 – 8.29400	149.90000 – 150.05000	2310.0 – 2390.0	15.350 – 16.200
8.36200 – 8.36600	156.52475 – 156.52525	2483.5 – 2500.0	17.700 – 21.400
8.37625 – 8.38675	156.70000 – 156.90000	2655.0 – 2900.0	22.010 – 23.120
8.41425 – 8.41475	162.01250 – 167.17000	3260.0 – 3267.0	23.600 – 24.000
12.29000 – 12.29300	167.72000 – 173.20000	3332.0 – 3339.0	31.200 – 31.800
12.51975 – 12.52025	240.00000 – 285.00000	3345.8 – 3358.0	36.430 – 36.500
12.57675 – 12.57725	322.00000 – 335.40000	3600.0 – 4400.0	Above 38.6
13.36000 – 13.41000			

** : Until February 1, 1999, this restricted band shall be 0.490-0.510 MHz



6.8 Restrict Band Emission Measurement Data

Power	: AC 120V/60Hz	Pol/Phase	: VERTICAL
Test Mode	: 802.11b, CH01		

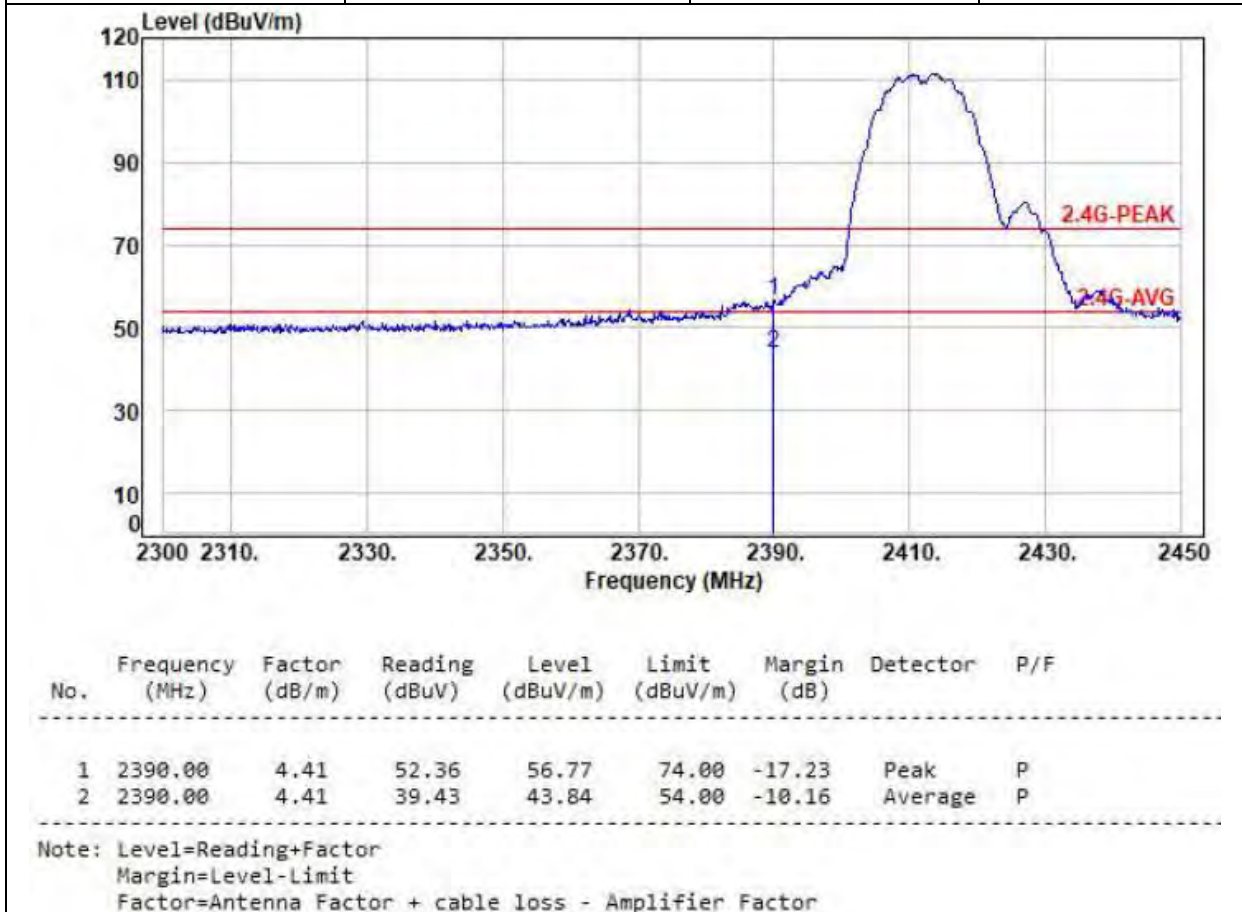



Power	: AC 120V/60Hz	Pol/Phase	: HORIZONTAL
Test Mode	: 802.11b, CH01		

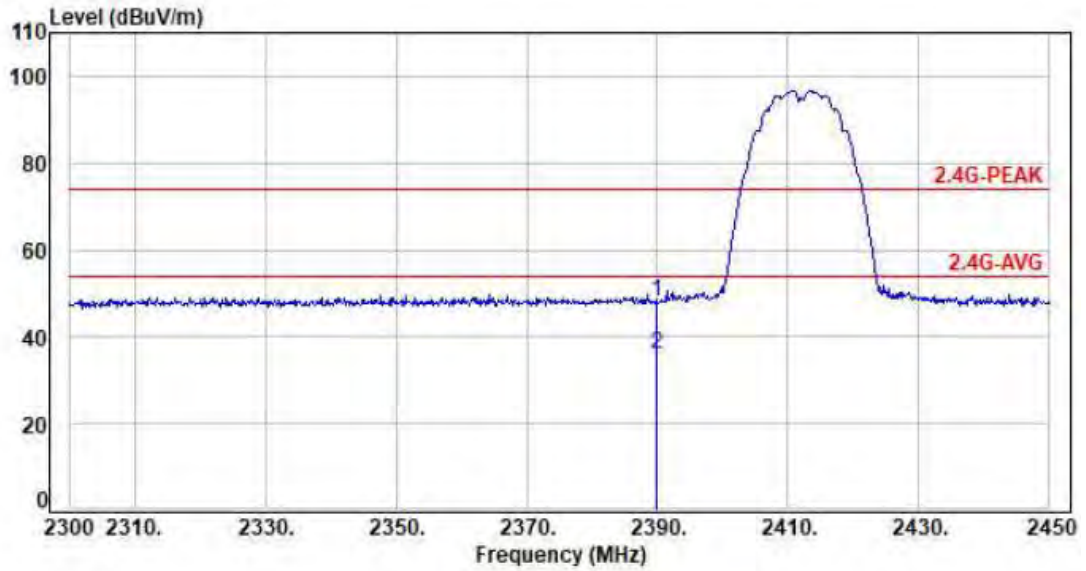

No.	Frequency (MHz)	Factor (dB/m)	Reading (dBuV)	Level (dBuV/m)	Limit (dBuV/m)	Margin (dB)	Detector	P/F
1	2390.00	4.41	43.64	48.05	74.00	-25.95	Peak	P
2	2390.00	4.41	31.72	36.13	54.00	-17.87	Average	P

Note: Level=Reading+Factor
Margin=Level-Limit
Factor=Antenna Factor + cable loss - Amplifier Factor



Power	: AC 120V/60Hz	Pol/Phase	: VERTICAL
Test Mode	: 802.11b, CH11		

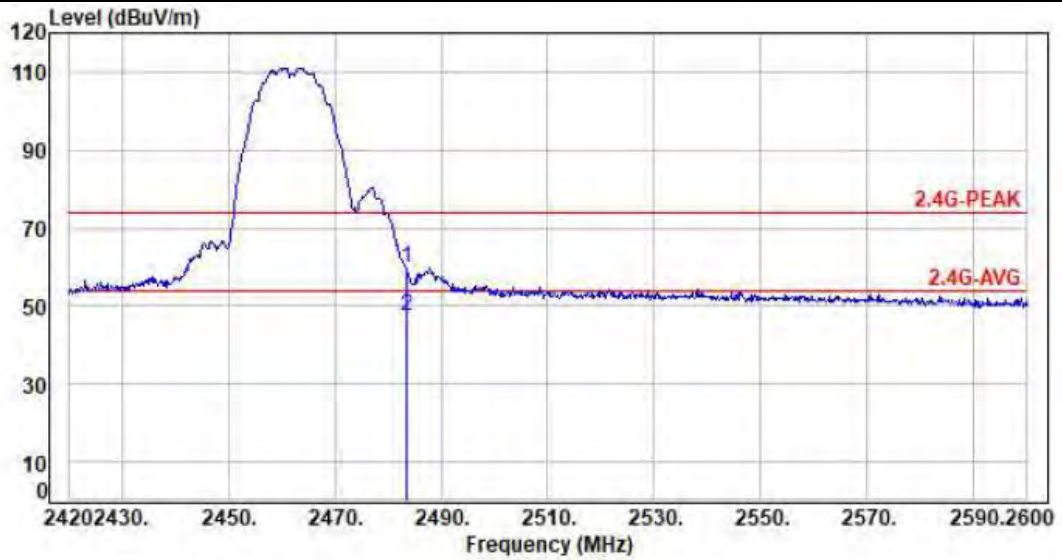

No.	Frequency (MHz)	Factor (dB/m)	Reading (dBuV)	Level (dBuV/m)	Limit (dBuV/m)	Margin (dB)	Detector	P/F
1	2483.50	4.73	54.86	59.59	74.00	-14.41	Peak	P
2	2483.50	4.73	42.62	47.35	54.00	-6.65	Average	P

Note: Level=Reading+Factor
Margin=Level-Limit
Factor=Antenna Factor + cable loss - Amplifier Factor



Power	: AC 120V/60Hz	Pol/Phase	: HORIZONTAL
Test Mode	: 802.11b, CH11		

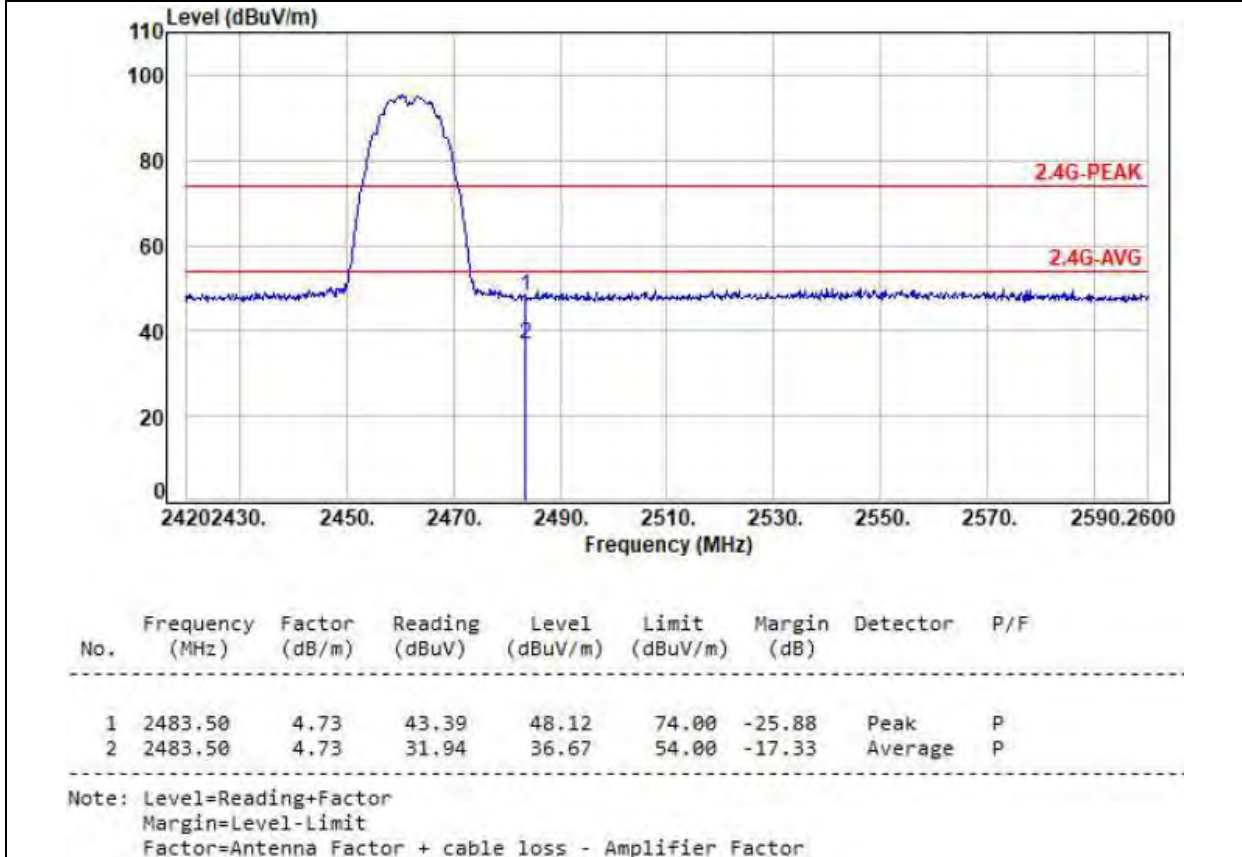



Power	: AC 120V/60Hz	Pol/Phase	: VERTICAL
Test Mode	: 802.11g, CH01		

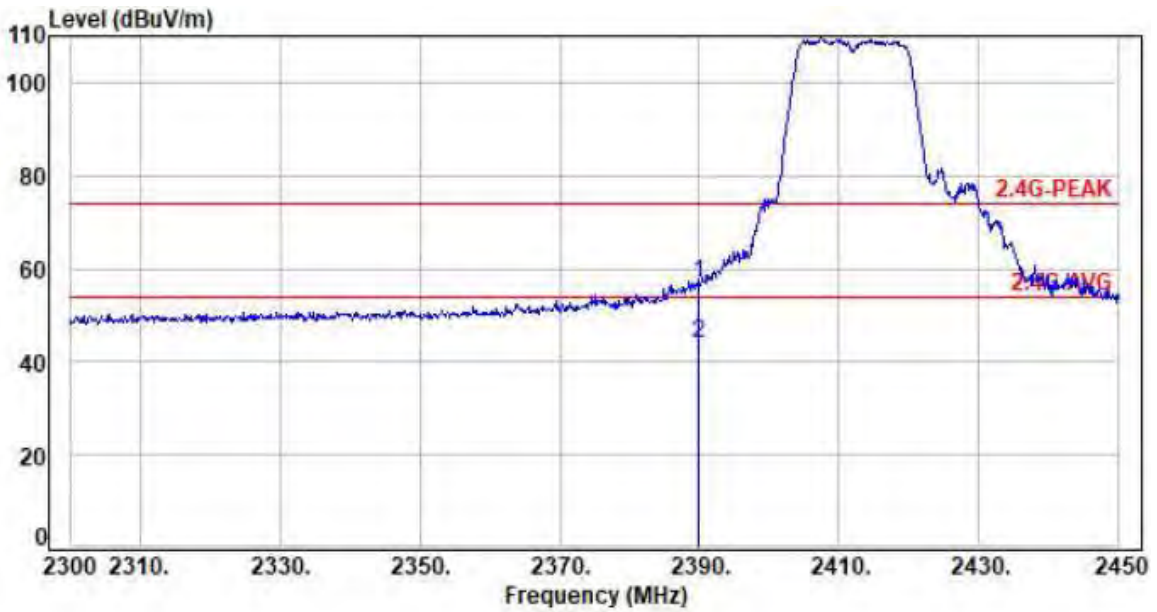

No.	Frequency (MHz)	Factor (dB/m)	Reading (dBuV)	Level (dBuV/m)	Limit (dBuV/m)	Margin (dB)	Detector	P/F
1	2390.00	4.41	52.33	56.74	74.00	-17.26	Peak	P
2	2390.00	4.41	39.42	43.83	54.00	-10.17	Average	P

Note: Level=Reading+Factor
Margin=Level-Limit
Factor=Antenna Factor + cable loss - Amplifier Factor

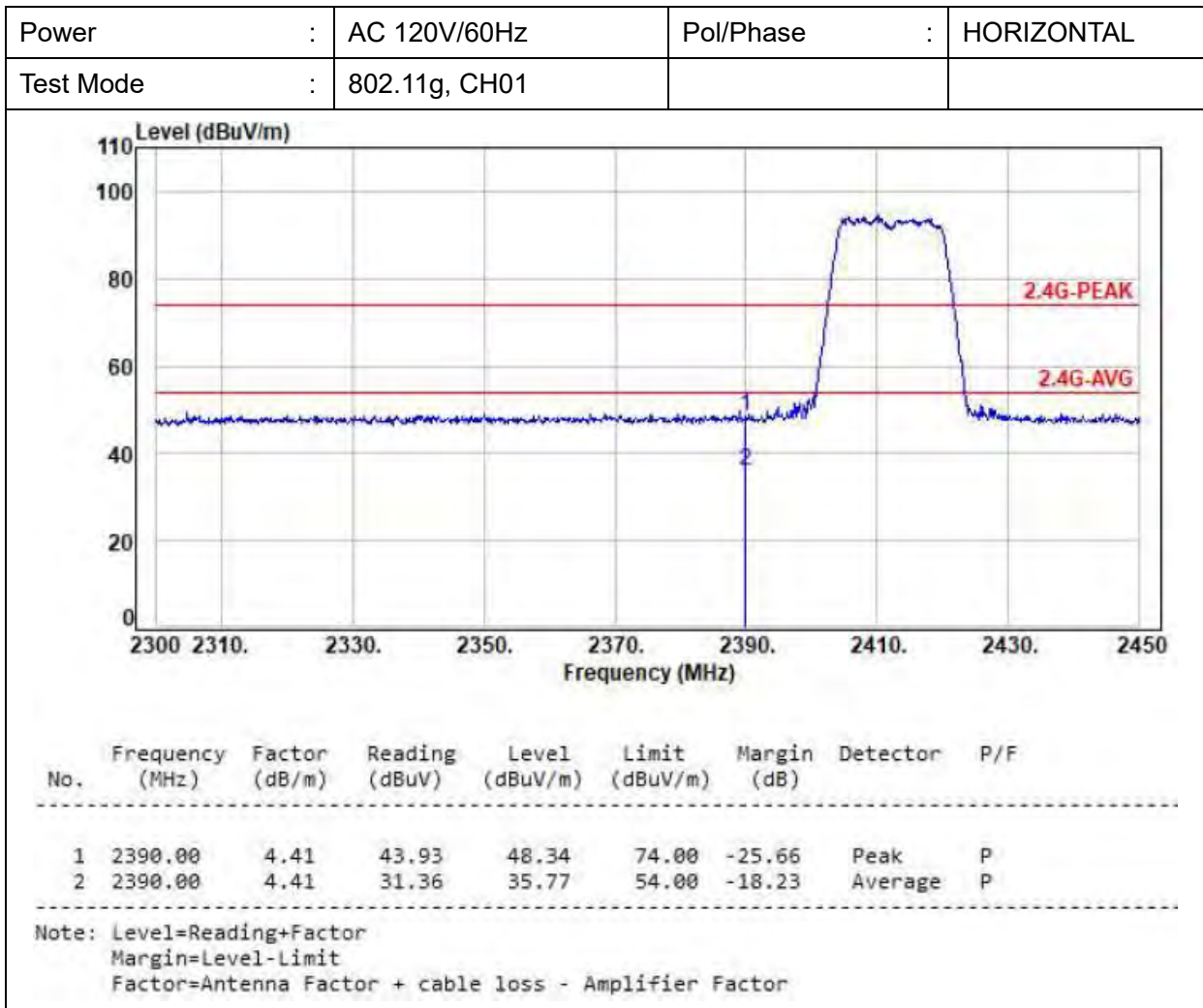

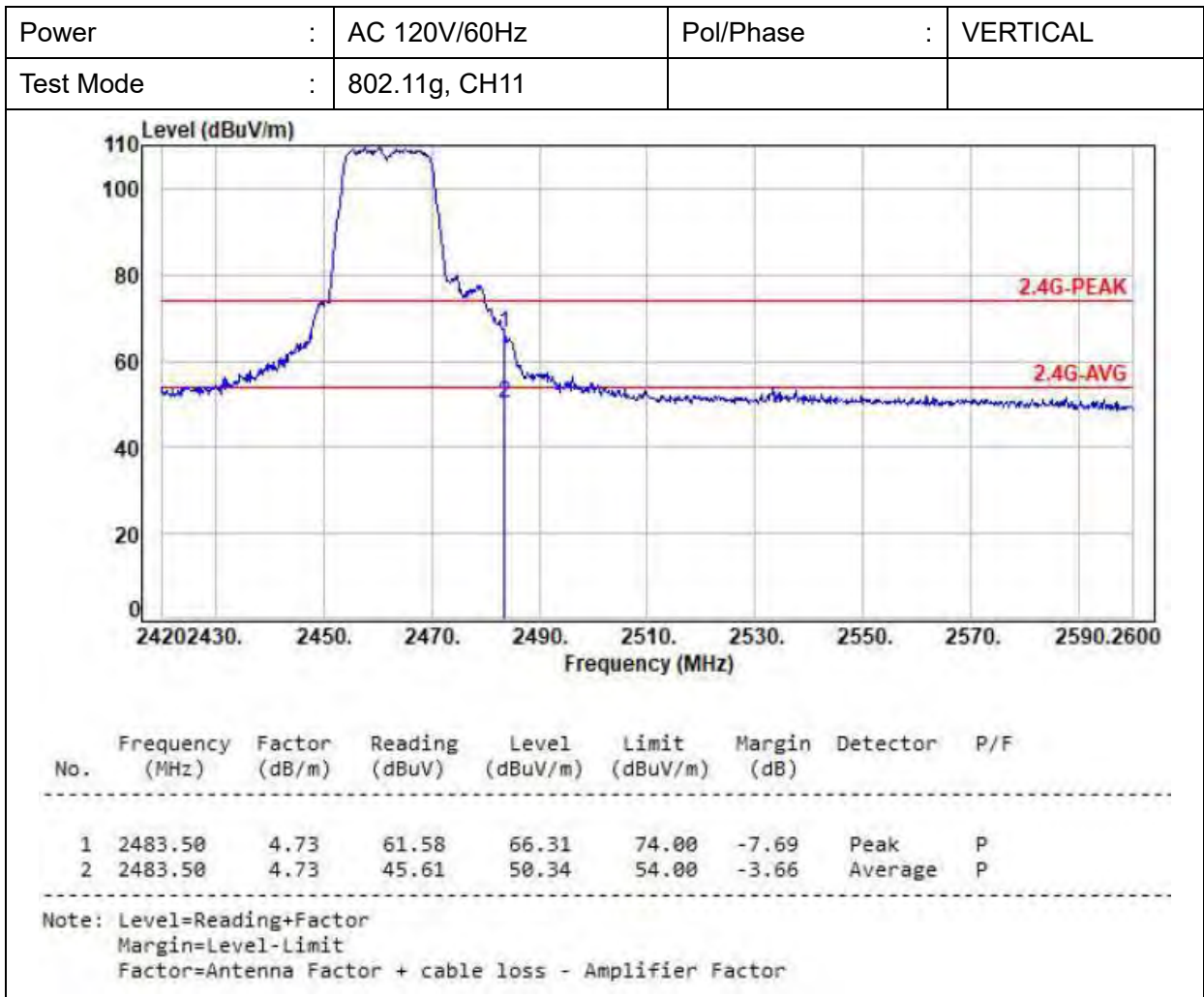



Power	: AC 120V/60Hz	Pol/Phase	: HORIZONTAL
Test Mode	: 802.11g, CH11		

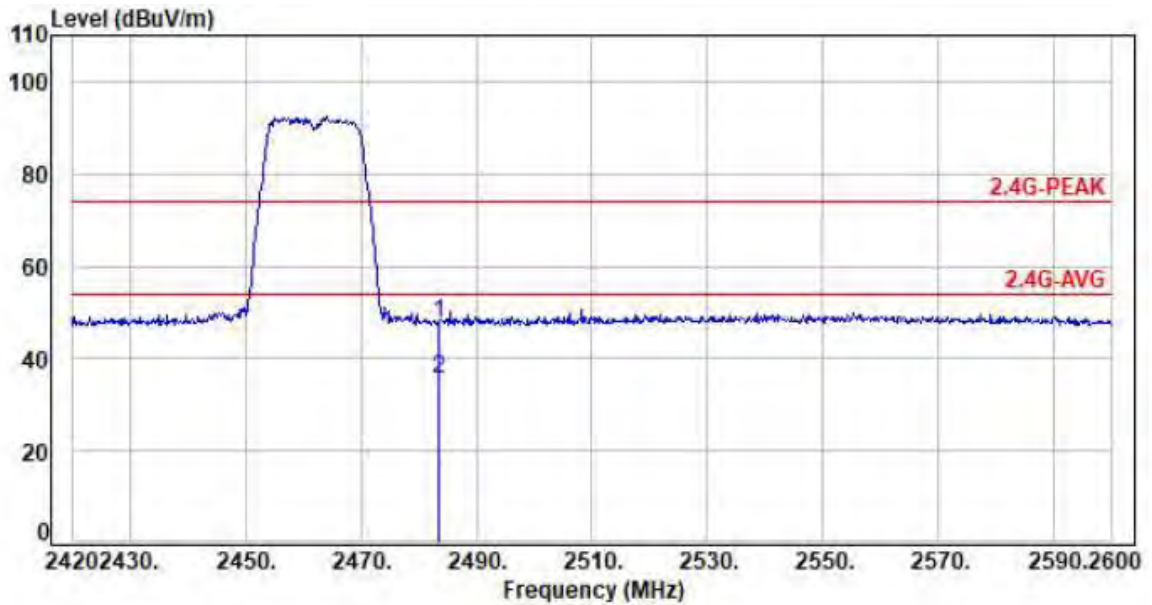

No.	Frequency (MHz)	Factor (dB/m)	Reading (dBuV)	Level (dBuV/m)	Limit (dBuV/m)	Margin (dB)	Detector	P/F
1	2483.50	4.73	42.81	47.54	74.00	-26.46	Peak	P
2	2483.50	4.73	30.83	35.56	54.00	-18.44	Average	P

Note: Level=Reading+Factor
Margin=Level-Limit
Factor=Antenna Factor + cable loss - Amplifier Factor



Power	: AC 120V/60Hz	Pol/Phase	: VERTICAL
Test Mode	: 802.11n HT20, CH01		

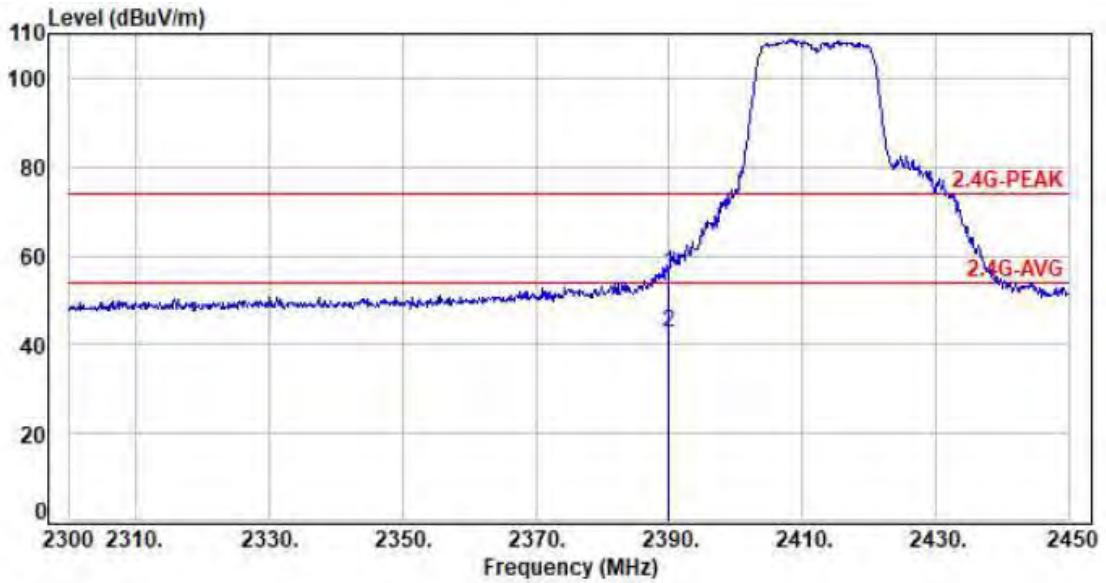

No.	Frequency (MHz)	Factor (dB/m)	Reading (dBUV)	Level (dBUV/m)	Limit (dBUV/m)	Margin (dB)	Detector	P/F
1	2390.00	4.41	51.79	56.20	74.00	-17.80	Peak	P
2	2390.00	4.41	38.42	42.83	54.00	-11.17	Average	P

Note: Level=Reading+Factor
Margin=Level-Limit
Factor=Antenna Factor + cable loss - Amplifier Factor



Power	: AC 120V/60Hz	Pol/Phase	: HORIZONTAL
Test Mode	: 802.11n HT20, CH01		

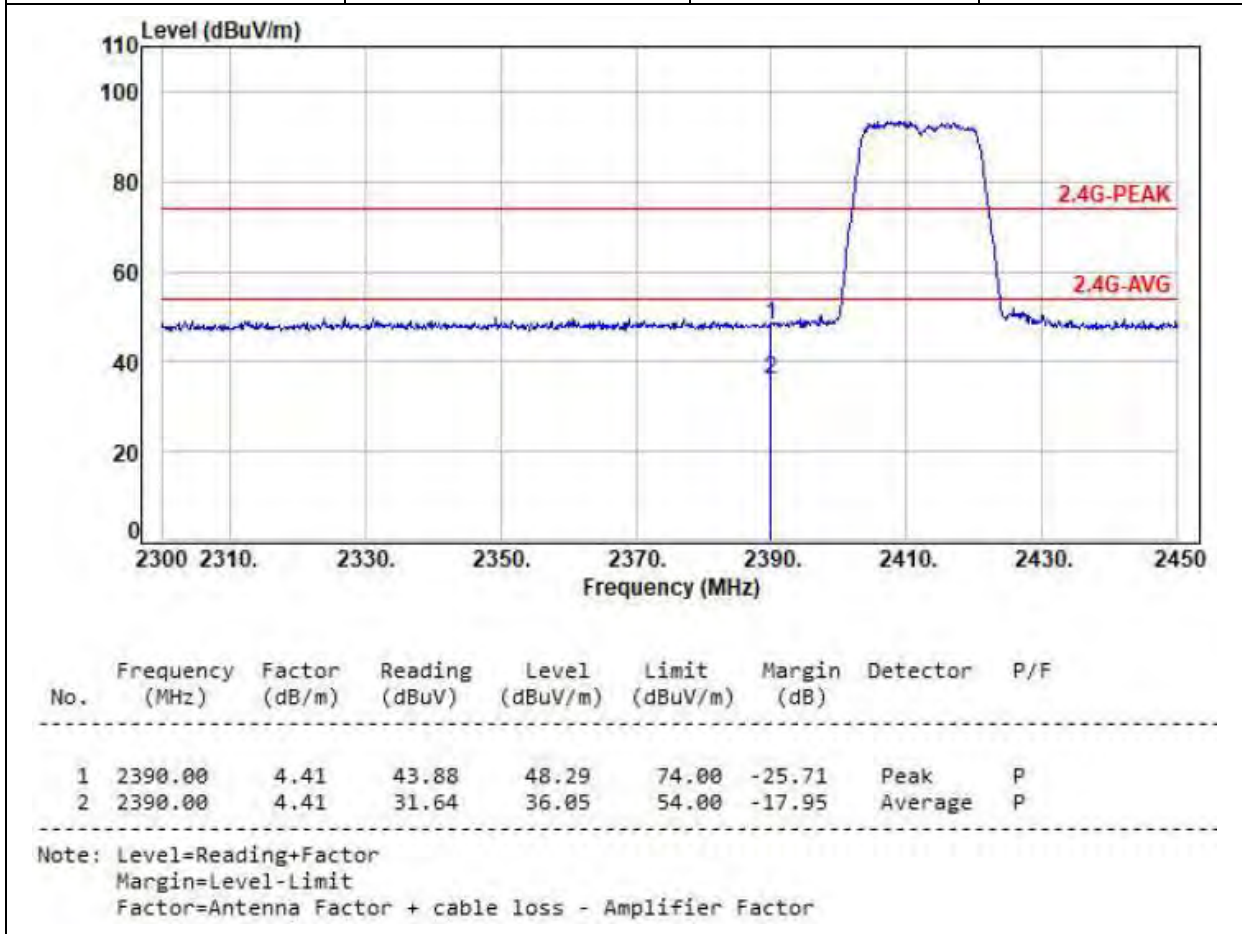

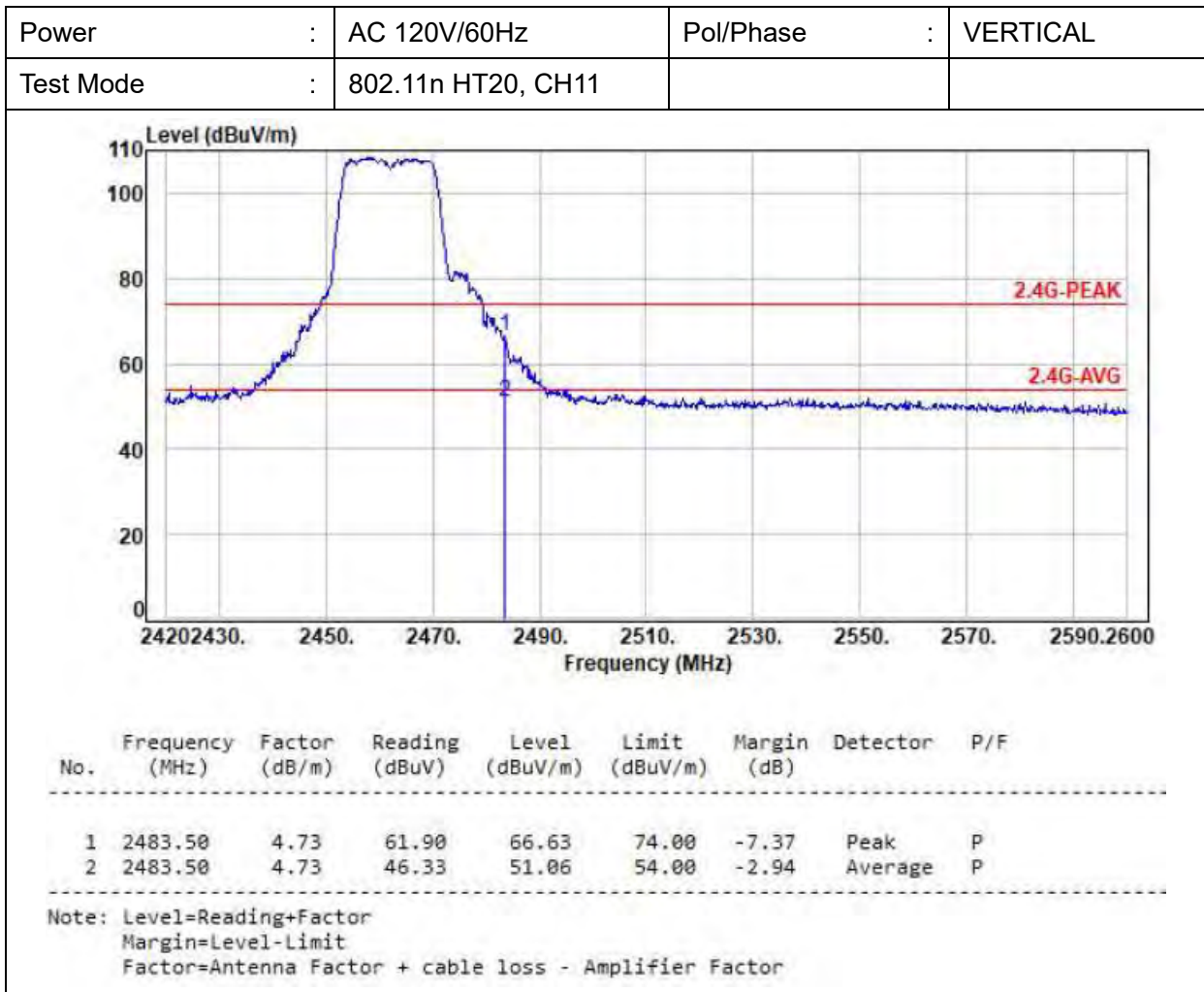



Power	: AC 120V/60Hz	Pol/Phase	: HORIZONTAL
Test Mode	: 802.11n HT20, CH11		

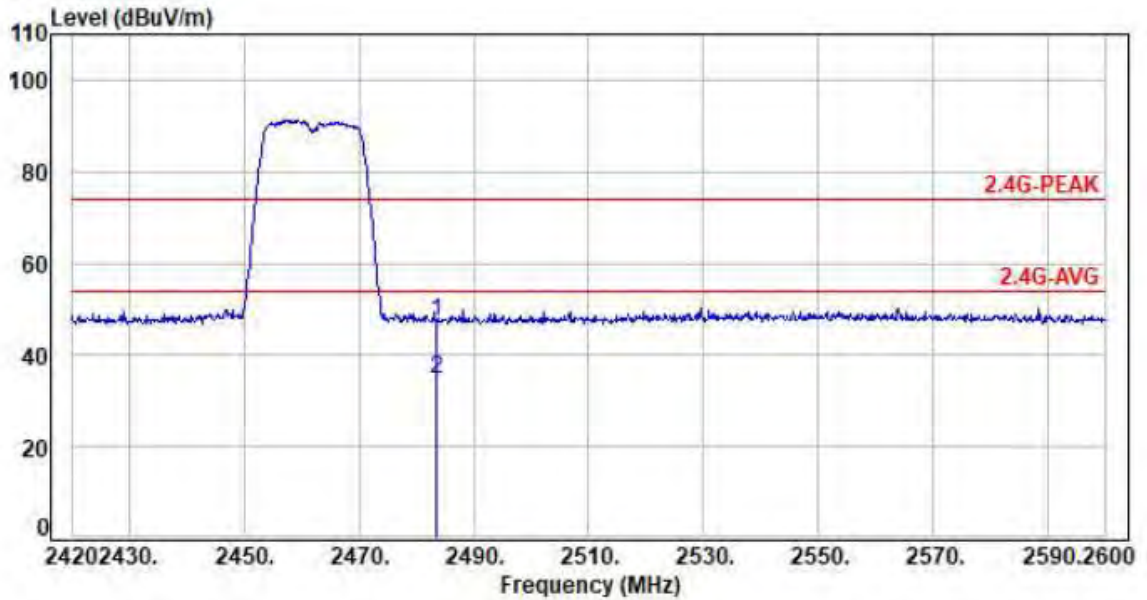

No.	Frequency (MHz)	Factor (dB/m)	Reading (dBuV)	Level (dBuV/m)	Limit (dBuV/m)	Margin (dB)	Detector	P/F
1	2483.50	4.73	42.41	47.14	74.00	-26.86	Peak	P
2	2483.50	4.73	30.13	34.86	54.00	-19.14	Average	P

Note: Level=Reading+Factor
Margin=Level-Limit
Factor=Antenna Factor + cable loss - Amplifier Factor



Power	: AC 120V/60Hz	Pol/Phase	: VERTICAL
Test Mode	: 802.11n HT40, CH03		

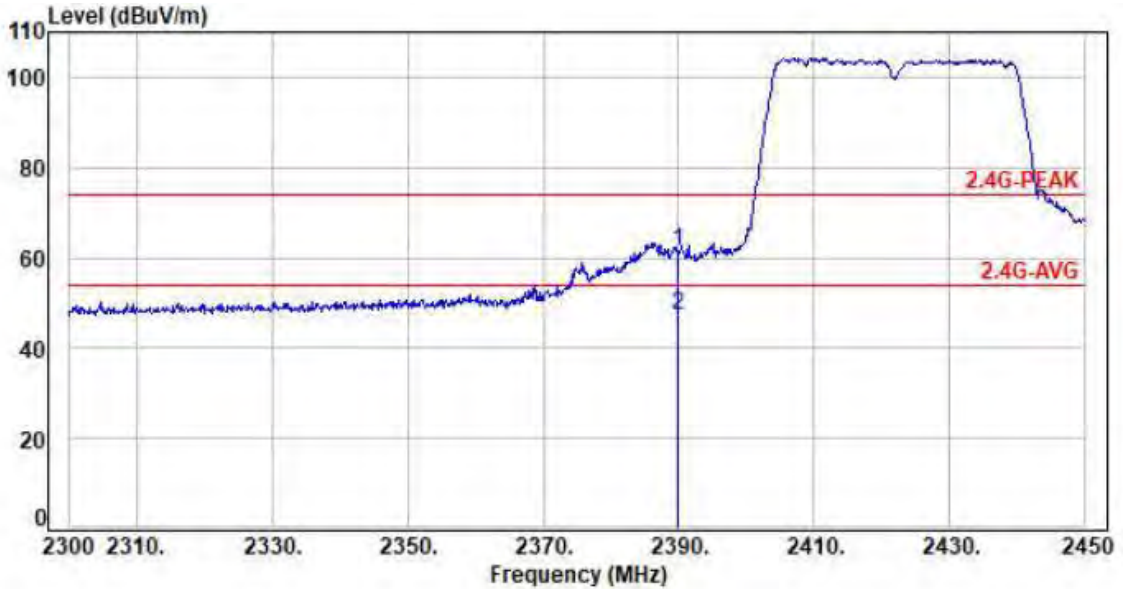

No.	Frequency (MHz)	Factor (dB/m)	Reading (dBuV)	Level (dBuV/m)	Limit (dBuV/m)	Margin (dB)	Detector	P/F
1	2390.00	4.41	56.90	61.31	74.00	-12.69	Peak	P
2	2390.00	4.41	43.05	47.46	54.00	-6.54	Average	P

Note: Level=Reading+Factor
Margin=Level-Limit
Factor=Antenna Factor + cable loss - Amplifier Factor



Power	: AC 120V/60Hz	Pol/Phase	: HORIZONTAL
Test Mode	: 802.11n HT40, CH03		

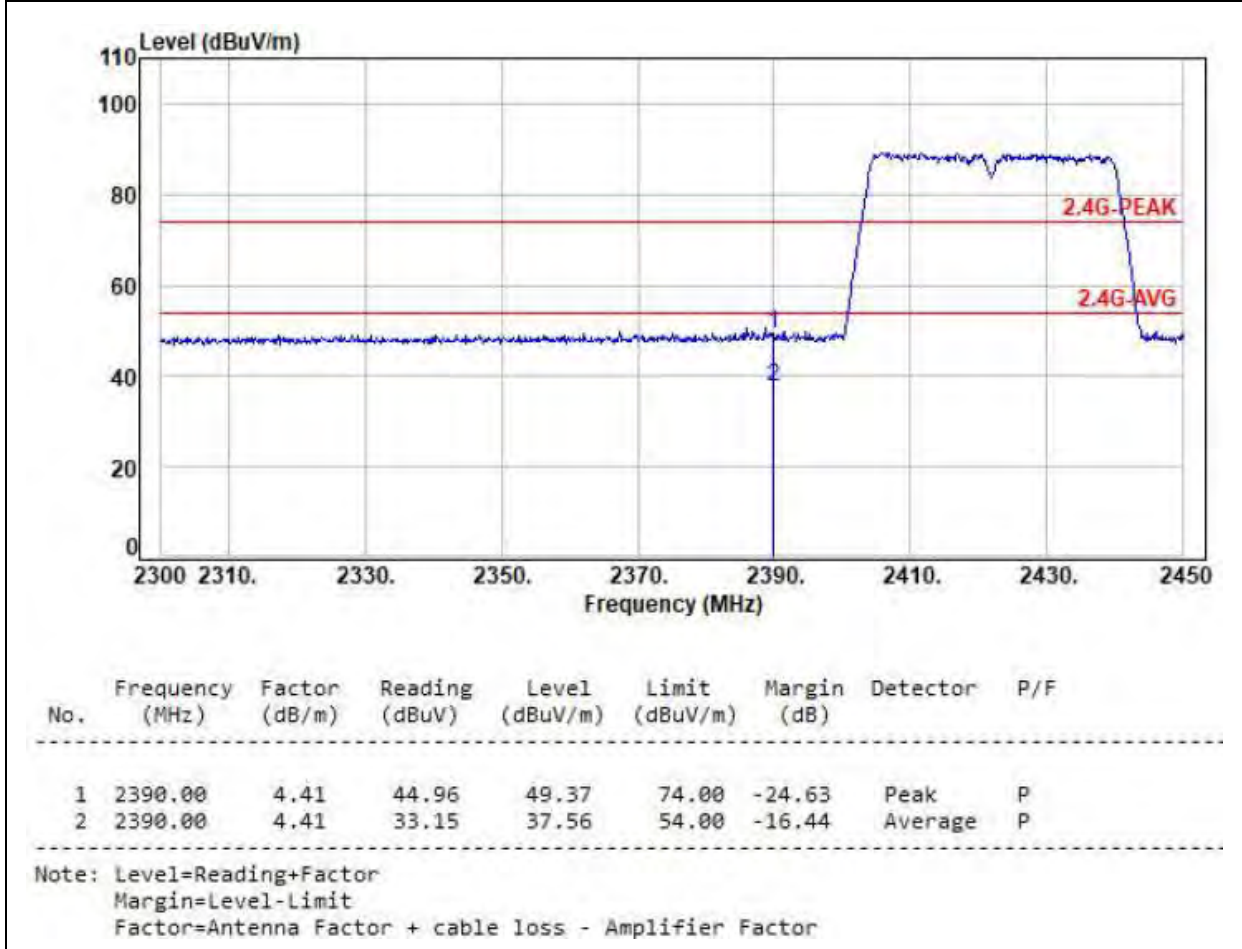



Power	: AC 120V/60Hz	Pol/Phase	: VERTICAL
Test Mode	: 802.11n HT40, CH09		

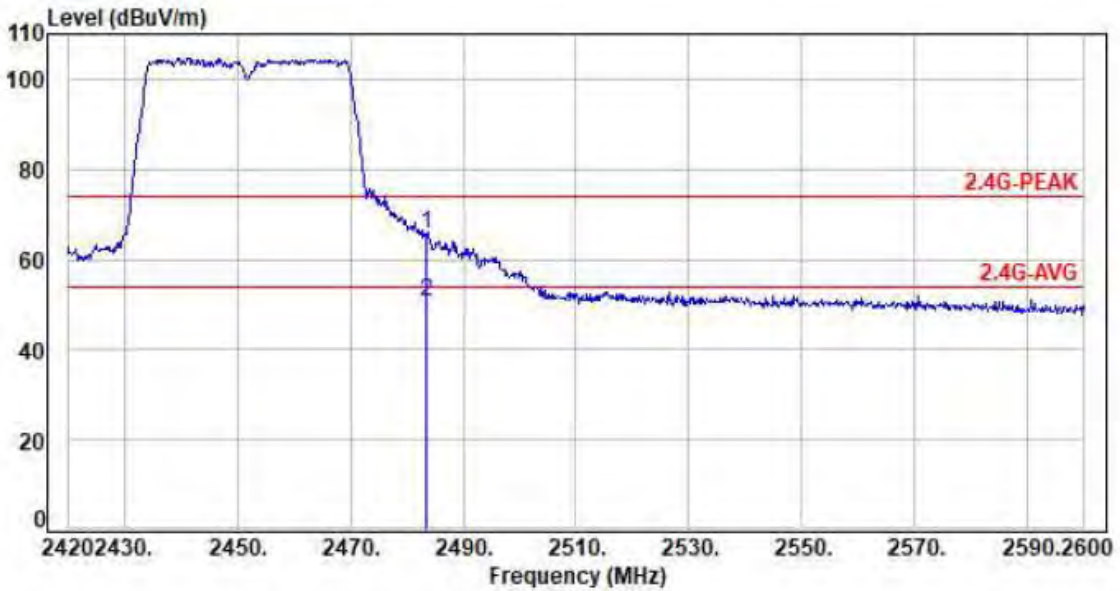

No.	Frequency (MHz)	Factor (dB/m)	Reading (dBuV)	Level (dBuV/m)	Limit (dBuV/m)	Margin (dB)	Detector	P/F
1	2483.50	4.73	60.92	65.65	74.00	-8.35	Peak	P
2	2483.50	4.73	45.70	50.43	54.00	-3.57	Average	P

Note: Level=Reading+Factor
Margin=Level-Limit
Factor=Antenna Factor + cable loss - Amplifier Factor



Power	: AC 120V/60Hz	Pol/Phase	: HORIZONTAL
Test Mode	: 802.11n HT40, CH09		

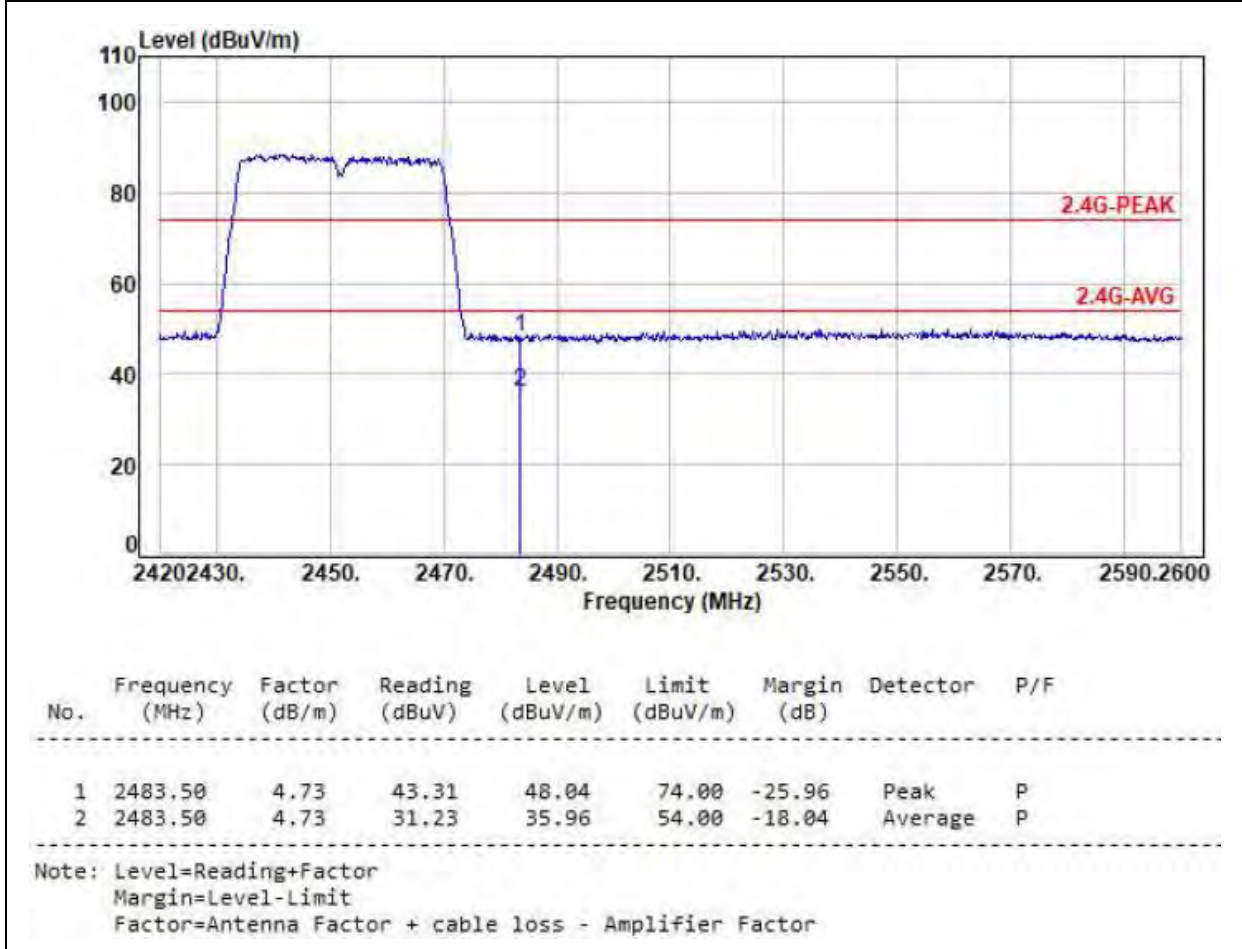

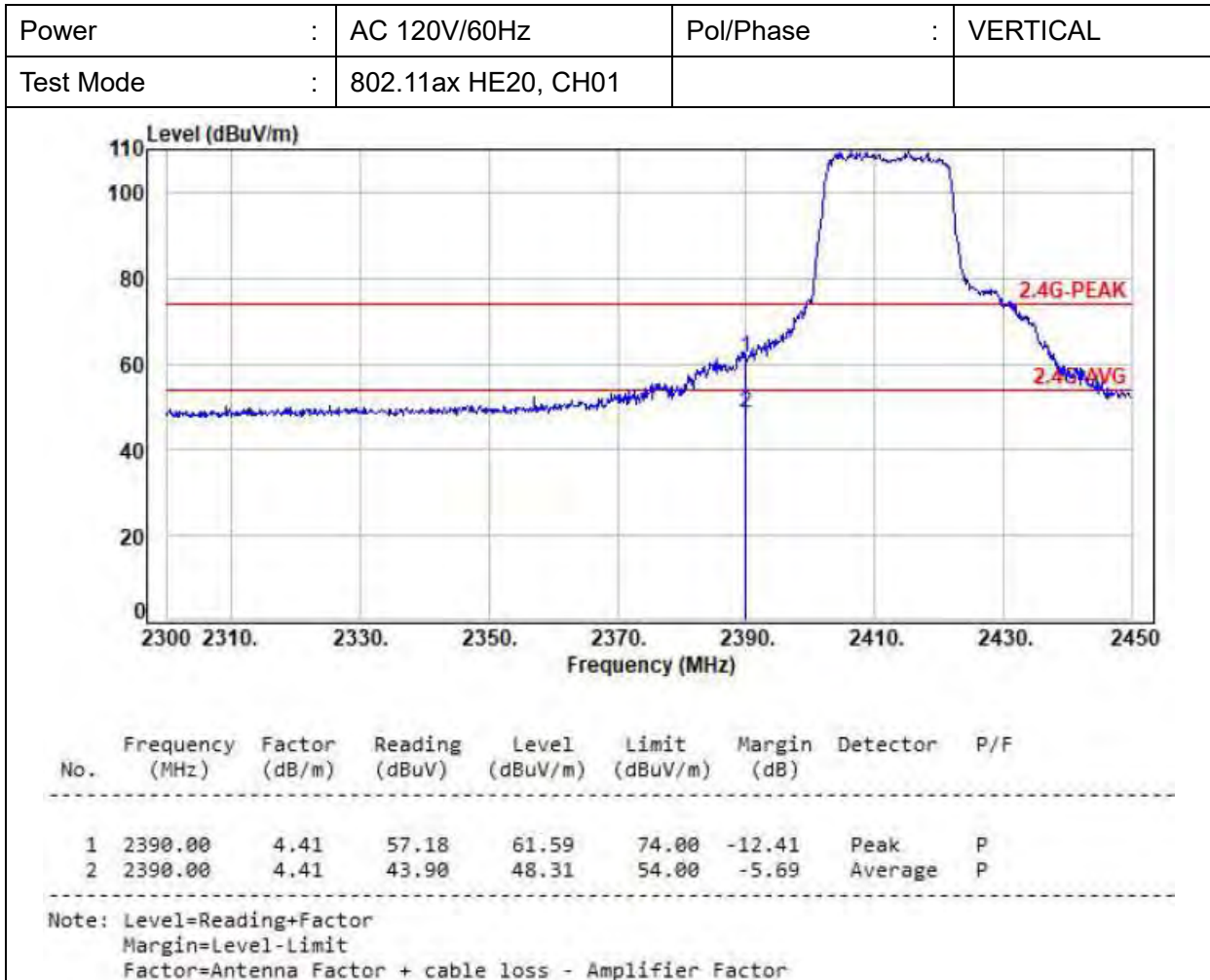



Power	: AC 120V/60Hz	Pol/Phase	: HORIZONTAL
Test Mode	: 802.11ax HE20, CH01		

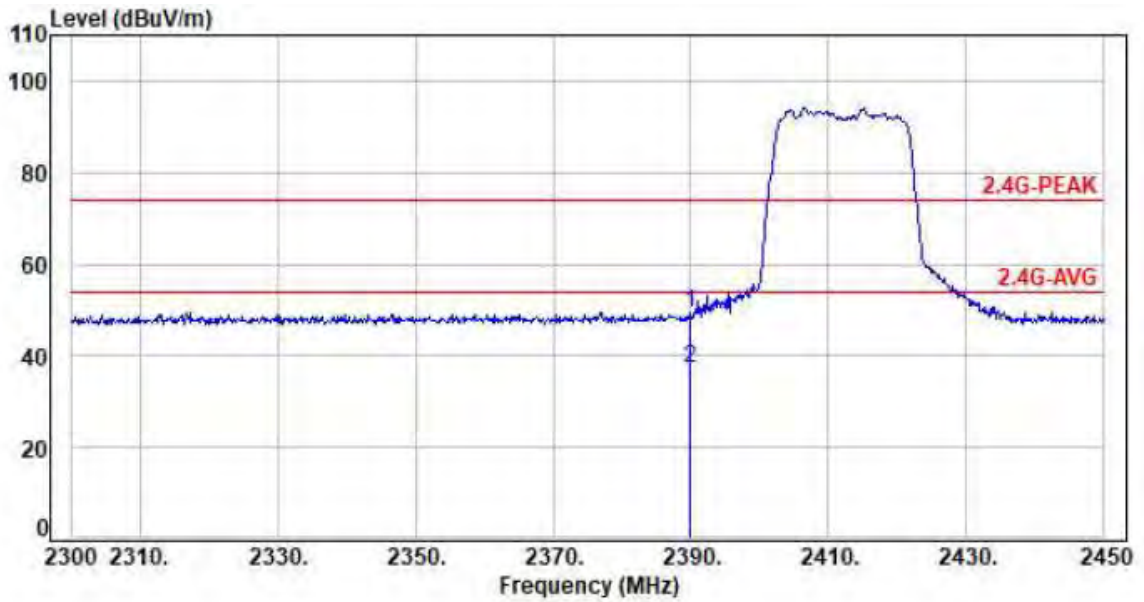

No.	Frequency (MHz)	Factor (dB/m)	Reading (dBuV)	Level (dBuV/m)	Limit (dBuV/m)	Margin (dB)	Detector	P/F
1	2390.00	4.41	45.01	49.42	74.00	-24.58	Peak	P
2	2390.00	4.41	32.74	37.15	54.00	-16.85	Average	P

Note: Level=Reading+Factor
Margin=Level-Limit
Factor=Antenna Factor + cable loss - Amplifier Factor



Power	: AC 120V/60Hz	Pol/Phase	: VERTICAL
Test Mode	: 802.11ax HE20, CH11		

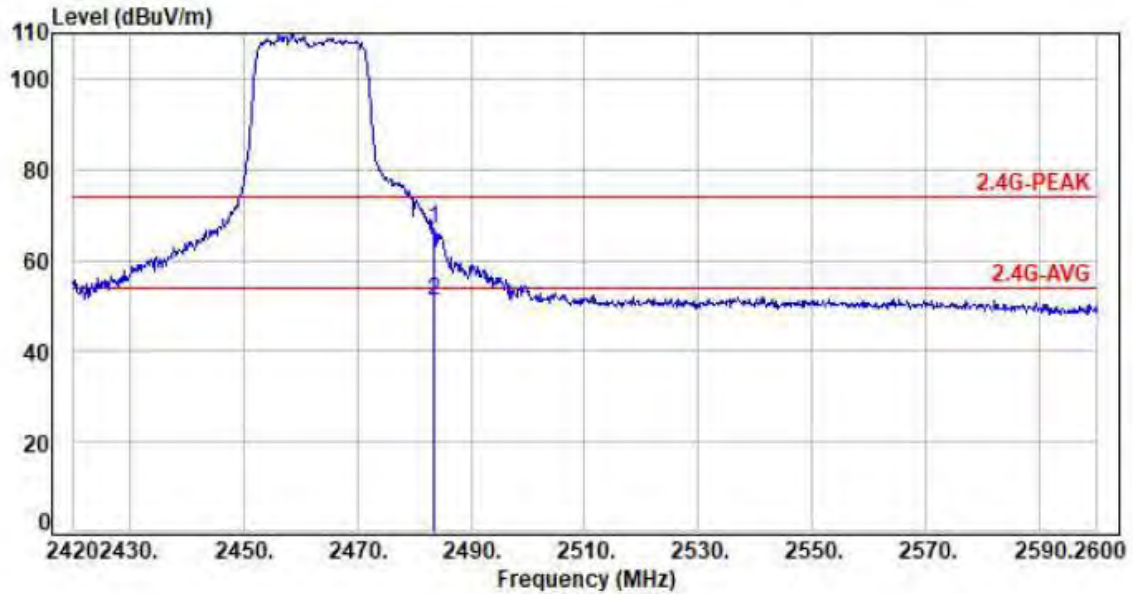

No.	Frequency (MHz)	Factor (dB/m)	Reading (dBuV)	Level (dBuV/m)	Limit (dBuV/m)	Margin (dB)	Detector	P/F
1	2483.50	4.73	62.07	66.80	74.00	-7.20	Peak	P
2	2483.50	4.73	46.42	51.15	54.00	-2.85	Average	P

Note: Level=Reading+Factor
Margin=Level-Limit
Factor=Antenna Factor + cable loss - Amplifier Factor



Power	: AC 120V/60Hz	Pol/Phase	: HORIZONTAL
Test Mode	: 802.11ax HE20, CH11		

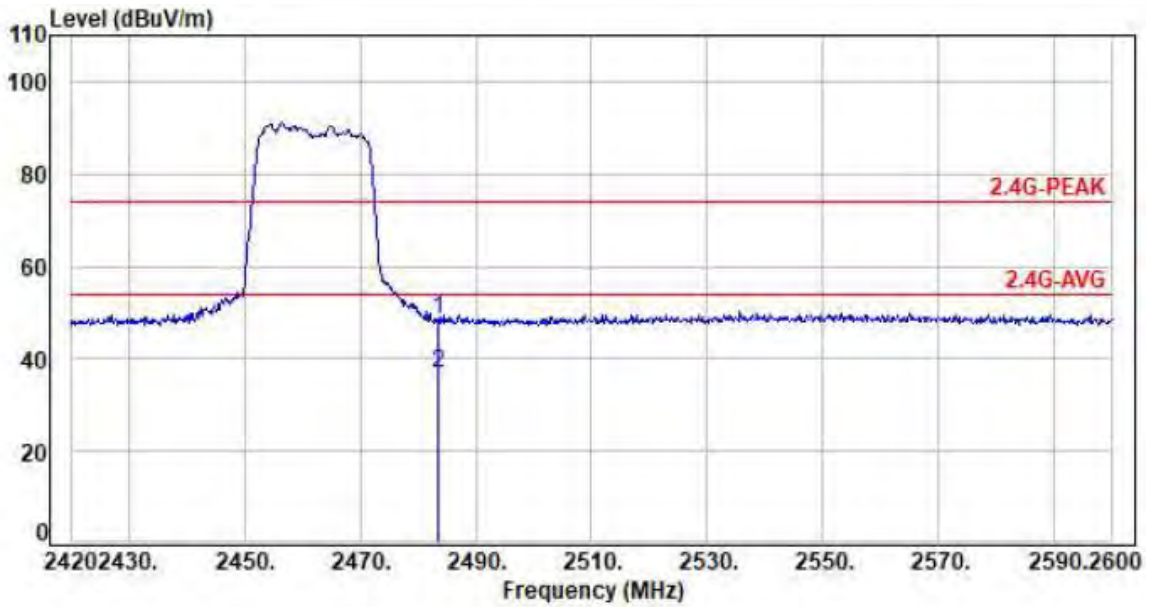

No.	Frequency (MHz)	Factor (dB/m)	Reading (dBuV)	Level (dBuV/m)	Limit (dBuV/m)	Margin (dB)	Detector	P/F
1	2483.50	4.73	43.84	48.57	74.00	-25.43	Peak	P
2	2483.50	4.73	32.08	36.81	54.00	-17.19	Average	P

Note: Level=Reading+Factor
Margin=Level-Limit
Factor=Antenna Factor + cable loss - Amplifier Factor



Power	: AC 120V/60Hz	Pol/Phase	: VERTICAL
Test Mode	: 802.11ax HE40, CH03		

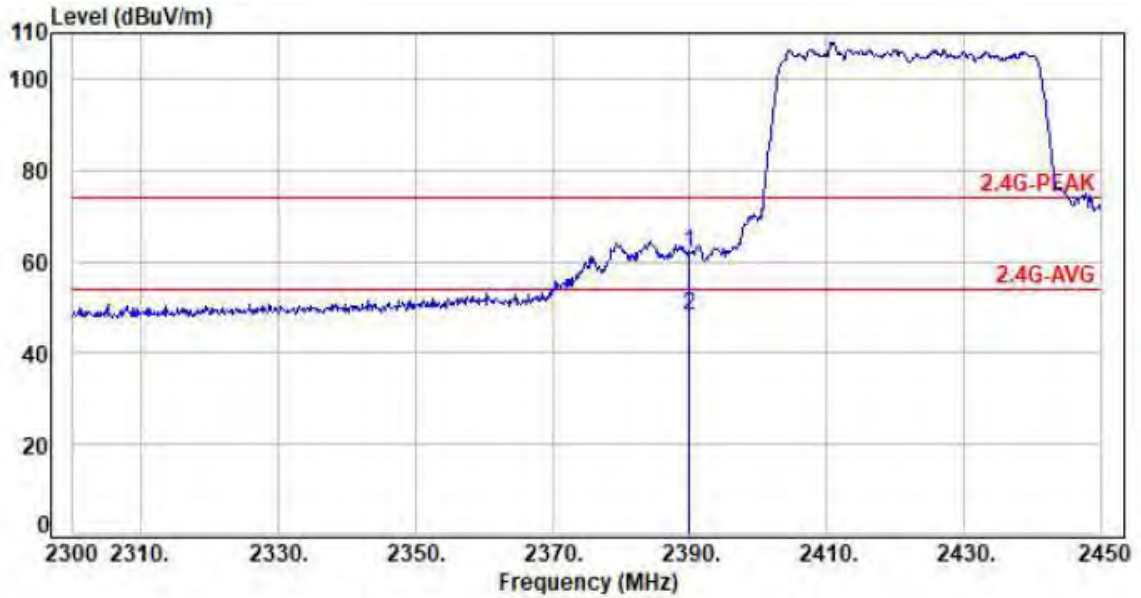

No.	Frequency (MHz)	Factor (dB/m)	Reading (dBuV)	Level (dBuV/m)	Limit (dBuV/m)	Margin (dB)	Detector	P/F
1	2390.00	4.41	57.56	61.97	74.00	-12.03	Peak	P
2	2390.00	4.41	43.63	48.04	54.00	-5.96	Average	P

Note: Level=Reading+Factor
Margin=Level-Limit
Factor=Antenna Factor + cable loss - Amplifier Factor



Power	: AC 120V/60Hz	Pol/Phase	: HORIZONTAL
Test Mode	: 802.11ax HE40, CH03		

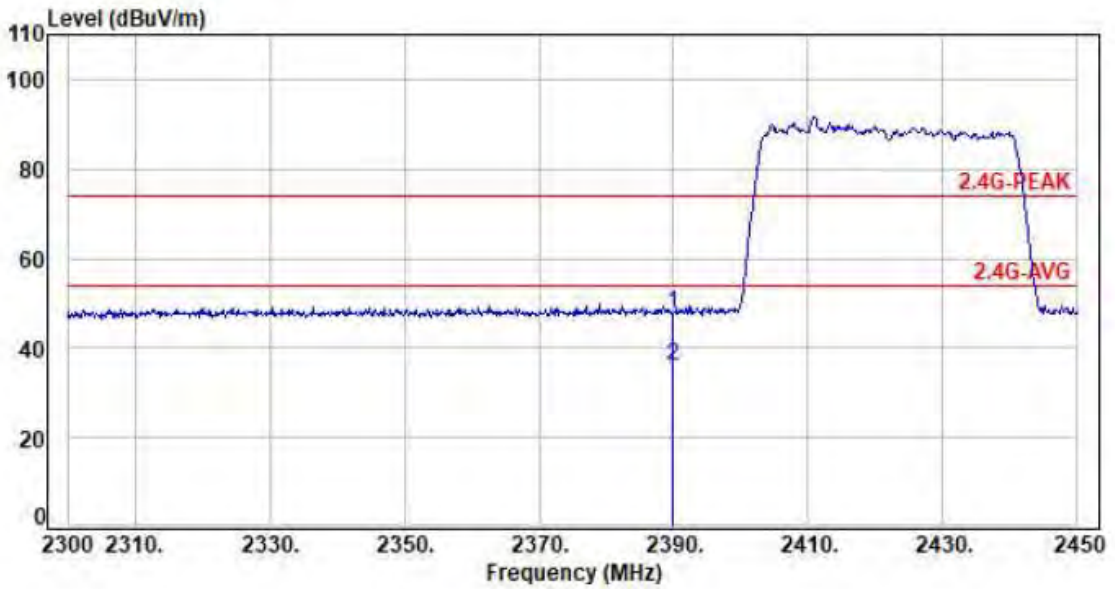

No.	Frequency (MHz)	Factor (dB/m)	Reading (dBuV)	Level (dBuV/m)	Limit (dBuV/m)	Margin (dB)	Detector	P/F
1	2390.00	4.41	43.41	47.82	74.00	-26.18	Peak	P
2	2390.00	4.41	31.69	36.10	54.00	-17.90	Average	P

Note: Level=Reading+Factor
Margin=Level-Limit
Factor=Antenna Factor + cable loss - Amplifier Factor



Power	: AC 120V/60Hz	Pol/Phase	: VERTICAL
Test Mode	: 802.11ax HE40, CH09		

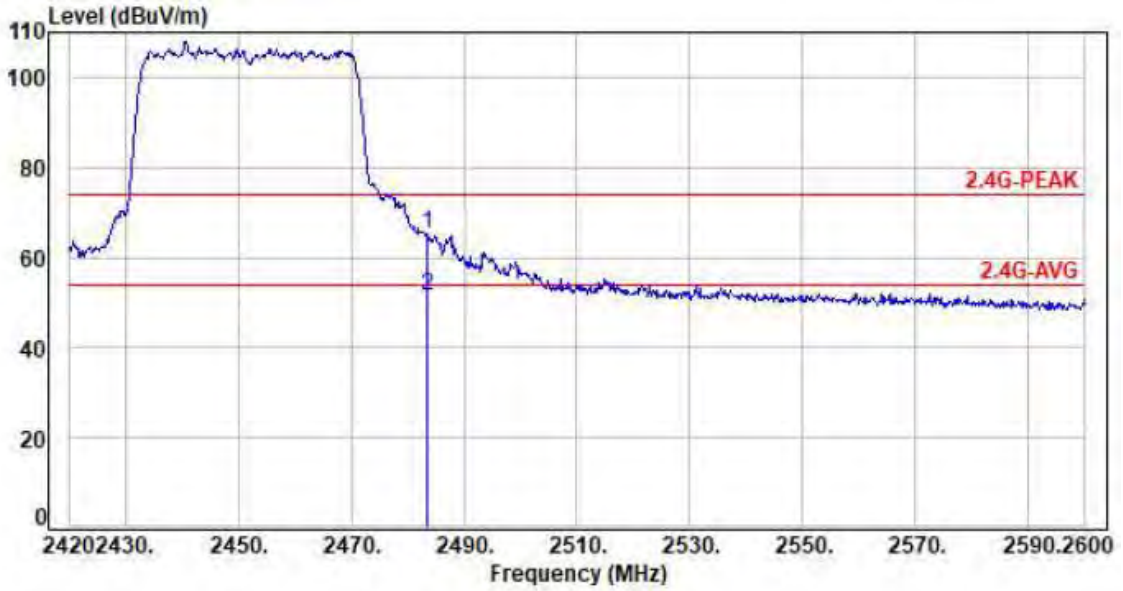

No.	Frequency (MHz)	Factor (dB/m)	Reading (dBuV)	Level (dBuV/m)	Limit (dBuV/m)	Margin (dB)	Detector	P/F
1	2483.50	4.73	60.32	65.05	74.00	-8.95	Peak	P
2	2483.50	4.73	46.61	51.34	54.00	-2.66	Average	P

Note: Level=Reading+Factor
Margin=Level-Limit
Factor=Antenna Factor + cable loss - Amplifier Factor



Power	: AC 120V/60Hz	Pol/Phase	: HORIZONTAL
Test Mode	: 802.11ax HE40, CH09		

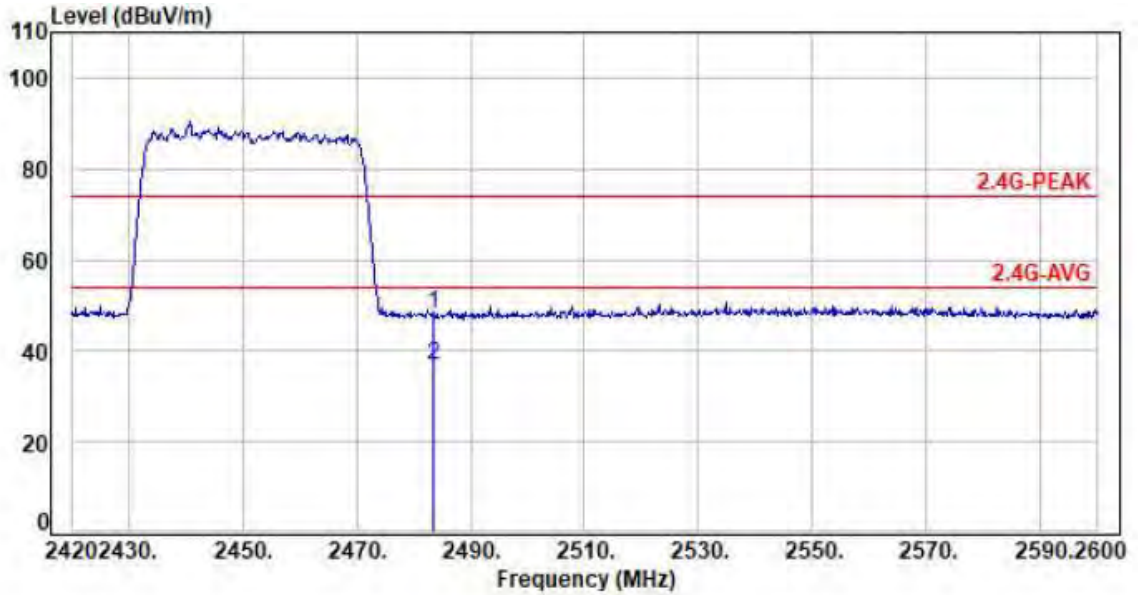

No.	Frequency (MHz)	Factor (dB/m)	Reading (dBuV)	Level (dBuV/m)	Limit (dBuV/m)	Margin (dB)	Detector	P/F
1	2483.50	4.73	43.31	48.04	74.00	-25.96	Peak	P
2	2483.50	4.73	32.12	36.85	54.00	-17.15	Average	P

Note: Level=Reading+Factor
Margin=Level-Limit
Factor=Antenna Factor + cable loss - Amplifier Factor



7. Test of Conducted Spurious Emission

7.1 Test Limit

Below -20dB of the highest emission level of operating band (In 100 kHz Resolution Bandwidth)

7.2 Test Procedure

- The transmitter output was connected to the spectrum analyzer via a low loss cable.
- Set RBW of spectrum analyzer to 100 KHz and VBW of spectrum analyzer to 300 KHz with convenient frequency span including 100 KHz bandwidth from band edge.
- Peak conducted output power measured within any 100 kHz outside the authorized frequency band shall be attenuated by at least 20dB relative to the maximum measured in-band peak PSD level.
- The band edges was measured and recorded.

7.3 Test Setup Layout

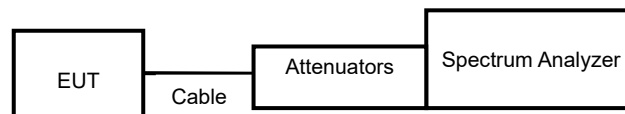

7.4 Test Result and Data

Note: Test plots refers to the following pages.



Antenna A

Modulation Standard: 802.11b

Channel: 01

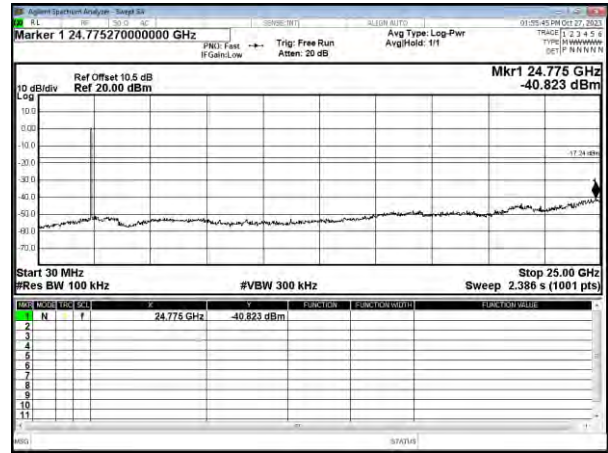
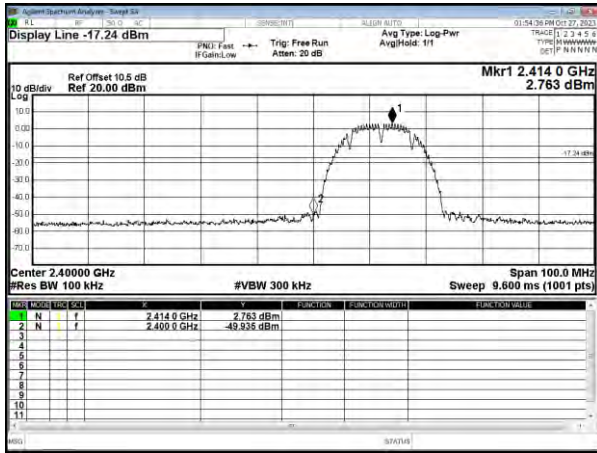

Modulation Standard: 802.11b

Channel: 06

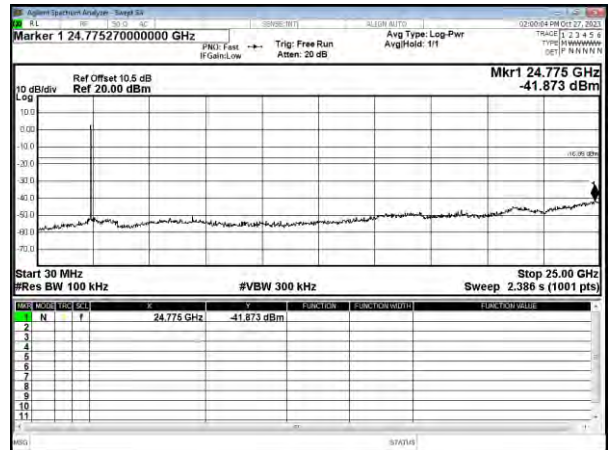
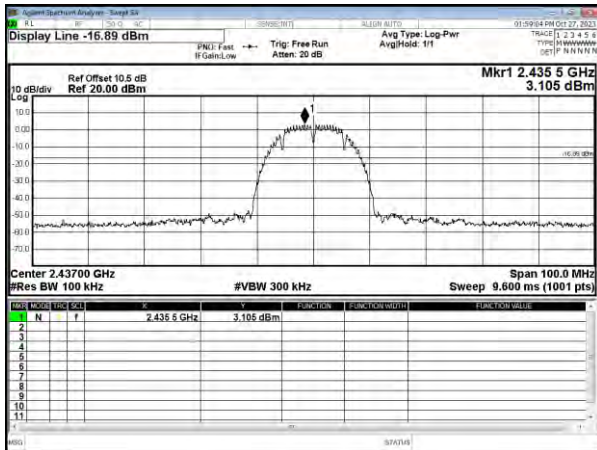

Modulation Standard: 802.11b

Channel: 11

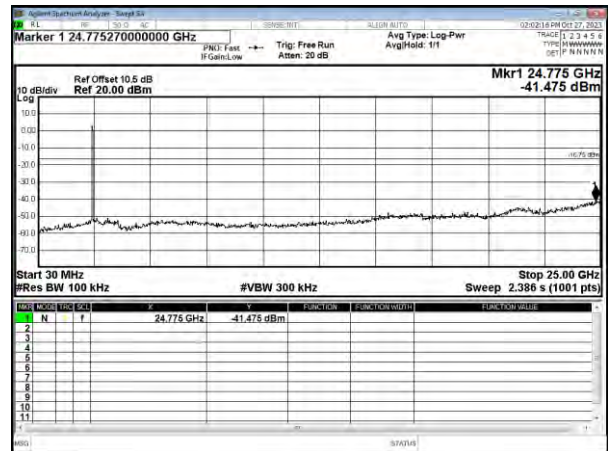
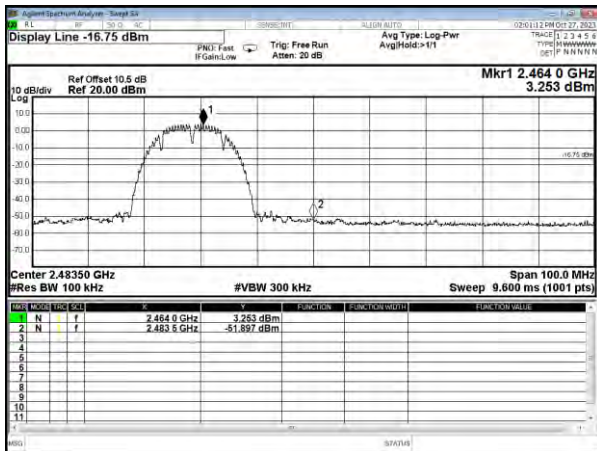



Modulation Standard: 802.11g
Channel: 01

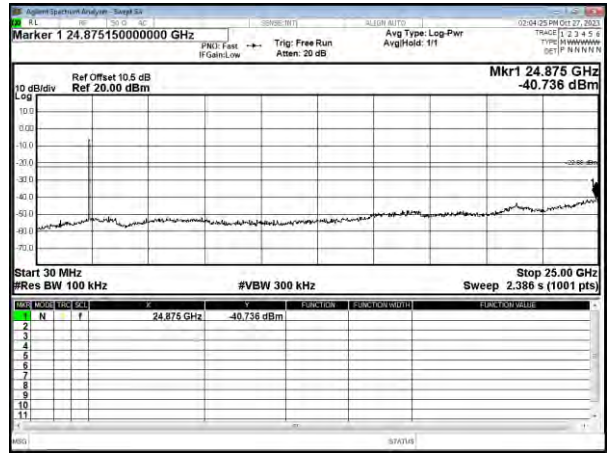
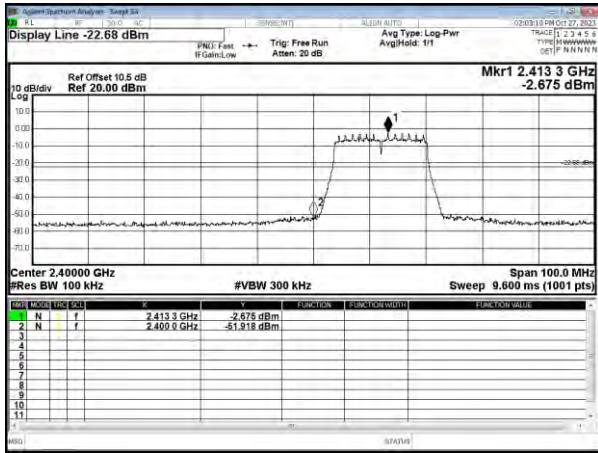

Modulation Standard: 802.11g
Channel: 06

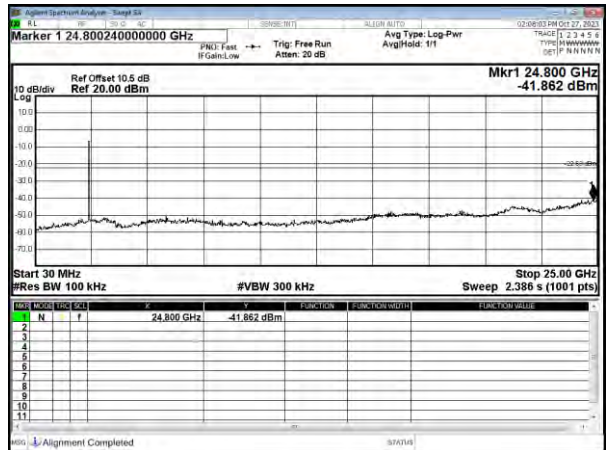
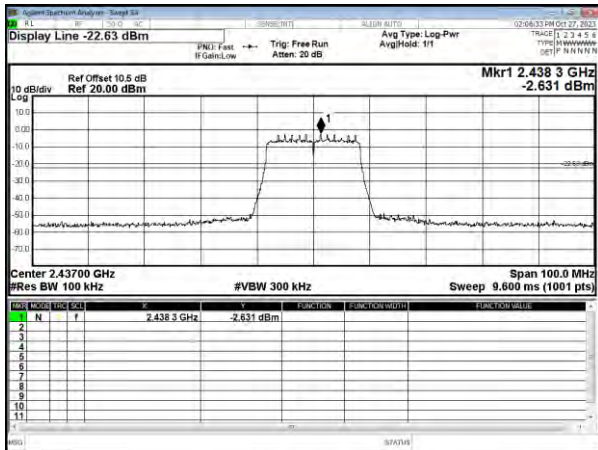

Modulation Standard: 802.11g
Channel: 11

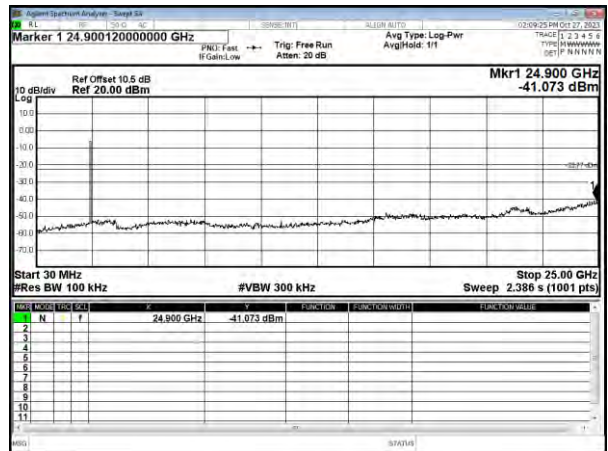
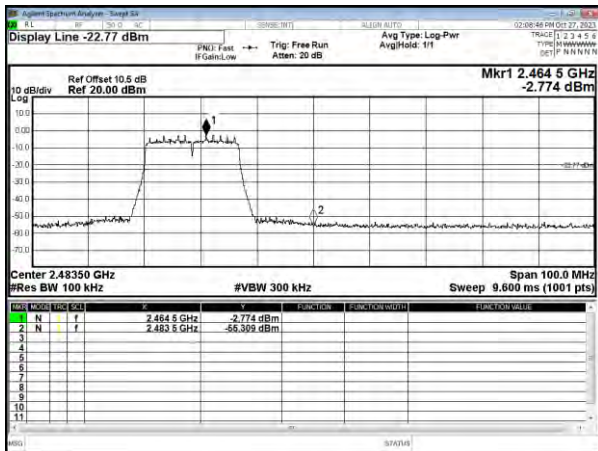



Modulation Standard: 802.11n HT20
Channel: 01

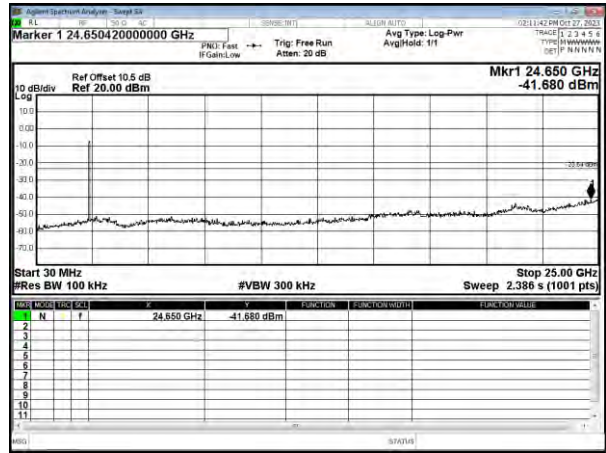
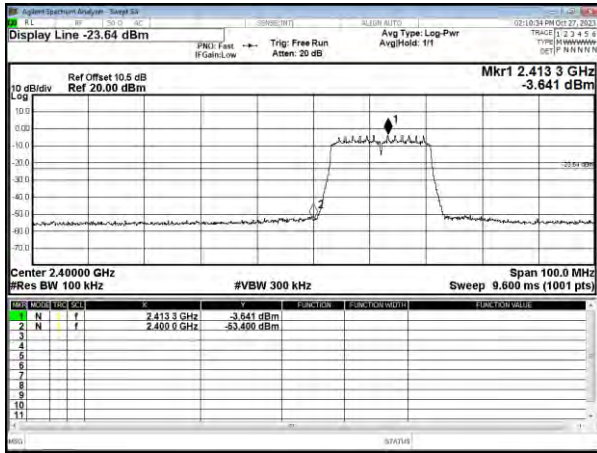

Modulation Standard: 802.11n HT20
Channel: 06

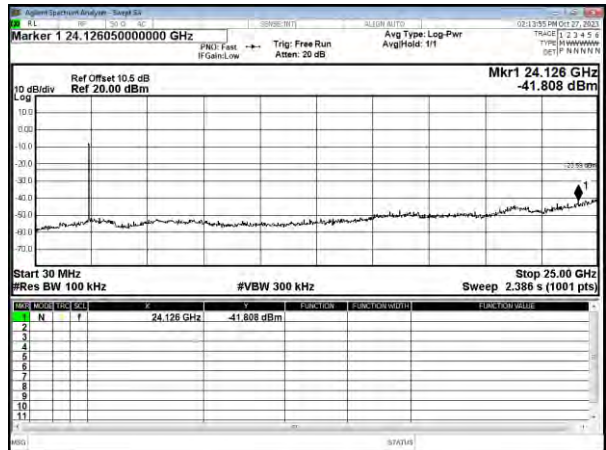
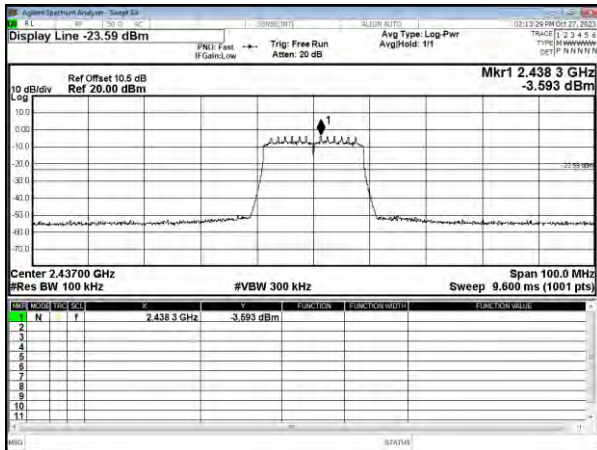

Modulation Standard: 802.11n HT20
Channel: 11

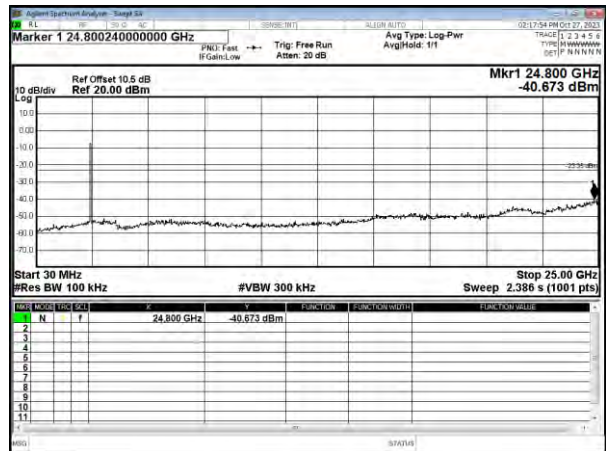
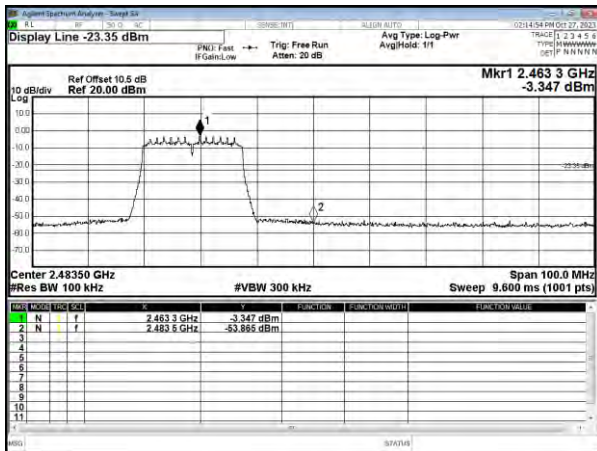



Modulation Standard: 802.11n HT40
Channel: 03

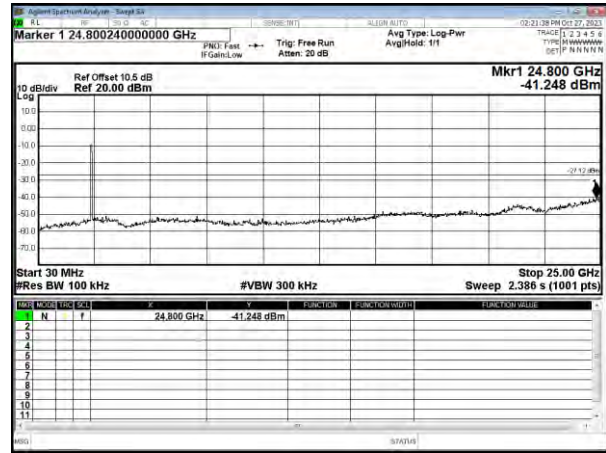
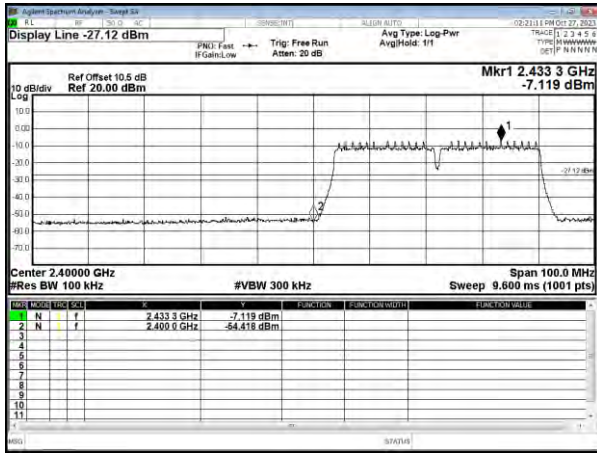

Modulation Standard: 802.11n HT40
Channel: 06

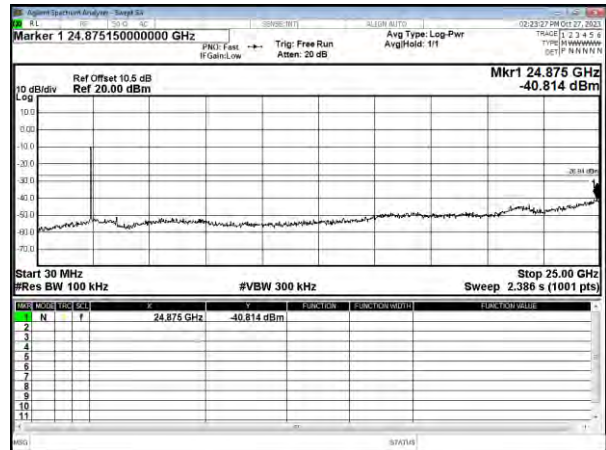
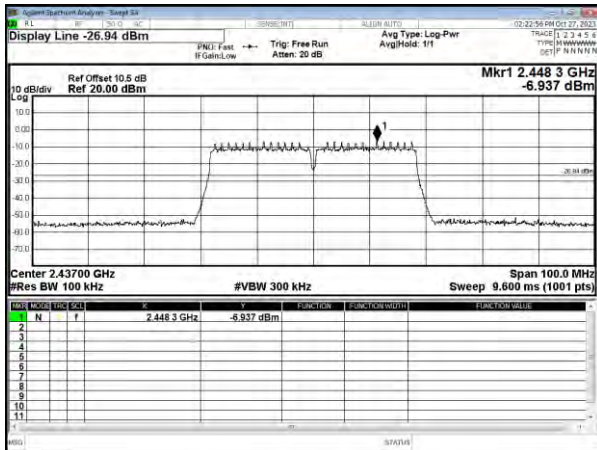

Modulation Standard: 802.11n HT40
Channel: 09

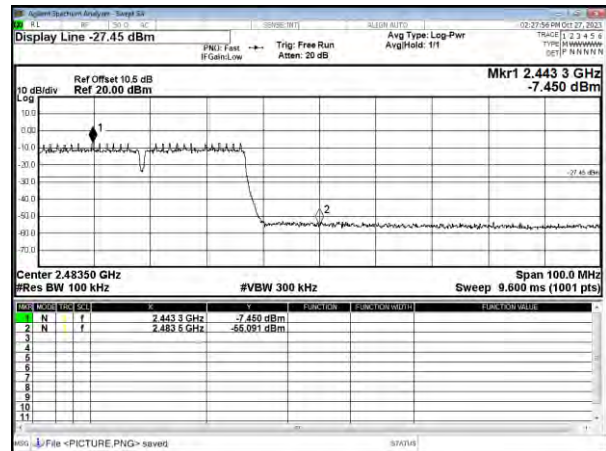
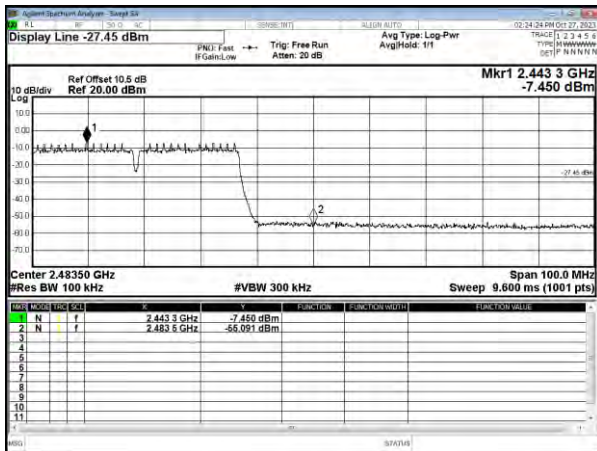



Modulation Standard: 802.11ax HE20
Channel: 01

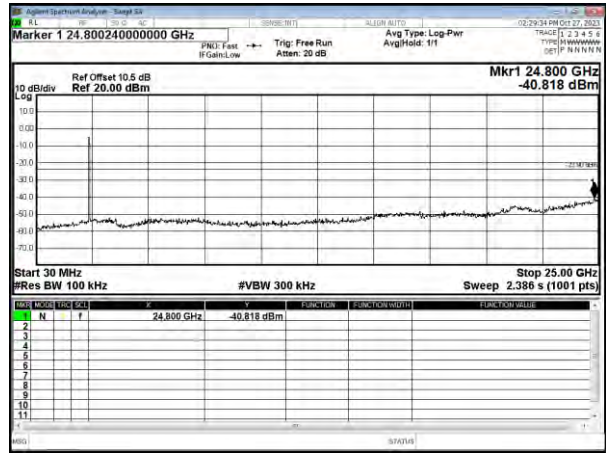
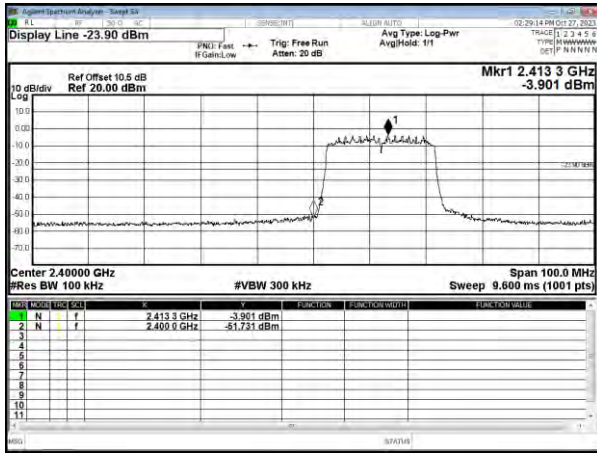

Modulation Standard: 802.11ax HE20
Channel: 06

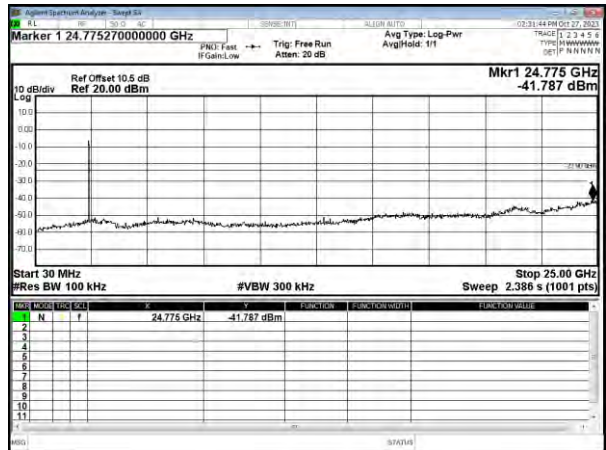
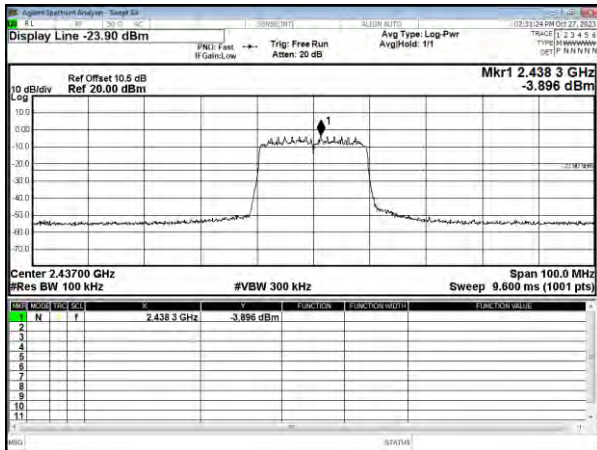

Modulation Standard: 802.11ax HE20
Channel: 11

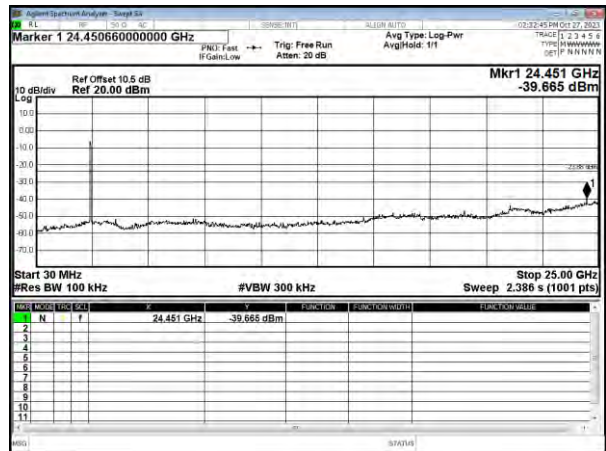
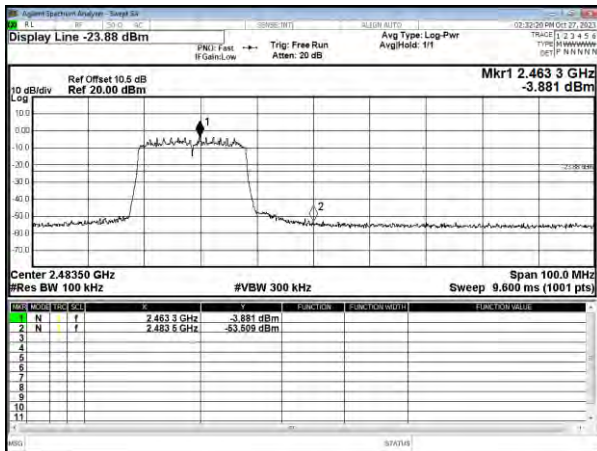



Modulation Standard: 802.11ax HE40
Channel: 03

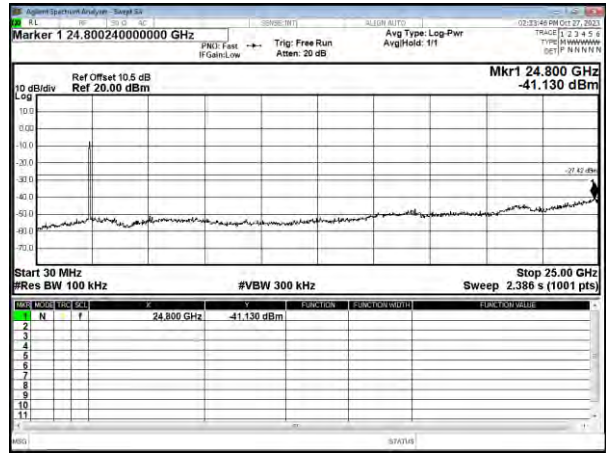
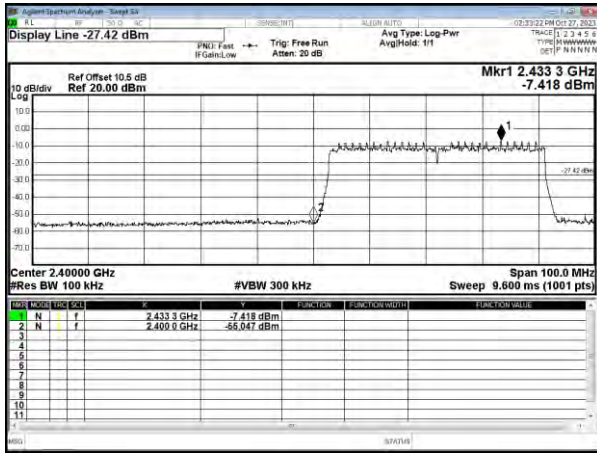

Modulation Standard: 802.11ax HE40
Channel: 06

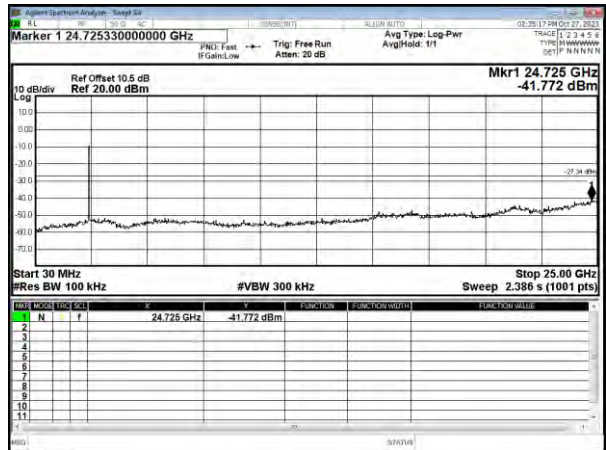
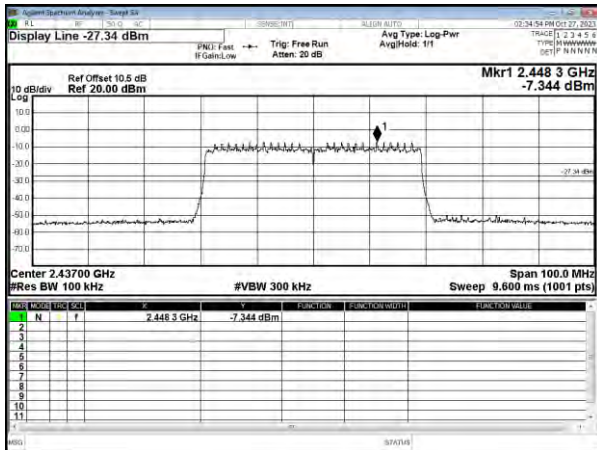

Modulation Standard: 802.11ax HE40
Channel: 09

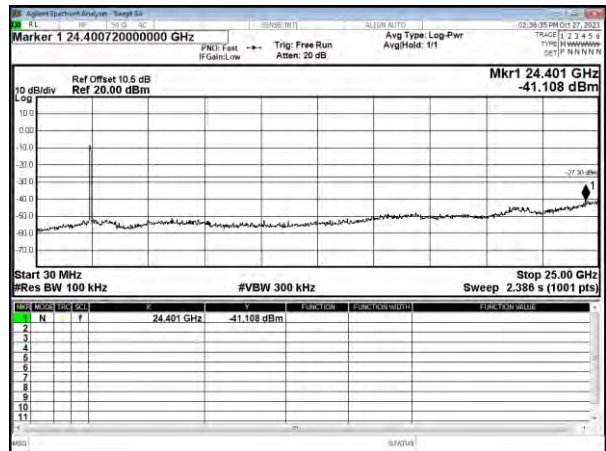
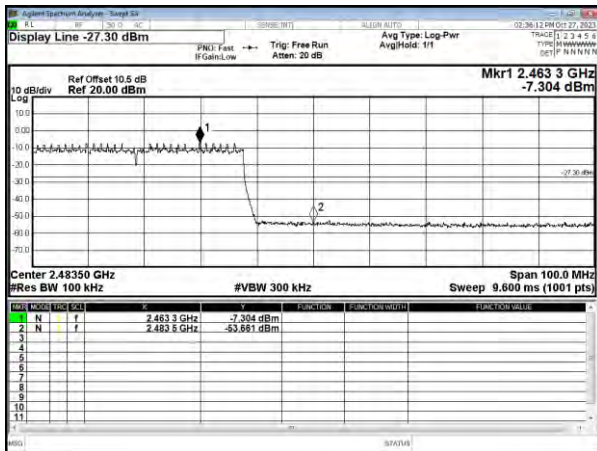



Antenna B

Modulation Standard: 802.11b

Channel: 01

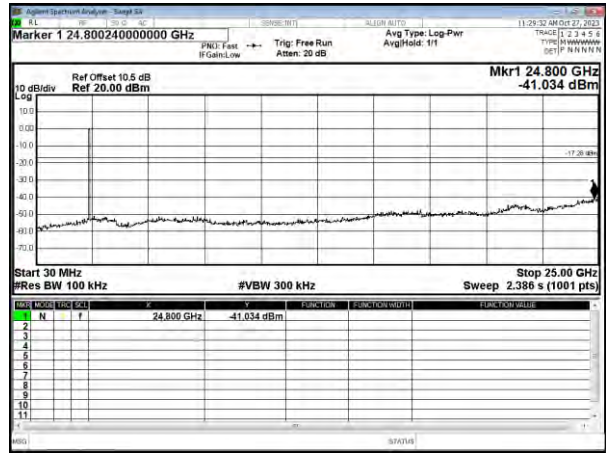
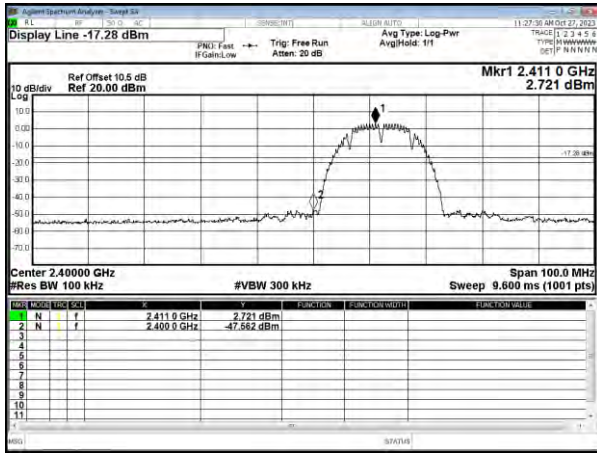

Modulation Standard: 802.11b

Channel: 06

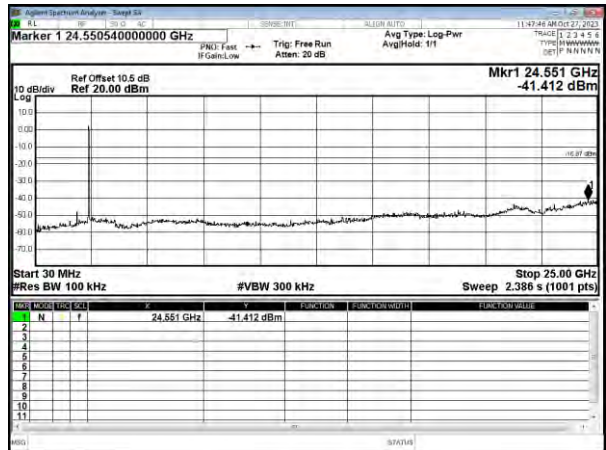
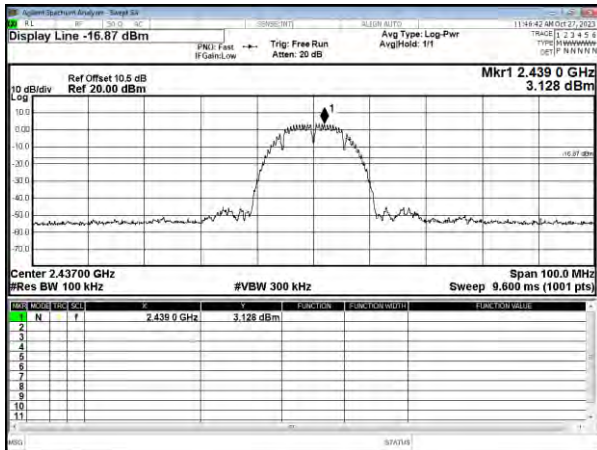

Modulation Standard: 802.11b

Channel: 11

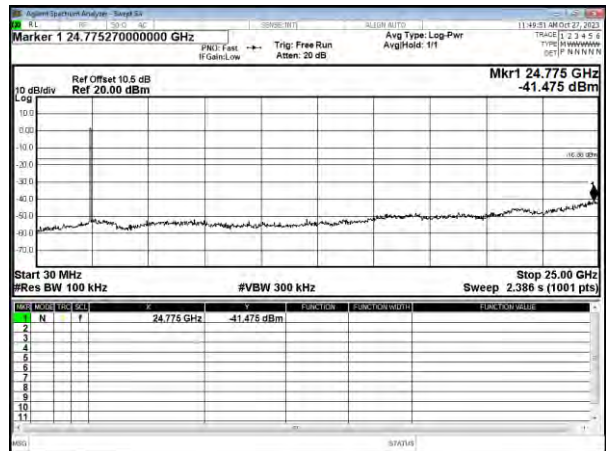
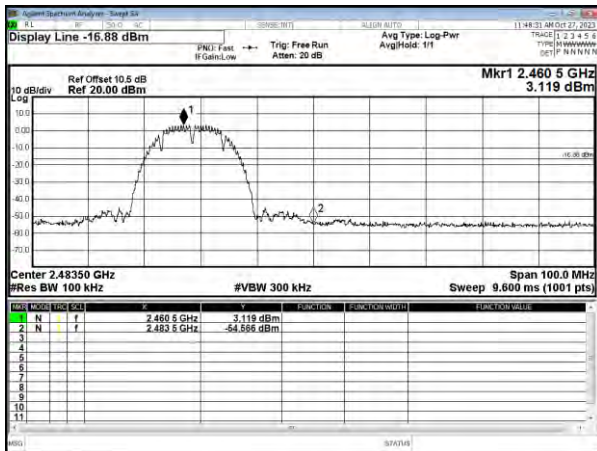



Modulation Standard: 802.11g
Channel: 01

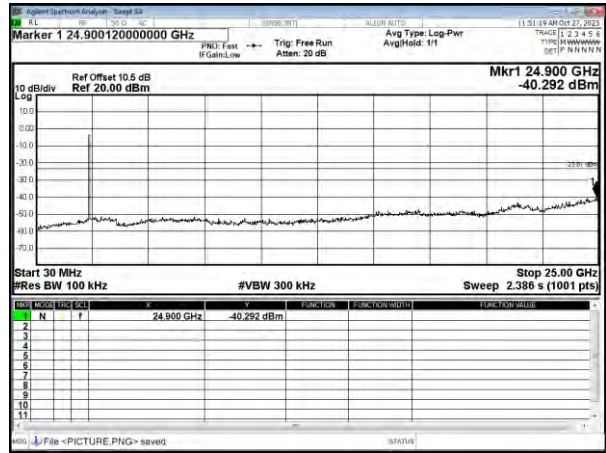
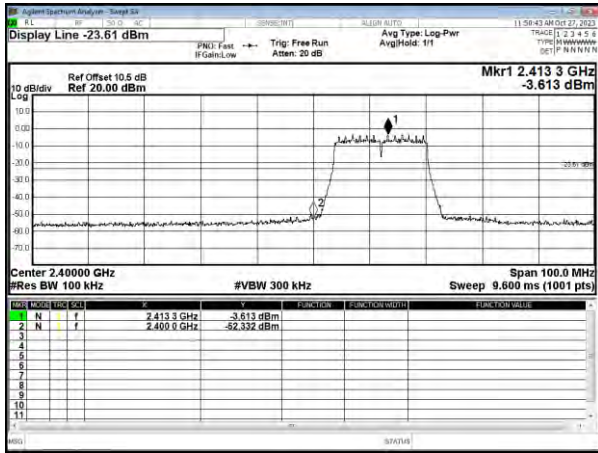

Modulation Standard: 802.11g
Channel: 06

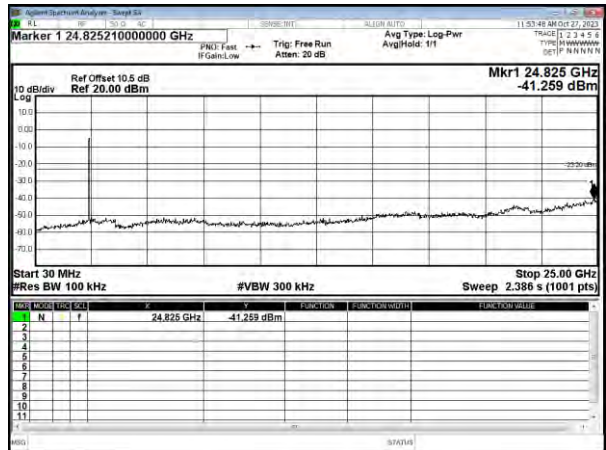
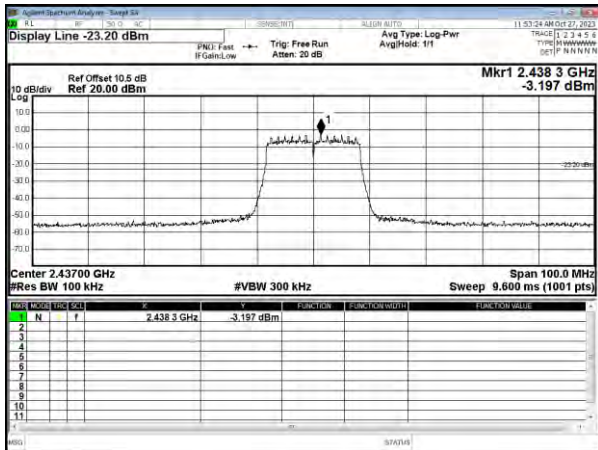

Modulation Standard: 802.11g
Channel: 11

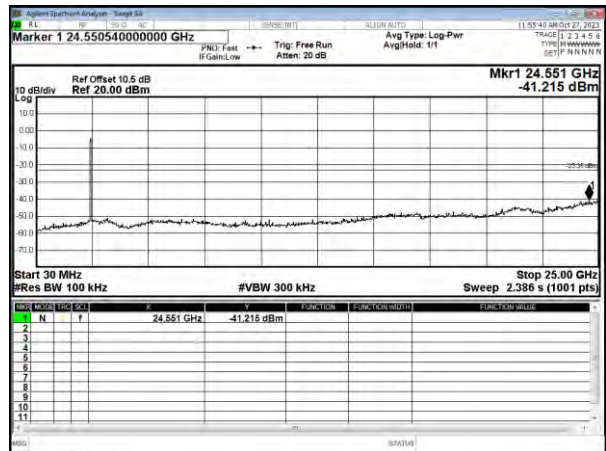
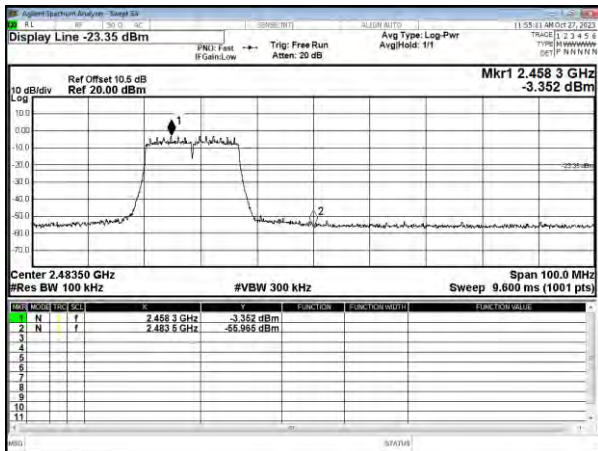



Modulation Standard: 802.11n HT20
Channel: 01

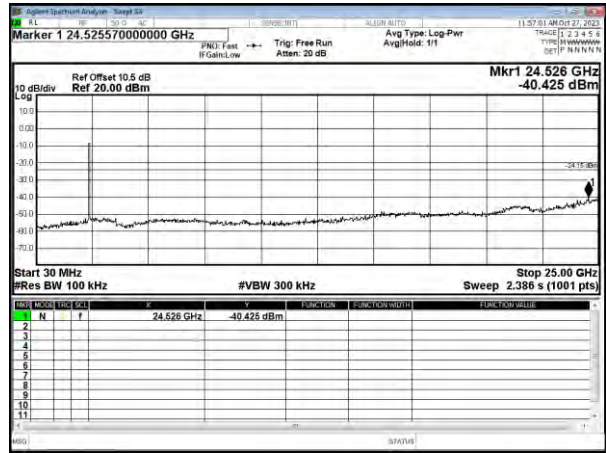
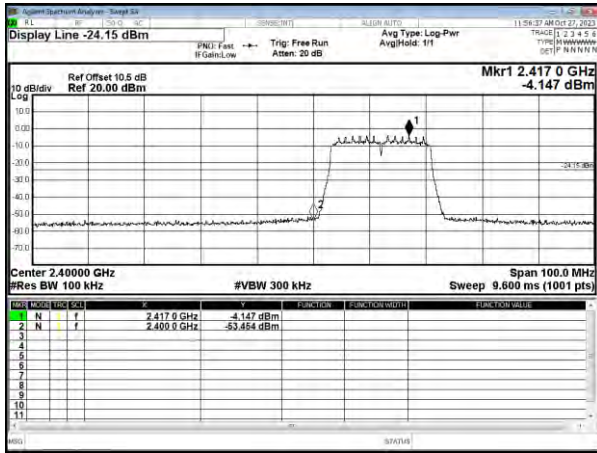

Modulation Standard: 802.11n HT20
Channel: 06

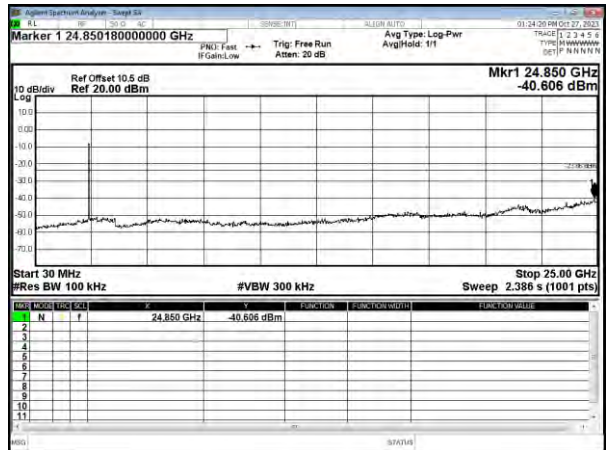
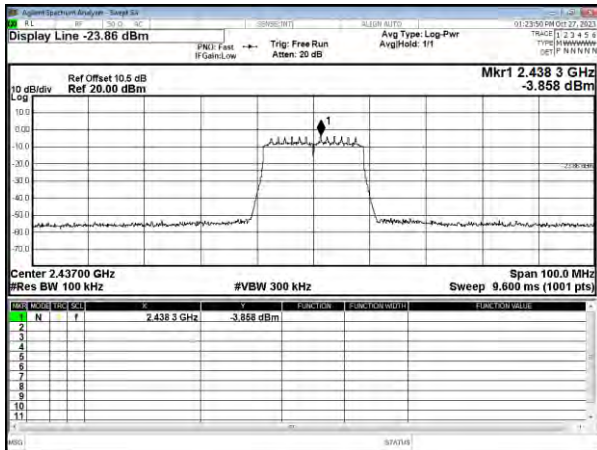

Modulation Standard: 802.11n HT20
Channel: 11

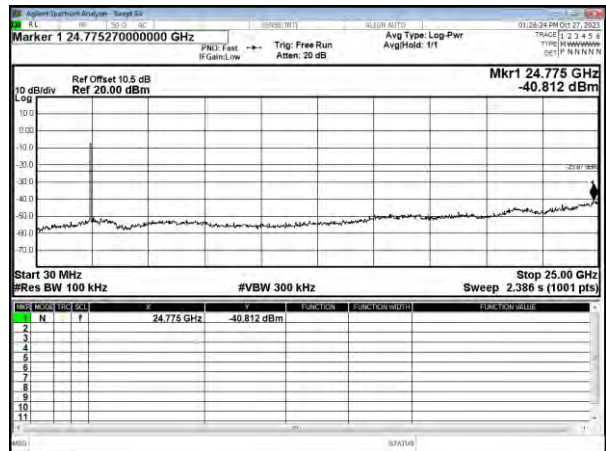
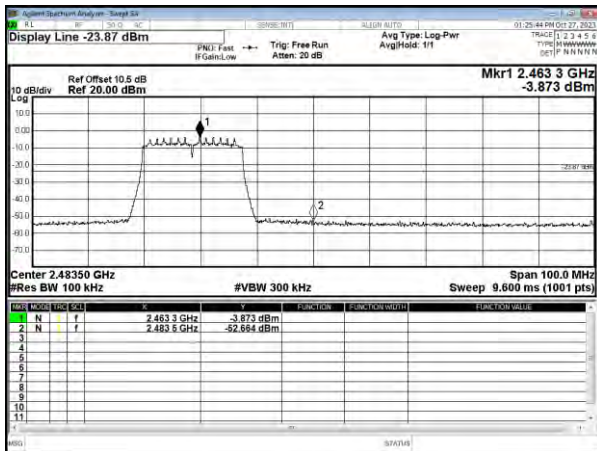



Modulation Standard: 802.11n HT40
Channel: 03

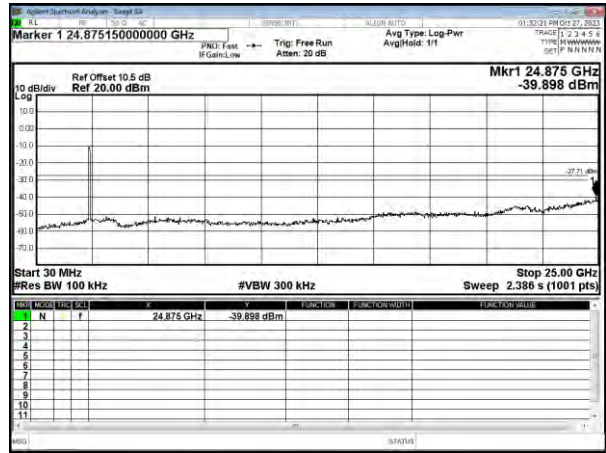
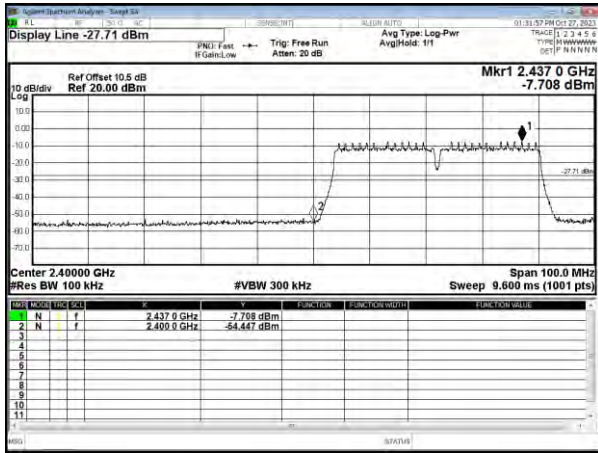

Modulation Standard: 802.11n HT40
Channel: 06

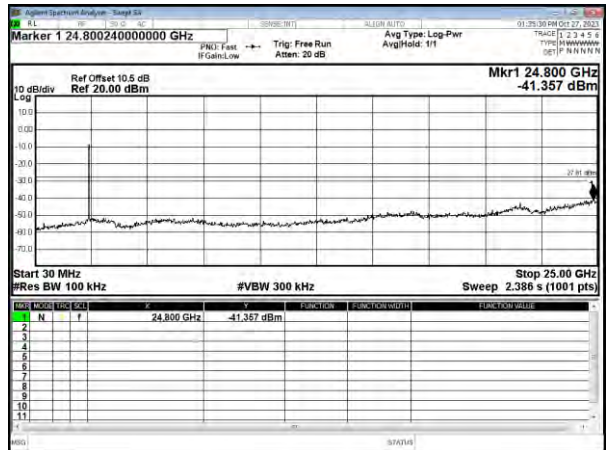
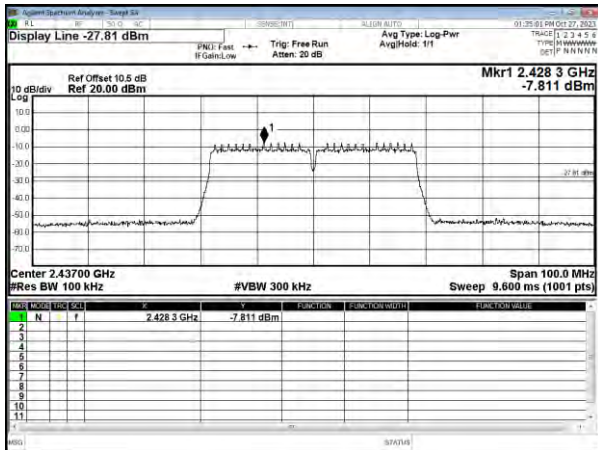

Modulation Standard: 802.11n HT40
Channel: 09

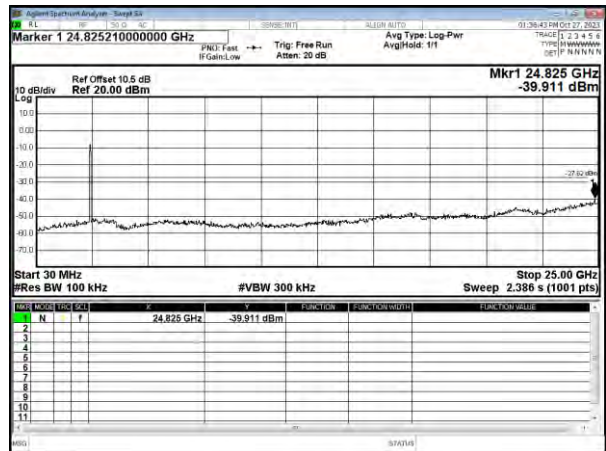
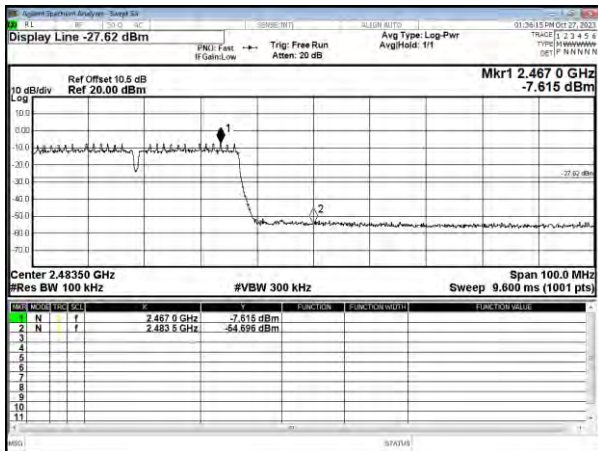



Modulation Standard: 802.11ax HE20
Channel: 01

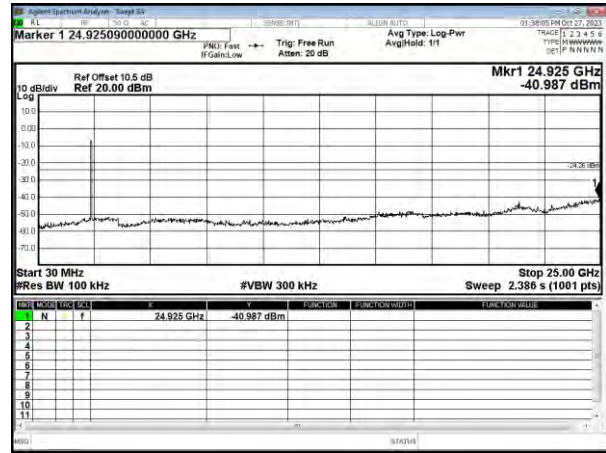
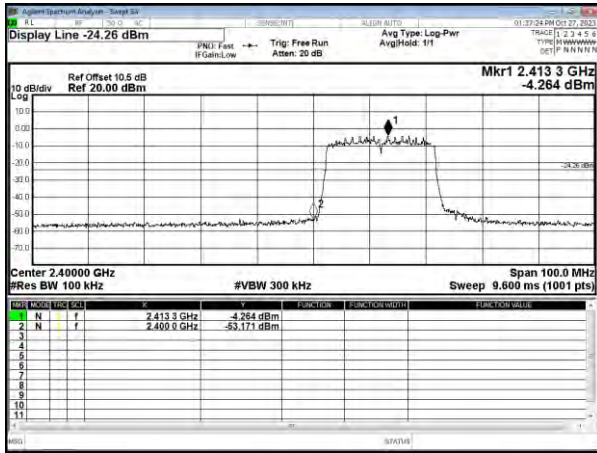

Modulation Standard: 802.11ax HE20
Channel: 06

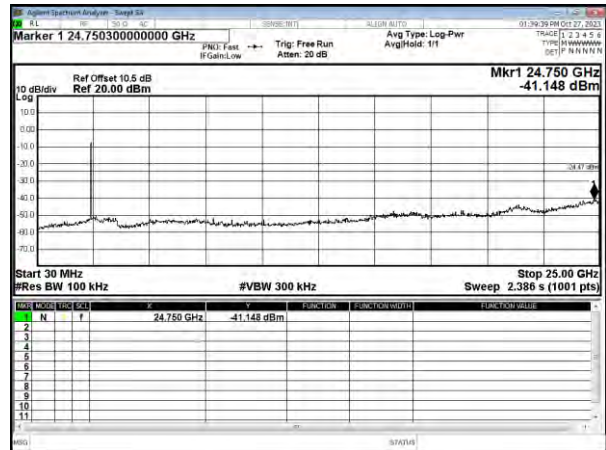
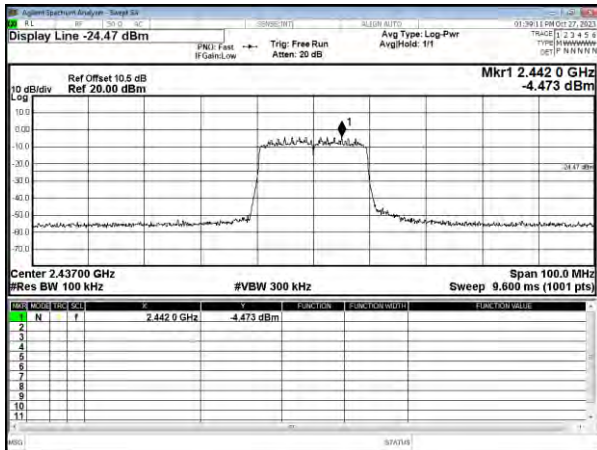

Modulation Standard: 802.11ax HE20
Channel: 11

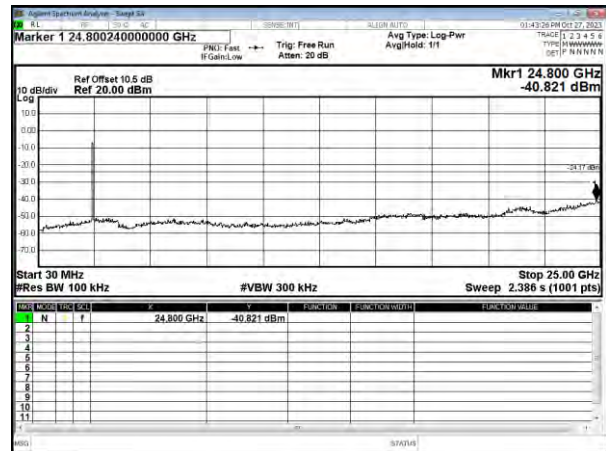
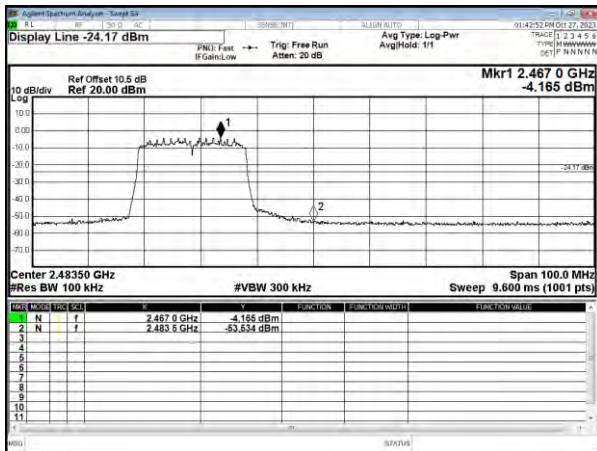



Modulation Standard: 802.11ax HE40
Channel: 03

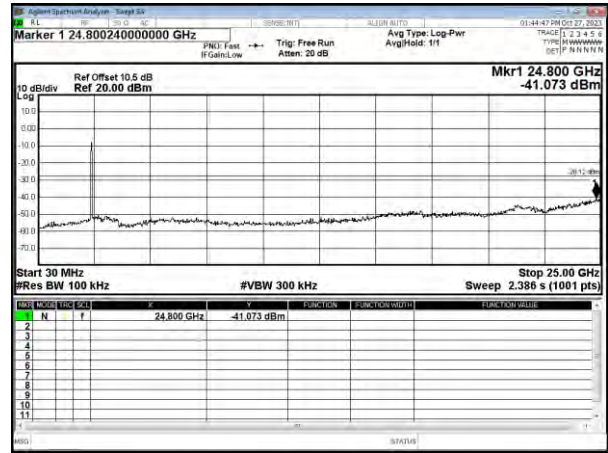
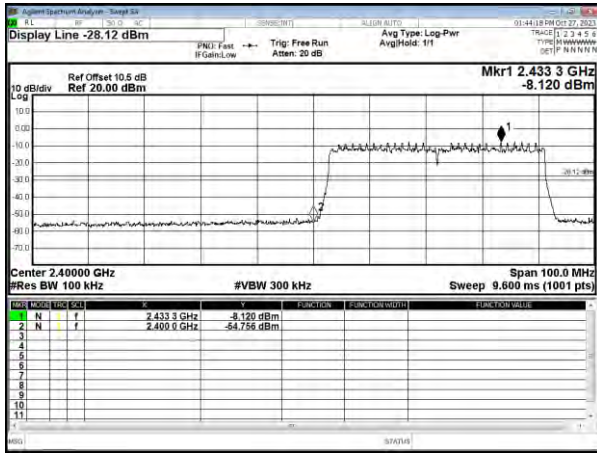

Modulation Standard: 802.11ax HE40
Channel: 06

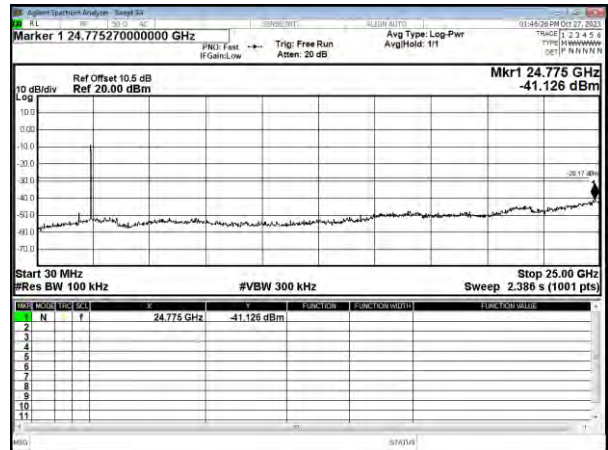
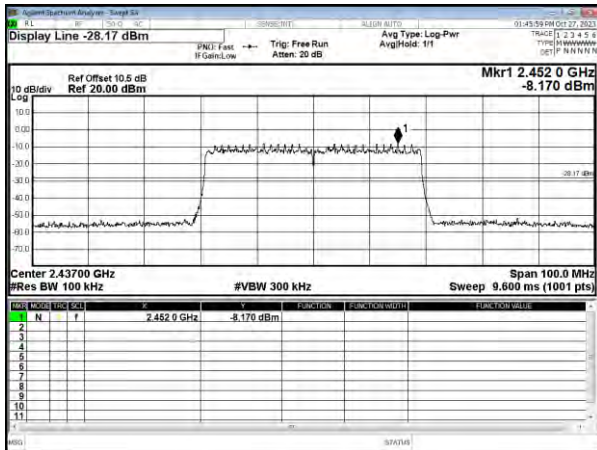

Modulation Standard: 802.11ax HE40
Channel: 09

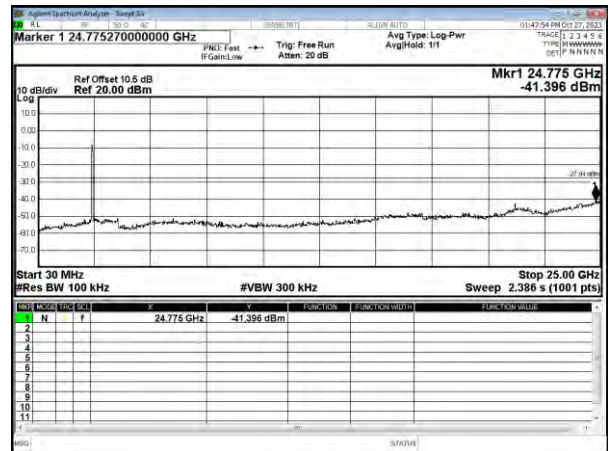
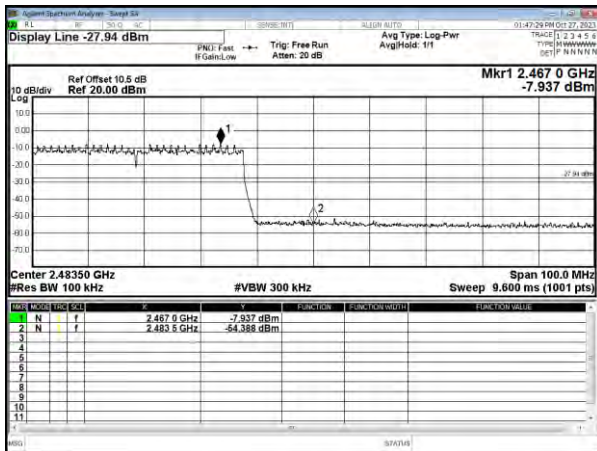



8. On Time, Duty Cycle and Measurement methods

8.1 Test Limit

None; for reporting purposes only.

8.2 Test Procedure

Zero-Span Spectrum Analyzer Method.

8.3 Test Setup Layout

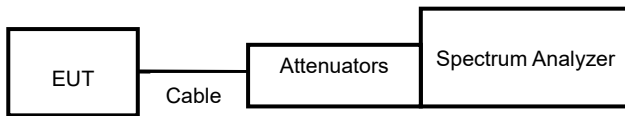



8.4 Test Result and Data

Modulation Type	On Time (ms)	Period Time (ms)	Duty Cycle (%)
11b	100.00	100.00	100.00%
11g	1.366	1.368	99.85%
11n HT20	1.276	1.280	99.69%
11n HT40	0.634	0.640	99.06%
11ax HE20	0.990	0.994	99.60%
11ax HE40	0.522	0.527	99.05%



Modulation Type: 802.11b(1Mbps)

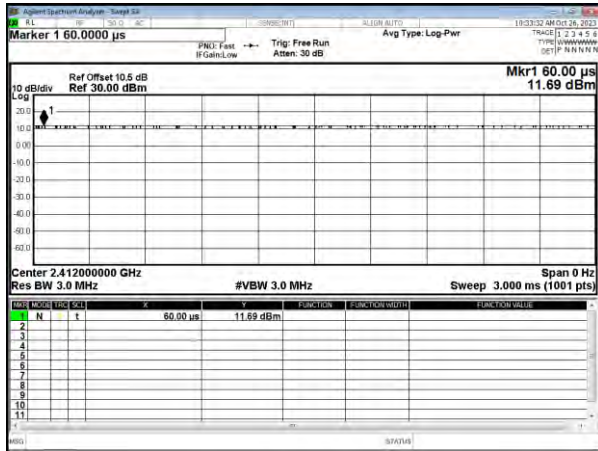

Modulation Type: 802.11g(6Mbps)

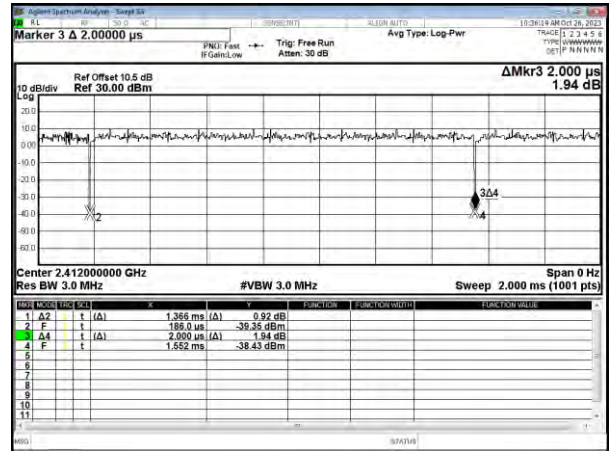

Modulation Type: 802.11n HT20(6.5Mbps)

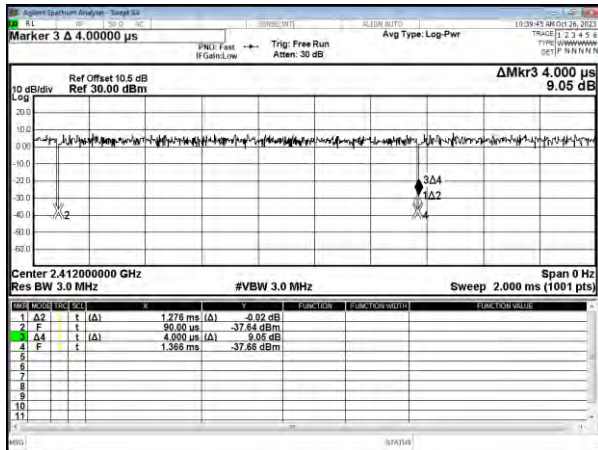

Modulation Type: 802.11n HT40(13.5Mbps)

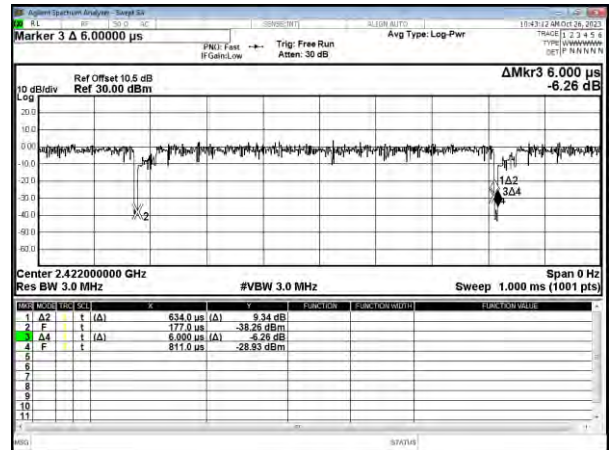

Modulation Type: 802.11ax HE20 (7.3Mbps)

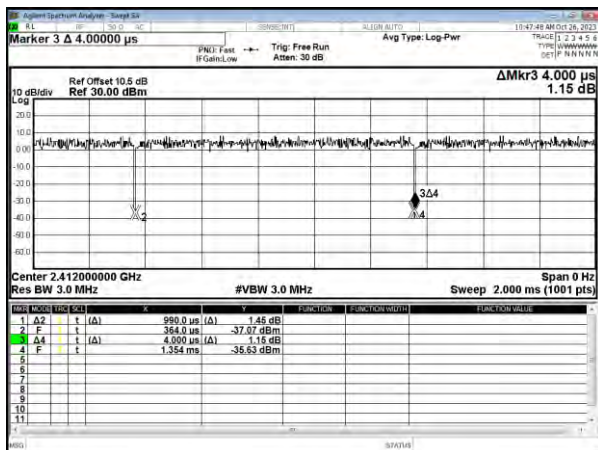

Modulation Type: 802.11 ax HE40(14.6Mbps)

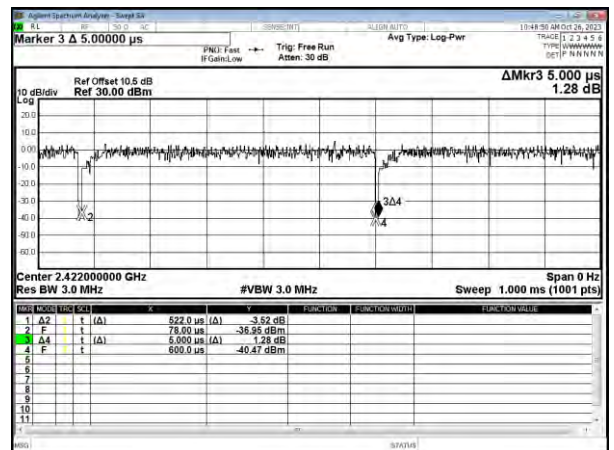



9. 6dB Bandwidth Measurement Data

9.1 Test Limit

The minimum of 6dB Bandwidth Measurement is 0.5 MHz.

9.2 Test Procedures

- a. The transmitter output was connected to the spectrum analyzer.
- b. Set RBW of spectrum analyzer to 100 KHz and VBW to 300 KHz.
- c. Set spectrum analyzer X dB to 6 dB.
- d. Set spectrum analyzer peak detector with maximum hold.

9.3 Test Setup Layout

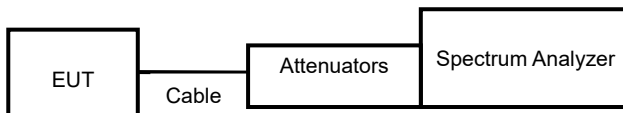



9.4 Test Result and Data

Modulation Type	Channel	Frequency (MHz)	6dB Bandwidth (MHz)		Limit (MHz)
			ANT A	ANT B	
IEEE 802.11b	01	2412	11.13	11.10	0.5
	06	2437	10.16	10.18	0.5
	11	2462	11.12	11.11	0.5
IEEE 802.11g	01	2412	16.38	16.36	0.5
	06	2437	16.33	16.36	0.5
	11	2462	16.34	16.37	0.5
IEEE 802.11n HT20	01	2412	17.56	17.31	0.5
	06	2437	17.57	17.55	0.5
	11	2462	17.57	17.35	0.5
IEEE 802.11n HT40	03	2422	36.36	36.36	0.5
	06	2437	36.30	36.37	0.5
	09	2452	36.34	36.34	0.5
IEEE 802.11ax HE20	01	2412	18.65	18.35	0.5
	06	2437	18.66	18.58	0.5
	11	2462	18.55	18.68	0.5
IEEE 802.11ax HE40	03	2422	37.96	38.00	0.5
	06	2437	37.99	37.99	0.5
	09	2452	37.99	38.00	0.5



ANT A

Modulation Type: 802.11b
CH01

Modulation Type: 802.11g
CH01

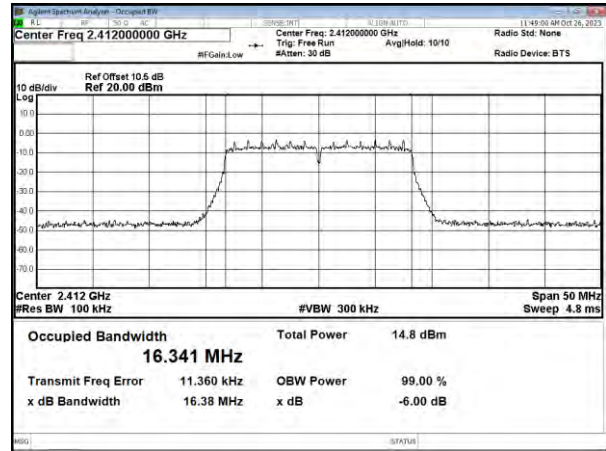
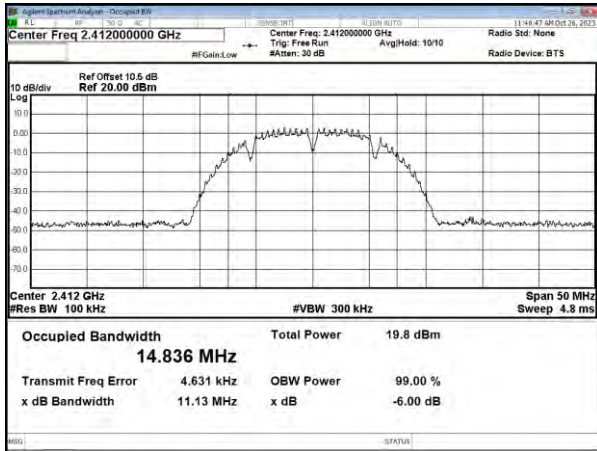

CH06

CH06

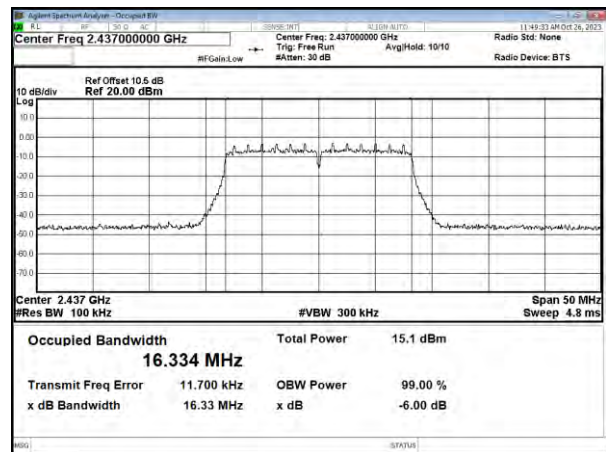
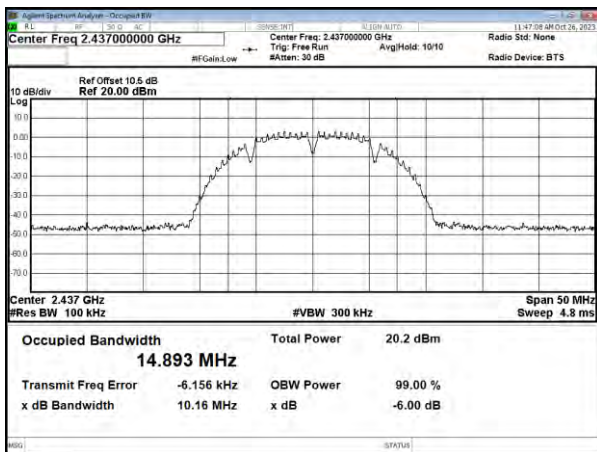

CH11

CH11

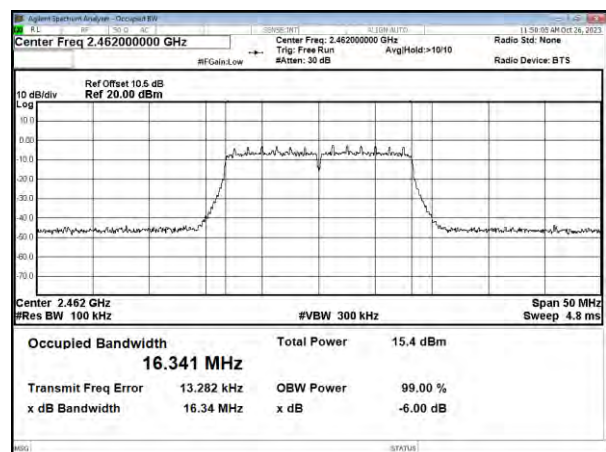
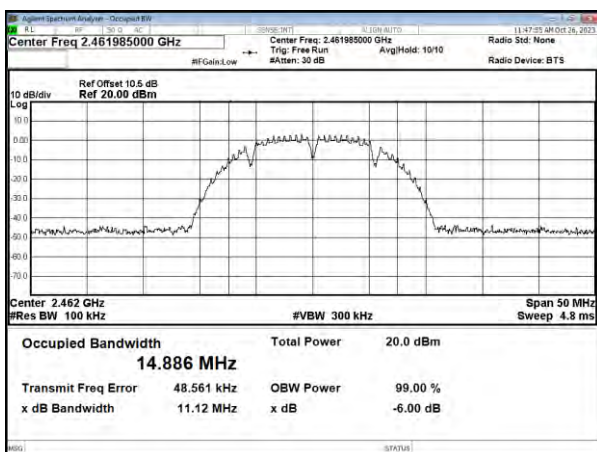



Modulation Type: IEEE 802.11n HT20
CH01

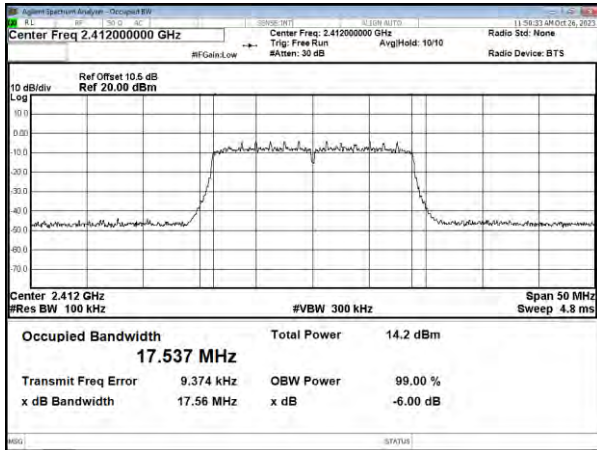

Modulation Type: IEEE 802.11n HT40
CH03

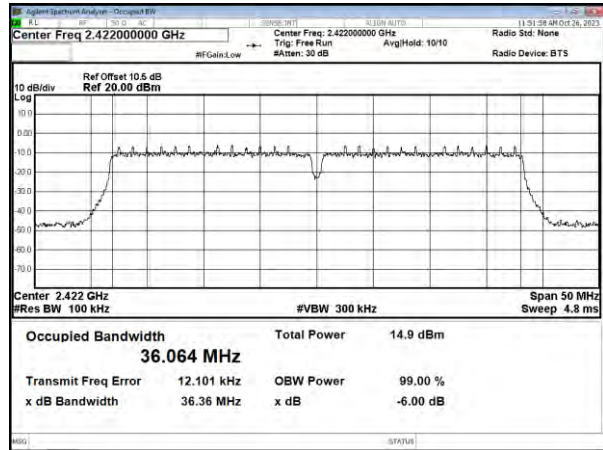

CH06

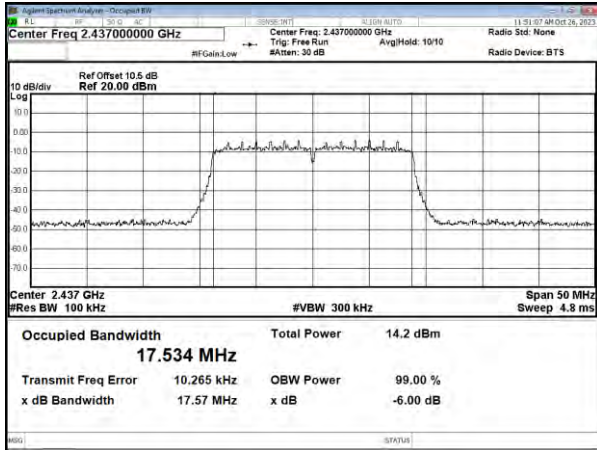

CH06

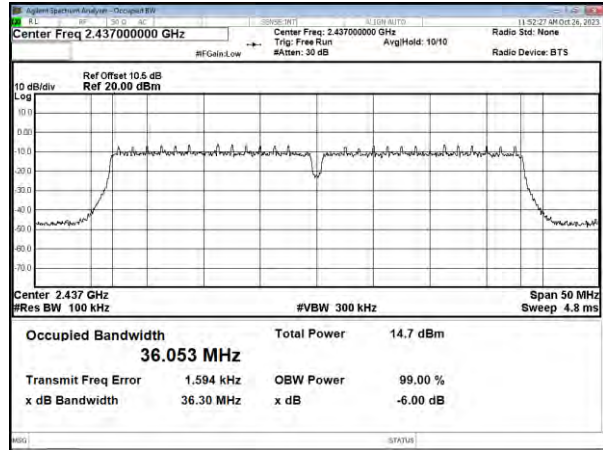

CH11

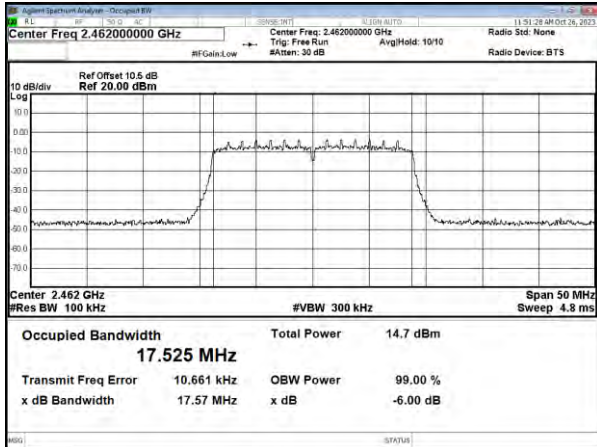

CH09

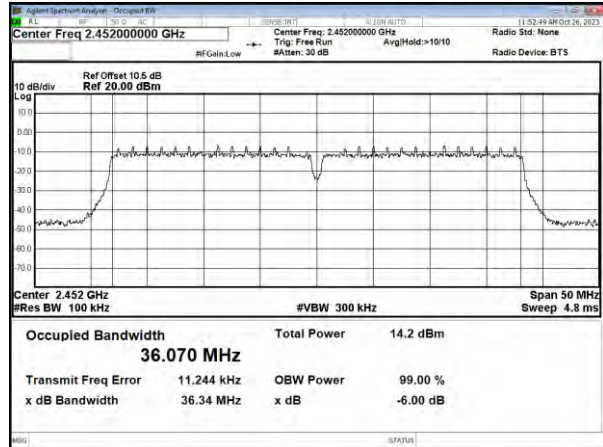



Modulation Type: IEEE 802.11ax HE20
CH01

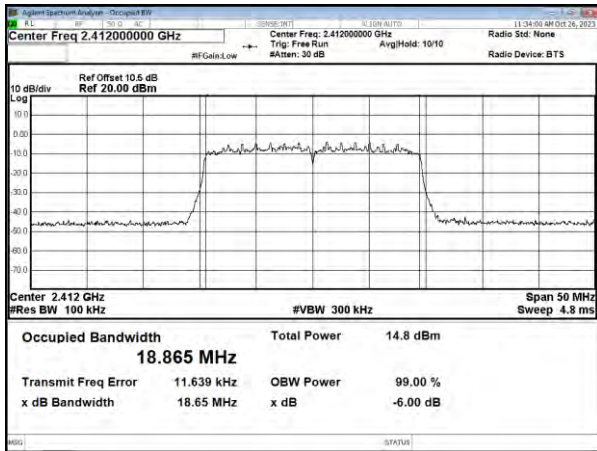

Modulation Type: IEEE 802.11ax HE40
CH03

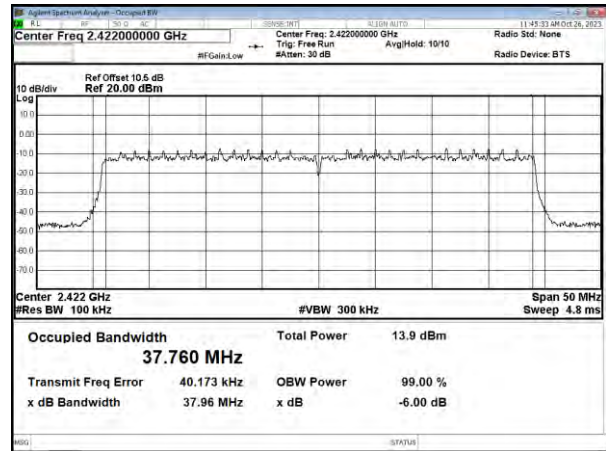

CH06

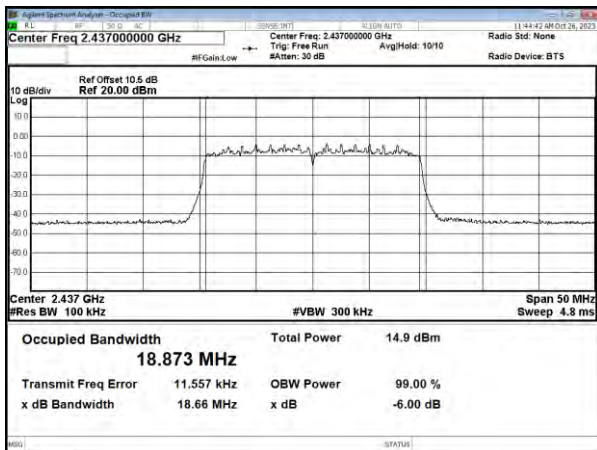

CH06

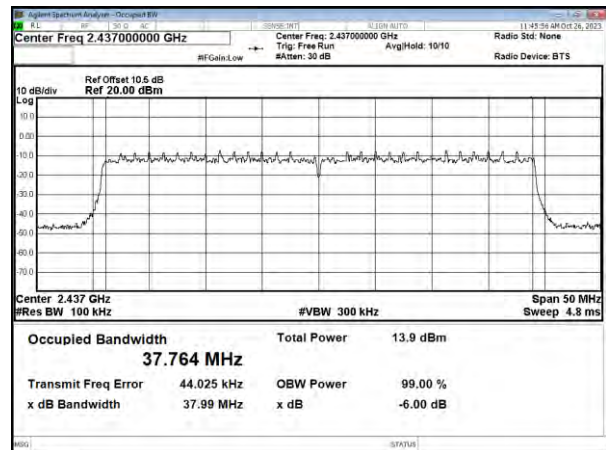

CH11

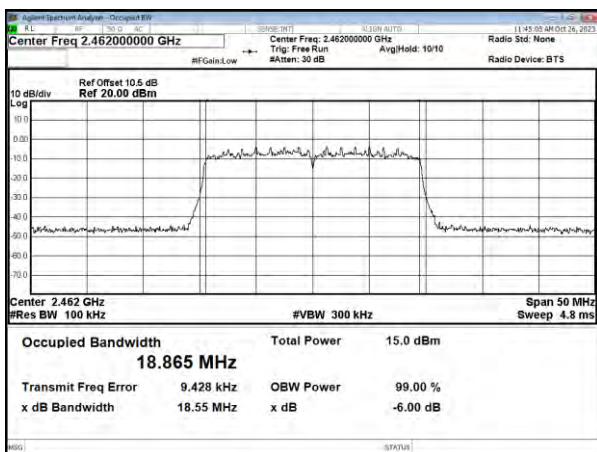

CH09

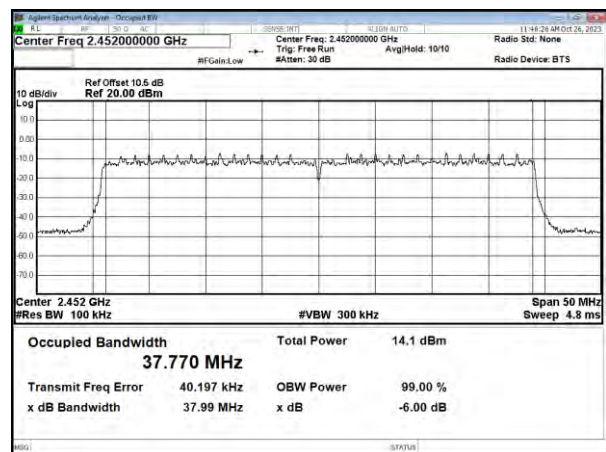



ANT B

Modulation Type: 802.11b
CH01

Modulation Type: 802.11g
CH01

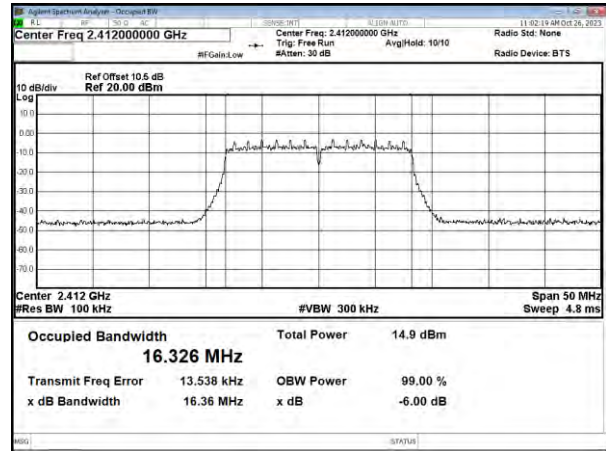
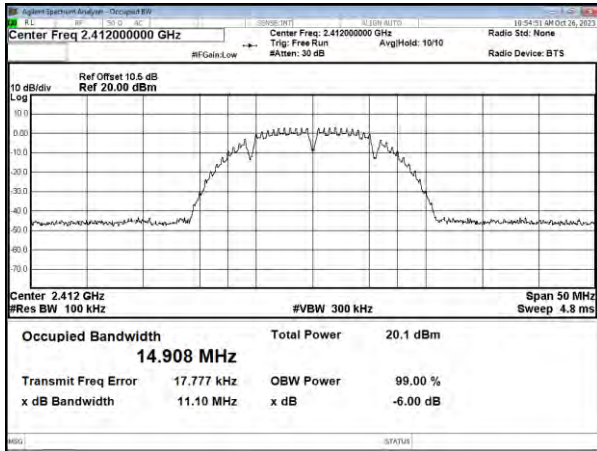

CH06

CH06

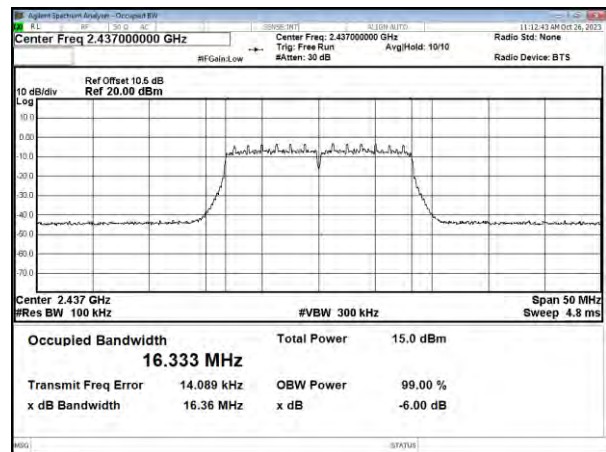
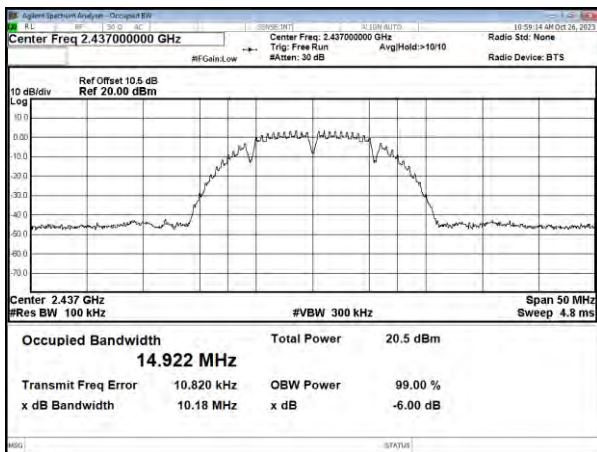

CH11

CH11

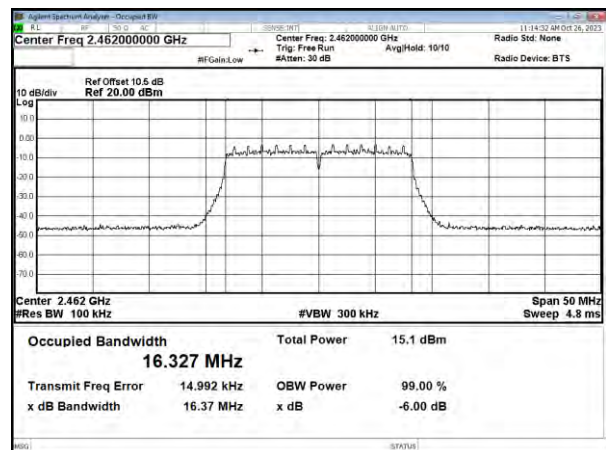
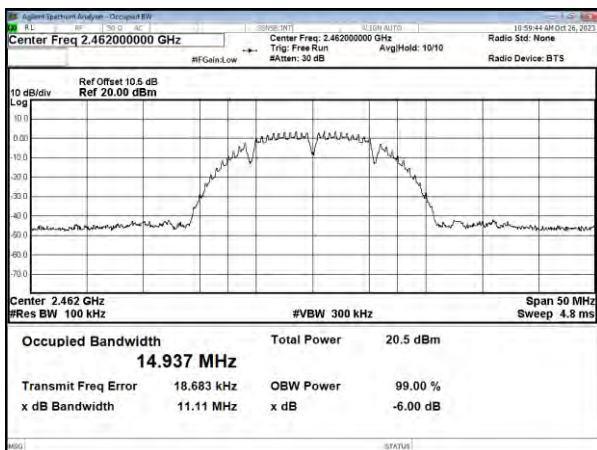



Modulation Type: IEEE 802.11n HT20
CH01

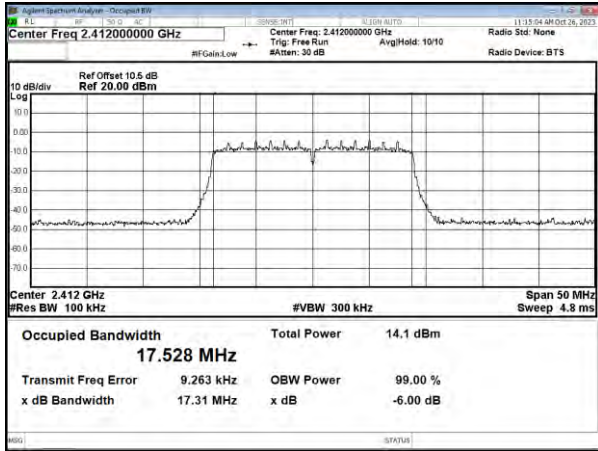

Modulation Type: IEEE 802.11n HT40
CH03

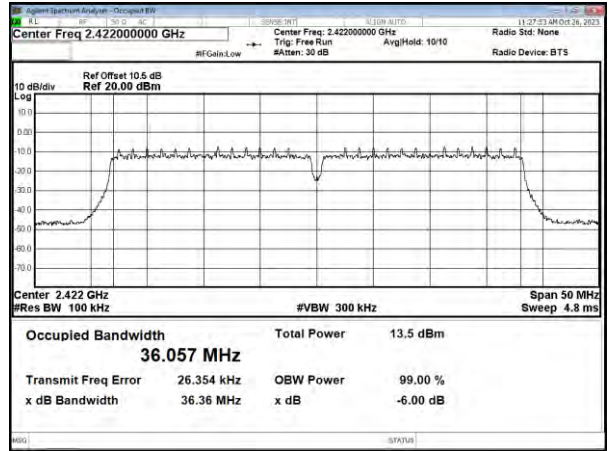

CH06

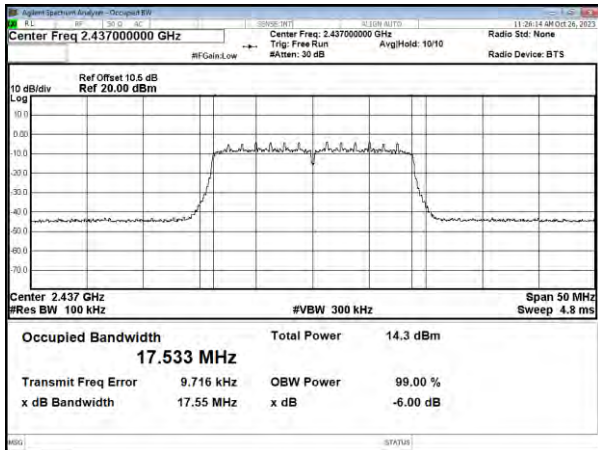

CH06

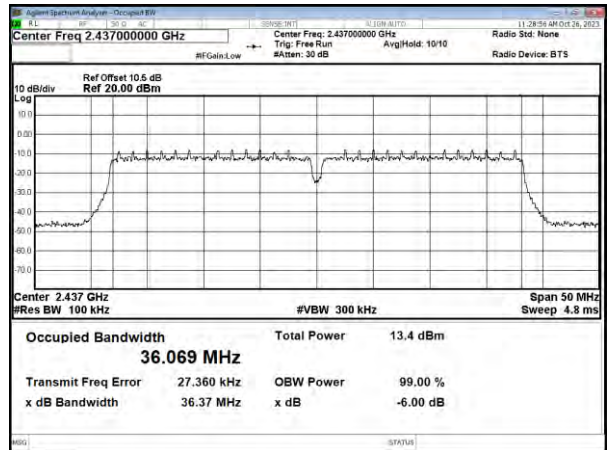

CH11

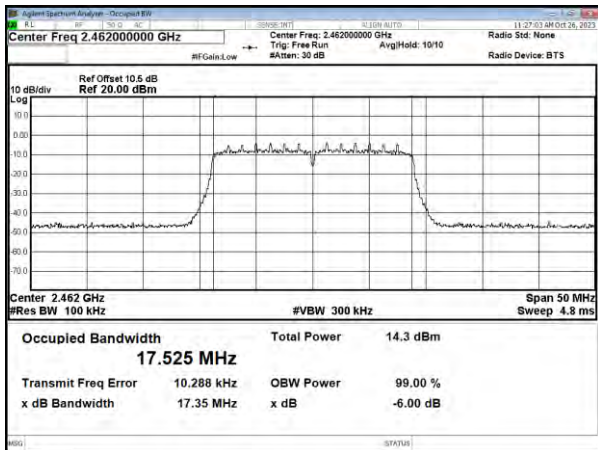

CH09

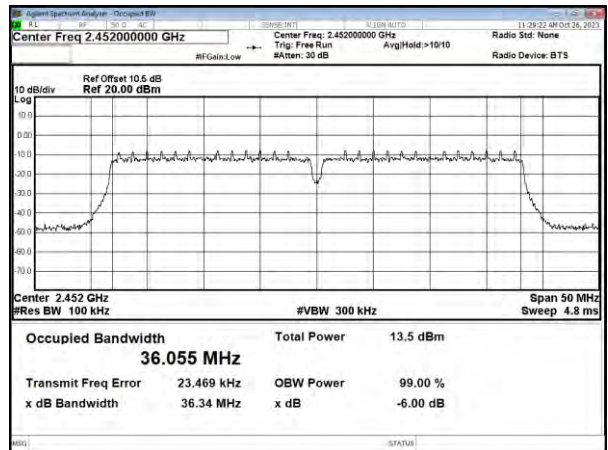



Modulation Type: IEEE 802.11ax HE20
CH01

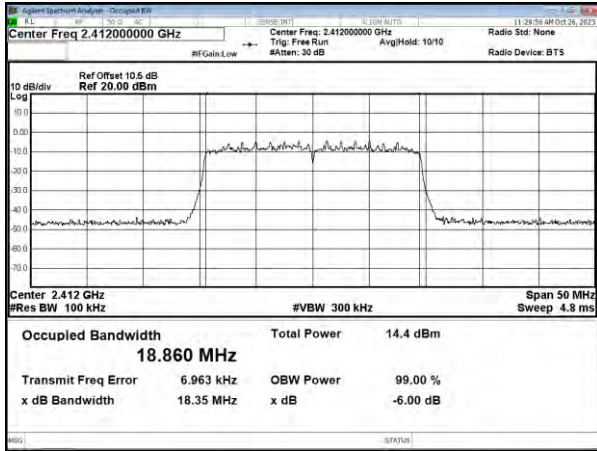

Modulation Type: IEEE 802.11ax HE40
CH03

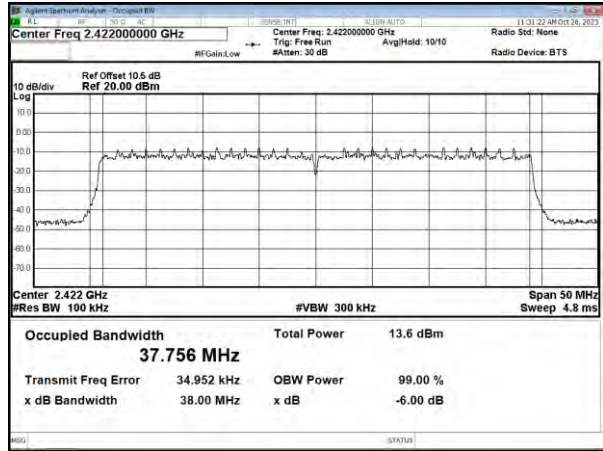

CH06

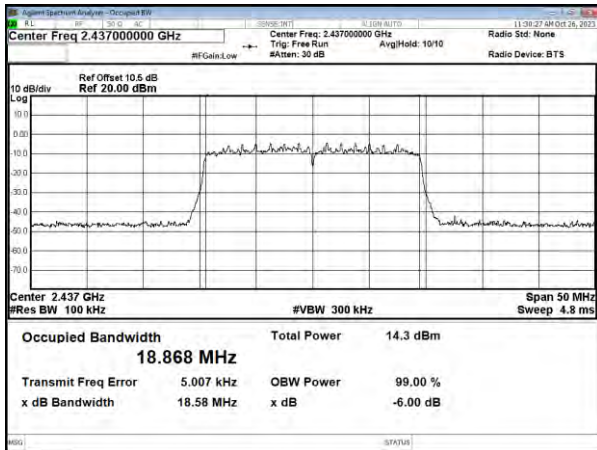

CH06

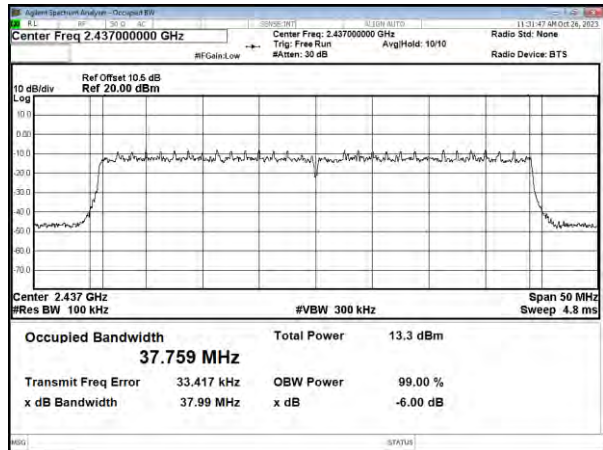

CH11

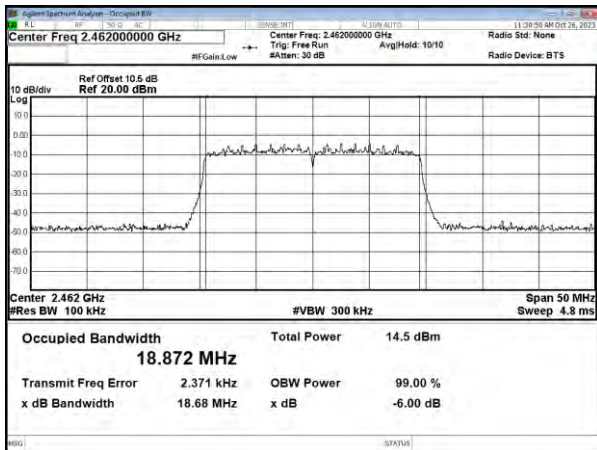

CH09

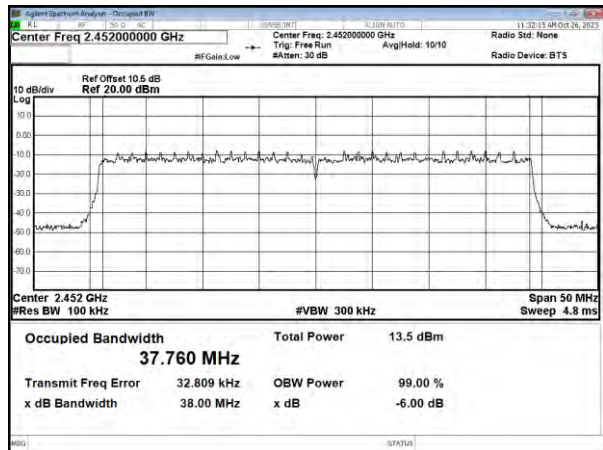



10. Maximum Peak Output Power

10.1 Test Limit

The Maximum Peak Output Power Measurement is 30dBm.

10.2 Test Procedures

The antenna port (RF output) of the EUT was connected to the input (RF input) of a power meter. Power was read directly from the meter and cable loss connection was added to the reading to obtain power at the EUT antenna terminal. The EUT Output Power was set to maximum to produce the worse case test result.

10.3 Test Setup Layout

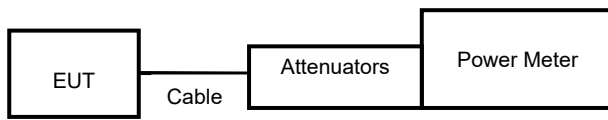

**10.4 Test Result and Data****MIMO**

Modulation Type	Channel	Frequency (MHz)	Conducted(peak) output power (dBm)		Total peak power (dBm)	Total peak power (mW)	Power Limit (dBm)
			ANT A	ANT B			
11b	1	2412	15.93	15.57	18.76	75.232	30.00
	6	2437	16.03	15.93	18.99	79.261	30.00
	11	2462	16.14	16.04	19.10	81.294	30.00
11g	1	2412	16.46	16.11	19.30	85.091	30.00
	6	2437	16.63	16.14	19.40	87.141	30.00
	11	2462	16.94	16.31	19.65	92.187	30.00
11n HT20	1	2412	15.66	14.90	18.31	67.716	30.00
	6	2437	15.71	14.77	18.28	67.231	30.00
	11	2462	15.89	15.07	18.51	70.952	30.00
11n HT40	3	2422	14.96	14.34	17.67	58.497	30.00
	6	2437	14.87	14.28	17.60	57.482	30.00
	9	2452	15.04	14.36	17.72	59.205	30.00
802.11ax HE20	1	2412	15.75	15.86	18.82	76.132	30.00
	6	2437	16.09	15.62	18.87	77.120	30.00
	11	2462	16.17	15.92	19.06	80.484	30.00
802.11ax HE40	3	2422	15.47	15.07	18.28	67.374	30.00
	6	2437	15.73	14.94	18.36	68.600	30.00
	9	2452	15.49	15.09	18.30	67.685	30.00



11. Power Spectral Density

11.1 Test Limit

The Maximum of Power Spectral Density Measurement is 8dBm.

If transmitting antennas of directional gain greater than 6 dBi are used, the power spectral density shall be reduced by the amount in dB that the directional gain of the antenna exceeds 6 dBi

11.2 Test Procedures

- a. The transmitter output was connected to spectrum analyzer.
- b. The spectrum analyzer's resolution bandwidth were set at 3kHz RBW and 10KHz VBW as that of the fundamental frequency. Set the sweep time=auto couple.
- c. The power spectral density was measured and recorded.

11.3 Test Setup Layout

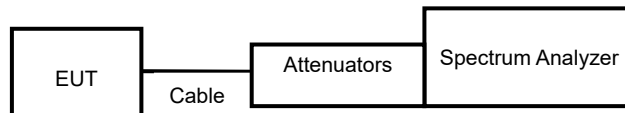

**11.4 Test Result and Data****MIMO**

Modulation Type	Channel	Frequency (MHz)	Maximum Power Density of 3KHz Bandwidth(dBm)		Sum chain (dBm)	Limit (dBm)
			ANT A	ANT B		
11b	1	2412	-12.543	-11.600	-9.04	6.80
	6	2437	-11.190	-11.880	-8.51	6.80
	11	2462	-11.831	-12.061	-8.93	6.80
11g	1	2412	-18.842	-19.605	-16.20	6.80
	6	2437	-19.443	-19.294	-16.36	6.80
	11	2462	-18.028	-19.621	-15.74	6.80
11n HT20	1	2412	-19.020	-20.250	-16.58	6.80
	6	2437	-19.393	-20.844	-17.05	6.80
	11	2462	-19.472	-19.981	-16.71	6.80
11n HT40	3	2422	-20.646	-22.770	-18.57	6.80
	6	2437	-20.626	-22.100	-18.29	6.80
	9	2452	-21.454	-21.367	-18.40	6.80
802.11ax HE20	1	2412	-19.628	-20.586	-17.07	6.80
	6	2437	-19.350	-19.964	-16.64	6.80
	11	2462	-19.067	-20.286	-16.62	6.80
802.11ax HE40	3	2422	-23.272	-23.173	-20.21	6.80
	6	2437	-23.339	-22.603	-19.95	6.80
	9	2452	-23.225	-23.525	-20.36	6.80



MIMO (ANT A)
Modulation Type: 802.11b
CH01

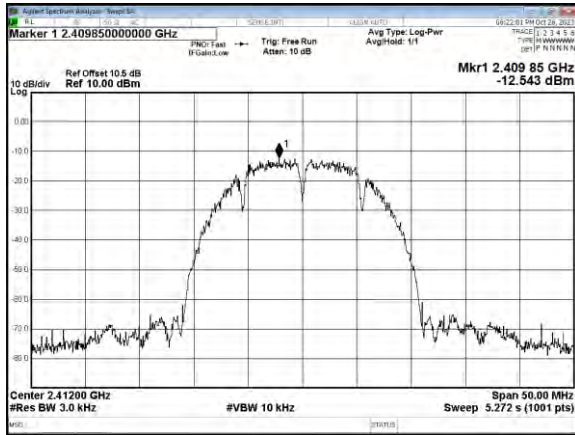

Modulation Type: 802.11g
CH01

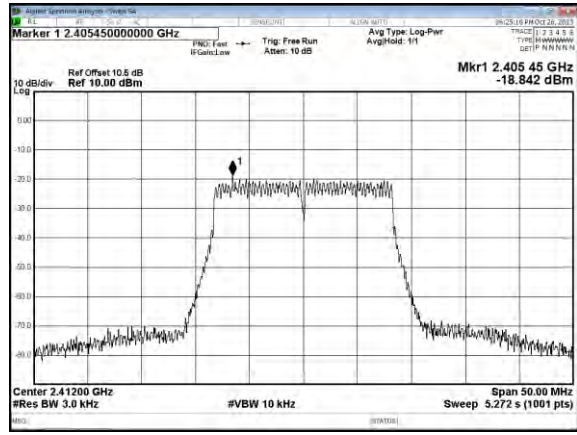

CH06

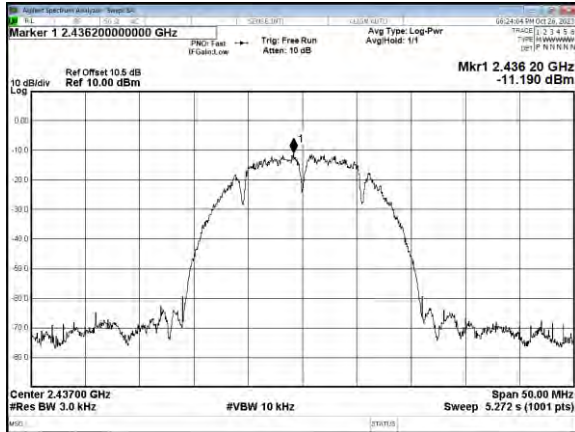

CH06

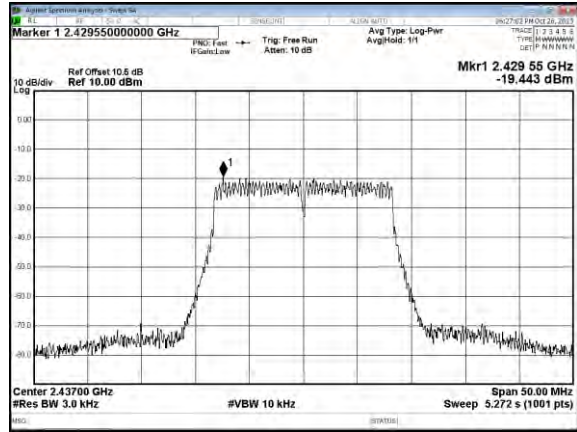

CH11

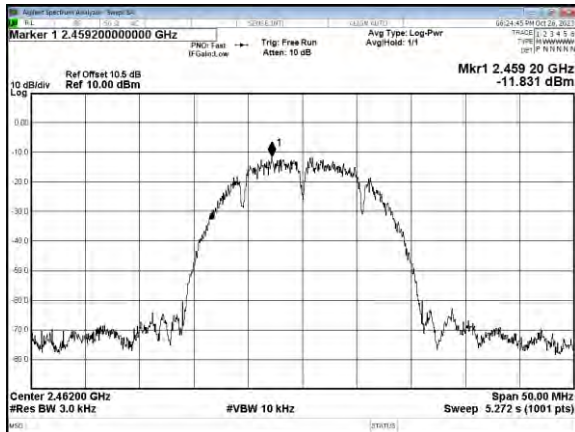

CH11

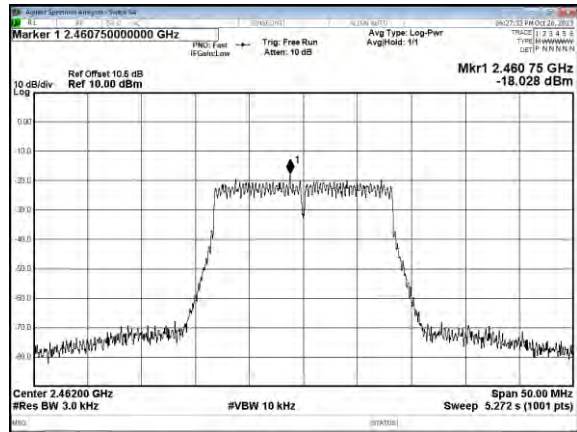



Modulation Type: 802.11n HT20
CH01

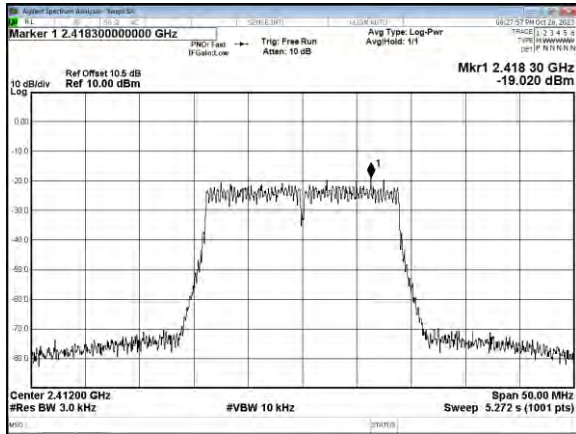

Modulation Type: 802.11n HT40
CH03

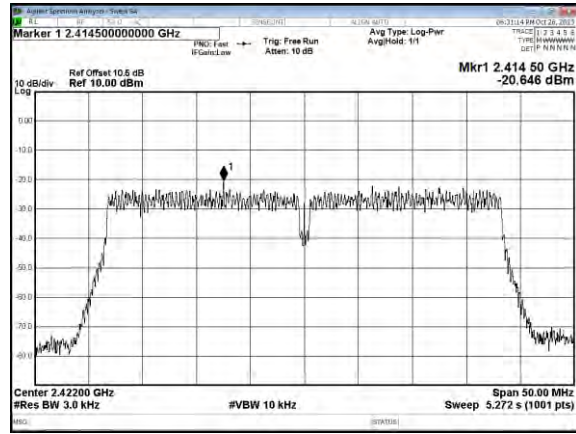

CH06

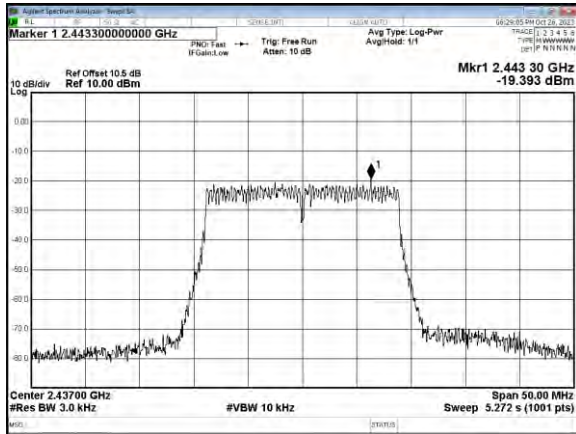

CH06

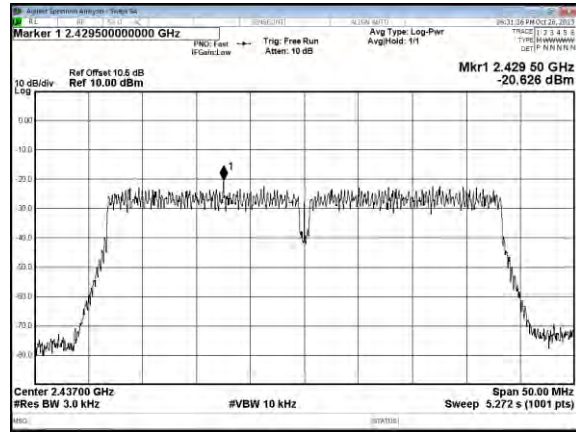

CH11

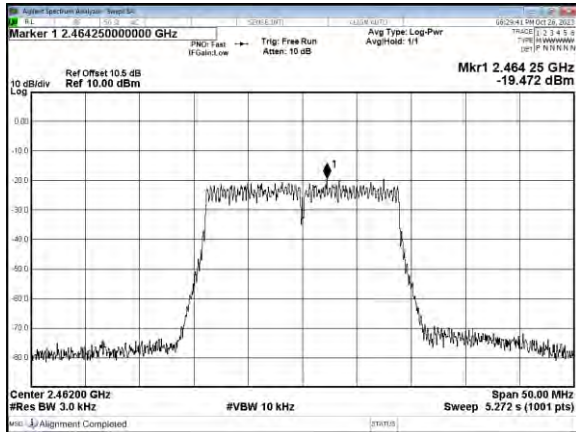

CH09

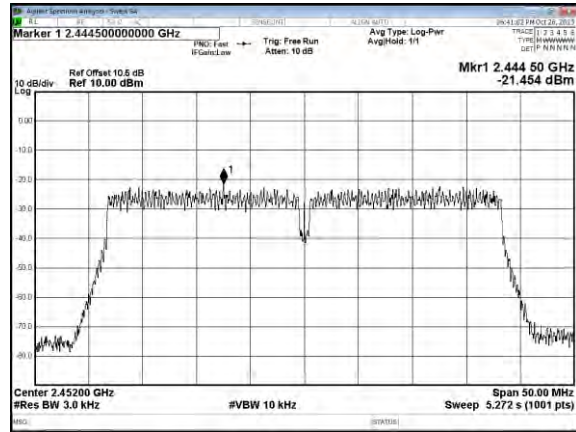



Modulation Type: 802.11ax HE20
CH01

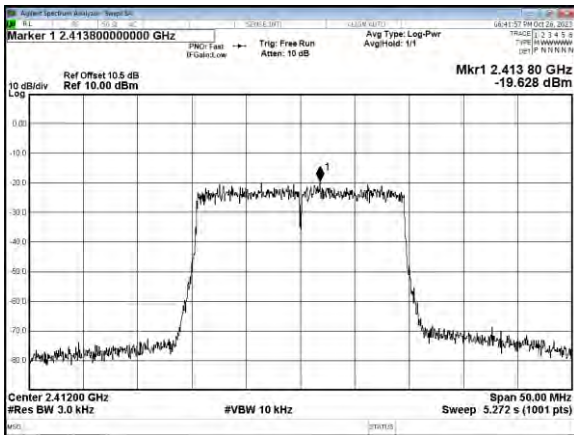

Modulation Type: 802.11ax HE40
CH03

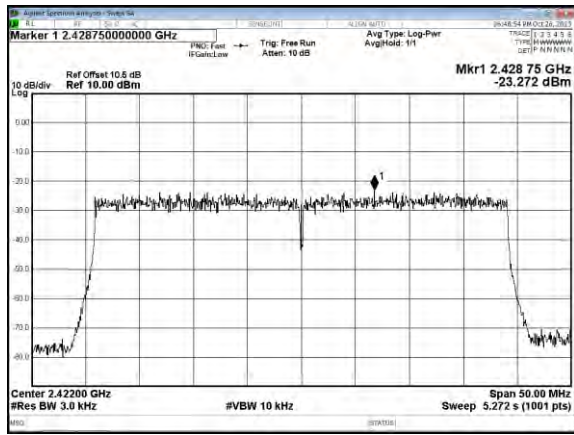

CH06

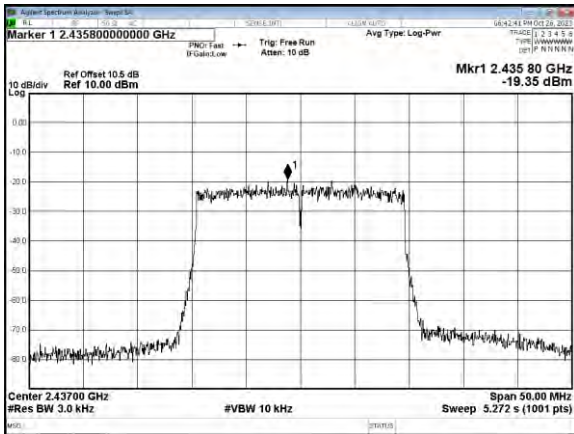

CH06

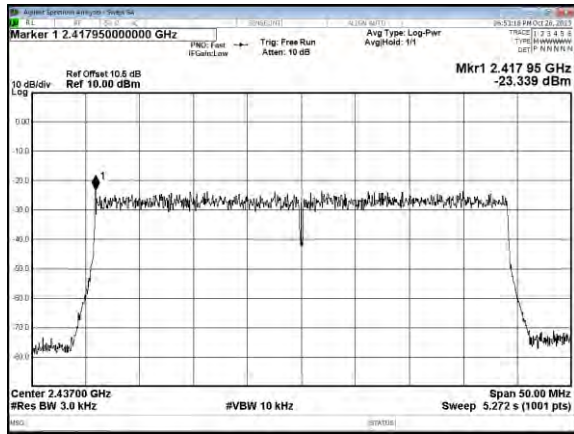

CH11

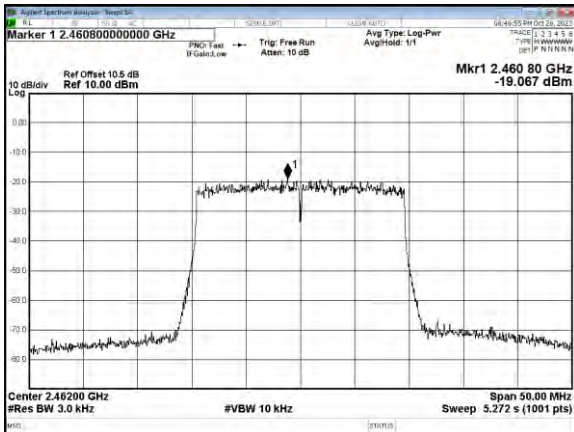

CH09

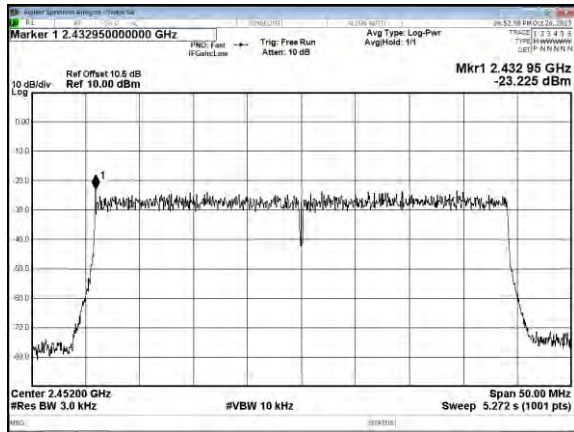



MIMO (ANT B)
Modulation Type: 802.11b
CH01

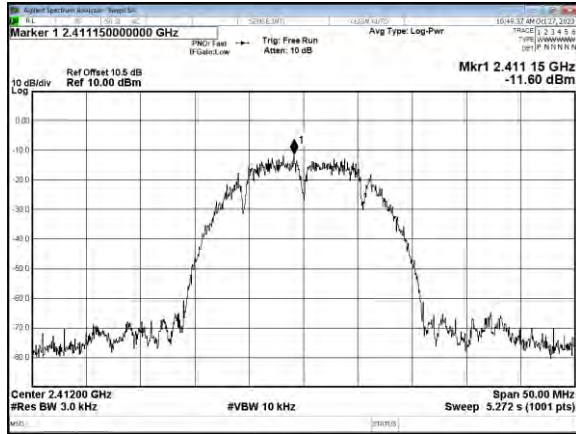

Modulation Type: 802.11g
CH01

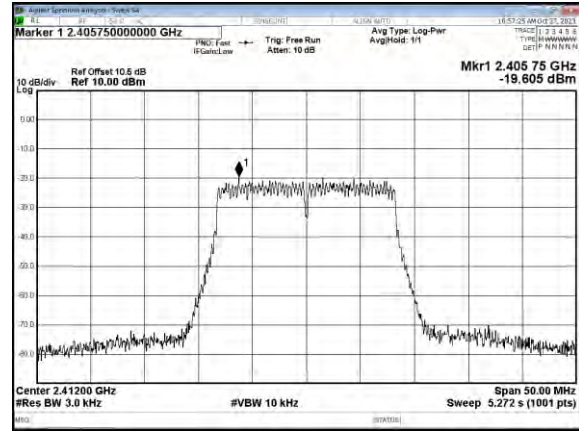

CH06



CH06

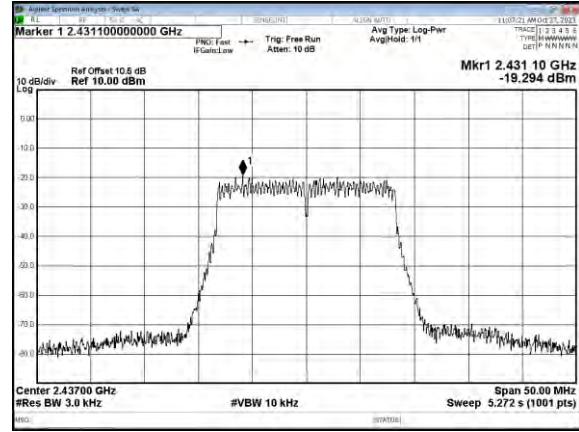

CH11

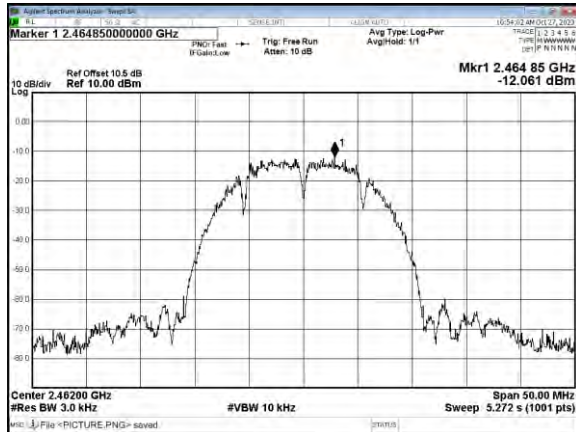

CH11

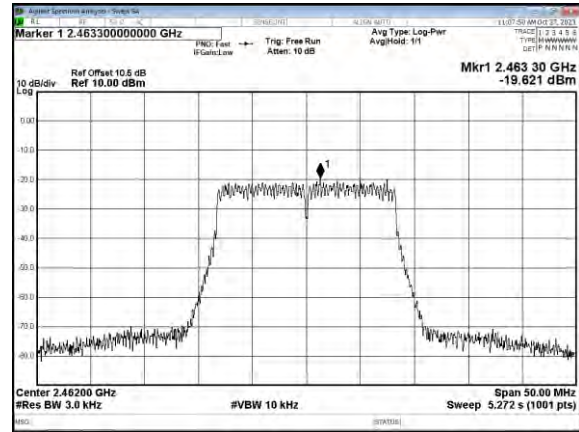



Modulation Type: 802.11n HT20
CH01

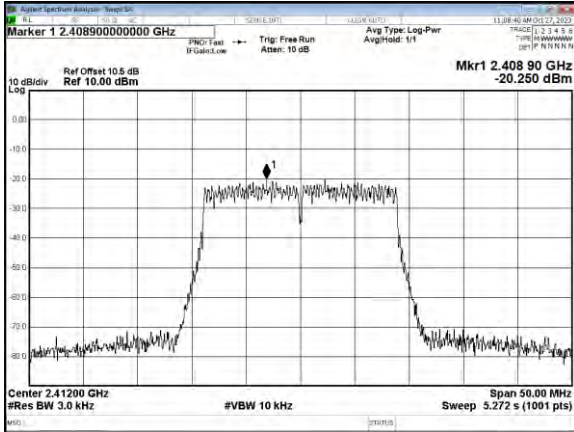

Modulation Type: 802.11n HT40
CH03

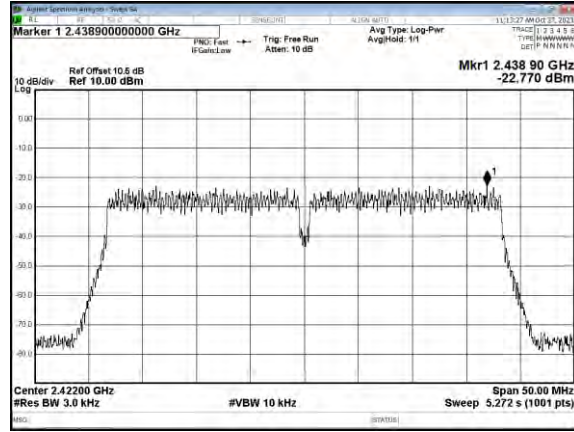

CH06

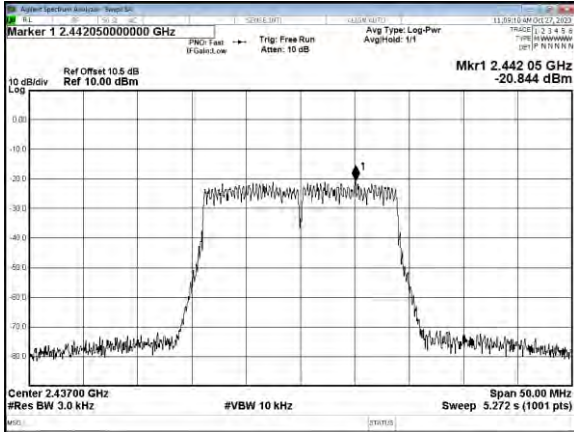

CH06

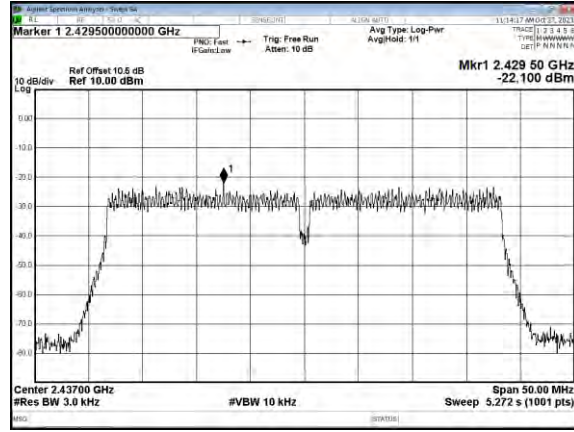

CH11

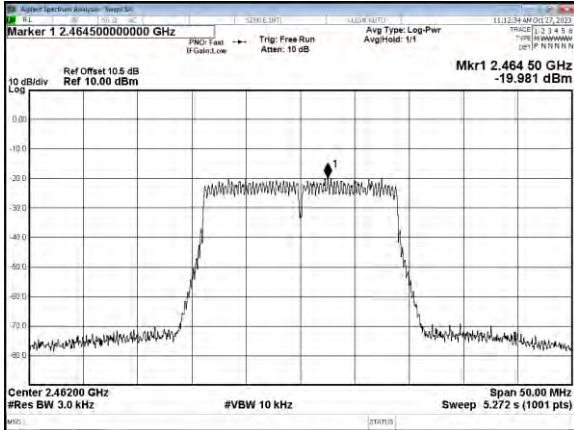

CH09

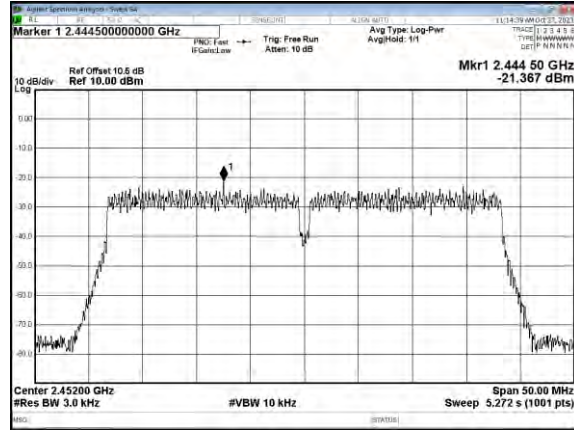



Modulation Type: 802.11ax HE20
CH01

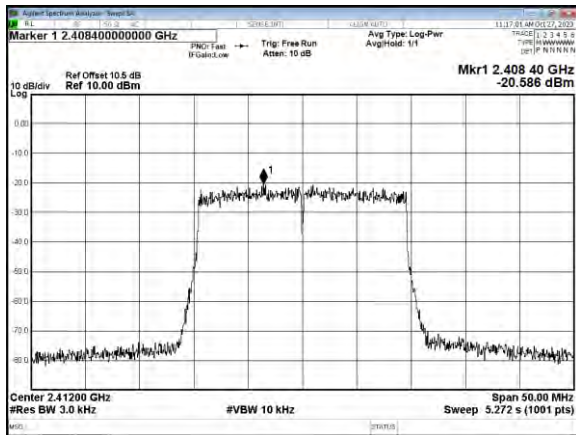

Modulation Type: 802.11ax HE40
CH03

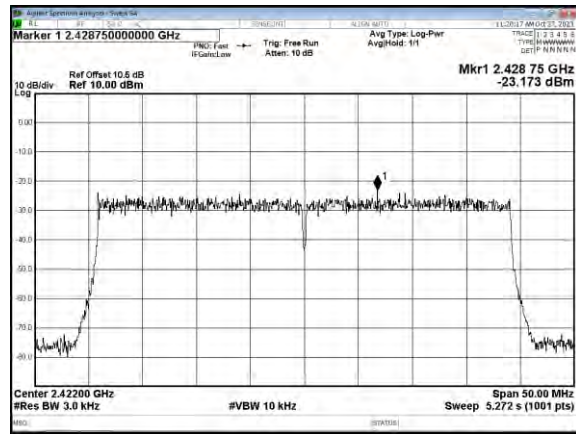

CH06

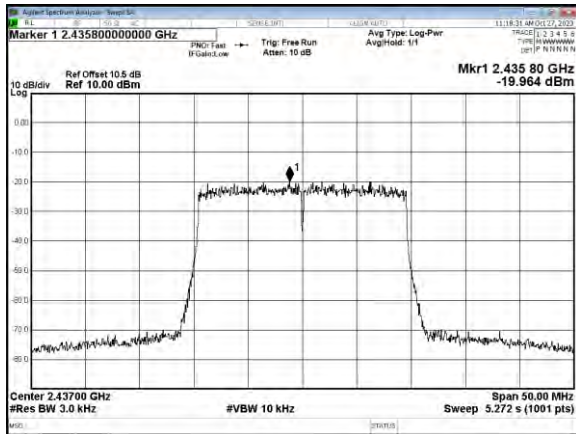

CH06

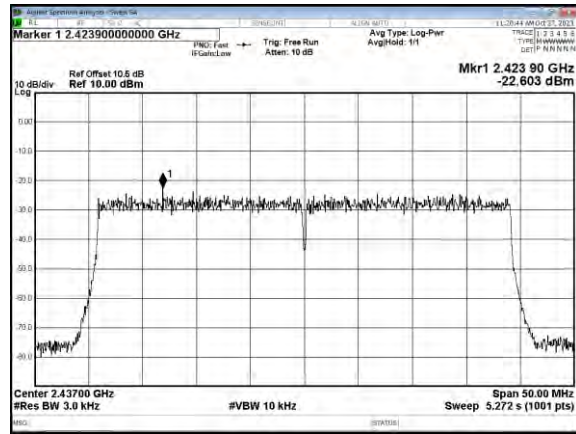

CH11

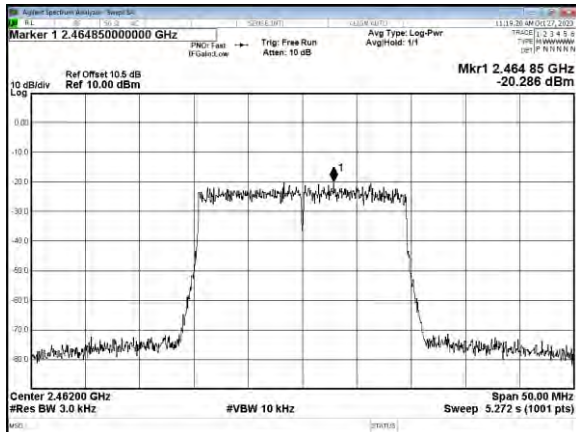

CH09

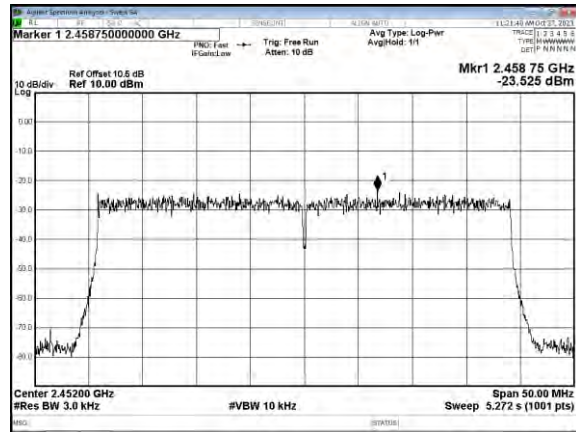

----- End of the report -----