

CFR 47 FCC PART 15 SUBPART E

TEST REPORT

For

Wireless module

MODEL NUMBER: AZ832-G

REPORT NUMBER: 4790969113-1-RF-4

ISSUE DATE: September 20, 2023

FCC ID: 2ACYT-AZ832-G

Prepared for

**SHENZHEN Hitevision Technology Co., Ltd.
Honghe Mansion No. 1 Building A, 1 Danzi North Road, Shatian, Kengzi Street,
Pingshan District, Shenzhen, China**

Prepared by

UL Verification Services (Guangzhou) Co., Ltd, Song Shan Lake Branch

Building 10, Innovation Technology Park, No. 1, Li Bin Road, Song Shan Lake Hi-Tech Development Zone Dongguan, 523808, People's Republic of China

Tel: +86 769 22038881

Fax: +86 769 33244054

Website: www.ul.com

U Revision History

<u>Rev.</u>	<u>Issue Date</u>	<u>Revisions</u>	<u>Revised By</u>
<u>V0</u>	<u>September 20, 2023</u>	<u>Initial Issue</u>	<u></u>

Summary of Test Results

Test Item	Clause	Limit/Requirement	Result
ON TIME AND DUTY CYCLE	ANSI C63.10-2013, Clause 12.2	None; for reporting purposes only.	Pass
6dB AND 26dB EMISSION BANDWIDTH AND 99% OCCUPIED BANDWIDTH	KDB 789033 D02 v02r01 Section C.1	FCC Part 15.407 (a)/(e),	Pass
CONDUCTED OUTPUT POWER	KDB 789033 D02 v02r01 Section E.3.a (Method PM)	FCC 15.407 (a)	Pass
POWER SPECTRAL DENSITY	KDB 789033 D02 v02r01 Section F	FCC 15.407 (a)	Pass
AC Power Line Conducted Emission	ANSI C63.10-2013, Clause 6.2.	FCC 15.207	Pass
Radiated Emissions and Band Edge Measurement	KDB 789033 D02 v02r01 Section G.3, G.4, G.5, and G.6	FCC 15.407 (b) FCC 15.209 FCC 15.205	Pass
FREQUENCY STABILITY	ANSI C63.10-2013, Clause 6.8	FCC 15.407 (g)	Pass
Dynamic Frequency Selection (Slave)	KDB 905462 D03 Client Without DFS New Rules v01r02	FCC Part 15.407 (h),	Pass
Dynamic Frequency Selection (Master)	KDB 905462 D02 UNII DFS Compliance Procedures New Rules v02	FCC Part 15.407 (h),	N/A
Antenna Requirement	N/A	FCC 47 CFR Part 15.203/ 15.407(a)(1) (2),	Pass

Note:

1. N/A: In this whole report not applicable.

*This test report is only published to and used by the applicant, and it is not for evidence purpose in China.

*The measurement result for the sample received is <Pass> according to <CFR 47 FCC PART 15 SUBPART E > when <Simple Acceptance> decision rule is applied.

CONTENTS

1. ATTESTATION OF TEST RESULTS.....	6
2. TEST METHODOLOGY.....	7
3. FACILITIES AND ACCREDITATION.....	7
4. CALIBRATION AND UNCERTAINTY	8
4.1. <i>MEASURING INSTRUMENT CALIBRATION</i>	<i>8</i>
4.2. <i>MEASUREMENT UNCERTAINTY.....</i>	<i>8</i>
5. EQUIPMENT UNDER TEST	9
5.1. <i>DESCRIPTION OF EUT</i>	<i>9</i>
5.2. <i>CHANNEL LIST</i>	<i>10</i>
5.3. <i>MAXIMUM POWER.....</i>	<i>11</i>
5.4. <i>TEST CHANNEL CONFIGURATION.....</i>	<i>12</i>
5.5. <i>THE WORSE CASE POWER SETTING PARAMETER.....</i>	<i>14</i>
5.6. <i>WORSE CASE CONFIGURATIONS.....</i>	<i>16</i>
5.7. <i>DESCRIPTION OF AVAILABLE ANTENNAS</i>	<i>17</i>
5.8. <i>SUPPORT UNITS FOR SYSTEM TEST</i>	<i>18</i>
6. MEASURING EQUIPMENT AND SOFTWARE USED.....	19
7. ANTENNA PORT TEST RESULTS	22
7.1. <i>ON TIME AND DUTY CYCLE.....</i>	<i>22</i>
7.2. <i>6DB AND 26DB EMISSION BANDWIDTH AND 99% OCCUPIED BANDWIDTH ...</i>	<i>23</i>
7.3. <i>CONDUCTED OUTPUT POWER.....</i>	<i>25</i>
7.4. <i>POWER SPECTRAL DENSITY</i>	<i>27</i>
7.5. <i>FREQUENCY STABILITY.....</i>	<i>29</i>
7.6. <i>DYNAMIC FREQUENCY SELECTION (SLAVE)</i>	<i>31</i>
8. RADIATED TEST RESULTS.....	35
8.1. <i>RESTRICTED BANDEDGE</i>	<i>43</i>
8.2. <i>SPURIOUS EMISSIONS(1 GHZ~7 GHZ)</i>	<i>124</i>
8.3. <i>SPURIOUS EMISSIONS(7 GHZ~18 GHZ)</i>	<i>150</i>
8.4. <i>SPURIOUS EMISSIONS(9 KHZ~30 MHZ)</i>	<i>292</i>
8.5. <i>SPURIOUS EMISSIONS(18 GHZ~26 GHZ)</i>	<i>295</i>
8.6. <i>SPURIOUS EMISSIONS(26 GHZ~40 GHZ)</i>	<i>297</i>
8.7. <i>SPURIOUS EMISSIONS(30 MHZ~1 GHZ).....</i>	<i>299</i>
9. AC POWER LINE CONDUCTED EMISSION	301
10. ANTENNA REQUIREMENT	304

11.	TEST DATA.....	305
11.1.	<i>APPENDIX A: EMISSION BANDWIDTH.....</i>	<i>305</i>
11.1.1.	Test Result.....	305
11.1.2.	Test Graphs	308
11.2.	<i>APPENDIX B: OCCUPIED CHANNEL BANDWIDTH.....</i>	<i>356</i>
11.2.1.	Test Result.....	356
11.2.2.	Test Graphs	359
11.3.	<i>APPENDIX C: MIN EMISSION BANDWIDTH</i>	<i>407</i>
11.3.1.	Test Result.....	407
11.3.2.	Test Graphs	409
11.4.	<i>APPENDIX D: MAXIMUM CONDUCTED OUTPUT POWER.....</i>	<i>424</i>
11.4.1.	Test Result.....	424
11.4.1.	Test Graphs	428
11.5.	<i>APPENDIX E: MAXIMUM POWER SPECTRAL DENSITY</i>	<i>438</i>
11.5.1.	Test Result.....	438
11.5.2.	Test Graphs	442
11.6.	<i>APPENDIX F: FREQUENCY STABILITY.....</i>	<i>494</i>
11.6.1.	Test Result.....	494
11.7.	<i>APPENDIX G: DUTY CYCLE.....</i>	<i>495</i>
11.7.1.	Test Result.....	495
11.7.2.	Test Graphs	496
11.8.	<i>APPENDIX H: DFS DETECTION THRESHOLDS.....</i>	<i>499</i>
11.8.1.	Test Result.....	499
11.8.2.	Test Graphs	500
11.9.	<i>APPENDIX I: CHANNEL MOVE TIME AND CHANNEL CLOSING TRANSMISSION TIME</i>	<i>501</i>
11.9.1.	Test Result.....	501
11.9.2.	Test Graphs	502
11.10.	<i>APPENDIX J: NON-OCCUPANCY PERIOD.....</i>	<i>503</i>
11.10.1.	Test Graphs	504

1. ATTESTATION OF TEST RESULTS

Applicant Information

Company Name: SHENZHEN Hitevision Technology Co., Ltd.
 Address: Honghe Mansion No. 1 Building A, 1 Danzi North Road, Shatian, Kengzi Street, Pingshan District, Shenzhen, China

Manufacturer Information

Company Name: SHENZHEN Hitevision Technology Co., Ltd.
 Address: Honghe Mansion No. 1 Building A, 1 Danzi North Road, Shatian, Kengzi Street, Pingshan District, Shenzhen, China

EUT Information

EUT Name: Wireless module
 Model: AZ832-G
 Brand: GSD
 Sample Received Date: August 16, 2023
 Sample Status: Normal
 Sample ID: 6365168
 Date of Tested: August 29, 2023 to September 20, 2023

APPLICABLE STANDARDS	
STANDARD	TEST RESULTS
CFR 47 FCC PART 15 SUBPART E	Pass

Prepared By:



Fanny Huang
 Engineer Project Associate

Checked By:

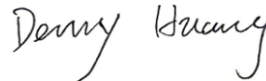

Denny Huang
 Senior Project Engineer

Approved By:



Stephen Guo
 Operations Manager

2. TEST METHODOLOGY

All tests were performed in accordance with the standard CFR 47 FCC PART 15 SUBPART E , ANSI C63.10-2013, CFR 47 FCC Part 2, KDB 789033 D02 v02r01, KDB414788 D01 Radiated Test Site v01, KDB 662911 D01 Multiple Transmitter Output v02r01, KDB 905462 D02 UNII DFS Compliance Procedures New Rules v02, KDB 905462 D03 UNII clients without radar detection New Rules v01r02, KDB 905462 D04 Operational Modes for DFS Testing New Rules v01, KDB 905462 D06 802 11 Channel Plans New Rules v02 and KDB 905462 D02 UNII DFS Compliance Procedures New Rules v02.

3. FACILITIES AND ACCREDITATION

Accreditation Certificate	<p>A2LA (Certificate No.: 4102.01) UL Verification Services (Guangzhou) Co., Ltd. Song Shan Lake Branch. has been assessed and proved to be in compliance with A2LA.</p> <p>FCC (FCC Designation No.: CN1187) UL Verification Services (Guangzhou) Co., Ltd. Song Shan Lake Branch. Has been recognized to perform compliance testing on equipment subject to the Commission's Declaration of Conformity (DoC) and Certification rules</p> <p>ISED (Company No.: 21320) UL Verification Services (Guangzhou) Co., Ltd. Song Shan Lake Branch. has been registered and fully described in a report filed with ISED. The Company Number is 21320 and the test lab Conformity Assessment Body Identifier (CABID) is CN0046.</p> <p>VCCI (Registration No.: G-20019, R-20004, C-20012 and T-20011) UL Verification Services (Guangzhou) Co., Ltd. Song Shan Lake Branch. has been assessed and proved to be in compliance with VCCI, the Membership No. is 3793. Facility Name: Chamber D, the VCCI registration No. is G-20019 and R-20004 Shielding Room B , the VCCI registration No. is C-20012 and T-20011</p>
---------------------------	--

Note 1:

All tests measurement facilities use to collect the measurement data are located at Building 10, Innovation Technology Park, No. 1, Li Bin Road, Song Shan Lake Hi-Tech Development Zone Dongguan, 523808, People's Republic of China.

Note 2:

The test anechoic chamber in UL Verification Services (Guangzhou) Co., Ltd. Song Shan Lake Branch had been calibrated and compared to the open field sites and the test anechoic chamber is shown to be equivalent to or worst case from the open field site.

Note 3:

For below 30 MHz, lab had performed measurements at test anechoic chamber and comparing to measurements obtained on an open field site. And these measurements below 30 MHz had been correlated to measurements performed on an OFS.

4. CALIBRATION AND UNCERTAINTY

4.1. MEASURING INSTRUMENT CALIBRATION

The measuring equipment utilized to perform the tests documented in this report has been calibrated in accordance with the manufacturer's recommendations and is traceable to recognized national standards.

4.2. MEASUREMENT UNCERTAINTY

Where relevant, the following measurement uncertainty levels have been estimated for tests performed on the apparatus:

Test Item	Uncertainty
Conduction emission	3.62 dB
Radiated Emission (Included Fundamental Emission) (9 kHz ~ 30 MHz)	2.2 dB
Radiated Emission (Included Fundamental Emission) (30 MHz ~ 1 GHz)	4.00 dB
Radiated Emission (Included Fundamental Emission) (1 GHz to 40 GHz)	5.78 dB (1 GHz ~ 18 GHz)
	5.23 dB (18 GHz ~ 26 GHz)
	5.37 dB (26 GHz ~ 40 GHz)
Duty Cycle	±0.028%
Emission Bandwidth and 99% Occupied Bandwidth	±0.0196%
Maximum Conducted Output Power	±0.766 dB
Maximum Power Spectral Density Level	±1.22 dB
Frequency Stability	±2.76%
Conducted Band-edge Compliance	±1.328 dB
Conducted Unwanted Emissions In Non-restricted Frequency Bands	±0.746 dB (9 kHz ~ 1 GHz)
	±1.328dB (1 GHz ~ 26 GHz)
Note: This uncertainty represents an expanded uncertainty expressed at approximately the 95% confidence level using a coverage factor of k=2.	

5. EQUIPMENT UNDER TEST

5.1. DESCRIPTION OF EUT

EUT Name	Wireless module
Model	AZ832-G
Frequency Range:	5180 MHz to 5240 MHz 5260 MHz to 5320 MHz 5500 MHz to 5720 MHz 5745 MHz to 5825 MHz
TPC Function:	Not Support
DFS Operational mode:	Slave without radar detection
Type of Modulation:	IEEE 802.11a: OFDM(64QAM, 16QAM, QPSK, BPSK) IEEE 802.11n: OFDM(64QAM, 16QAM, QPSK, BPSK) IEEE 802.11ac: OFDM(256QAM, 64QAM, 16QAM, QPSK, BPSK) IEEE 802.11ax: OFDM(1024QAM, 256QAM, 64QAM, 16QAM, QPSK, BPSK)
Radio Technology	IEEE 802.11a20 IEEE 802.11n HT20/HT40 IEEE 802.11ac VHT20/VHT40/VHT80 IEEE 802.11ax HE20/HE40/HE80
Normal Test Voltage:	DC 12 V
Wireless module	RTL8852BU

5.2. CHANNEL LIST

UNII-1 (For Bandwidth=20MHz)		UNII-1 (For Bandwidth=40MHz)		UNII-1 (For Bandwidth=80MHz)	
Channel	Frequency (MHz)	Channel	Frequency (MHz)	Channel	Frequency (MHz)
36	5180	38	5190	42	5210
40	5200	46	5230		
44	5220				
48	5240				

UNII-2A (For Bandwidth=20MHz)		UNII-2A (For Bandwidth=40MHz)		UNII-2A (For Bandwidth=80MHz)	
Channel	Frequency (MHz)	Channel	Frequency (MHz)	Channel	Frequency (MHz)
52	5260	54	5270	58	5290
56	5280	62	5310		
60	5300				
64	5320				

UNII-2C (For Bandwidth=20MHz)		UNII-2C (For Bandwidth=40MHz)		UNII-2C (For Bandwidth=80MHz)	
Channel	Frequency (MHz)	Channel	Frequency (MHz)	Channel	Frequency (MHz)
100	5500	102	5510	106	5530
104	5520	110	5550	122	5610
108	5540	118	5590	/	/
112	5560	126	5630		
116	5580	134	5670		
120	5600	/	/		
124	5620				
128	5640				
132	5660				
136	5680				
140	5700				
/	/				

UNII-3 (For Bandwidth=20MHz)		UNII-3 (For Bandwidth=40MHz)		UNII-3 (For Bandwidth=80MHz)	
Channel	Frequency (MHz)	Channel	Frequency (MHz)	Channel	Frequency (MHz)
149	5745	151	5755	155	5775
153	5765	159	5795		
157	5785				
161	5805				
165	5825				

Straddle Test Channel Configuration	
Test Channel Number	Frequency
CH 142	5710 MHz
CH 144	5720 MHz
CH 138	5690 MHz

5.3. MAXIMUM POWER

IEEE Std. 802.11	Frequency (MHz)	Maximum Average Conducted Power (dBm)
a	5180 ~ 5825	16.08
n HT20		18.89
n HT40		18.50
ac VHT80		16.70
ax HE20		14.86
ax HE40		14.35
ax HE80		14.68

5.4. TEST CHANNEL CONFIGURATION

UNII-1 Test Channel Configuration		
IEEE Std.	Test Channel Number	Frequency
802.11a	CH 36(Low Channel), CH 40(MID Channel), CH 48(High Channel)	5180 MHz, 5200 MHz, 5240 MHz
802.11n HT20	CH 36(Low Channel), CH 40(MID Channel), CH 48(High Channel)	5180 MHz, 5200 MHz, 5240 MHz
802.11n HT40	CH 38(Low Channel), CH 46(High Channel)	5190 MHz, 5230 MHz
802.11ac VHT80	CH 42(Low Channel)	5210 MHz
802.11ax HE20	CH 36(Low Channel), CH 40(MID Channel), CH 48(High Channel)	5180 MHz, 5200 MHz, 5240 MHz
802.11ax HE40	CH 38(Low Channel), CH 46(High Channel)	5190 MHz, 5230 MHz
802.11ax HE80	CH 42(Low Channel)	5210 MHz

UNII-2A Test Channel Configuration		
IEEE Std.	Test Channel Number	Frequency
802.11a	CH 52(Low Channel), CH 56(MID Channel), CH 64(High Channel)	5260 MHz, 5280 MHz, 5320 MHz
802.11n HT20	CH 52(Low Channel), CH 56(MID Channel), CH 64(High Channel)	5260 MHz, 5280 MHz, 5320 MHz
802.11n HT40	CH 54(Low Channel), CH 62(High Channel)	5270 MHz, 5310 MHz
802.11ac VHT80	CH 58(Low Channel)	5290 MHz
802.11ax HE20	CH 52(Low Channel), CH 56(MID Channel), CH 64(High Channel)	5260 MHz, 5280 MHz, 5320 MHz
802.11ax HE40	CH 54(Low Channel), CH 62(High Channel)	5270 MHz, 5310 MHz
802.11ax HE80	CH 58(Low Channel)	5290 MHz

UNII-2C Test Channel Configuration		
IEEE Std.	Test Channel Number	Frequency
802.11a	CH 100(Low Channel), CH 116(MID Channel), CH 140(High Channel)	5500 MHz, 5580 MHz, 5700 MHz
802.11n HT20	CH 100(Low Channel), CH 116(MID Channel), CH 140(High Channel)	5500 MHz, 5580 MHz, 5700 MHz
802.11n HT40	CH 102(Low Channel), CH 110(MID Channel), CH 134(High Channel)	5510 MHz, 5550 MHz, 5670 MHz
802.11ac VHT80	CH 102(Low Channel), CH 122(High Channel)	5530 MHz, 5610 MHz
802.11ax HE20	CH 100(Low Channel), CH 116(MID Channel), CH 140(High Channel)	5500 MHz, 5580 MHz, 5700 MHz
802.11ax HE40	CH 102(Low Channel), CH 110(MID Channel), CH 134(High Channel)	5510 MHz, 5550 MHz, 5670 MHz
802.11ax HE80	CH 102(Low Channel), CH 122(High Channel)	5530 MHz, 5610 MHz

UNII-3 Test Channel Configuration

IEEE Std.	Test Channel Number	Frequency
802.11a	CH 149(Low Channel), CH 157(MID Channel), CH 165(High Channel)	5745 MHz, 5785 MHz, 5825 MHz
802.11n HT20	CH 149(Low Channel), CH 157(MID Channel), CH 165(High Channel)	5745 MHz, 5785 MHz, 5825 MHz
802.11n HT40	CH 151(Low Channel), CH 159(High Channel)	5755MHz, 5795MHz
802.11ac VHT80	CH 155(Low Channel)	5775 MHz
802.11ax HE20	CH 149(Low Channel), CH 157(MID Channel), CH 165(High Channel)	5745 MHz, 5785 MHz, 5825 MHz
802.11ax HE40	CH 151(Low Channel), CH 159(High Channel)	5755MHz, 5795MHz
802.11ax HE80	CH 155(Low Channel)	5775 MHz

Straddle Test Channel Configuration

IEEE Std.	Test Channel Number	Frequency
802.11a	CH 144	5720 MHz
802.11n HT20	CH 144	5720 MHz
802.11n HT40	CH 142	5710 MHz
802.11ac VHT80	CH 138	5690 MHz
802.11ax HE20	CH 144	5720 MHz
802.11ax HE40	CH 142	5710 MHz
802.11ax HE80	CH 138	5690 MHz

5.5. THE WORSE CASE POWER SETTING PARAMETER

The Worst Case Power Setting Parameter			
Test Software	RTL8852BU		
Mode	Freq(MHz)	Tx power from software (dBm)	
		ANT1	ANT3
802.11a	5180	16	16
	5200	16	16
	5240	16	16
	5260	16	16
	5280	16	16
	5320	16	16
	5500	16	15
	5580	14	14
	5700	14	14
	5720-2C	14	14
	5720-3	14	14
	5745	16	15
	5785	16	15
	5825	16	15
802.11n 20M	5180	16	
	5200	16	
	5240	16	
	5260	16	
	5280	16	
	5320	16	
	5500	15	
	5580	15	
	5700	14	
	5720-2C	15	
	5720-3	15	
	5745	15	
	5785	15	
	5825	15	
802.11n 40M	5190	15	
	5230	15	
	5270	15	
	5310	15	
	5510	14	
	5550	15	
	5670	15	
	5710-2C	15	

	5710-3	15
	5755	15
	5795	15
802.11ac 80M	5210	14
	5290	14
	5530	13
	5610	13
	5690-2C	13
	5690-3	13
	5775	13
802.11ax 20M	5180	12
	5200	12
	5240	12
	5260	12
	5280	12
	5320	13
	5500	12
	5580	11
	5700	12
	5720-2C	12
	5720-3	12
	5745	12
	5785	12
	5825	12
802.11ax 40M	5190	11
	5230	11
	5270	12
	5310	12
	5510	11
	5550	11
	5670	11
	5710-2C	11
	5710-3	11
	5755	11
	5795	11
802.11ax 80M	5210	12
	5290	12
	5530	11
	5610	11
	5690-2C	11
	5690-3	11
	5775	11

5.6. WORSE CASE CONFIGURATIONS

The EUT was tested in the following configuration(s):

Controlled in test mode using a software application on the EUT supplied by customer. The application was used to enable a continuous transmission and to select the mode, test channels, bandwidth, data rates as required.

Test channels referring to section 5.4.

Maximum power setting referring to section 5.5.

Worst case Data Rates declared by the customer:

802.11a 20 mode: 6 Mbps
802.11n HT20 mode: MCS0
802.11n HT40 mode: MCS0
802.11ac VHT20 mode: MCS0
802.11ac VHT40 mode: MCS0
802.11ac VHT80 mode: MCS0
802.11ax HE20 mode: MCS0
802.11ax HE40 mode: MCS0
802.11ax HE80 mode: MCS0

802.11a only support SISO mode.

802.11n HT20/HT40/ac VHT20/VHT40/VHT80/ax HE20/HE40/HE80 support SISO and MIMO mode.

802.11a SISO mode, Antenna 1 and Antenna 2 has the same power setting, so only Antenna 1 worst case test data were recorded in the report.

802.11n/ac/ax SISO mode and MIMO mode have the same power setting, so only the worst case power mode(MIMO) will be record in the report.

802.11ac VHT20 and VHT40 mode are different from 802.11nHT20 and HT40 only in control messages, so for these 4 modes, only 802.11n HT20 and 802.11n HT40 worst case power modes radiated emission test data are recorded in the report .

The EUT has 2 separate antennas which correspond to 2 separate antenna ports. Core 1 and Core 2 correspond to antenna 1 and antenna 2 respectively.

The measured additional path loss was included in any path loss calculations for all RF cable used during tested.

Conducted output power, power spectral density tests separately on each port with all supported SISO & MIMO port combinations.

Radiated emissions tests were performed with the MIMO modes. These were found to be the worst modulation scheme with regards to emissions after preliminary investigations and, as this mode emits the highest conducted output power level, it was deemed to be the worst case.

5.7. DESCRIPTION OF AVAILABLE ANTENNAS

Antenna No.	Frequency Band	Antenna Type	Max Antenna Gain (dBi)
1	5150-5850	External antenna	1.89
3	5150-5850	External antenna	2.74

The EUT support Cyclic Shift Diversity(CDD) mode.

MIMO output power port and MIMO PSD port summing were performed in accordance with KDB 662911 D01. For the CDD results the Directional Gain was calculated in accordance with the following method.

For output power measurements:

Directional gain= $G_{ANT} + \text{Array Gain} = 2.74 \text{ dBi}$

G_{ANT} : equal to the gain of the antenna having the highest gain

Array Gain = 0 dB (i.e., no array gain) for $N_{ANT} \leq 4$

For power spectral density (PSD) measurements:

Directional gain= $G_{ANT} + \text{Array Gain} = 5.75 \text{ dBi}$

Array Gain = $10 \log(N_{ANT}/N_{SS}) \text{ dB}$.

N_{ANT} : number of transmit antennas

N_{SS} : number of spatial streams, The worst case directional gain will occur when $N_{SS} = 1$

IEE Std. 802.11	Transmit and Receive Mode	Description
802.11a	<input checked="" type="checkbox"/> 2TX, 2RX	ANT 1 and ANT 3 can be used as transmitting/receiving antenna.
802.11n HT20	<input checked="" type="checkbox"/> 2TX, 2RX	ANT 1 and ANT 3 can be used as transmitting/receiving antenna.
802.11n HT40	<input checked="" type="checkbox"/> 2TX, 2RX	ANT 1 and ANT 3 can be used as transmitting/receiving antenna.
802.11ac VHT20	<input checked="" type="checkbox"/> 2TX, 2RX	ANT 1 and ANT 3 can be used as transmitting/receiving antenna.
802.11ac VHT40	<input checked="" type="checkbox"/> 2TX, 2RX	ANT 1 and ANT 3 can be used as transmitting/receiving antenna.
802.11ac VHT80	<input checked="" type="checkbox"/> 2TX, 2RX	ANT 1 and ANT 3 can be used as transmitting/receiving antenna.
802.11ax HE20	<input checked="" type="checkbox"/> 2TX, 2RX	ANT 1 and ANT 3 can be used as transmitting/receiving antenna.
802.11ax HE40	<input checked="" type="checkbox"/> 2TX, 2RX	ANT 1 and ANT 3 can be used as transmitting/receiving antenna.
802.11ax HE80	<input checked="" type="checkbox"/> 2TX, 2RX	ANT 1 and ANT 3 can be used as transmitting/receiving antenna.
Note: BT&WLAN 2.4G, BT & WLAN 5G, WLAN 2.4G & WLAN 5G can't transmit simultaneously (Declared by client)		

5.8. SUPPORT UNITS FOR SYSTEM TEST

SUPPORT EQUIPMENT

Item	Equipment	Brand Name	Model Name	Remark
1	PC	Lenovo	E42-80	/
2	AC Adaptor	Lenovo	MACS-1201001202	Input: 100-240 V~50/60 Hz, 0.35 A Output: DC 12V1A
3	OPS board	/	/	/
4	RJ45 dummy load	/	/	/

I/O CABLES

Cable No	Port	Connector Type	Cable Type	Cable Length(m)	Remarks
1	USB	Type-C	/	1.0	/

ACCESSORIES

Item	Accessory	Brand Name	Model Name	Description
/	/	/	/	/

TEST SETUP

The EUT can work in engineering mode with a software through a Laptop.

SETUP DIAGRAM FOR TESTS

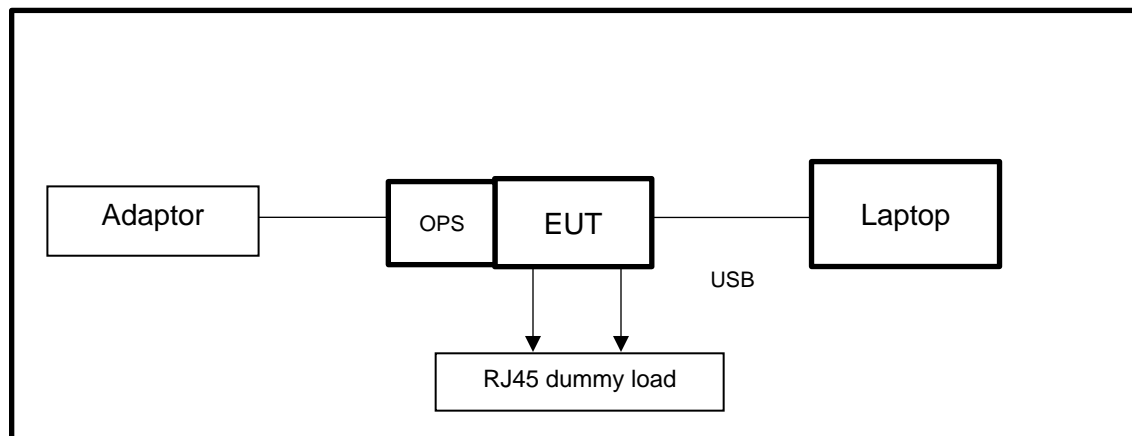

6. MEASURING EQUIPMENT AND SOFTWARE USED

R&S TS 8997 Test System					
Equipment	Manufacturer	Model No.	Serial No.	Last Cal.	Due. Date
Power sensor, Power Meter	R&S	OSP120	100921	Mar.31,2023	Mar.30,2024
Vector Signal Generator	R&S	SMBV100A	261637	Oct.17, 2022	Oct.16, 2023
Signal Generator	R&S	SMB100A	178553	Oct.17, 2022	Oct.16, 2023
Signal Analyzer	R&S	FSV40	101118	Oct.17, 2022	Oct.16, 2023
Software					
Description	Manufacturer	Name		Version	
For R&S TS 8997 Test System	Rohde & Schwarz	EMC 32		10.60.10	
Tonsend RF Test System					
Equipment	Manufacturer	Model No.	Serial No.	Last Cal.	Due. Date
Wideband Radio Communication Tester	R&S	CMW500	155523	Oct.17, 2022	Oct.16, 2023
Wireless Connectivity Tester	R&S	CMW270	1201.0002N75-102	Sep.28, 2022	Sep.27, 2023
PXA Signal Analyzer	Keysight	N9030A	MY55410512	Oct.17, 2022	Oct.16, 2023
MXG Vector Signal Generator	Keysight	N5182B	MY56200284	Oct.17, 2022	Oct.16, 2023
MXG Vector Signal Generator	Keysight	N5172B	MY56200301	Oct.17, 2022	Oct.16, 2023
DC power supply	Keysight	E3642A	MY55159130	Oct.17, 2022	Oct.16, 2023
Temperature & Humidity Chamber	SANMOOD	SG-80-CC-2	2088	Oct.17, 2022	Oct.16, 2023
Attenuator	Aglient	8495B	2814a12853	Oct.18, 2022	Oct.17, 2023
RF Control Unit	Tonscend	JS0806-2	23B80620666	April 18,2023	April 17,2024
Software					
Description	Manufacturer	Name		Version	
Tonsend SRD Test System	Tonsend	JS1120-3 RF Test System		V3.2.22	

Conducted Emissions					
Equipment	Manufacturer	Model No.	Serial No.	Last Cal.	Due Date
EMI Test Receiver	R&S	ESR3	101961	Oct.17, 2022	Oct.16, 2023
Two-Line V-Network	R&S	ENV216	101983	Oct.17, 2022	Oct.16, 2023
Artificial Mains Networks	Schwarzbeck	NSLK 8126	8126465	Oct.17, 2022	Oct.16, 2023
Software					
Description			Manufacturer	Name	Version
Test Software for Conducted Emissions			Farad	EZ-EMC	Ver. UL-3A1

Radiated Emissions					
Equipment	Manufacturer	Model No.	Serial No.	Last Cal.	Due Date
MXE EMI Receiver	KESIGHT	N9038A	MY56400036	Oct.17, 2022	Oct.16, 2023
Hybrid Log Periodic Antenna	TDK	HLP-3003C	130959	Aug.02, 2021	Aug.01, 2024
Preamplifier	HP	8447D	2944A09099	Oct.17, 2022	Oct.16, 2023
EMI Measurement Receiver	R&S	ESR26	101377	Oct.17, 2022	Oct.16, 2023
Horn Antenna	TDK	HRN-0118	130940	July 20, 2021	July 19, 2024
Preamplifier	TDK	PA-02-0118	TRS-305-00067	Oct.17, 2022	Oct.16, 2023
Horn Antenna	Schwarzbeck	BBHA9170	697	July 20, 2021	July 19, 2024
Preamplifier	TDK	PA-02-2	TRS-307-00003	Oct.17, 2022	Oct.16, 2023
Preamplifier	TDK	PA-02-3	TRS-308-00002	Oct.17, 2022	Oct.16, 2023
Loop antenna	Schwarzbeck	1519B	00008	Dec.14, 2021	Dec.13, 2024
Preamplifier	TDK	PA-02-001-3000	TRS-302-00050	Oct.17, 2022	Oct.16, 2023
Preamplifier	Mini-Circuits	ZX60-83LN-S+	SUP01202035	Oct.17, 2022	Oct.16, 2023
High Pass Filter	Wi	WHKX10-2700-3000-18000-40SS	23	Dec.01,2022	Nov.30,2023
Highpass Filter	Wainwright	WHKX10-5850-6500-1800-40SS	4	Dec.01,2022	Nov.30,2023
Band Reject Filter	Wainwright	WRCJV12-5695-5725-5850-5880-40SS	4	Dec.01,2022	Nov.30,2023
Band Reject Filter	Wainwright	WRCJV20-5120-5150-	2	Dec.01,2022	Nov.30,2023

		5350-5380-60SS			
Band Reject Filter	Wainwright	WRCJV20-5440-5470-5725-5755-60SS	1	Dec.01,2022	Nov.30,2023
Band Reject Filter	Wainwright	WRCJV8-2350-2400-2483.5-2533.5-40SS	4	Dec.01,2022	Nov.30,2023
Band Reject Filter	Wainwright	WRCD5-1879-1879.85-1880.15-1881-40SS	1	Dec.01,2022	Nov.30,2023
Notch Filter	Wainwright	WHJ10-882-980-7000-40SS	1	Dec.01,2022	Nov.30,2023
Software					
Description			Manufacturer	Name	Version
Test Software for Radiated Emissions			Farad	EZ-EMC	Ver. UL-3A1

Other Instrument					
Equipment	Manufacturer	Model No.	Serial No.	Last Cal.	Due Date
Temperature humidity probe	OMEGA	ITHX-SD-5	18470007	Oct.22, 2022	Oct.21, 2023
Barometer	Yiyi	Baro	N/A	Oct.24, 2022	Oct.23, 2023
Attenuator	Agilent	8495B	2814a12853	Oct.18, 2022	Oct.17, 2023

7. ANTENNA PORT TEST RESULTS

7.1. ON TIME AND DUTY CYCLE

LIMITS

None; for reporting purposes only.

TEST PROCEDURE

Refer to KDB 789033 D02 General U-NII Test Procedures New Rules v02r01 section II.B.

The zero-span mode on a spectrum analyzer or EMI receiver, if the response time and spacing between bins on the sweep are sufficient to permit accurate measurements of the on and off times of the transmitted signal. Set the center frequency of the instrument to the center frequency of the transmission. Set RBW \geq EBW if possible; otherwise, set RBW to the largest available value. Set VBW \geq RBW. Set detector = peak or average. The zero-span measurement method shall not be used unless both RBW and VBW are $> 50/T$, where T is defined in II.B.1.a), and the number of sweep points across duration T exceeds 100. (For example, if VBW and/or RBW are limited to 3 MHz, then the zero-span method of measuring duty cycle shall not be used if $T \leq 16.7$ microseconds.)

TEST SETUP

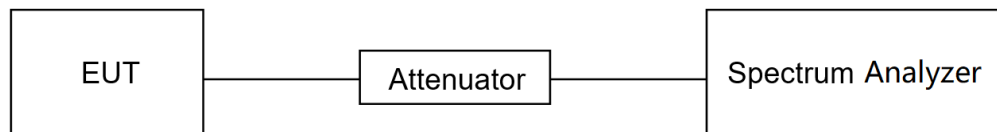

TEST ENVIRONMENT

Temperature	26.4°C	Relative Humidity	60.3%
Atmosphere Pressure	101kPa	Test Voltage	DC 12 V

TEST DATE / ENGINEER

Test Date	August 29, 2023	Test By	Johnson Liu
-----------	-----------------	---------	-------------

TEST RESULTS

Please refer to section "Test Data" - Appendix G

7.2. 6DB AND 26DB EMISSION BANDWIDTH AND 99% OCCUPIED BANDWIDTH

LIMITS

CFR 47 FCC Part15, Subpart E		
Test Item	Limit	Frequency Range (MHz)
26 dB Emission Bandwidth	For reporting purposes only.	5150 ~ 5250
26 dB Emission Bandwidth	For reporting purposes only.	5250 ~ 5350
26 dB Emission Bandwidth	For reporting purposes only.	5470 ~ 5725 (For FCC) 5470 ~ 5600 (For ISSED) 5650 ~ 5725 (For ISSED)
6 dB Emission Bandwidth	The minimum 6 dB emission bandwidth shall be 500 kHz.	5725 ~ 5850
99 % Occupied Bandwidth	For reporting purposes only.	5150 ~ 5825 (For ISSED)

TEST PROCEDURE

Refer to KDB 789033 D02 General U-NII Test Procedures New Rules v02r01 section II.C1. for 26 dB Emission Bandwidth; section II.C2. for 6 dB Emission Bandwidth; section II.D. for 99 % Occupied Bandwidth.

Connect the EUT to the spectrum analyser and use the following settings:

Center Frequency	The center frequency of the channel under test
Detector	Peak
RBW	For 6 dB Emission Bandwidth: RBW=100 kHz For 26 dB Emission bandwidth: approximately 1 % of the EBW. For 99 % Occupied Bandwidth: approximately 1 % ~ 5 % of the OBW.
VBW	For 6 dB Bandwidth: $\geq 3 \times \text{RBW}$ For 26 dB Bandwidth: $> 3 \times \text{RBW}$ For 99 % Bandwidth: $> 3 \times \text{RBW}$
Trace	Max hold
Sweep	Auto couple

- Use the 99 % power bandwidth function of the instrument, allow the trace to stabilize and report the measured bandwidth.
- Allow the trace to stabilize and measure the maximum width of the emission that is constrained by the frequencies associated with the two outermost amplitude points (upper and lower frequencies) that are attenuated by 6/26 dB relative to the maximum level measured in the fundamental emission.

Calculation for 99 % Bandwidth of UNII-2C and UNII-3 Straddle Channel:

For Example: Fundamental Frequency: 5720 MHz

99 % OBW: 21.00 MHz

Turning Frequency: 5725 MHz

99 % Bandwidth of UNII-2C Band Portion = $(5725 - (5720 - (21.00/2))) = 15.50 \text{ MHz}$

99 % Bandwidth of UNII-3 Band Portion = $(5720 + (21.00/2) - 5725) = 5.50 \text{ MHz}$

Calculation for 26 dB Bandwidth of UNII-2C Straddle Channel:

For Example: Fundamental frequency: 5720 MHz

26 dB BW: 20.00 MHz

FL: 5710.16 MHz

FH: 5730.16 MHz

Turning Frequency: 5725 MHz

26 dB Bandwidth of UNII-2C Band Portion = $5725 - 5710.16 = 14.84$ MHz

Calculation for 6dB Bandwidth of UNII-3 Straddle Channel:

For Example: Fundamental frequency: 5720 MHz

6 dB BW: 16.44 MHz

FL: 5711.76 MHz

FH: 5728.2 MHz

Turning Frequency: 5725 MHz

6 dB Bandwidth of UNII-3 band Portion = $5728.2 - 5725 = 3.2$ MHz

TEST SETUP

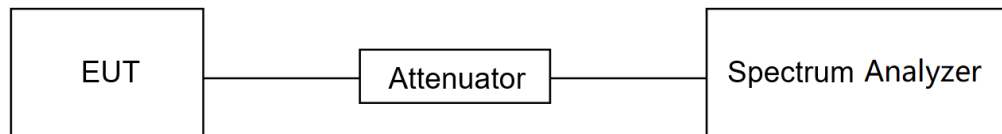

TEST ENVIRONMENT

Temperature	26.4°C	Relative Humidity	60.3%
Atmosphere Pressure	101kPa	Test Voltage	DC 12 V

TEST DATE / ENGINEER

Test Date	August 29, 2023	Test By	Johnson Liu
-----------	-----------------	---------	-------------

TEST RESULTS

Please refer to section "Test Data" - Appendix A&B&C

7.3. CONDUCTED OUTPUT POWER

LIMITS

CFR 47 FCC Part15, Subpart E		
Test Item	Limit	Frequency Range (MHz)
Conducted Output Power	<input type="checkbox"/> Outdoor Access Point: 1 W (30 dBm) <input type="checkbox"/> Indoor Access Point: 1 W (30 dBm) <input type="checkbox"/> Fixed Point-To-Point Access Points: 1 W (30 dBm) <input checked="" type="checkbox"/> Client Devices: 250 mW (24 dBm)	5150 ~ 5250
	Shall not exceed the lesser of 250 mW (24dBm) or 11 dBm + 10 log B, where B is the 26 dB emission bandwidth in megahertz.	5250 ~ 5350 5470 ~ 5725
	Shall not exceed 1 Watt (30 dBm).	5725 ~ 5850

Note:

The above limits are based upon the maximum antenna gain does not exceed 6 dBi.

If transmitting antennas of directional gain greater than 6 dBi are used, the maximum conducted output power shall be reduced by the amount in dB that the directional gain of the antenna exceeds 6 dBi.

TEST PROCEDURE

Refer to KDB 789033 D02 General U-NII Test Procedures New Rules v02r01 section II.E.

Method SA-2 (trace averaging across ON and OFF times of the EUT transmissions, followed by duty cycle correction.):

- (a) Measure the duty cycle D of the transmitter output signal.
- (b) Set span to encompass the entire 26 dB EBW or 99% OBW of the signal.
- (c) Set RBW = 1 MHz.
- (d) Set VBW \geq 3 MHz.
- (e) Number of points in sweep \geq $[2 \times \text{span} / \text{RBW}]$. (This gives bin-to-bin spacing \leq RBW / 2, so that narrowband signals are not lost between frequency bins.)
- (f) Sweep time = auto.
- (g) Detector = RMS (i.e., power averaging), if available. Otherwise, use sample detector mode.
- (h) Do not use sweep triggering. Allow the sweep to “free run.”
- (i) Trace average at least 100 traces in power averaging (rms) mode; however, the number of traces to be averaged shall be increased above 100 as needed such that the average accurately represents the true average over the ON and OFF periods of the transmitter.
- (j) Compute power by integrating the spectrum across the 26 dB EBW or 99% OBW of the signal using the instrument’s band power measurement function with band limits set equal to the EBW or OBW band edges. If the instrument does not have a band power function, then sum the spectrum levels (in power units) at 1 MHz intervals extending across the 26 dB EBW or 99% OBW of the spectrum.
- (k) Add $[10 \log (1 / D)]$, where D is the duty cycle, to the measured power to compute the average power during the actual transmission times (because the measurement represents an average over both the ON and OFF times of the transmission). For example, add $[10 \log (1 / 0.25)] = 6$ dB if the duty cycle is 25%.

Method PM (Measurement using an RF average power meter):

(i) Measurements may be performed using a wideband RF power meter with a thermocouple detector or equivalent if all of the following conditions are satisfied:

a. The EUT is configured to transmit continuously or to transmit with a constant duty cycle.
 b. At all times when the EUT is transmitting, it must be transmitting at its maximum power control level.

c. The integration period of the power meter exceeds the repetition period of the transmitted signal by at least a factor of five.

(ii) If the transmitter does not transmit continuously, measure the duty cycle, x , of the transmitter output signal as described in II.B.

(iii) Measure the average power of the transmitter. This measurement is an average over both the on and off periods of the transmitter.

(iv) Adjust the measurement in dBm by adding $10 \log (1/x)$ where x is the duty cycle (e.g., $10 \log (1/0.25)$ if the duty cycle is 25 %).

Note: Method SA-2 was used for straddle channel output power test, and Method PM was used for testing rest channels

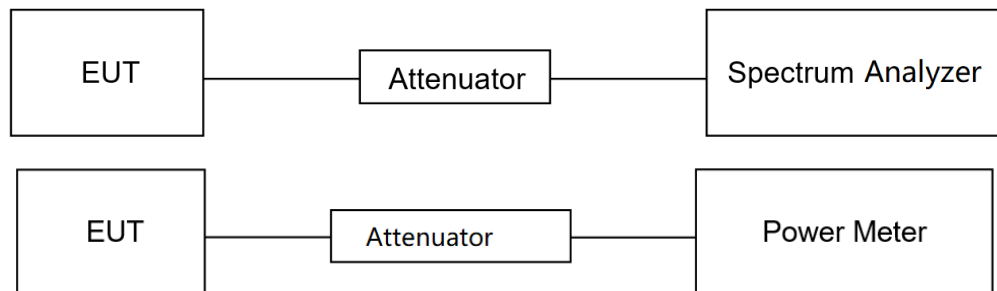
TEST SETUP

TEST ENVIRONMENT

Temperature	26.4°C	Relative Humidity	60.3%
Atmosphere Pressure	101kPa	Test Voltage	DC 12 V

TEST DATE / ENGINEER

Test Date	August 29, 2023	Test By	Johnson Liu
-----------	-----------------	---------	-------------

TEST RESULTS

Please refer to section "Test Data" - Appendix D

7.4. POWER SPECTRAL DENSITY

LIMITS

CFR 47 FCC Part15, Subpart E		
Test Item	Limit	Frequency Range (MHz)
Power Spectral Density	<input type="checkbox"/> Outdoor Access Point: 17 dBm/MHz <input type="checkbox"/> Indoor Access Point: 17 dBm/MHz <input type="checkbox"/> Fixed Point-To-Point Access Points: 17 dBm/MHz <input checked="" type="checkbox"/> Client Devices: 11 dBm/MHz	5150 ~ 5250
	11 dBm/MHz	5250 ~ 5350 5470 ~ 5725
	30 dBm/500kHz	5725 ~ 5850

ISED RSS-247 ISSUE 3		
Test Item	Limit	Frequency Range (MHz)
Power Spectral Density	The e.i.r.p. spectral density shall not exceed 10 dBm in any 1.0 MHz band.	5150 ~ 5250
	The power spectral density shall not exceed 11 dBm in any 1.0 MHz band.	5250 ~ 5350 5470 ~ 5600 5650 ~ 5725
	30 dBm / 500 kHz	5725 ~ 5850

Note:

The above limits are based upon the maximum antenna gain does not exceed 6 dBi. If transmitting antennas of directional gain greater than 6 dBi are used, maximum power spectral density shall be reduced by the amount in dB that the directional gain of the antenna exceeds 6 dBi.

TEST PROCEDURE

Refer to KDB 789033 D02 General U-NII Test Procedures New Rules v02r01 section II.F.

Connect the EUT to the spectrum analyzer and use the following settings:

For U-NII-1, U-NII-2A and U-NII-2C band:

Center Frequency	The center frequency of the channel under test
Detector	RMS
RBW	1 MHz
VBW	$\geq 3 \times \text{RBW}$
Span	Encompass the entire emissions bandwidth (EBW) of the signal
Trace	Max hold
Sweep time	Auto

For U-NII-3:

Center Frequency	The center frequency of the channel under test
Detector	RMS
RBW	500 kHz
VBW	$\geq 3 \times \text{RBW}$
Span	Encompass the entire emissions bandwidth (EBW) of the signal
Trace	Max hold
Sweep time	Auto

Allow trace to fully stabilize and use the peak search function on the instrument to find the peak of the spectrum and record its value.

Add $10 \log(1/x)$, where x is the duty cycle, to the peak of the spectrum, the result is the Maximum PSD over 1 MHz / 500 kHz reference bandwidth.

TEST SETUP

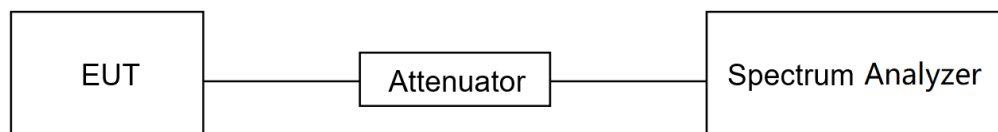

TEST ENVIRONMENT

Temperature	26.4°C	Relative Humidity	60.3%
Atmosphere Pressure	101kPa	Test Voltage	DC 12 V

TEST DATE / ENGINEER

Test Date	August 29, 2023	Test By	Johnson Liu
-----------	-----------------	---------	-------------

TEST RESULTS

Please refer to section "Test Data" - Appendix E

7.5. FREQUENCY STABILITY

LIMITS

The frequency of the carrier signal shall be maintained within band of operation.

TEST PROCEDURE

1. The EUT was placed inside an environmental chamber as the temperature in the chamber was varied between 0 °C ~ 45 °C (declared by customer).
2. The temperature was incremented by 10 °C intervals and the unit allowed to stabilize at each temperature before each measurement. The center frequency of the transmitting channel was evaluated at each temperature and the frequency deviation from the channel's center frequency was recorded.
3. The primary supply voltage is varied from 85 % to 115 % of the nominal value for non hand-carried battery and AC powered equipment. For hand-carried, battery-powered equipment, primary supply voltage is reduced to the battery operating end point which shall be specified by the manufacturer.

For devices obtaining power from an input/output (I/O) port (USB, firewire, etc.), a test jig is necessary to apply voltage variation to the device from a support power supply, while maintaining the functionalities of the device.

Connect the EUT to the spectrum analyzer and use the following settings:

Center Frequency	The center frequency of the channel under test
Detector	Peak
RBW	10 kHz
VBW	$\geq 3 \times \text{RBW}$
Span	Encompass the entire emissions bandwidth (EBW) of the signal
Trace	Max hold
Sweep time	Auto

4. While maintaining a constant temperature inside the environmental chamber, turn the EUT on and record the operating frequency at startup, and at 2 minutes, 5 minutes, and 10 minutes after the EUT is energized.
5. Allow the trace to stabilize, find the peak value of the power envelope and record the frequency, then calculated the frequency drift.

TEST ENVIRONMENT

	Normal Test Conditions	Extreme Test Conditions
Relative Humidity	20 % ~ 75 %	/
Atmospheric Pressure	100 kPa ~ 102 kPa	/
Temperature	T _N (Normal Temperature): 25.1 °C	T _L (Low Temperature): 0 °C
		T _H (High Temperature): 45 °C
Supply Voltage	V _N (Normal Voltage): DC 12 V	V _L (Low Voltage): DC 10.2 V
		V _H (High Voltage): DC 13.8 V

TEST SETUP

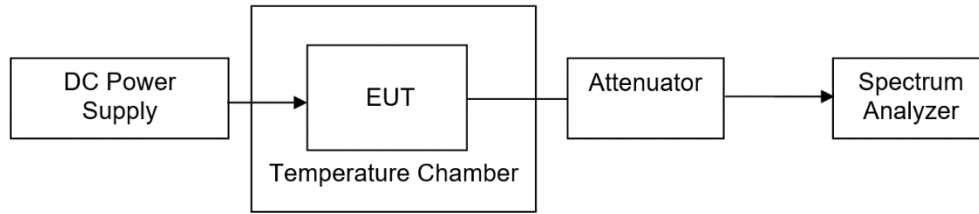

TEST ENVIRONMENT

Temperature	26.4°C	Relative Humidity	60.3%
Atmosphere Pressure	101kPa	Test Voltage	DC 12 V

TEST DATE / ENGINEER

Test Date	August 29, 2023	Test By	Johnson Liu
-----------	-----------------	---------	-------------

TEST RESULTS

Please refer to section "Test Data" - Appendix F

7.6. DYNAMIC FREQUENCY SELECTION (SLAVE)

LIMITS

(1) DFS Detection Thresholds

Table 3: DFS Detection Thresholds for Master Devices and Client Devices With Radar Detection

Maximum Transmit Power	Value (See Notes 1, 2, and 3)
EIRP \geq 200 milliwatt	-64 dBm
EIRP < 200 milliwatt and power spectral density < 10 dBm/MHz	-62 dBm
EIRP < 200 milliwatt that do not meet the power spectral density requirement	-64 dBm

Note 1: This is the level at the input of the receiver assuming a 0 dBi receive antenna.
 Note 2: Throughout these test procedures an additional 1 dB has been added to the amplitude of the test transmission waveforms to account for variations in measurement equipment. This will ensure that the test signal is at or above the detection threshold level to trigger a DFS response.
 Note3: EIRP is based on the highest antenna gain. For MIMO devices refer to KDB Publication 662911 D01.

(2) DFS Response Requirements

Table 4: DFS Response Requirement Values

Parameter	Value
Non-occupancy period	Minimum 30 minutes
Channel Availability Check Time	60 seconds
Channel Move Time	10 seconds See Note 1.
Channel Closing Transmission Time	200 milliseconds + an aggregate of 60 milliseconds over remaining 10 second period. See Notes 1 and 2.
U-NII Detection Bandwidth	Minimum 100% of the U-NII 99% transmission power bandwidth. See Note 3.

Note 1: Channel Move Time and the Channel Closing Transmission Time should be performed with Radar Type 0. The measurement timing begins at the end of the Radar Type 0 burst.
 Note 2: The Channel Closing Transmission Time is comprised of 200 milliseconds starting at the beginning of the Channel Move Time plus any additional intermittent control signals required facilitating a Channel move (an aggregate of 60 milliseconds) during the remainder of the 10 second period. The aggregate duration of control signals will not count quiet periods in between transmissions.
 Note 3: During the U-NII Detection Bandwidth detection test, radar type 0 should be used. For each frequency step the minimum percentage of detection is 90 percent. Measurements are performed with no data traffic.

APPLICABILITY OF DFS REQUIREMENTS

A U-NII network will employ a DFS function to detect signals from radar systems and to avoid co-channel operation with these systems. This applies to the 5250-5350 MHz and/or 5470-5725 MHz bands.

Within the context of the operation of the DFS function, a U-NII device will operate in either Master Mode or Client Mode. U-NII devices operating in Client Mode can only operate in a network controlled by a U-NII device operating in Master Mode.

Table 1: Applicability of DFS Requirements Prior to Use of a Channel

Requirement	Operational Mode		
	<input type="checkbox"/> Master	<input checked="" type="checkbox"/> Client Without Radar Detection	<input type="checkbox"/> Client With Radar Detection
Non-Occupancy Period	Yes	Not required	Yes
DFS Detection Threshold	Yes	Not required	Yes
Channel Availability Check Time	Yes	Not required	Not required
U-NII Detection Bandwidth	Yes	Not required	Yes

Table 2: Applicability of DFS requirements during normal operation

Requirement	Operational Mode	
	<input type="checkbox"/> Master Device or Client with Radar Detection	<input checked="" type="checkbox"/> Client Without Radar Detection
DFS Detection Threshold	Yes	Not required
Channel Closing Transmission Time	Yes	Yes
Channel Move Time	Yes	Yes
U-NII Detection Bandwidth	Yes	Not required

Additional requirements for devices with multiple bandwidth modes	<input type="checkbox"/> Master Device or Client with Radar Detection	<input checked="" type="checkbox"/> Client Without Radar Detection
U-NII Detection Bandwidth and Statistical Performance Check	All BW modes must be tested	Not required
Channel Move Time and Channel Closing Transmission Time	Test using widest BW mode available	Test using the widest BW mode available for the link
All other tests	Any single BW mode	Not required

Note: Frequencies selected for statistical performance check should include several frequencies within the radar detection bandwidth and frequencies near the edge of the radar detection bandwidth. For 802.11 devices it is suggested to select frequencies in each of the bonded 20 MHz channels and the channel center frequency.

PARAMETERS OF RADAR TEST WAVEFORMS

This section provides the parameters for required test waveforms, minimum percentage of successful detections, and the minimum number of trials that must be used for determining DFS conformance. Step intervals of 0.1 microsecond for Pulse Width, 1 microsecond for PRI, 1 MHz for chirp width and 1 for the number of pulses will be utilized for the random determination of specific test waveforms.

Table 5 Short Pulse Radar Test Waveforms

Radar Type	Pulse Width (μsec)	PRI (μsec)	Number of Pulses	Minimum Percentage of Successful Detection	Minimum Number of Trials
0	1	1428	18	See Note 1	See Note 1
1	1	Test A	Roundup $\left\{ \begin{array}{l} \frac{1}{360} \\ \frac{19 \cdot 10^6}{\text{PRI}_{\mu\text{sec}}} \end{array} \right\}$	60%	30
		Test B			
2	1-5	150-230	23-29	60%	30
3	6-10	200-500	16-18	60%	30
4	11-20	200-500	12-16	60%	30
Aggregate (Radar Types 1-4)				80%	120
Note 1: Short Pulse Radar Type 0 should be used for the detection bandwidth test, channel move time, and channel closing time tests. Test A: 15 unique PRI values randomly selected from the list of 23 PRI values in Table 5a Test B: 15 unique PRI values randomly selected within the range of 518-3066 μsec, with a minimum increment of 1 μsec, excluding PRI values selected in Test A					

A minimum of 30 unique waveforms are required for each of the Short Pulse Radar Types 2 through 4. If more than 30 waveforms are used for Short Pulse Radar Types 2 through 4, then each additional waveform must also be unique and not repeated from the previous waveforms. If more than 30 waveforms are used for Short Pulse Radar Type 1, then each additional waveform is generated with Test B and must also be unique and not repeated from the previous waveforms in Tests A or B. Test aggregate is average of the percentage of successful detections of short pulse radar types 1-4.

TEST SETUP

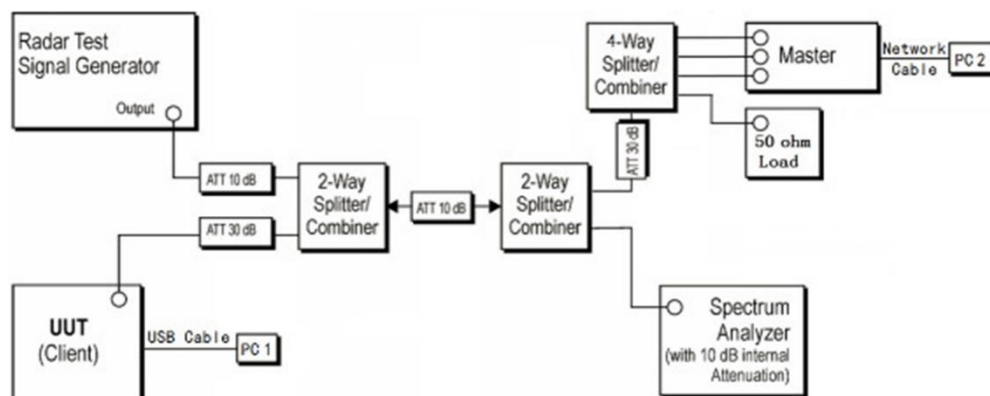

TEST ENVIRONMENT

Temperature	26.4°C	Relative Humidity	60.3%
Atmosphere Pressure	101kPa	Test Voltage	DC 12 V

TEST DATE / ENGINEER

Test Date	August 29, 2023	Test By	Johnson Liu
-----------	-----------------	---------	-------------

TEST RESULTS

Please refer to section "Test Data" - Appendix H

8. RADIATED TEST RESULTS

LIMITS

Refer to CFR 47 FCC §15.205, §15.209 and §15.407 (b).

Radiation Disturbance Test Limit for FCC (Class B) (9 kHz ~ 1 GHz)

Emissions radiated outside of the specified frequency bands above 30 MHz			
Frequency Range (MHz)	Field Strength Limit (uV/m) at 3 m	Field Strength Limit (dBuV/m) at 3 m	
		Quasi-Peak	
30 - 88	100	40	
88 - 216	150	43.5	
216 - 960	200	46	
Above 960	500	54	
Above 1000	500	Peak	Average
		74	54

FCC Emissions radiated outside of the specified frequency bands below 30 MHz		
Frequency (MHz)	Field strength (microvolts/meter)	Measurement distance (meters)
0.009-0.490	2400/F(kHz)	300
0.490-1.705	24000/F(kHz)	30
1.705-30.0	30	30

FCC Restricted bands of operation refer to FCC §15.205 (a):

MHz	MHz	MHz	GHz
0.090-0.110	16.42-16.423	399.9-410	4.5-5.15
¹ 0.495-0.505	16.69475-16.69525	608-614	5.35-5.46
2.1735-2.1905	16.80425-16.80475	960-1240	7.25-7.75
4.125-4.128	25.5-25.67	1300-1427	8.025-8.5
4.17725-4.17775	37.5-38.25	1435-1626.5	9.0-9.2
4.20725-4.20775	73-74.6	1645.5-1646.5	9.3-9.5
6.215-6.218	74.8-75.2	1660-1710	10.6-12.7
6.26775-6.26825	108-121.94	1718.8-1722.2	13.25-13.4
6.31175-6.31225	123-138	2200-2300	14.47-14.5
8.291-8.294	149.9-150.05	2310-2390	15.35-16.2
8.362-8.366	156.52475-156.52525	2483.5-2500	17.7-21.4
8.37625-8.38675	156.7-156.9	2690-2900	22.01-23.12
8.41425-8.41475	162.0125-167.17	3260-3267	23.6-24.0
12.29-12.293	167.72-173.2	3332-3339	31.2-31.8
12.51975-12.52025	240-285	3345.8-3358	36.43-36.5
12.57675-12.57725	322-335.4	3600-4400	(²)
13.36-13.41			

Note: ¹Until February 1, 1999, this restricted band shall be 0.490-0.510 MHz.

²Above 38.6c

Limits of unwanted/undesirable emission out of the restricted bands refer to CFR 47 FCC §15.407 (b) and ISED RSS-247 6.2.

LIMITS OF RADIATED EMISSION MEASUREMENT (Above 1GHz)		
Frequency Range (MHz)	EIRP Limit	Field Strength Limit (dBuV/m) at 3 m
5150~5250 MHz	PK: -27 (dBm/MHz)	PK:68.2(dBμV/m)
5250~5350 MHz		
5470~5725 MHz		
5725~5850 MHz	PK: -27 (dBm/MHz) *1 PK: 10 (dBm/MHz) *2 PK: 15.6 (dBm/MHz) *3 PK: 27 (dBm/MHz) *4	PK: 68.2(dBμV/m) *1 PK: 105.2 (dBμV/m) *2 PK: 110.8(dBμV/m) *3 PK: 122.2 (dBμV/m) *4
Note: *1 beyond 75 MHz or more above of the band edge. *2 below the band edge increasing linearly to 10 dBm/MHz at 25 MHz above. *3 below the band edge increasing linearly to a level of 15.6 dBm/MHz at 5 MHz above. *4 from 5 MHz above or below the band edge increasing linearly to a level of 27 dBm/MHz at the band edge.		

TEST PROCEDURE

Below 30 MHz

The setting of the spectrum analyzer

RBW	200 Hz (From 9 kHz to 0.15 MHz)/ 9 kHz (From 0.15 MHz to 30 MHz)
VBW	200 Hz (From 9 kHz to 0.15 MHz)/ 9 kHz (From 0.15 MHz to 30 MHz)
Sweep	Auto

1. The testing follows the guidelines in ANSI C63.10-2013 clause 6.4.
2. The EUT was arranged to its worst case and then turntable (from 0 degree to 360 degrees) to find the maximum reading. A pre-amp and a high pass filter are used for the test in order to get better signal level. Both Horizontal, Face-on and Face-off polarizations of the antenna are set to make the measurement.
3. The EUT was placed on a turntable with 80 cm above ground.
4. The EUT was set 3 meters from the interference receiving antenna, which was mounted on the top of a 1 m height antenna tower.
5. The radiated emission limits are based on measurements employing a CISPR quasi-peak detector except for the frequency bands 9-90 kHz, 110-490 kHz and above 1000 MHz Radiated emission limits in these three bands are based on measurements employing an average detector.
6. For measurement below 1 GHz, the initial step in collecting conducted emission data is a spectrum analyzer peak detector mode pre-scanning the measurement frequency range. Significant peaks are then marked and then Quasi Peak and average detector mode re-measured. If the emission level of the EUT measured by the peak detector is 3 dB lower than the applicable limit, the peak emission level will be reported. Otherwise, the emission measurement will be repeated using the quasi-peak and average detector and reported.
7. Although these tests were performed other than open field site, adequate comparison measurements were confirmed against 30m open field site. Therefore sufficient tests were made

to demonstrate that the alternative site produces results that correlate with the ones of tests made in an open field site based on KDB 414788.

8. The limits in CFR 47, Part 15, Subpart C, paragraph 15.209 (a), are identical to those in RSS-GEN Section 8.9, Table 6, since the measurements are performed in terms of magnetic field strength and converted to electric field strength levels (as reported in the table) using the free space impedance of 377Ω . For example, the measurement frequency X kHz resulted in a level of Y dBuV/m, which is equivalent to $Y-51.5 = Z$ dBuA/m, which has the same margin, W dB, to the corresponding RSS-GEN Table 6 limit as it has to be 15.209(a) limit.

Below 1 GHz and above 30 MHz

The setting of the spectrum analyzer

RBW	120 kHz
VBW	300 kHz
Sweep	Auto
Detector	Peak/QP
Trace	Max hold

1. The testing follows the guidelines in ANSI C63.10-2013 clause 6.5.
2. The EUT was arranged to its worst case and then tune the antenna tower (from 1 m to 4 m) and turntable (from 0 degree to 360 degrees) to find the maximum reading. A pre-amp and a high pass filter are used for the test in order to get better signal level. Both horizontal and vertical polarizations of the antenna are set to make the measurement.
3. The EUT was placed on a turntable with 80 cm above ground.
4. The EUT was set 3 meters from the interference receiving antenna, which was mounted on the top of a variable height antenna tower.
5. For measurement below 1 GHz, the initial step in collecting conducted emission data is a spectrum analyzer peak detector mode pre-scanning the measurement frequency range. Significant peaks are then marked and then Quasi Peak detector mode re-measured. If the emission level of the EUT measured by the peak detector is 3 dB lower than the applicable limit, the peak emission level will be reported. Otherwise, the emission measurement will be repeated using the quasi-peak detector and reported.

Above 1 GHz

The setting of the spectrum analyzer

RBW	1 MHz
VBW	PEAK: 3 MHz AVG: see note 6
Sweep	Auto
Detector	Peak
Trace	Max hold

1. The testing follows the guidelines in KDB 789033 D02 General U-NII Test Procedures New Rules v02r01 section II.G.3 ~ II.G.6.
2. The EUT was arranged to its worst case and then tune the antenna tower (from 1 m to 4 m) and turntable (from 0 degree to 360 degrees) to find the maximum reading. A pre-amp and a high pass filter are used for the test in order to get better signal level. Both horizontal and vertical polarizations of the antenna are set to make the measurement.
3. The EUT was placed on a turntable with 1.5 m above ground.
4. The EUT was set 3 meters from the interference receiving antenna, which was mounted on the top of a variable height antenna tower.
5. For measurement above 1 GHz, the emission measurement will be measured by the peak detector. This peak level, once corrected, must comply with the limit specified in Section 15.209.
6. For measurements above 1 GHz the resolution bandwidth is set to 1 MHz, then the video bandwidth is set to 3 MHz for peak measurements and 1 MHz resolution bandwidth with 1/T video bandwidth with peak detector for average measurements. For the Duty Cycle please refer to clause 7.1. ON TIME AND DUTY CYCLE.

X axis, Y axis, Z axis positions:

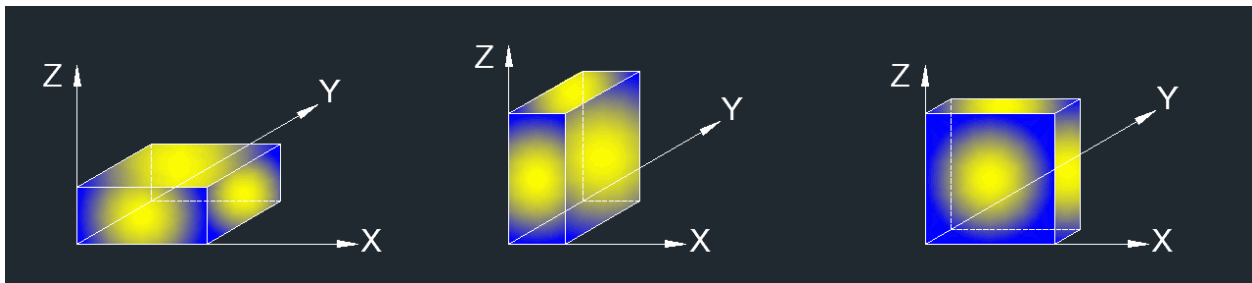

Note 1: For all radiated test, EUT in each of three orthogonal axis emissions had been tested, but only the worst case (X axis) data recorded in the report.

For Restricted Bandedge:

Note:

1. Measurement = Reading Level + Correct Factor.
2. If the peak values are less than the average limit of 54 dBuV/m, the average result is deemed to comply with average limit.
3. PK=Peak: Peak detector.
4. AV=Average: VBW=1/Ton, where: Ton is the transmitting duration.
5. For the transmitting duration, please refer to clause 7.1.
6. Only the worst data was recorded, if it complies with the limit, the other emissions deemed to comply with the limit.
7. Both horizontal and vertical have been tested, only the worst data was recorded in the report.
8. All modes have been tested, but only the worst data was recorded in the report.

For Radiate Spurious emission (9 kHz ~ 30 MHz):

Note:

1. Measurement = Reading Level + Correct Factor.
2. If the peak values are less than the QP limit, the QP result is deemed to comply with QP limit.
3. All 3 polarizations (Horizontal, Face-on and Face-off) of the loop antenna had been tested, but only the worst data recorded in the report.
4. All modes have been tested, but only the worst data was recorded in the report.
5. $\text{dBuA/m} = \text{dBuV/m} - 20\text{Log}_{10}[120\pi] = \text{dBuV/m} - 51.5$

For Radiate Spurious Emission (30 MHz ~ 1 GHz):

Note:

1. Result Level = Read Level + Correct Factor.
2. If the peak values are less than the QP limit, the QP result is deemed to comply with QP limit.
3. All modes have been tested, but only the worst data was recorded in the report.

For Radiate Spurious Emission (1 GHz ~ 7 GHz):

1. Measurement = Reading Level + Correct Factor.
2. If the peak values are less than the average limit of 54 dBuV/m, the average result is deemed to comply with average limit.
3. Peak: Peak detector.
4. AVG: VBW=1/Ton, where: Ton is the transmitting duration.
5. For the transmitting duration, please refer to clause 7.1.
6. Filter losses were only considered in the spurious frequency bands and the authorized band was not corrected for Band reject filter losses.
7. Proper operation of the transmitter prior to adding the filter to the measurement chain.
8. Since non-restricted band peak emissions are less than the average limit, they also comply with the -27 dBm/MHz (68.2 dBuV/m) limit.
9. All modes have been tested, but only the worst data was recorded in the report.

For Radiate Spurious Emission (7 GHz ~ 18 GHz):

Note:

1. Peak Result = Reading Level + Correct Factor.
2. If the peak values are less than the average limit of 54 dBuV/m, the average result is deemed to comply with average limit.
3. Peak: Peak detector.
4. AVG: $VBW=1/T_{on}$, where: T_{on} is the transmitting duration.
5. For the transmitting duration, please refer to clause 7.1.
6. Filter losses were only considered in the spurious frequency bands and the authorized band was not corrected for High Pass Filter losses.
7. Proper operation of the transmitter prior to adding the filter to the measurement chain.
8. Since non-restricted band peak emissions are less than the average limit, they also comply with the -27 dBm/MHz (68.2 dBuV/m) limit.
9. All modes have been tested, but only the worst data was recorded in the report.

For Radiate Spurious emission (18 GHz ~ 26 GHz):

Note:

1. Measurement = Reading Level + Correct Factor.
2. If the peak values are less than the average limit of 54 dBuV/m, the average result is deemed to comply with average limit.
3. Peak: Peak detector.
4. All modes have been tested, but only the worst data was recorded in the report.

For Radiate Spurious emission (26 GHz ~ 40 GHz):

Note:

1. Measurement = Reading Level + Correct Factor.
2. If the peak values are less than the average limit of 54 dBuV/m, the average result is deemed to comply with average limit.
3. Peak: Peak detector.
4. All modes have been tested, but only the worst data was recorded in the report.

TEST SETUP

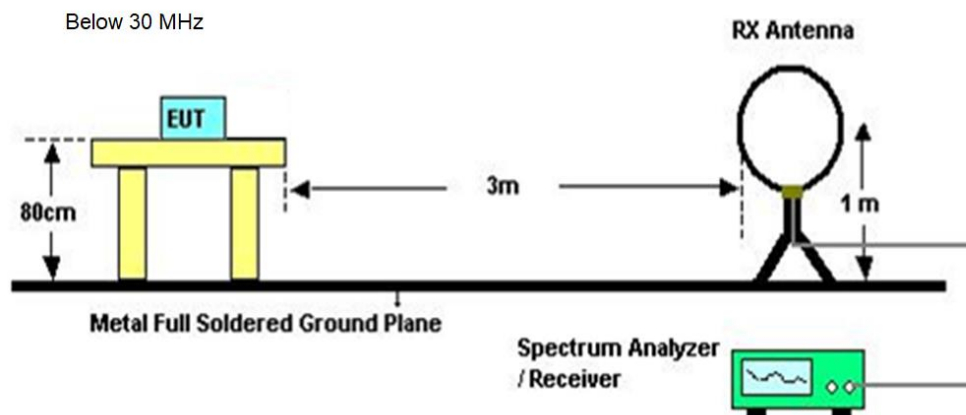

Below 1 GHz and above 30 MHz

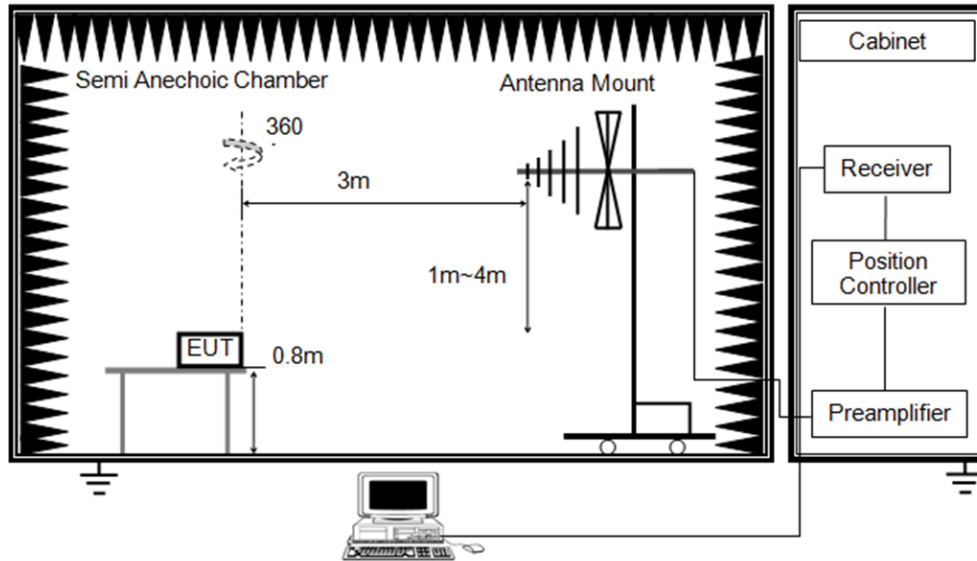

Above 1 GHz

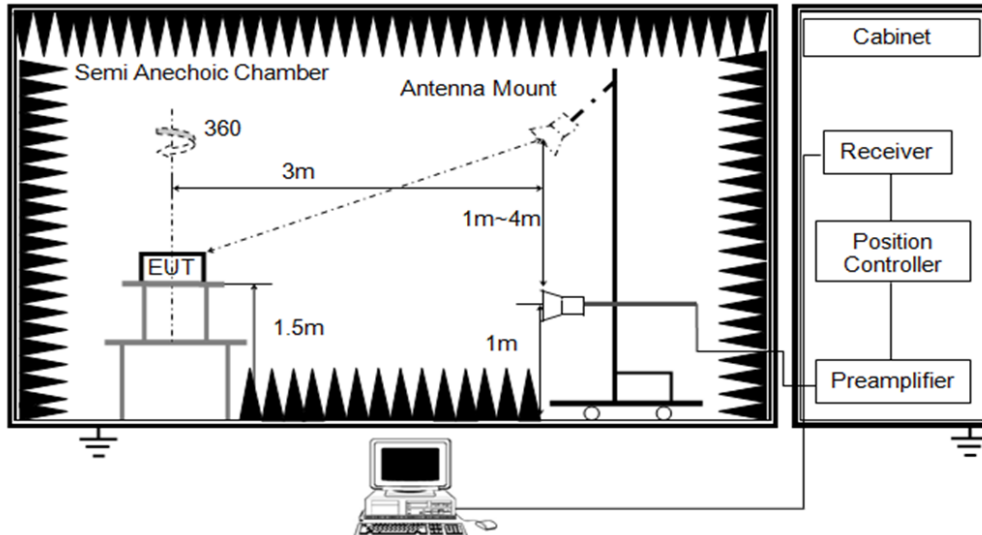

TEST ENVIRONMENT

Temperature	25.3°C	Relative Humidity	62%
Atmosphere Pressure	101kPa	Test Voltage	

TEST DATE / ENGINEER

Test Date	September 12, 2023	Test By	Rex Huang
-----------	--------------------	---------	-----------

TEST RESULTS

8.1. RESTRICTED BANDEDGE

Test Mode:	802.11a 20 PK	Frequency(MHz):	5180
Polarity:	Vertical	Test Voltage:	DC 12 V

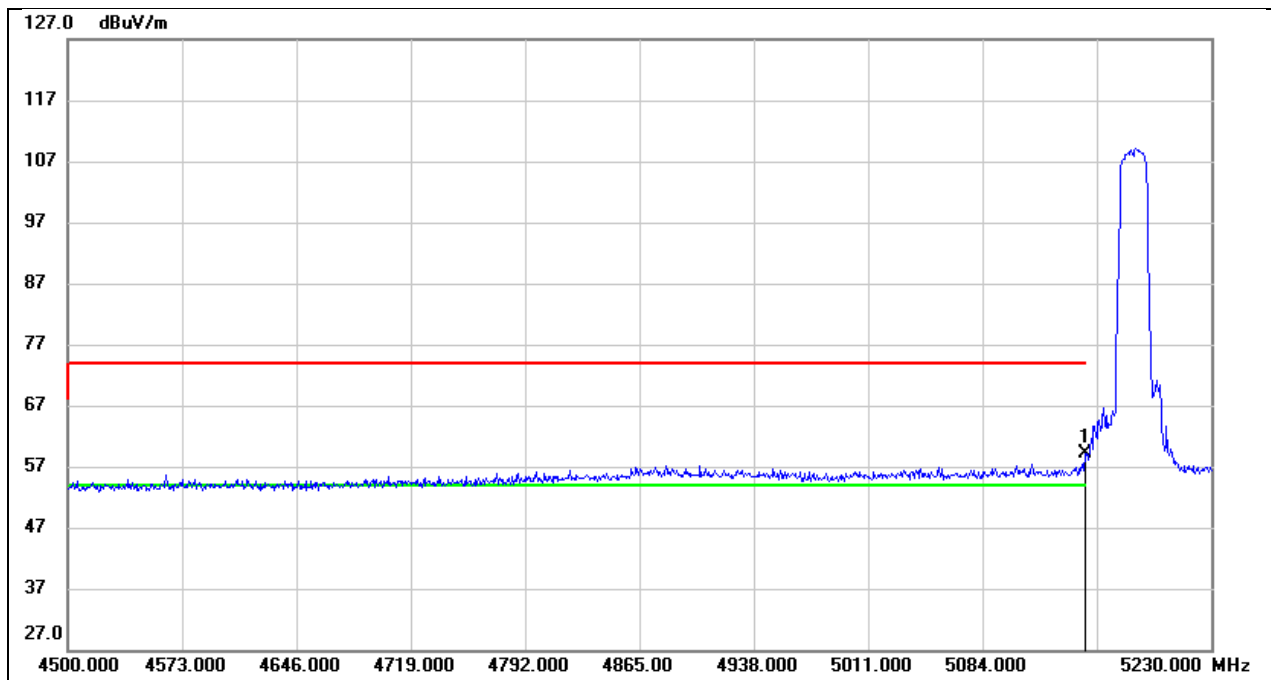

No.	Frequency (MHz)	Reading (dBuV)	Correct (dB/m)	Result (dBuV/m)	Limit (dBuV/m)	Margin (dB)	Remark
1	5150.000	18.80	40.27	59.07	74.00	-14.93	peak

Test Mode:	802.11a 20 AV	Frequency(MHz):	5180
Polarity:	Vertical	Test Voltage:	DC 12 V

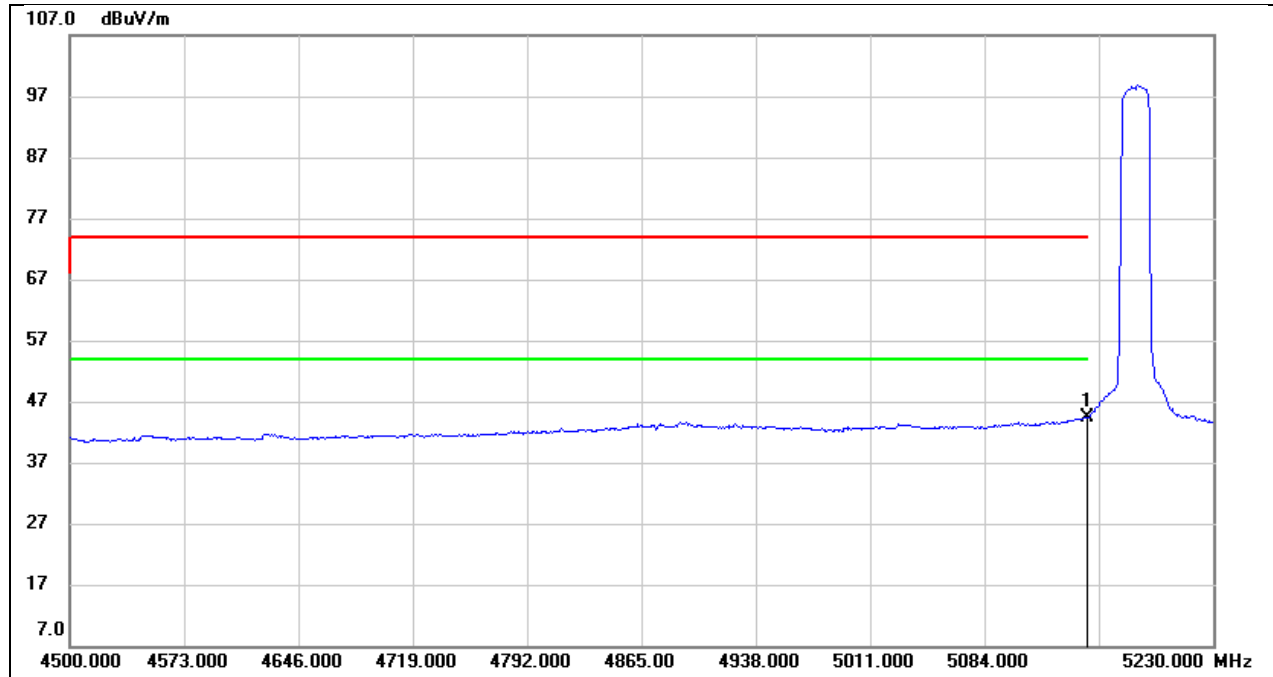

No.	Frequency (MHz)	Reading (dBuV)	Correct (dB/m)	Result (dBuV/m)	Limit (dBuV/m)	Margin (dB)	Remark
1	5150.000	4.11	40.27	44.38	54.00	-9.62	AVG

Test Mode:	802.11a 20 PK	Frequency(MHz):	5240
Polarity:	Vertical	Test Voltage:	DC 12 V

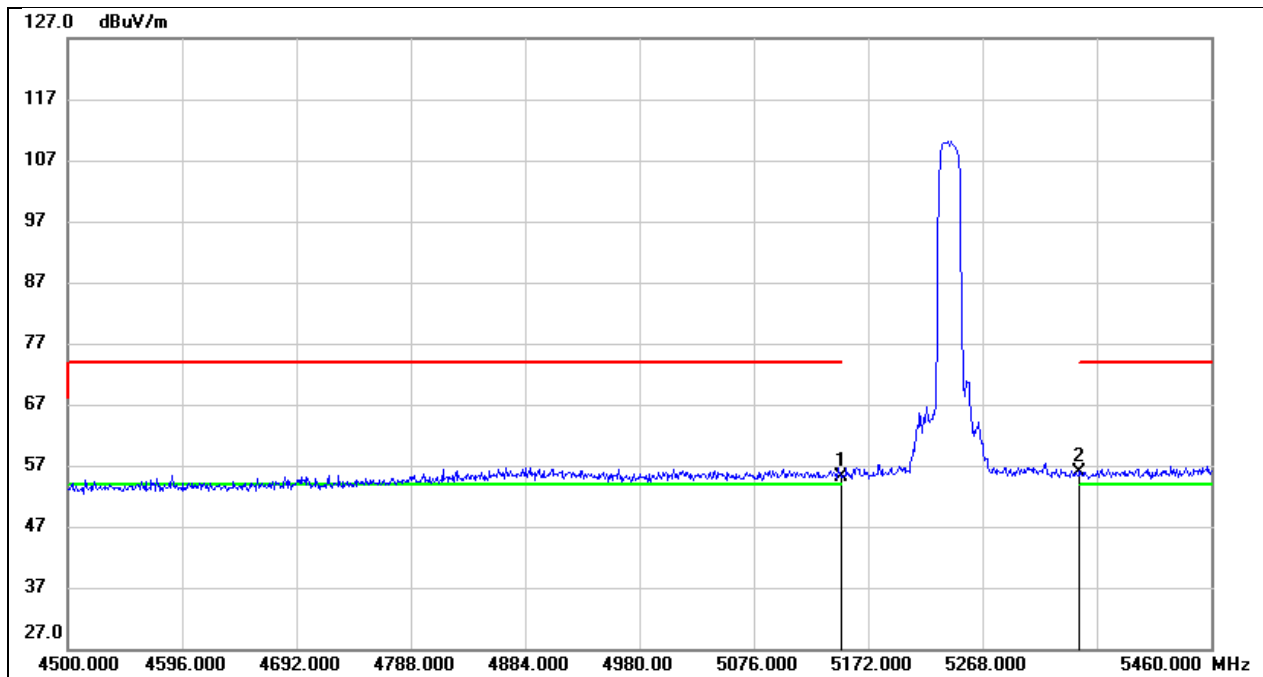

No.	Frequency (MHz)	Reading (dBuV)	Correct (dB/m)	Result (dBuV/m)	Limit (dBuV/m)	Margin (dB)	Remark
1	5150.000	14.91	40.27	55.18	74.00	-18.82	peak
2	5350.000	15.31	40.49	55.80	74.00	-18.20	peak

Test Mode:	802.11a 20 AV	Frequency(MHz):	5240
Polarity:	Vertical	Test Voltage:	DC 12 V

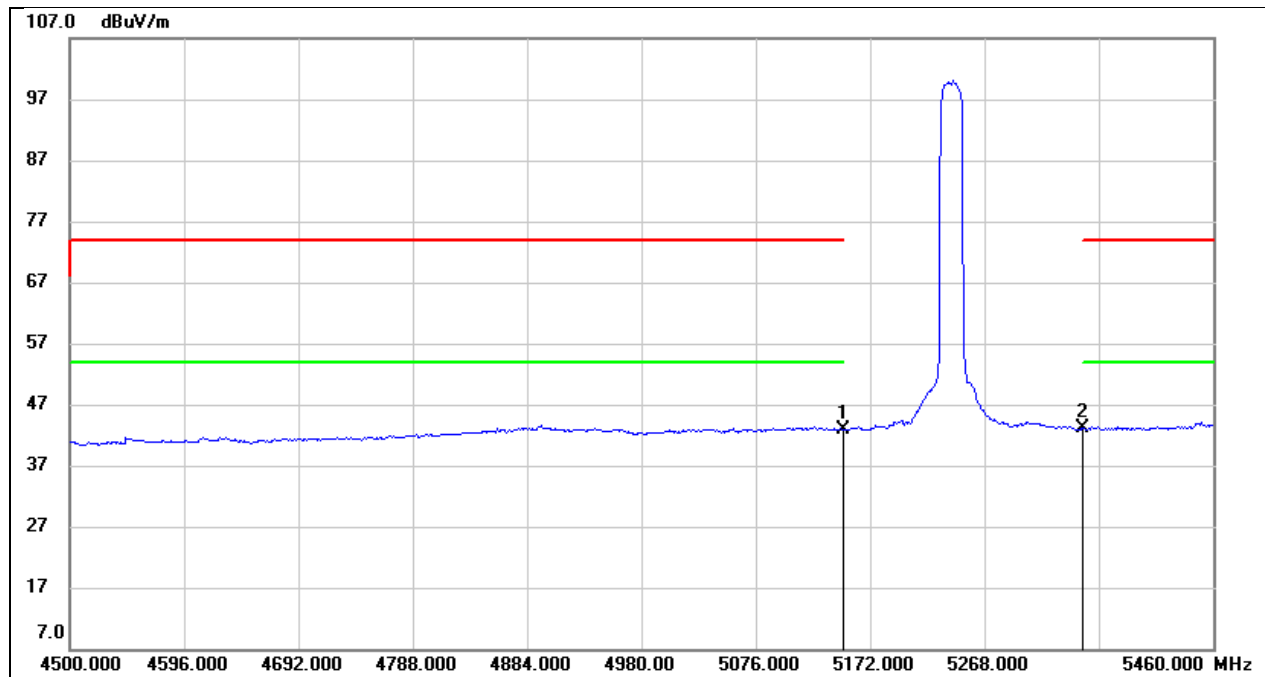

No.	Frequency (MHz)	Reading (dBuV)	Correct (dB/m)	Result (dBuV/m)	Limit (dBuV/m)	Margin (dB)	Remark
1	5150.000	2.52	40.27	42.79	54.00	-11.21	AVG
2	5350.000	2.63	40.49	43.12	54.00	-10.88	AVG

Test Mode:	802.11a 20 PK	Frequency(MHz):	5260
Polarity:	Vertical	Test Voltage:	DC 12 V

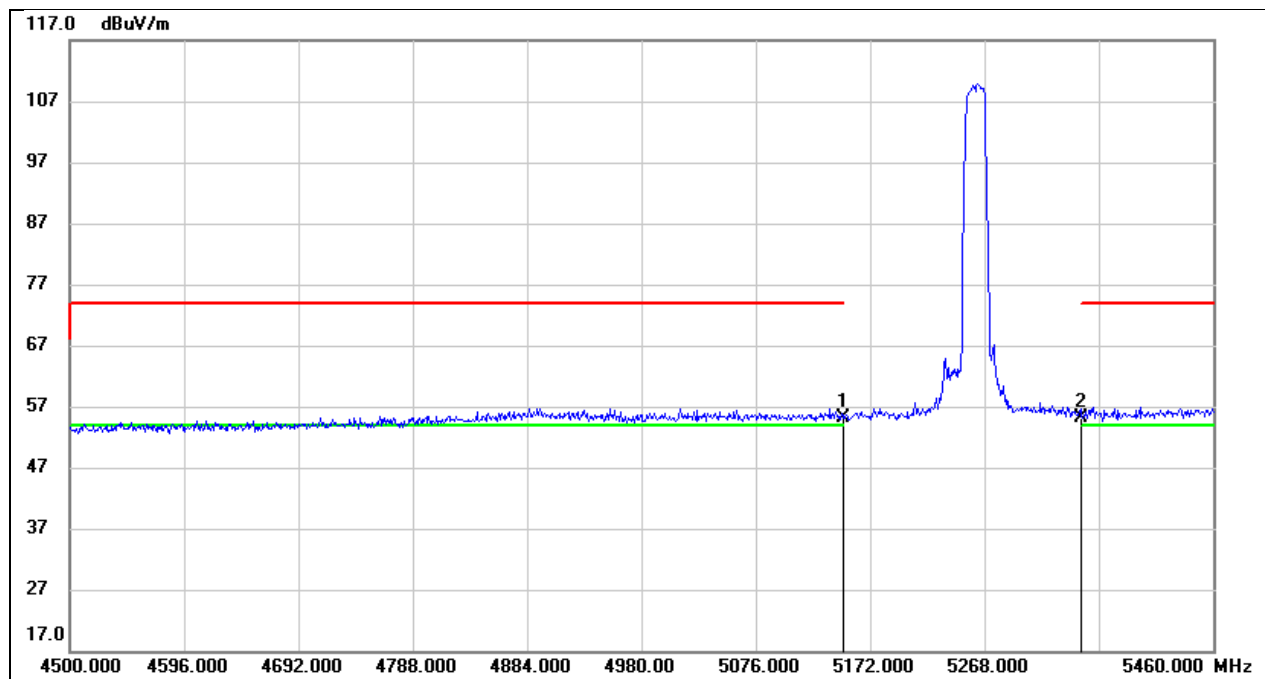

No.	Frequency (MHz)	Reading (dBuV)	Correct (dB/m)	Result (dBuV/m)	Limit (dBuV/m)	Margin (dB)	Remark
1	5150.000	14.91	40.27	55.18	74.00	-18.82	peak
2	5350.000	14.75	40.49	55.24	74.00	-18.76	peak

Test Mode:	802.11a 20 AV	Frequency(MHz):	5260
Polarity:	Vertical	Test Voltage:	DC 12 V

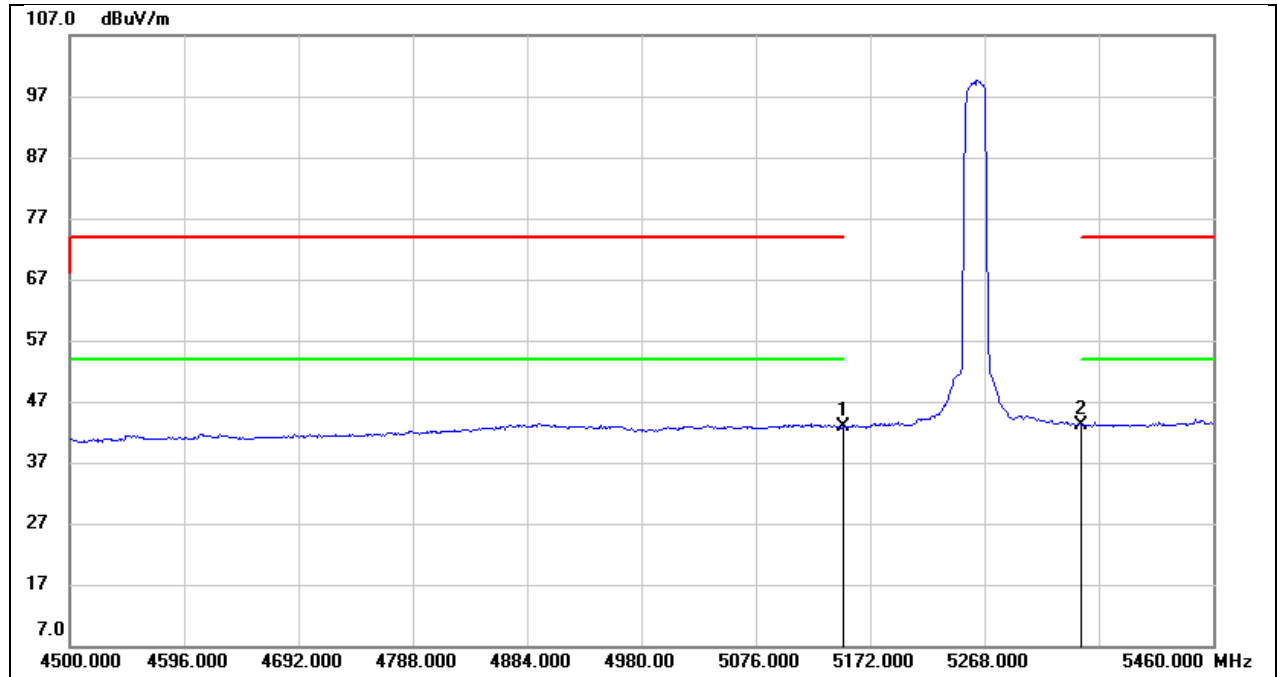

No.	Frequency (MHz)	Reading (dBuV)	Correct (dB/m)	Result (dBuV/m)	Limit (dBuV/m)	Margin (dB)	Remark
1	5150.000	2.53	40.27	42.80	54.00	-11.20	AVG
2	5350.000	2.70	40.49	43.19	54.00	-10.81	AVG

Test Mode:	802.11a 20 PK	Frequency(MHz):	5320
Polarity:	Vertical	Test Voltage:	DC 12 V

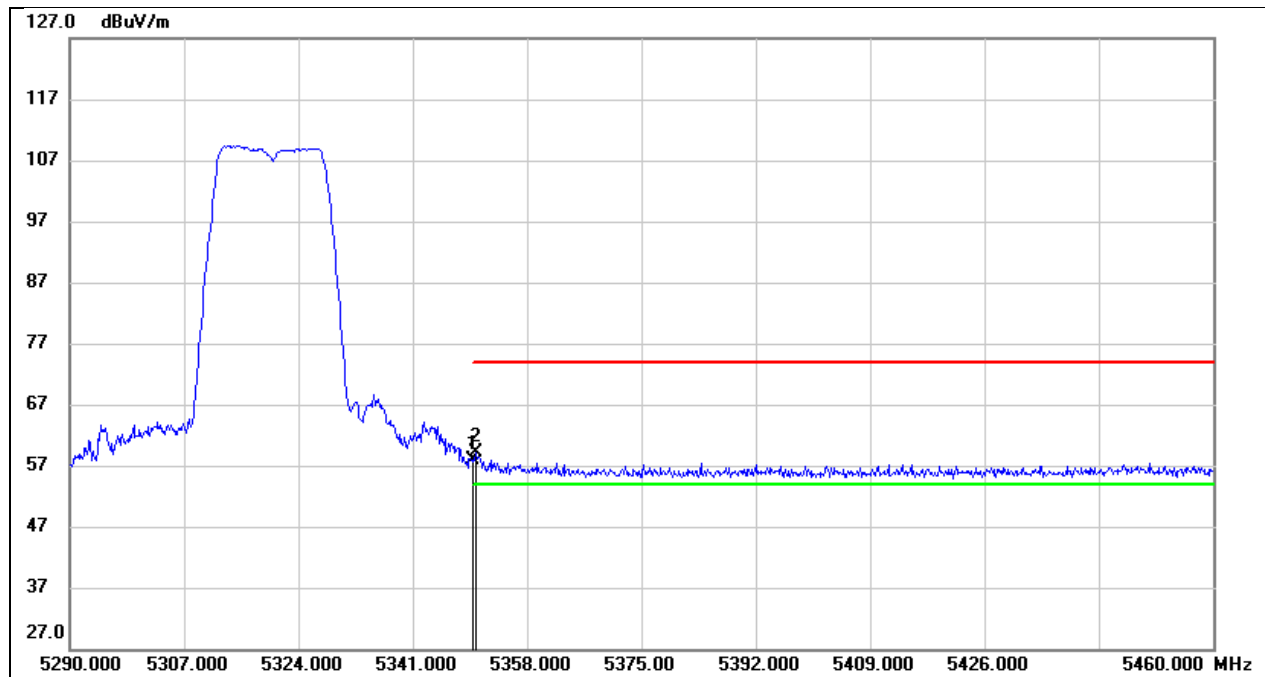

No.	Frequency (MHz)	Reading (dBuV)	Correct (dB/m)	Result (dBuV/m)	Limit (dBuV/m)	Margin (dB)	Remark
1	5350.000	17.51	40.49	58.00	74.00	-16.00	peak
2	5350.350	18.59	40.49	59.08	74.00	-14.92	peak

Test Mode:	802.11a 20 AV	Frequency(MHz):	5320
Polarity:	Vertical	Test Voltage:	DC 12 V

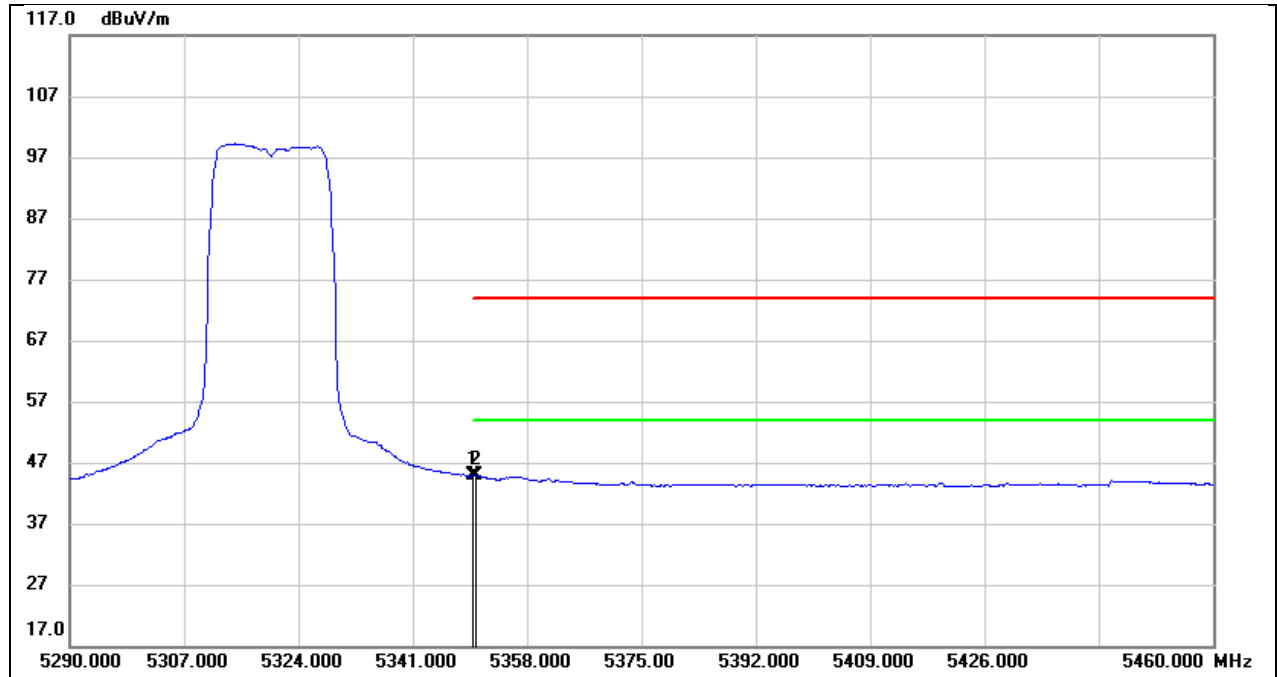

No.	Frequency (MHz)	Reading (dBuV)	Correct (dB/m)	Result (dBuV/m)	Limit (dBuV/m)	Margin (dB)	Remark
1	5350.000	4.30	40.49	44.79	54.00	-9.21	AVG
2	5350.350	4.28	40.49	44.77	54.00	-9.23	AVG

Test Mode:	802.11a 20 PK	Frequency(MHz):	5500
Polarity:	Vertical	Test Voltage:	DC 12 V

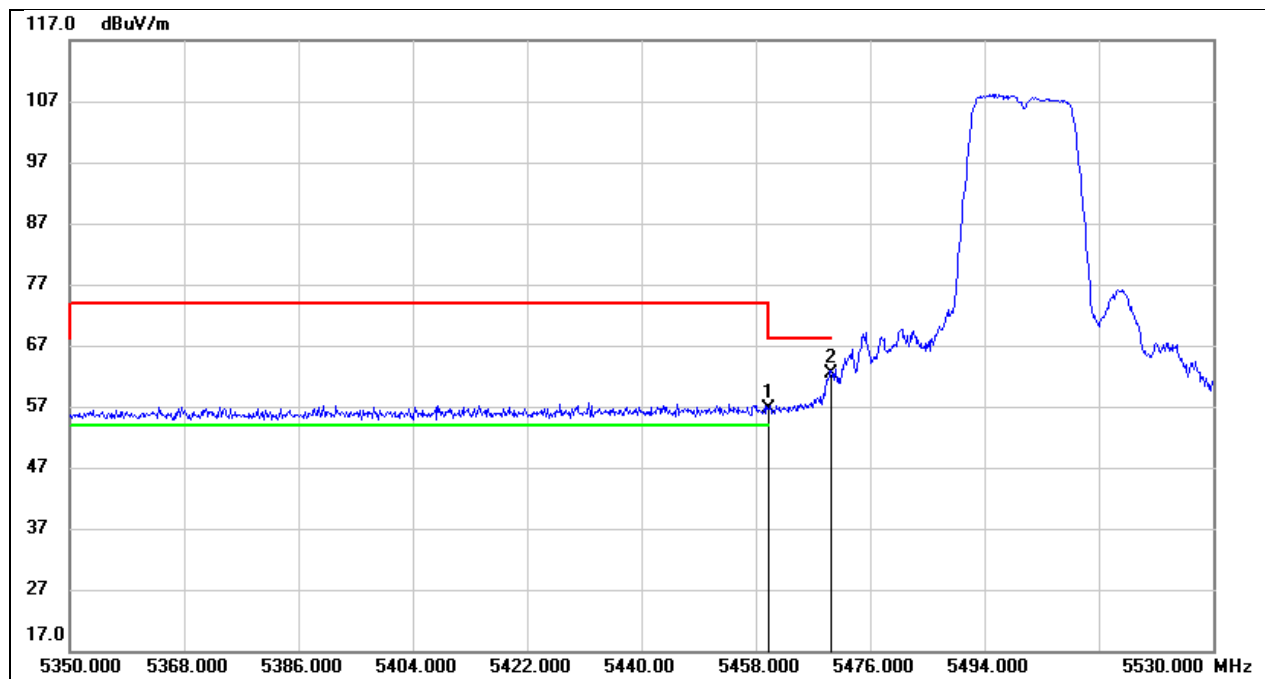

No.	Frequency (MHz)	Reading (dBuV)	Correct (dB/m)	Result (dBuV/m)	Limit (dBuV/m)	Margin (dB)	Remark
1	5460.000	15.97	40.62	56.59	74.00	-17.41	peak
2	5470.000	21.71	40.63	62.34	68.20	-5.86	peak

Test Mode:	802.11a 20 AV	Frequency(MHz):	5500
Polarity:	Vertical	Test Voltage:	DC 12 V

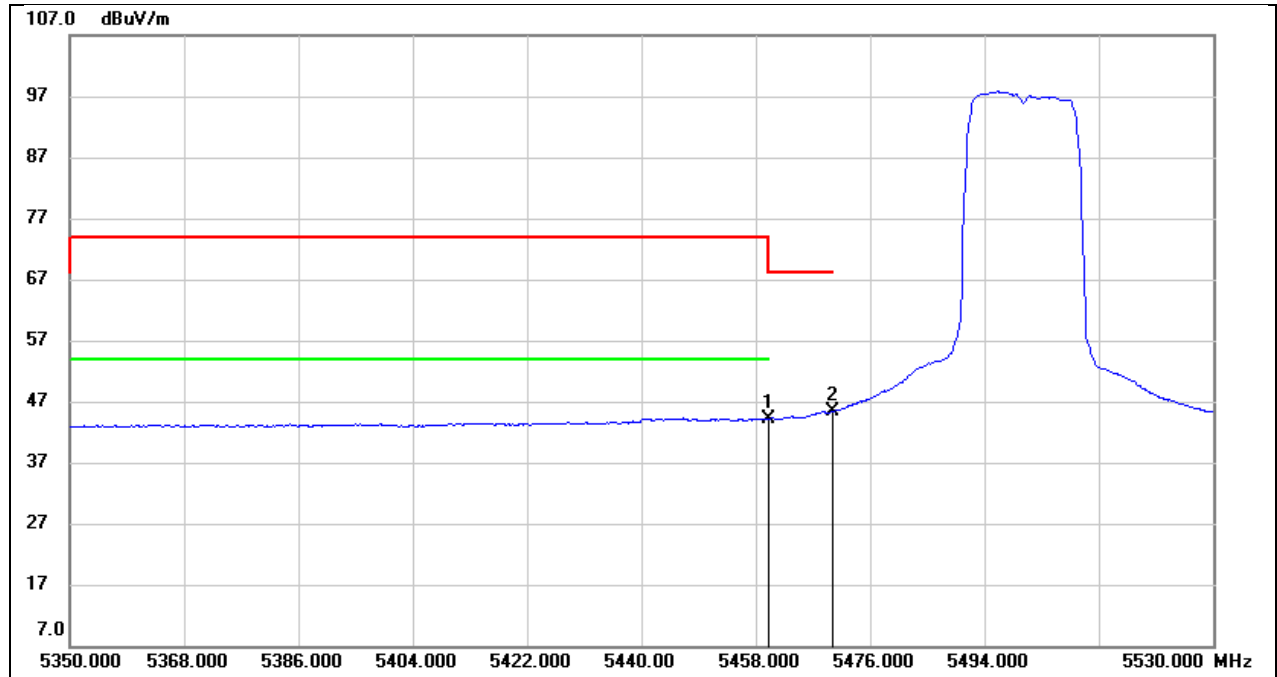

No.	Frequency (MHz)	Reading (dBuV)	Correct (dB/m)	Result (dBuV/m)	Limit (dBuV/m)	Margin (dB)	Remark
1	5460.000	3.58	40.62	44.20	54.00	-9.80	AVG
2	5470.000	4.85	40.63	45.48	/	/	AVG

Test Mode:	802.11a 20 PK	Frequency(MHz):	5700
Polarity:	Vertical	Test Voltage:	DC 12 V

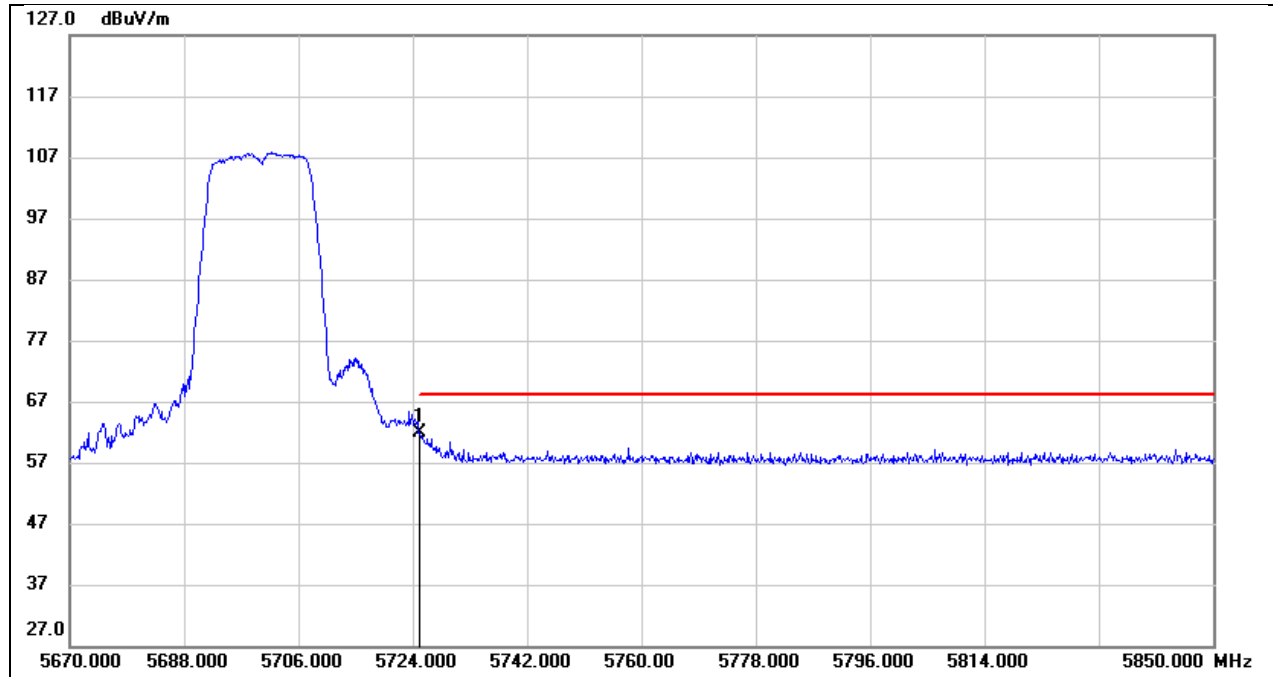

No.	Frequency (MHz)	Reading (dBuV)	Correct (dB/m)	Result (dBuV/m)	Limit (dBuV/m)	Margin (dB)	Remark
1	5725.000	20.70	41.27	61.97	68.20	-6.23	peak

Test Mode:	802.11a 20 PK	Frequency(MHz):	5745
Polarity:	Vertical	Test Voltage:	DC 12 V

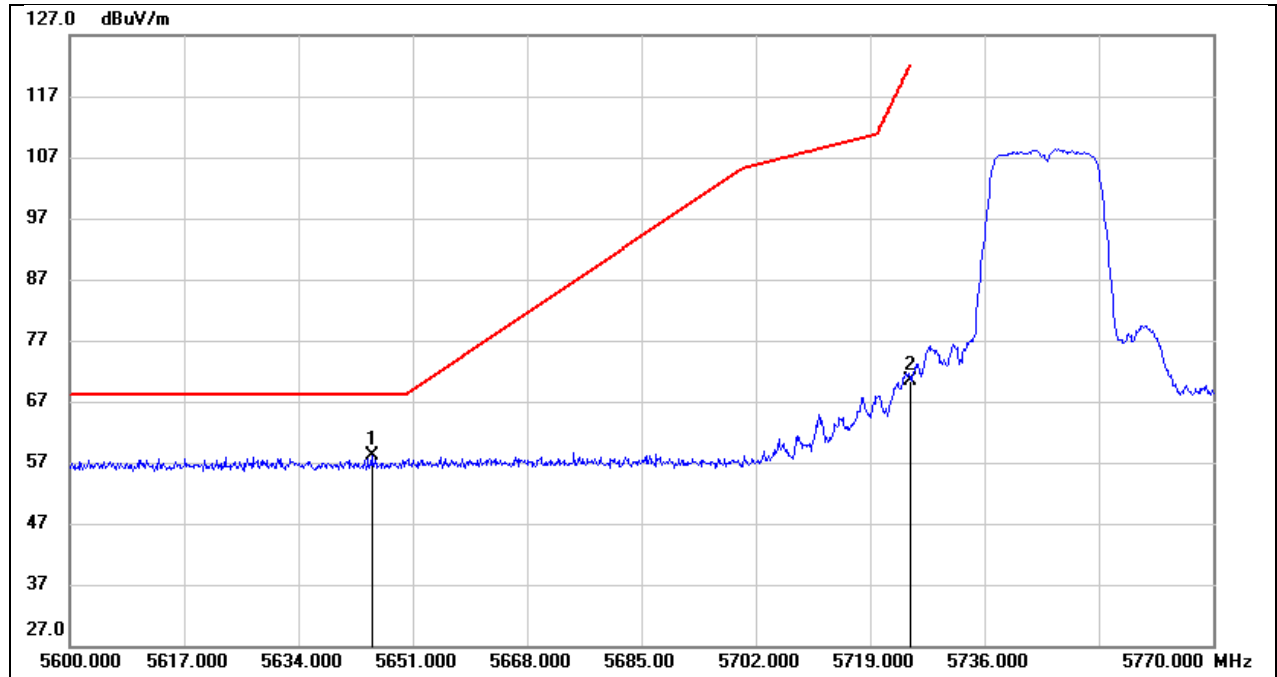

No.	Frequency (MHz)	Reading (dBuV)	Correct (dB/m)	Result (dBuV/m)	Limit (dBuV/m)	Margin (dB)	Remark
1	5644.880	17.01	41.04	58.05	68.20	-10.15	peak
2	5725.000	29.02	41.27	70.29	122.20	-51.91	peak

Test Mode:	802.11a 20 PK	Frequency(MHz):	5825
Polarity:	Vertical	Test Voltage:	DC 12 V

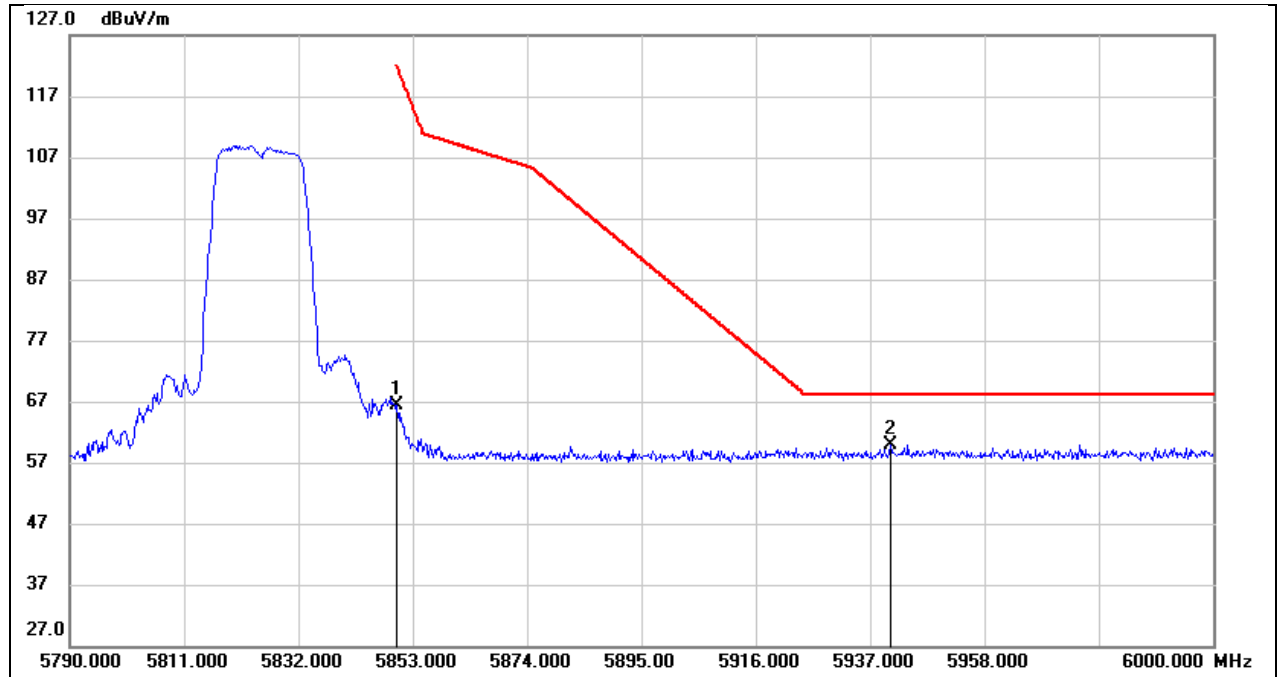

No.	Frequency (MHz)	Reading (dBuV)	Correct (dB/m)	Result (dBuV/m)	Limit (dBuV/m)	Margin (dB)	Remark
1	5850.000	24.70	41.60	66.30	122.20	-55.90	peak
2	5940.780	18.06	41.84	59.90	68.20	-8.30	peak

Test Mode:	802.11n HT20 PK	Frequency(MHz):	5180
Polarity:	Horizontal	Test Voltage:	DC 12 V

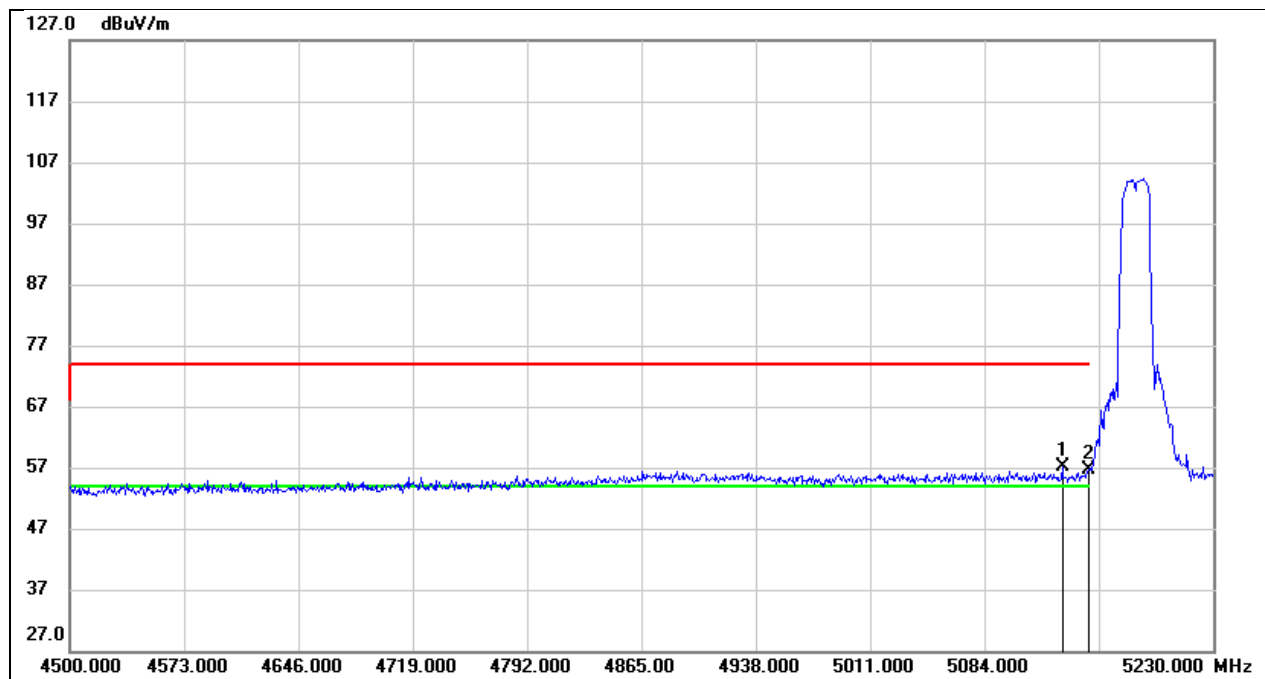

No.	Frequency (MHz)	Reading (dBuV)	Correct (dB/m)	Result (dBuV/m)	Limit (dBuV/m)	Margin (dB)	Remark
1	5133.640	16.91	40.26	57.17	74.00	-16.83	peak
2	5150.000	16.40	40.27	56.67	74.00	-17.33	peak

Test Mode:	802.11n HT20 AV	Frequency(MHz):	5180
Polarity:	Horizontal	Test Voltage:	DC 12 V

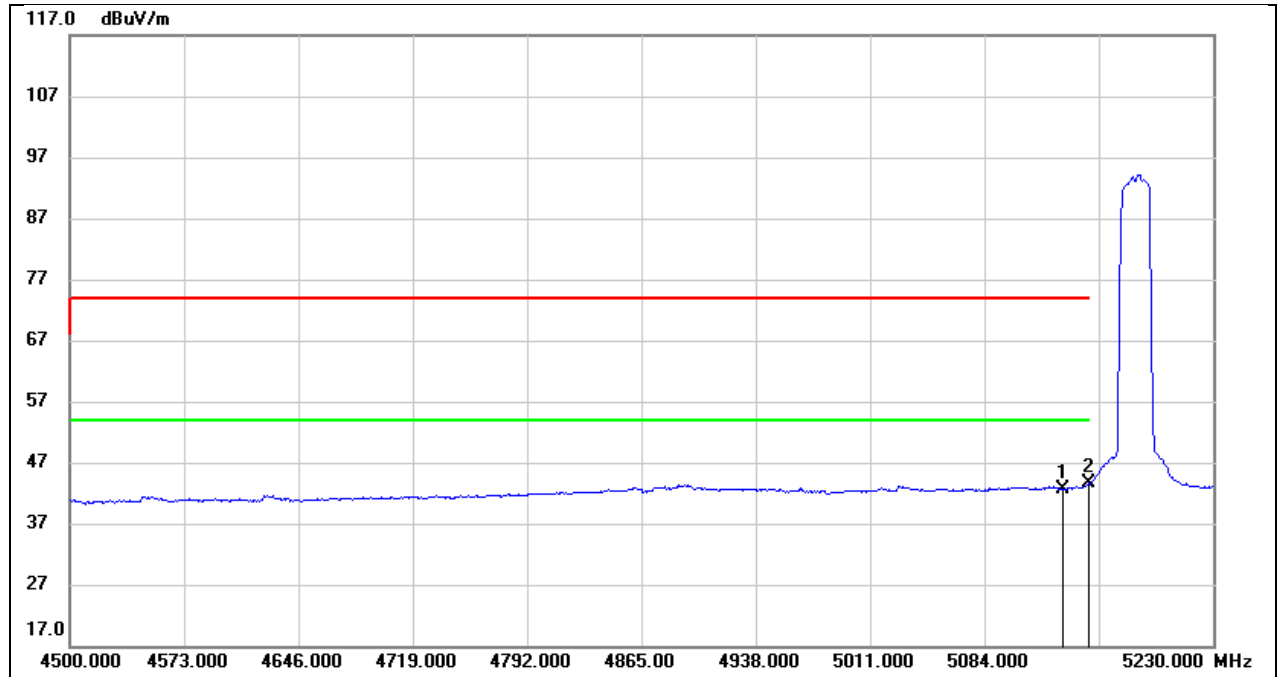

No.	Frequency (MHz)	Reading (dBuV)	Correct (dB/m)	Result (dBuV/m)	Limit (dBuV/m)	Margin (dB)	Remark
1	5133.640	2.41	40.26	42.67	54.00	-11.33	AVG
2	5150.000	3.25	40.27	43.52	54.00	-10.48	AVG

Test Mode:	802.11n HT20 PK	Frequency(MHz):	5240
Polarity:	Horizontal	Test Voltage:	DC 12 V

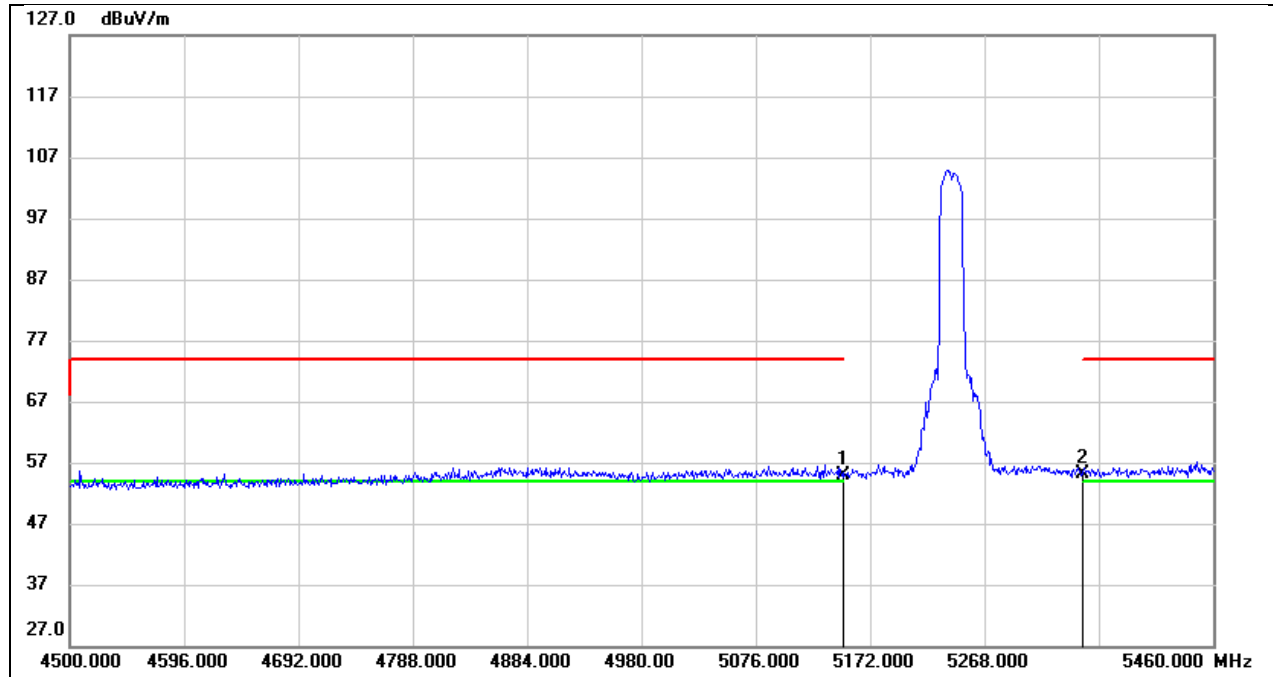

No.	Frequency (MHz)	Reading (dBuV)	Correct (dB/m)	Result (dBuV/m)	Limit (dBuV/m)	Margin (dB)	Remark
1	5150.000	14.71	40.27	54.98	74.00	-19.02	peak
2	5350.000	14.63	40.49	55.12	74.00	-18.88	peak

Test Mode:	802.11n HT20 AV	Frequency(MHz):	5240
Polarity:	Horizontal	Test Voltage:	DC 12 V

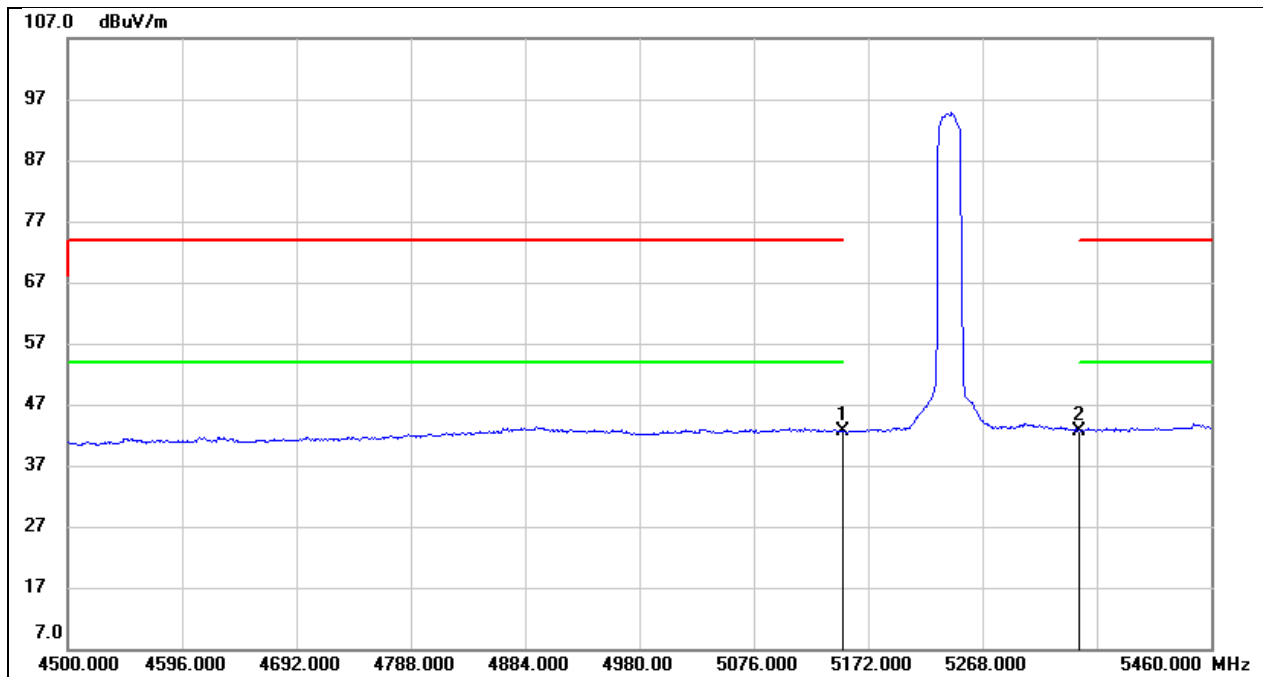

No.	Frequency (MHz)	Reading (dBuV)	Correct (dB/m)	Result (dBuV/m)	Limit (dBuV/m)	Margin (dB)	Remark
1	5150.000	2.29	40.27	42.56	54.00	-11.44	AVG
2	5350.000	2.25	40.49	42.74	54.00	-11.26	AVG

Test Mode:	802.11n HT20 PK	Frequency(MHz):	5260
Polarity:	Horizontal	Test Voltage:	DC 12 V

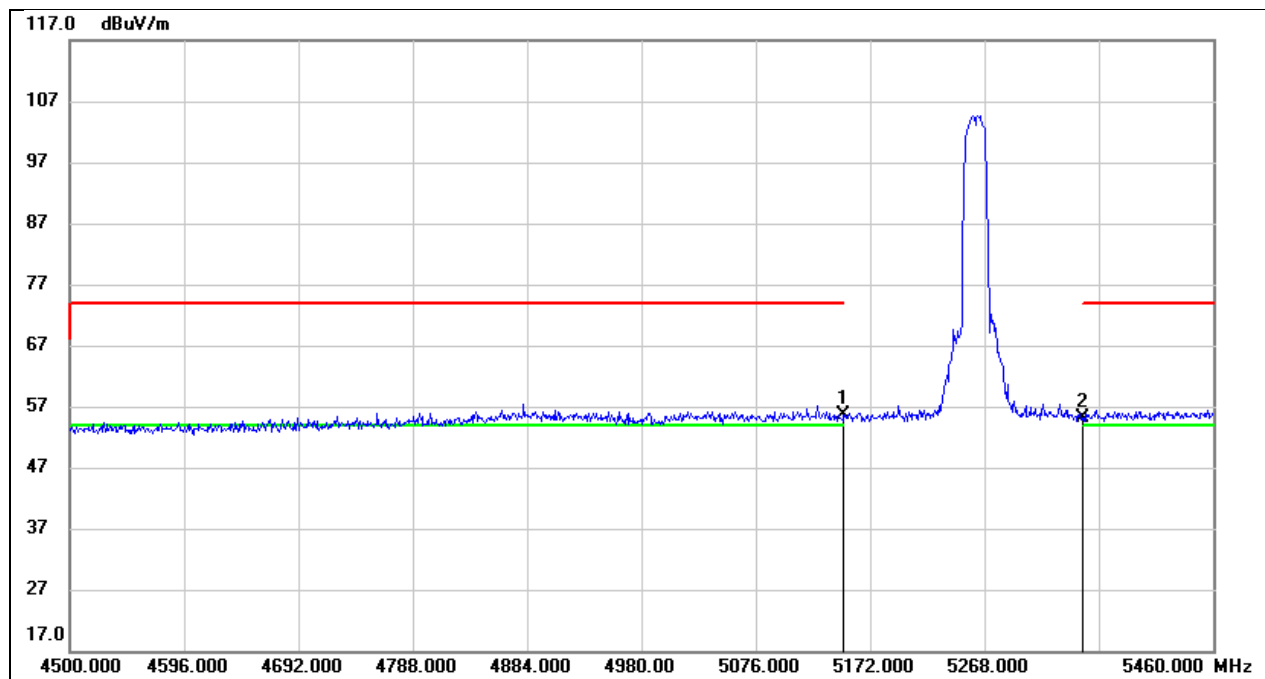

No.	Frequency (MHz)	Reading (dBuV)	Correct (dB/m)	Result (dBuV/m)	Limit (dBuV/m)	Margin (dB)	Remark
1	5150.000	15.25	40.27	55.52	74.00	-18.48	peak
2	5350.000	14.64	40.49	55.13	74.00	-18.87	peak

Test Mode:	802.11n HT20 AV	Frequency(MHz):	5260
Polarity:	Horizontal	Test Voltage:	DC 12 V

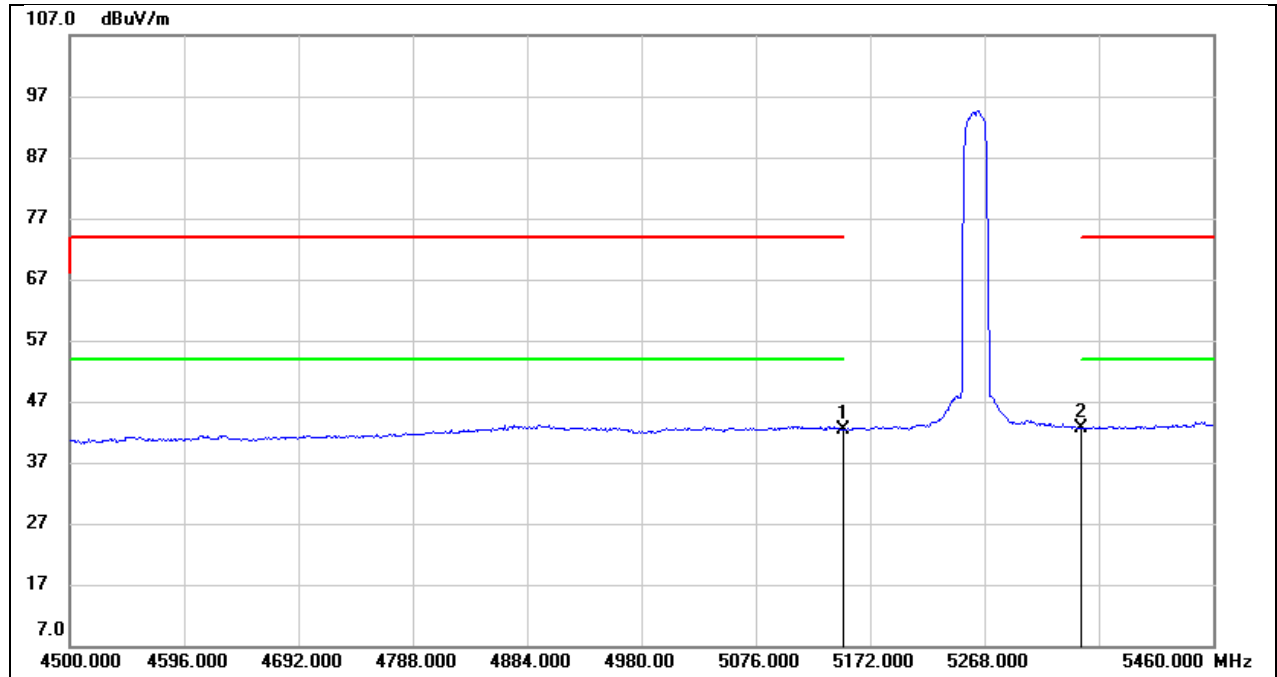

No.	Frequency (MHz)	Reading (dBuV)	Correct (dB/m)	Result (dBuV/m)	Limit (dBuV/m)	Margin (dB)	Remark
1	5150.000	2.06	40.27	42.33	54.00	-11.67	AVG
2	5350.000	2.15	40.49	42.64	54.00	-11.36	AVG

Test Mode:	802.11n HT20 PK	Frequency(MHz):	5320
Polarity:	Horizontal	Test Voltage:	DC 12 V

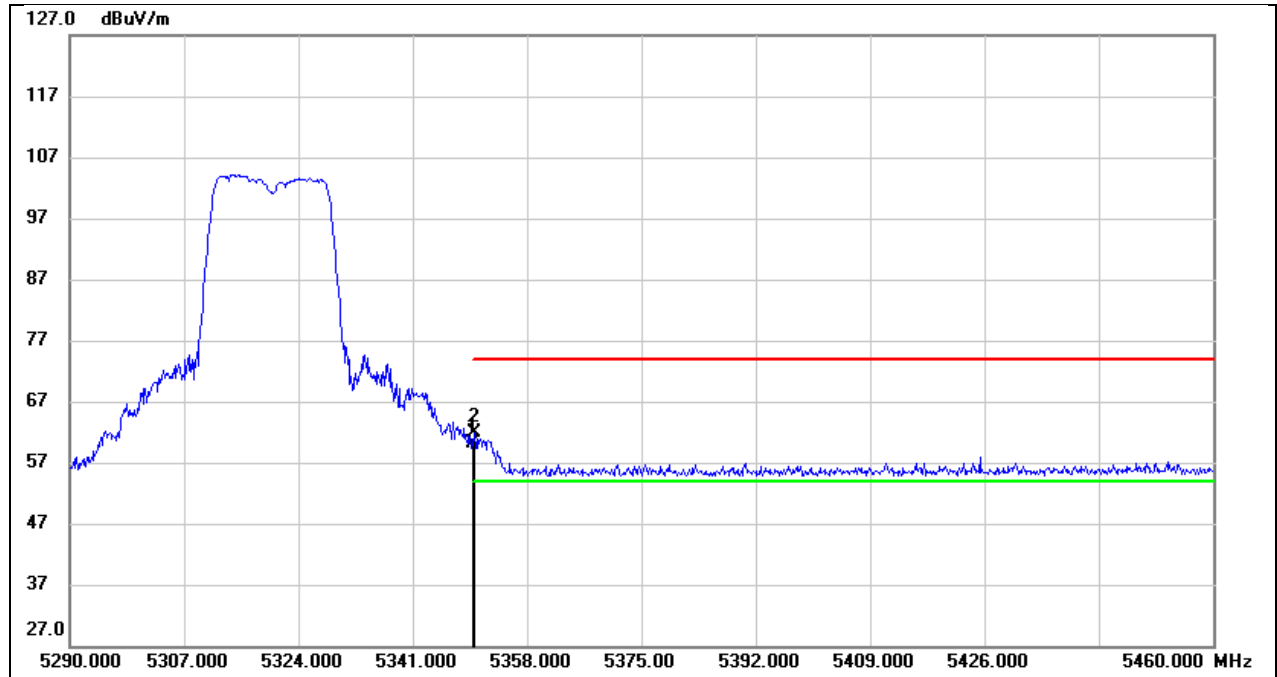

No.	Frequency (MHz)	Reading (dBuV)	Correct (dB/m)	Result (dBuV/m)	Limit (dBuV/m)	Margin (dB)	Remark
1	5350.000	19.61	40.49	60.10	74.00	-13.90	peak
2	5350.180	21.50	40.49	61.99	74.00	-12.01	peak

Test Mode:	802.11n HT20 AV	Frequency(MHz):	5320
Polarity:	Horizontal	Test Voltage:	DC 12 V

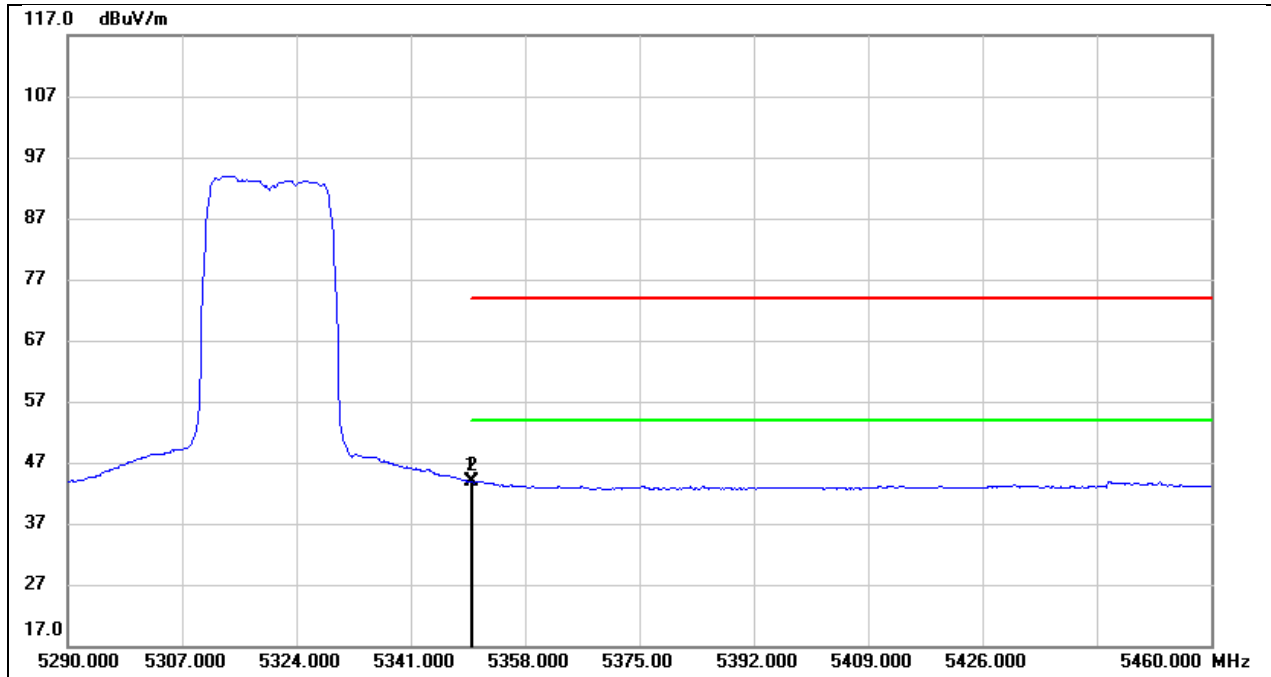

No.	Frequency (MHz)	Reading (dBuV)	Correct (dB/m)	Result (dBuV/m)	Limit (dBuV/m)	Margin (dB)	Remark
1	5350.000	3.36	40.49	43.85	54.00	-10.15	AVG
2	5350.180	3.32	40.49	43.81	54.00	-10.19	AVG

Test Mode:	802.11n HT20 PK	Frequency(MHz):	5500
Polarity:	Vertical	Test Voltage:	DC 12 V

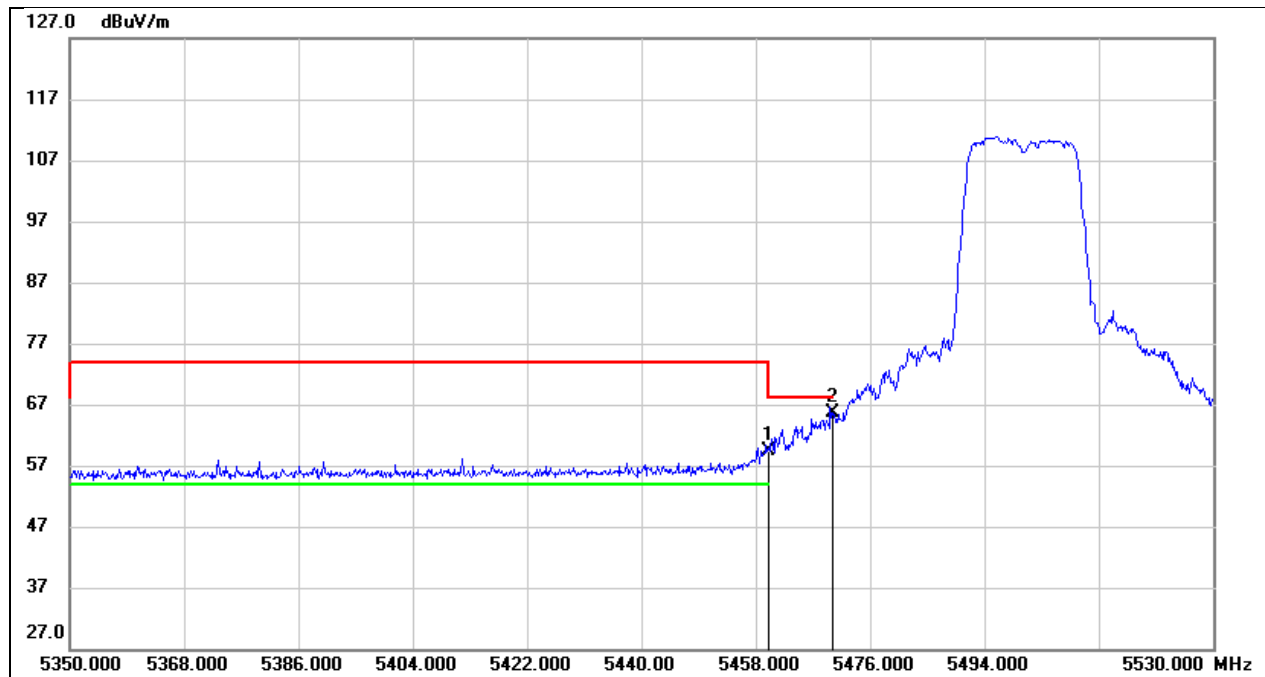

No.	Frequency (MHz)	Reading (dBuV)	Correct (dB/m)	Result (dBuV/m)	Limit (dBuV/m)	Margin (dB)	Remark
1	5460.000	18.84	40.62	59.46	74.00	-14.54	peak
2	5470.000	24.93	40.63	65.56	68.20	-2.64	peak

Test Mode:	802.11n HT20 AV	Frequency(MHz):	5500
Polarity:	Vertical	Test Voltage:	DC 12 V

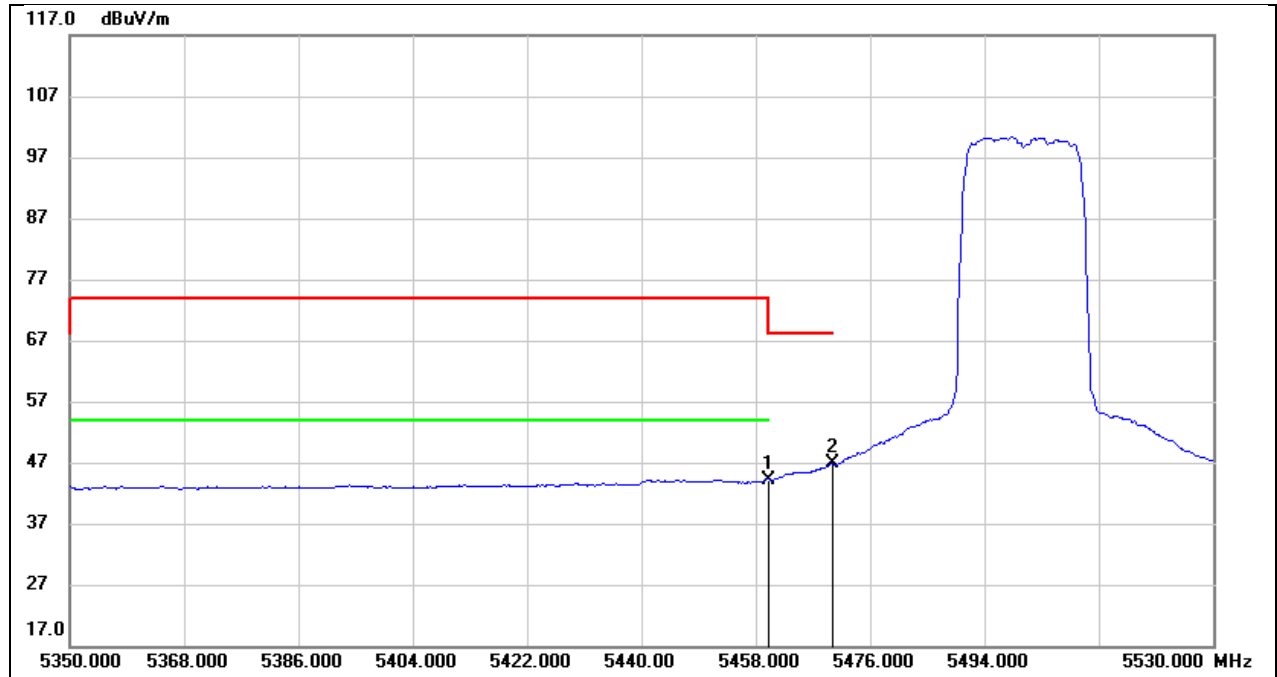

No.	Frequency (MHz)	Reading (dBuV)	Correct (dB/m)	Result (dBuV/m)	Limit (dBuV/m)	Margin (dB)	Remark
1	5460.000	3.58	40.62	44.20	54.00	-9.80	AVG
2	5470.000	6.22	40.63	46.85	/	/	AVG

Test Mode:	802.11n HT20 PK	Frequency(MHz):	5700
Polarity:	Vertical	Test Voltage:	DC 12 V

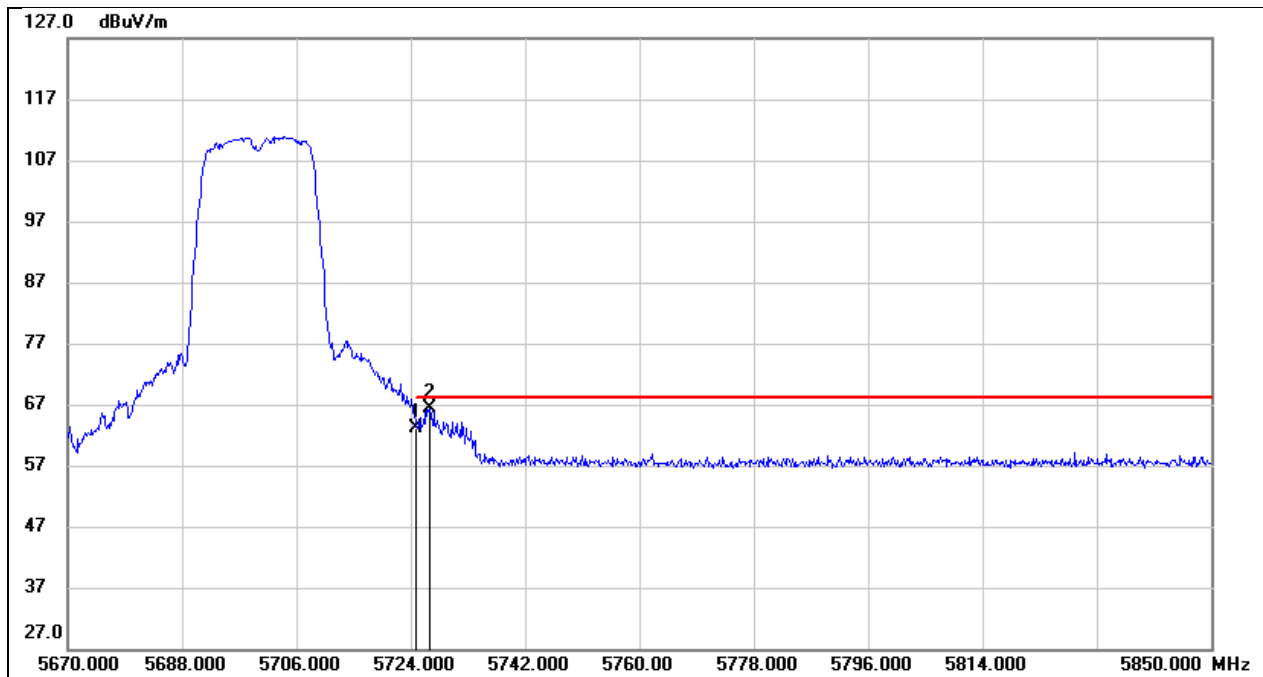

No.	Frequency (MHz)	Reading (dBuV)	Correct (dB/m)	Result (dBuV/m)	Limit (dBuV/m)	Margin (dB)	Remark
1	5725.000	21.88	41.27	63.15	68.20	-5.05	peak
2	5726.880	25.05	41.27	66.32	68.20	-1.88	peak

Test Mode:	802.11n HT20 PK	Frequency(MHz):	5745
Polarity:	Vertical	Test Voltage:	DC 12 V

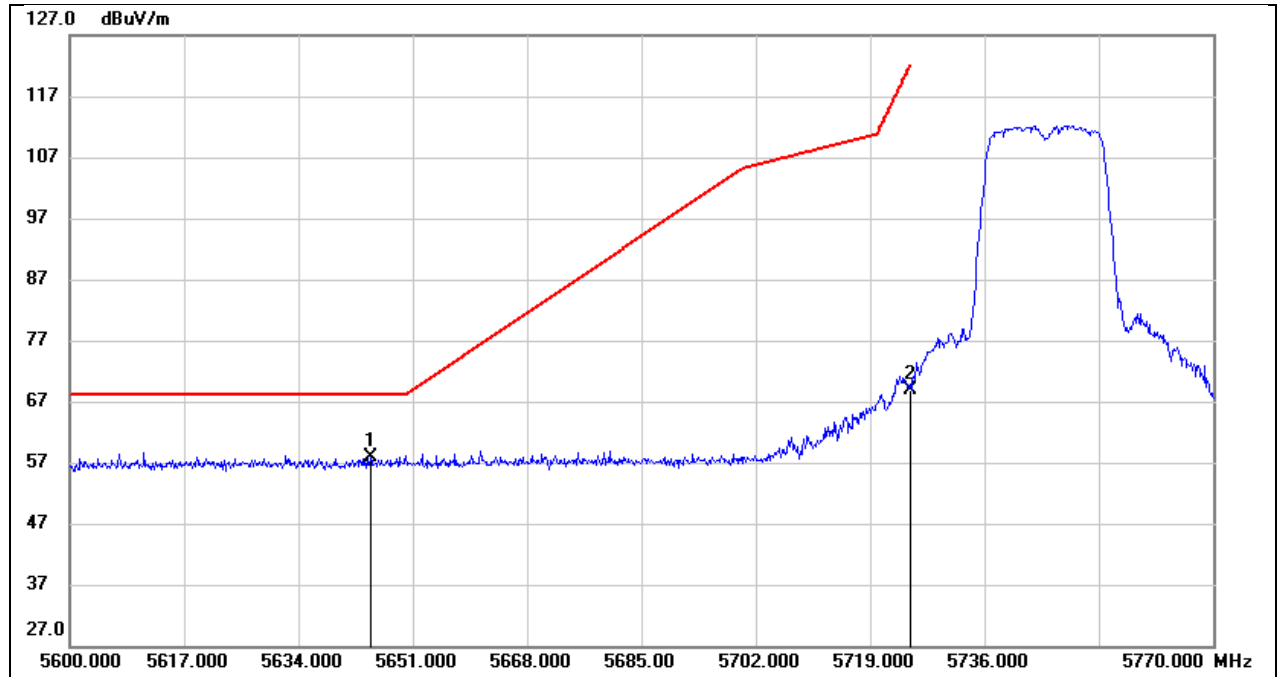

No.	Frequency (MHz)	Reading (dBuV)	Correct (dB/m)	Result (dBuV/m)	Limit (dBuV/m)	Margin (dB)	Remark
1	5644.710	16.92	41.04	57.96	68.20	-10.24	peak
2	5725.000	27.54	41.27	68.81	122.20	-53.39	peak

Test Mode:	802.11n HT20 PK	Frequency(MHz):	5825
Polarity:	Vertical	Test Voltage:	DC 12 V

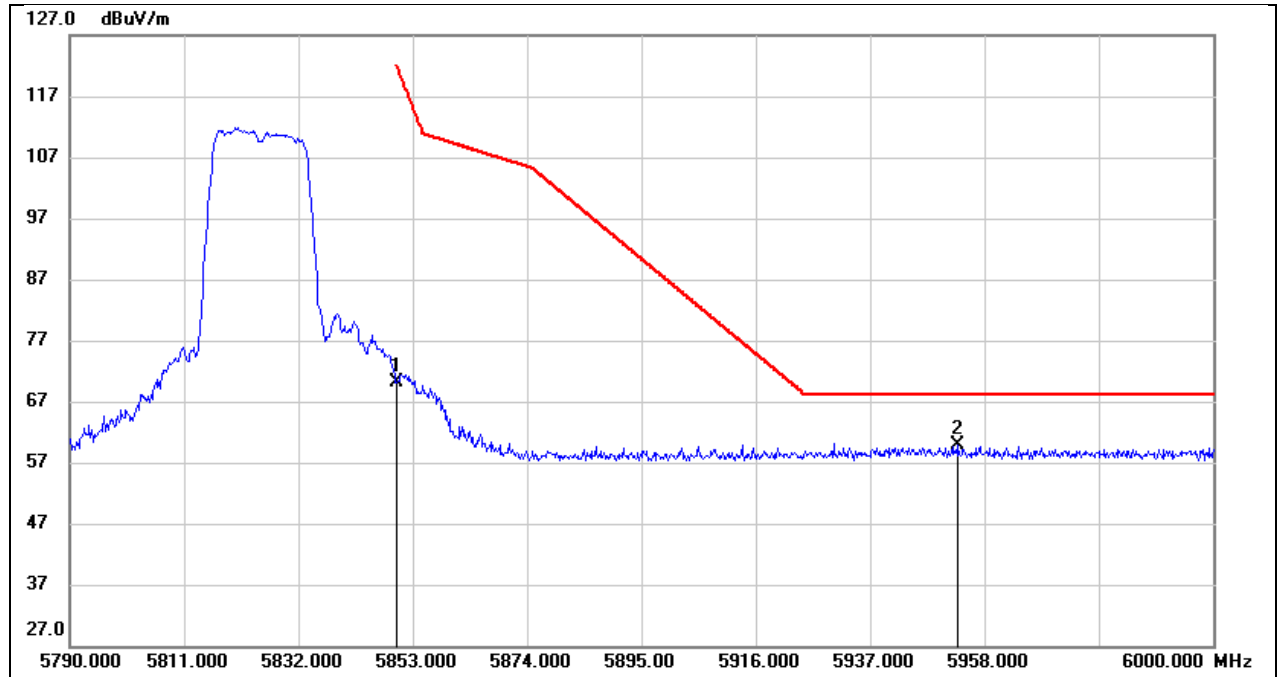

No.	Frequency (MHz)	Reading (dBuV)	Correct (dB/m)	Result (dBuV/m)	Limit (dBuV/m)	Margin (dB)	Remark
1	5850.000	28.52	41.60	70.12	122.20	-52.08	peak
2	5953.170	17.93	41.87	59.80	68.20	-8.40	peak

Test Mode:	802.11n HT40 PK	Frequency(MHz):	5190
Polarity:	Vertical	Test Voltage:	DC 12 V

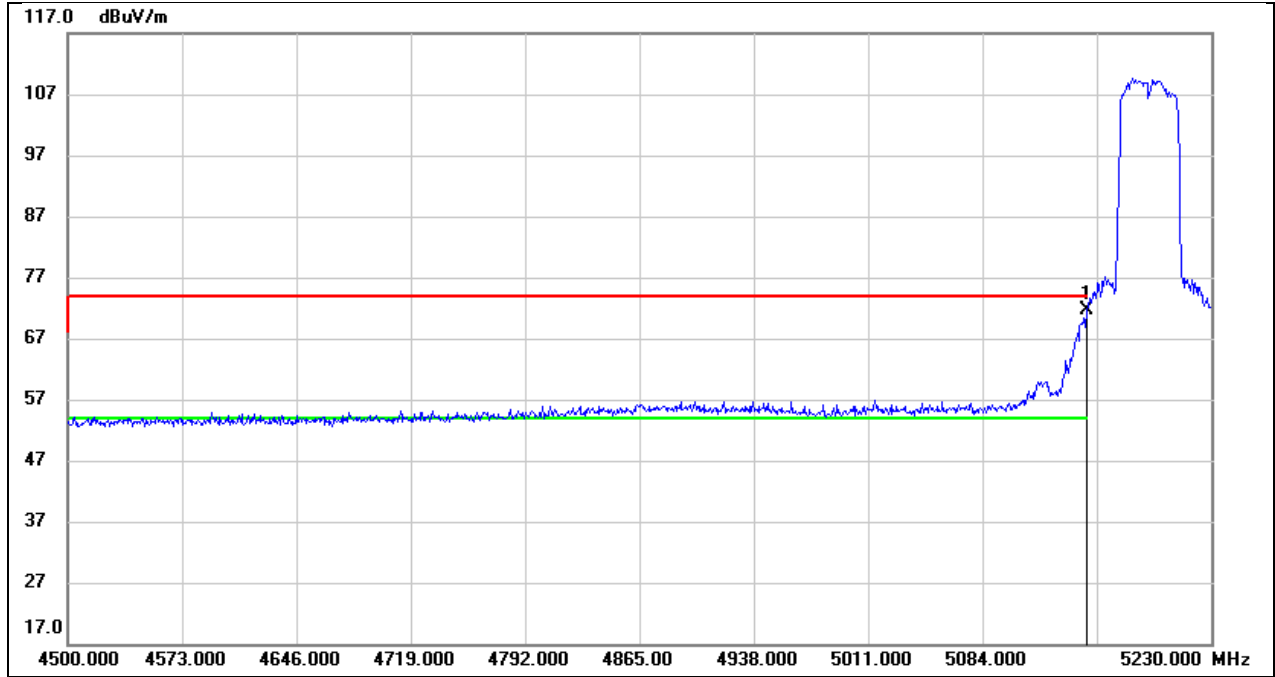

No.	Frequency (MHz)	Reading (dBuV)	Correct (dB/m)	Result (dBuV/m)	Limit (dBuV/m)	Margin (dB)	Remark
1	5150.000	31.37	40.27	71.64	74.00	-2.36	peak

Test Mode:	802.11n HT40 AV	Frequency(MHz):	5190
Polarity:	Vertical	Test Voltage:	DC 12 V

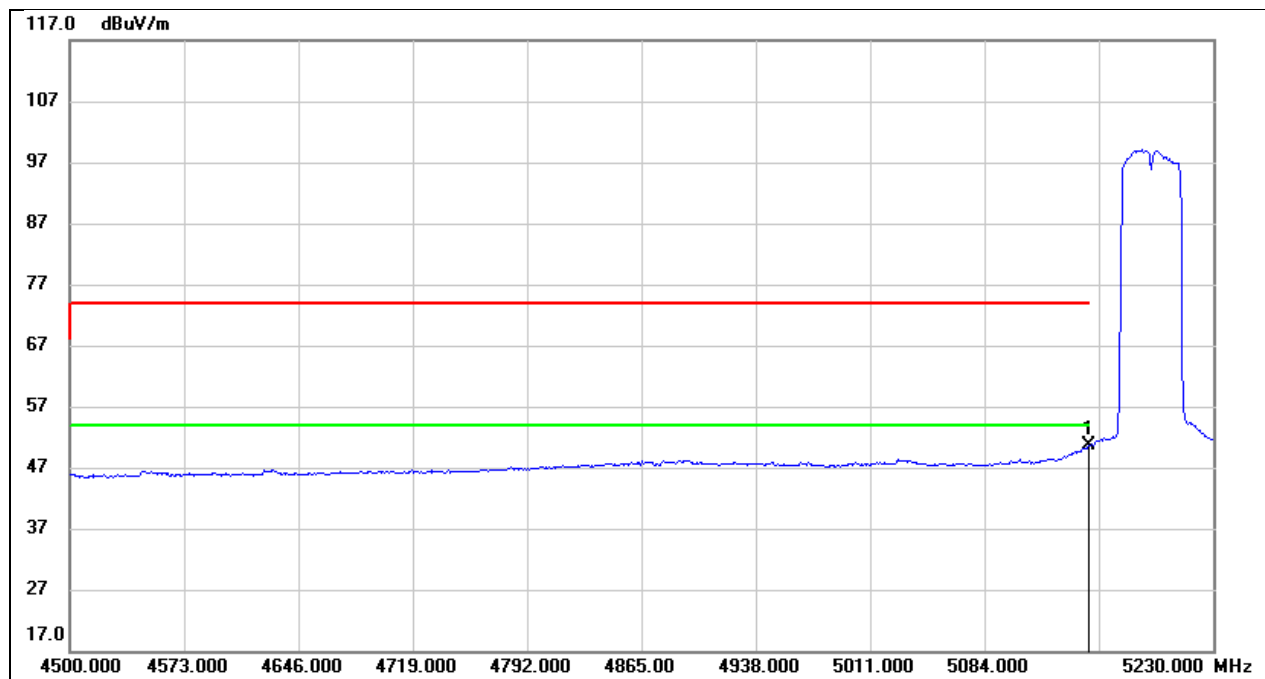

No.	Frequency (MHz)	Reading (dBuV)	Correct (dB/m)	Result (dBuV/m)	Limit (dBuV/m)	Margin (dB)	Remark
1	5150.000	10.25	40.27	50.52	54.00	-3.48	AVG

Test Mode:	802.11n HT40 PK	Frequency(MHz):	5230
Polarity:	Vertical	Test Voltage:	DC 12 V

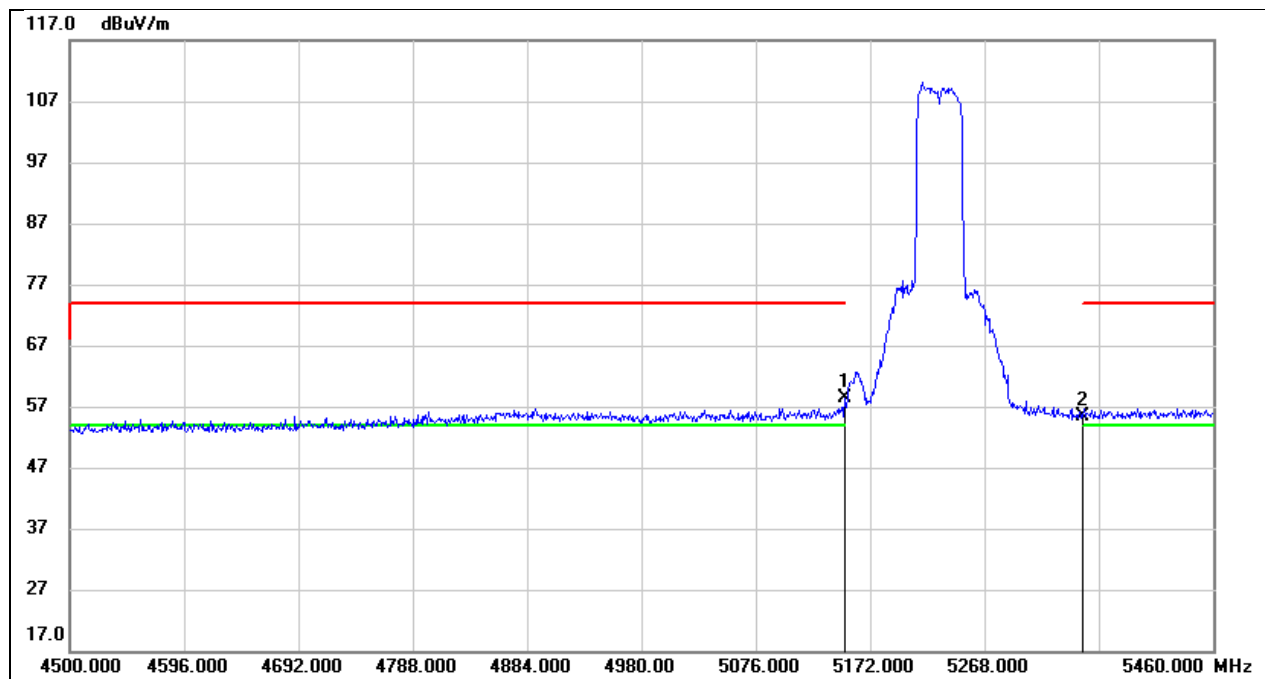

No.	Frequency (MHz)	Reading (dBuV)	Correct (dB/m)	Result (dBuV/m)	Limit (dBuV/m)	Margin (dB)	Remark
1	5150.000	18.10	40.27	58.37	74.00	-15.63	peak
2	5350.000	14.97	40.49	55.46	74.00	-18.54	peak

Test Mode:	802.11n HT40 AV	Frequency(MHz):	5230
Polarity:	Vertical	Test Voltage:	DC 12 V

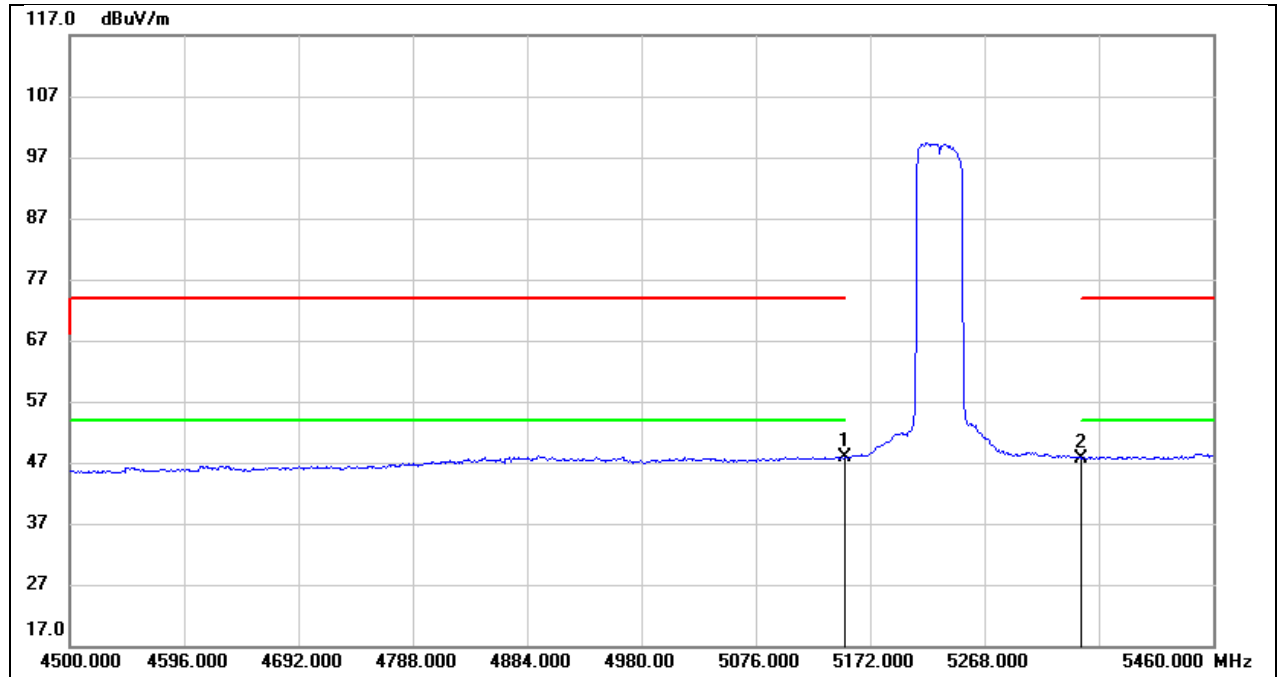

No.	Frequency (MHz)	Reading (dBuV)	Correct (dB/m)	Result (dBuV/m)	Limit (dBuV/m)	Margin (dB)	Remark
1	5150.000	7.52	40.27	47.79	54.00	-6.21	AVG
2	5350.000	7.17	40.49	47.66	54.00	-6.34	AVG

Test Mode:	802.11n HT40 PK	Frequency(MHz):	5270
Polarity:	Vertical	Test Voltage:	DC 12 V

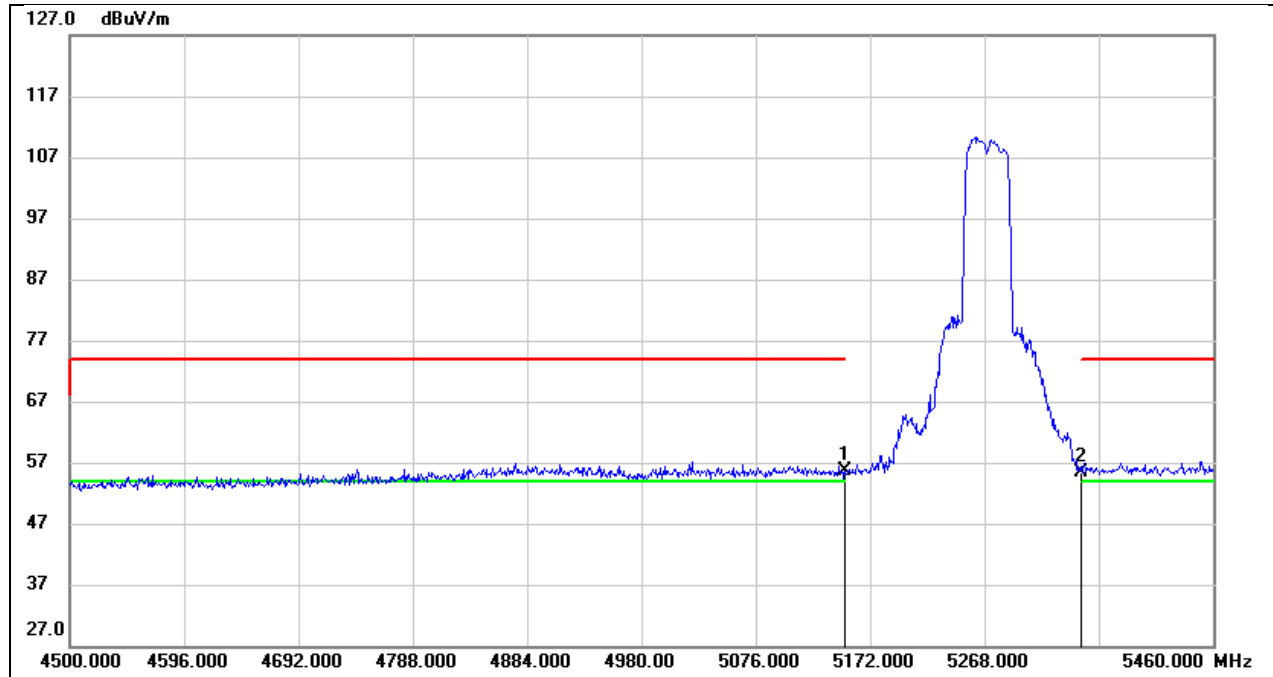

No.	Frequency (MHz)	Reading (dBuV)	Correct (dB/m)	Result (dBuV/m)	Limit (dBuV/m)	Margin (dB)	Remark
1	5150.000	15.28	40.27	55.55	74.00	-18.45	peak
2	5350.000	14.77	40.49	55.26	74.00	-18.74	peak

Test Mode:	802.11n HT40 AV	Frequency(MHz):	5270
Polarity:	Vertical	Test Voltage:	DC 12 V

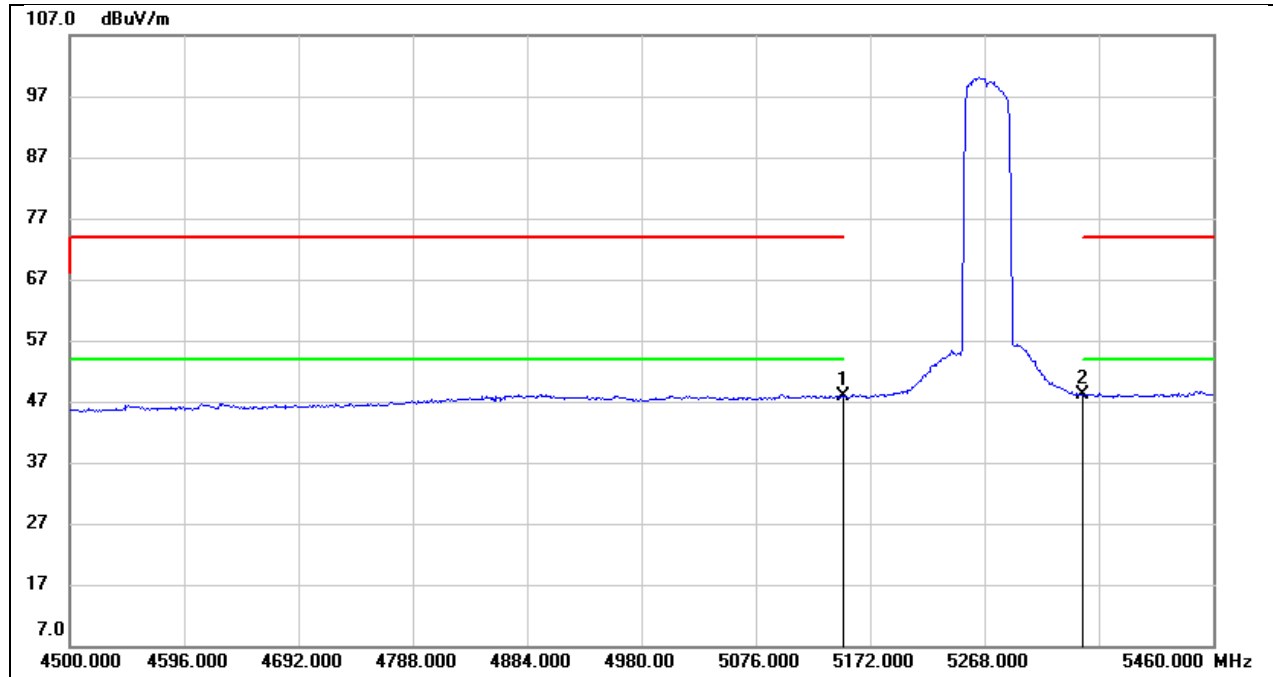

No.	Frequency (MHz)	Reading (dBuV)	Correct (dB/m)	Result (dBuV/m)	Limit (dBuV/m)	Margin (dB)	Remark
1	5150.000	7.49	40.27	47.76	54.00	-6.24	AVG
2	5350.000	7.62	40.49	48.11	54.00	-5.89	AVG

Test Mode:	802.11n HT40 PK	Frequency(MHz):	5310
Polarity:	Vertical	Test Voltage:	DC 12 V

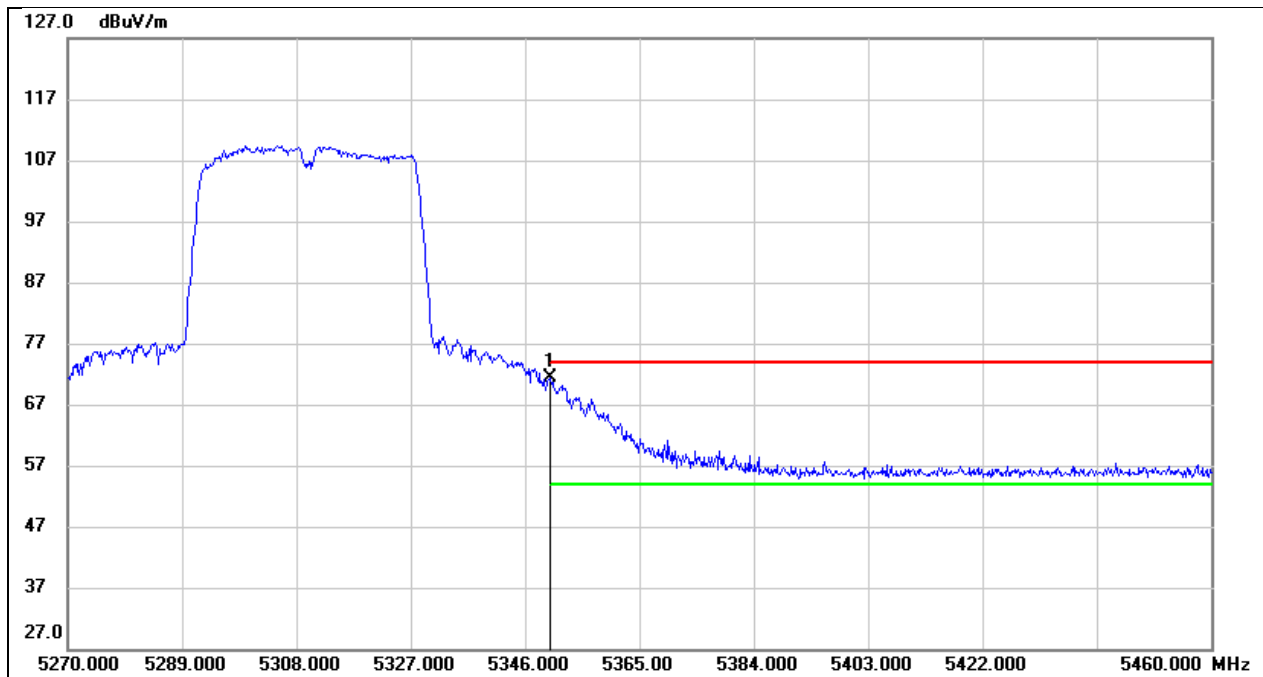

No.	Frequency (MHz)	Reading (dBuV)	Correct (dB/m)	Result (dBuV/m)	Limit (dBuV/m)	Margin (dB)	Remark
1	5350.000	30.89	40.49	71.38	74.00	-2.62	peak

Test Mode:	802.11n HT40 AV	Frequency(MHz):	5310
Polarity:	Vertical	Test Voltage:	DC 12 V

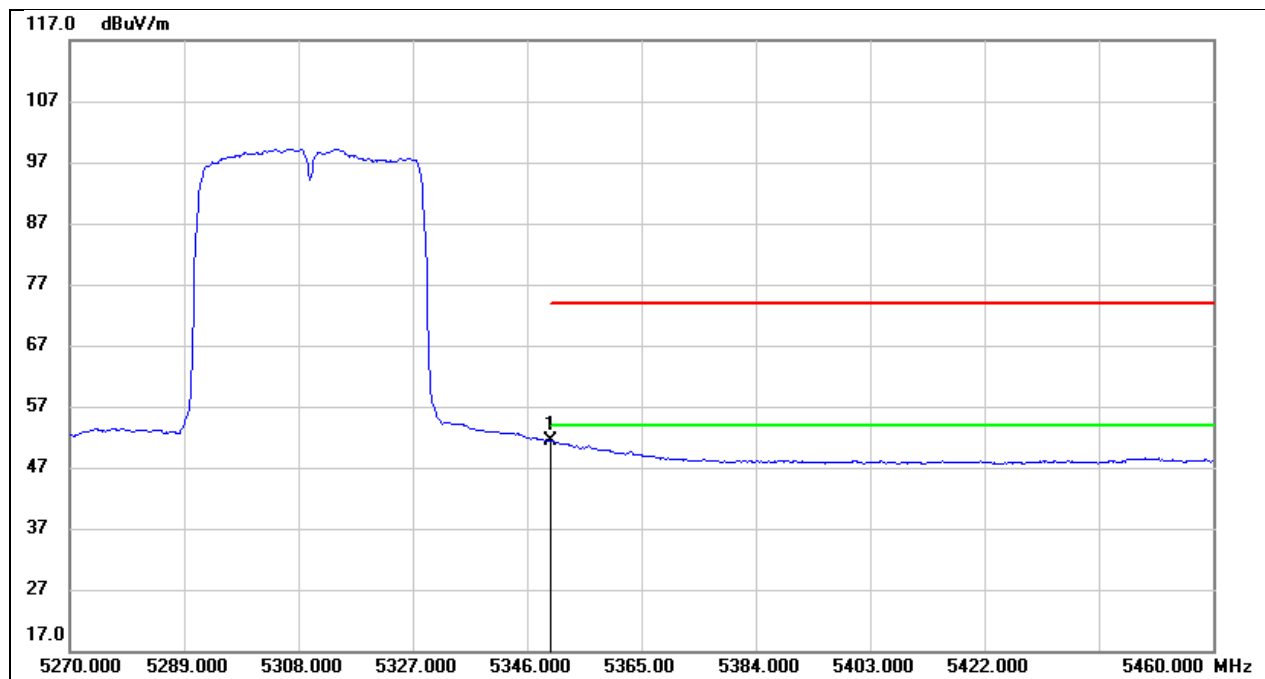

No.	Frequency (MHz)	Reading (dBuV)	Correct (dB/m)	Result (dBuV/m)	Limit (dBuV/m)	Margin (dB)	Remark
1	5350.000	10.95	40.49	51.44	54.00	-2.56	AVG

Test Mode:	802.11n HT40 PK	Frequency(MHz):	5510
Polarity:	Vertical	Test Voltage:	DC 12 V

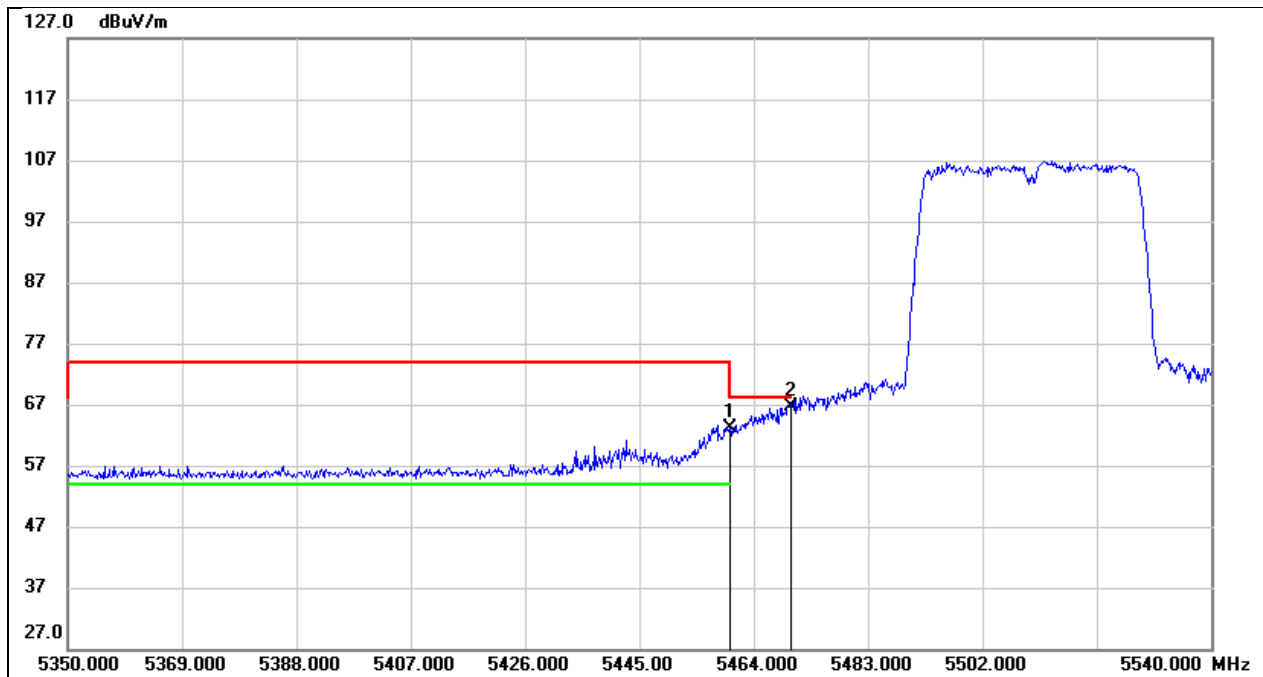

No.	Frequency (MHz)	Reading (dBuV)	Correct (dB/m)	Result (dBuV/m)	Limit (dBuV/m)	Margin (dB)	Remark
1	5460.000	22.52	40.62	63.14	74.00	-10.86	peak
2	5470.000	26.09	40.63	66.72	68.20	-1.48	peak

Test Mode:	802.11n HT40 AV	Frequency(MHz):	5510
Polarity:	Vertical	Test Voltage:	DC 12 V

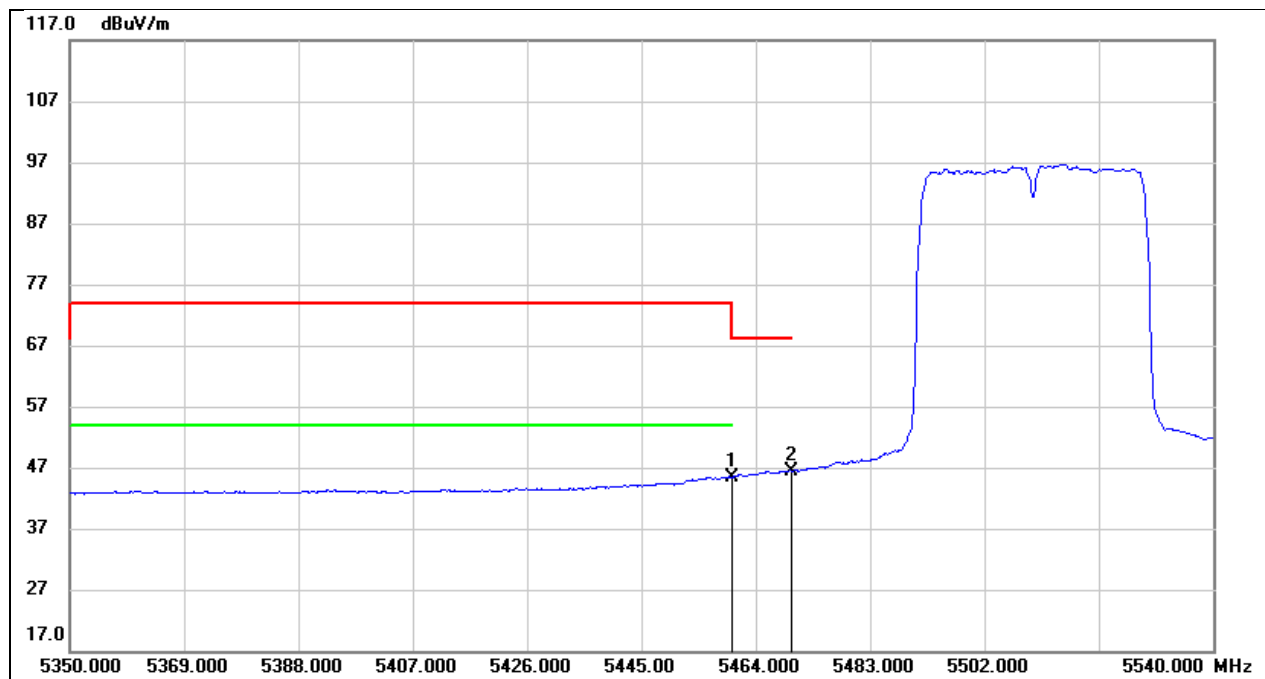

No.	Frequency (MHz)	Reading (dBuV)	Correct (dB/m)	Result (dBuV/m)	Limit (dBuV/m)	Margin (dB)	Remark
1	5460.000	4.86	40.62	45.48	54.00	-8.52	AVG
2	5470.000	5.75	40.63	46.38	/	/	AVG

Test Mode:	802.11n HT40 PK	Frequency(MHz):	5670
Polarity:	Vertical	Test Voltage:	DC 12 V

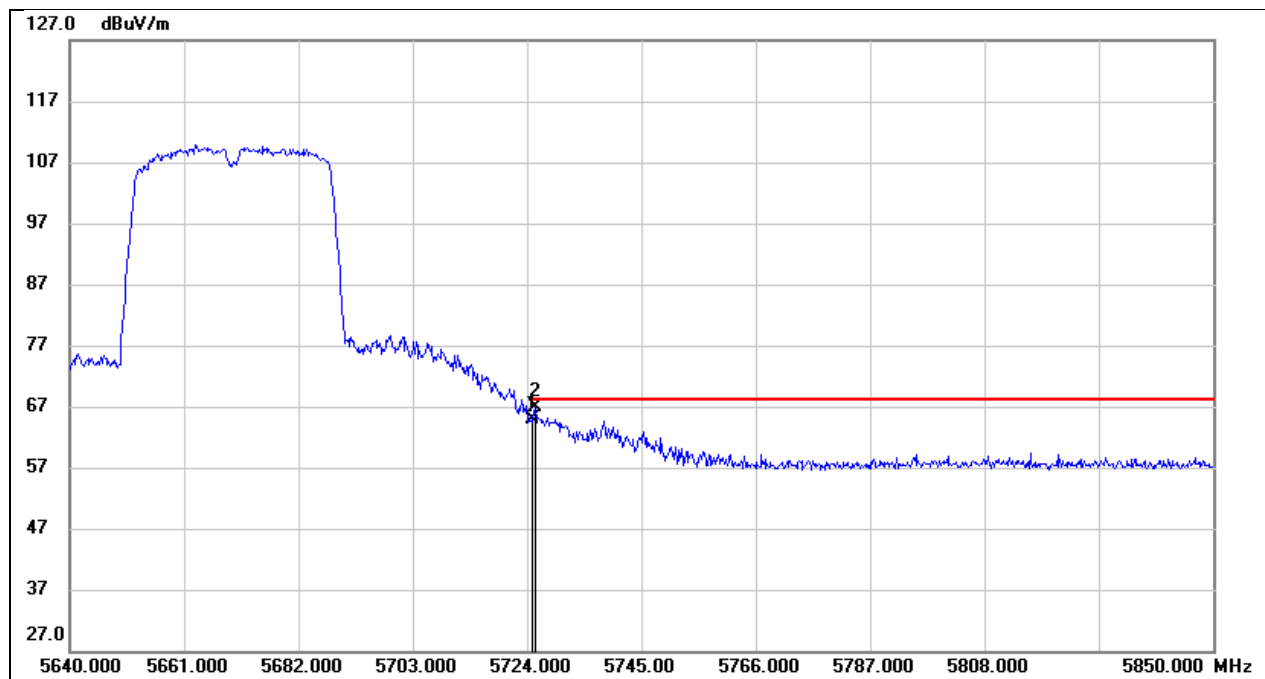

No.	Frequency (MHz)	Reading (dBuV)	Correct (dB/m)	Result (dBuV/m)	Limit (dBuV/m)	Margin (dB)	Remark
1	5725.000	23.60	41.27	64.87	68.20	-3.33	peak
2	5725.470	25.65	41.27	66.92	68.20	-1.28	peak

Test Mode:	802.11n HT40 PK	Frequency(MHz):	5755
Polarity:	Vertical	Test Voltage:	DC 12 V

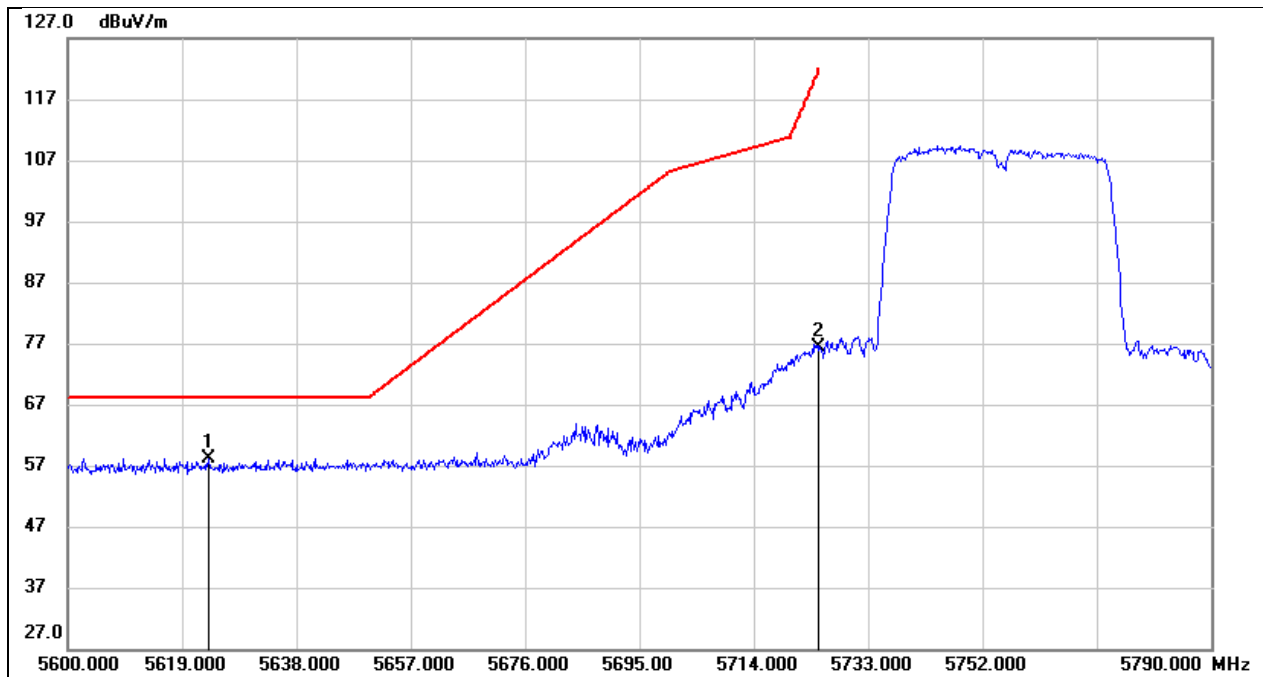

No.	Frequency (MHz)	Reading (dBuV)	Correct (dB/m)	Result (dBuV/m)	Limit (dBuV/m)	Margin (dB)	Remark
1	5623.370	17.23	40.99	58.22	68.20	-9.98	peak
2	5725.000	35.09	41.27	76.36	122.20	-45.84	peak

Test Mode:	802.11n HT40 PK	Frequency(MHz):	5795
Polarity:	Vertical	Test Voltage:	DC 12 V

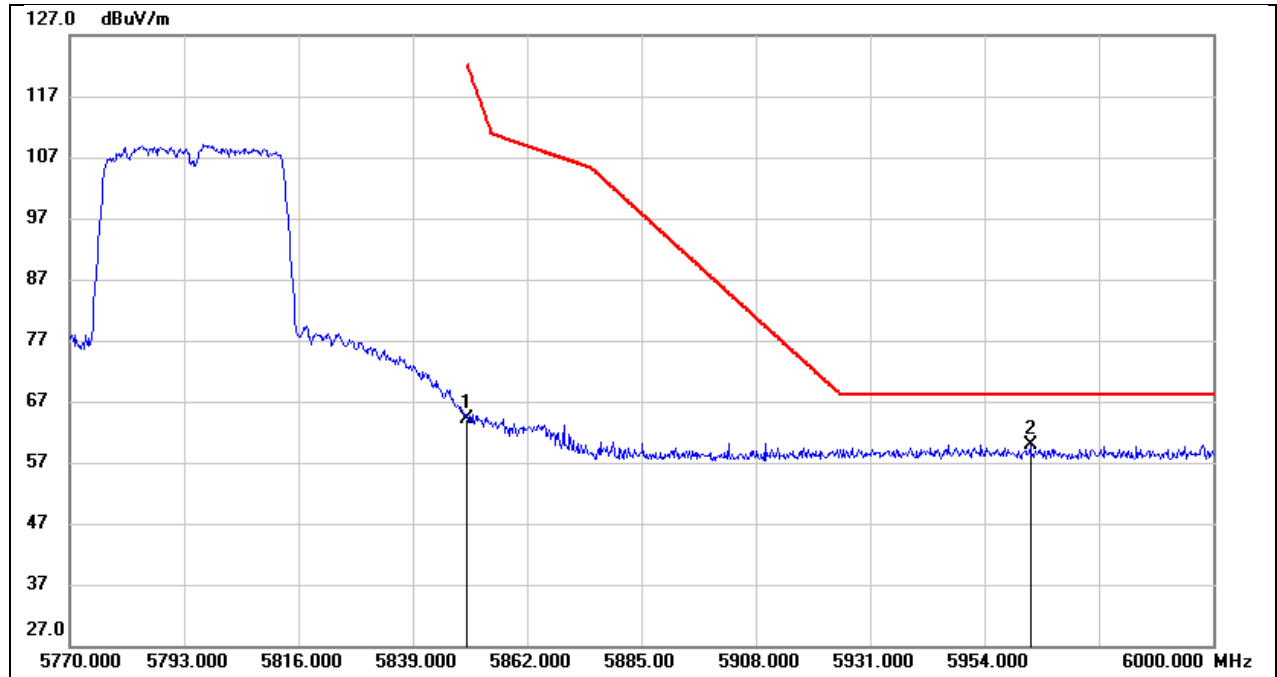

No.	Frequency (MHz)	Reading (dBuV)	Correct (dB/m)	Result (dBuV/m)	Limit (dBuV/m)	Margin (dB)	Remark
1	5850.000	22.56	41.60	64.16	122.20	-58.04	peak
2	5963.200	18.07	41.90	59.97	68.20	-8.23	peak

Test Mode:	802.11ac VHT80 PK	Frequency(MHz):	5210
Polarity:	Vertical	Test Voltage:	DC 12 V

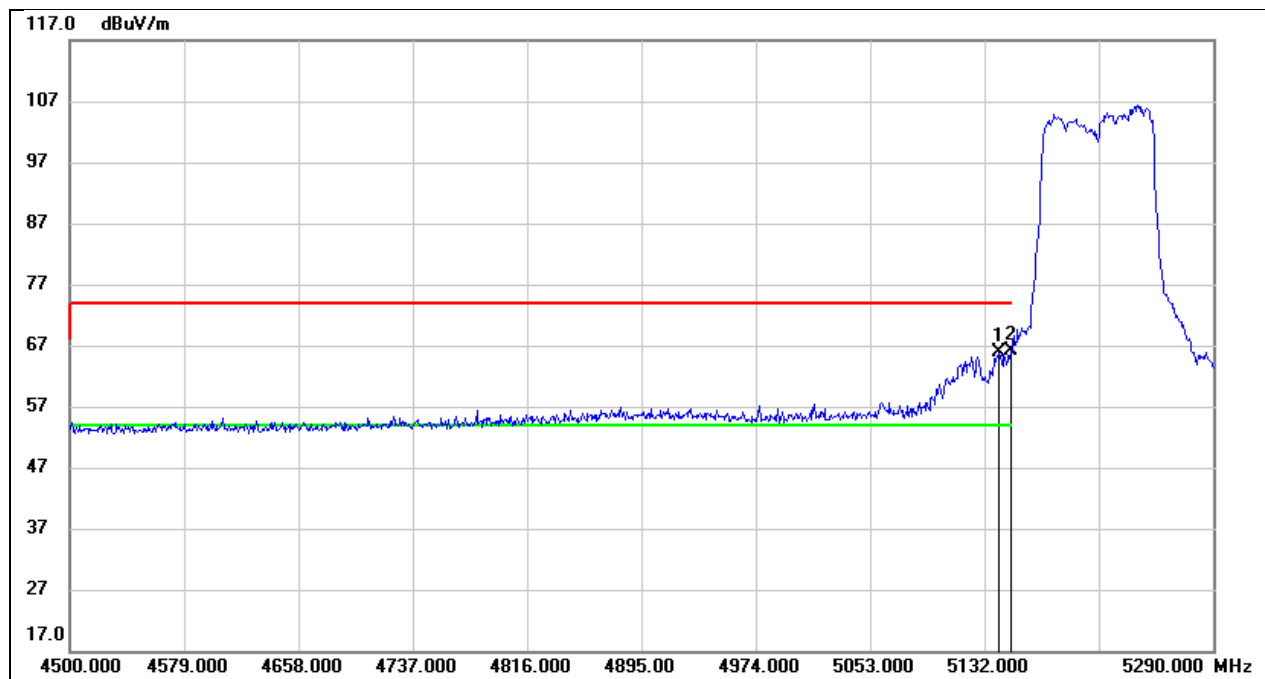

No.	Frequency (MHz)	Reading (dBuV)	Correct (dB/m)	Result (dBuV/m)	Limit (dBuV/m)	Margin (dB)	Remark
1	5142.270	25.58	40.26	65.84	74.00	-8.16	peak
2	5150.000	25.85	40.27	66.12	74.00	-7.88	peak

Test Mode:	802.11ac VHT80 AV	Frequency(MHz):	5210
Polarity:	Vertical	Test Voltage:	DC 12 V

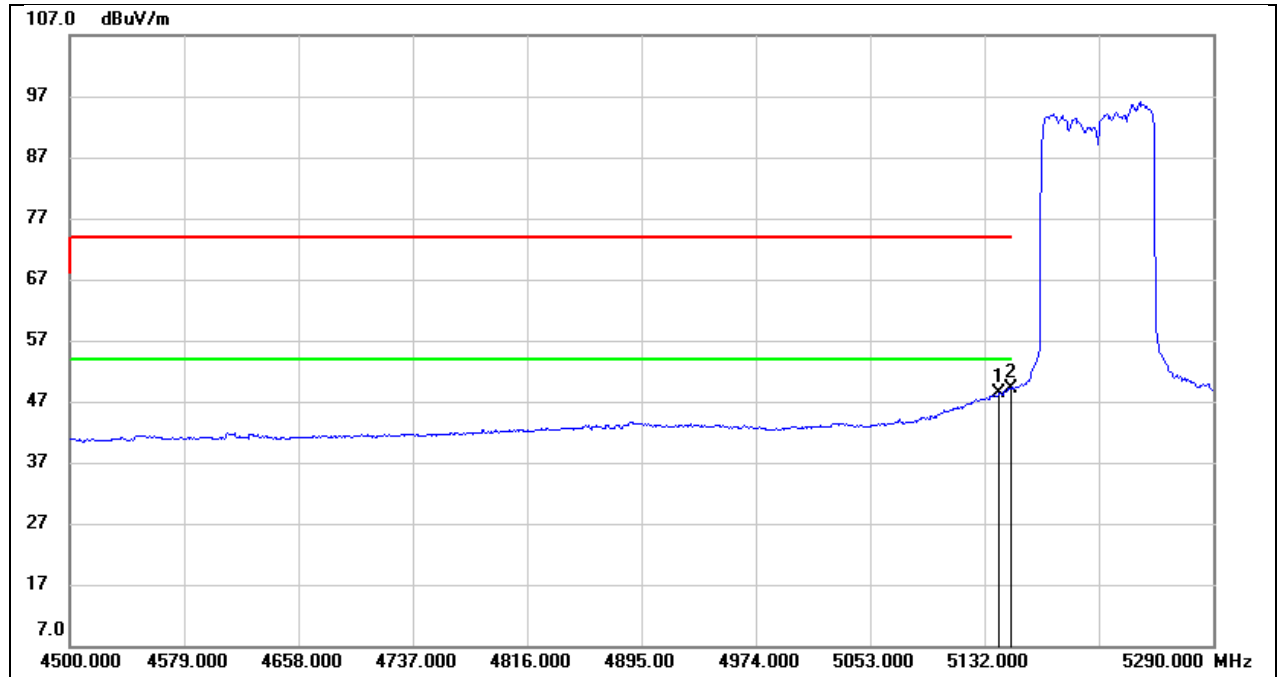

No.	Frequency (MHz)	Reading (dBuV)	Correct (dB/m)	Result (dBuV/m)	Limit (dBuV/m)	Margin (dB)	Remark
1	5142.270	8.05	40.26	48.31	54.00	-5.69	AVG
2	5150.000	8.97	40.27	49.24	54.00	-4.76	AVG

Test Mode:	802.11ac VHT80 PK	Frequency(MHz):	5290
Polarity:	Vertical	Test Voltage:	DC 12 V

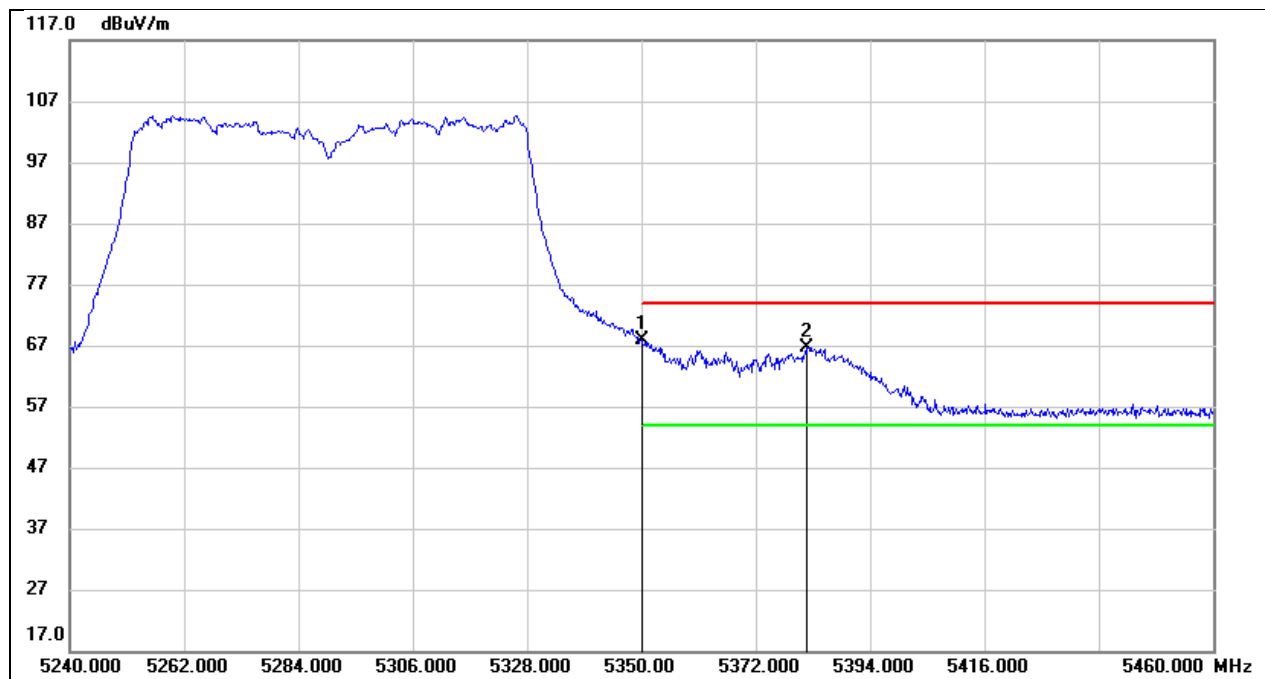

No.	Frequency (MHz)	Reading (dBuV)	Correct (dB/m)	Result (dBuV/m)	Limit (dBuV/m)	Margin (dB)	Remark
1	5350.000	27.46	40.49	67.95	74.00	-6.05	peak
2	5381.900	26.07	40.53	66.60	74.00	-7.40	peak

Test Mode:	802.11ac VHT80 AV	Frequency(MHz):	5290
Polarity:	Vertical	Test Voltage:	DC 12 V

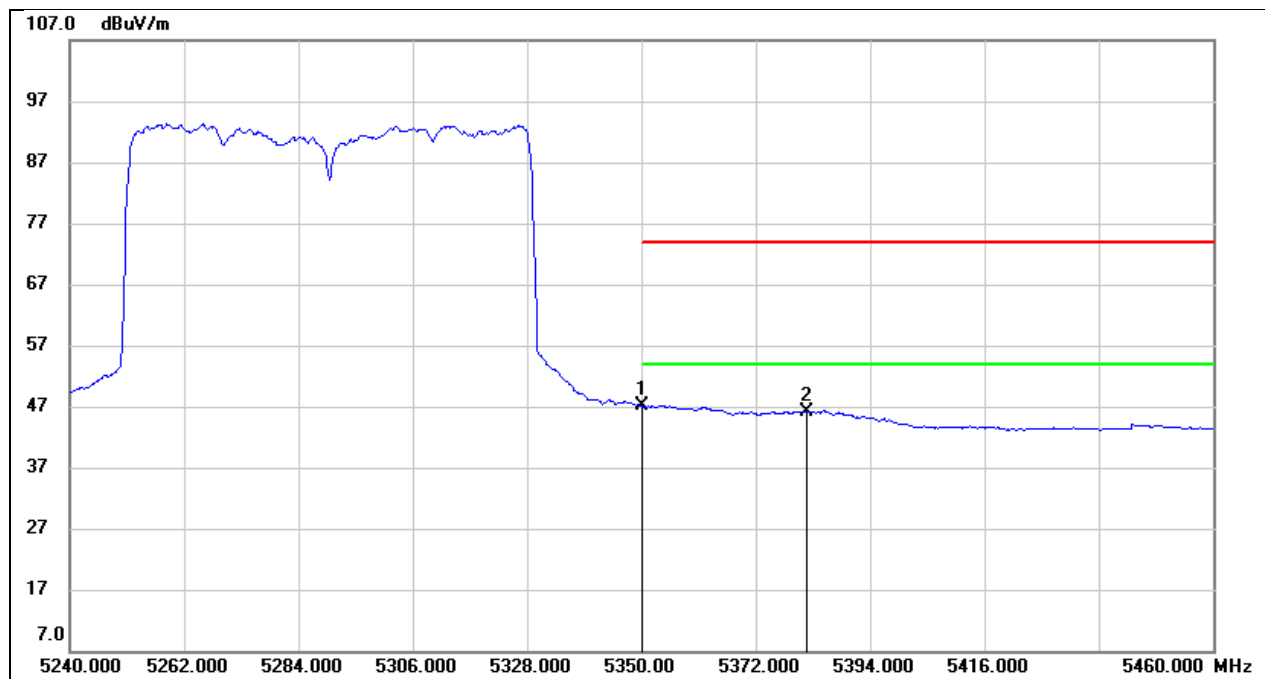

No.	Frequency (MHz)	Reading (dBuV)	Correct (dB/m)	Result (dBuV/m)	Limit (dBuV/m)	Margin (dB)	Remark
1	5350.000	6.57	40.49	47.06	54.00	-6.94	AVG
2	5381.900	5.60	40.53	46.13	54.00	-7.87	AVG

Test Mode:	802.11ac VHT80 PK	Frequency(MHz):	5530
Polarity:	Vertical	Test Voltage:	DC 12 V

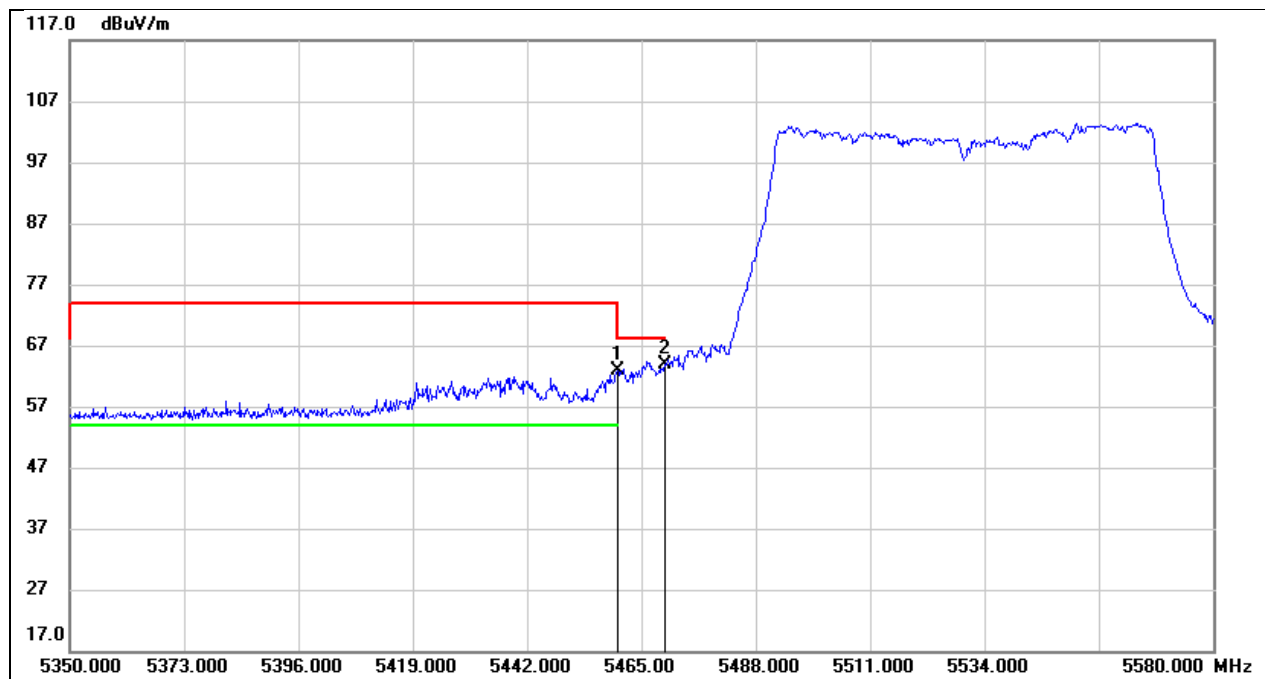

No.	Frequency (MHz)	Reading (dBuV)	Correct (dB/m)	Result (dBuV/m)	Limit (dBuV/m)	Margin (dB)	Remark
1	5460.000	22.16	40.62	62.78	74.00	-11.22	peak
2	5470.000	23.29	40.63	63.92	68.20	-4.28	peak

Test Mode:	802.11ac VHT80 AV	Frequency(MHz):	5530
Polarity:	Vertical	Test Voltage:	DC 12 V

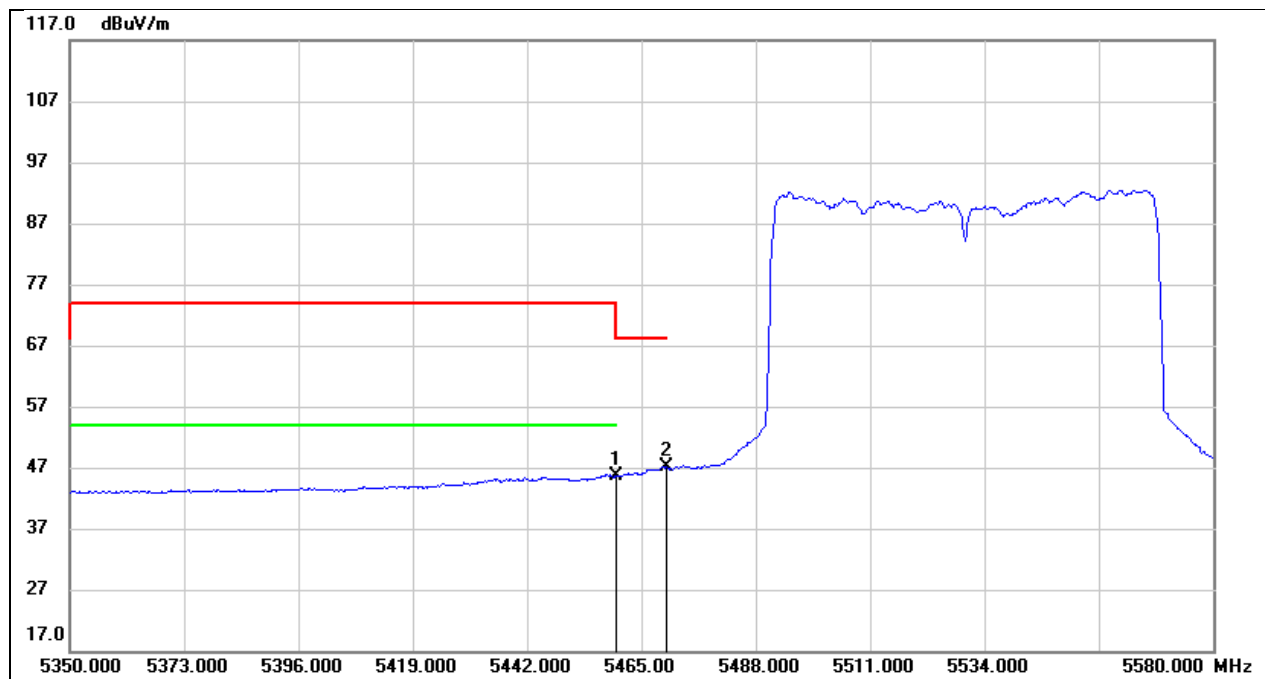

No.	Frequency (MHz)	Reading (dBuV)	Correct (dB/m)	Result (dBuV/m)	Limit (dBuV/m)	Margin (dB)	Remark
1	5460.000	4.98	40.62	45.60	54.00	-8.40	AVG
2	5470.000	6.45	40.63	47.08	/	/	AVG

Test Mode:	802.11ac VHT80 PK	Frequency(MHz):	5610
Polarity:	Vertical	Test Voltage:	DC 12 V

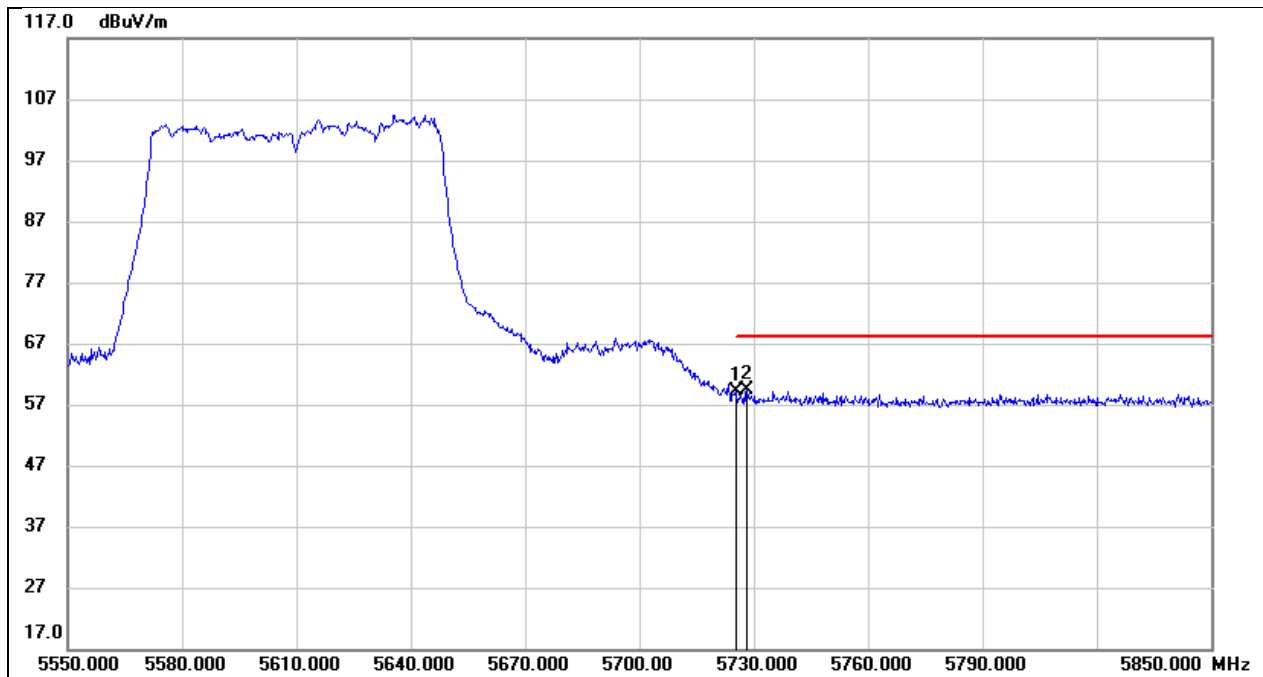

No.	Frequency (MHz)	Reading (dBuV)	Correct (dB/m)	Result (dBuV/m)	Limit (dBuV/m)	Margin (dB)	Remark
1	5725.000	17.92	41.27	59.19	68.20	-9.01	peak
2	5728.200	18.20	41.27	59.47	68.20	-8.73	peak

Test Mode:	802.11ac VHT80 PK	Frequency(MHz):	5775
Polarity:	Vertical	Test Voltage:	DC 12 V

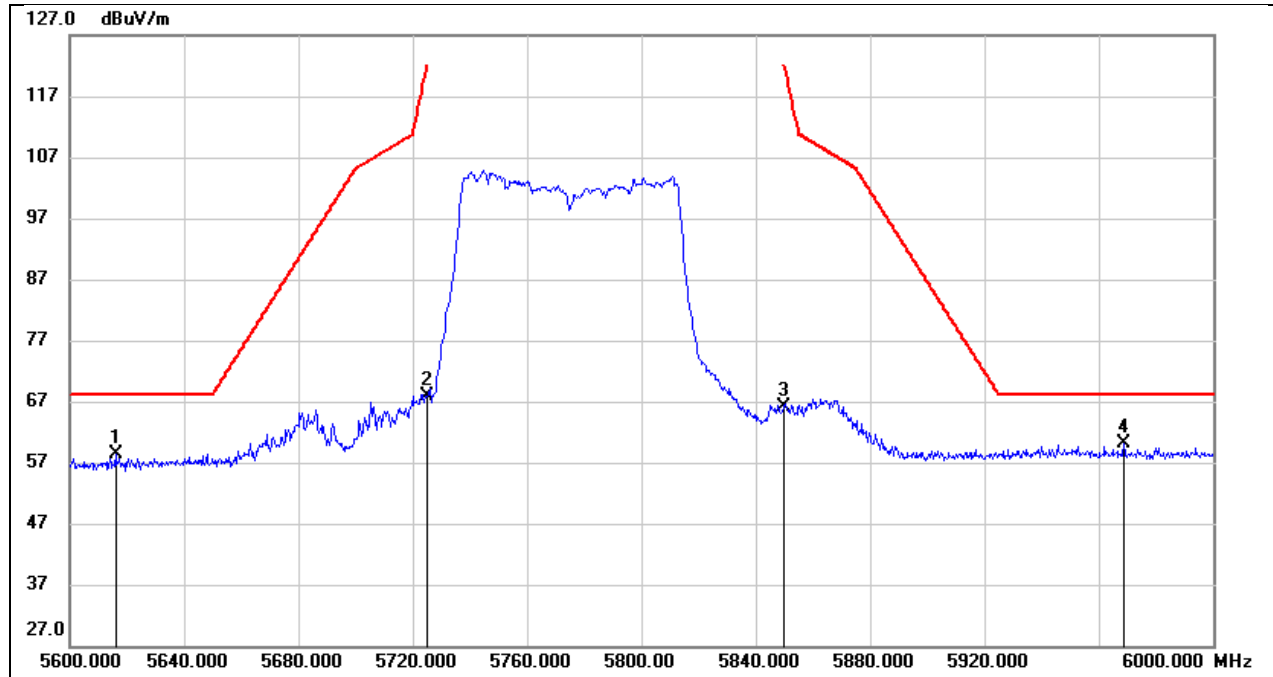

No.	Frequency (MHz)	Reading (dBuV)	Correct (dB/m)	Result (dBuV/m)	Limit (dBuV/m)	Margin (dB)	Remark
1	5616.000	17.35	40.97	58.32	68.20	-9.88	peak
2	5725.000	26.70	41.27	67.97	122.20	-54.23	peak
3	5850.000	24.59	41.60	66.19	122.20	-56.01	peak
4	5968.800	18.19	41.92	60.11	68.20	-8.09	peak

Test Mode:	802.11ax HE20 PK	Frequency(MHz):	5180
Polarity:	Vertical	Test Voltage:	DC 12 V

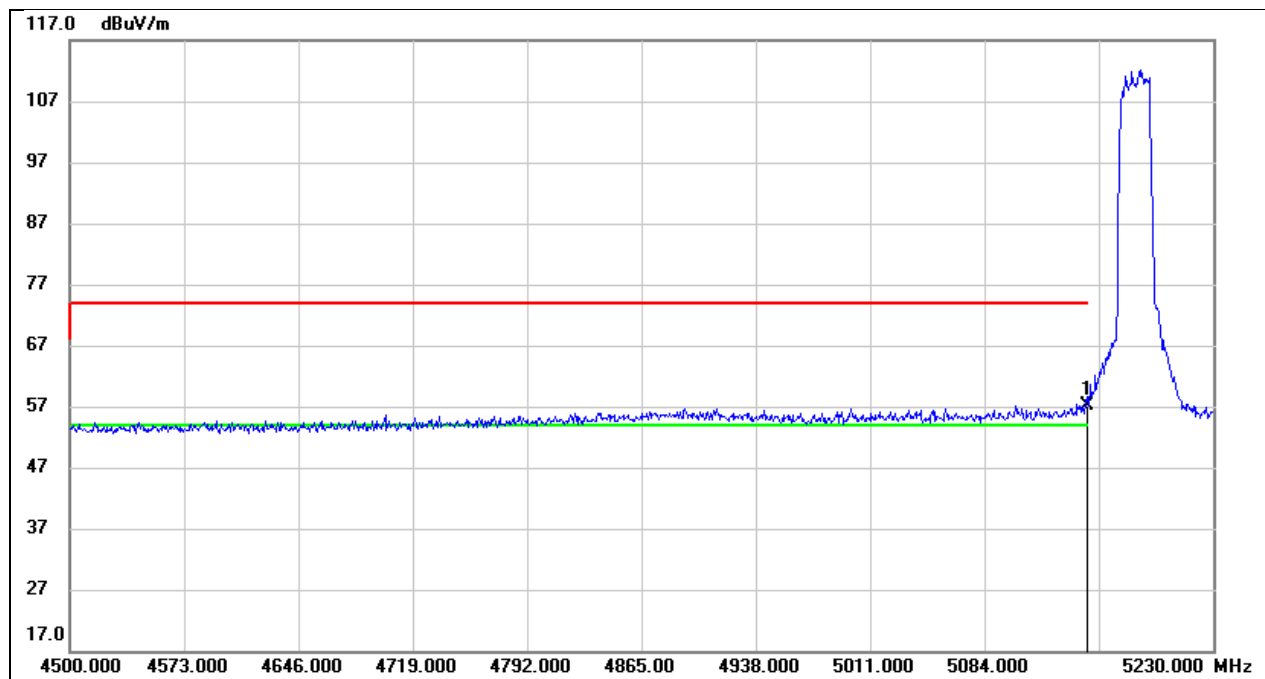

No.	Frequency (MHz)	Reading (dBuV)	Correct (dB/m)	Result (dBuV/m)	Limit (dBuV/m)	Margin (dB)	Remark
1	5150.000	16.95	40.27	57.22	74.00	-16.78	peak

Test Mode:	802.11ax HE20 AV	Frequency(MHz):	5180
Polarity:	Vertical	Test Voltage:	DC 12 V

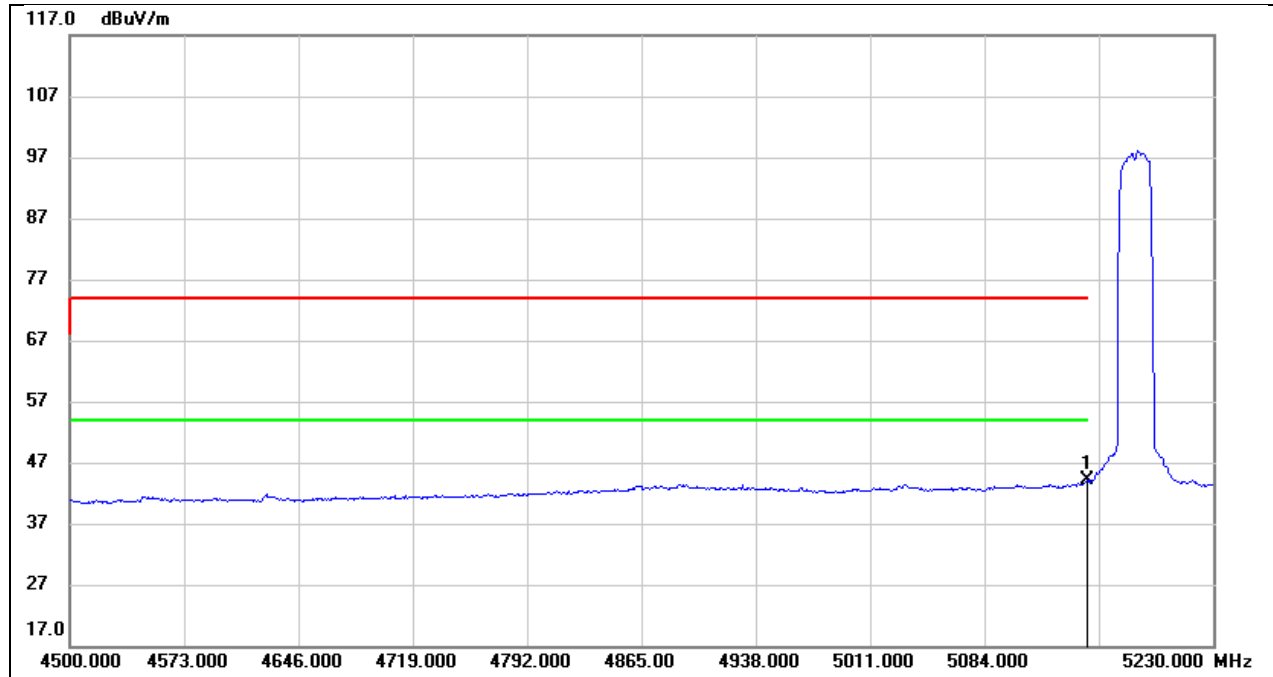

No.	Frequency (MHz)	Reading (dBuV)	Correct (dB/m)	Result (dBuV/m)	Limit (dBuV/m)	Margin (dB)	Remark
1	5150.000	3.75	40.27	44.02	54.00	-9.98	AVG

Test Mode:	802.11ax HE20 PK	Frequency(MHz):	5240
Polarity:	Vertical	Test Voltage:	DC 12 V

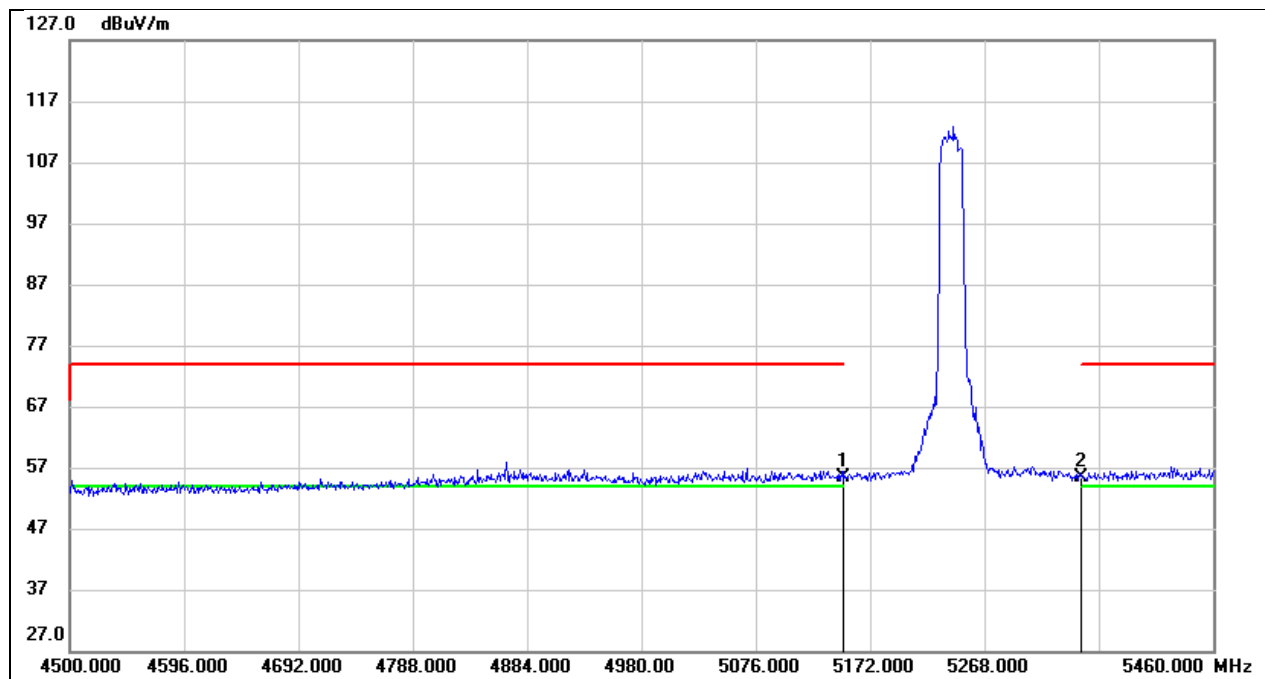

No.	Frequency (MHz)	Reading (dBuV)	Correct (dB/m)	Result (dBuV/m)	Limit (dBuV/m)	Margin (dB)	Remark
1	5150.000	15.00	40.27	55.27	74.00	-18.73	peak
2	5350.000	14.79	40.49	55.28	74.00	-18.72	peak

Test Mode:	802.11ax HE20 AV	Frequency(MHz):	5240
Polarity:	Vertical	Test Voltage:	DC 12 V

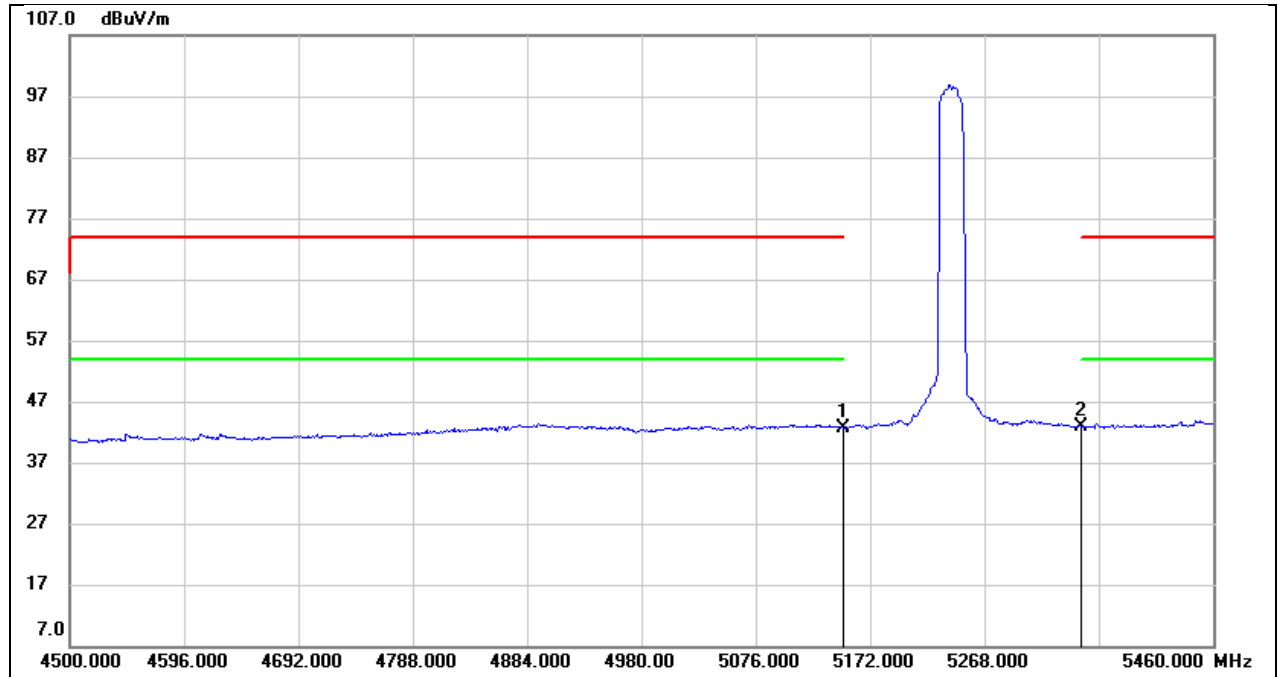

No.	Frequency (MHz)	Reading (dBuV)	Correct (dB/m)	Result (dBuV/m)	Limit (dBuV/m)	Margin (dB)	Remark
1	5150.000	2.42	40.27	42.69	54.00	-11.31	AVG
2	5350.000	2.34	40.49	42.83	54.00	-11.17	AVG

Test Mode:	802.11ax HE20 PK	Frequency(MHz):	5260
Polarity:	Vertical	Test Voltage:	DC 12 V

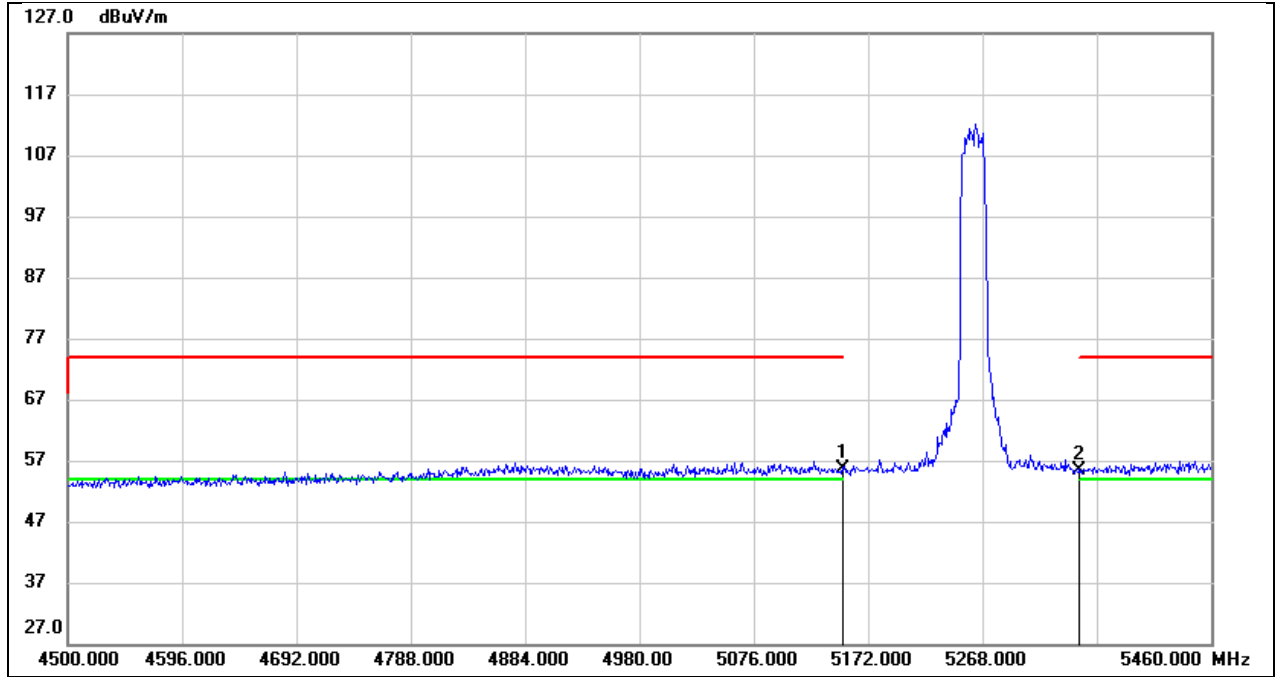

No.	Frequency (MHz)	Reading (dBuV)	Correct (dB/m)	Result (dBuV/m)	Limit (dBuV/m)	Margin (dB)	Remark
1	5150.000	15.26	40.27	55.53	74.00	-18.47	peak
2	5350.000	14.98	40.49	55.47	74.00	-18.53	peak

Test Mode:	802.11ax HE20 AV	Frequency(MHz):	5260
Polarity:	Vertical	Test Voltage:	DC 12 V

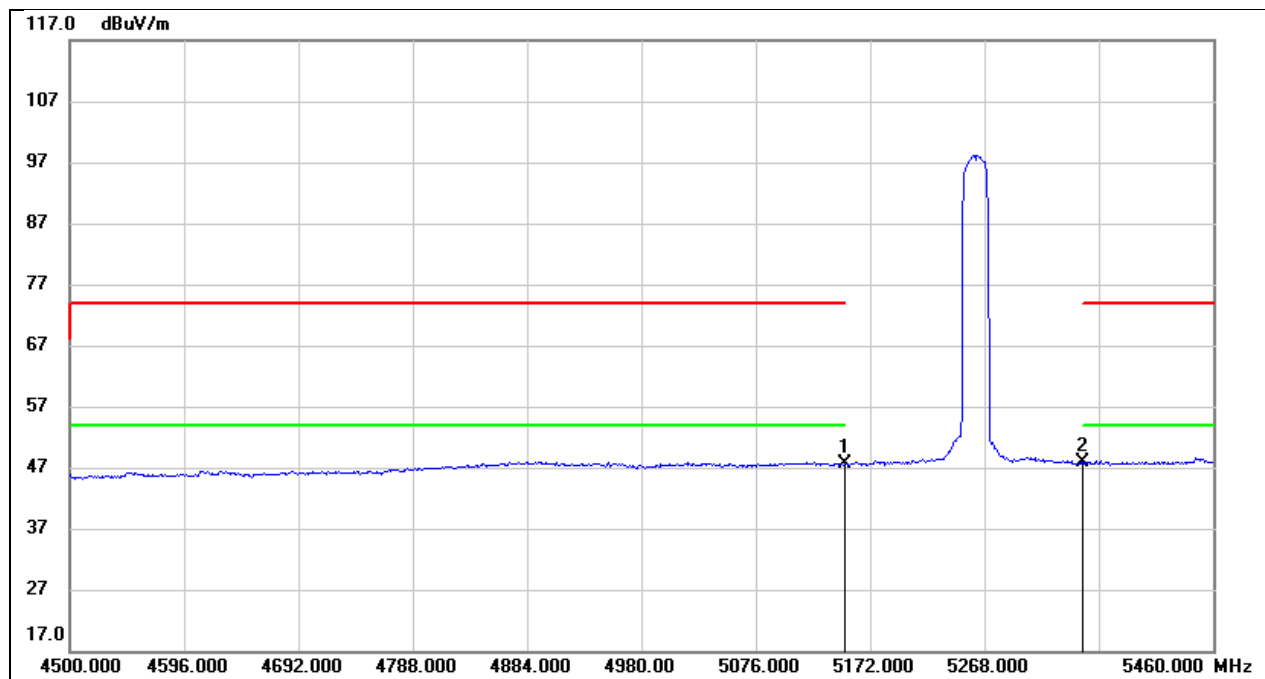

No.	Frequency (MHz)	Reading (dBuV)	Correct (dB/m)	Result (dBuV/m)	Limit (dBuV/m)	Margin (dB)	Remark
1	5150.000	7.35	40.27	47.62	54.00	-6.38	AVG
2	5350.000	7.33	40.49	47.82	54.00	-6.18	AVG

Test Mode:	802.11ax HE20 PK	Frequency(MHz):	5320
Polarity:	Vertical	Test Voltage:	DC 12 V

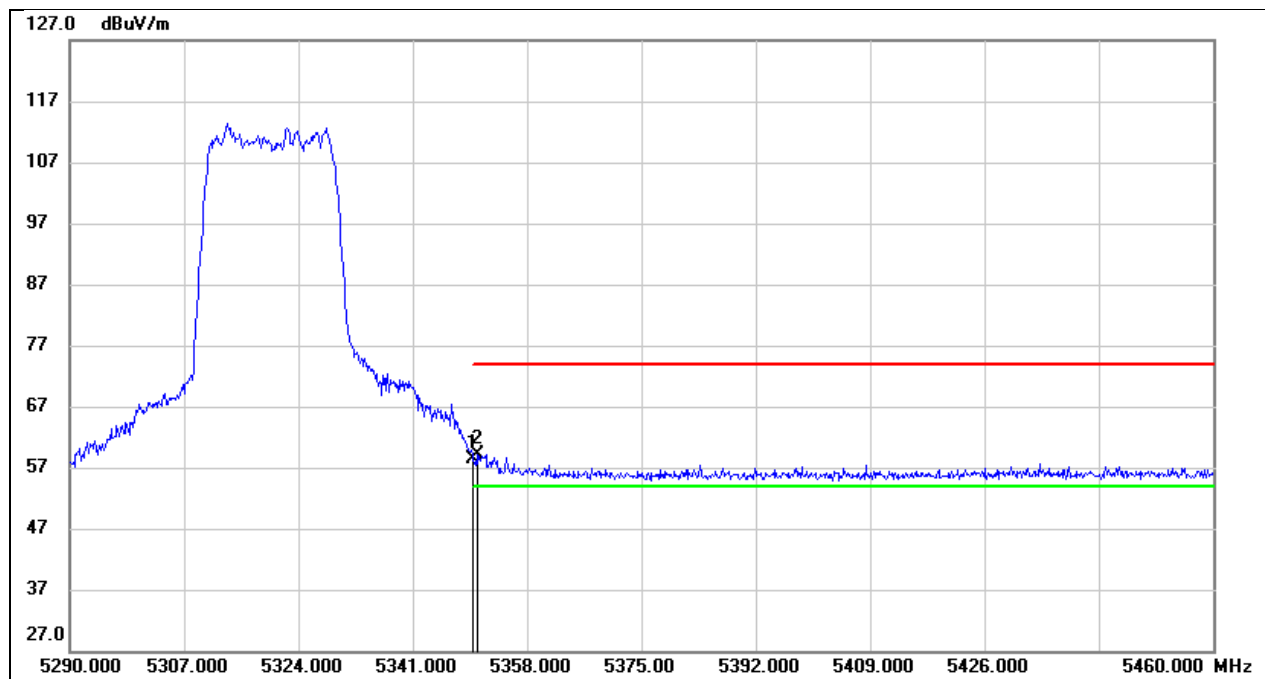

No.	Frequency (MHz)	Reading (dBuV)	Correct (dB/m)	Result (dBuV/m)	Limit (dBuV/m)	Margin (dB)	Remark
1	5350.000	17.77	40.49	58.26	74.00	-15.74	peak
2	5350.520	18.74	40.49	59.23	74.00	-14.77	peak

Test Mode:	802.11ax HE20 AV	Frequency(MHz):	5320
Polarity:	Vertical	Test Voltage:	DC 12 V

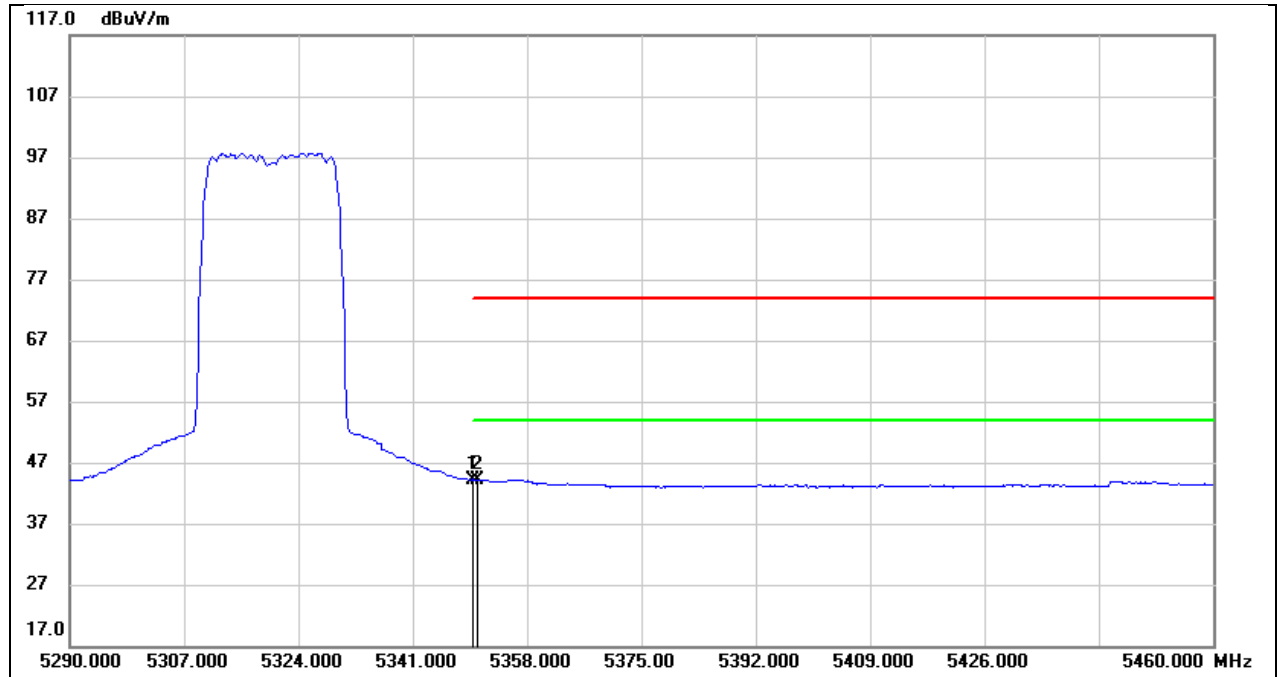

No.	Frequency (MHz)	Reading (dBuV)	Correct (dB/m)	Result (dBuV/m)	Limit (dBuV/m)	Margin (dB)	Remark
1	5350.000	3.71	40.49	44.20	54.00	-9.80	AVG
2	5350.520	3.61	40.49	44.10	54.00	-9.90	AVG

Test Mode:	802.11ax HE20 PK	Frequency(MHz):	5500
Polarity:	Vertical	Test Voltage:	DC 12 V

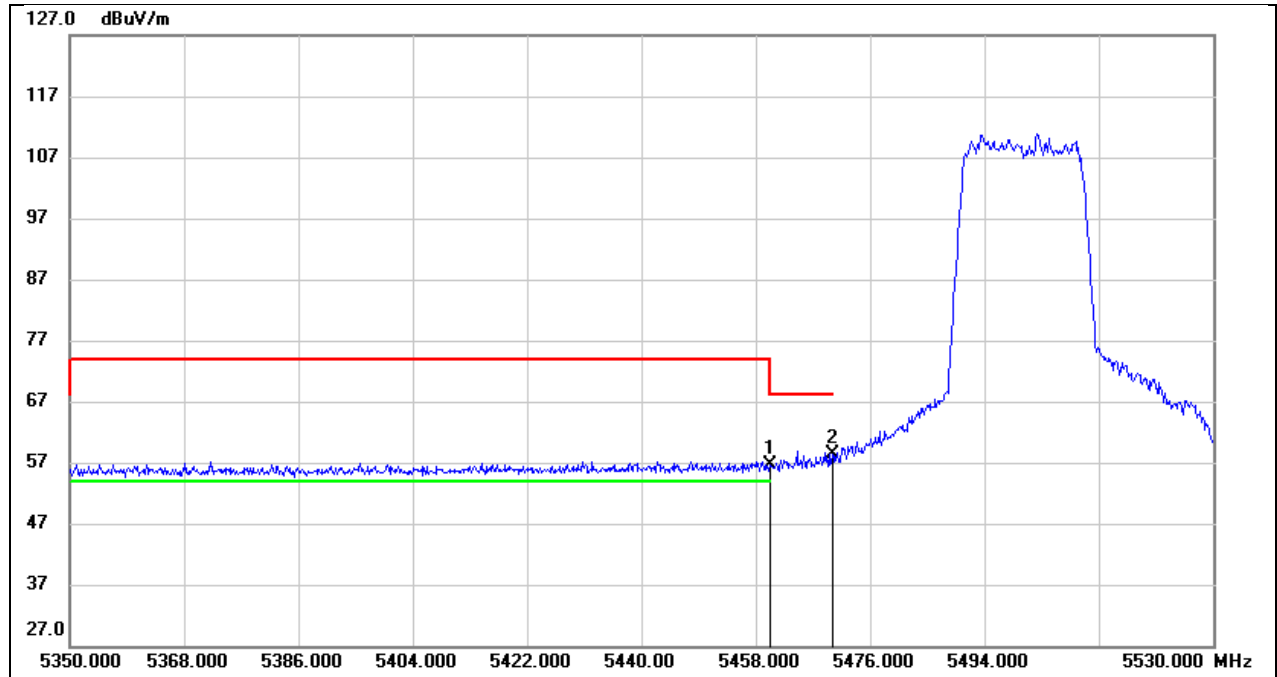

No.	Frequency (MHz)	Reading (dBuV)	Correct (dB/m)	Result (dBuV/m)	Limit (dBuV/m)	Margin (dB)	Remark
1	5460.000	15.89	40.62	56.51	74.00	-17.49	peak
2	5470.000	17.71	40.63	58.34	68.20	-9.86	peak

Test Mode:	802.11ax HE20 AV	Frequency(MHz):	5500
Polarity:	Vertical	Test Voltage:	DC 12 V

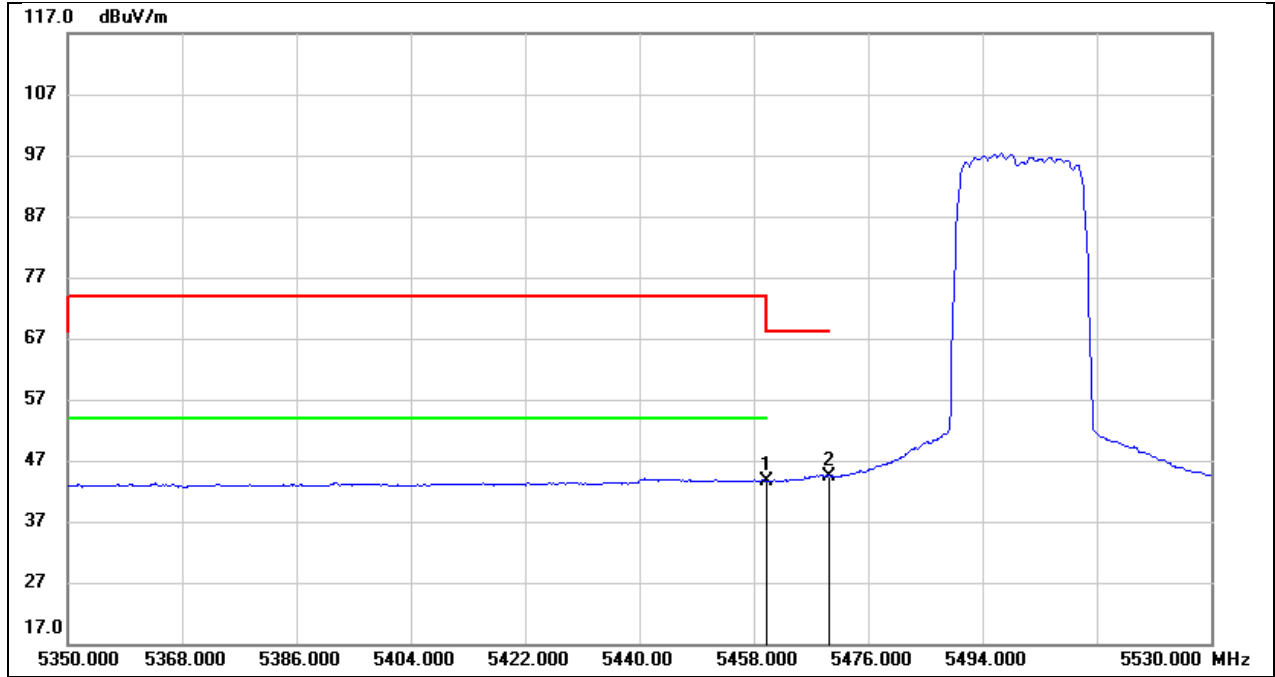

No.	Frequency (MHz)	Reading (dBuV)	Correct (dB/m)	Result (dBuV/m)	Limit (dBuV/m)	Margin (dB)	Remark
1	5460.000	3.01	40.62	43.63	54.00	-10.37	AVG
2	5470.000	3.76	40.63	44.39	/	/	AVG

Test Mode:	802.11ax HE20 PK	Frequency(MHz):	5700
Polarity:	Vertical	Test Voltage:	DC 12 V

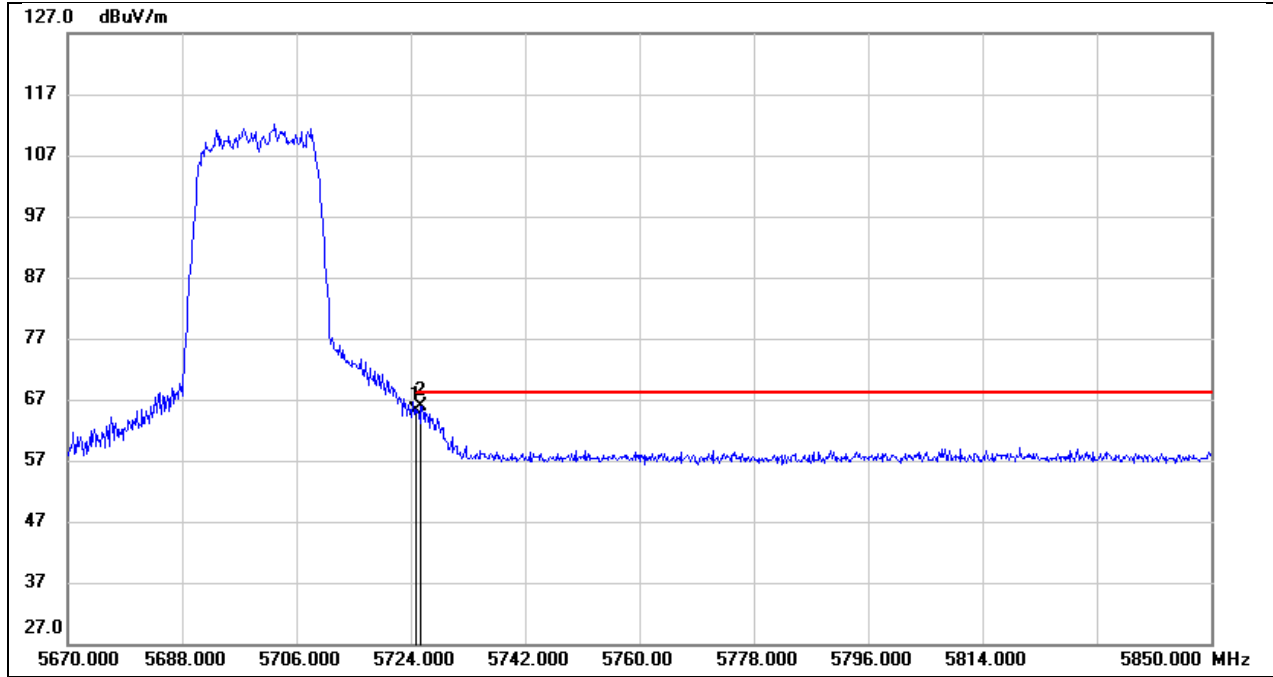

No.	Frequency (MHz)	Reading (dBuV)	Correct (dB/m)	Result (dBuV/m)	Limit (dBuV/m)	Margin (dB)	Remark
1	5725.000	23.84	41.27	65.11	68.20	-3.09	peak
2	5725.620	24.62	41.27	65.89	68.20	-2.31	peak

Test Mode:	802.11ax HE20 PK	Frequency(MHz):	5745
Polarity:	Vertical	Test Voltage:	DC 12 V

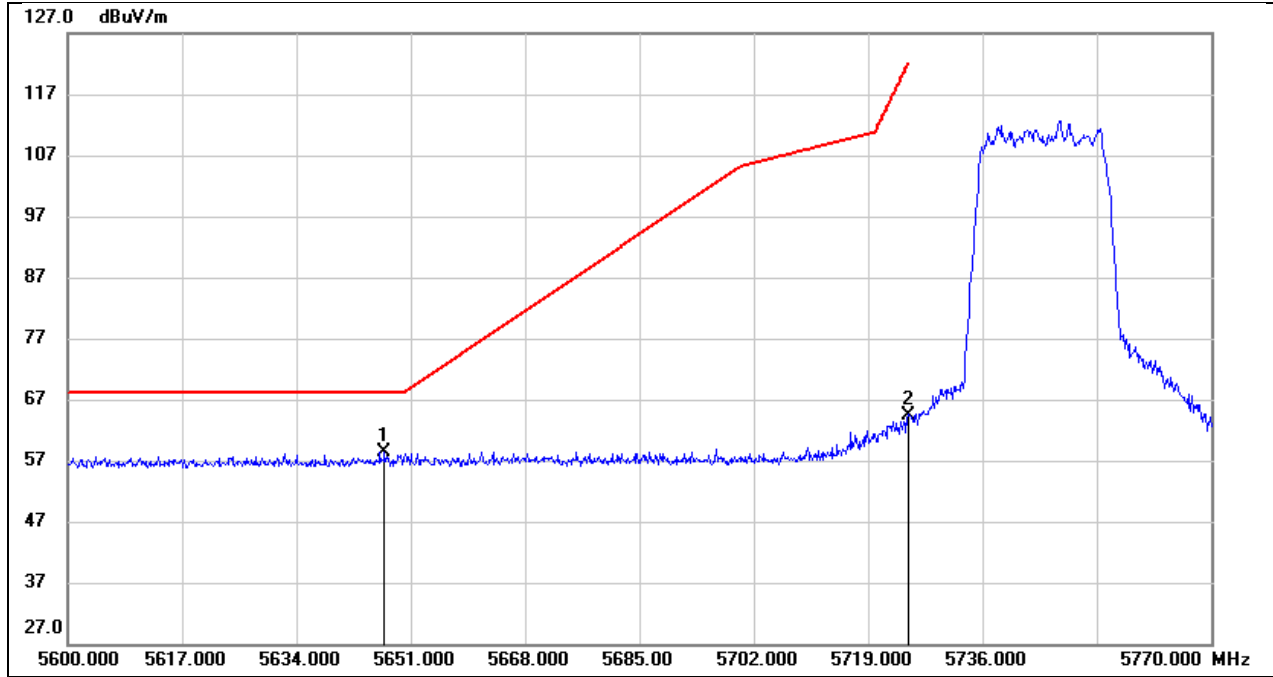

No.	Frequency (MHz)	Reading (dBuV)	Correct (dB/m)	Result (dBuV/m)	Limit (dBuV/m)	Margin (dB)	Remark
1	5647.090	17.33	41.06	58.39	68.20	-9.81	peak
2	5725.000	23.22	41.27	64.49	122.20	-57.71	peak

Test Mode:	802.11ax HE20 PK	Frequency(MHz):	5825
Polarity:	Vertical	Test Voltage:	DC 12 V

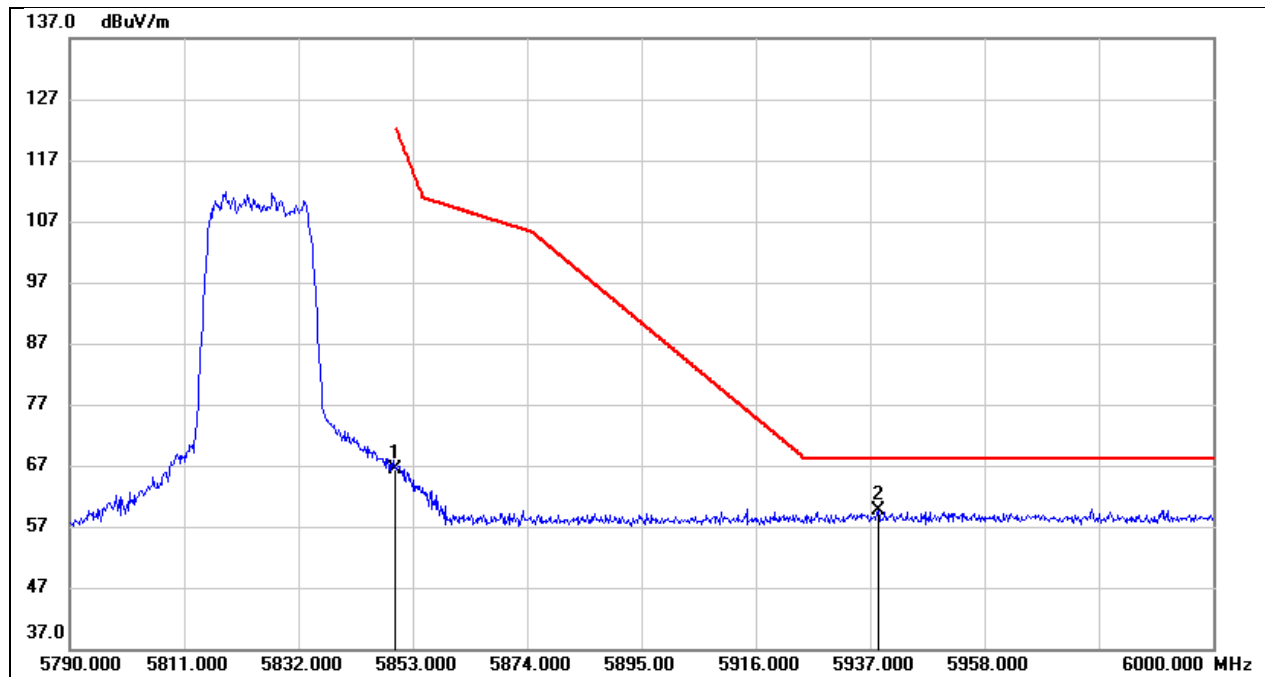

No.	Frequency (MHz)	Reading (dBuV)	Correct (dB/m)	Result (dBuV/m)	Limit (dBuV/m)	Margin (dB)	Remark
1	5850.000	24.89	41.60	66.49	122.20	-55.71	peak
2	5938.470	17.82	41.84	59.66	68.20	-8.54	peak

Test Mode:	802.11ax HE40 PK	Frequency(MHz):	5190
Polarity:	Vertical	Test Voltage:	DC 12 V

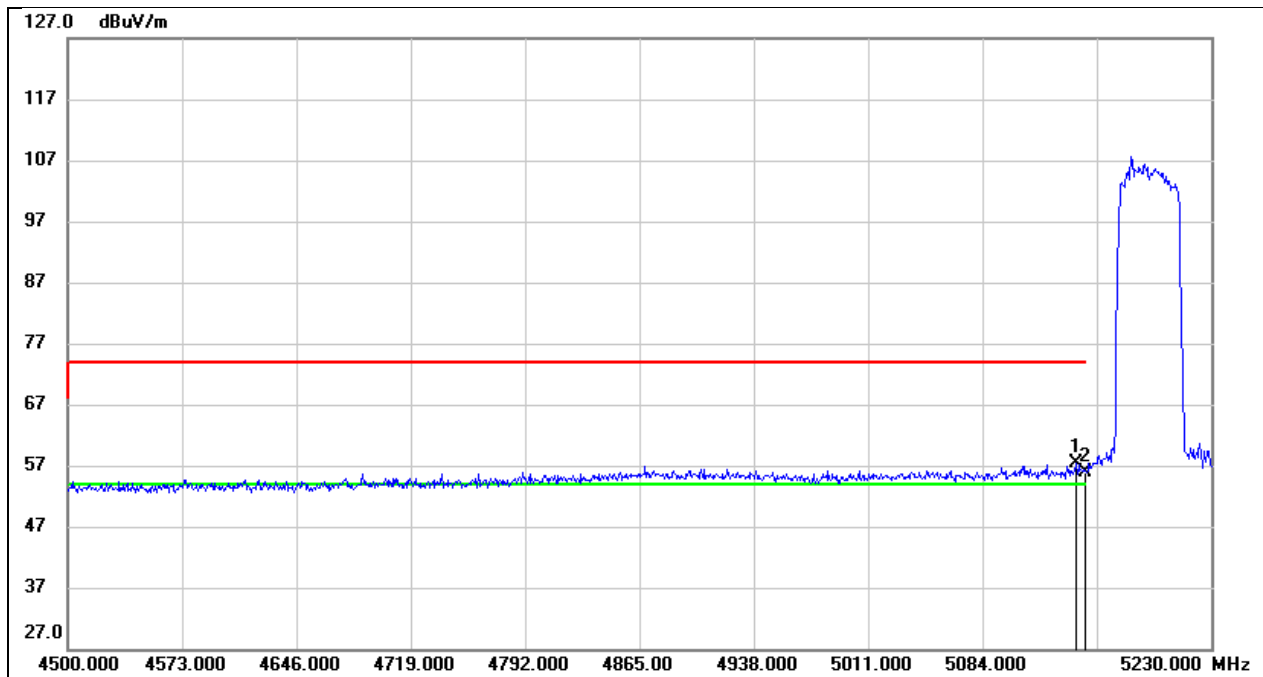

No.	Frequency (MHz)	Reading (dBuV)	Correct (dB/m)	Result (dBuV/m)	Limit (dBuV/m)	Margin (dB)	Remark
1	5143.860	17.22	40.27	57.49	74.00	-16.51	peak
2	5150.000	15.61	40.27	55.88	74.00	-18.12	peak

Test Mode:	802.11ax HE40 AV	Frequency(MHz):	5190
Polarity:	Vertical	Test Voltage:	DC 12 V

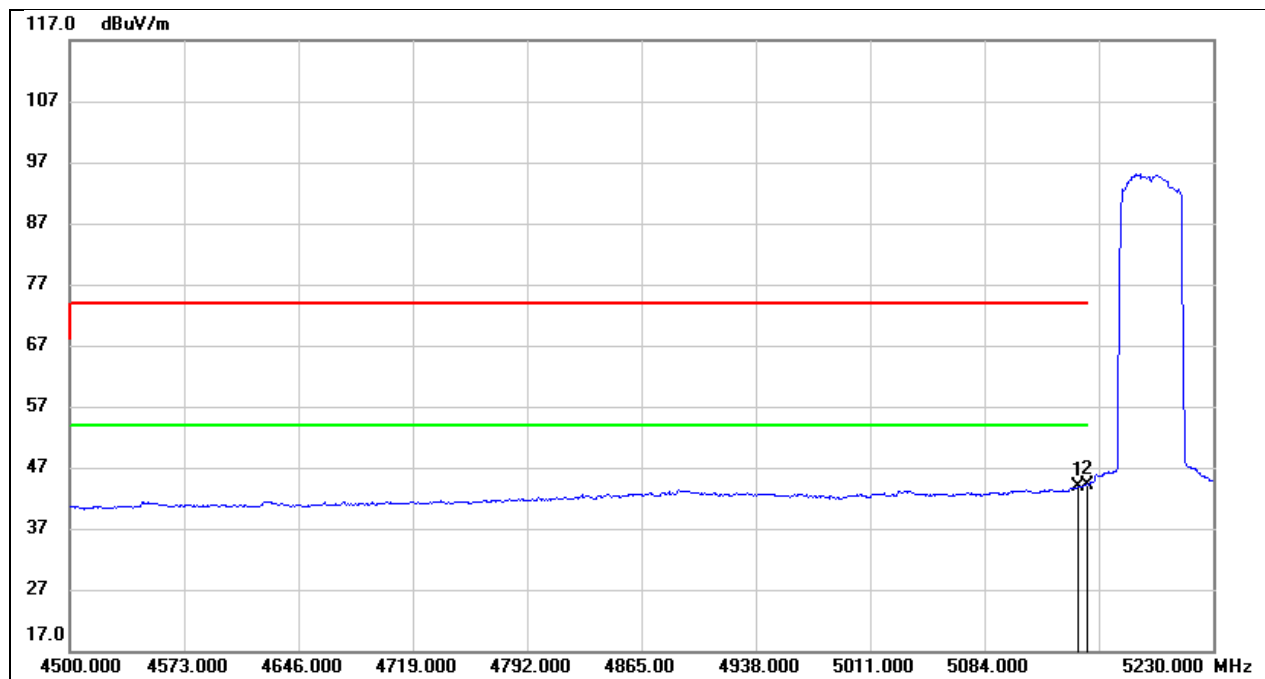

No.	Frequency (MHz)	Reading (dBuV)	Correct (dB/m)	Result (dBuV/m)	Limit (dBuV/m)	Margin (dB)	Remark
1	5143.860	3.56	40.27	43.83	54.00	-10.17	AVG
2	5150.000	3.94	40.27	44.21	54.00	-9.79	AVG

Test Mode:	802.11ax HE40 PK	Frequency(MHz):	5230
Polarity:	Vertical	Test Voltage:	DC 12 V

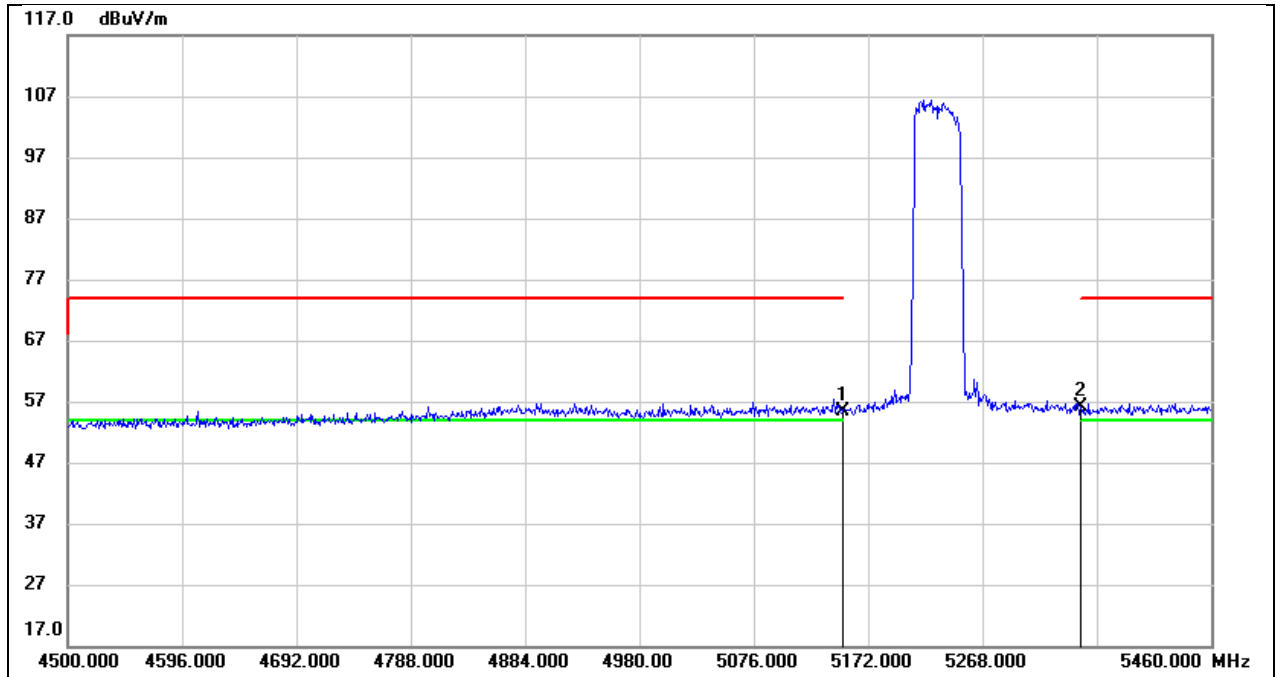

No.	Frequency (MHz)	Reading (dBuV)	Correct (dB/m)	Result (dBuV/m)	Limit (dBuV/m)	Margin (dB)	Remark
1	5150.000	15.05	40.27	55.32	74.00	-18.68	peak
2	5350.000	15.62	40.49	56.11	74.00	-17.89	peak

Test Mode:	802.11ax HE40 AV	Frequency(MHz):	5230
Polarity:	Vertical	Test Voltage:	DC 12 V

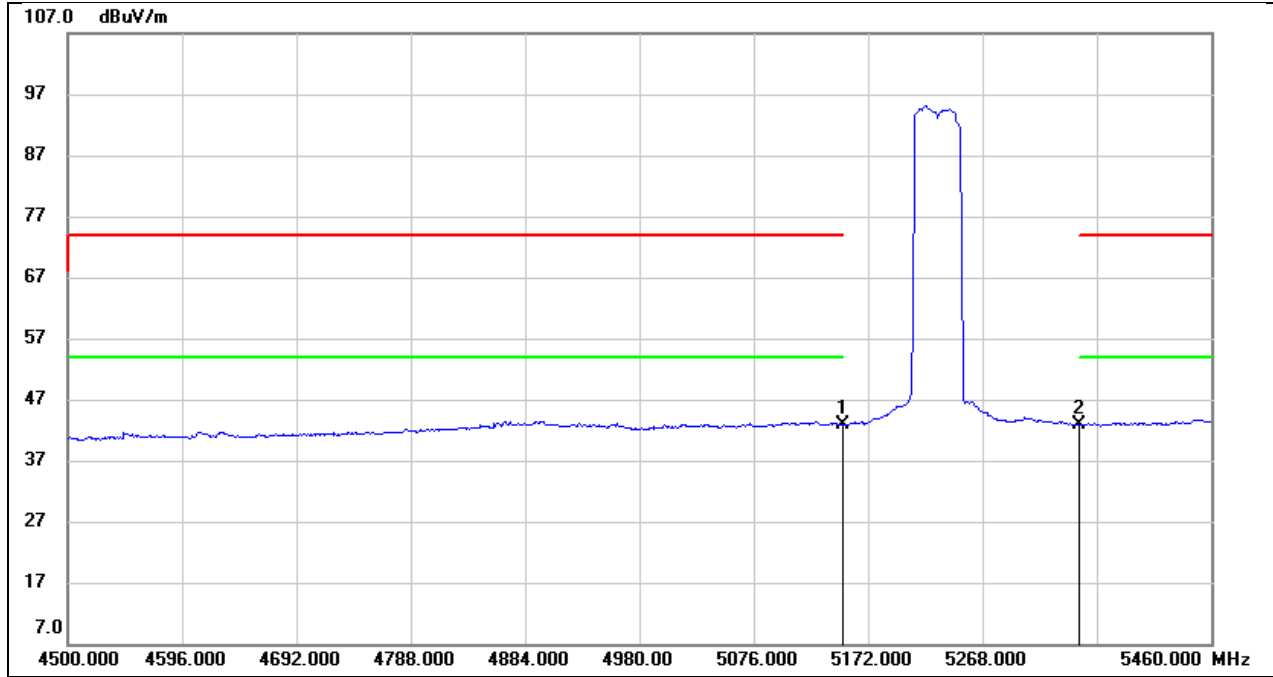

No.	Frequency (MHz)	Reading (dBuV)	Correct (dB/m)	Result (dBuV/m)	Limit (dBuV/m)	Margin (dB)	Remark
1	5150.000	2.72	40.27	42.99	54.00	-11.01	AVG
2	5350.000	2.36	40.49	42.85	54.00	-11.15	AVG

Test Mode:	802.11ax HE40 PK	Frequency(MHz):	5270
Polarity:	Vertical	Test Voltage:	DC 12 V

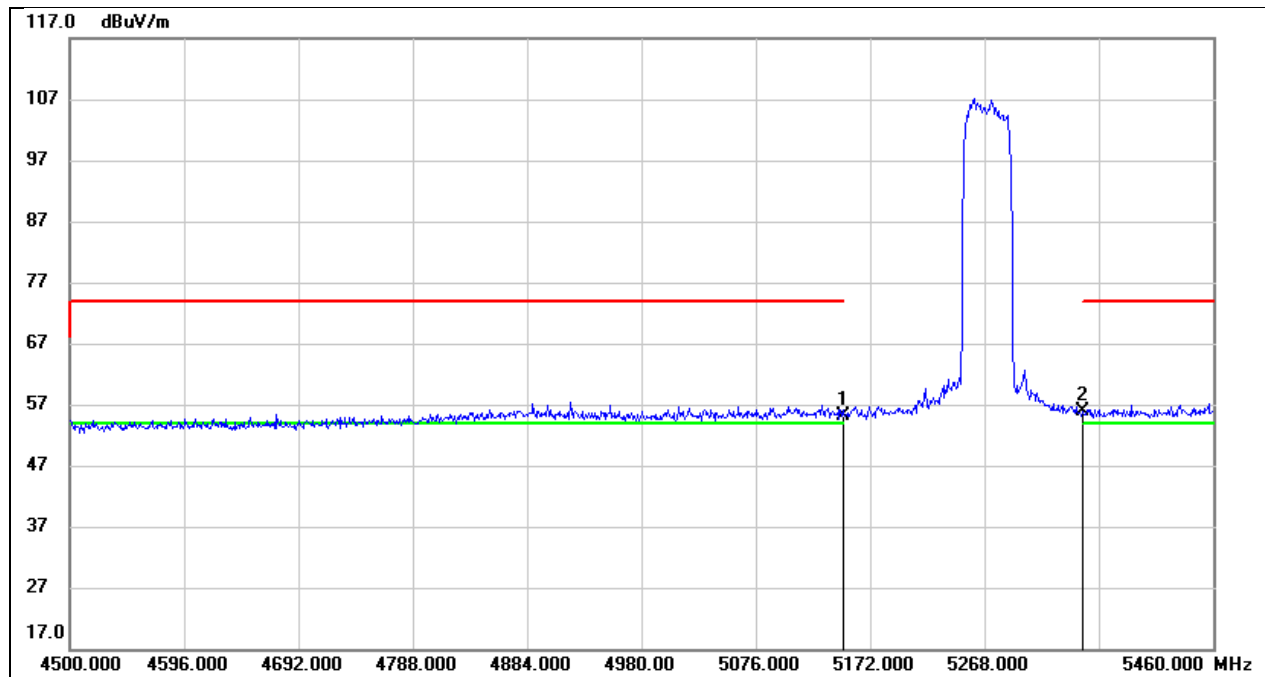

No.	Frequency (MHz)	Reading (dBuV)	Correct (dB/m)	Result (dBuV/m)	Limit (dBuV/m)	Margin (dB)	Remark
1	5150.000	14.95	40.27	55.22	74.00	-18.78	peak
2	5350.000	15.49	40.49	55.98	74.00	-18.02	peak

Test Mode:	802.11ax HE40 AV	Frequency(MHz):	5270
Polarity:	Vertical	Test Voltage:	DC 12 V

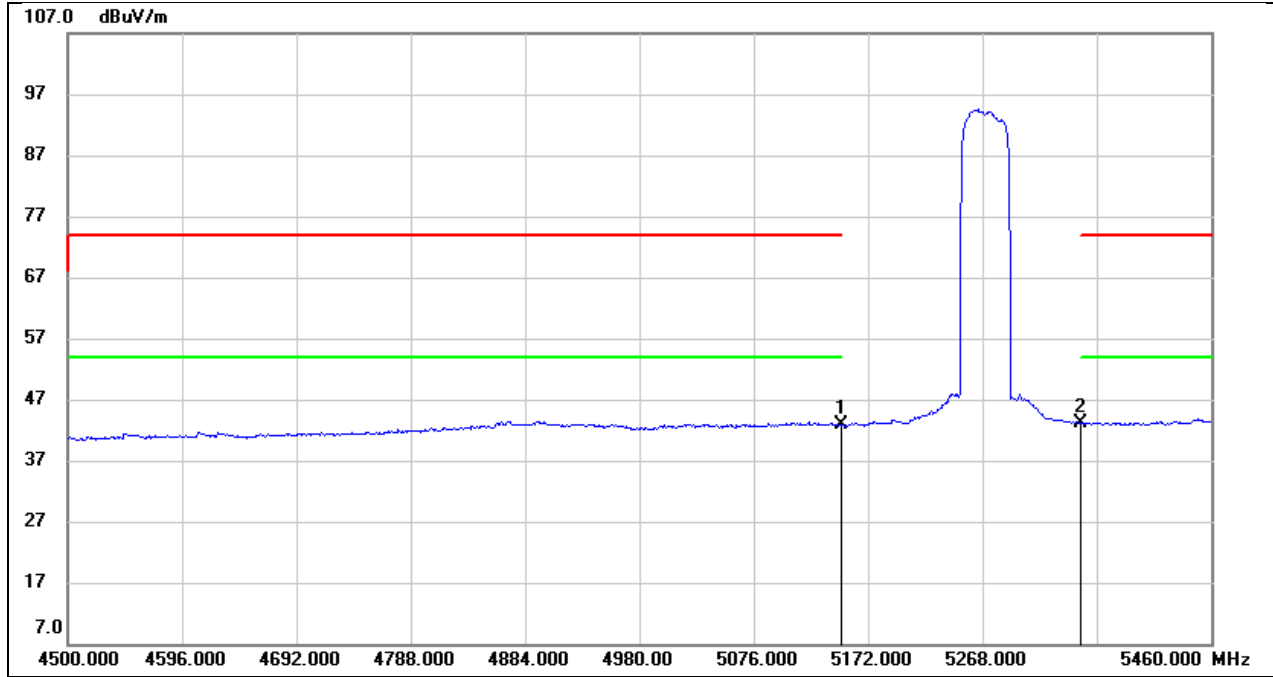

No.	Frequency (MHz)	Reading (dBuV)	Correct (dB/m)	Result (dBuV/m)	Limit (dBuV/m)	Margin (dB)	Remark
1	5150.000	2.52	40.27	42.79	54.00	-11.21	AVG
2	5350.000	2.65	40.49	43.14	54.00	-10.86	AVG

Test Mode:	802.11ax HE40 PK	Frequency(MHz):	5310
Polarity:	Vertical	Test Voltage:	DC 12 V

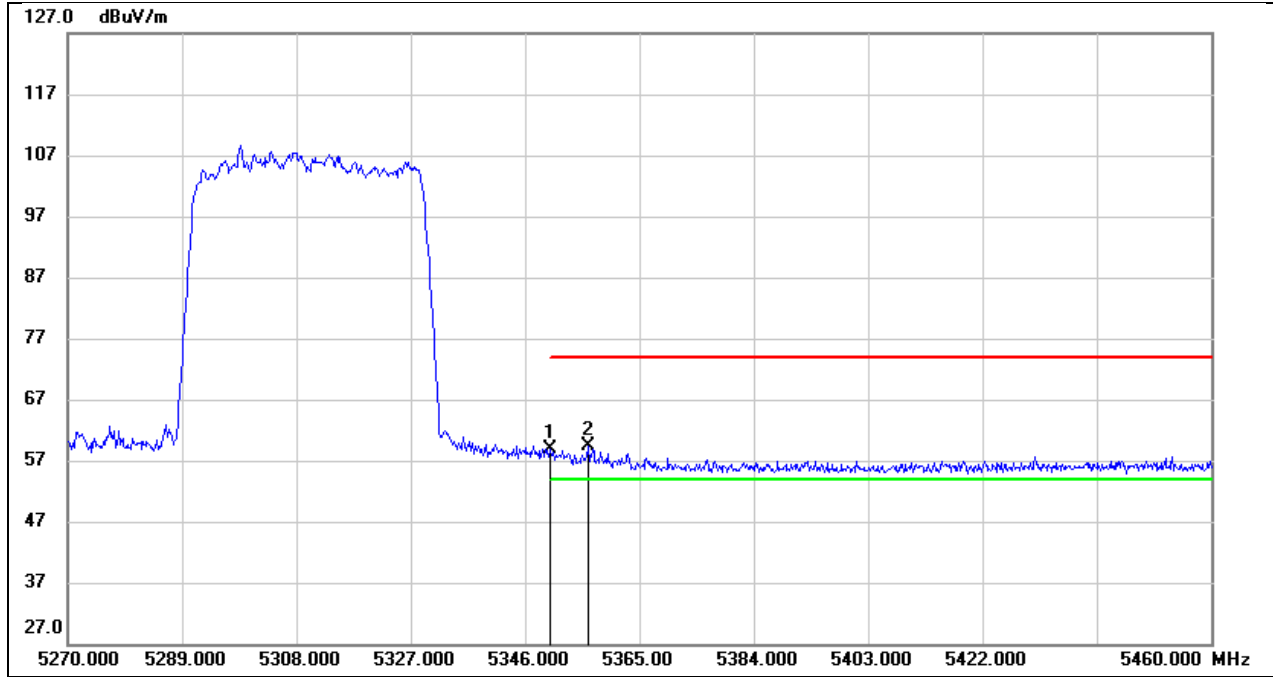

No.	Frequency (MHz)	Reading (dBuV)	Correct (dB/m)	Result (dBuV/m)	Limit (dBuV/m)	Margin (dB)	Remark
1	5350.000	18.36	40.49	58.85	74.00	-15.15	peak
2	5356.450	18.79	40.50	59.29	74.00	-14.71	peak

Test Mode:	802.11ax HE40 AV	Frequency(MHz):	5310
Polarity:	Vertical	Test Voltage:	DC 12 V

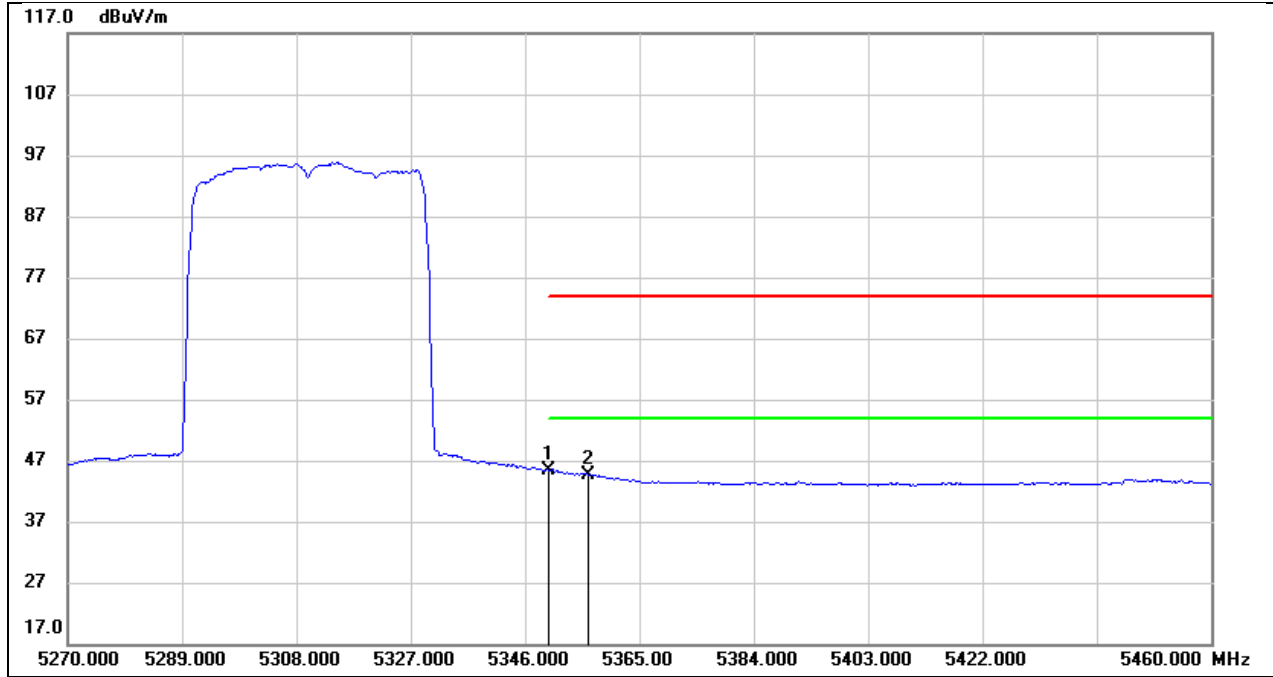

No.	Frequency (MHz)	Reading (dBuV)	Correct (dB/m)	Result (dBuV/m)	Limit (dBuV/m)	Margin (dB)	Remark
1	5350.000	4.83	40.49	45.32	54.00	-8.68	AVG
2	5356.450	4.18	40.50	44.68	54.00	-9.32	AVG

Test Mode:	802.11ax HE40 PK	Frequency(MHz):	5510
Polarity:	Vertical	Test Voltage:	DC 12 V

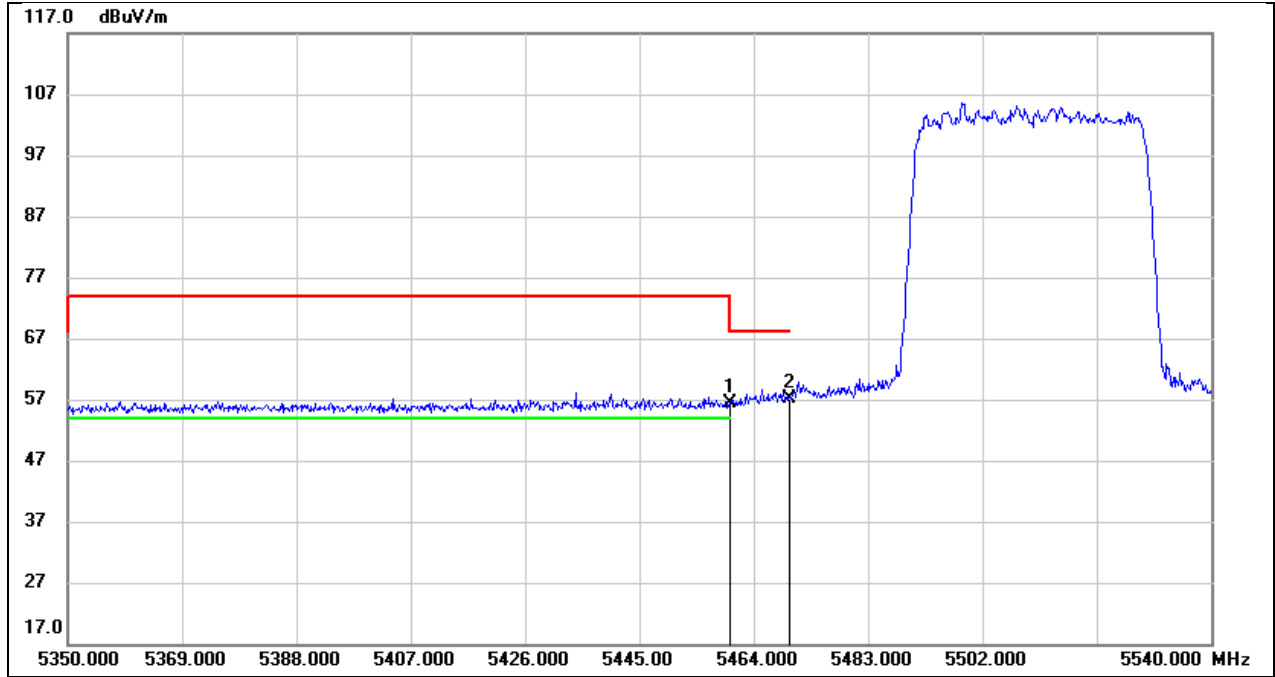

No.	Frequency (MHz)	Reading (dBuV)	Correct (dB/m)	Result (dBuV/m)	Limit (dBuV/m)	Margin (dB)	Remark
1	5460.000	15.74	40.62	56.36	74.00	-17.64	peak
2	5470.000	16.56	40.63	57.19	68.20	-11.01	peak

Test Mode:	802.11ax HE40 AV	Frequency(MHz):	5510
Polarity:	Vertical	Test Voltage:	DC 12 V

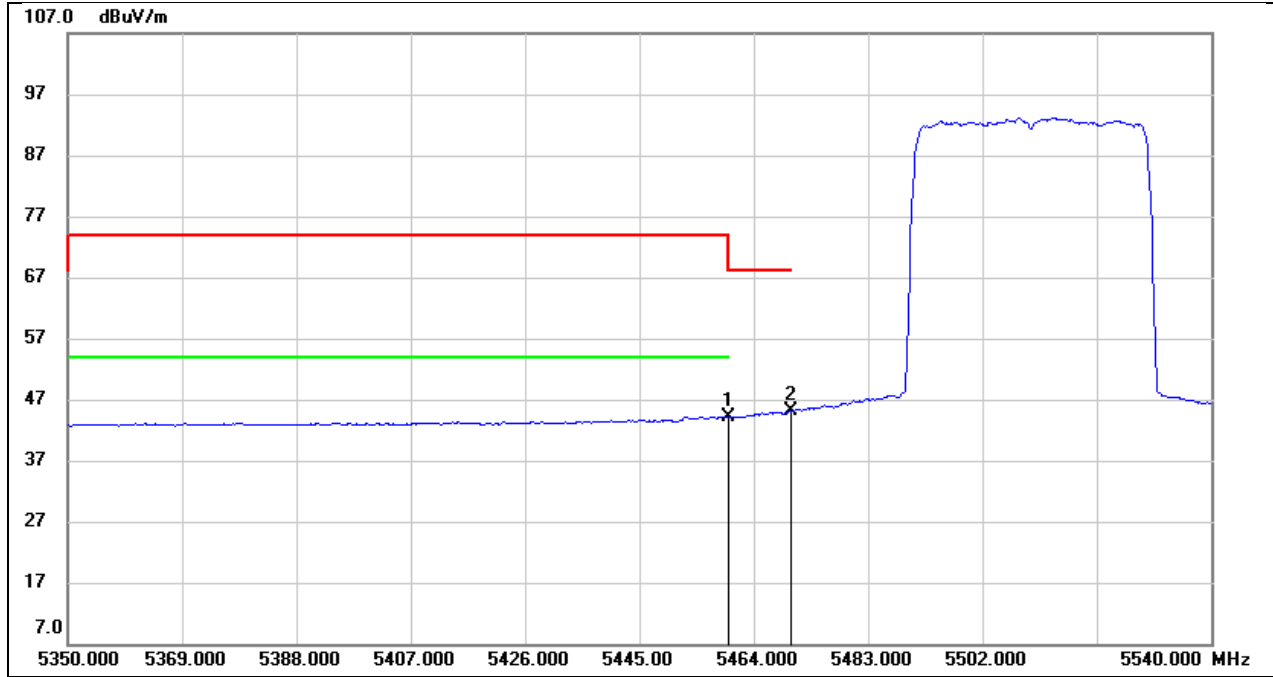

No.	Frequency (MHz)	Reading (dBuV)	Correct (dB/m)	Result (dBuV/m)	Limit (dBuV/m)	Margin (dB)	Remark
1	5460.000	3.43	40.62	44.05	54.00	-9.95	AVG
2	5470.000	4.46	40.63	45.09	/	/	AVG

Test Mode:	802.11ax HE40 PK	Frequency(MHz):	5670
Polarity:	Vertical	Test Voltage:	DC 12 V

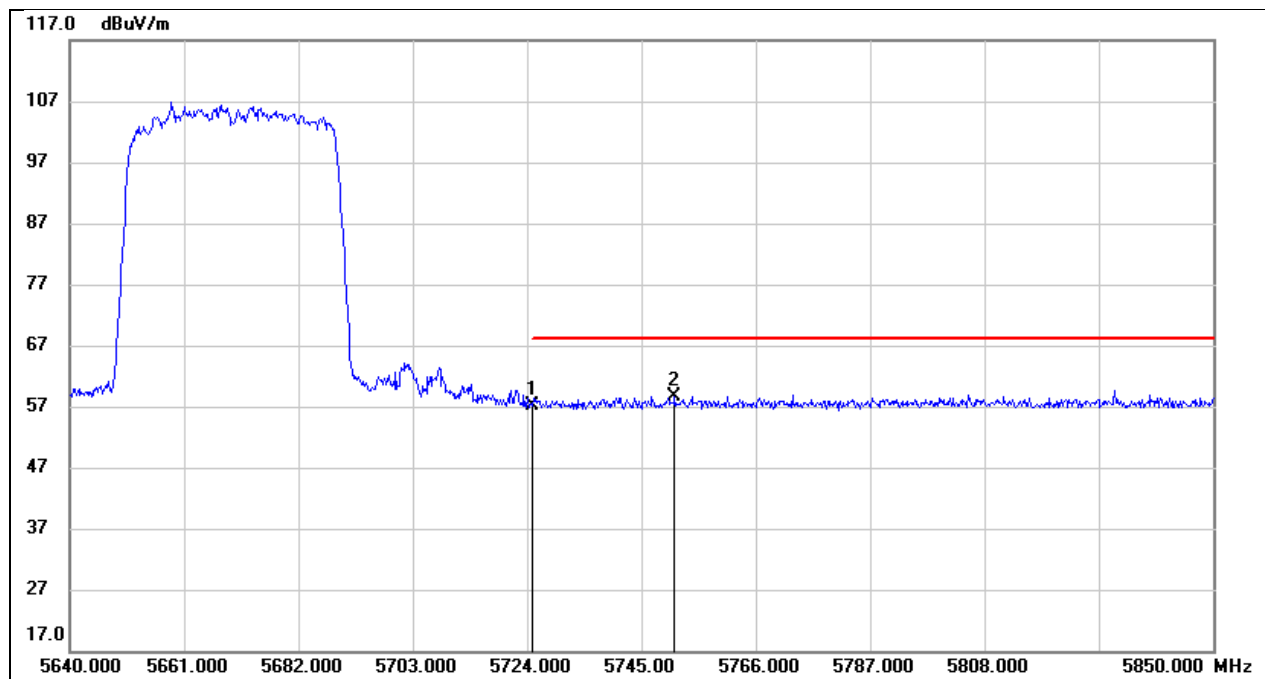

No.	Frequency (MHz)	Reading (dBuV)	Correct (dB/m)	Result (dBuV/m)	Limit (dBuV/m)	Margin (dB)	Remark
1	5725.000	15.79	41.27	57.06	68.20	-11.14	peak
2	5751.090	17.26	41.33	58.59	68.20	-9.61	peak

Test Mode:	802.11ax HE40 PK	Frequency(MHz):	5755
Polarity:	Vertical	Test Voltage:	DC 12 V

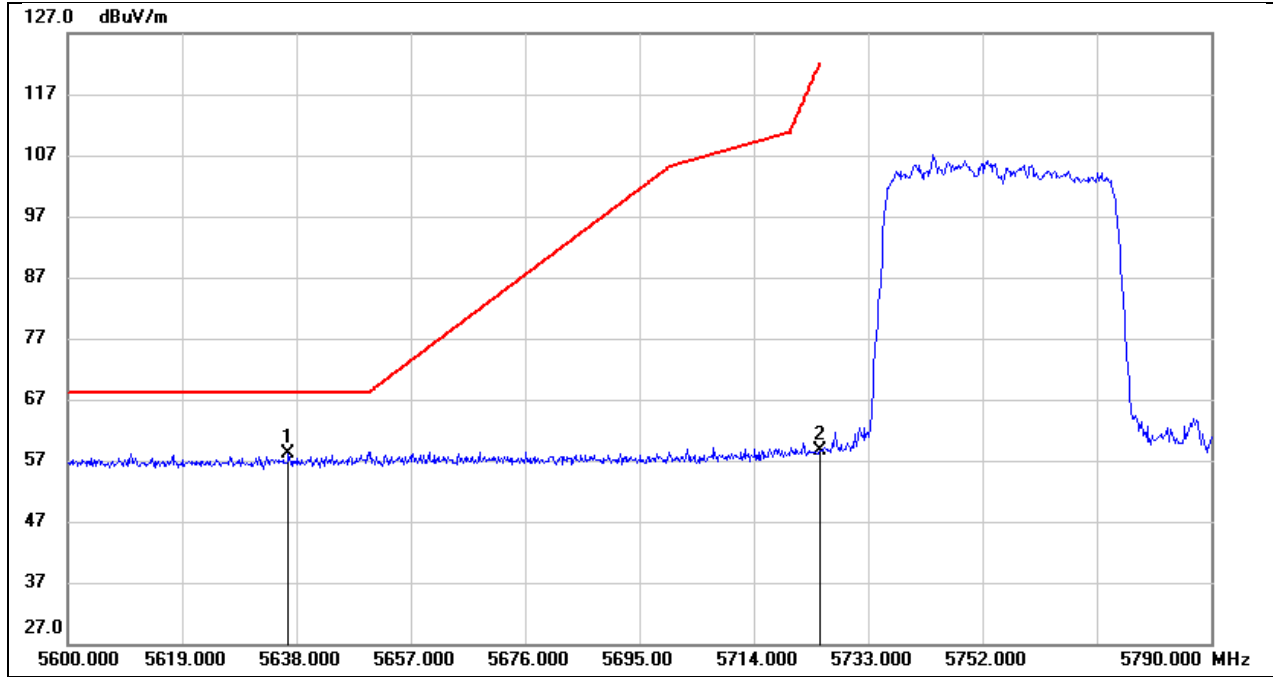

No.	Frequency (MHz)	Reading (dBuV)	Correct (dB/m)	Result (dBuV/m)	Limit (dBuV/m)	Margin (dB)	Remark
1	5636.670	17.08	41.03	58.11	68.20	-10.09	peak
2	5725.000	17.45	41.27	58.72	122.20	-63.48	peak

Test Mode:	802.11ax HE40 PK	Frequency(MHz):	5795
Polarity:	Vertical	Test Voltage:	DC 12 V

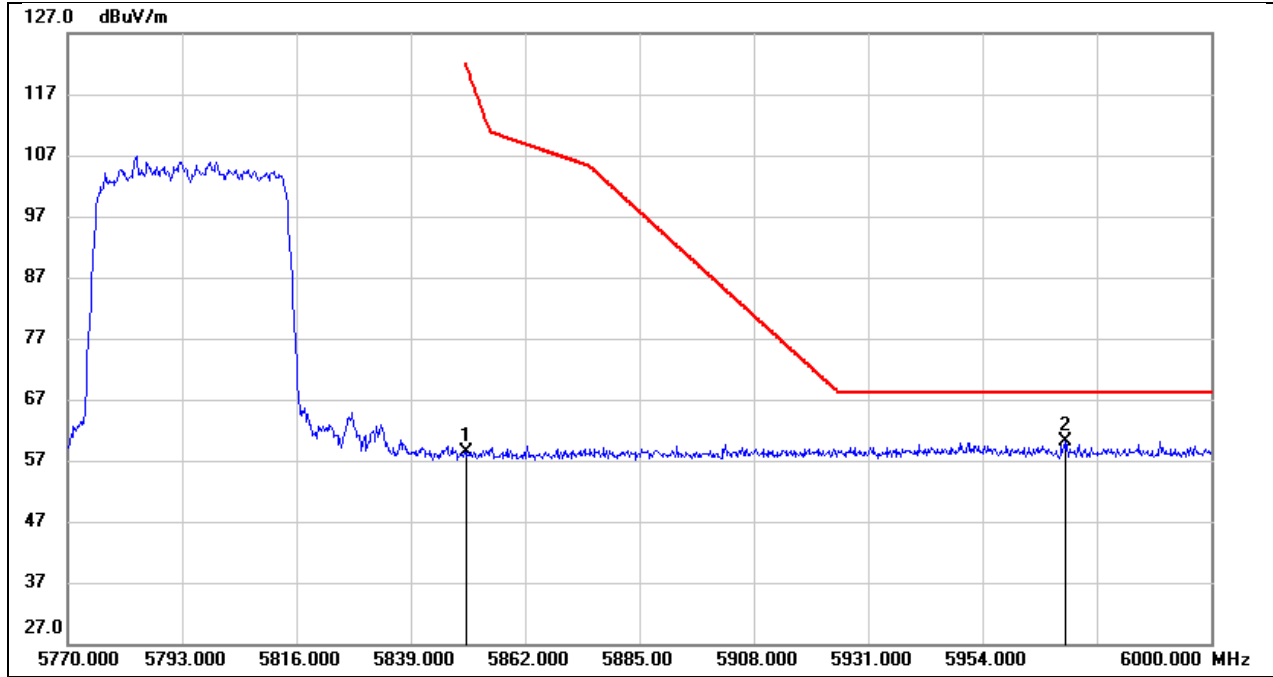

No.	Frequency (MHz)	Reading (dBuV)	Correct (dB/m)	Result (dBuV/m)	Limit (dBuV/m)	Margin (dB)	Remark
1	5850.000	16.71	41.60	58.31	122.20	-63.89	peak
2	5970.790	18.28	41.92	60.20	68.20	-8.00	peak

Test Mode:	802.11ax HE80 PK	Frequency(MHz):	5210
Polarity:	Vertical	Test Voltage:	DC 12 V

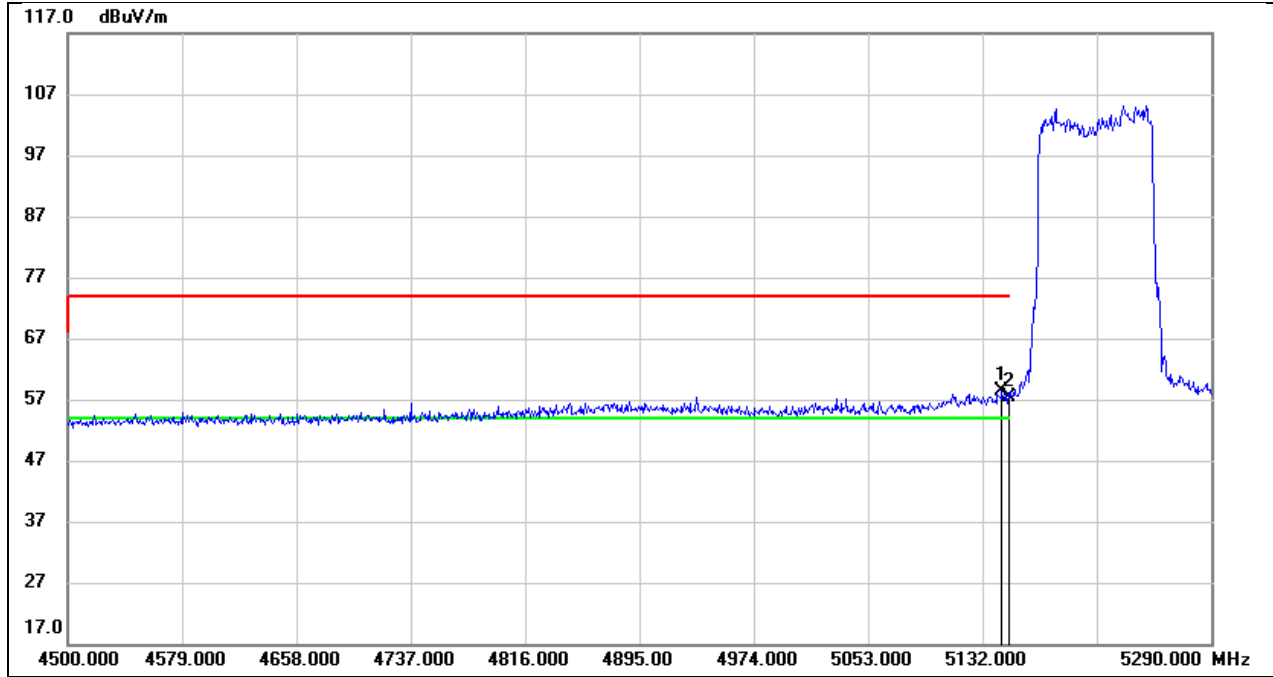

No.	Frequency (MHz)	Reading (dBuV)	Correct (dB/m)	Result (dBuV/m)	Limit (dBuV/m)	Margin (dB)	Remark
1	5145.430	17.99	40.27	58.26	74.00	-15.74	peak
2	5150.000	17.02	40.27	57.29	74.00	-16.71	peak

Test Mode:	802.11ax HE80 AV	Frequency(MHz):	5210
Polarity:	Vertical	Test Voltage:	DC 12 V

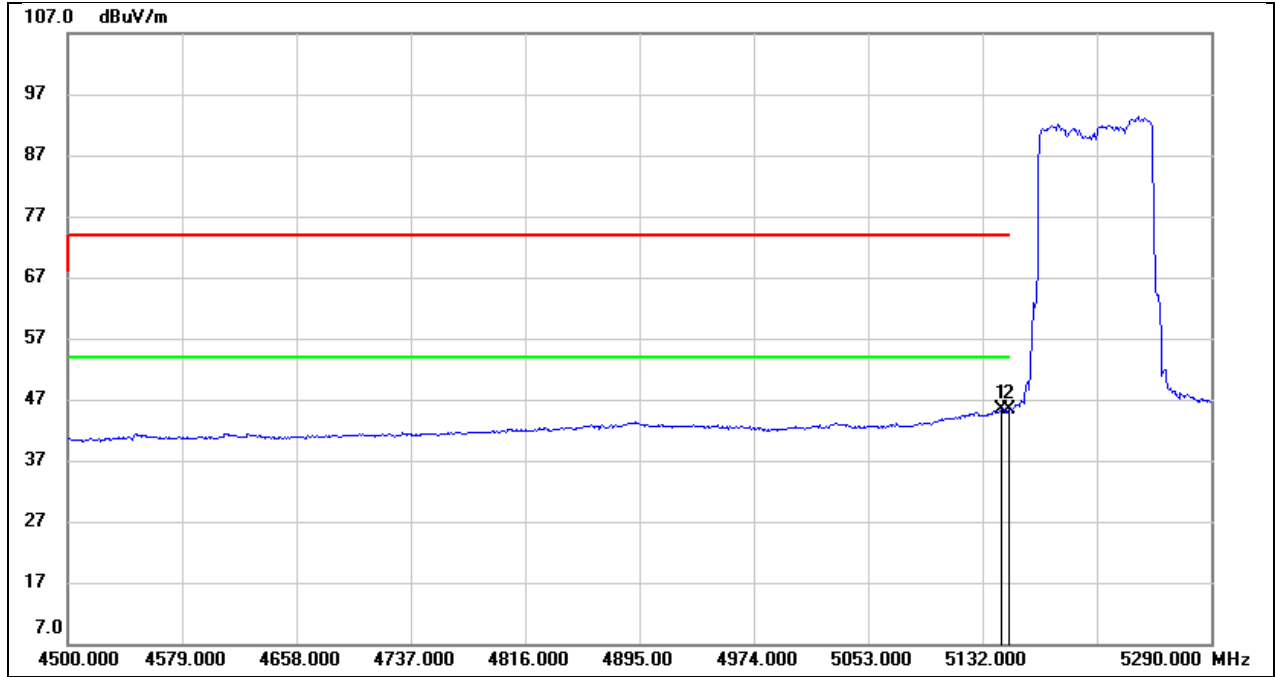

No.	Frequency (MHz)	Reading (dBuV)	Correct (dB/m)	Result (dBuV/m)	Limit (dBuV/m)	Margin (dB)	Remark
1	5145.430	5.02	40.27	45.29	54.00	-8.71	AVG
2	5150.000	5.15	40.27	45.42	54.00	-8.58	AVG

Test Mode:	802.11ax HE80 PK	Frequency(MHz):	5290
Polarity:	Vertical	Test Voltage:	DC 12 V

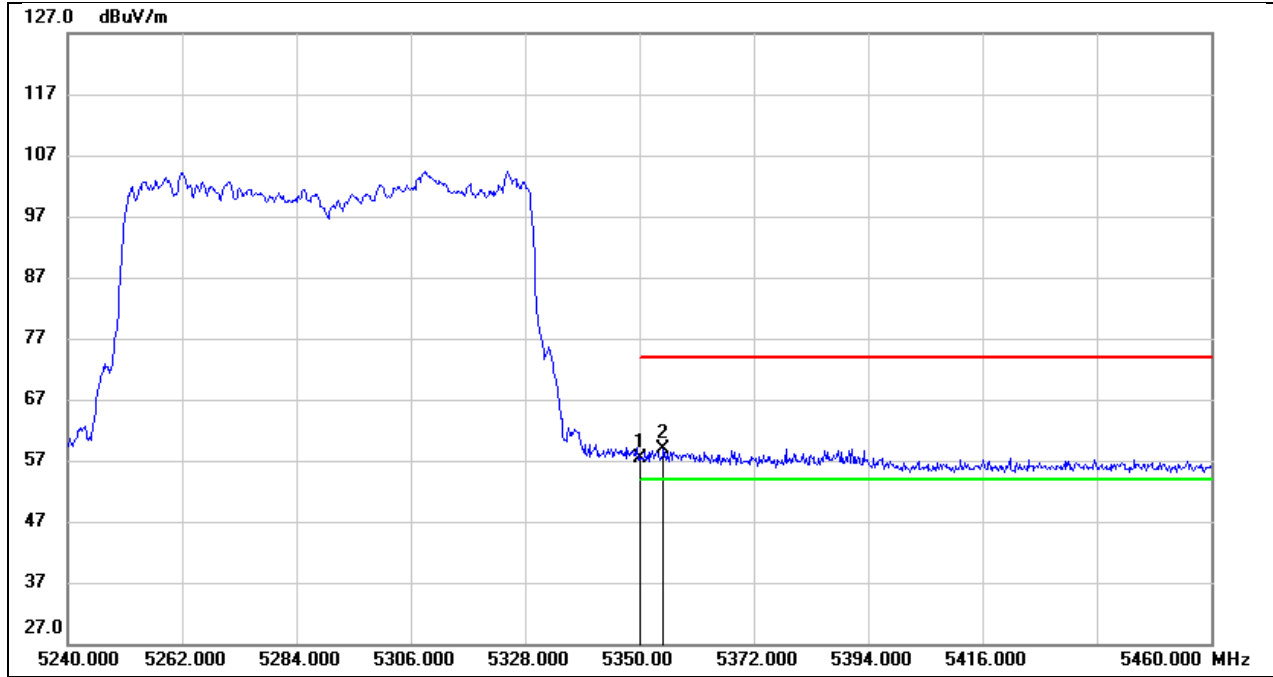

No.	Frequency (MHz)	Reading (dBuV)	Correct (dB/m)	Result (dBuV/m)	Limit (dBuV/m)	Margin (dB)	Remark
1	5350.000	16.94	40.49	57.43	74.00	-16.57	peak
2	5354.620	18.32	40.50	58.82	74.00	-15.18	peak

Test Mode:	802.11ax HE80 AV	Frequency(MHz):	5290
Polarity:	Vertical	Test Voltage:	DC 12 V

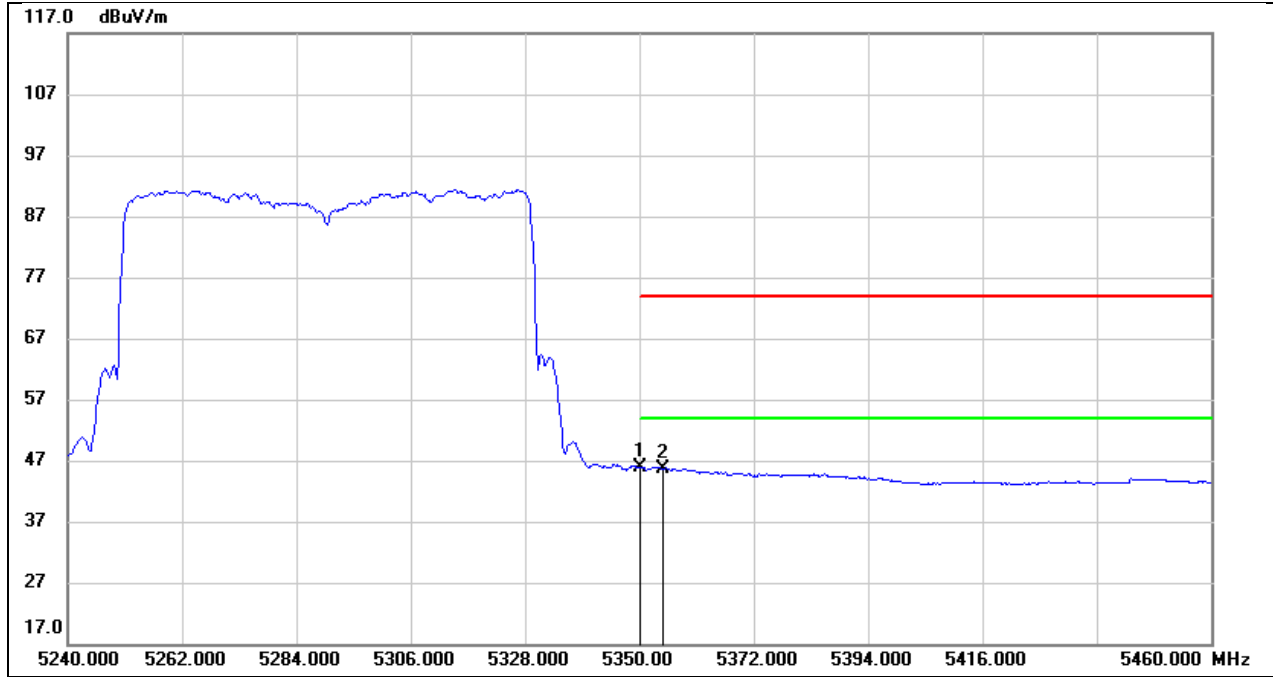

No.	Frequency (MHz)	Reading (dBuV)	Correct (dB/m)	Result (dBuV/m)	Limit (dBuV/m)	Margin (dB)	Remark
1	5350.000	5.32	40.49	45.81	54.00	-8.19	AVG
2	5354.620	5.12	40.50	45.62	54.00	-8.38	AVG

Test Mode:	802.11ax HE80 PK	Frequency(MHz):	5530
Polarity:	Vertical	Test Voltage:	DC 12 V

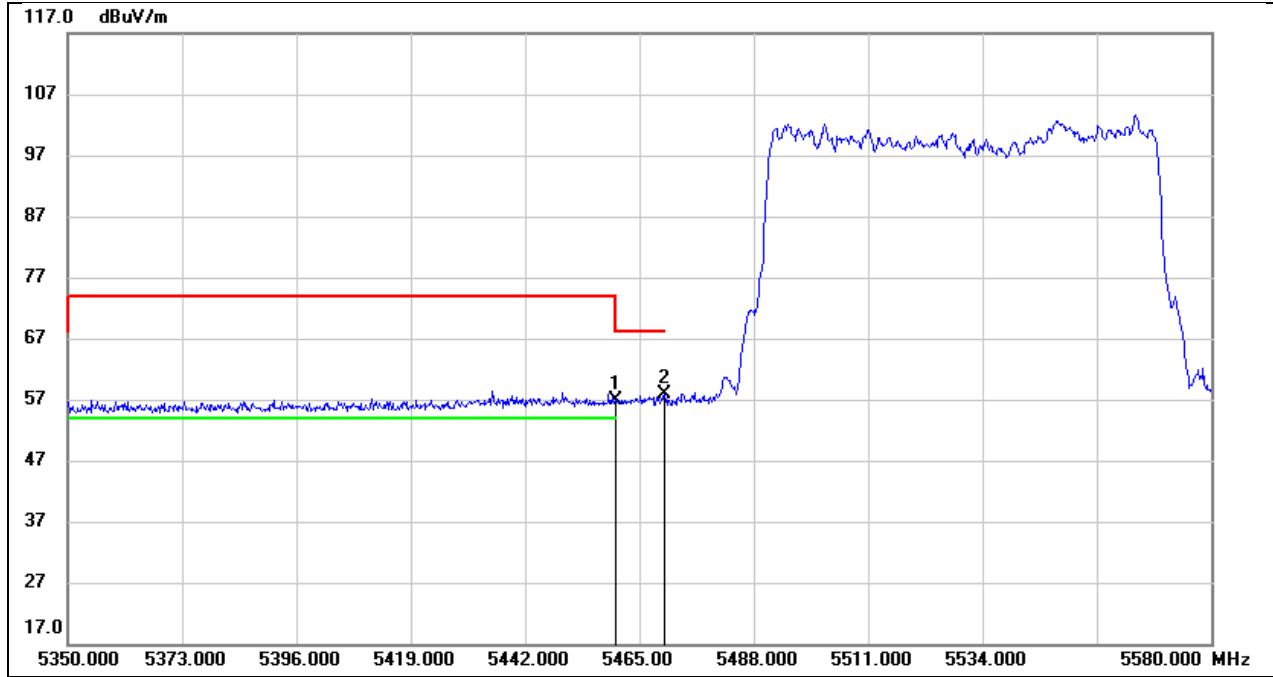

No.	Frequency (MHz)	Reading (dBuV)	Correct (dB/m)	Result (dBuV/m)	Limit (dBuV/m)	Margin (dB)	Remark
1	5460.000	16.14	40.62	56.76	74.00	-17.24	peak
2	5470.000	17.34	40.63	57.97	68.20	-10.23	peak

Test Mode:	802.11ax HE80 AV	Frequency(MHz):	5530
Polarity:	Vertical	Test Voltage:	DC 12 V

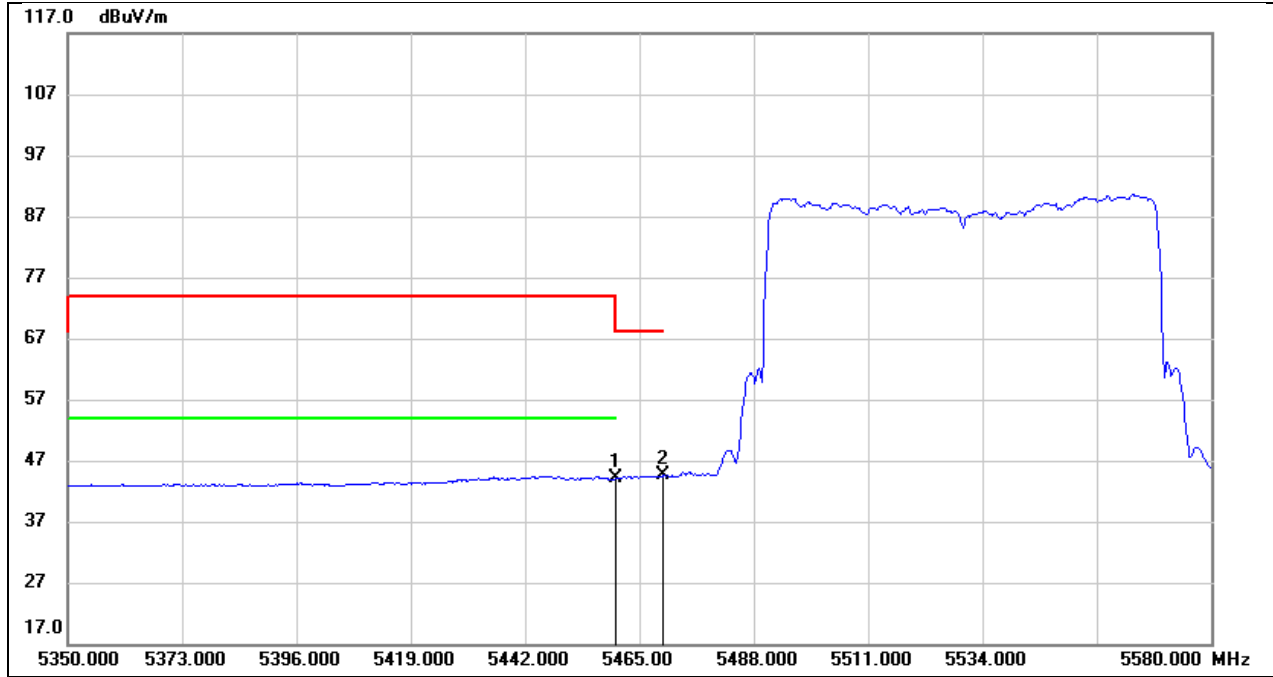

No.	Frequency (MHz)	Reading (dBuV)	Correct (dB/m)	Result (dBuV/m)	Limit (dBuV/m)	Margin (dB)	Remark
1	5460.000	3.39	40.62	44.01	54.00	-9.99	AVG
2	5470.000	3.88	40.63	44.51	/	/	AVG

Test Mode:	802.11ax HE80 PK	Frequency(MHz):	5610
Polarity:	Vertical	Test Voltage:	DC 12 V

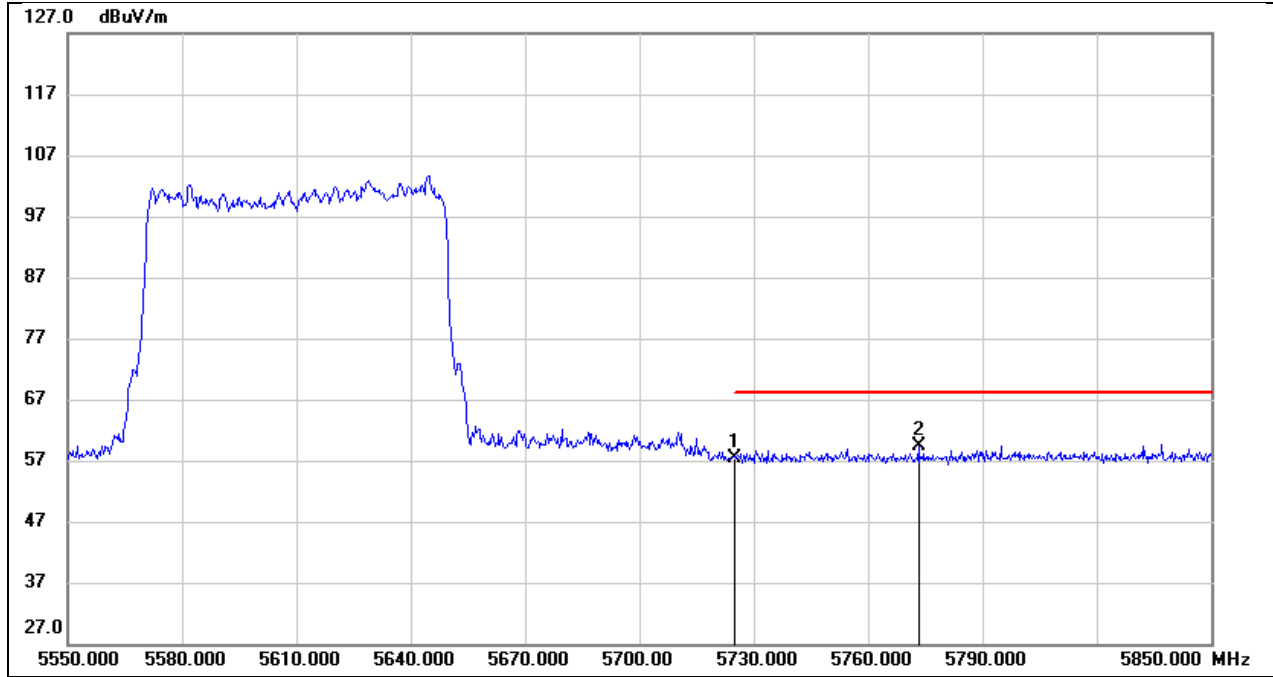

No.	Frequency (MHz)	Reading (dBuV)	Correct (dB/m)	Result (dBuV/m)	Limit (dBuV/m)	Margin (dB)	Remark
1	5725.000	16.21	41.27	57.48	68.20	-10.72	peak
2	5773.200	17.87	41.39	59.26	68.20	-8.94	peak

Test Mode:	802.11ax HE80 PK	Frequency(MHz):	5775
Polarity:	Vertical	Test Voltage:	DC 12 V

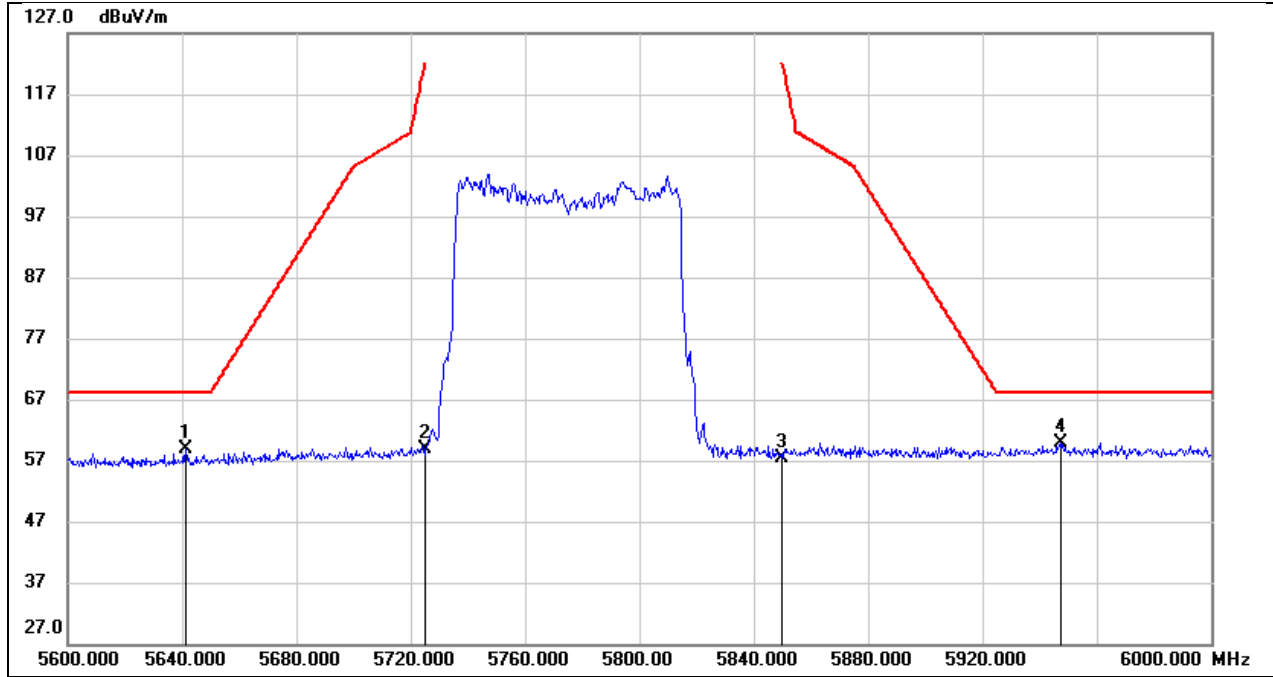

No.	Frequency (MHz)	Reading (dBuV)	Correct (dB/m)	Result (dBuV/m)	Limit (dBuV/m)	Margin (dB)	Remark
1	5641.200	17.75	41.04	58.79	68.20	-9.41	peak
2	5725.000	17.57	41.27	58.84	122.20	-63.36	peak
3	5850.000	15.74	41.60	57.34	122.20	-64.86	peak
4	5947.200	18.12	41.86	59.98	68.20	-8.22	peak

8.2. SPURIOUS EMISSIONS(1 GHZ~7 GHZ)

Test Mode:	802.11a 20	Frequency(MHz):	5180
Polarity:	Horizontal	Test Voltage:	DC 12 V

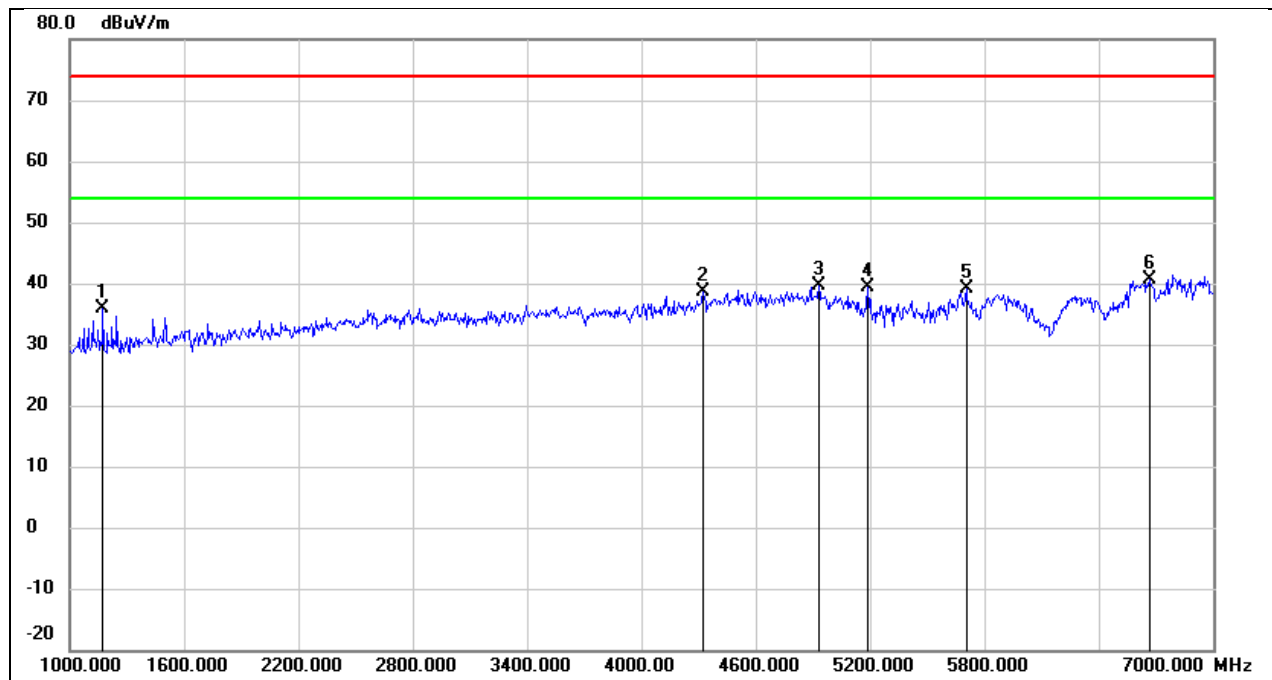

No.	Frequency (MHz)	Reading (dBuV)	Correct (dB/m)	Result (dBuV/m)	Limit (dBuV/m)	Margin (dB)	Remark
1	1174.000	50.19	-14.22	35.97	74.00	-38.03	peak
2	4324.000	41.49	-2.96	38.53	74.00	-35.47	peak
3	4930.000	40.11	-0.43	39.68	74.00	-34.32	peak
4	5188.000	39.27	0.07	39.34	74.00	-34.66	peak
5	5704.000	38.24	1.00	39.24	74.00	-34.76	peak
6	6664.000	35.98	4.54	40.52	74.00	-33.48	peak

Test Mode:	802.11a 20	Frequency(MHz):	5180
Polarity:	Vertical	Test Voltage:	DC 12 V

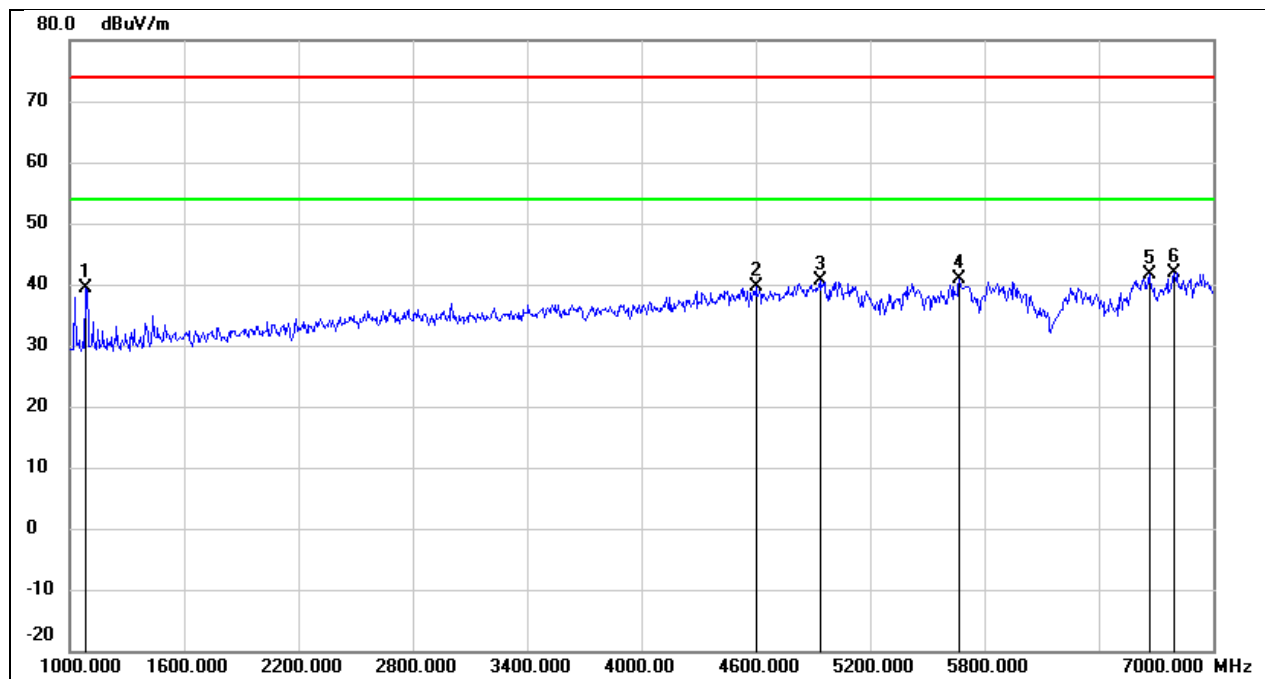

No.	Frequency (MHz)	Reading (dBuV)	Correct (dB/m)	Result (dBuV/m)	Limit (dBuV/m)	Margin (dB)	Remark
1	1084.000	53.93	-14.64	39.29	74.00	-34.71	peak
2	4600.000	41.46	-1.74	39.72	74.00	-34.28	peak
3	4936.000	41.14	-0.40	40.74	74.00	-33.26	peak
4	5668.000	39.87	0.91	40.78	74.00	-33.22	peak
5	6664.000	37.13	4.54	41.67	74.00	-32.33	peak
6	6796.000	36.77	5.19	41.96	74.00	-32.04	peak

Test Mode:	802.11a 20	Frequency(MHz):	5200
Polarity:	Horizontal	Test Voltage:	DC 12 V

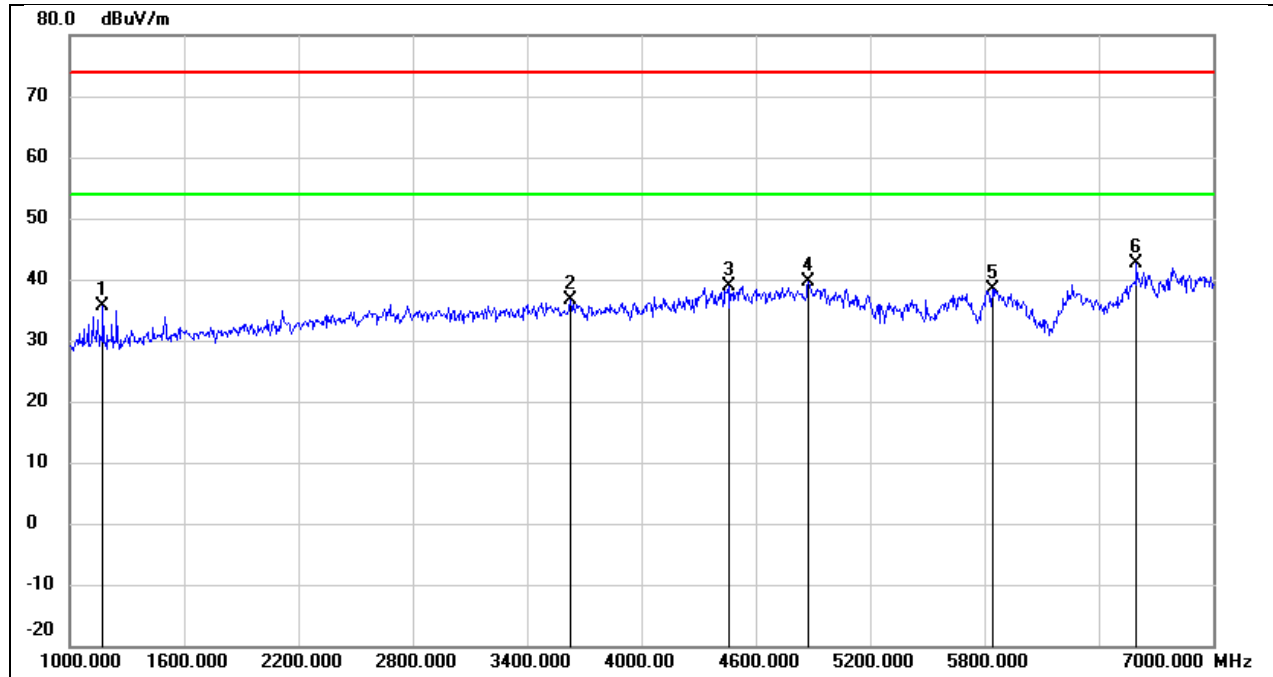

No.	Frequency (MHz)	Reading (dBuV)	Correct (dB/m)	Result (dBuV/m)	Limit (dBuV/m)	Margin (dB)	Remark
1	1174.000	49.78	-14.22	35.56	74.00	-38.44	peak
2	3628.000	42.11	-5.50	36.61	74.00	-37.39	peak
3	4456.000	41.19	-2.35	38.84	74.00	-35.16	peak
4	4876.000	40.30	-0.64	39.66	74.00	-34.34	peak
5	5842.000	36.97	1.39	38.36	74.00	-35.64	peak
6	6598.000	38.50	4.21	42.71	74.00	-31.29	peak

Test Mode:	802.11a 20	Frequency(MHz):	5200
Polarity:	Vertical	Test Voltage:	DC 12 V

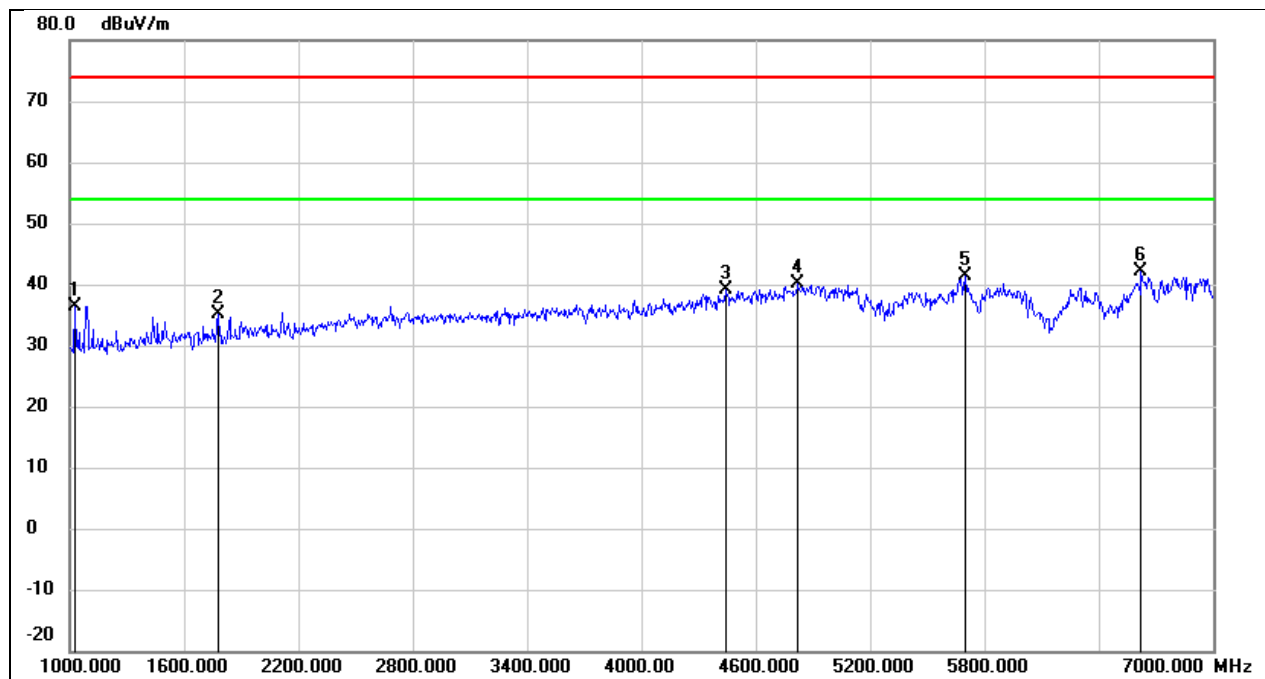

No.	Frequency (MHz)	Reading (dBuV)	Correct (dB/m)	Result (dBuV/m)	Limit (dBuV/m)	Margin (dB)	Remark
1	1024.000	51.30	-14.92	36.38	74.00	-37.62	peak
2	1780.000	46.83	-11.79	35.04	74.00	-38.96	peak
3	4444.000	41.46	-2.40	39.06	74.00	-34.94	peak
4	4822.000	41.02	-0.85	40.17	74.00	-33.83	peak
5	5698.000	40.30	0.99	41.29	74.00	-32.71	peak
6	6622.000	37.86	4.32	42.18	74.00	-31.82	peak

Test Mode:	802.11a 20	Frequency(MHz):	5240
Polarity:	Horizontal	Test Voltage:	DC 12 V

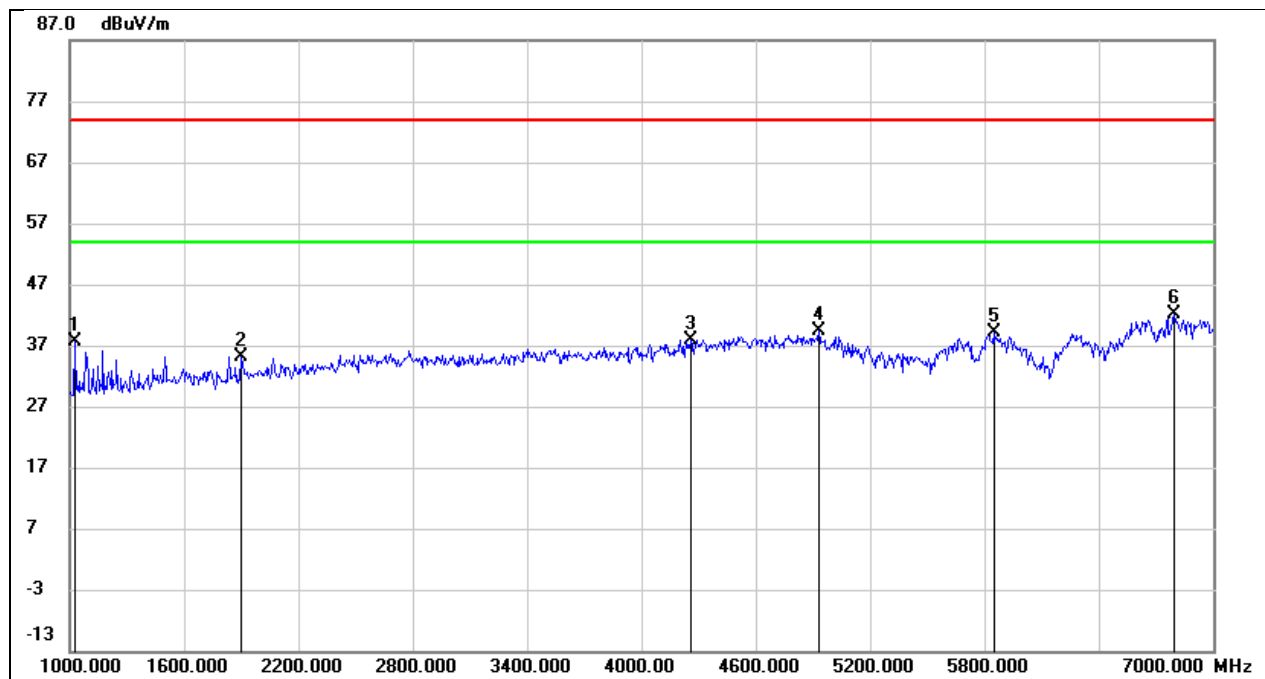

No.	Frequency (MHz)	Reading (dBuV)	Correct (dB/m)	Result (dBuV/m)	Limit (dBuV/m)	Margin (dB)	Remark
1	1024.000	52.65	-14.92	37.73	74.00	-36.27	peak
2	1900.000	46.48	-11.39	35.09	74.00	-38.91	peak
3	4258.000	41.25	-3.27	37.98	74.00	-36.02	peak
4	4930.000	39.88	-0.43	39.45	74.00	-34.55	peak
5	5848.000	37.81	1.41	39.22	74.00	-34.78	peak
6	6796.000	36.84	5.19	42.03	74.00	-31.97	peak

Test Mode:	802.11a 20	Frequency(MHz):	5240
Polarity:	Vertical	Test Voltage:	DC 12 V

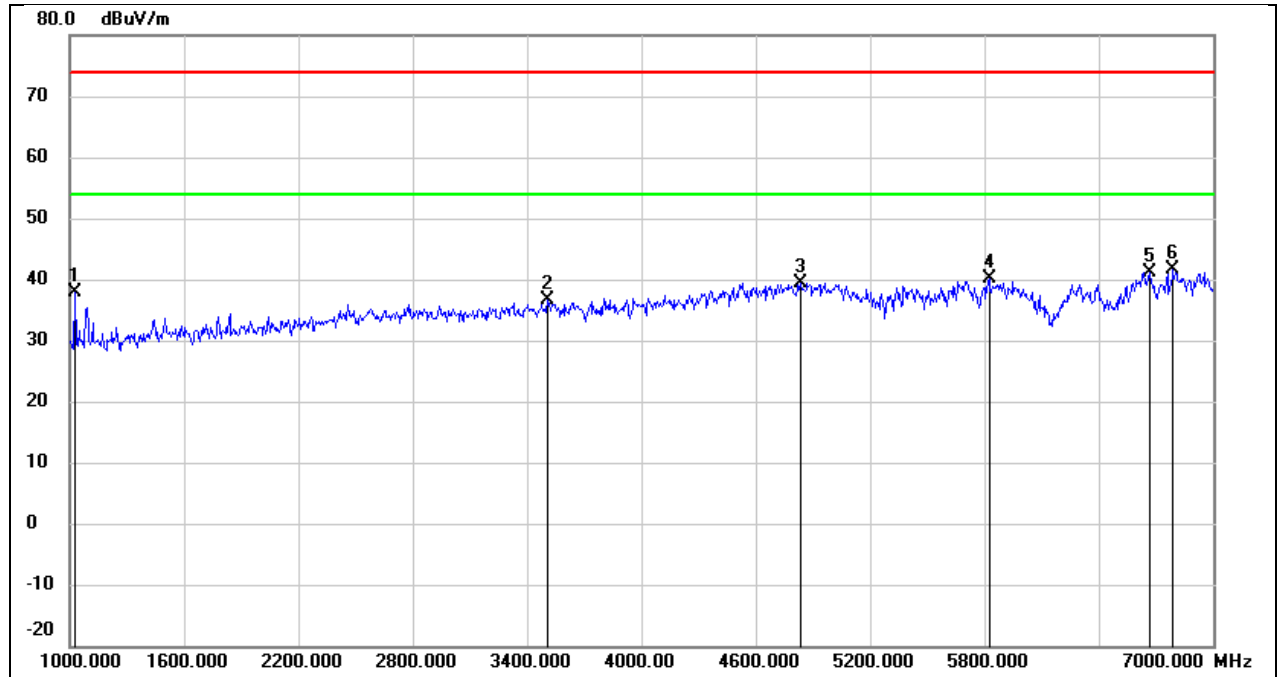

No.	Frequency (MHz)	Reading (dBuV)	Correct (dB/m)	Result (dBuV/m)	Limit (dBuV/m)	Margin (dB)	Remark
1	1024.000	52.86	-14.92	37.94	74.00	-36.06	peak
2	3508.000	42.36	-5.82	36.54	74.00	-37.46	peak
3	4834.000	40.25	-0.81	39.44	74.00	-34.56	peak
4	5824.000	38.67	1.34	40.01	74.00	-33.99	peak
5	6664.000	36.65	4.54	41.19	74.00	-32.81	peak
6	6790.000	36.58	5.15	41.73	74.00	-32.27	peak

Test Mode:	802.11a 20	Frequency(MHz):	5260
Polarity:	Horizontal	Test Voltage:	DC 12 V

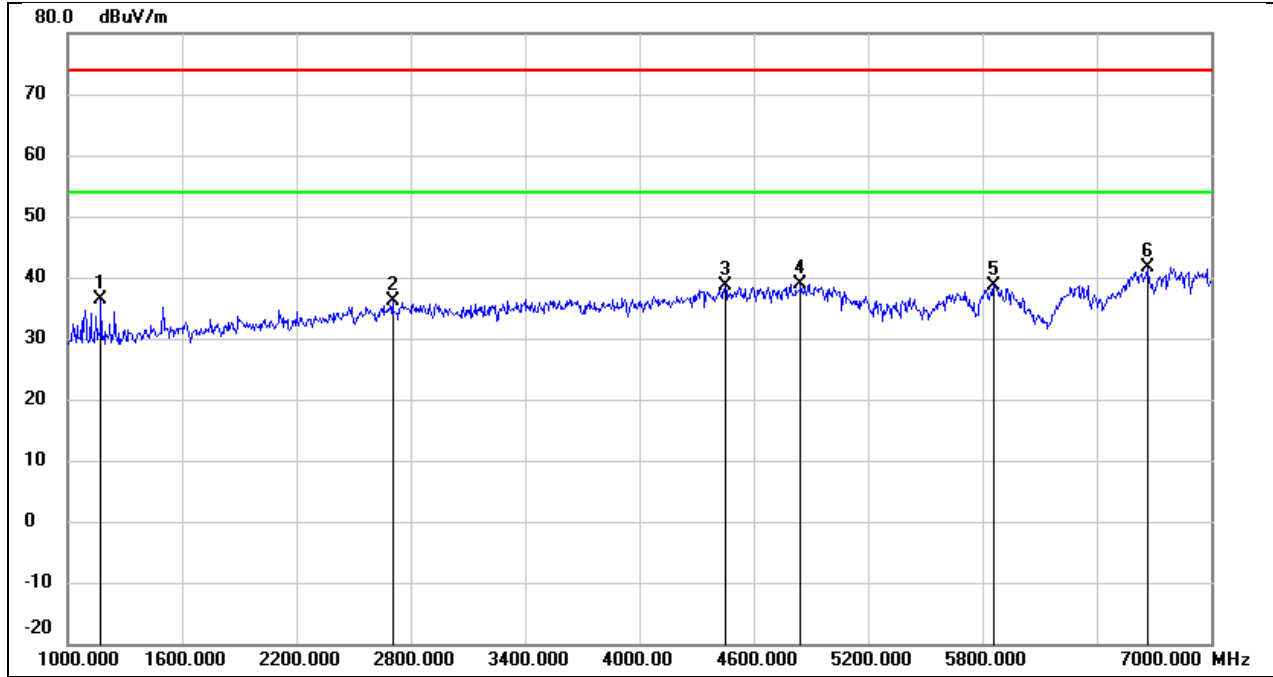

No.	Frequency (MHz)	Reading (dBuV)	Correct (dB/m)	Result (dBuV/m)	Limit (dBuV/m)	Margin (dB)	Remark
1	1174.000	50.58	-14.22	36.36	74.00	-37.64	peak
2	2704.000	43.91	-7.87	36.04	74.00	-37.96	peak
3	4450.000	41.11	-2.37	38.74	74.00	-35.26	peak
4	4846.000	39.72	-0.77	38.95	74.00	-35.05	peak
5	5860.000	37.23	1.45	38.68	74.00	-35.32	peak
6	6664.000	37.13	4.54	41.67	74.00	-32.33	peak

Test Mode:	802.11a 20	Frequency(MHz):	5260
Polarity:	Vertical	Test Voltage:	DC 12 V

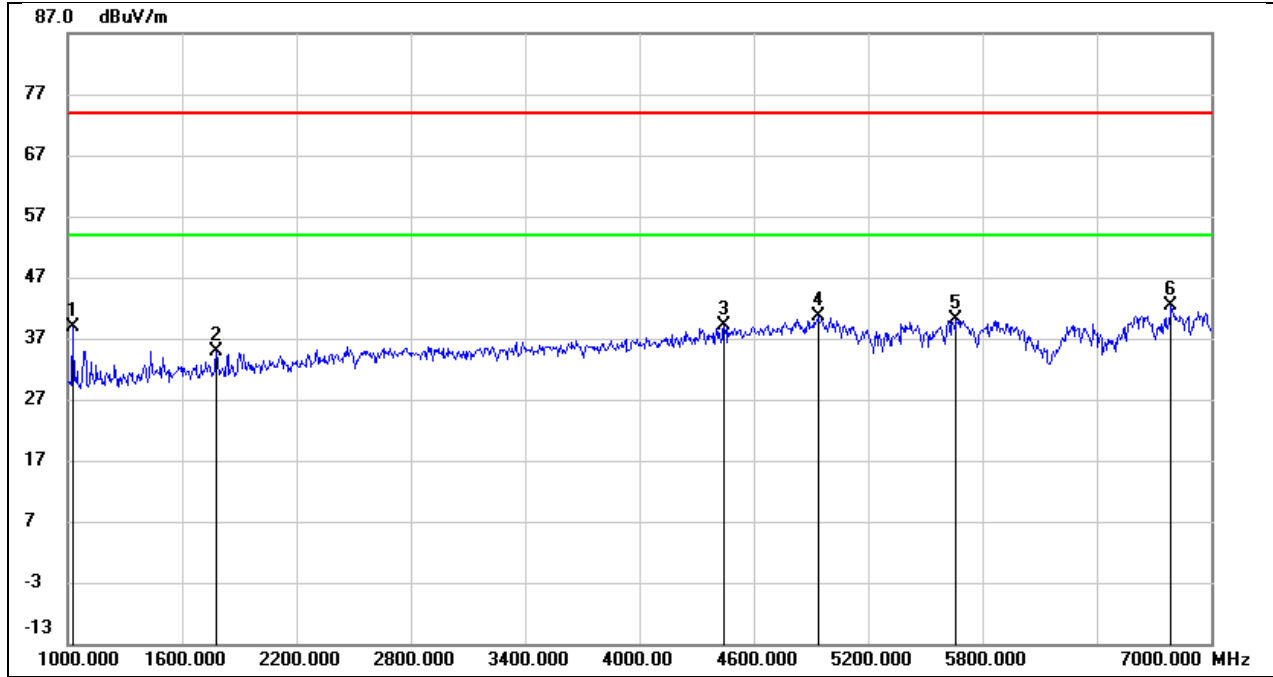

No.	Frequency (MHz)	Reading (dBuV)	Correct (dB/m)	Result (dBuV/m)	Limit (dBuV/m)	Margin (dB)	Remark
1	1024.000	53.86	-14.92	38.94	74.00	-35.06	peak
2	1780.000	46.58	-11.79	34.79	74.00	-39.21	peak
3	4444.000	41.56	-2.40	39.16	74.00	-34.84	peak
4	4936.000	41.00	-0.40	40.60	74.00	-33.40	peak
5	5662.000	39.31	0.89	40.20	74.00	-33.80	peak
6	6790.000	37.11	5.15	42.26	74.00	-31.74	peak

Test Mode:	802.11a 20	Frequency(MHz):	5280
Polarity:	Horizontal	Test Voltage:	DC 12 V

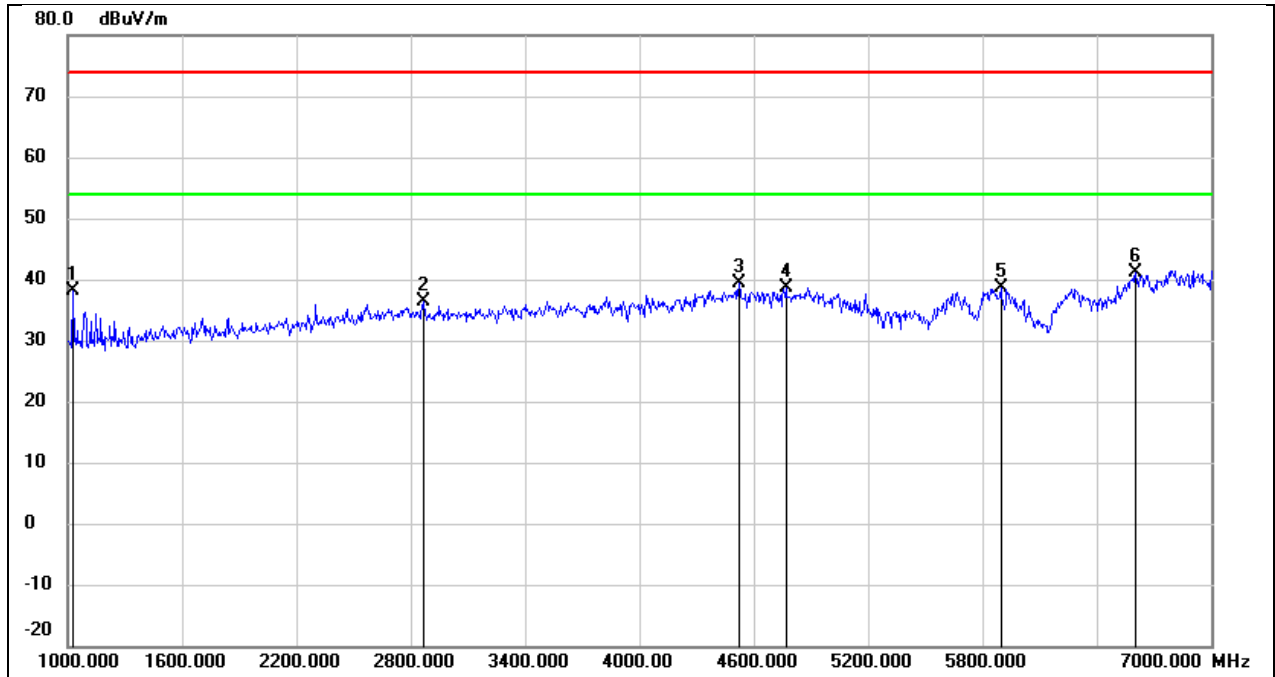

No.	Frequency (MHz)	Reading (dBuV)	Correct (dB/m)	Result (dBuV/m)	Limit (dBuV/m)	Margin (dB)	Remark
1	1024.000	53.01	-14.92	38.09	74.00	-35.91	peak
2	2866.000	43.77	-7.38	36.39	74.00	-37.61	peak
3	4522.000	41.40	-2.05	39.35	74.00	-34.65	peak
4	4768.000	39.68	-1.07	38.61	74.00	-35.39	peak
5	5896.000	37.02	1.56	38.58	74.00	-35.42	peak
6	6604.000	36.78	4.24	41.02	74.00	-32.98	peak

Test Mode:	802.11a 20	Frequency(MHz):	5280
Polarity:	Vertical	Test Voltage:	DC 12 V

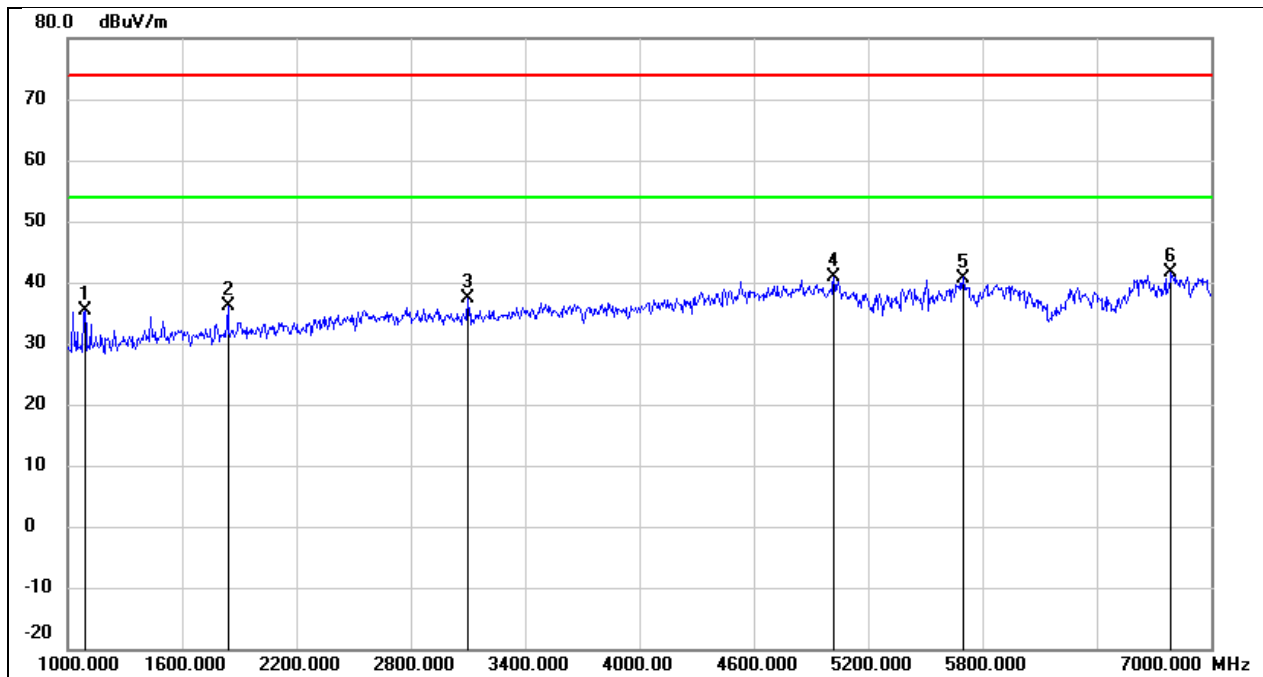

No.	Frequency (MHz)	Reading (dBuV)	Correct (dB/m)	Result (dBuV/m)	Limit (dBuV/m)	Margin (dB)	Remark
1	1090.000	49.95	-14.61	35.34	74.00	-38.66	peak
2	1840.000	47.79	-11.58	36.21	74.00	-37.79	peak
3	3100.000	44.20	-6.75	37.45	74.00	-36.55	peak
4	5020.000	40.98	-0.13	40.85	74.00	-33.15	peak
5	5698.000	39.76	0.99	40.75	74.00	-33.25	peak
6	6790.000	36.52	5.15	41.67	74.00	-32.33	peak

Test Mode:	802.11a 20	Frequency(MHz):	5320
Polarity:	Horizontal	Test Voltage:	DC 12 V

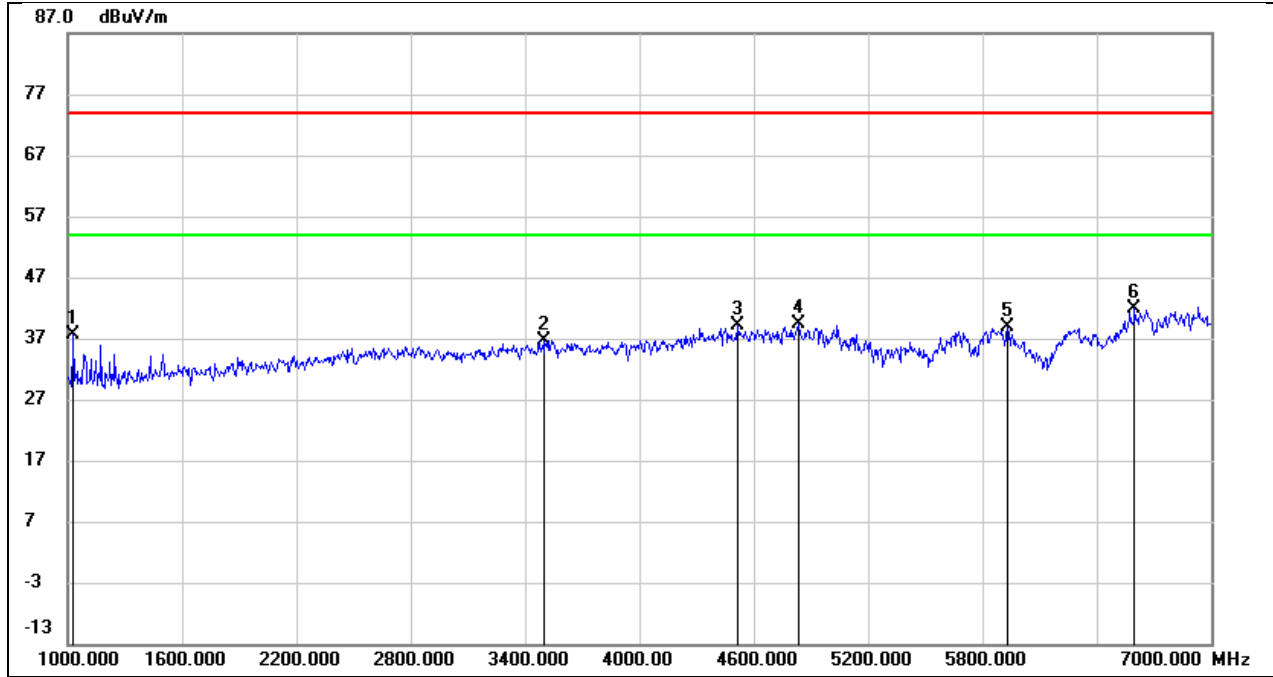

No.	Frequency (MHz)	Reading (dBuV)	Correct (dB/m)	Result (dBuV/m)	Limit (dBuV/m)	Margin (dB)	Remark
1	1030.000	52.59	-14.89	37.70	74.00	-36.30	peak
2	3502.000	42.60	-5.85	36.75	74.00	-37.25	peak
3	4516.000	41.10	-2.08	39.02	74.00	-34.98	peak
4	4834.000	40.21	-0.81	39.40	74.00	-34.60	peak
5	5932.000	37.31	1.65	38.96	74.00	-35.04	peak
6	6598.000	37.64	4.21	41.85	74.00	-32.15	peak

Test Mode:	802.11a 20	Frequency(MHz):	5320
Polarity:	Vertical	Test Voltage:	DC 12 V

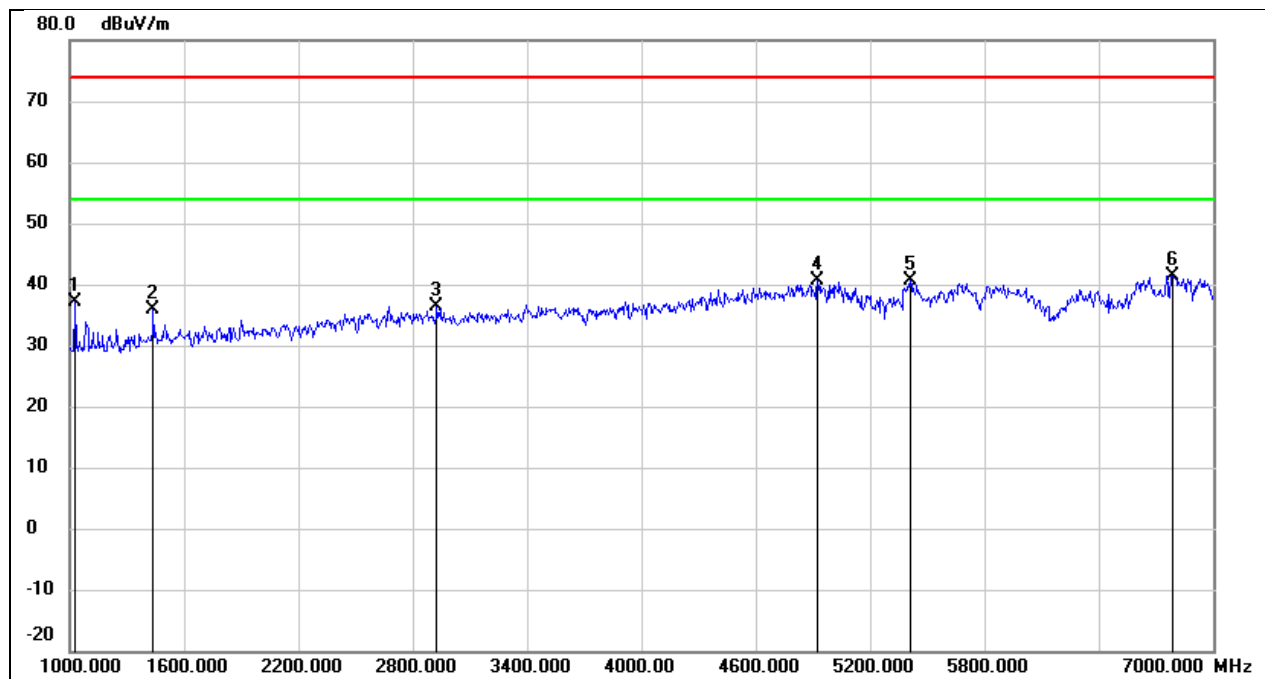

No.	Frequency (MHz)	Reading (dBuV)	Correct (dB/m)	Result (dBuV/m)	Limit (dBuV/m)	Margin (dB)	Remark
1	1030.000	52.13	-14.89	37.24	74.00	-36.76	peak
2	1438.000	48.88	-13.00	35.88	74.00	-38.12	peak
3	2926.000	43.53	-7.20	36.33	74.00	-37.67	peak
4	4924.000	41.15	-0.45	40.70	74.00	-33.30	peak
5	5410.000	40.33	0.32	40.65	74.00	-33.35	peak
6	6784.000	36.26	5.13	41.39	74.00	-32.61	peak

Test Mode:	802.11a 20	Frequency(MHz):	5500
Polarity:	Horizontal	Test Voltage:	DC 12 V

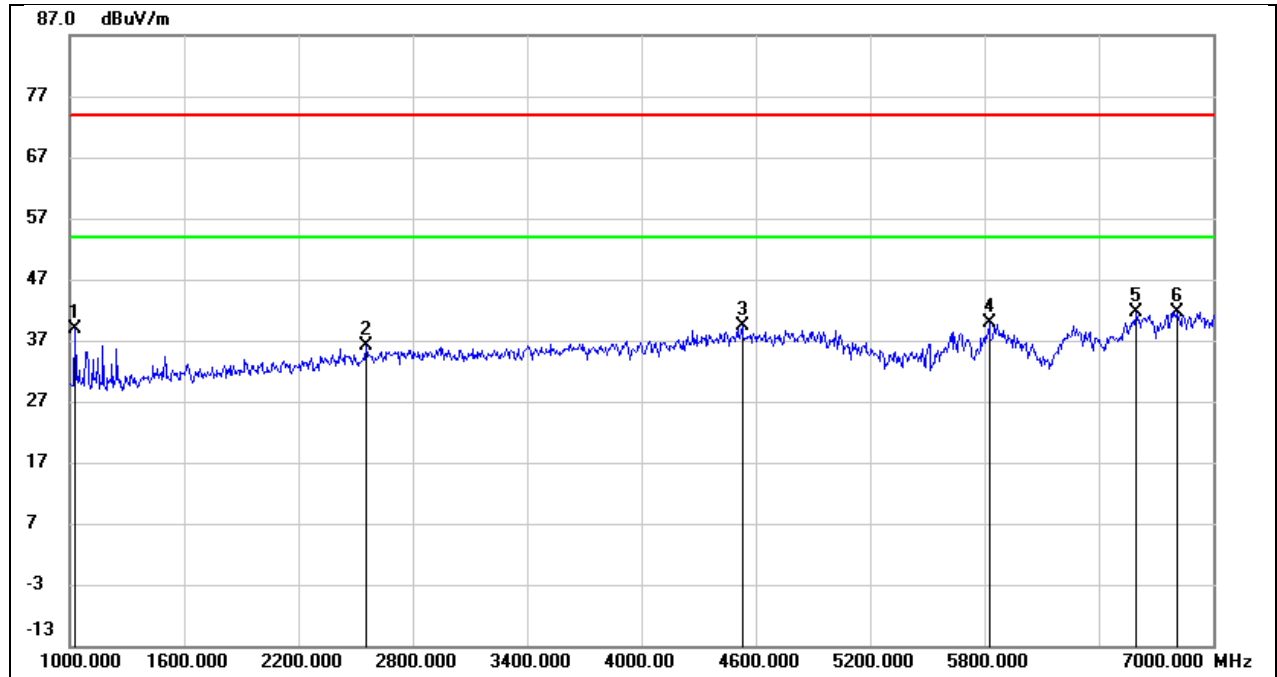

No.	Frequency (MHz)	Reading (dBuV)	Correct (dB/m)	Result (dBuV/m)	Limit (dBuV/m)	Margin (dB)	Remark
1	1024.000	53.78	-14.92	38.86	74.00	-35.14	peak
2	2554.000	44.38	-8.32	36.06	74.00	-37.94	peak
3	4528.000	41.44	-2.03	39.41	74.00	-34.59	peak
4	5824.000	38.54	1.34	39.88	74.00	-34.12	peak
5	6598.000	37.43	4.21	41.64	74.00	-32.36	peak
6	6808.000	36.43	5.24	41.67	74.00	-32.33	peak

Test Mode:	802.11a 20	Frequency(MHz):	5500
Polarity:	Vertical	Test Voltage:	DC 12 V

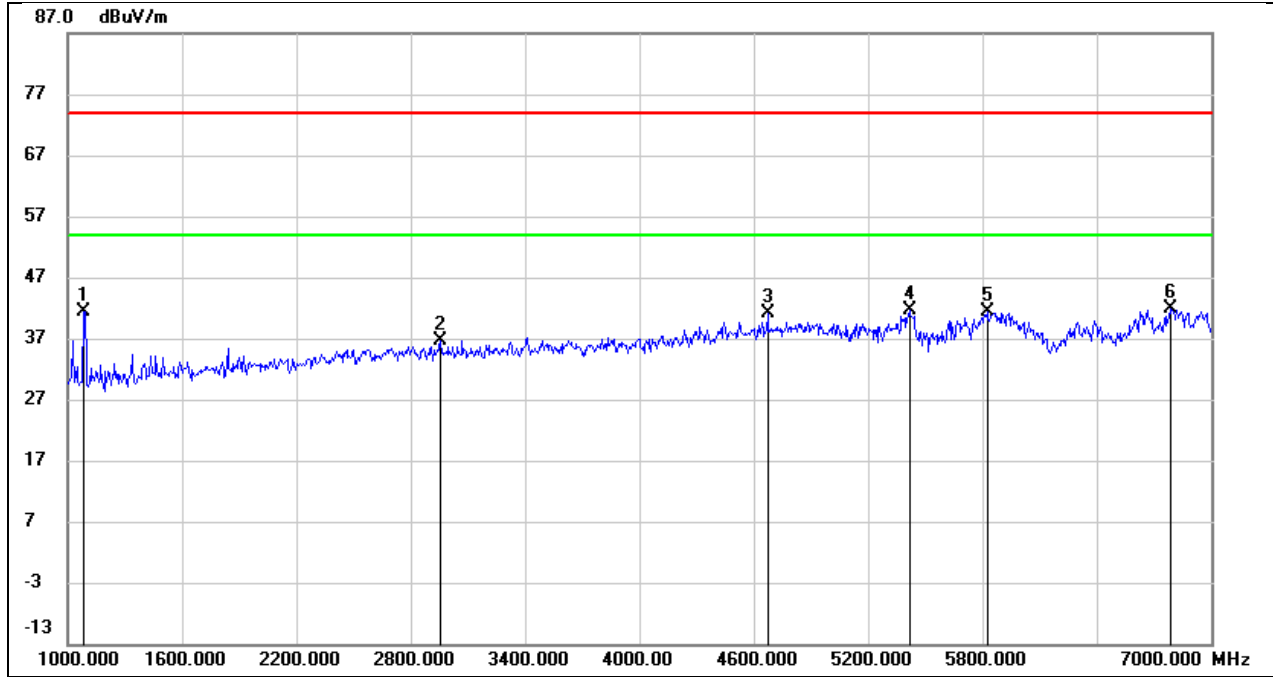

No.	Frequency (MHz)	Reading (dBuV)	Correct (dB/m)	Result (dBuV/m)	Limit (dBuV/m)	Margin (dB)	Remark
1	1084.000	55.96	-14.64	41.32	74.00	-32.68	peak
2	2956.000	43.77	-7.11	36.66	74.00	-37.34	peak
3	4672.000	42.49	-1.46	41.03	74.00	-32.97	peak
4	5416.000	41.24	0.32	41.56	74.00	-32.44	peak
5	5824.000	39.95	1.34	41.29	74.00	-32.71	peak
6	6784.000	36.65	5.13	41.78	74.00	-32.22	peak

Test Mode:	802.11a 20	Frequency(MHz):	5580
Polarity:	Horizontal	Test Voltage:	DC 12 V

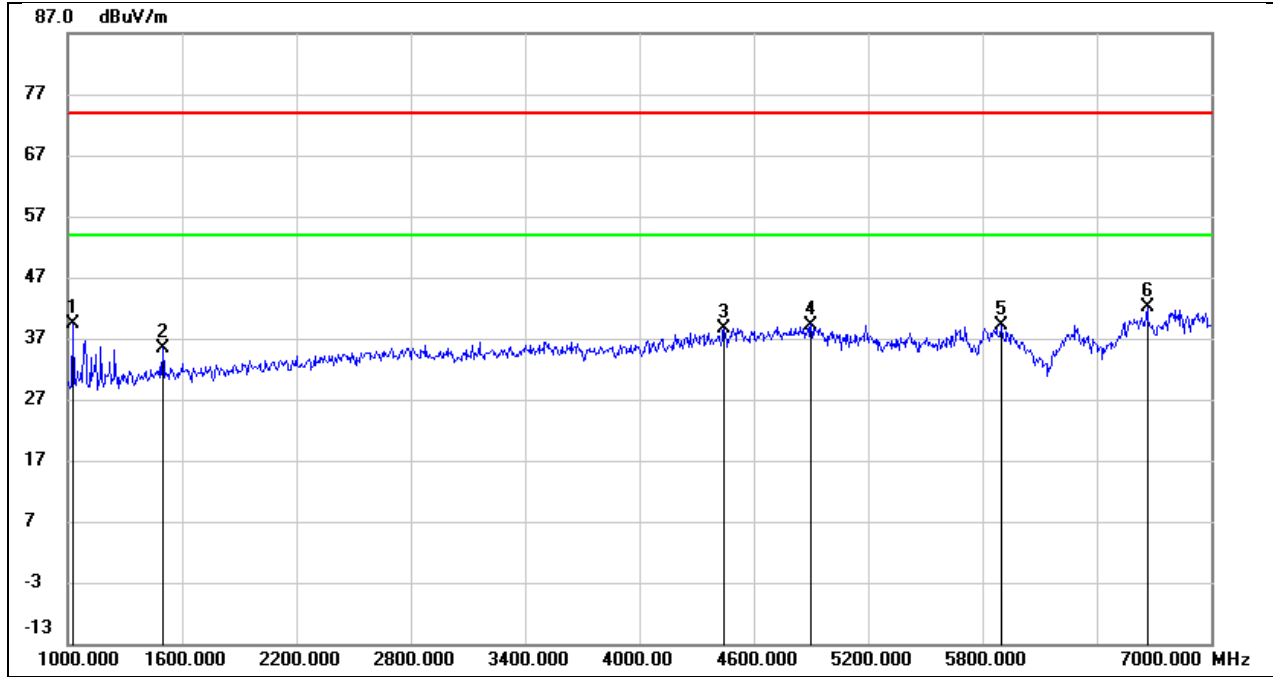

No.	Frequency (MHz)	Reading (dBuV)	Correct (dB/m)	Result (dBuV/m)	Limit (dBuV/m)	Margin (dB)	Remark
1	1024.000	54.23	-14.92	39.31	74.00	-34.69	peak
2	1498.000	48.20	-12.72	35.48	74.00	-38.52	peak
3	4444.000	41.11	-2.40	38.71	74.00	-35.29	peak
4	4900.000	39.80	-0.55	39.25	74.00	-34.75	peak
5	5896.000	37.66	1.56	39.22	74.00	-34.78	peak
6	6664.000	37.47	4.54	42.01	74.00	-31.99	peak

Test Mode:	802.11a 20	Frequency(MHz):	5580
Polarity:	Vertical	Test Voltage:	DC 12 V

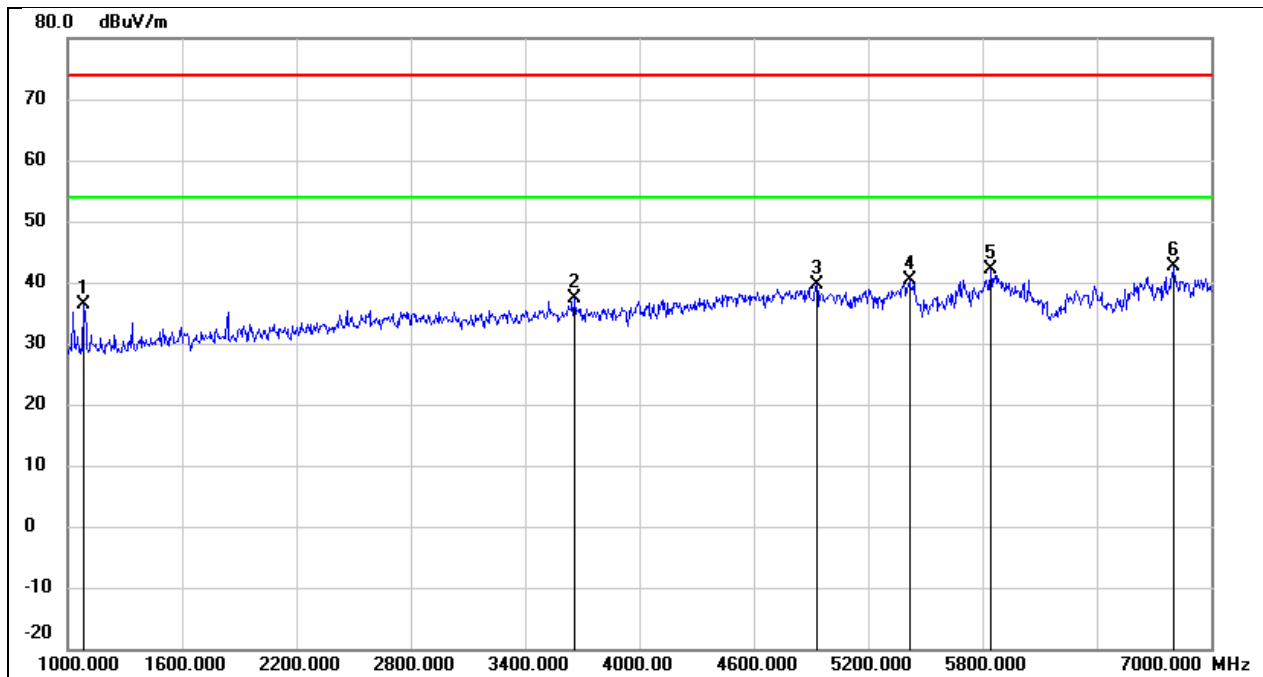

No.	Frequency (MHz)	Reading (dBuV)	Correct (dB/m)	Result (dBuV/m)	Limit (dBuV/m)	Margin (dB)	Remark
1	1084.000	51.07	-14.64	36.43	74.00	-37.57	peak
2	3658.000	42.89	-5.41	37.48	74.00	-36.52	peak
3	4930.000	40.05	-0.43	39.62	74.00	-34.38	peak
4	5416.000	40.18	0.32	40.50	74.00	-33.50	peak
5	5842.000	40.85	1.39	42.24	74.00	-31.76	peak
6	6802.000	37.30	5.21	42.51	74.00	-31.49	peak

Test Mode:	802.11a 20	Frequency(MHz):	5700
Polarity:	Horizontal	Test Voltage:	DC 12 V

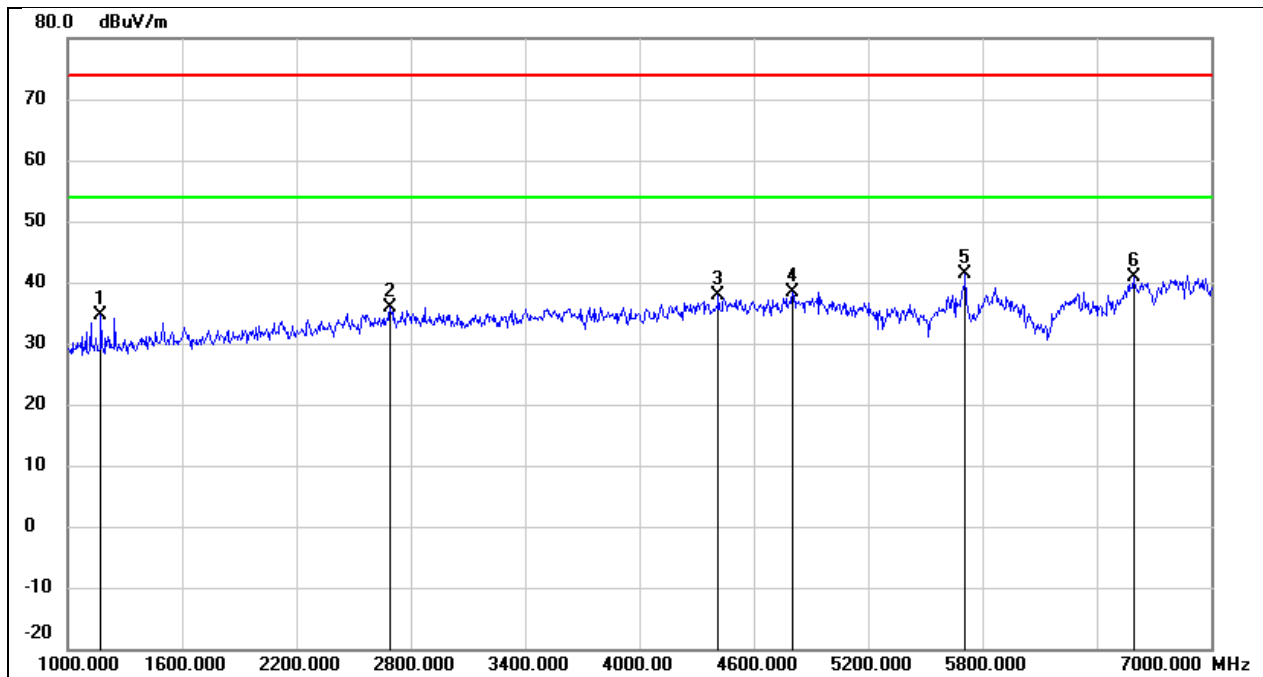

No.	Frequency (MHz)	Reading (dBuV)	Correct (dB/m)	Result (dBuV/m)	Limit (dBuV/m)	Margin (dB)	Remark
1	1174.000	48.75	-14.22	34.53	74.00	-39.47	peak
2	2692.000	43.74	-7.91	35.83	74.00	-38.17	peak
3	4414.000	40.43	-2.54	37.89	74.00	-36.11	peak
4	4804.000	39.19	-0.93	38.26	74.00	-35.74	peak
5	5710.000	40.38	1.02	41.40	74.00	-32.60	peak
6	6592.000	36.71	4.19	40.90	74.00	-33.10	peak

Test Mode:	802.11a 20	Frequency(MHz):	5700
Polarity:	Vertical	Test Voltage:	DC 12 V

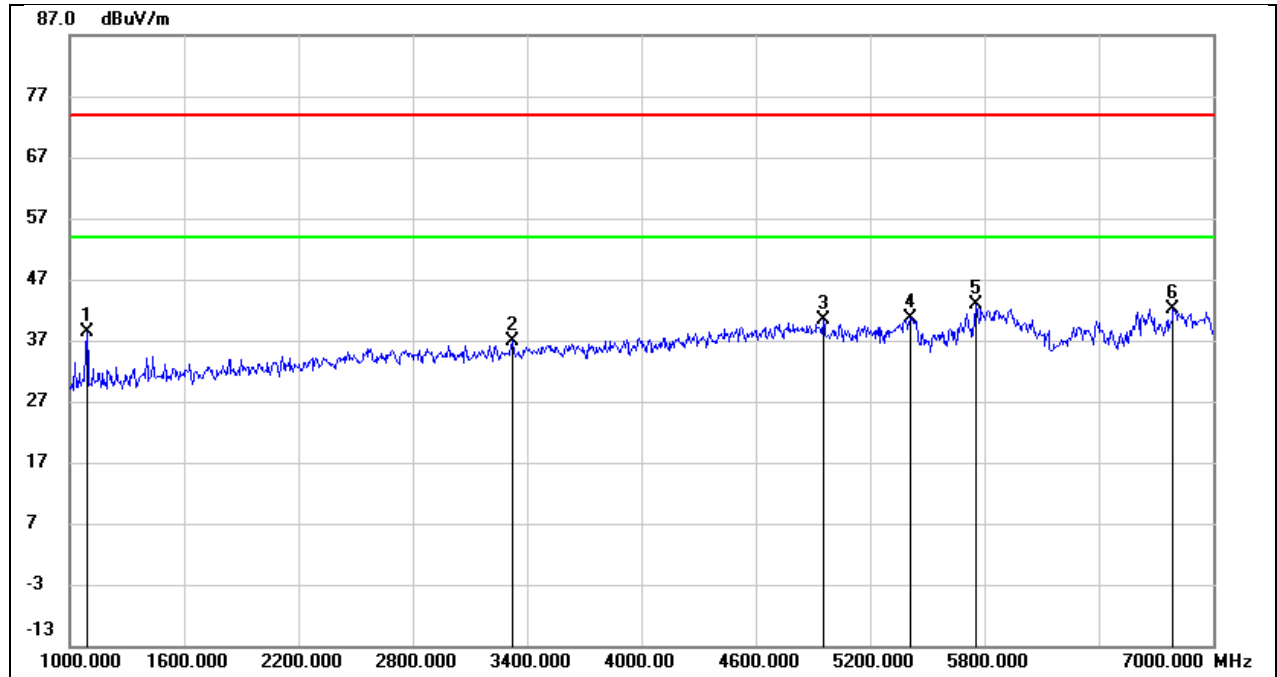

No.	Frequency (MHz)	Reading (dBuV)	Correct (dB/m)	Result (dBuV/m)	Limit (dBuV/m)	Margin (dB)	Remark
1	1090.000	53.06	-14.61	38.45	74.00	-35.55	peak
2	3322.000	43.04	-6.25	36.79	74.00	-37.21	peak
3	4954.000	40.73	-0.33	40.40	74.00	-33.60	peak
4	5410.000	40.31	0.32	40.63	74.00	-33.37	peak
5	5758.000	41.77	1.16	42.93	74.00	-31.07	peak
6	6790.000	36.96	5.15	42.11	74.00	-31.89	peak

Test Mode:	802.11a 20	Frequency(MHz):	5720
Polarity:	Horizontal	Test Voltage:	DC 12 V

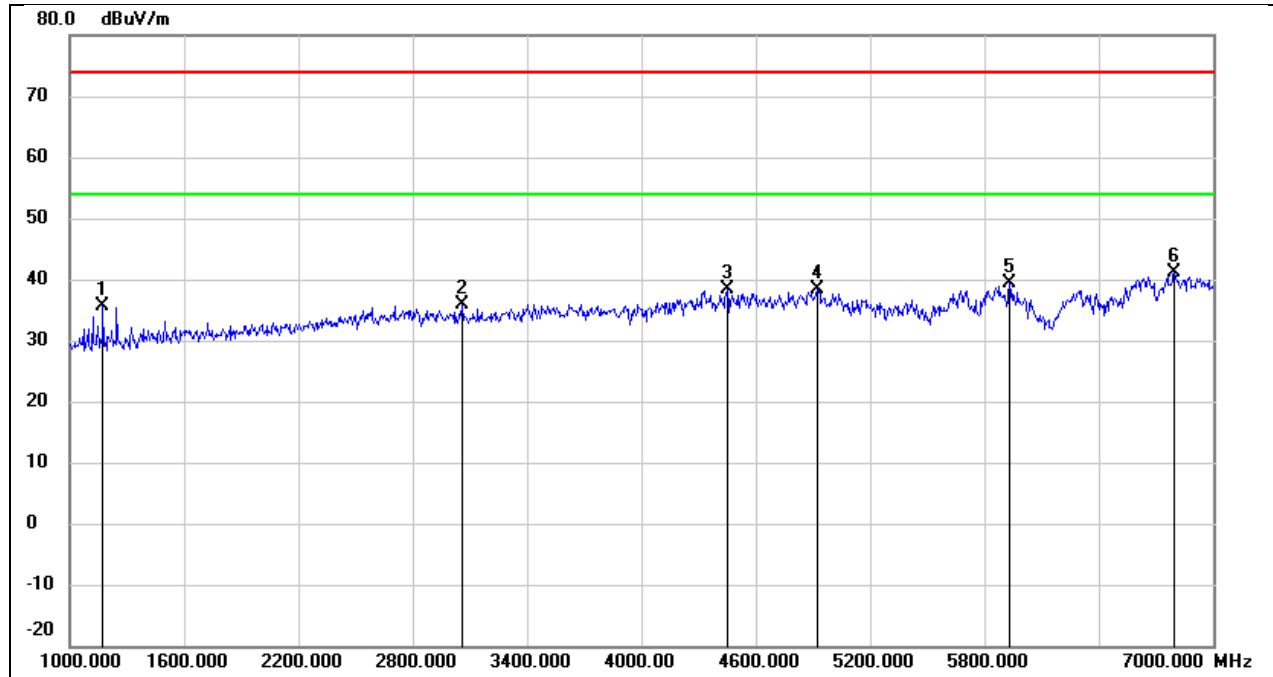

No.	Frequency (MHz)	Reading (dBuV)	Correct (dB/m)	Result (dBuV/m)	Limit (dBuV/m)	Margin (dB)	Remark
1	1174.000	49.91	-14.22	35.69	74.00	-38.31	peak
2	3058.000	42.80	-6.85	35.95	74.00	-38.05	peak
3	4450.000	40.85	-2.37	38.48	74.00	-35.52	peak
4	4924.000	38.95	-0.45	38.50	74.00	-35.50	peak
5	5932.000	37.61	1.65	39.26	74.00	-34.74	peak
6	6796.000	36.04	5.19	41.23	74.00	-32.77	peak

Test Mode:	802.11a 20	Frequency(MHz):	5720
Polarity:	Vertical	Test Voltage:	DC 12 V

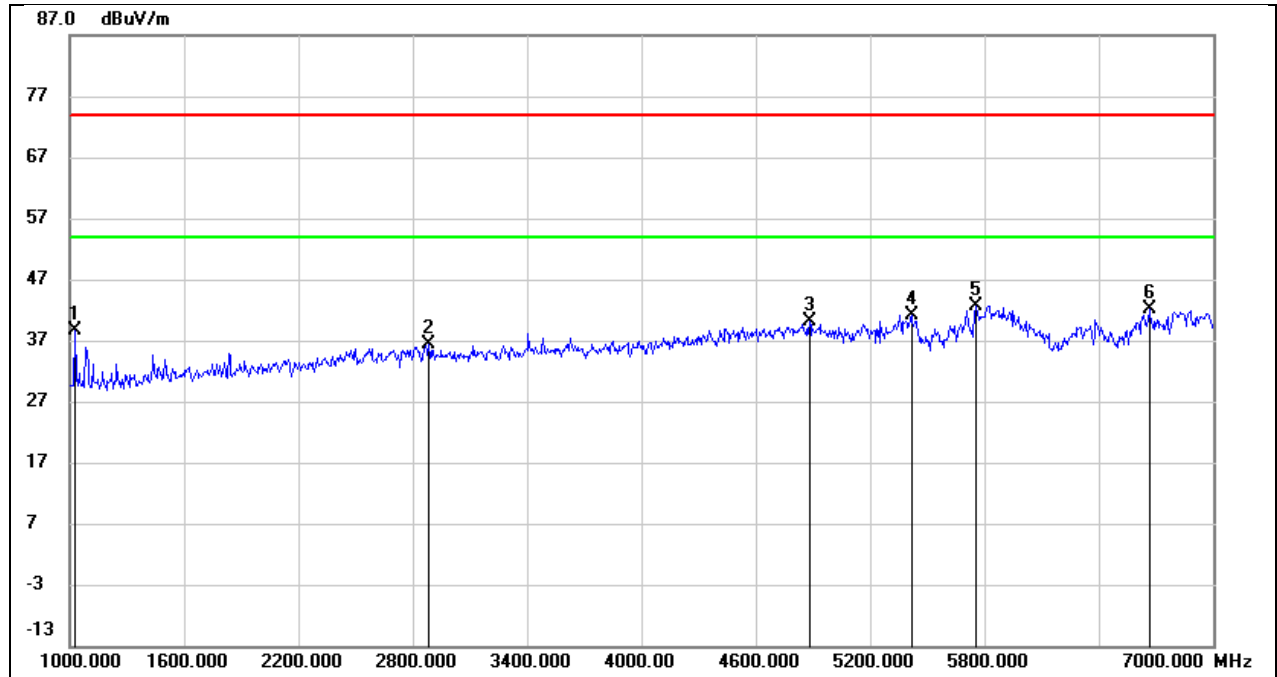

No.	Frequency (MHz)	Reading (dBuV)	Correct (dB/m)	Result (dBuV/m)	Limit (dBuV/m)	Margin (dB)	Remark
1	1024.000	53.51	-14.92	38.59	74.00	-35.41	peak
2	2884.000	43.71	-7.33	36.38	74.00	-37.62	peak
3	4882.000	40.63	-0.62	40.01	74.00	-33.99	peak
4	5416.000	40.75	0.32	41.07	74.00	-32.93	peak
5	5758.000	41.40	1.16	42.56	74.00	-31.44	peak
6	6664.000	37.47	4.54	42.01	74.00	-31.99	peak

Test Mode:	802.11a 20	Frequency(MHz):	5745
Polarity:	Horizontal	Test Voltage:	DC 12 V

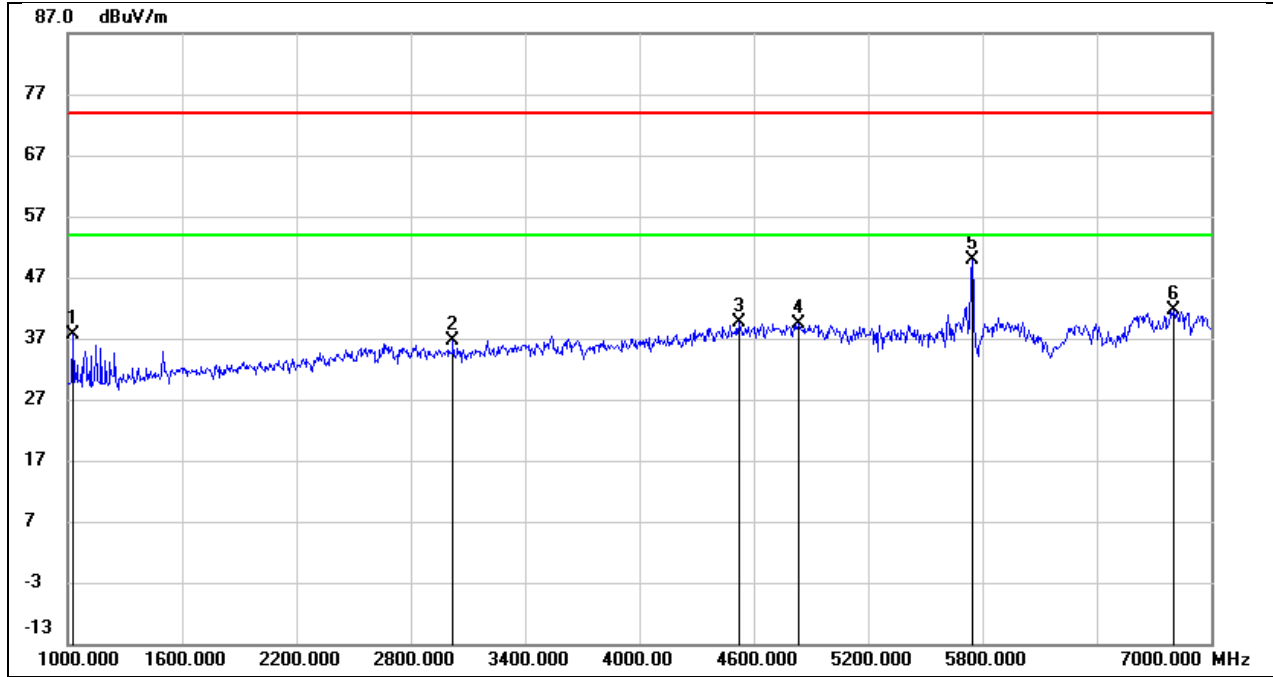

No.	Frequency (MHz)	Reading (dBuV)	Correct (dB/m)	Result (dBuV/m)	Limit (dBuV/m)	Margin (dB)	Remark
1	1024.000	52.62	-14.92	37.70	74.00	-36.30	peak
2	3022.000	43.50	-6.93	36.57	74.00	-37.43	peak
3	4522.000	41.68	-2.05	39.63	74.00	-34.37	peak
4	4834.000	40.18	-0.81	39.37	74.00	-34.63	peak
5	5746.000	48.83	1.12	49.95	74.00	-24.05	peak
6	6802.000	36.42	5.21	41.63	74.00	-32.37	peak

Test Mode:	802.11a 20	Frequency(MHz):	5745
Polarity:	Vertical	Test Voltage:	DC 12 V

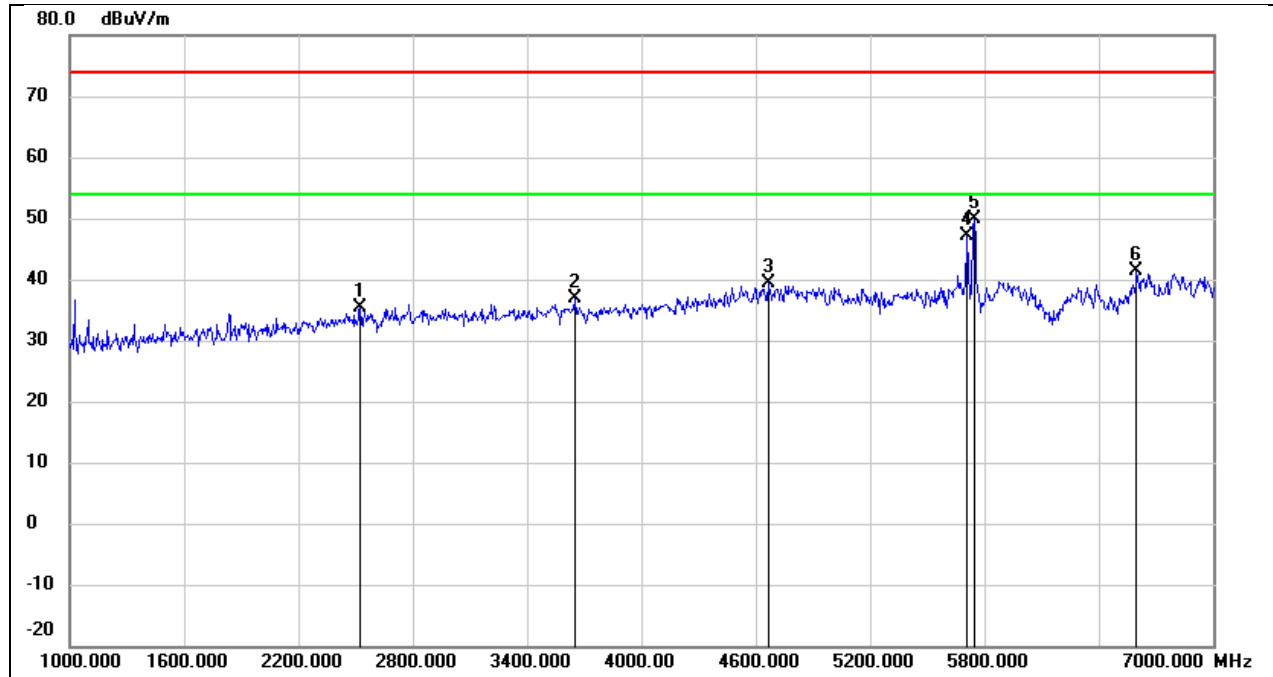

No.	Frequency (MHz)	Reading (dBuV)	Correct (dB/m)	Result (dBuV/m)	Limit (dBuV/m)	Margin (dB)	Remark
1	2524.000	43.86	-8.42	35.44	74.00	-38.56	peak
2	3652.000	42.38	-5.44	36.94	74.00	-37.06	peak
3	4666.000	40.95	-1.48	39.47	74.00	-34.53	peak
4	5710.000	46.22	1.02	47.24	74.00	-26.76	peak
5	5746.000	48.85	1.12	49.97	74.00	-24.03	peak
6	6598.000	37.13	4.21	41.34	74.00	-32.66	peak

Test Mode:	802.11a 20	Frequency(MHz):	5785
Polarity:	Horizontal	Test Voltage:	DC 12 V

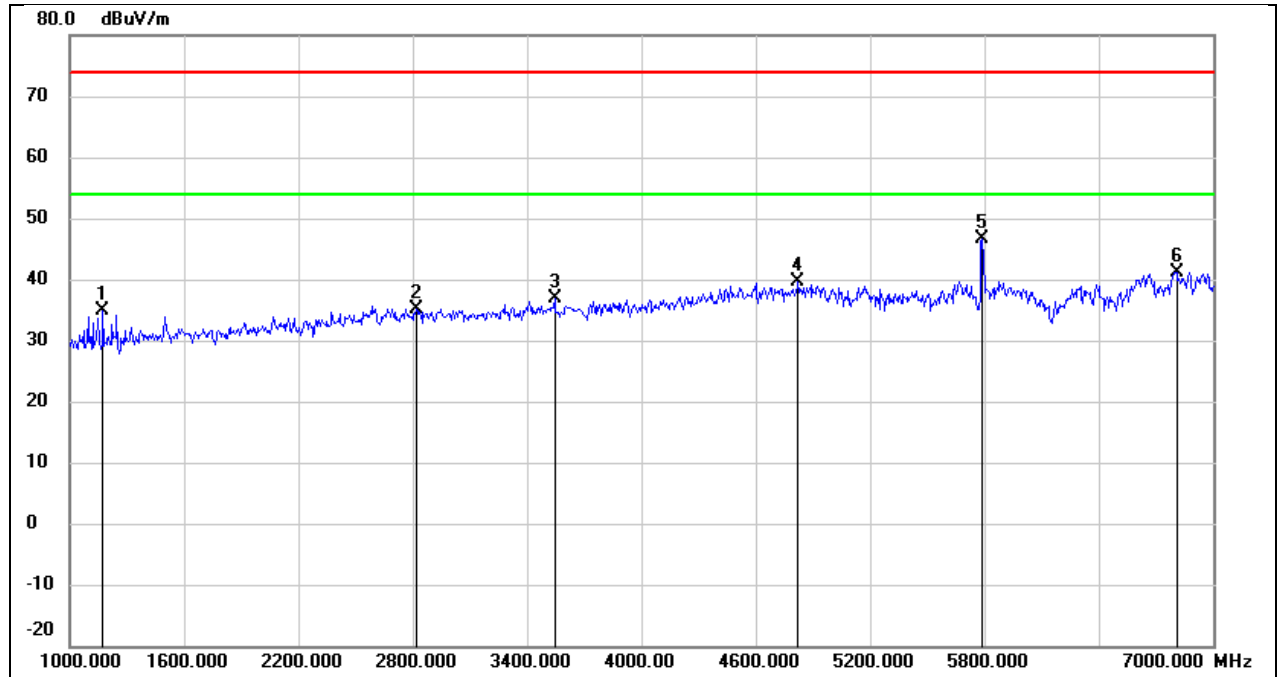

No.	Frequency (MHz)	Reading (dBuV)	Correct (dB/m)	Result (dBuV/m)	Limit (dBuV/m)	Margin (dB)	Remark
1	1174.000	49.06	-14.22	34.84	74.00	-39.16	peak
2	2818.000	42.78	-7.53	35.25	74.00	-38.75	peak
3	3544.000	42.62	-5.73	36.89	74.00	-37.11	peak
4	4822.000	40.59	-0.85	39.74	74.00	-34.26	peak
5	5788.000	45.34	1.25	46.59	74.00	-27.41	peak
6	6808.000	35.89	5.24	41.13	74.00	-32.87	peak

Test Mode:	802.11a 20	Frequency(MHz):	5785
Polarity:	Vertical	Test Voltage:	DC 12 V

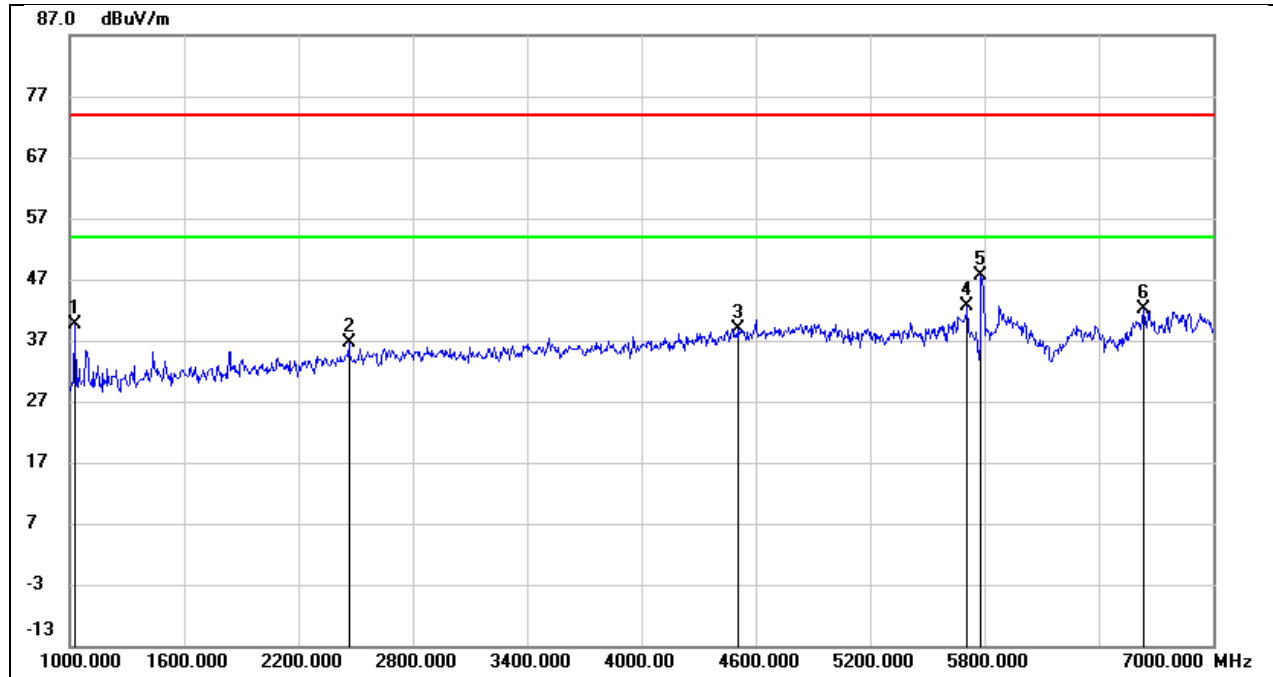

No.	Frequency (MHz)	Reading (dBuV)	Correct (dB/m)	Result (dBuV/m)	Limit (dBuV/m)	Margin (dB)	Remark
1	1024.000	54.64	-14.92	39.72	74.00	-34.28	peak
2	2464.000	45.40	-8.68	36.72	74.00	-37.28	peak
3	4504.000	40.97	-2.12	38.85	74.00	-35.15	peak
4	5710.000	41.72	1.02	42.74	74.00	-31.26	peak
5	5782.000	46.43	1.23	47.66	74.00	-26.34	peak
6	6634.000	37.64	4.38	42.02	74.00	-31.98	peak

Test Mode:	802.11a 20	Frequency(MHz):	5825
Polarity:	Horizontal	Test Voltage:	DC 12 V

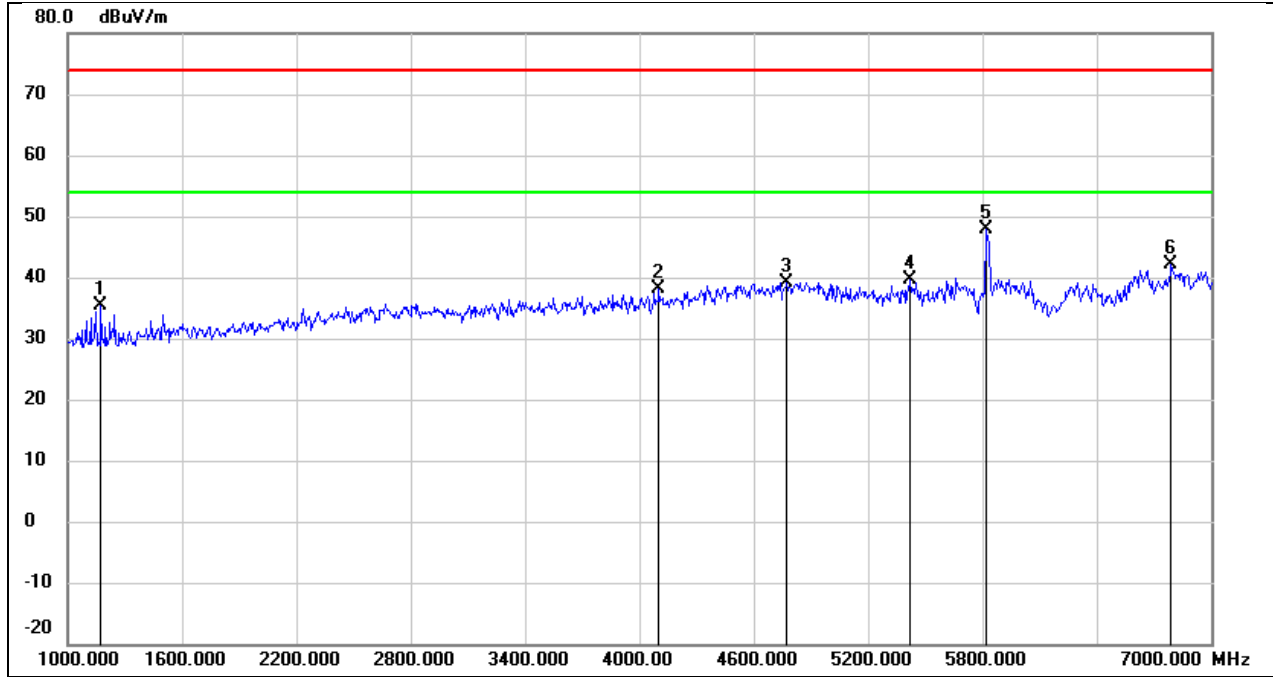

No.	Frequency (MHz)	Reading (dBuV)	Correct (dB/m)	Result (dBuV/m)	Limit (dBuV/m)	Margin (dB)	Remark
1	1174.000	49.53	-14.22	35.31	74.00	-38.69	peak
2	4102.000	42.20	-4.01	38.19	74.00	-35.81	peak
3	4774.000	40.07	-1.05	39.02	74.00	-34.98	peak
4	5422.000	39.25	0.32	39.57	74.00	-34.43	peak
5	5818.000	46.46	1.33	47.79	74.00	-26.21	peak
6	6790.000	36.90	5.15	42.05	74.00	-31.95	peak

Test Mode:	802.11a 20	Frequency(MHz):	5825
Polarity:	Vertical	Test Voltage:	DC 12 V

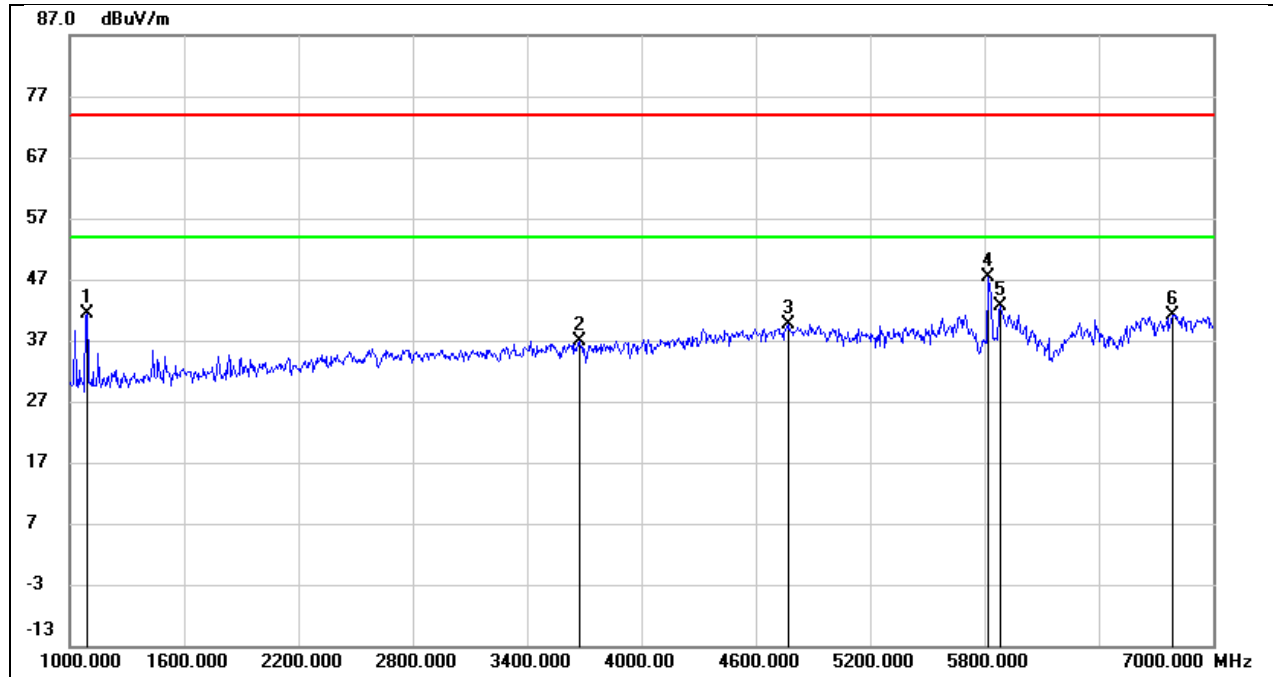

No.	Frequency (MHz)	Reading (dBuV)	Correct (dB/m)	Result (dBuV/m)	Limit (dBuV/m)	Margin (dB)	Remark
1	1090.000	56.09	-14.61	41.48	74.00	-32.52	peak
2	3676.000	42.34	-5.37	36.97	74.00	-37.03	peak
3	4774.000	40.78	-1.05	39.73	74.00	-34.27	peak
4	5818.000	46.16	1.33	47.49	74.00	-26.51	peak
5	5884.000	41.18	1.52	42.70	74.00	-31.30	peak
6	6790.000	36.09	5.15	41.24	74.00	-32.76	peak

8.3. SPURIOUS EMISSIONS(7 GHZ~18 GHZ)

Test Mode:	802.11a 20	Frequency(MHz):	5180
Polarity:	Horizontal	Test Voltage:	DC 12 V

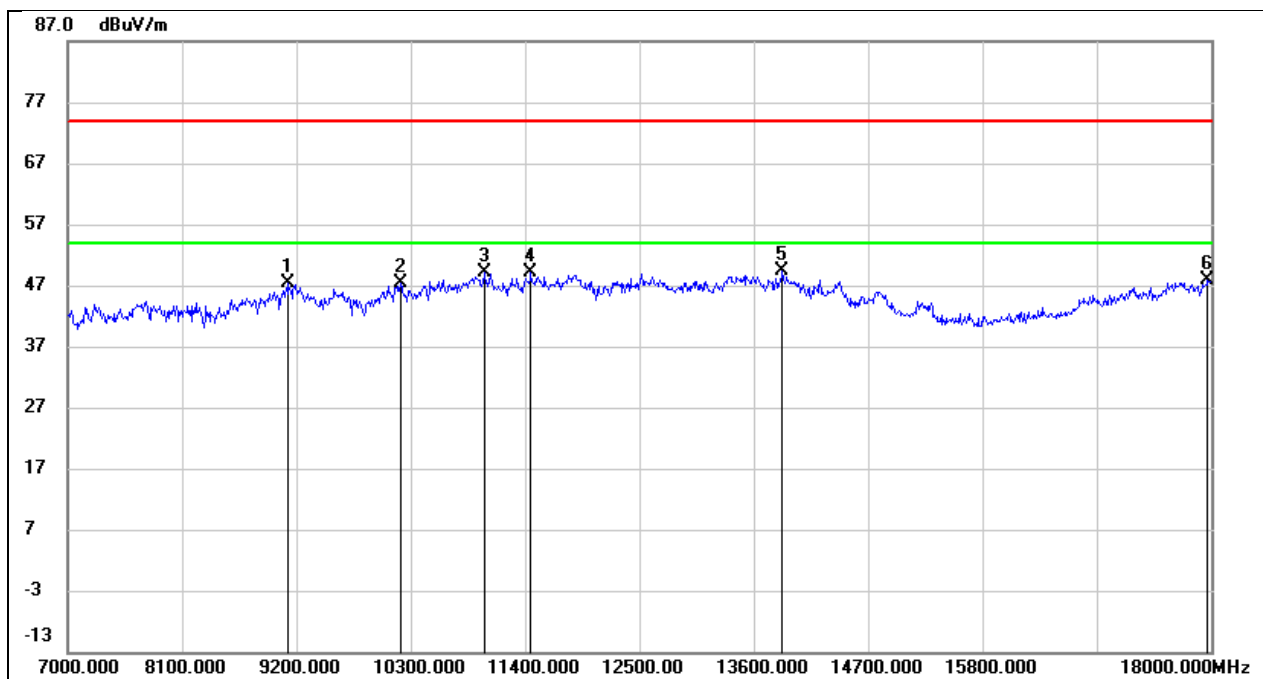

No.	Frequency (MHz)	Reading (dBuV)	Correct (dB/m)	Result (dBuV/m)	Limit (dBuV/m)	Margin (dB)	Remark
1	9123.000	36.94	10.42	47.36	74.00	-26.64	peak
2	10201.000	35.11	12.19	47.30	74.00	-26.70	peak
3	11004.000	34.37	14.74	49.11	74.00	-24.89	peak
4	11455.000	32.43	16.58	49.01	74.00	-24.99	peak
5	13875.000	27.86	21.57	49.43	74.00	-24.57	peak
6	17967.000	21.92	25.89	47.81	74.00	-26.19	peak

Test Mode:	802.11a 20	Frequency(MHz):	5180
Polarity:	Vertical	Test Voltage:	DC 12 V

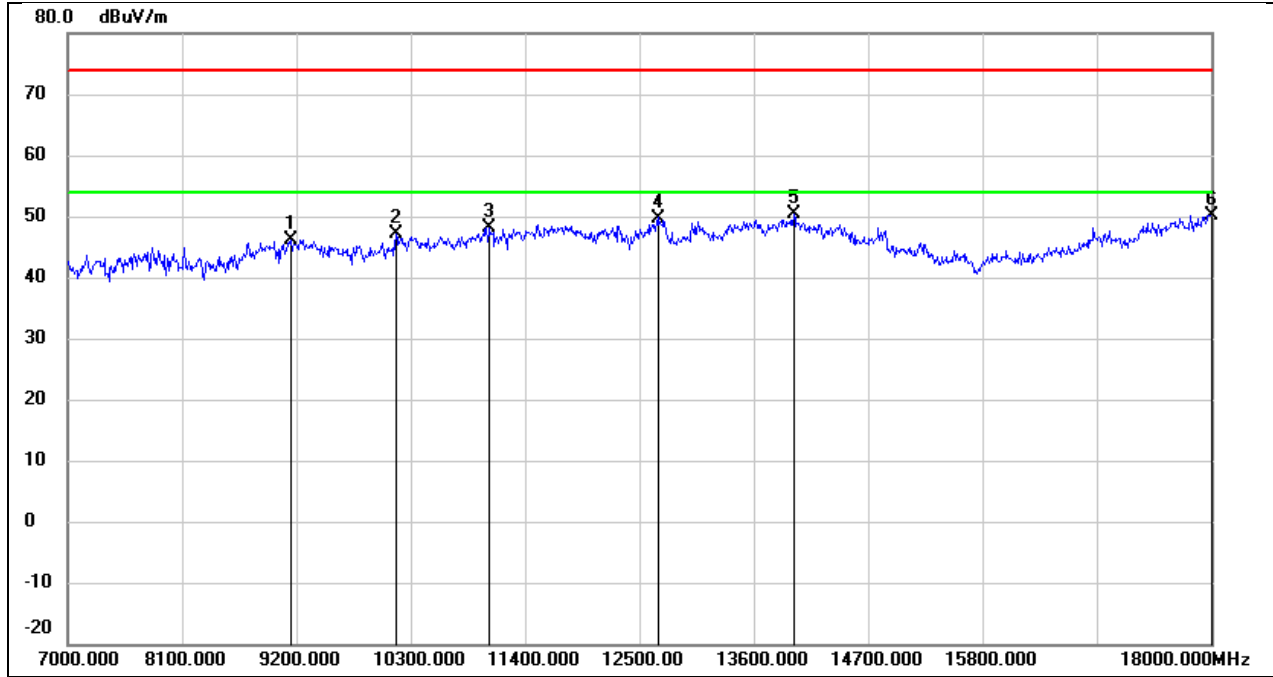

No.	Frequency (MHz)	Reading (dBuV)	Correct (dB/m)	Result (dBuV/m)	Limit (dBuV/m)	Margin (dB)	Remark
1	9145.000	35.80	10.43	46.23	74.00	-27.77	peak
2	10157.000	34.99	12.10	47.09	74.00	-26.91	peak
3	11059.000	33.14	14.96	48.10	74.00	-25.90	peak
4	12676.000	31.70	18.05	49.75	74.00	-24.25	peak
5	13985.000	28.51	21.85	50.36	74.00	-23.64	peak
6	18000.000	24.08	26.12	50.20	74.00	-23.80	peak

Test Mode:	802.11a 20	Frequency(MHz):	5200
Polarity:	Horizontal	Test Voltage:	DC 12 V

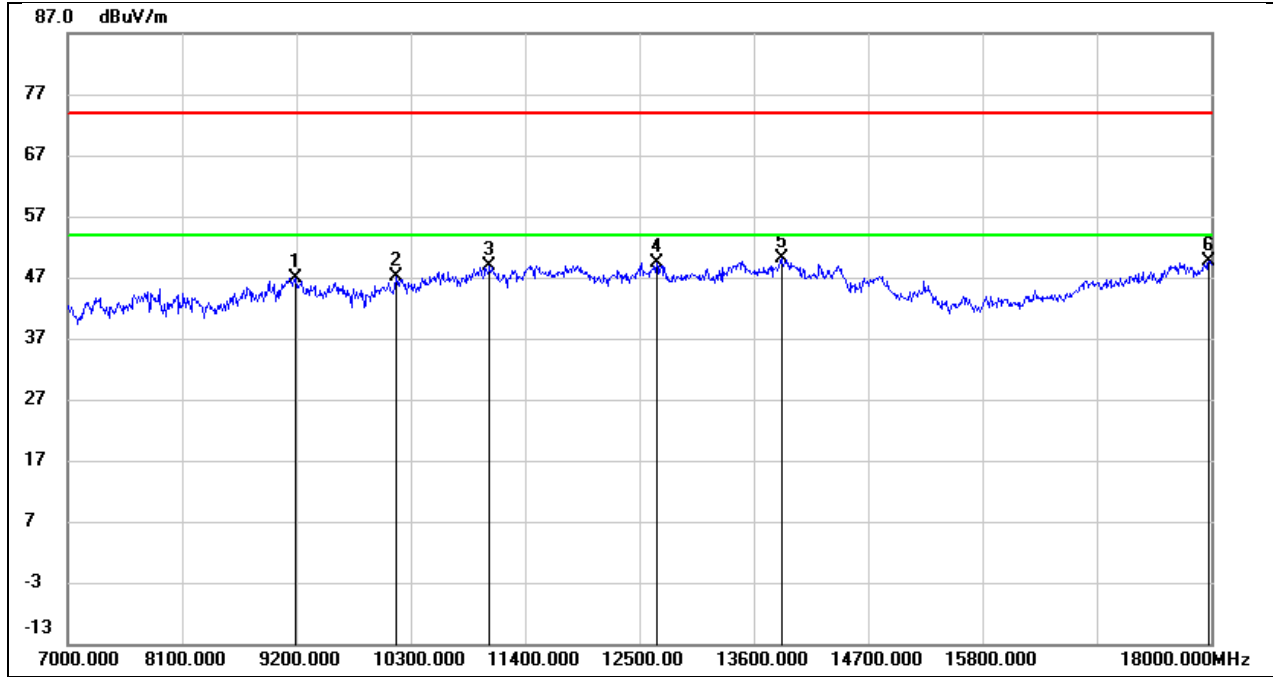

No.	Frequency (MHz)	Reading (dBuV)	Correct (dB/m)	Result (dBuV/m)	Limit (dBuV/m)	Margin (dB)	Remark
1	9189.000	36.46	10.46	46.92	74.00	-27.08	peak
2	10157.000	34.96	12.10	47.06	74.00	-26.94	peak
3	11059.000	34.01	14.96	48.97	74.00	-25.03	peak
4	12665.000	31.27	18.04	49.31	74.00	-24.69	peak
5	13864.000	28.66	21.53	50.19	74.00	-23.81	peak
6	17978.000	23.71	25.97	49.68	74.00	-24.32	peak

Test Mode:	802.11a 20	Frequency(MHz):	5200
Polarity:	Vertical	Test Voltage:	DC 12 V

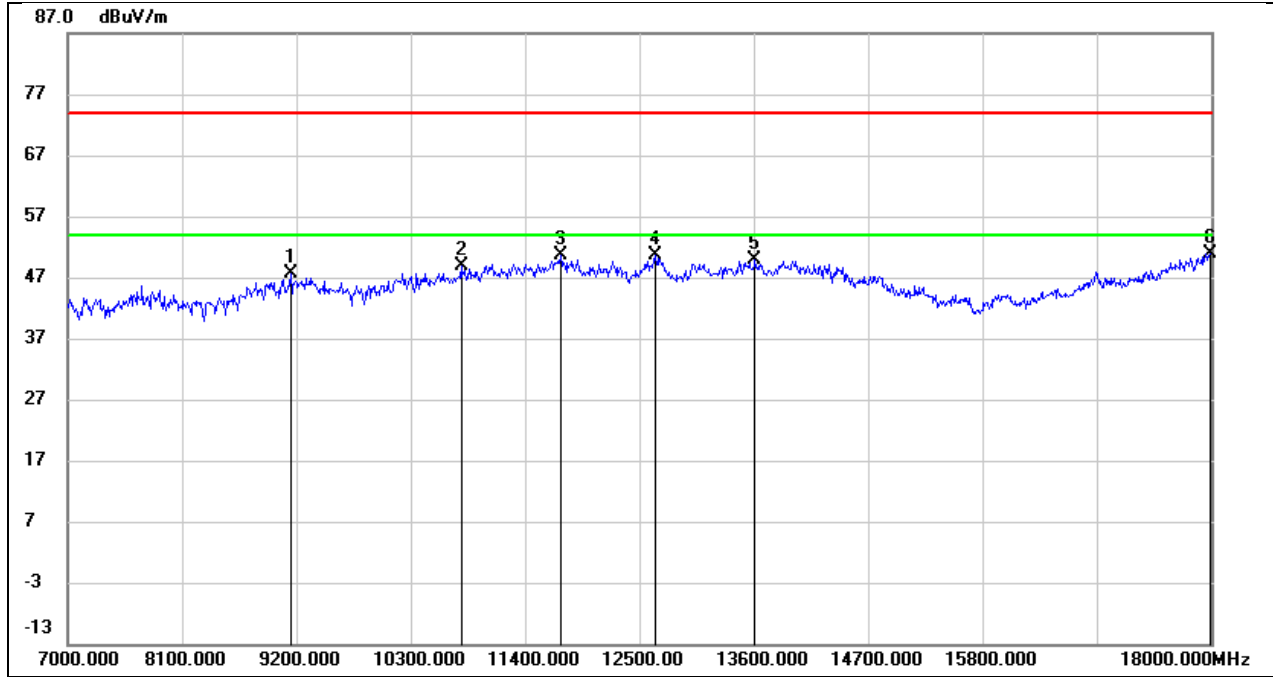

No.	Frequency (MHz)	Reading (dBuV)	Correct (dB/m)	Result (dBuV/m)	Limit (dBuV/m)	Margin (dB)	Remark
1	9145.000	37.21	10.43	47.64	74.00	-26.36	peak
2	10784.000	34.98	13.91	48.89	74.00	-25.11	peak
3	11741.000	33.51	17.22	50.73	74.00	-23.27	peak
4	12654.000	32.73	18.01	50.74	74.00	-23.26	peak
5	13611.000	29.07	20.92	49.99	74.00	-24.01	peak
6	17989.000	24.89	26.04	50.93	74.00	-23.07	peak

Test Mode:	802.11a 20	Frequency(MHz):	5240
Polarity:	Horizontal	Test Voltage:	DC 12 V

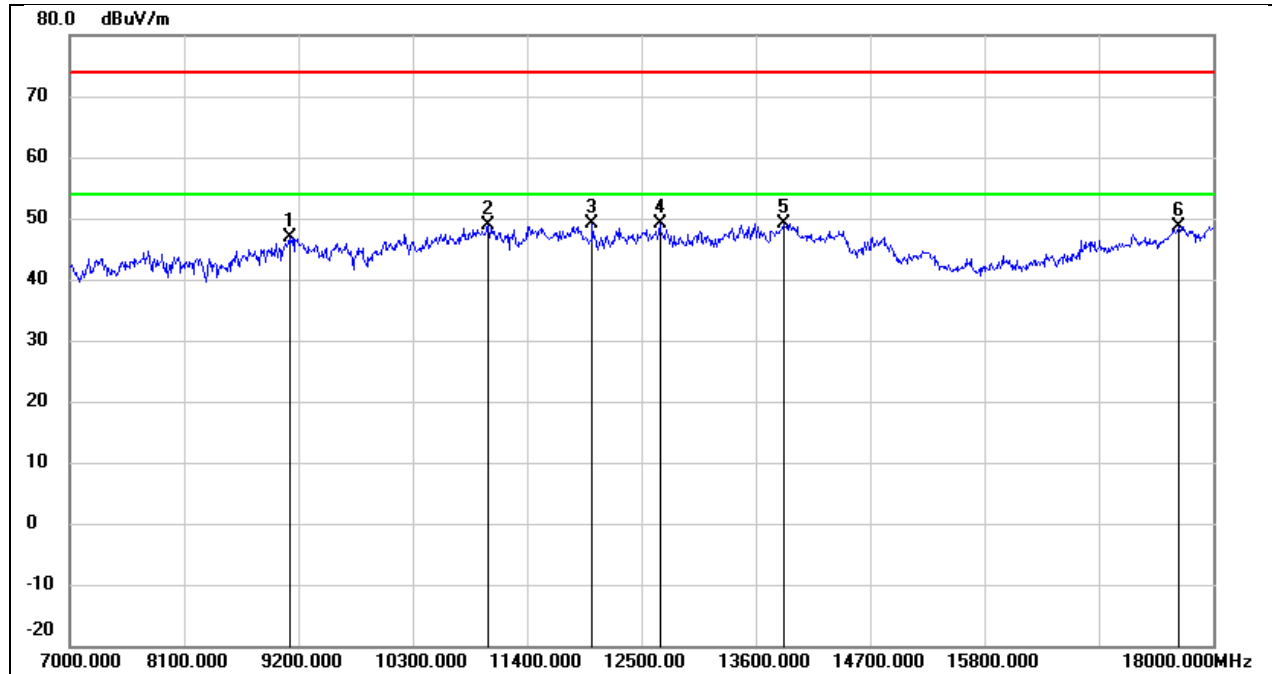

No.	Frequency (MHz)	Reading (dBuV)	Correct (dB/m)	Result (dBuV/m)	Limit (dBuV/m)	Margin (dB)	Remark
1	9112.000	36.40	10.41	46.81	74.00	-27.19	peak
2	11026.000	34.11	14.82	48.93	74.00	-25.07	peak
3	12027.000	31.49	17.70	49.19	74.00	-24.81	peak
4	12676.000	31.03	18.05	49.08	74.00	-24.92	peak
5	13875.000	27.63	21.57	49.20	74.00	-24.80	peak
6	17670.000	24.71	23.86	48.57	74.00	-25.43	peak

Test Mode:	802.11a 20	Frequency(MHz):	5240
Polarity:	Vertical	Test Voltage:	DC 12 V

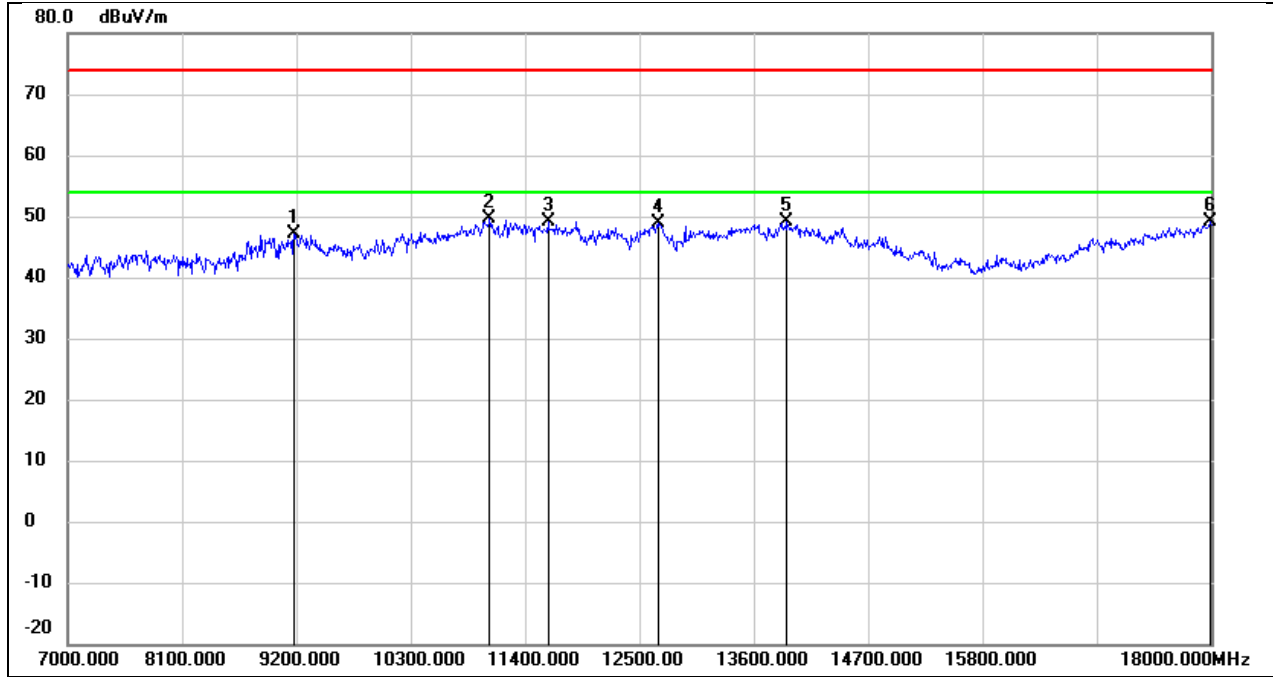

No.	Frequency (MHz)	Reading (dBuV)	Correct (dB/m)	Result (dBuV/m)	Limit (dBuV/m)	Margin (dB)	Remark
1	9178.000	36.63	10.45	47.08	74.00	-26.92	peak
2	11059.000	34.64	14.96	49.60	74.00	-24.40	peak
3	11620.000	32.16	16.99	49.15	74.00	-24.85	peak
4	12676.000	30.91	18.05	48.96	74.00	-25.04	peak
5	13919.000	27.38	21.68	49.06	74.00	-24.94	peak
6	17989.000	23.07	26.04	49.11	74.00	-24.89	peak

Test Mode:	802.11a 20	Frequency(MHz):	5260
Polarity:	Horizontal	Test Voltage:	DC 12 V

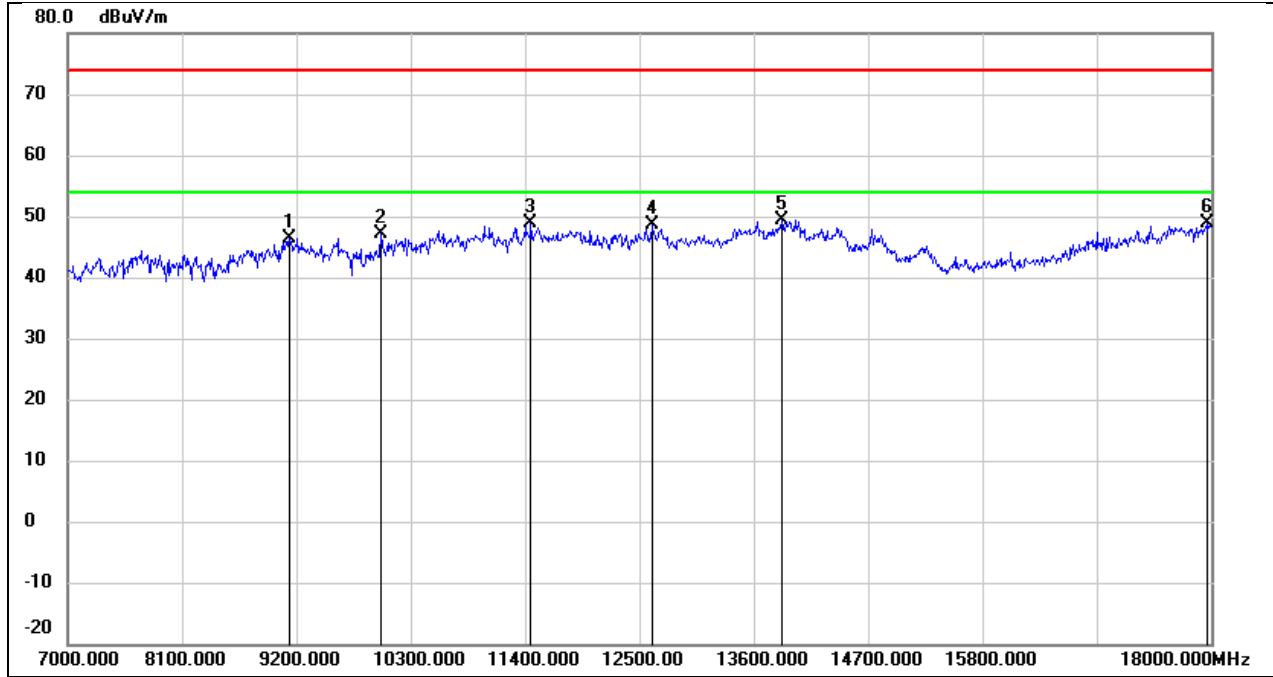

No.	Frequency (MHz)	Reading (dBuV)	Correct (dB/m)	Result (dBuV/m)	Limit (dBuV/m)	Margin (dB)	Remark
1	9134.000	36.03	10.41	46.44	74.00	-27.56	peak
2	10014.000	35.40	11.80	47.20	74.00	-26.80	peak
3	11455.000	32.20	16.58	48.78	74.00	-25.22	peak
4	12621.000	30.53	17.98	48.51	74.00	-25.49	peak
5	13875.000	27.81	21.57	49.38	74.00	-24.62	peak
6	17967.000	23.05	25.89	48.94	74.00	-25.06	peak

Test Mode:	802.11a 20	Frequency(MHz):	5260
Polarity:	Vertical	Test Voltage:	DC 12 V

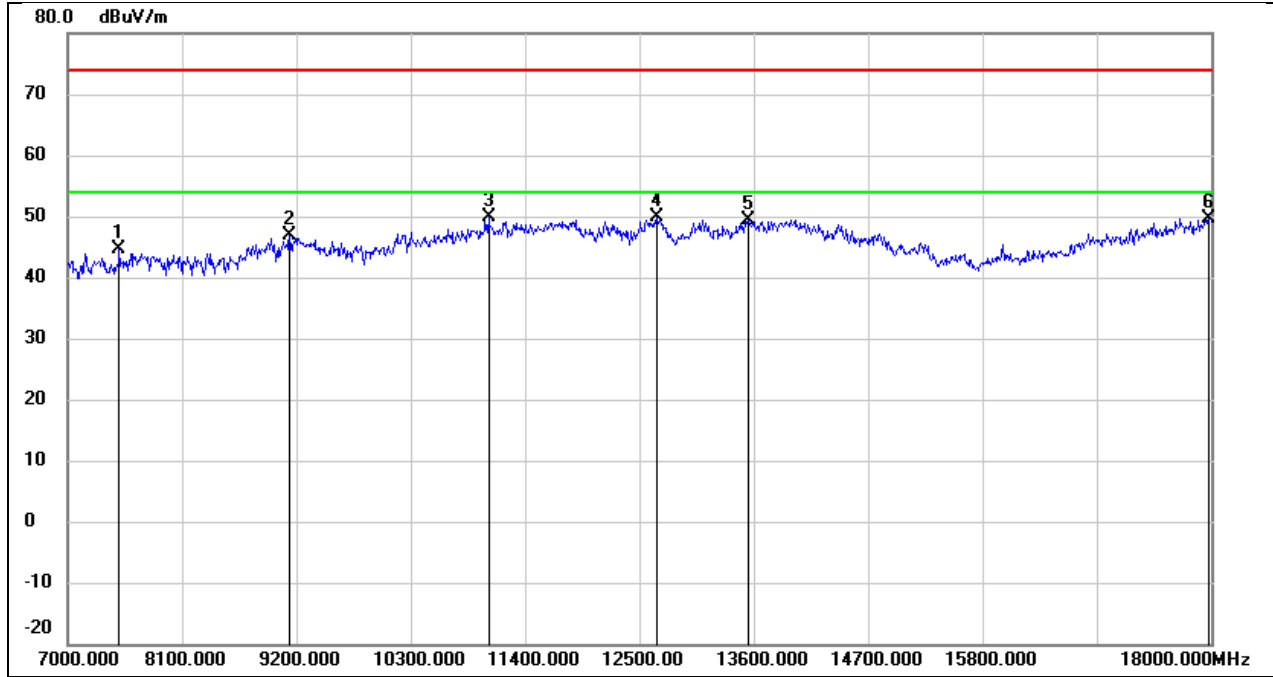

No.	Frequency (MHz)	Reading (dBuV)	Correct (dB/m)	Result (dBuV/m)	Limit (dBuV/m)	Margin (dB)	Remark
1	7495.000	37.74	6.87	44.61	74.00	-29.39	peak
2	9134.000	36.36	10.41	46.77	74.00	-27.23	peak
3	11048.000	35.04	14.91	49.95	74.00	-24.05	peak
4	12665.000	31.72	18.04	49.76	74.00	-24.24	peak
5	13545.000	28.70	20.75	49.45	74.00	-24.55	peak
6	17978.000	23.66	25.97	49.63	74.00	-24.37	peak

Test Mode:	802.11a 20	Frequency(MHz):	5280
Polarity:	Horizontal	Test Voltage:	DC 12 V

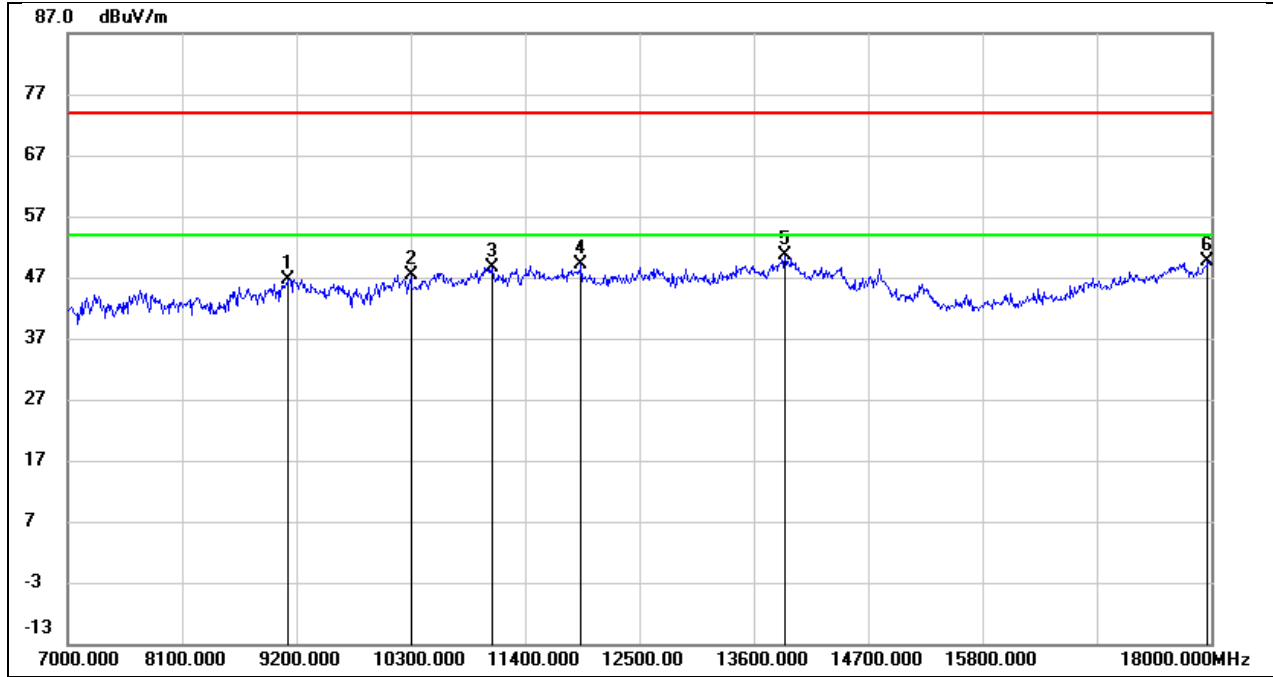

No.	Frequency (MHz)	Reading (dBuV)	Correct (dB/m)	Result (dBuV/m)	Limit (dBuV/m)	Margin (dB)	Remark
1	9112.000	36.26	10.41	46.67	74.00	-27.33	peak
2	10300.000	35.03	12.40	47.43	74.00	-26.57	peak
3	11081.000	33.58	15.05	48.63	74.00	-25.37	peak
4	11939.000	31.60	17.59	49.19	74.00	-24.81	peak
5	13897.000	28.95	21.62	50.57	74.00	-23.43	peak
6	17967.000	23.86	25.89	49.75	74.00	-24.25	peak

Test Mode:	802.11a 20	Frequency(MHz):	5280
Polarity:	Vertical	Test Voltage:	DC 12 V

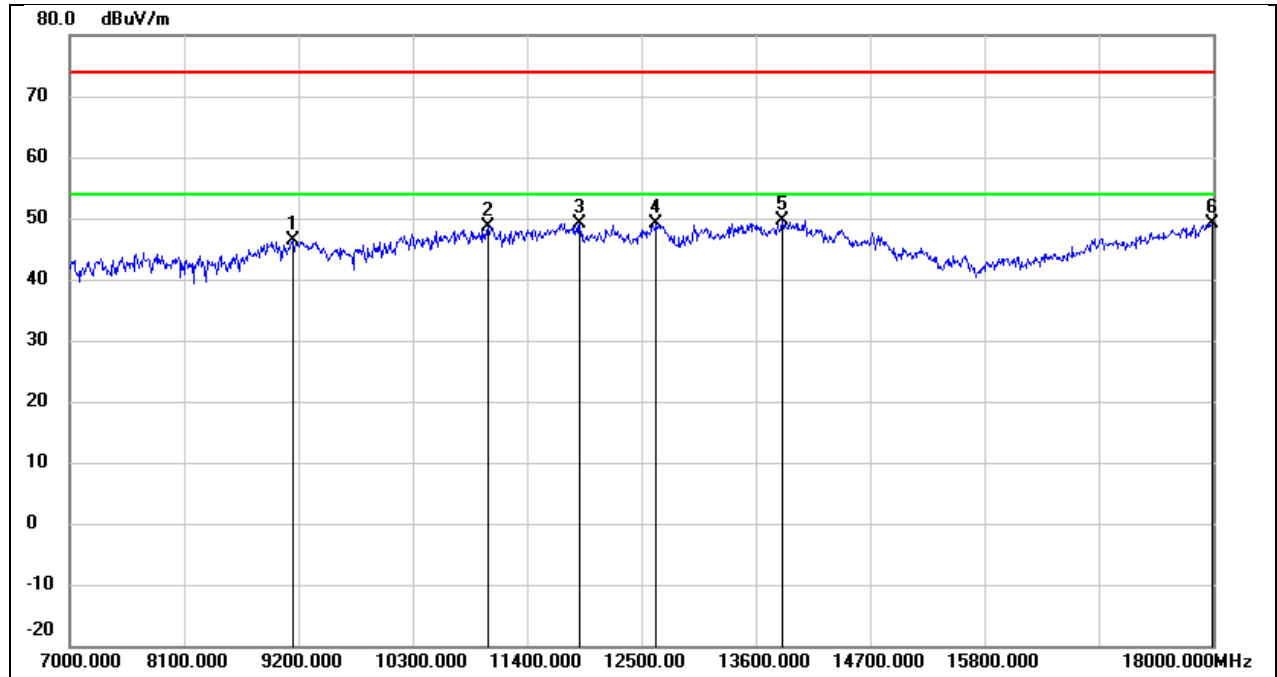

No.	Frequency (MHz)	Reading (dBuV)	Correct (dB/m)	Result (dBuV/m)	Limit (dBuV/m)	Margin (dB)	Remark
1	9145.000	35.94	10.43	46.37	74.00	-27.63	peak
2	11026.000	33.72	14.82	48.54	74.00	-25.46	peak
3	11906.000	31.55	17.52	49.07	74.00	-24.93	peak
4	12643.000	31.14	18.01	49.15	74.00	-24.85	peak
5	13853.000	28.22	21.52	49.74	74.00	-24.26	peak
6	17989.000	22.99	26.04	49.03	74.00	-24.97	peak

Test Mode:	802.11a 20	Frequency(MHz):	5320
Polarity:	Horizontal	Test Voltage:	DC 12 V

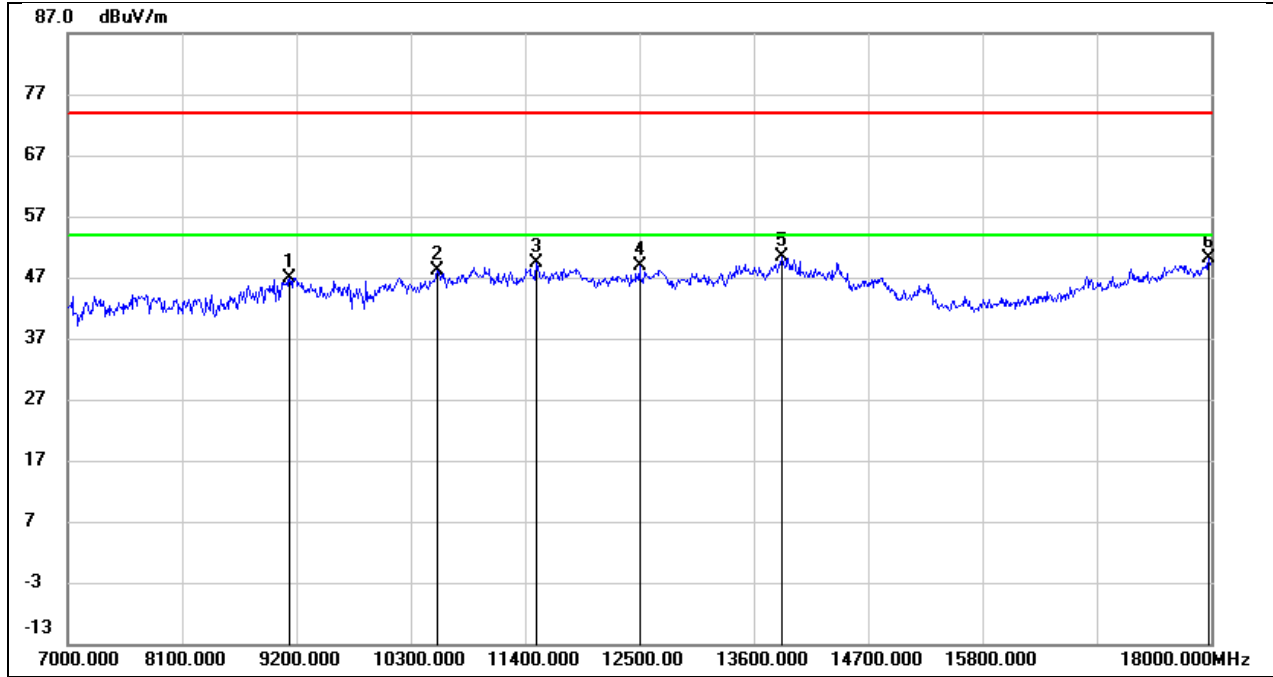

No.	Frequency (MHz)	Reading (dBuV)	Correct (dB/m)	Result (dBuV/m)	Limit (dBuV/m)	Margin (dB)	Remark
1	9134.000	36.50	10.41	46.91	74.00	-27.09	peak
2	10553.000	35.06	13.02	48.08	74.00	-25.92	peak
3	11510.000	32.52	16.79	49.31	74.00	-24.69	peak
4	12500.000	31.13	17.83	48.96	74.00	-25.04	peak
5	13875.000	28.87	21.57	50.44	74.00	-23.56	peak
6	17978.000	24.14	25.97	50.11	74.00	-23.89	peak

Test Mode:	802.11a 20	Frequency(MHz):	5320
Polarity:	Vertical	Test Voltage:	DC 12 V

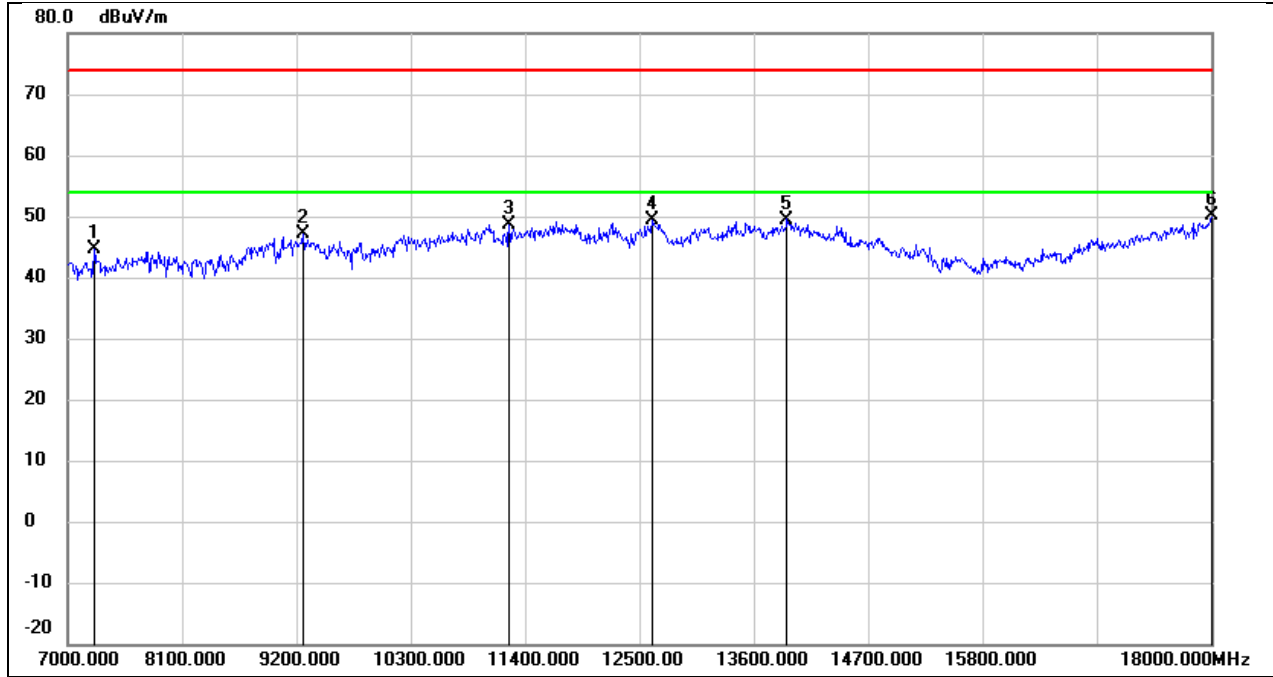

No.	Frequency (MHz)	Reading (dBuV)	Correct (dB/m)	Result (dBuV/m)	Limit (dBuV/m)	Margin (dB)	Remark
1	7253.000	37.78	6.95	44.73	74.00	-29.27	peak
2	9266.000	36.69	10.51	47.20	74.00	-26.80	peak
3	11246.000	32.83	15.73	48.56	74.00	-25.44	peak
4	12621.000	31.28	17.98	49.26	74.00	-24.74	peak
5	13919.000	27.82	21.68	49.50	74.00	-24.50	peak
6	18000.000	24.02	26.12	50.14	74.00	-23.86	peak

Test Mode:	802.11a 20	Frequency(MHz):	5500
Polarity:	Horizontal	Test Voltage:	DC 12 V

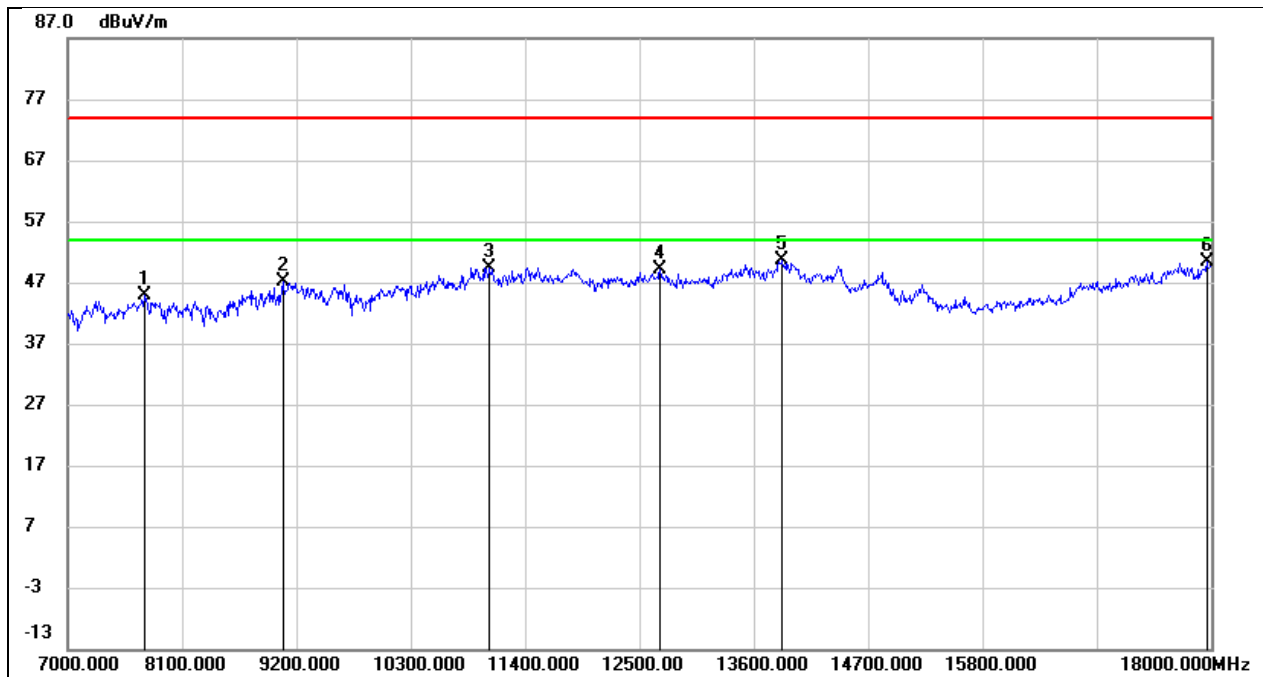

No.	Frequency (MHz)	Reading (dBuV)	Correct (dB/m)	Result (dBuV/m)	Limit (dBuV/m)	Margin (dB)	Remark
1	7737.000	38.21	6.66	44.87	74.00	-29.13	peak
2	9068.000	36.65	10.39	47.04	74.00	-26.96	peak
3	11059.000	34.51	14.96	49.47	74.00	-24.53	peak
4	12698.000	31.11	18.08	49.19	74.00	-24.81	peak
5	13875.000	29.14	21.57	50.71	74.00	-23.29	peak
6	17956.000	24.51	25.82	50.33	74.00	-23.67	peak

Test Mode:	802.11a 20	Frequency(MHz):	5500
Polarity:	Vertical	Test Voltage:	DC 12 V

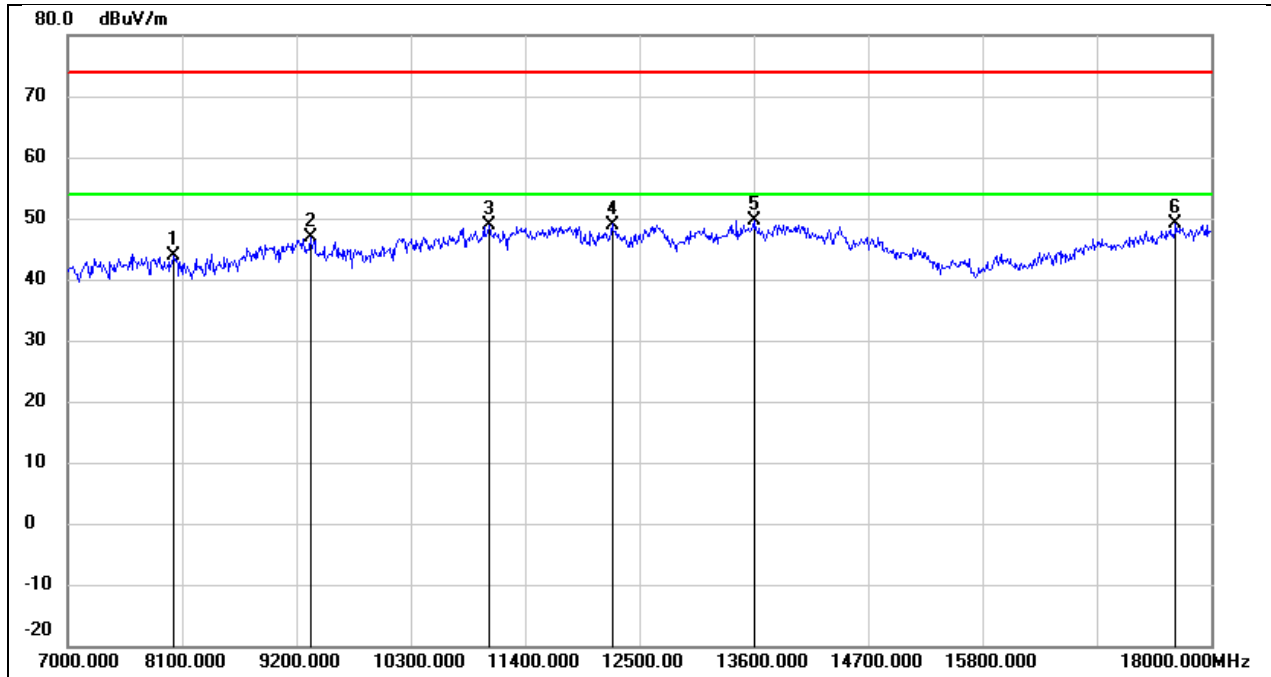

No.	Frequency (MHz)	Reading (dBuV)	Correct (dB/m)	Result (dBuV/m)	Limit (dBuV/m)	Margin (dB)	Remark
1	8023.000	37.36	6.45	43.81	74.00	-30.19	peak
2	9332.000	36.27	10.54	46.81	74.00	-27.19	peak
3	11059.000	33.90	14.96	48.86	74.00	-25.14	peak
4	12236.000	31.24	17.76	49.00	74.00	-25.00	peak
5	13600.000	28.79	20.89	49.68	74.00	-24.32	peak
6	17659.000	25.45	23.78	49.23	74.00	-24.77	peak

Test Mode:	802.11a 20	Frequency(MHz):	5580
Polarity:	Horizontal	Test Voltage:	DC 12 V

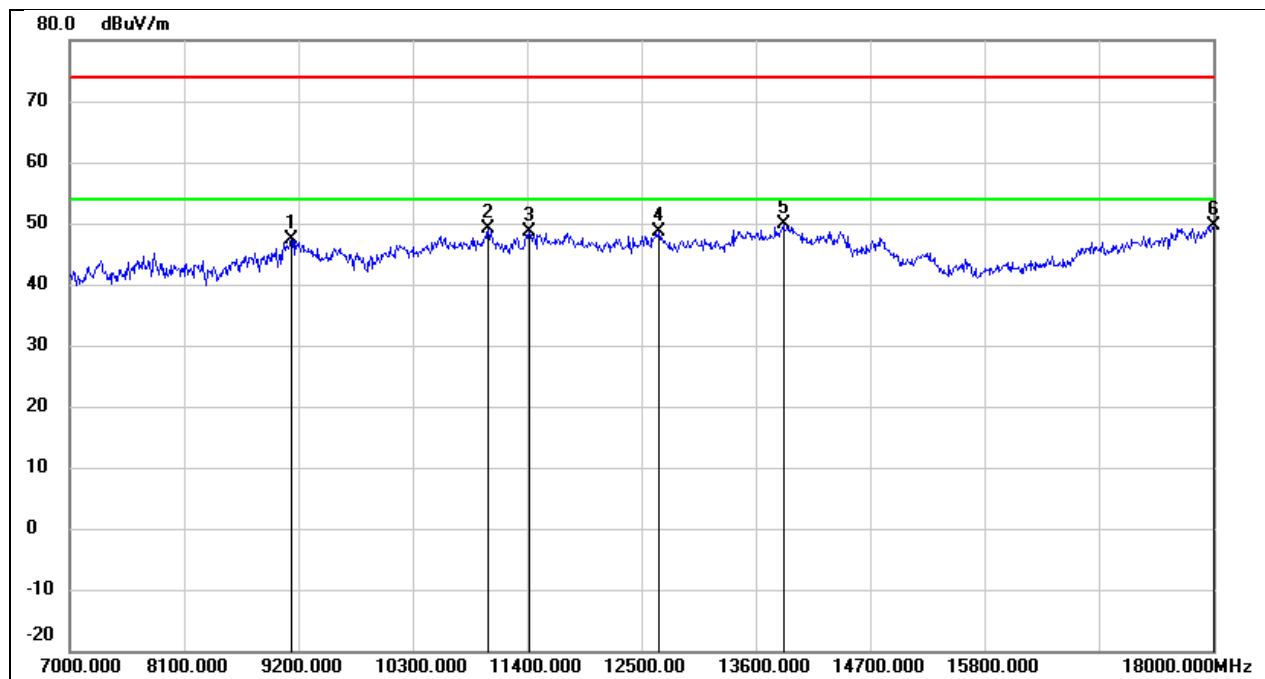

No.	Frequency (MHz)	Reading (dBuV)	Correct (dB/m)	Result (dBuV/m)	Limit (dBuV/m)	Margin (dB)	Remark
1	9134.000	36.91	10.41	47.32	74.00	-26.68	peak
2	11026.000	34.32	14.82	49.14	74.00	-24.86	peak
3	11422.000	32.05	16.46	48.51	74.00	-25.49	peak
4	12665.000	30.59	18.04	48.63	74.00	-25.37	peak
5	13864.000	28.42	21.53	49.95	74.00	-24.05	peak
6	18000.000	23.54	26.12	49.66	74.00	-24.34	peak

Test Mode:	802.11a 20	Frequency(MHz):	5580
Polarity:	Vertical	Test Voltage:	DC 12 V

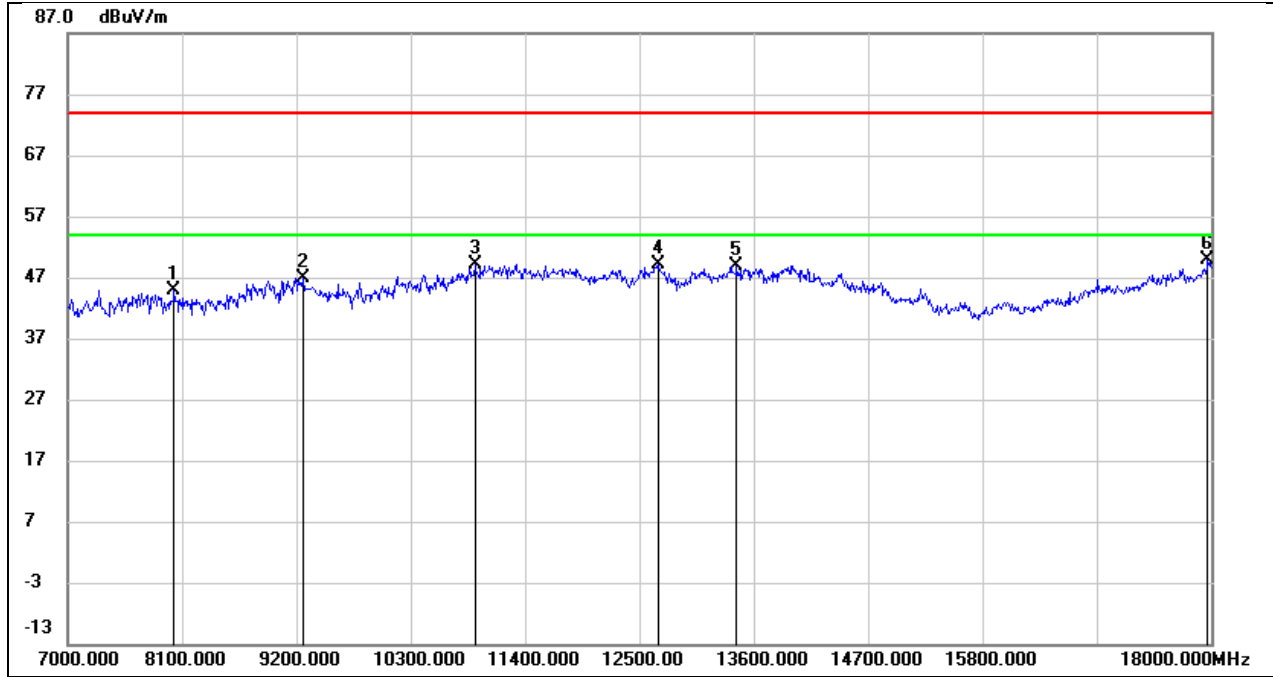

No.	Frequency (MHz)	Reading (dBuV)	Correct (dB/m)	Result (dBuV/m)	Limit (dBuV/m)	Margin (dB)	Remark
1	8023.000	38.48	6.45	44.93	74.00	-29.07	peak
2	9266.000	36.33	10.51	46.84	74.00	-27.16	peak
3	10916.000	34.68	14.39	49.07	74.00	-24.93	peak
4	12676.000	30.98	18.05	49.03	74.00	-24.97	peak
5	13435.000	28.64	20.35	48.99	74.00	-25.01	peak
6	17967.000	24.09	25.89	49.98	74.00	-24.02	peak

Test Mode:	802.11a 20	Frequency(MHz):	5700
Polarity:	Horizontal	Test Voltage:	DC 12 V

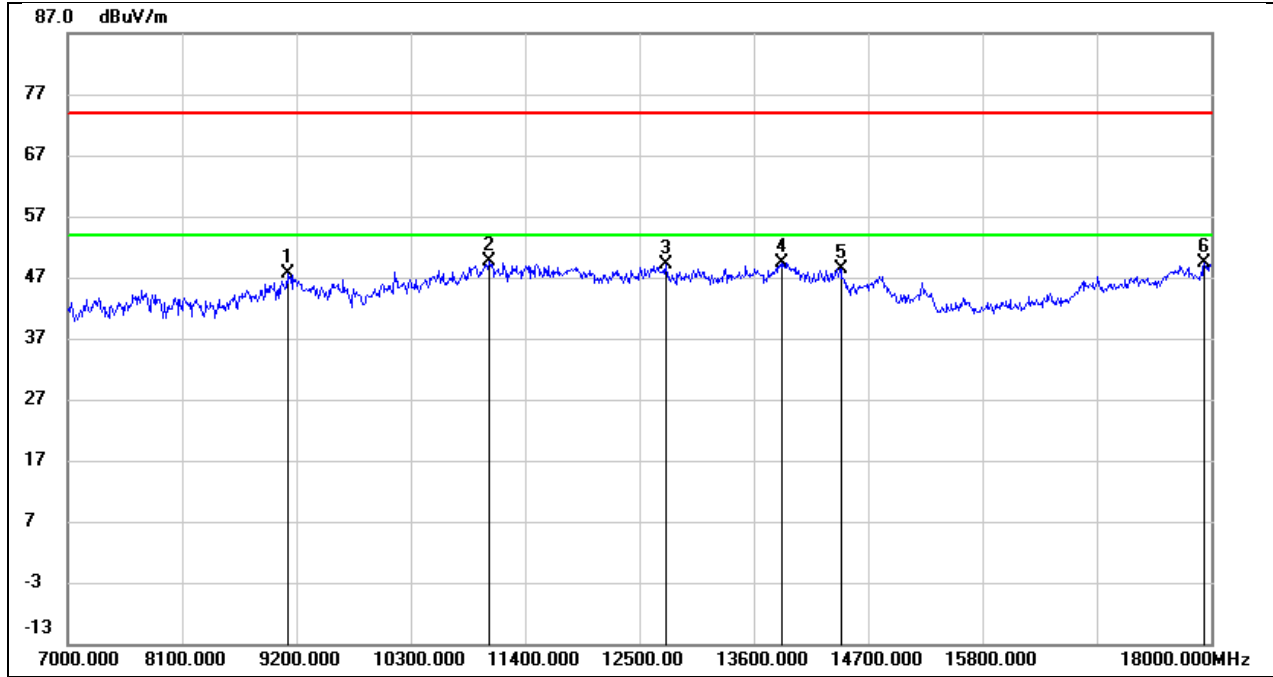

No.	Frequency (MHz)	Reading (dBuV)	Correct (dB/m)	Result (dBuV/m)	Limit (dBuV/m)	Margin (dB)	Remark
1	9112.000	37.12	10.41	47.53	74.00	-26.47	peak
2	11059.000	34.61	14.96	49.57	74.00	-24.43	peak
3	12753.000	30.93	18.14	49.07	74.00	-24.93	peak
4	13864.000	27.86	21.53	49.39	74.00	-24.61	peak
5	14436.000	28.39	20.05	48.44	74.00	-25.56	peak
6	17934.000	23.68	25.67	49.35	74.00	-24.65	peak

Test Mode:	802.11a 20	Frequency(MHz):	5700
Polarity:	Vertical	Test Voltage:	DC 12 V

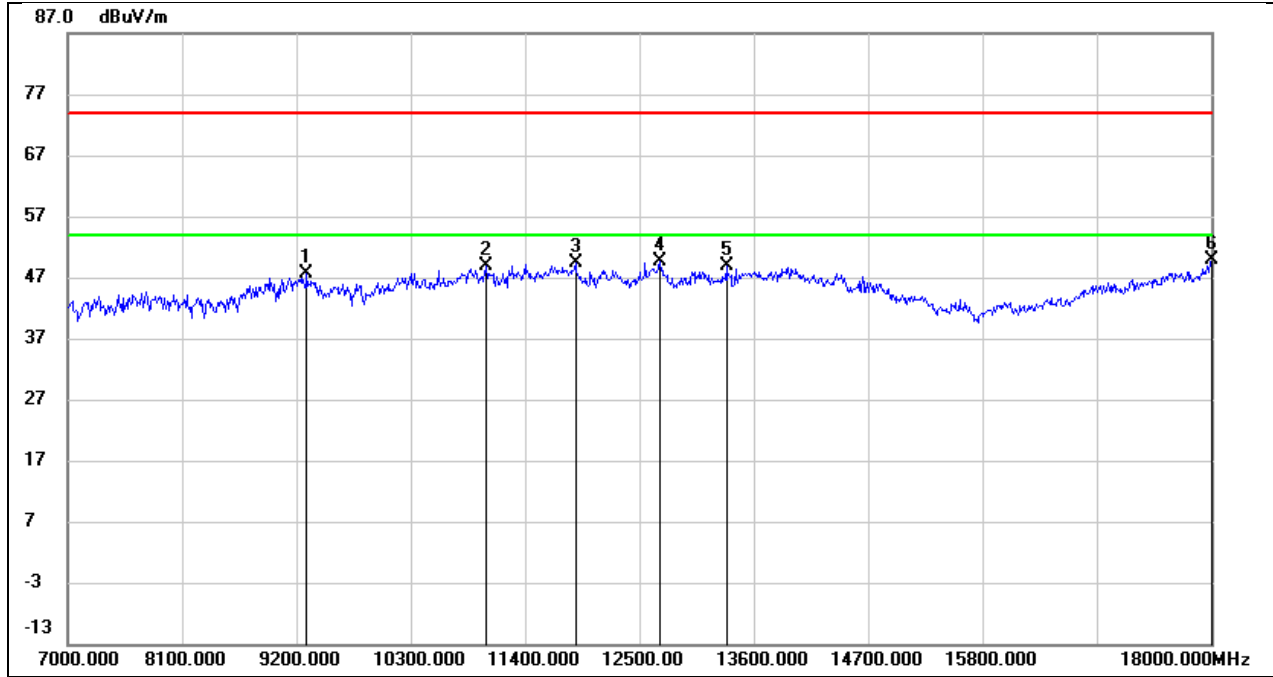

No.	Frequency (MHz)	Reading (dBuV)	Correct (dB/m)	Result (dBuV/m)	Limit (dBuV/m)	Margin (dB)	Remark
1	9299.000	37.01	10.53	47.54	74.00	-26.46	peak
2	11026.000	34.03	14.82	48.85	74.00	-25.15	peak
3	11884.000	31.89	17.48	49.37	74.00	-24.63	peak
4	12698.000	31.65	18.08	49.73	74.00	-24.27	peak
5	13336.000	29.02	19.93	48.95	74.00	-25.05	peak
6	18000.000	23.77	26.12	49.89	74.00	-24.11	peak

Test Mode:	802.11a 20	Frequency(MHz):	5720
Polarity:	Horizontal	Test Voltage:	DC 12 V

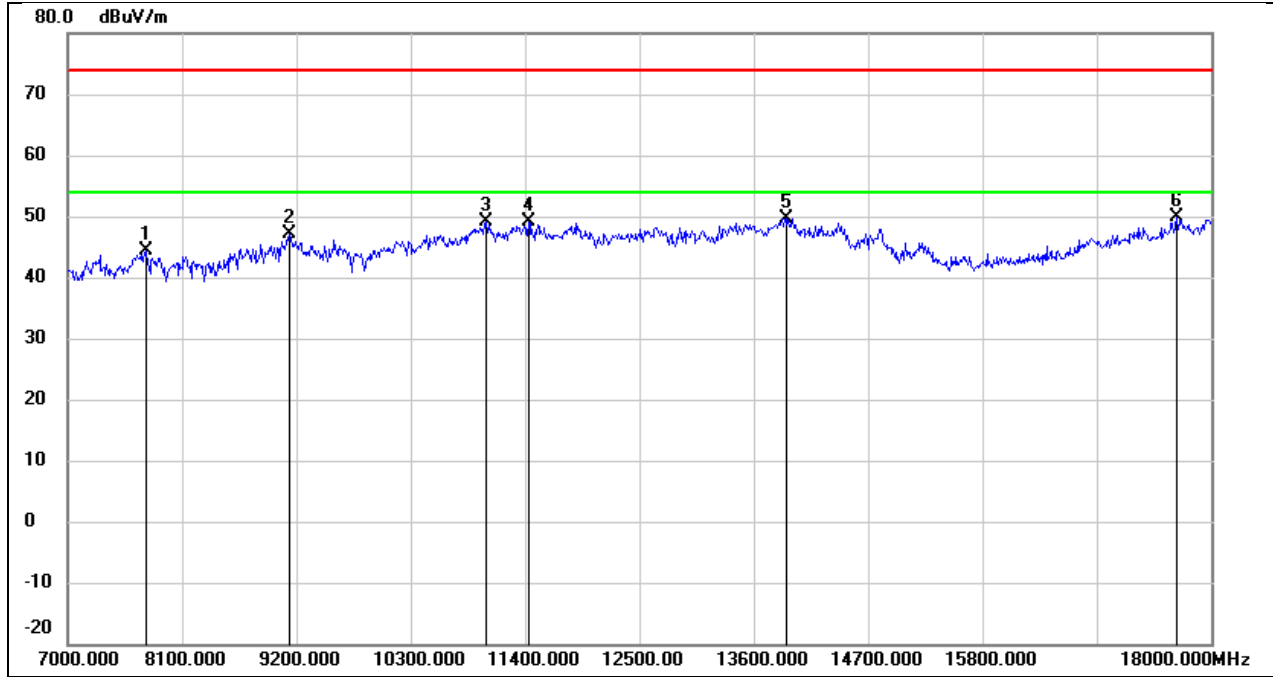

No.	Frequency (MHz)	Reading (dBuV)	Correct (dB/m)	Result (dBuV/m)	Limit (dBuV/m)	Margin (dB)	Remark
1	7759.000	37.77	6.64	44.41	74.00	-29.59	peak
2	9134.000	36.68	10.41	47.09	74.00	-26.91	peak
3	11026.000	34.42	14.82	49.24	74.00	-24.76	peak
4	11433.000	32.61	16.50	49.11	74.00	-24.89	peak
5	13919.000	28.06	21.68	49.74	74.00	-24.26	peak
6	17670.000	26.00	23.86	49.86	74.00	-24.14	peak

Test Mode:	802.11a 20	Frequency(MHz):	5720
Polarity:	Vertical	Test Voltage:	DC 12 V

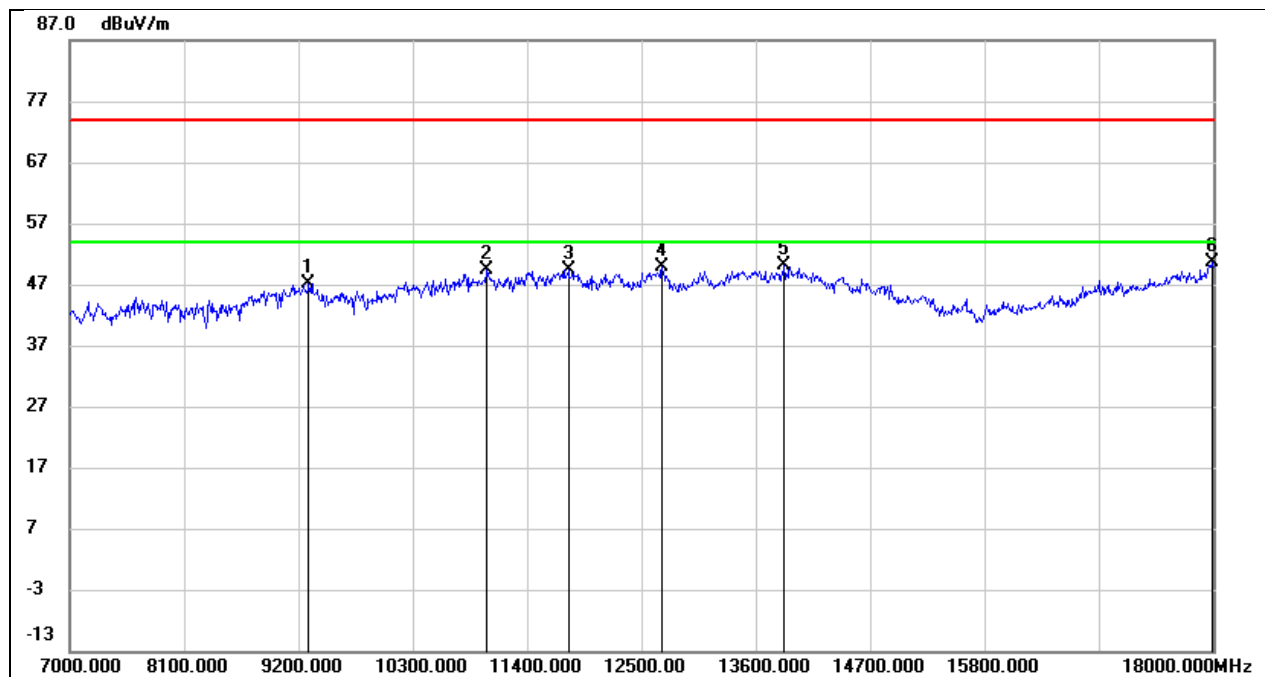

No.	Frequency (MHz)	Reading (dBuV)	Correct (dB/m)	Result (dBuV/m)	Limit (dBuV/m)	Margin (dB)	Remark
1	9299.000	36.61	10.53	47.14	74.00	-26.86	peak
2	11015.000	34.64	14.79	49.43	74.00	-24.57	peak
3	11796.000	32.13	17.32	49.45	74.00	-24.55	peak
4	12698.000	31.79	18.08	49.87	74.00	-24.13	peak
5	13875.000	28.53	21.57	50.10	74.00	-23.90	peak
6	17989.000	24.69	26.04	50.73	74.00	-23.27	peak

Test Mode:	802.11a 20	Frequency(MHz):	5745
Polarity:	Horizontal	Test Voltage:	DC 12 V

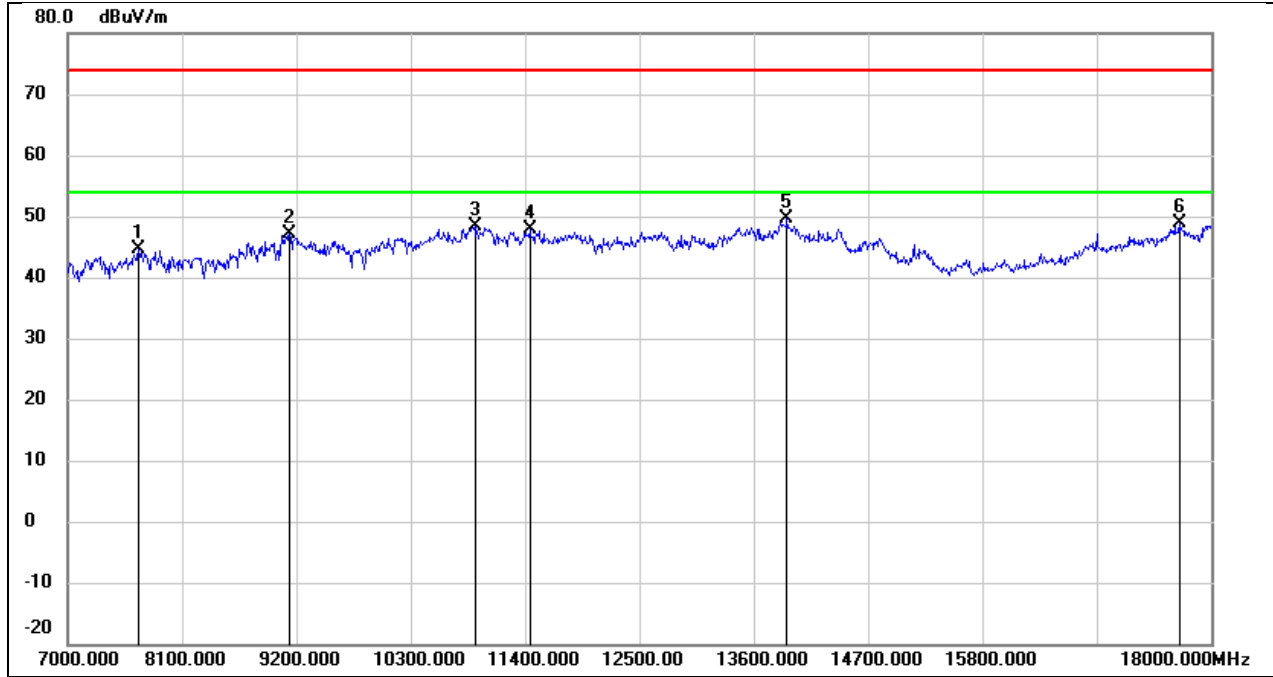

No.	Frequency (MHz)	Reading (dBuV)	Correct (dB/m)	Result (dBuV/m)	Limit (dBuV/m)	Margin (dB)	Remark
1	7682.000	37.80	6.71	44.51	74.00	-29.49	peak
2	9134.000	36.70	10.41	47.11	74.00	-26.89	peak
3	10916.000	33.90	14.39	48.29	74.00	-25.71	peak
4	11444.000	31.38	16.53	47.91	74.00	-26.09	peak
5	13919.000	27.96	21.68	49.64	74.00	-24.36	peak
6	17692.000	24.80	24.01	48.81	74.00	-25.19	peak

Test Mode:	802.11a 20	Frequency(MHz):	5745
Polarity:	Vertical	Test Voltage:	DC 12 V

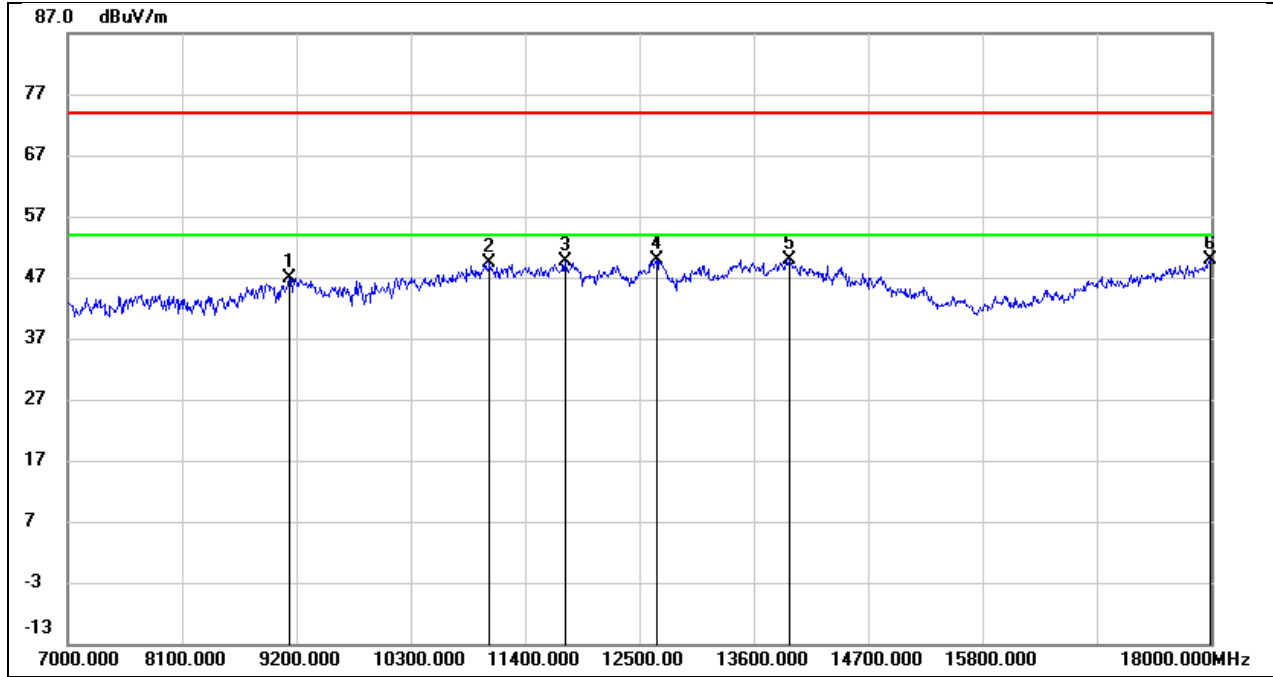

No.	Frequency (MHz)	Reading (dBuV)	Correct (dB/m)	Result (dBuV/m)	Limit (dBuV/m)	Margin (dB)	Remark
1	9134.000	36.54	10.41	46.95	74.00	-27.05	peak
2	11059.000	34.35	14.96	49.31	74.00	-24.69	peak
3	11785.000	32.25	17.30	49.55	74.00	-24.45	peak
4	12665.000	31.78	18.04	49.82	74.00	-24.18	peak
5	13941.000	28.26	21.73	49.99	74.00	-24.01	peak
6	17989.000	23.95	26.04	49.99	74.00	-24.01	peak

Test Mode:	802.11a 20	Frequency(MHz):	5785
Polarity:	Horizontal	Test Voltage:	DC 12 V

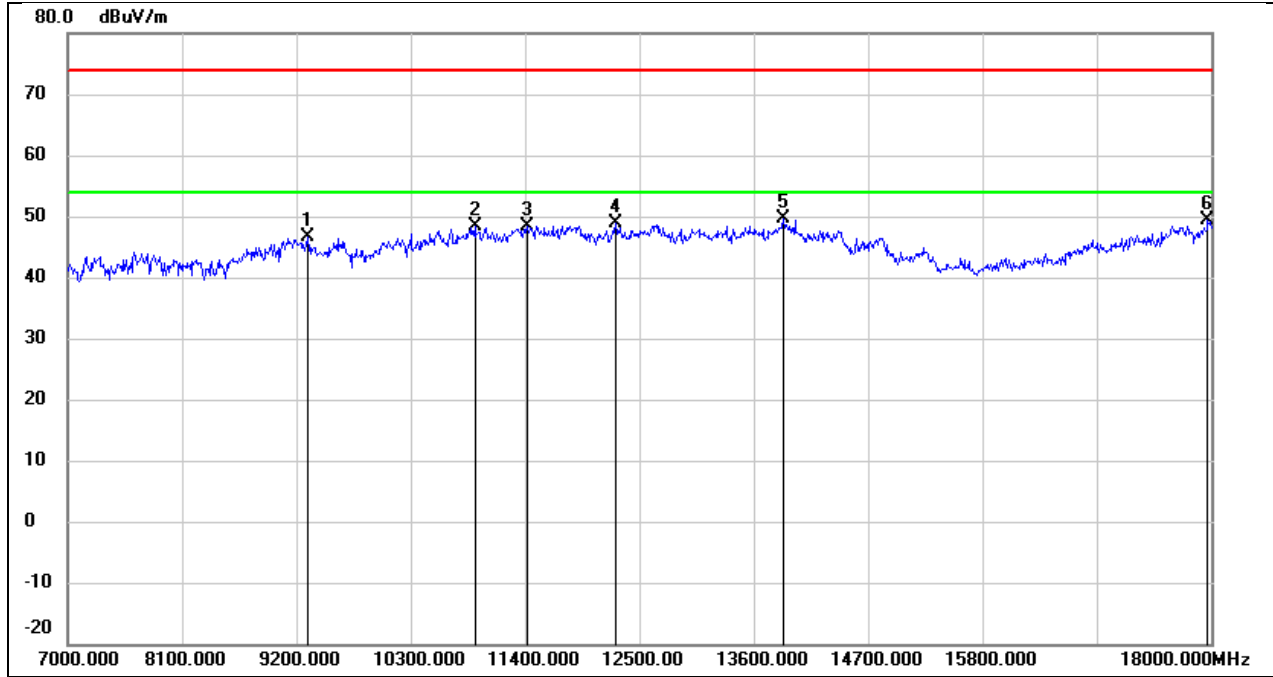

No.	Frequency (MHz)	Reading (dBuV)	Correct (dB/m)	Result (dBuV/m)	Limit (dBuV/m)	Margin (dB)	Remark
1	9310.000	36.04	10.54	46.58	74.00	-27.42	peak
2	10916.000	34.00	14.39	48.39	74.00	-25.61	peak
3	11422.000	31.89	16.46	48.35	74.00	-25.65	peak
4	12269.000	31.07	17.77	48.84	74.00	-25.16	peak
5	13886.000	28.03	21.60	49.63	74.00	-24.37	peak
6	17967.000	23.61	25.89	49.50	74.00	-24.50	peak

Test Mode:	802.11a 20	Frequency(MHz):	5785
Polarity:	Vertical	Test Voltage:	DC 12 V

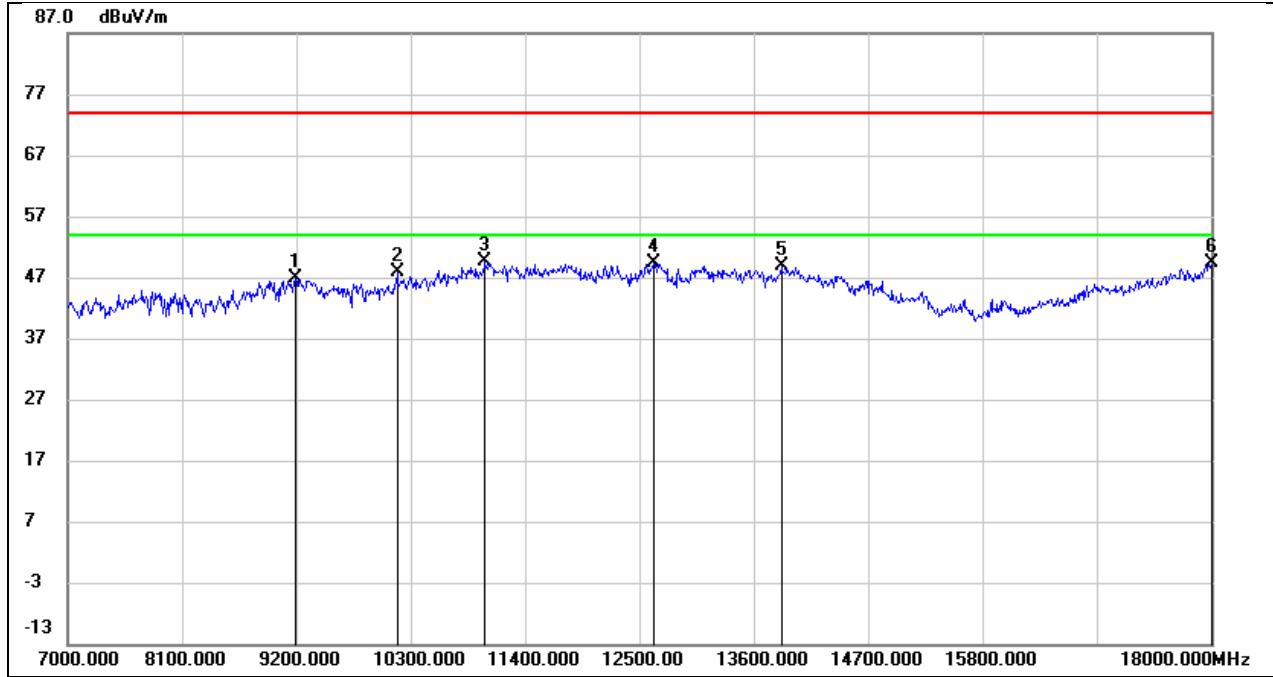

No.	Frequency (MHz)	Reading (dBuV)	Correct (dB/m)	Result (dBuV/m)	Limit (dBuV/m)	Margin (dB)	Remark
1	9189.000	36.46	10.46	46.92	74.00	-27.08	peak
2	10168.000	35.69	12.13	47.82	74.00	-26.18	peak
3	11015.000	34.84	14.79	49.63	74.00	-24.37	peak
4	12643.000	31.30	18.01	49.31	74.00	-24.69	peak
5	13864.000	27.45	21.53	48.98	74.00	-25.02	peak
6	18000.000	23.29	26.12	49.41	74.00	-24.59	peak

Test Mode:	802.11a 20	Frequency(MHz):	5825
Polarity:	Horizontal	Test Voltage:	DC 12 V

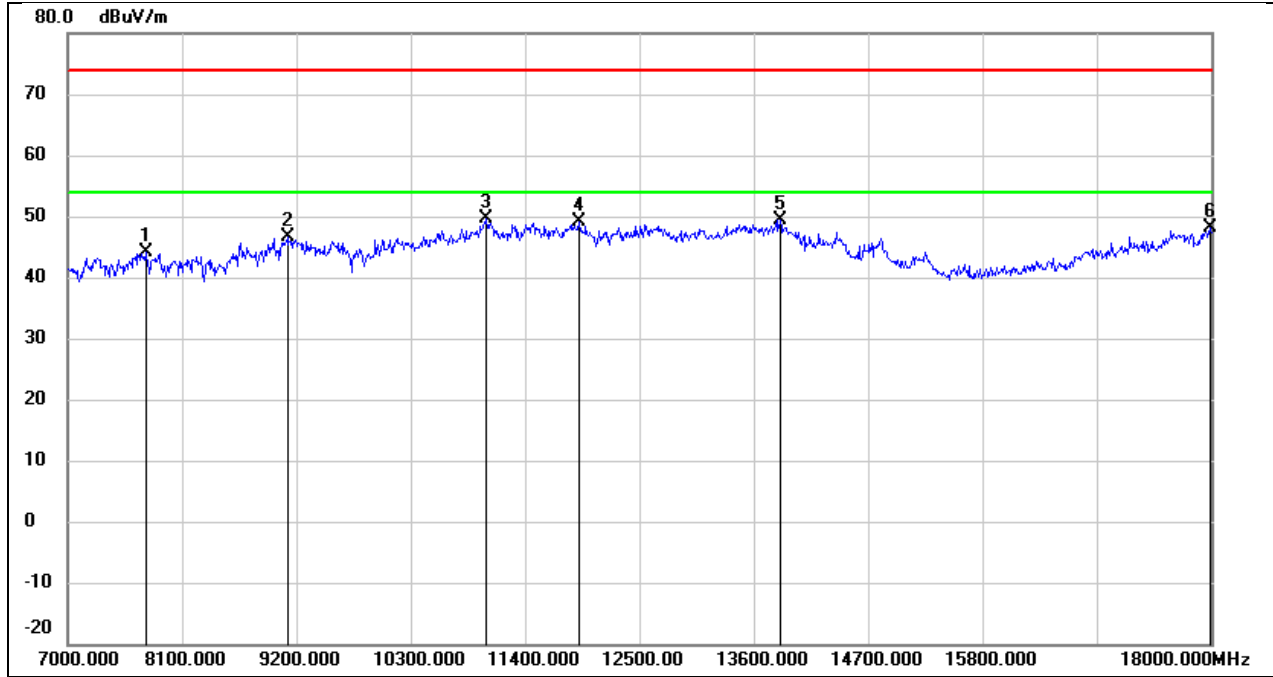

No.	Frequency (MHz)	Reading (dBuV)	Correct (dB/m)	Result (dBuV/m)	Limit (dBuV/m)	Margin (dB)	Remark
1	7748.000	37.54	6.66	44.20	74.00	-29.80	peak
2	9112.000	36.15	10.41	46.56	74.00	-27.44	peak
3	11026.000	34.69	14.82	49.51	74.00	-24.49	peak
4	11917.000	31.55	17.54	49.09	74.00	-24.91	peak
5	13853.000	27.85	21.52	49.37	74.00	-24.63	peak
6	17989.000	22.15	26.04	48.19	74.00	-25.81	peak

Test Mode:	802.11a 20	Frequency(MHz):	5825
Polarity:	Vertical	Test Voltage:	DC 12 V

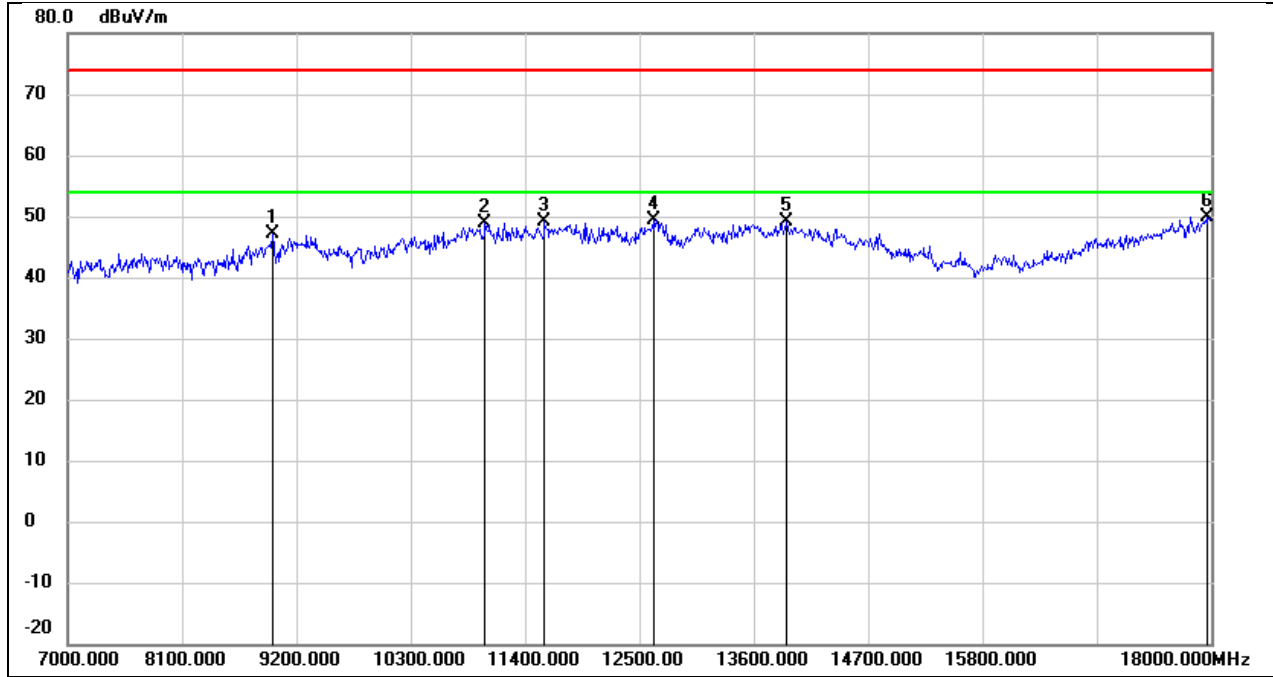

No.	Frequency (MHz)	Reading (dBuV)	Correct (dB/m)	Result (dBuV/m)	Limit (dBuV/m)	Margin (dB)	Remark
1	8969.000	36.92	10.13	47.05	74.00	-26.95	peak
2	11015.000	34.04	14.79	48.83	74.00	-25.17	peak
3	11587.000	32.18	16.93	49.11	74.00	-24.89	peak
4	12632.000	31.32	17.99	49.31	74.00	-24.69	peak
5	13919.000	27.37	21.68	49.05	74.00	-24.95	peak
6	17967.000	23.98	25.89	49.87	74.00	-24.13	peak

Test Mode:	802.11n HT20	Frequency(MHz):	5180
Polarity:	Horizontal	Test Voltage:	DC 12 V

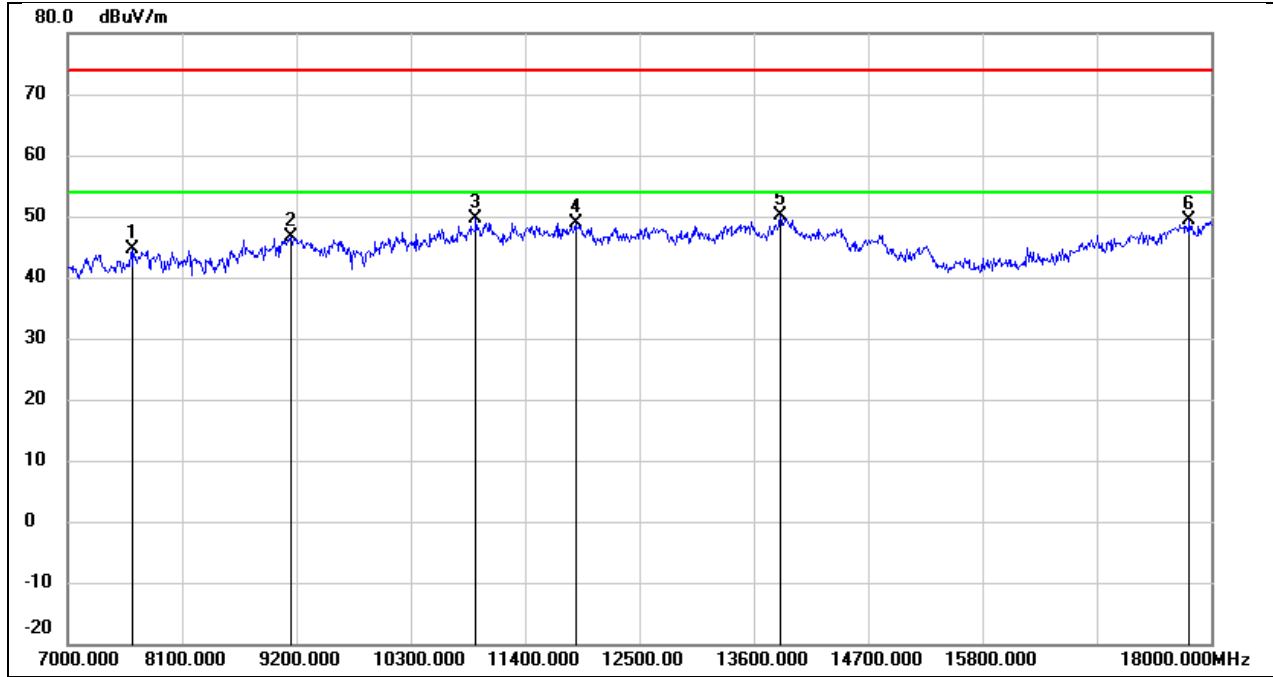

No.	Frequency (MHz)	Reading (dBuV)	Correct (dB/m)	Result (dBuV/m)	Limit (dBuV/m)	Margin (dB)	Remark
1	7627.000	37.81	6.76	44.57	74.00	-29.43	peak
2	9145.000	36.25	10.43	46.68	74.00	-27.32	peak
3	10927.000	35.07	14.45	49.52	74.00	-24.48	peak
4	11884.000	31.32	17.48	48.80	74.00	-25.20	peak
5	13853.000	28.51	21.52	50.03	74.00	-23.97	peak
6	17791.000	24.74	24.69	49.43	74.00	-24.57	peak

Test Mode:	802.11n HT20	Frequency(MHz):	5180
Polarity:	Vertical	Test Voltage:	DC 12 V

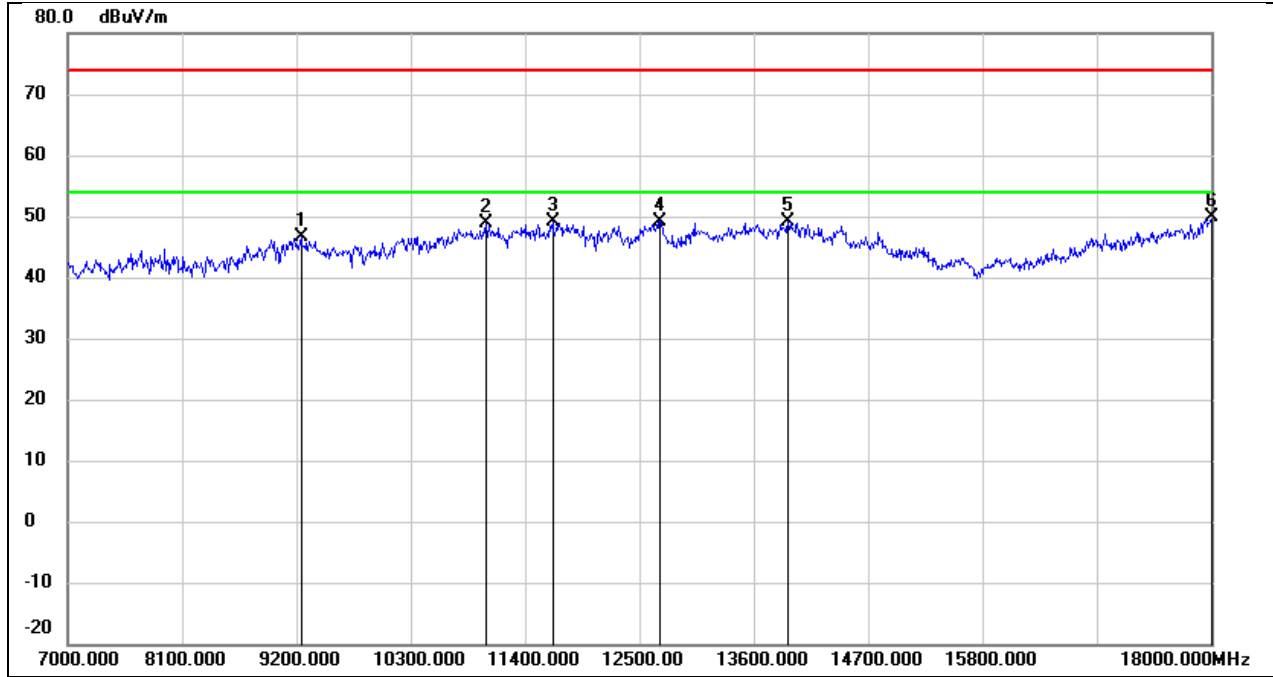

No.	Frequency (MHz)	Reading (dBuV)	Correct (dB/m)	Result (dBuV/m)	Limit (dBuV/m)	Margin (dB)	Remark
1	9244.000	36.17	10.49	46.66	74.00	-27.34	peak
2	11026.000	33.94	14.82	48.76	74.00	-25.24	peak
3	11664.000	32.14	17.08	49.22	74.00	-24.78	peak
4	12698.000	31.14	18.08	49.22	74.00	-24.78	peak
5	13930.000	27.52	21.71	49.23	74.00	-24.77	peak
6	18000.000	23.66	26.12	49.78	74.00	-24.22	peak

Test Mode:	802.11n HT20	Frequency(MHz):	5200
Polarity:	Horizontal	Test Voltage:	DC 12 V

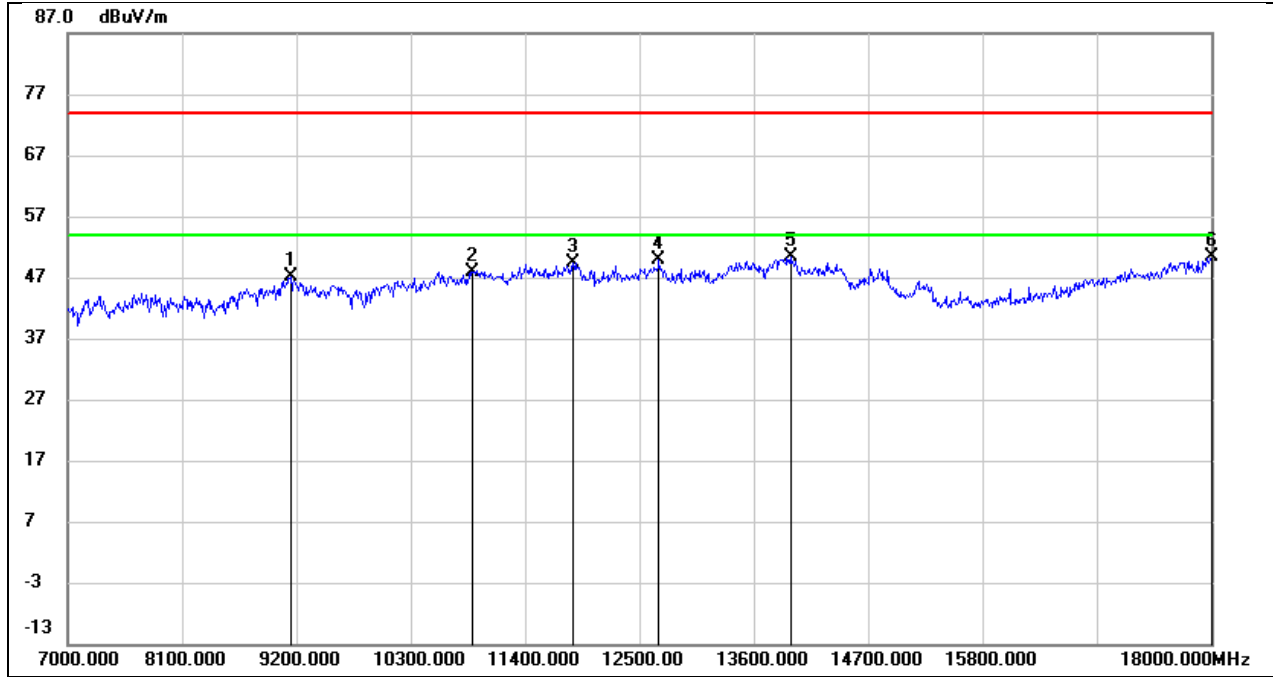

No.	Frequency (MHz)	Reading (dBuV)	Correct (dB/m)	Result (dBuV/m)	Limit (dBuV/m)	Margin (dB)	Remark
1	9145.000	36.61	10.43	47.04	74.00	-26.96	peak
2	10894.000	33.67	14.32	47.99	74.00	-26.01	peak
3	11862.000	31.87	17.45	49.32	74.00	-24.68	peak
4	12687.000	31.77	18.05	49.82	74.00	-24.18	peak
5	13952.000	28.62	21.76	50.38	74.00	-23.62	peak
6	18000.000	24.14	26.12	50.26	74.00	-23.74	peak

Test Mode:	802.11n HT20	Frequency(MHz):	5200
Polarity:	Vertical	Test Voltage:	DC 12 V

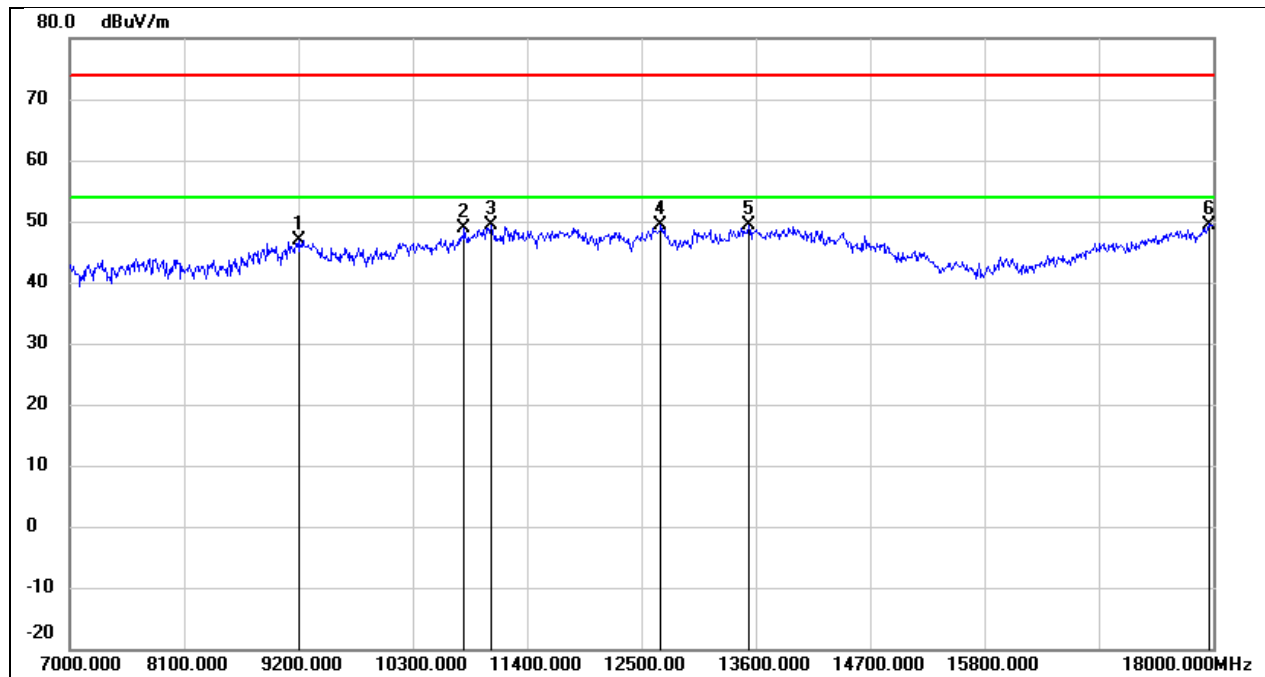

No.	Frequency (MHz)	Reading (dBuV)	Correct (dB/m)	Result (dBuV/m)	Limit (dBuV/m)	Margin (dB)	Remark
1	9200.000	36.53	10.46	46.99	74.00	-27.01	peak
2	10795.000	35.03	13.94	48.97	74.00	-25.03	peak
3	11059.000	34.38	14.96	49.34	74.00	-24.66	peak
4	12687.000	31.36	18.05	49.41	74.00	-24.59	peak
5	13534.000	28.58	20.73	49.31	74.00	-24.69	peak
6	17956.000	23.68	25.82	49.50	74.00	-24.50	peak

Test Mode:	802.11n HT20	Frequency(MHz):	5240
Polarity:	Horizontal	Test Voltage:	DC 12 V

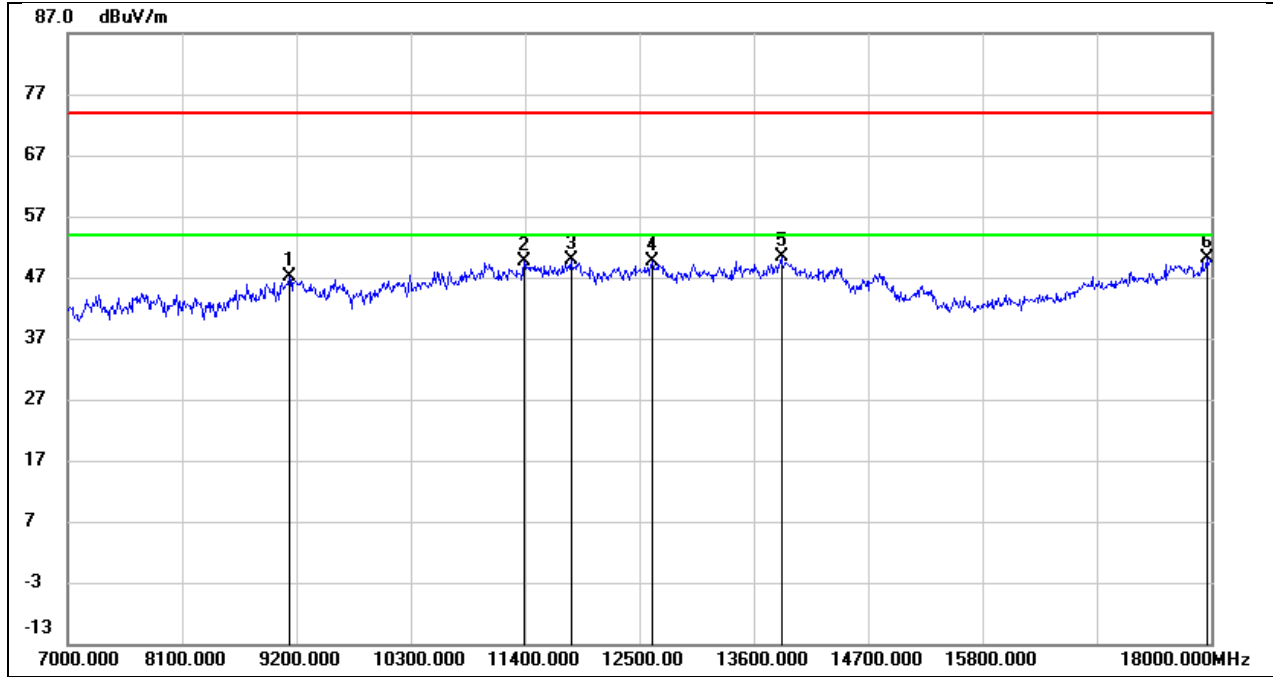

No.	Frequency (MHz)	Reading (dBuV)	Correct (dB/m)	Result (dBuV/m)	Limit (dBuV/m)	Margin (dB)	Remark
1	9134.000	36.63	10.41	47.04	74.00	-26.96	peak
2	11389.000	33.22	16.31	49.53	74.00	-24.47	peak
3	11840.000	32.48	17.40	49.88	74.00	-24.12	peak
4	12621.000	31.55	17.98	49.53	74.00	-24.47	peak
5	13864.000	28.86	21.53	50.39	74.00	-23.61	peak
6	17956.000	24.24	25.82	50.06	74.00	-23.94	peak

Test Mode:	802.11n HT20	Frequency(MHz):	5240
Polarity:	Vertical	Test Voltage:	DC 12 V

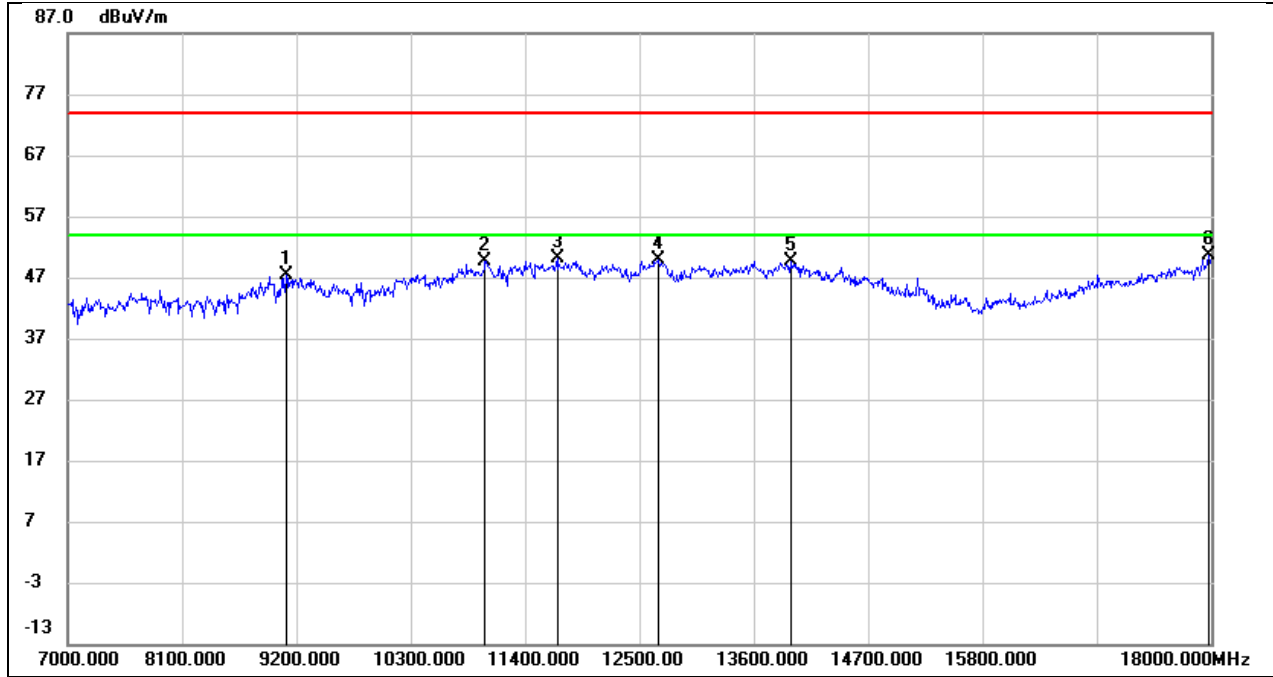

No.	Frequency (MHz)	Reading (dBuV)	Correct (dB/m)	Result (dBuV/m)	Limit (dBuV/m)	Margin (dB)	Remark
1	9101.000	36.95	10.40	47.35	74.00	-26.65	peak
2	11015.000	34.75	14.79	49.54	74.00	-24.46	peak
3	11708.000	32.93	17.16	50.09	74.00	-23.91	peak
4	12676.000	31.75	18.05	49.80	74.00	-24.20	peak
5	13952.000	27.92	21.76	49.68	74.00	-24.32	peak
6	17978.000	24.60	25.97	50.57	74.00	-23.43	peak

Test Mode:	802.11n HT20	Frequency(MHz):	5260
Polarity:	Horizontal	Test Voltage:	DC 12 V

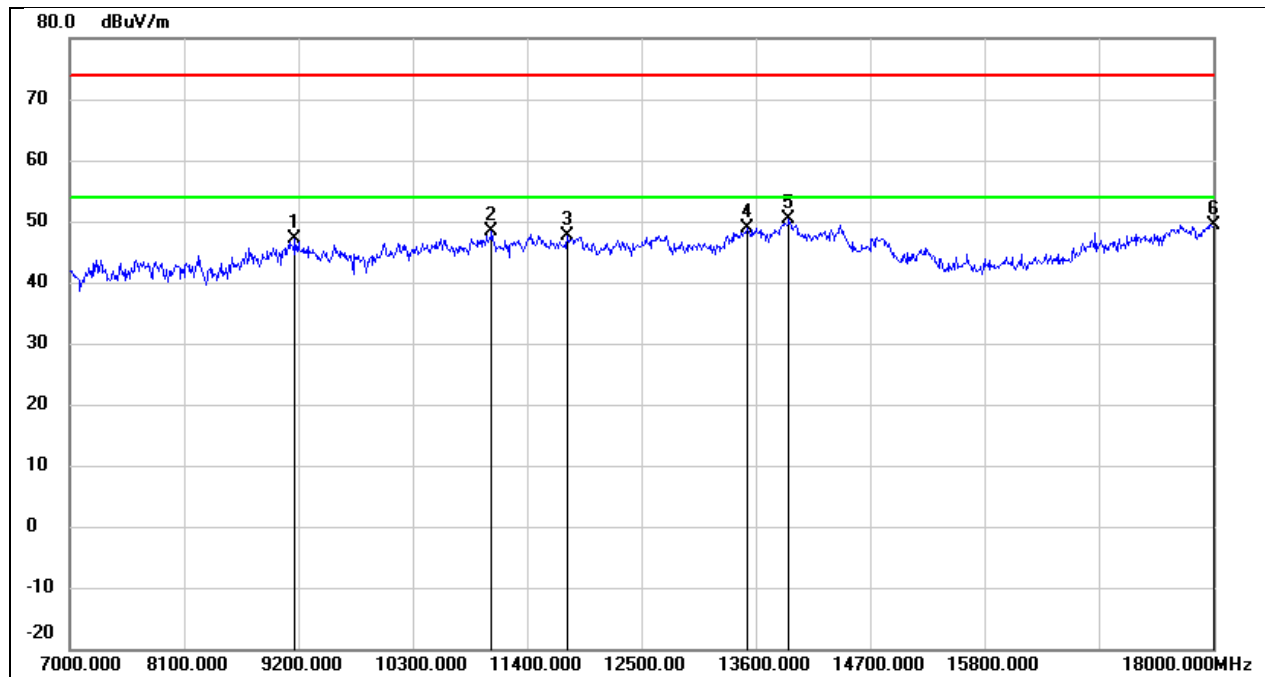

No.	Frequency (MHz)	Reading (dBuV)	Correct (dB/m)	Result (dBuV/m)	Limit (dBuV/m)	Margin (dB)	Remark
1	9167.000	36.66	10.45	47.11	74.00	-26.89	peak
2	11059.000	33.41	14.96	48.37	74.00	-25.63	peak
3	11785.000	30.35	17.30	47.65	74.00	-26.35	peak
4	13523.000	28.10	20.70	48.80	74.00	-25.20	peak
5	13919.000	28.69	21.68	50.37	74.00	-23.63	peak
6	18000.000	23.29	26.12	49.41	74.00	-24.59	peak