

**FCC 47 CFR PART 15 SUBPART B
CERTIFICATION TEST REPORT**

Product name: Interactive Touch Screen, LED Interactive Multi-Touch Display, Optimus-Touch Screen, Genee Touch, Interactive Led Monitor, Touch Pro

MODEL No.: TT-7015E, TT-7015EX, QIT 1270 10IN, TWB-I70, TWB-I70X, TWB-I70A, TWBI70AX, P-70D, 70G-Touch Slim-STND, TWB-IC70, TWB-IC70X, TWB-IC70A, TWB-IC70AX, HD-I7XXXE, HD-IXXXE, WS-Z7XXX, WB-XXXXX ('X'=0-9 or A-Z)

FCC ID: 2ACYT-AHH15V69-70

REPORT NO: ES151110029E

ISSUE DATE: March 23, 2016

Prepared for

**SHENZHEN Hitevision Technology Co., Ltd.
No. 8, Qinglan 1st Road, Pingshan, Shenzhen,
Guangdong 518118, P. R. China**

Prepared by

EMTEK (SHENZHEN) CO., LTD.

**Bldg 69, Majialong Industry Zone, Nanshan District, Shenzhen,
Guangdong, China
TEL: 86-755-26954280
FAX: 86-755-26954282**

TABLE OF CONTENT

Test Report Description	Page
1. SUMMARY OF TEST RESULT	5
2. GENERAL INFORMATION	6
2.1. DESCRIPTION OF DEVICE (EUT)	6
2.2. DESCRIPTION OF TEST FACILITY	6
2.3. DESCRIPTION OF SUPPORT DEVICE	7
2.4. MEASUREMENT UNCERTAINTY	7
3. MEASURING DEVICE AND TEST EQUIPMENT	8
3.1. FOR POWER LINE CONDUCTED EMISSION MEASUREMENT	8
3.2. FOR RADIATED EMISSION MEASUREMENT (10M CHAMBER).....	8
3.3. FOR RADIATED EMISSION MEASUREMENT (3M CHAMBER).....	8
4. CONDUCTED EMISSION MEASUREMENT	9
4.1. BLOCK DIAGRAM OF TEST SETUP	9
4.2. MEASURING STANDARD.....	9
4.3. POWER LINE CONDUCTED EMISSION LIMITS (CLASS B)	9
4.4. EUT CONFIGURATION ON MEASUREMENT	9
4.5. OPERATING CONDITION OF EUT	9
4.6. TEST PROCEDURE	10
4.7. MEASURING RESULTS	10
5. RADIATED EMISSION MEASUREMENT.....	23
5.1. BLOCK DIAGRAM OF TEST SETUP	23
5.2. MEASURING STANDARD.....	24
5.3. RADIATED EMISSION LIMITS (CLASS B)	24
5.4. EUT CONFIGURATION ON MEASUREMENT	24
5.5. OPERATING CONDITION OF EUT	24
5.6. TEST PROCEDURE	24
5.7. MEASURING RESULTS	25
6. PHOTOGRAPHS	50
6.1. PHOTOS OF CONDUCTED EMISSION MEASUREMENT	50
6.2. PHOTOS OF RADIATION EMISSION MEASUREMENT	51

APPENDIX (Photos of EUT) (8 Pages)

TEST REPORT DESCRIPTION

Applicant : SHENZHEN Hitevision Technology Co., Ltd.
No. 8, Qinglan 1st Road, Pingshan, Shenzhen, Guangdong 518118, P. R. China

Manufacturer : SHENZHEN Hitevision Technology Co., Ltd.
No. 8, Qinglan 1st Road, Pingshan, Shenzhen, Guangdong 518118, P. R. China

Trademark : 

EUT : Interactive Touch Screen, LED Interactive Multi-Touch Display, Optimus-Touch Screen, Genee Touch, Interactive Led Monitor, Touch Pro

Model No. : TT-7015E, TT-7015EX, QIT 1270 10IN, TWB-I70, TWB-I70X, TWB-I70A, TWB-I70AX, P-70D, 70G-Touch Slim-STND, TWB-IC70, TWB-IC70X, TWB-IC70A, TWB-IC70AX, HD-I7XXXE, HD-IXXXXE, WS-Z7XXX, WB-XXXXX ('X'=0-9 or A-Z)

Power Supply : AC 100-240V 50/60Hz 2.5A Max

Measurement Procedure Used:

FCC Rules and Regulations Part 15: 2015 Subpart B Class B & FCC / ANSI C63.4-2014

The device described above is tested by EMTEK (SHENZHEN) CO., LTD. to determine the maximum emission levels emanating from the device and the severe levels of the device can endure and its performance criterion. The measurement results are contained in this test report and EMTEK (SHENZHEN) CO., LTD. is assumed full of responsibility for the accuracy and completeness of these measurements. Also, this report shows that the EUT (Equipment Under Test) is technically compliant with the FCC requirements.

This report applies to above tested sample only and shall not be reproduced in part without written approval of EMTEK (SHENZHEN) CO., LTD.

Date of Test : November 11, 2015 to March 22, 2016

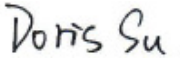
Prepared by : 
Doris Su/Editor

Reviewer : 
Yaping Shen /Supervisor

Approved & Authorized Signer : 
Lisa Wang/Manager

Modified Information

Version	Report No.	Revision Date	Summary
Ver.1.0	ES151110029E	2016-03-23	Original Report

1. SUMMARY OF TEST RESULT

EMISSION		
Description of Test Item	Standard & Limits	Results
Conducted Disturbance at Mains Terminals	FCC Part 15, Subpart B, Class B ANSI C63.4: 2014	Pass
Radiated Disturbance	FCC Part 15, Subpart B, Class B ANSI C63.4: 2014	Pass
Note: N/A is an abbreviation for Not Applicable.		

2. GENERAL INFORMATION

2.1. Description of Device (EUT)

EUT	:	Interactive Touch Screen, LED Interactive Multi-Touch Display, Optimus-Touch Screen, Genee Touch, Interactive Led Monitor, Touch Pro
Model Number	:	TT-7015E, TT-7015EX, QIT 1270 10IN, TWB-I70, TWB-I70X, TWB-I70A, TWBI70AX, P-70D, 70G-Touch Slim-STND, TWB-IC70, TWB-IC70X, TWB-IC70A, TWB-IC70AX, HD-I7XXE, HD-IXXXE, WS-Z7XXX, WB-XXXXX ('X'=0-9 or A-Z) (Note: These models are identical in circuitry and electrical, mechanical and physical construction; the only difference are appearance, trade mark and the model number. for trading purpose. We prepare TT-7015E for all test.)
Test Voltage	:	AC 120V/60Hz
Applicant	:	SHENZHEN Hitevision Technology Co., Ltd.
Address	:	No. 8, Qinglan 1st Road, Pingshan, Shenzhen, Guangdong 518118, P. R. China
Manufacturer	:	SHENZHEN Hitevision Technology Co., Ltd.
Address	:	No. 8, Qinglan 1st Road, Pingshan, Shenzhen, Guangdong 518118, P. R. China
Date of Received	:	November 11, 2015
Date of Test	:	November 11, 2015 to March 22, 2016

2.2. Description of Test Facility

Site Description EMC Lab.	:	Accredited by CNAS, 2013.10.29 The certificate is valid until 2016.10.28 The Laboratory has been assessed and proved to be in compliance with CNAS-CL01:2006 (identical to ISO/IEC 17025:2005) The Certificate Registration Number is L2291. Accredited by TUV Rheinland Shenzhen 2010.5.25 The Laboratory has been assessed according to the requirements ISO/IEC 17025. Accredited by FCC, April 17, 2013 The Certificate Registration Number is 709623. Accredited by Industry Canada, November 15, 2010 The Certificate Registration Number is 4480A-2.
Name of Firm	:	EMTEK (SHENZHEN) CO., LTD.
Site Location	:	Bldg 69, Majialong Industry Zone, Nanshan District, Shenzhen, Guangdong, China

2.3. Description of Support Device

PC : Manufacturer: LENOVO
M/N: 9702
S/N: L3C4410
CE, FCC: DOC

Keyboard : Manufacturer: LENOVO
M/N: KU-0225
S/N:0585494
CE, FCC: DOC

Mouse : Manufacturer: LENOVO
M/N: MO28UOL
S/N:44G7862 068
CE, FCC: DOC

2.4. Measurement Uncertainty

Test Item	Uncertainty
Conducted Emission Uncertainty	: 2.96dB(9k~150kHz Conduction 1#) 2.74dB(150k-30MHz Conduction 1#)
Radiated Emission Uncertainty (10m Chamber)	: 3.96dB (30M~1GHz Polarize: H) 4.04dB (30M~1GHz Polarize: V)
Radiated Emission Uncertainty (3m Chamber)	4.46dB (1~6GHz)

3. MEASURING DEVICE AND TEST EQUIPMENT

3.1. For Power Line Conducted Emission Measurement

Item	Equipment	Manufacturer	Model No.	Serial No.	Last Cal.	Cal. Interval
<input checked="" type="checkbox"/>	Test Receiver	Rohde & Schwarz	ESCI	26115-010-0027	May 16, 2015	1 Year
<input checked="" type="checkbox"/>	L.I.S.N.	Rohde & Schwarz	ENV216	101161	May 16, 2015	1 Year
<input checked="" type="checkbox"/>	50Ω Coaxial Switch	Anritsu	MP59B	6100175589	May 16, 2015	1 Year
<input checked="" type="checkbox"/>	Voltage Probe	Rohde & Schwarz	ESH2-Z3	100122	May 16, 2015	1 Year

3.2. For Radiated Emission Measurement (10m Chamber)

Item	Equipment	Manufacturer	Model No.	Serial No.	Last Cal.	Cal. Interval
<input checked="" type="checkbox"/>	EMI Test Receiver	Rohde & Schwarz	ESR3	1316.3003K03-101706-HN	May 16, 2015	1 Year
<input checked="" type="checkbox"/>	EMI Test Receiver	Rohde & Schwarz	ESR3	1316.3003K03-101707-Z1	May 16, 2015	1 Year
<input checked="" type="checkbox"/>	Pre-Amplifier	Lunar EM	LNA10M1G-40	J1011130912001	May 16, 2015	1 Year
<input checked="" type="checkbox"/>	Pre-Amplifier	Lunar EM	LNA10M1G-40	J1011131126002	May 16, 2015	1 Year
<input checked="" type="checkbox"/>	Bilog Antenna	Schwarzbeck	VULB9163	659	May 16, 2015	1 Year
<input checked="" type="checkbox"/>	Bilog Antenna	Schwarzbeck	VULB9163	661	May 16, 2015	1 Year

3.3. For Radiated Emission Measurement (3m Chamber)

Item	Equipment	Manufacturer	Model No.	Serial No.	Last Cal.	Cal. Interval
<input checked="" type="checkbox"/>	EMI Test Receiver	Rohde & Schwarz	ESU	1302.6005.26	May 16, 2015	1 Year
<input checked="" type="checkbox"/>	Pre-Amplifier	A.H.	PAM-0126	1415261	May 16, 2015	1 Year
<input checked="" type="checkbox"/>	Horn Antenna	Schwarzbeck	BBHA 9120	707	May 16, 2015	1 Year

4. CONDUCTED EMISSION MEASUREMENT

4.1. Block Diagram of Test Setup

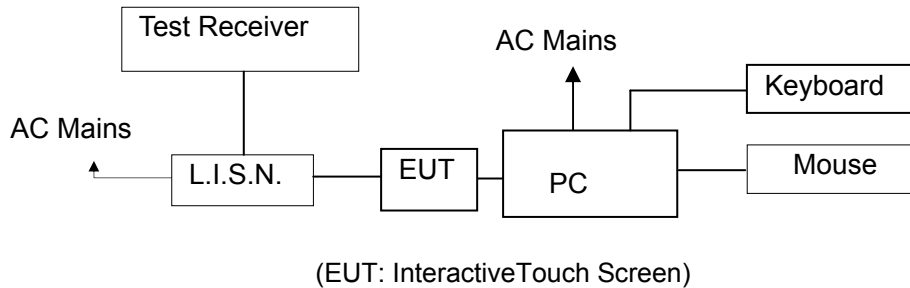

4.2. Measuring Standard

FCC Part 15, Subpart B, Class BANSI C63.4: 2014

4.3. Power Line Conducted Emission Limits (Class B)

Frequency (MHz)	Limit (dB μ V)	
	Quasi-peak Level	Average Level
0.15 ~ 0.50	66.0 ~ 56.0 *	56.0 ~ 46.0 *
0.50 ~ 5.00	56.0	46.0
5.00 ~ 30.00	60.0	50.0

NOTE1-The lower limit shall apply at the transition frequencies.
NOTE2-The limit decreases linearly with the logarithm of the frequency in the range 0.15MHz to 0.50MHz.

4.4. EUT Configuration on Measurement

The following equipments are installed on Conducted Emission Measurement to meet FCC requirements and operating in a manner which tends to maximize its emission characteristics in a normal application.

EUT : InteractiveTouch Screen
Model Number : TT-7015E

4.5. Operating Condition of EUT

4.5.1. Setup the EUT as shown on Section 4.1.

4.5.2. Turn on the power of all equipments.

4.5.3. Let the EUT work in measuring mode (VGA, HDMI IN, AV IN, USB PLAY, TOUCH MODE, Y+Pb+Pr IN) and measure it.

4.6. Test Procedure

The EUT is put on the plane 0.8m high above the ground by insulating support and connected to the AC mains through Line Impedance Stability Network (L.I.S.N). This provided a 50ohm coupling impedance for the tested equipments. Both sides of AC line are investigated to find out the maximum conducted emission according to the FCC regulations during conducted emission measurement.

The bandwidth of the field strength meter (R&S Test Receiver ESCS30) is set at 9kHz in 150kHz~30MHz and 200Hz in 9kHz~150kHz.

The frequency range from 150kHz to 30MHz is investigated.

All the modes were tested and the data of the worst modes are attached the following pages.

4.7. Measuring Results

PASS.

Please refer to the following pages.

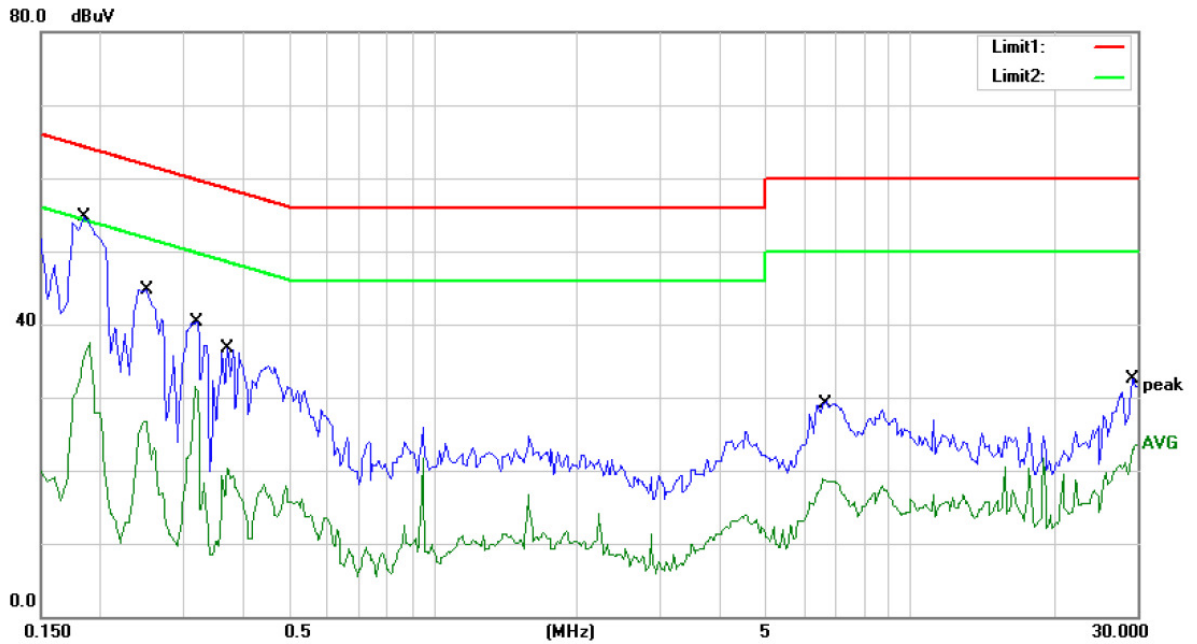

Site Conduction #1

Phase: **L1**

Temperature: 22

Limit: (CE)FCC PART 15 class B_QP

Power: AC 120V/60Hz

Humidity: 50 %

Mode: VGA

Note:

No.	Mk.	Freq. MHz	Reading Level dBuV	Correct Factor dB	Measure- ment dBuV	Limit dBuV	Over dB	Detector	Comment
1	*	0.1850	54.65	0.00	54.65	64.26	-9.61	QP	
2		0.1850	37.44	0.00	37.44	54.26	-16.82	AVG	
3		0.2500	44.75	0.00	44.75	61.76	-17.01	QP	
4		0.2500	26.76	0.00	26.76	51.76	-25.00	AVG	
5		0.3150	40.33	0.00	40.33	59.84	-19.51	QP	
6		0.3150	31.54	0.00	31.54	49.84	-18.30	AVG	
7		0.3700	36.67	0.00	36.67	58.50	-21.83	QP	
8		0.3700	20.38	0.00	20.38	48.50	-28.12	AVG	
9		6.5400	29.44	0.00	29.44	60.00	-30.56	QP	
10		6.5400	18.81	0.00	18.81	50.00	-31.19	AVG	
11		29.3500	32.57	0.00	32.57	60.00	-27.43	QP	
12		29.3500	23.57	0.00	23.57	50.00	-26.43	AVG	

*:Maximum data x:Over limit !:over margin Comment: Factor build in receiver. Operator: XY

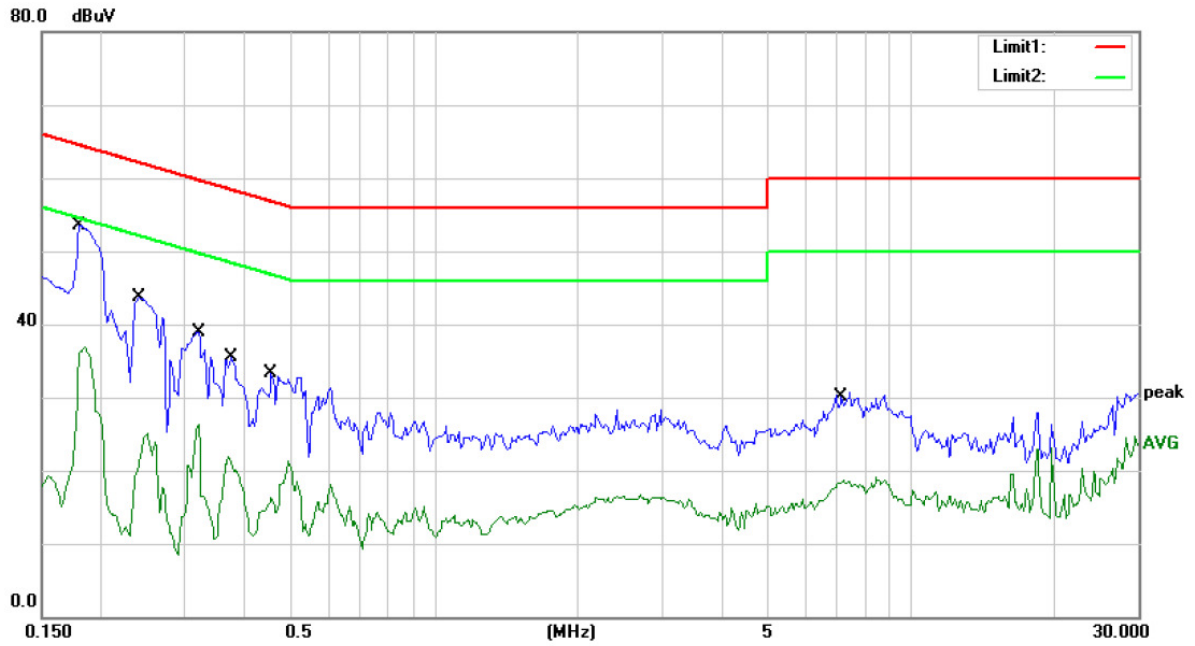

Site Conduction #1 Phase: **N** Temperature: 22
 Limit: (CE)FCC PART 15 class B_QP Power: AC 120V/60Hz Humidity: 50 %
 Mode: VGA
 Note:

No.	Mk.	Freq.	Reading Level	Correct Factor	Measurement	Limit	Over	Detector	Comment
		MHz	dBuV	dB	dBuV	dBuV	dB		
1	*	0.1800	53.54	0.00	53.54	64.49	-10.95	QP	
2		0.1800	36.90	0.00	36.90	54.49	-17.59	AVG	
3		0.2400	43.66	0.00	43.66	62.10	-18.44	QP	
4		0.2400	25.20	0.00	25.20	52.10	-26.90	AVG	
5		0.3200	38.98	0.00	38.98	59.71	-20.73	QP	
6		0.3200	26.29	0.00	26.29	49.71	-23.42	AVG	
7		0.3700	35.43	0.00	35.43	58.50	-23.07	QP	
8		0.3700	21.80	0.00	21.80	48.50	-26.70	AVG	
9		0.4550	33.22	0.00	33.22	56.78	-23.56	QP	
10		0.4550	21.27	0.00	21.27	46.78	-25.51	AVG	
11		7.2500	30.62	0.00	30.62	60.00	-29.38	QP	
12		7.2500	18.79	0.00	18.79	50.00	-31.21	AVG	

*:Maximum data x:Over limit !:over margin Comment: Factor build in receiver. Operator: XY

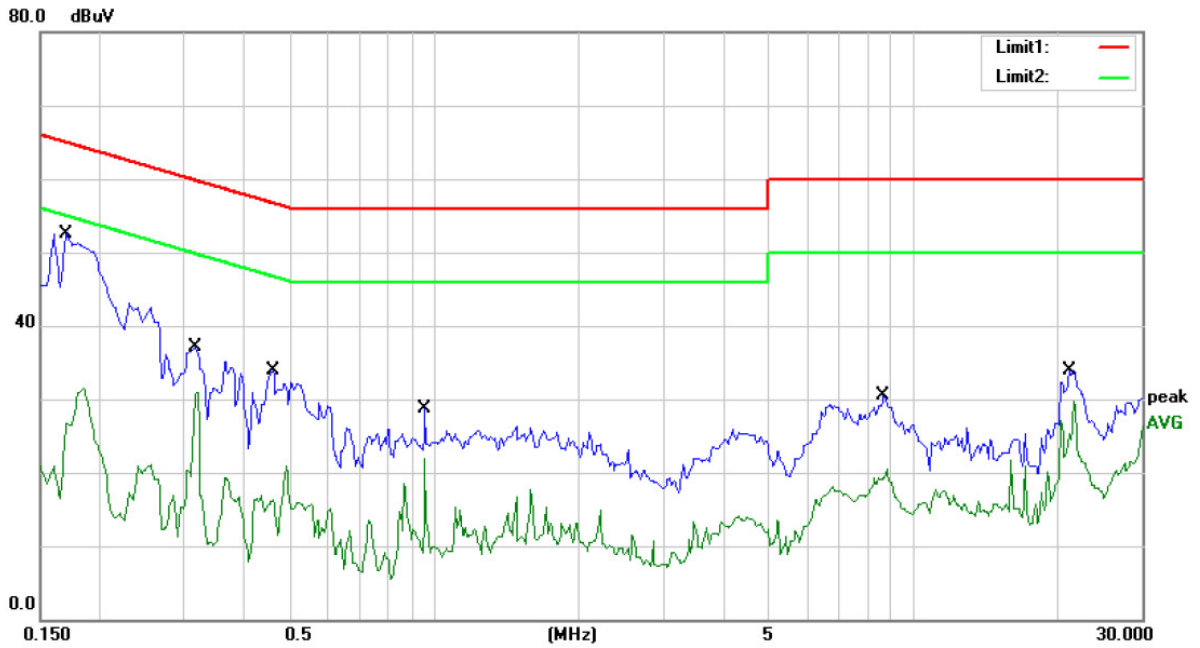

Site Conduction #1

Phase: **L1**

Temperature: 22

Limit: (CE)FCC PART 15 class B_QP

Power: AC 120V/60Hz

Humidity: 50 %

Mode: HDMI IN

Note:

No.	Mk.	Freq. MHz	Reading Level dBuV	Correct Factor dB	Measure- ment dBuV	Limit dBuV	Over dB	Detector	Comment
1	*	0.1700	52.55	0.00	52.55	64.96	-12.41	QP	
2		0.1700	31.48	0.00	31.48	54.96	-23.48	AVG	
3		0.3150	37.18	0.00	37.18	59.84	-22.66	QP	
4		0.3150	30.91	0.00	30.91	49.84	-18.93	AVG	
5		0.4600	34.00	0.00	34.00	56.69	-22.69	QP	
6		0.4600	20.99	0.00	20.99	46.69	-25.70	AVG	
7		0.4600	20.52	0.00	20.52	46.69	-26.17	AVG	
8		0.9550	28.79	0.00	28.79	56.00	-27.21	QP	
9		0.9550	21.99	0.00	21.99	46.00	-24.01	AVG	
10		8.6800	30.41	0.00	30.41	60.00	-29.59	QP	
11		21.2500	33.85	0.00	33.85	60.00	-26.15	QP	
12		21.2500	29.71	0.00	29.71	50.00	-20.29	AVG	

*:Maximum data x:Over limit !:over margin Comment: Factor build in receiver. Operator: XY

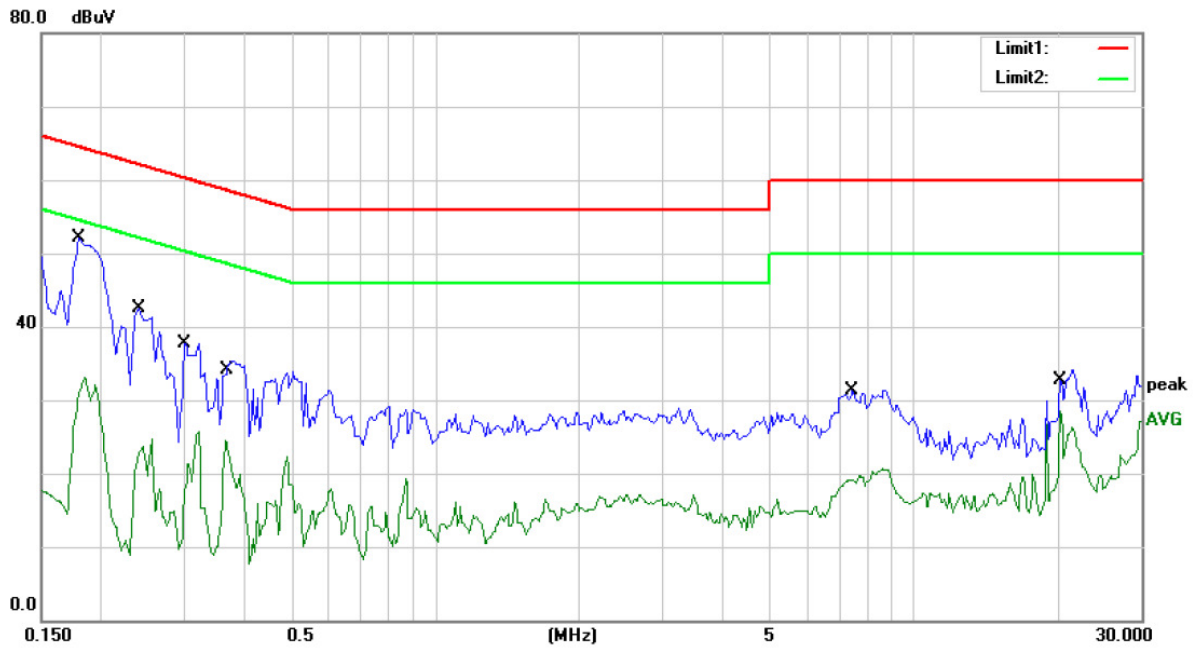

Site Conduction #1

Phase: **N**

Temperature: 22

Limit: (CE)FCC PART 15 class B_QP

Power: AC 120V/60Hz

Humidity: 50 %

Mode: HDMI IN

Note:

No.	Mk.	Freq. MHz	Reading Level dBuV	Correct Factor dB	Measure- ment dBuV	Limit dBuV	Over dB	Detector	Comment
1	*	0.1800	52.04	0.00	52.04	64.49	-12.45	QP	
2		0.1800	33.15	0.00	33.15	54.49	-21.34	AVG	
3		0.2400	42.54	0.00	42.54	62.10	-19.56	QP	
4		0.2400	24.76	0.00	24.76	52.10	-27.34	AVG	
5		0.3000	37.75	0.00	37.75	60.24	-22.49	QP	
6		0.3000	25.74	0.00	25.74	50.24	-24.50	AVG	
7		0.3650	35.26	0.00	35.26	58.61	-23.35	QP	
8		0.3650	24.47	0.00	24.47	48.61	-24.14	AVG	
9		7.4700	31.36	0.00	31.36	60.00	-28.64	QP	
10		7.4700	20.38	0.00	20.38	50.00	-29.62	AVG	
11		20.3500	34.17	0.00	34.17	60.00	-25.83	QP	
12		20.3500	28.50	0.00	28.50	50.00	-21.50	AVG	

*:Maximum data x:Over limit !:over margin Comment: Factor build in receiver. Operator: XY

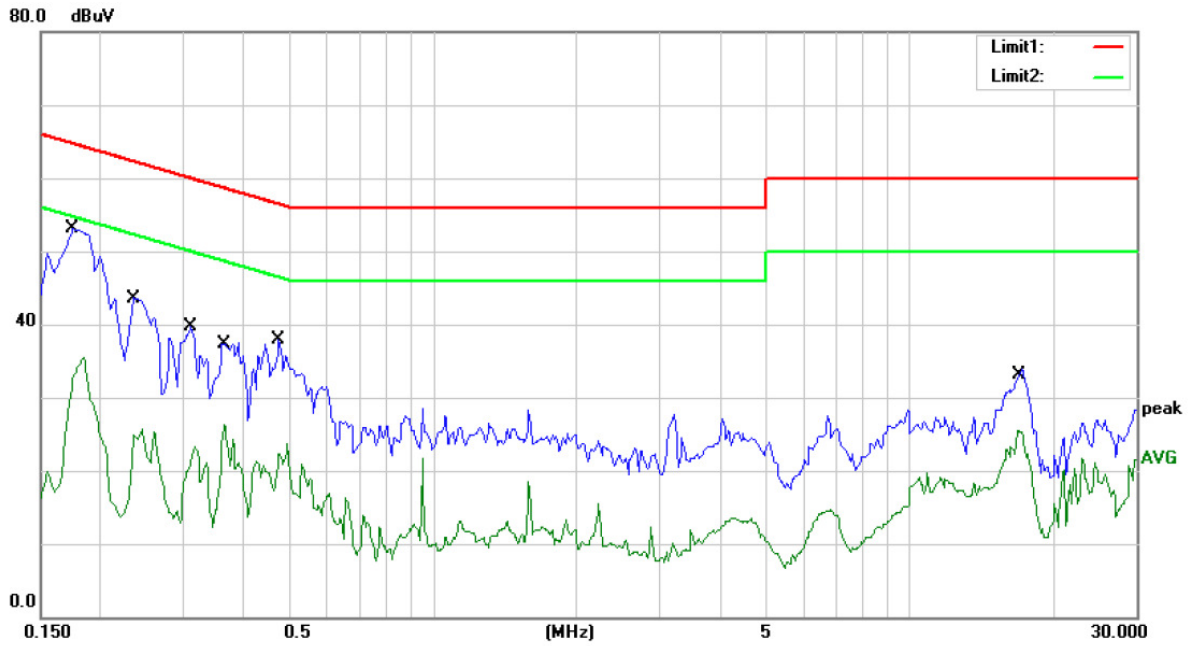

Site Conduction #1

Phase: **L1**

Temperature: 22

Limit: (CE)FCC PART 15 class B_QP

Power: AC 120V/60Hz

Humidity: 50 %

Mode: AV IN

Note:

No.	Mk.	Freq.	Reading Level	Correct Factor	Measurement	Limit	Over	Detector	Comment
		MHz	dBuV	dB	dBuV	dBuV	dB		
1	*	0.1750	53.02	0.00	53.02	64.72	-11.70	QP	
2		0.1750	35.57	0.00	35.57	54.72	-19.15	AVG	
3		0.2350	43.60	0.00	43.60	62.27	-18.67	QP	
4		0.2350	25.60	0.00	25.60	52.27	-26.67	AVG	
5		0.3100	39.62	0.00	39.62	59.97	-20.35	QP	
6		0.3100	23.32	0.00	23.32	49.97	-26.65	AVG	
7		0.3650	37.47	0.00	37.47	58.61	-21.14	QP	
8		0.3650	26.27	0.00	26.27	48.61	-22.34	AVG	
9		0.4750	37.83	0.00	37.83	56.43	-18.60	QP	
10		0.4750	23.72	0.00	23.72	46.43	-22.71	AVG	
11		16.8500	33.92	0.00	33.92	60.00	-26.08	QP	
12		16.8500	25.52	0.00	25.52	50.00	-24.48	AVG	

*:Maximum data x:Over limit !:over margin Comment: Factor build in receiver. Operator: XY

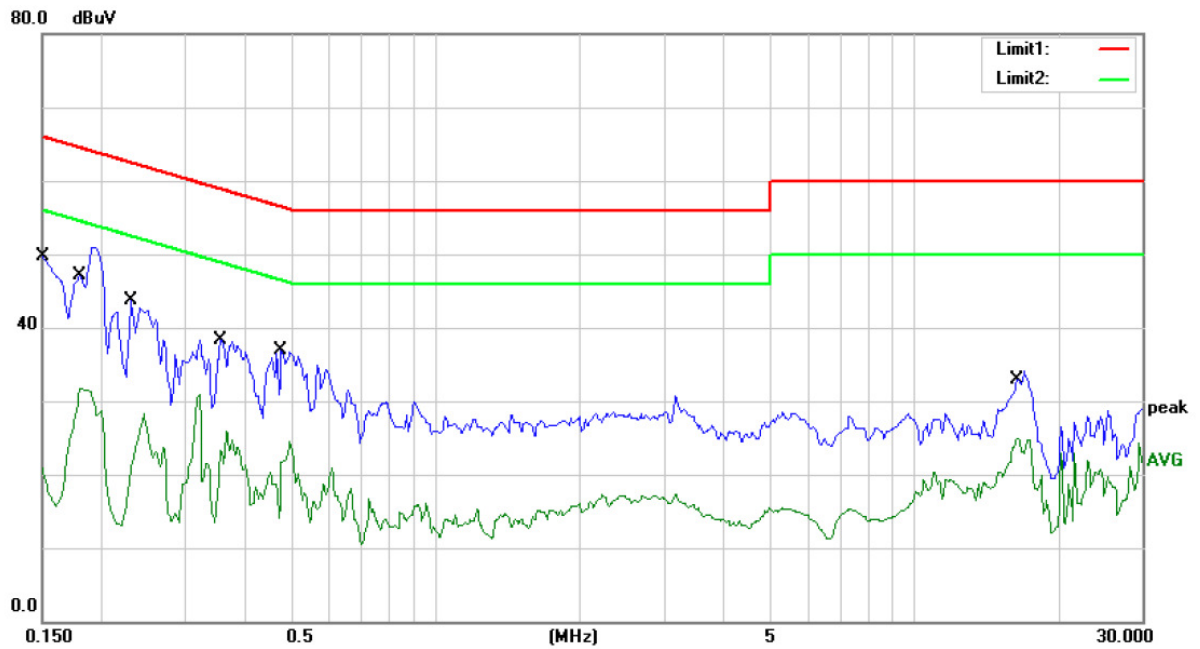

Site Conduction #1

Phase: **N**

Temperature: 22

Limit: (CE)FCC PART 15 class B_QP

Power: AC 120V/60Hz

Humidity: 50 %

Mode: AV IN

Note:

No.	Mk.	Freq.	Reading Level	Correct Factor	Measurement	Limit	Over	Detector	Comment
		MHz	dBuV	dB	dBuV	dBuV	dB		
1		0.1500	49.76	0.00	49.76	66.00	-16.24	QP	
2		0.1500	20.87	0.00	20.87	56.00	-35.13	AVG	
3	*	0.1800	50.87	0.00	50.87	64.49	-13.62	QP	
4		0.1800	31.67	0.00	31.67	54.49	-22.82	AVG	
5		0.2300	43.76	0.00	43.76	62.45	-18.69	QP	
6		0.2300	28.27	0.00	28.27	52.45	-24.18	AVG	
7		0.3550	38.32	0.00	38.32	58.84	-20.52	QP	
8		0.3550	25.89	0.00	25.89	48.84	-22.95	AVG	
9		0.4750	36.84	0.00	36.84	56.43	-19.59	QP	
10		0.4750	24.52	0.00	24.52	46.43	-21.91	AVG	
11		16.4000	34.03	0.00	34.03	60.00	-25.97	QP	
12		16.4000	24.88	0.00	24.88	50.00	-25.12	AVG	

*:Maximum data x:Over limit !:over margin Comment: Factor build in receiver. Operator: XY

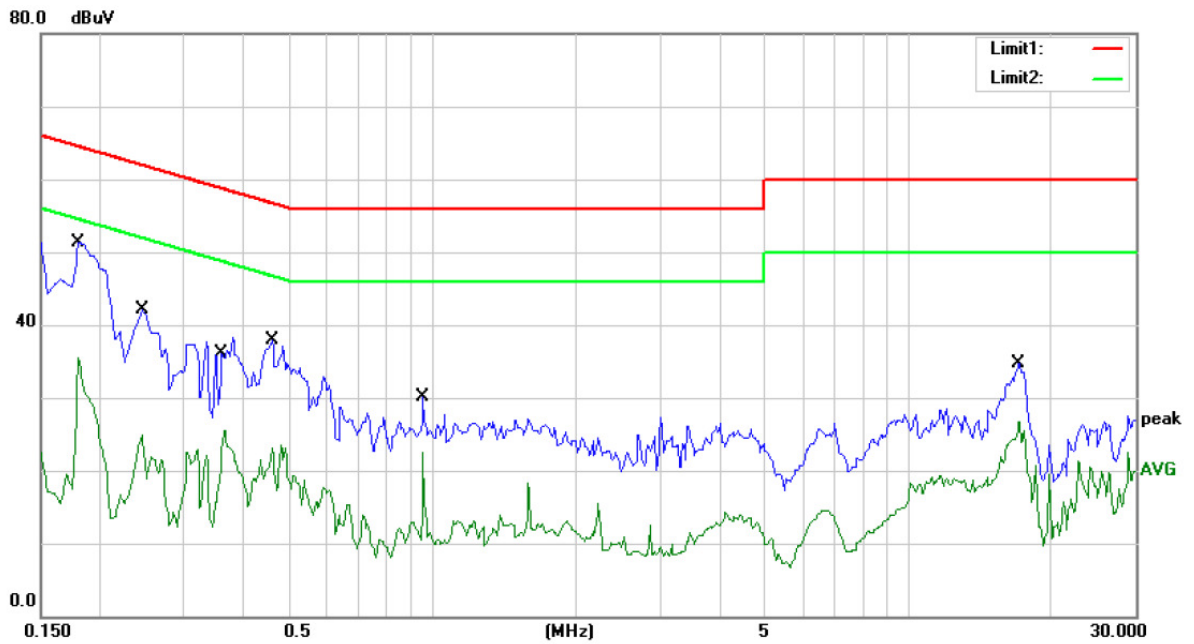

Site Conduction #1 Phase: **L1** Temperature: 22
 Limit: (CE)FCC PART 15 class B_QP Power: AC 120V/60Hz Humidity: 50 %
 Mode: USB PLAY
 Note:

No.	Mk.	Freq.	Reading Level	Correct Factor	Measurement	Limit	Over	Detector	Comment
		MHz	dBuV	dB	dBuV	dBuV	dB		
1	*	0.1800	51.30	0.00	51.30	64.49	-13.19	QP	
2		0.1800	35.51	0.00	35.51	54.49	-18.98	AVG	
3		0.2450	42.01	0.00	42.01	61.92	-19.91	QP	
4		0.2450	24.89	0.00	24.89	51.92	-27.03	AVG	
5		0.3650	38.37	0.00	38.37	58.61	-20.24	QP	
6		0.3650	25.56	0.00	25.56	48.61	-23.05	AVG	
7		0.4600	37.92	0.00	37.92	56.69	-18.77	QP	
8		0.4600	23.43	0.00	23.43	46.69	-23.26	AVG	
9		0.9550	30.07	0.00	30.07	56.00	-25.93	QP	
10		0.9550	22.41	0.00	22.41	46.00	-23.59	AVG	
11		17.1000	34.80	0.00	34.80	60.00	-25.20	QP	
12		17.1000	26.75	0.00	26.75	50.00	-23.25	AVG	

*:Maximum data x:Over limit !:over margin Comment: Factor build in receiver. Operator: XY

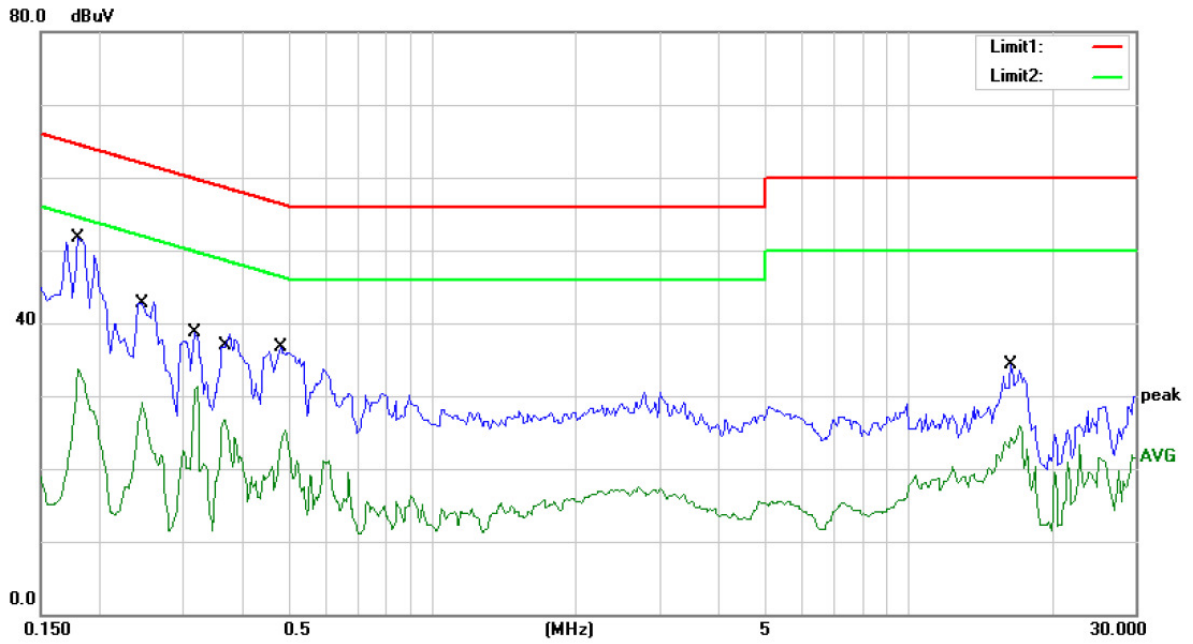

Site Conduction #1

Phase: **N**

Temperature: 22

Limit: (CE)FCC PART 15 class B_QP

Power: AC 120V/60Hz

Humidity: 50 %

Mode: USB PLAY

Note:

No.	Mk.	Freq.	Reading Level	Correct Factor	Measurement	Limit	Over	Detector	Comment
		MHz	dBuV	dB	dBuV	dBuV	dB		
1	*	0.1800	51.66	0.00	51.66	64.49	-12.83	QP	
2		0.1800	33.64	0.00	33.64	54.49	-20.85	AVG	
3		0.2450	42.93	0.00	42.93	61.92	-18.99	QP	
4		0.2450	29.07	0.00	29.07	51.92	-22.85	AVG	
5		0.3150	38.65	0.00	38.65	59.84	-21.19	QP	
6		0.3150	31.27	0.00	31.27	49.84	-18.57	AVG	
7		0.3650	38.56	0.00	38.56	58.61	-20.05	QP	
8		0.3650	26.77	0.00	26.77	48.61	-21.84	AVG	
9		0.4800	36.78	0.00	36.78	56.34	-19.56	QP	
10		0.4800	25.25	0.00	25.25	46.34	-21.09	AVG	
11		16.4000	34.33	0.00	34.33	60.00	-25.67	QP	
12		16.4000	26.00	0.00	26.00	50.00	-24.00	AVG	

*:Maximum data x:Over limit !:over margin Comment: Factor build in receiver. Operator: XY

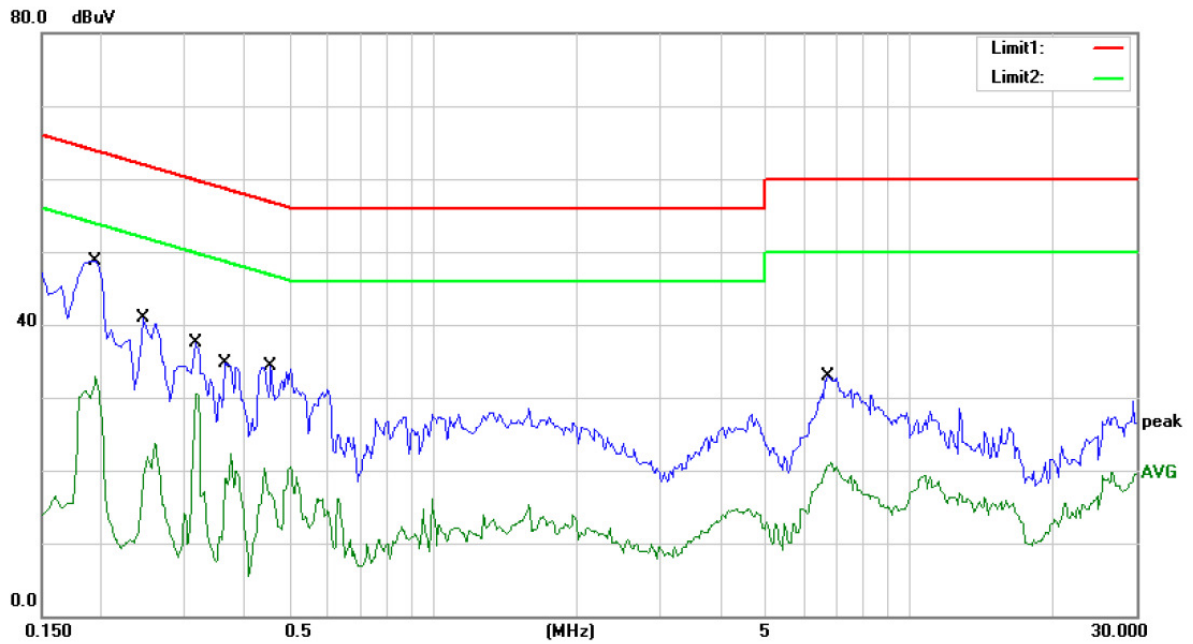

Site Conduction #1

Phase: **L1**

Temperature: 22

Limit: (CE)FCC PART 15 class B_QP

Power: AC 120V/60Hz

Humidity: 50 %

Mode: TOUCH MODE

Note:

No.	Mk.	Freq. MHz	Reading Level dBuV	Correct Factor dB	Measure- ment dBuV	Limit dBuV	Over dB	Detector	Comment
1	*	0.1950	48.79	0.00	48.79	63.82	-15.03	QP	
2		0.1950	32.83	0.00	32.83	53.82	-20.99	AVG	
3		0.2450	40.83	0.00	40.83	61.92	-21.09	QP	
4		0.2450	23.71	0.00	23.71	51.92	-28.21	AVG	
5		0.3150	37.56	0.00	37.56	59.84	-22.28	QP	
6		0.3150	30.53	0.00	30.53	49.84	-19.31	AVG	
7		0.3650	34.64	0.00	34.64	58.61	-23.97	QP	
8		0.3650	22.39	0.00	22.39	48.61	-26.22	AVG	
9		0.4550	34.32	0.00	34.32	56.78	-22.46	QP	
10		0.4550	20.55	0.00	20.55	46.78	-26.23	AVG	
11		6.7600	32.82	0.00	32.82	60.00	-27.18	QP	
12		6.7600	21.04	0.00	21.04	50.00	-28.96	AVG	

*:Maximum data x:Over limit !:over margin Comment: Factor build in receiver. Operator: XY

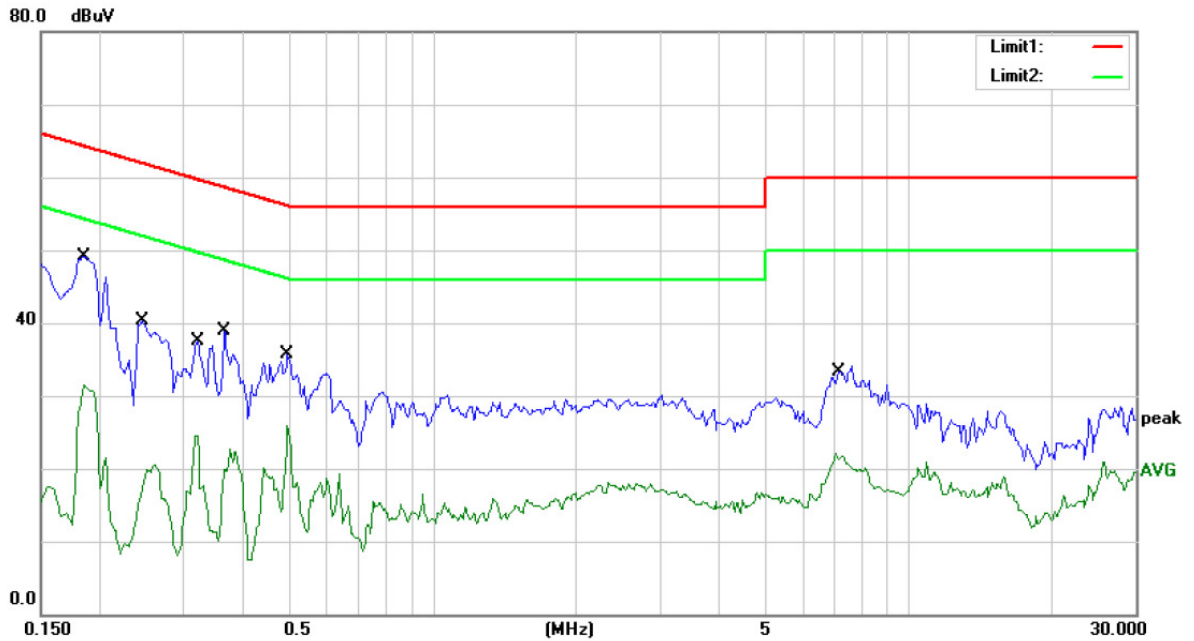

Site Conduction #1 Phase: **N** Temperature: 22
 Limit: (CE)FCC PART 15 class B_QP Power: AC 120V/60Hz Humidity: 50 %
 Mode: TOUCH MODE
 Note:

No.	Mk.	Freq.	Reading Level	Correct Factor	Measurement	Limit	Over	Detector	Comment
		MHz	dBuV	dB	dBuV	dBuV	dB		
1	*	0.1850	49.17	0.00	49.17	64.26	-15.09	QP	
2		0.1850	31.45	0.00	31.45	54.26	-22.81	AVG	
3		0.2450	40.27	0.00	40.27	61.92	-21.65	QP	
4		0.2450	20.56	0.00	20.56	51.92	-31.36	AVG	
5		0.3200	37.50	0.00	37.50	59.71	-22.21	QP	
6		0.3200	24.49	0.00	24.49	49.71	-25.22	AVG	
7		0.3650	38.81	0.00	38.81	58.61	-19.80	QP	
8		0.3650	22.70	0.00	22.70	48.61	-25.91	AVG	
9		0.4950	35.75	0.00	35.75	56.08	-20.33	QP	
10		0.4950	25.87	0.00	25.87	46.08	-20.21	AVG	
11		7.0300	34.01	0.00	34.01	60.00	-25.99	QP	
12		7.0300	22.02	0.00	22.02	50.00	-27.98	AVG	

*:Maximum data x:Over limit !:over margin Comment: Factor build in receiver. Operator: XY

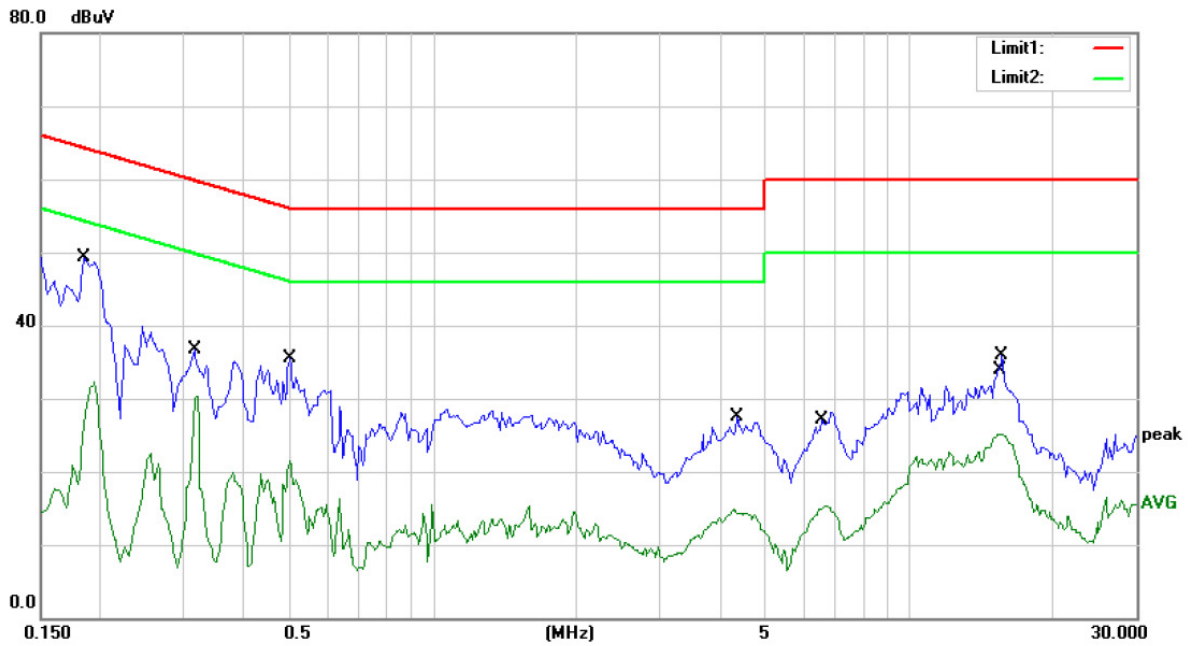

Site Conduction #1

Phase: **L1**

Temperature: 22

Limit: (CE)FCC PART 15 class B_QP

Power: AC 120V/60Hz

Humidity: 50 %

Mode: Y+Pb+Pr IN

Note:

No.	Mk.	Freq.	Reading Level	Correct Factor	Measurement	Limit	Over	Detector	Comment
		MHz	dBuV	dB	dBuV	dBuV	dB		
1	*	0.1850	49.27	0.00	49.27	64.26	-14.99	QP	
2		0.3150	36.80	0.00	36.80	59.84	-23.04	QP	
3		0.3150	30.34	0.00	30.34	49.84	-19.50	AVG	
4		0.5000	35.42	0.00	35.42	56.00	-20.58	QP	
5		0.5000	21.58	0.00	21.58	46.00	-24.42	AVG	
6		4.3050	27.42	0.00	27.42	56.00	-28.58	QP	
7		4.3050	14.95	0.00	14.95	46.00	-31.05	AVG	
8		6.6600	28.04	0.00	28.04	60.00	-31.96	QP	
9		6.6600	15.36	0.00	15.36	50.00	-34.64	AVG	
10		15.2250	32.27	0.00	32.27	50.00	-17.73	AVG	
11		15.6750	35.93	0.00	35.93	60.00	-24.07	QP	
12		15.6750	25.20	0.00	25.20	50.00	-24.80	AVG	

*:Maximum data x:Over limit !:over margin Comment: Factor build in receiver. Operator: XY

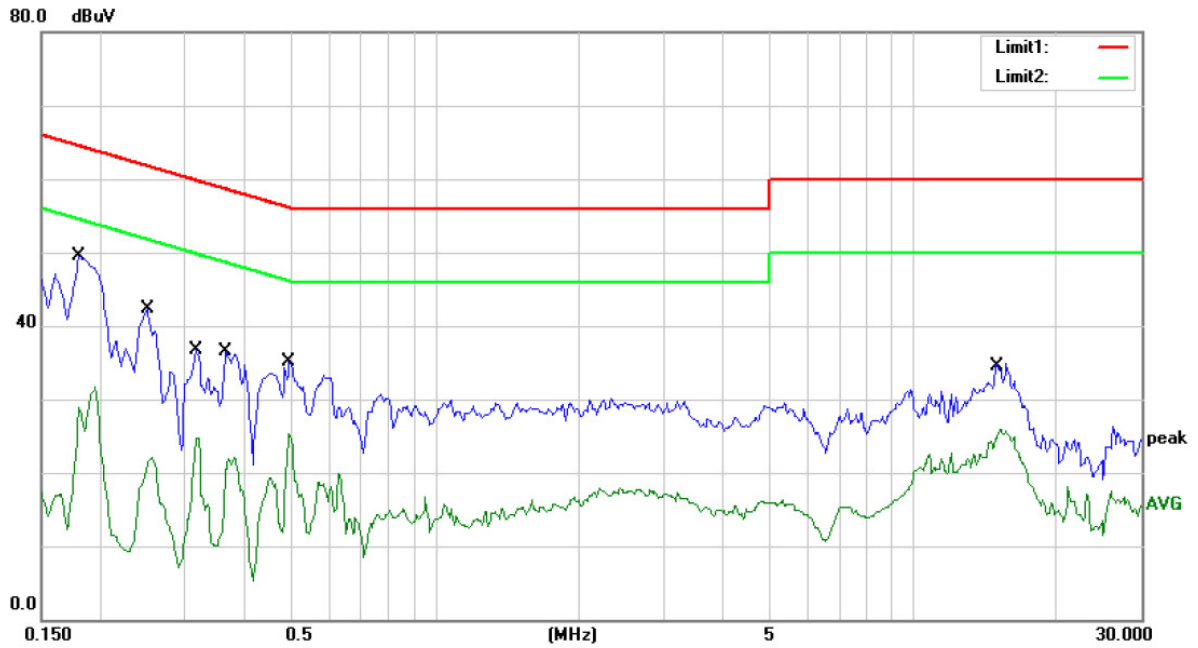

Site Conduction #1

Phase: **N**

Temperature: 22

Limit: (CE)FCC PART 15 class B_QP

Power: AC 120V/60Hz

Humidity: 50 %

Mode: Y+Pb+Pr IN

Note:

No.	Mk.	Freq.	Reading Level	Correct Factor	Measurement	Limit	Over	Detector	Comment
		MHz	dBuV	dB	dBuV	dBuV	dB		
1	*	0.1800	49.53	0.00	49.53	64.49	-14.96	QP	
2		0.1800	31.66	0.00	31.66	54.49	-22.83	AVG	
3		0.2500	42.21	0.00	42.21	61.76	-19.55	QP	
4		0.2500	22.16	0.00	22.16	51.76	-29.60	AVG	
5		0.3150	36.68	0.00	36.68	59.84	-23.16	QP	
6		0.3150	24.74	0.00	24.74	49.84	-25.10	AVG	
7		0.3650	36.44	0.00	36.44	58.61	-22.17	QP	
8		0.3650	22.12	0.00	22.12	48.61	-26.49	AVG	
9		0.4950	35.04	0.00	35.04	56.08	-21.04	QP	
10		0.4950	25.25	0.00	25.25	46.08	-20.83	AVG	
11		15.2250	34.84	0.00	34.84	60.00	-25.16	QP	
12		15.2250	25.95	0.00	25.95	50.00	-24.05	AVG	

*:Maximum data x:Over limit !:over margin Comment: Factor build in receiver. Operator: XY

5. RADIATED EMISSION MEASUREMENT

5.1. Block Diagram of Test Setup

5.1.1. Block diagram of EUT System

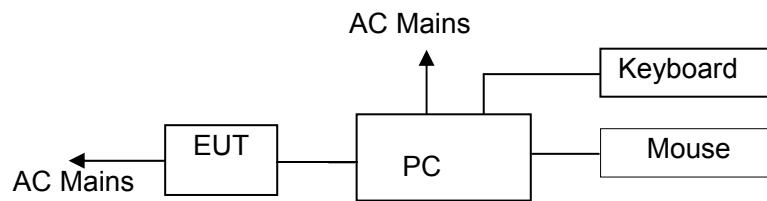

(EUT: InteractiveTouch Screen)

5.1.2. Block diagram of test setup (In chamber)

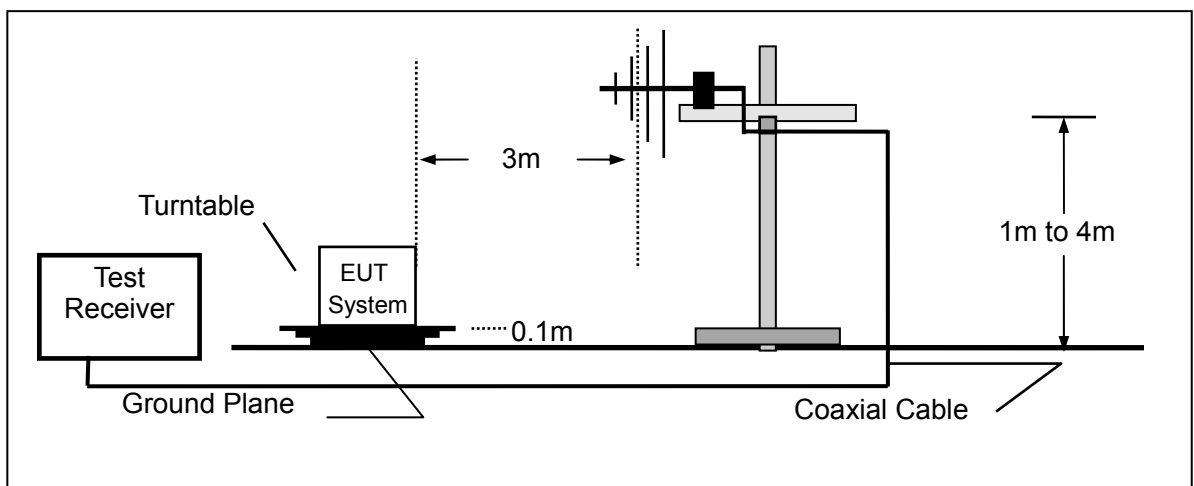

(EUT: InteractiveTouch Screen)

5.2. Measuring Standard

FCC Part 15, Subpart B, Class B ANSI C63.4: 2014

5.3. Radiated Emission Limits (Class B)

Frequency MHz	Distance (Meters)	Field Strengths Limit		
		$\mu\text{V}/\text{m}$ @3m	$\mu\text{V}/\text{m}$ @10m	$\text{dB}(\mu\text{V})/\text{m}@10\text{M}$
30 ~ 88	10	100	30	29.5
88 ~ 216	10	150	45	33.0
216 ~ 960	10	200	60	35.5
960 ~ 1000	10	500	150	43.5

Frequency (GHz)	Distance (Meters)	Field Strengths Limit	
		Average ($\text{dB}\mu\text{V}/\text{m}$)	Peak ($\text{dB}\mu\text{V}/\text{m}$)
1~6	3	54	74

Remark: (1) Emission level $(\text{dB})\mu\text{V} = 20 \log$ Emission level $\mu\text{V}/\text{m}$
 (2) $(\text{Emission level } \mu\text{V}/\text{m} @3\text{m}) / (\text{Emission level } \mu\text{V}/\text{m} @10\text{m}) = 10\text{m} / 3\text{m}$
 (3) The smaller limit shall apply at the cross point between two frequency bands.
 (4) Distance is the distance in meters between the measuring instrument, antenna and the closest point of any part of the device or system.

5.4. EUT Configuration on Measurement

The FCC Class B regulations test method must be used to find the maximum emission during radiated emission measurement.

EUT : Interactive Touch Screen
 Model Number : TT-7015E

5.5. Operating Condition of EUT

5.5.1. Setup the EUT as shown on Section 5.1.

5.5.2. Turn on the power of all equipments.

5.5.3. Let the EUT work in measuring mode (VGA, TOUCH MODE, HDMI IN, USB PLAY, AV IN, Y+Pb+Pr IN) and measure it.

5.6. Test Procedure

The EUT is placed on a turn table which is 0.8 meter high above the ground. The turn table can rotate 360 degrees to determine the position of the maximum emission level. The EUT is set 3 meters away from the receiving antenna which is mounted on an antenna tower. The antenna can be moved up and down from 1 to 4 meters to find out the maximum emission level. Bilog antenna (calibrated by Dipole Antenna) is used as a receiving antenna. Both horizontal and vertical polarization of the antenna are set on test.

The bandwidth of the Receiver (ESU26) is set at 120kHz.

All the modes were tested and the data of the worst modes are attached the following pages.

5.7. Measuring Results

PASS.

The frequency range from 30MHz to 6000MHz is investigated.

Please refer to the following pages.

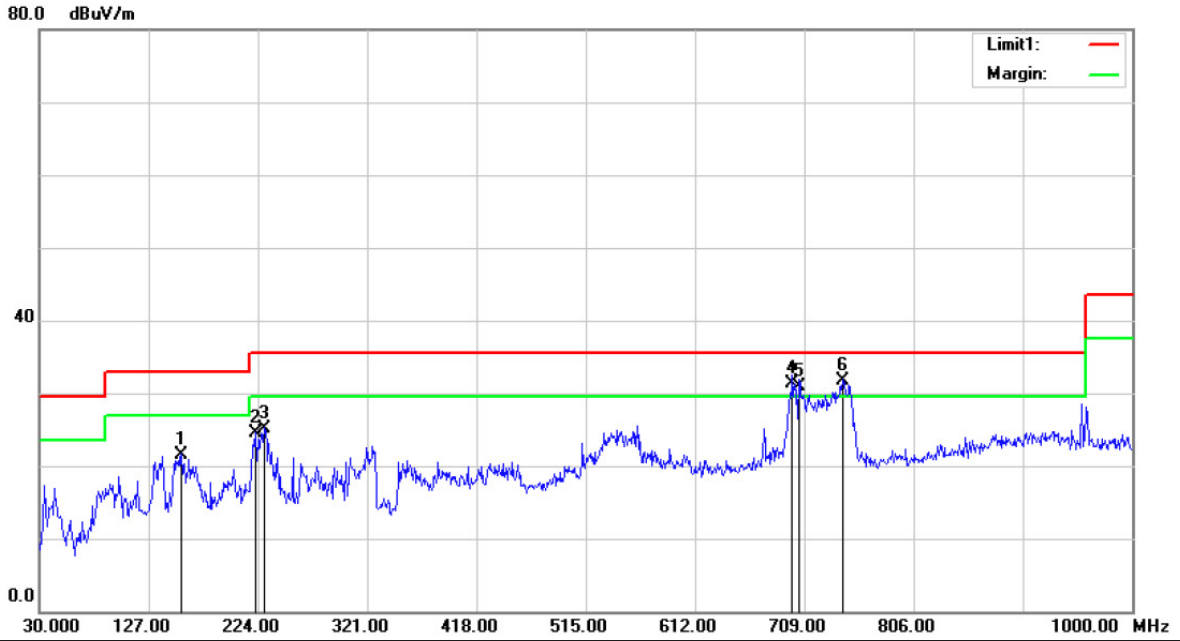

Site :10m Chamber #1 Polarization: **Horizontal** Temperature: 26
 Limit: (RE 10M)FCC 15 ClassB Power: AC 120V/60Hz Humidity: 60 %
 Mode:VGA
 Note:

No.	Mk.	Freq.	Reading Level	Correct Factor	Measurement	Limit	Over	Antenna Height	Table Degree	
		MHz	dBuV	dB	dBuV/m	dBuV/m	dB	cm	degree	Comment
1		156.1000	55.18	-33.58	21.60	33.00	-11.40	QP		
2		222.0600	54.39	-29.79	24.60	35.50	-10.90	QP		
3		229.8200	54.59	-29.39	25.20	35.50	-10.30	QP		
4	!	698.3300	49.50	-18.10	31.40	35.50	-4.10	QP		
5	!	704.1500	48.93	-18.03	30.90	35.50	-4.60	QP		
6	*	742.9500	49.53	-17.73	31.80	35.50	-3.70	QP		

*:Maximum data x:Over limit !:over margin

Operator: CSL

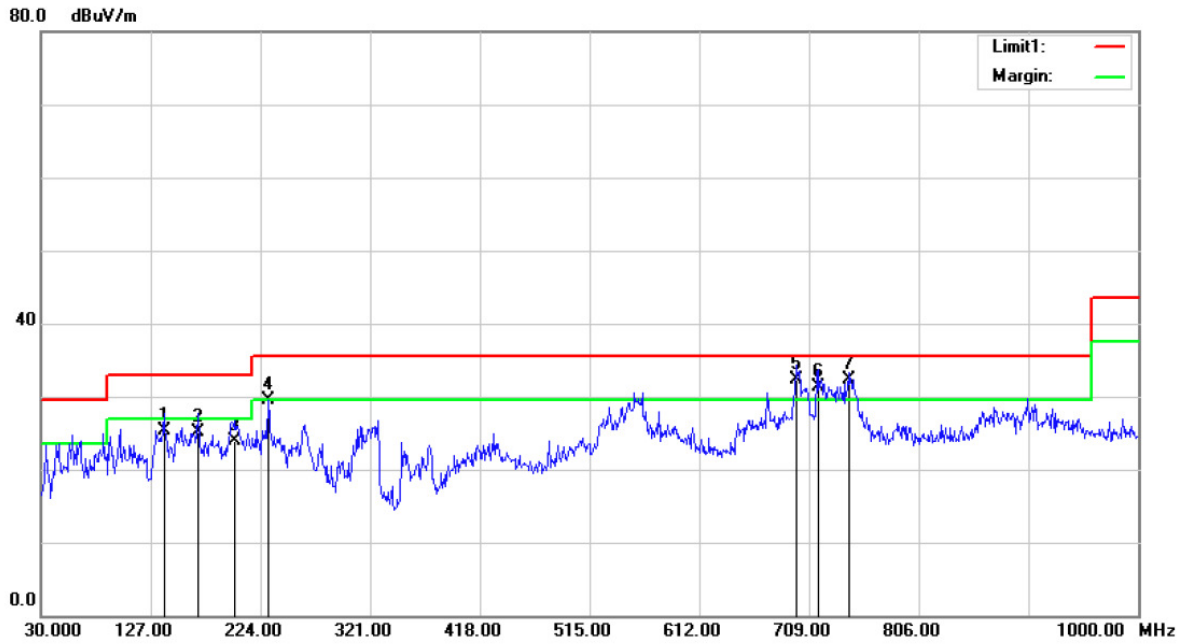

Site :10m Chamber #1 Polarization: **Vertical** Temperature: 26
 Limit: (RE 10M)FCC 15 Class B Power: AC 120V/60Hz Humidity: 60 %
 Mode:VGA
 Note:

No.	Mk.	Freq.	Reading Level	Correct Factor	Measurement	Limit	Over	Antenna Height	Table Degree	
		MHz	dBuV	dB	dBuV/m	dBuV/m	dB	cm	degree	Comment
1		138.6400	59.29	-33.89	25.40	33.00	-7.60			QP
2		168.7100	57.98	-32.78	25.20	33.00	-7.80			QP
3		201.6900	53.04	-29.14	23.90	33.00	-9.10			QP
4		230.7900	57.82	-28.37	29.45	35.50	-6.05			QP
5	*	697.3600	47.85	-15.45	32.40	35.50	-3.10			QP
6	!	716.7600	46.61	-15.31	31.30	35.50	-4.20			QP
7	!	743.9200	47.54	-15.24	32.30	35.50	-3.20			QP

*:Maximum data x:Over limit !:over margin

Operator: CSL

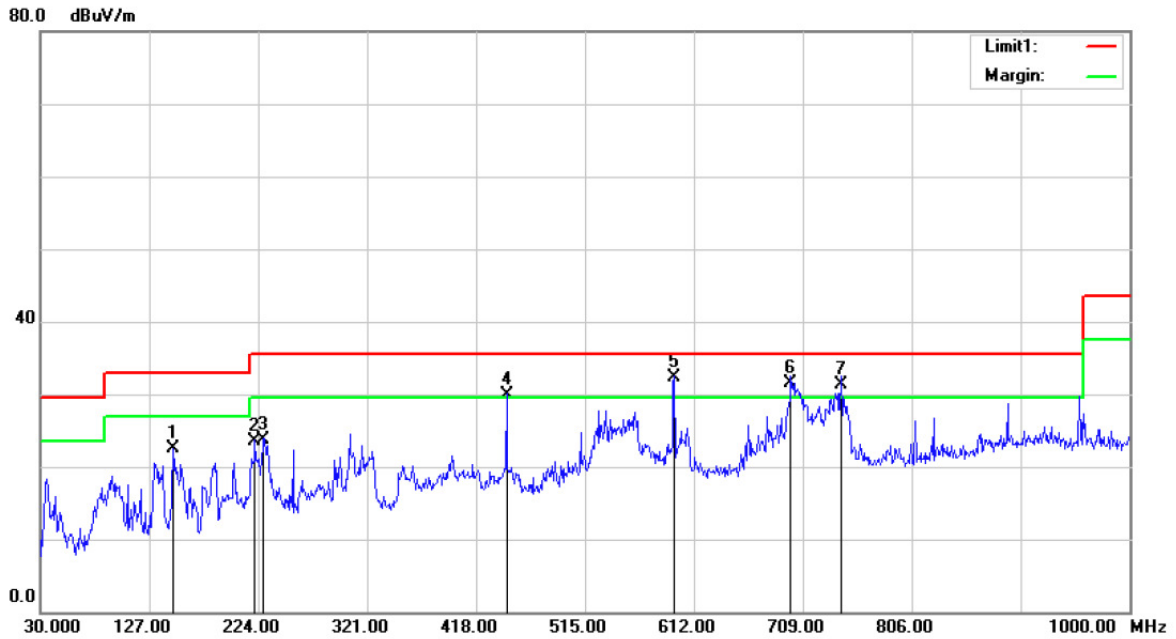

Site :10m Chamber #1 Polarization: **Horizontal** Temperature: 26
 Limit: (RE 10M)FCC 15 Class B Power: AC 120V/60Hz Humidity: 60 %
 Mode:HDMI IN
 Note:

No.	Mk.	Freq.	Reading Level	Correct Factor	Measurement	Limit	Over	Antenna Height	Table Degree	
		MHz	dBuV	dB	dBuV/m	dBuV/m	dB	cm	degree	Comment
1		148.3400	56.60	-34.00	22.60	33.00	-10.40	QP		
2		221.0900	53.43	-29.83	23.60	35.50	-11.90	QP		
3		228.8500	53.24	-29.44	23.80	35.50	-11.70	QP		
4	!	445.1600	52.87	-22.87	30.00	35.50	-5.50	QP		
5	*	594.5400	51.83	-19.53	32.30	35.50	-3.20	QP		
6	!	698.3300	49.60	-18.10	31.50	35.50	-4.00	QP		
7	!	742.9500	49.13	-17.73	31.40	35.50	-4.10	QP		

*:Maximum data x:Over limit !:over margin

Operator: CSL

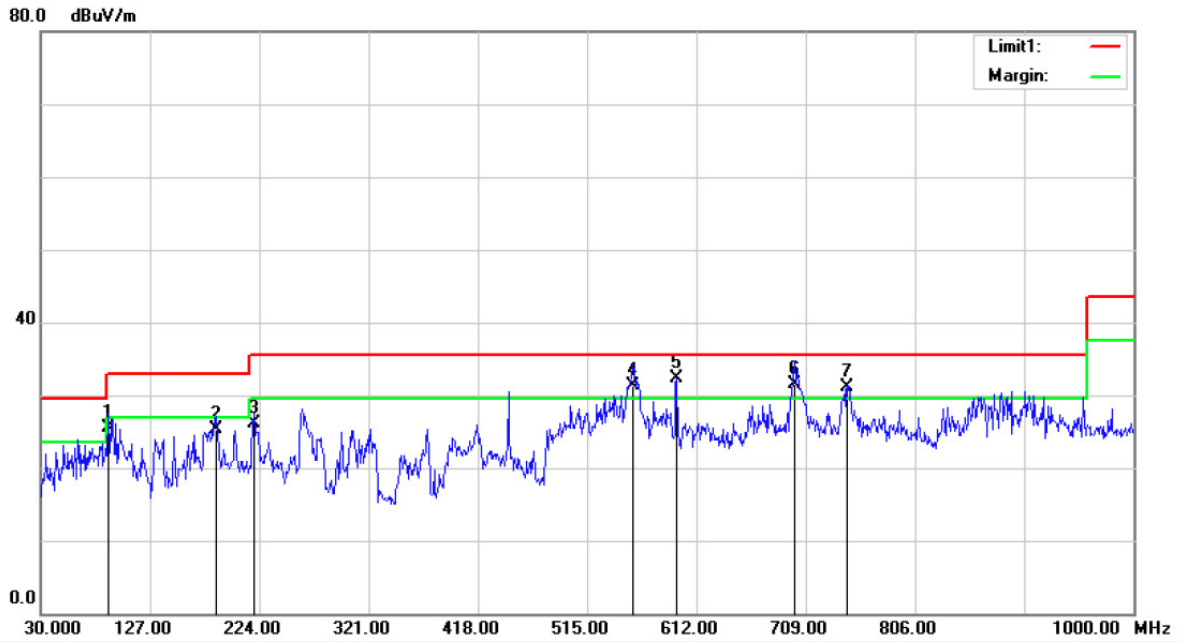

Site :10m Chamber #1 Polarization: **Vertical** Temperature: 26
 Limit: (RE 10M)FCC 15 ClassB Power: AC 120V/60Hz Humidity: 60 %
 Mode:HDMI IN
 Note:

No.	Mk.	Freq. MHz	Reading Level dBuV	Correct Factor dB	Measure- ment dBuV/m	Limit dBuV/m	Over dB	Antenna Height cm	Table Degree	Comment
1		90.1400	56.93	-31.43	25.50	33.00	-7.50	QP		
2		185.2000	56.73	-31.33	25.40	33.00	-7.60	QP		
3		219.1500	54.82	-28.72	26.10	35.50	-9.40	QP		
4	!	555.7400	50.01	-18.71	31.30	35.50	-4.20	QP		
5	*	594.5400	50.38	-18.08	32.30	35.50	-3.20	QP		
6	!	699.3000	46.99	-15.39	31.60	35.50	-3.90	QP		
7	!	745.8600	46.42	-15.22	31.20	35.50	-4.30	QP		

*:Maximum data x:Over limit !:over margin

Operator: CSL

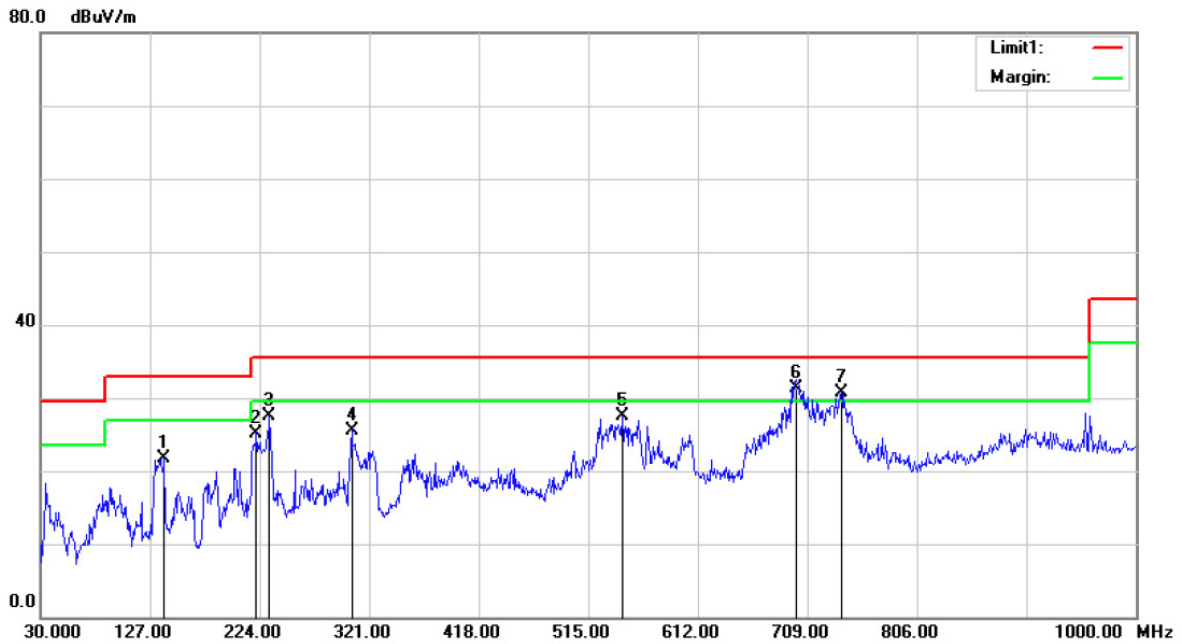

Site :10m Chamber #1 Polarization: **Horizontal** Temperature: 26
 Limit: (RE 10M)FCC 15 ClassB Power: AC 120V/60Hz Humidity: 60 %
 Mode:Touch Mode
 Note:

No.	Mk.	Freq. MHz	Reading Level dBuV	Correct Factor dB	Measure- ment dBuV/m	Limit dBuV/m	Over dB	Detector	Antenna Height cm	Table Degree degree	Comment
1		139.6100	56.23	-34.43	21.80	33.00	-11.20	QP			
2		221.0900	55.03	-29.83	25.20	35.50	-10.30	QP			
3		232.7300	56.84	-29.24	27.60	35.50	-7.90	QP			
4		305.4800	52.29	-26.69	25.60	35.50	-9.90	QP			
5		545.0700	47.79	-20.29	27.50	35.50	-8.00	QP			
6	*	699.3000	49.48	-18.08	31.40	35.50	-4.10	QP			
7	!	739.0700	48.55	-17.75	30.80	35.50	-4.70	QP			

*:Maximum data x:Over limit !:over margin

Operator: CSL

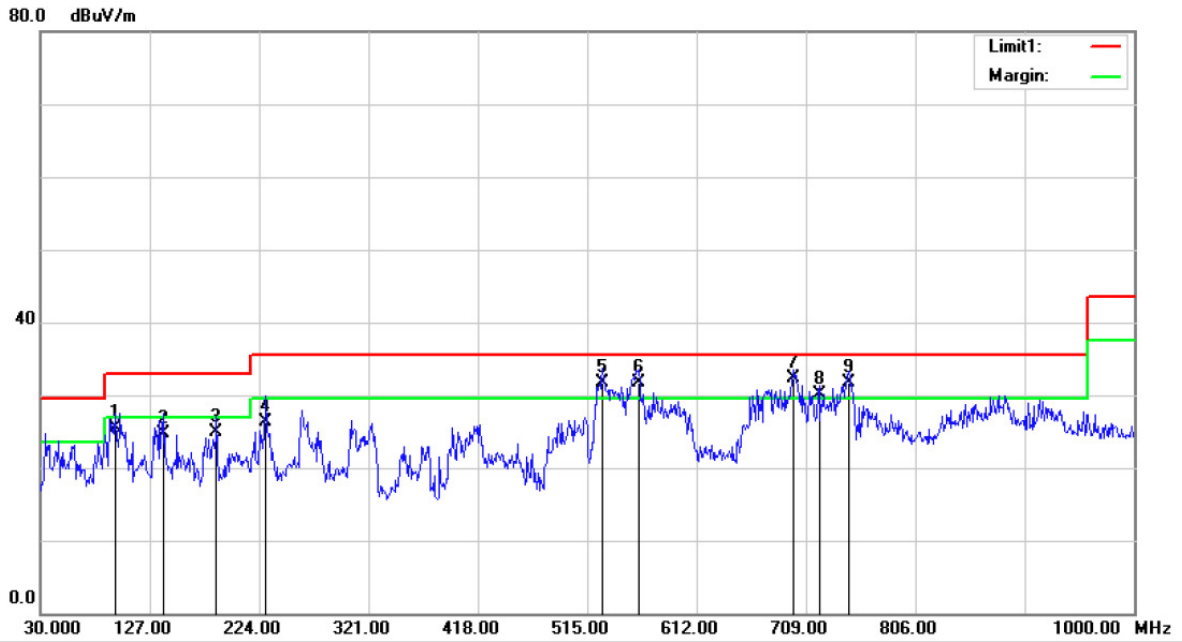

Site :10m Chamber #1 Polarization: **Vertical** Temperature: 26
 Limit: (RE 10M)FCC 15 ClassB Power: AC 120V/60Hz Humidity: 60 %
 Mode:Touch Mode
 Note:

No.	Mk.	Freq.	Reading Level	Correct Factor	Measurement	Limit	Over	Antenna Height	Table Degree	
		MHz	dBuV	dB	dBuV/m	dBuV/m	dB	cm	degree	Comment
1		95.9600	56.36	-30.76	25.60	33.00	-7.40			QP
2		139.6100	58.79	-33.99	24.80	33.00	-8.20			QP
3		186.1700	56.10	-31.20	24.90	33.00	-8.10			QP
4		229.8200	54.80	-28.40	26.40	35.50	-9.10			QP
5	!	528.5800	51.40	-19.60	31.80	35.50	-3.70			QP
6	!	560.5900	50.33	-18.63	31.70	35.50	-3.80			QP
7	*	698.3300	47.82	-15.42	32.40	35.50	-3.10			QP
8	!	720.6400	45.51	-15.31	30.20	35.50	-5.30			QP
9	!	746.8300	47.03	-15.23	31.80	35.50	-3.70			QP

*:Maximum data x:Over limit !:over margin

Operator: CSL

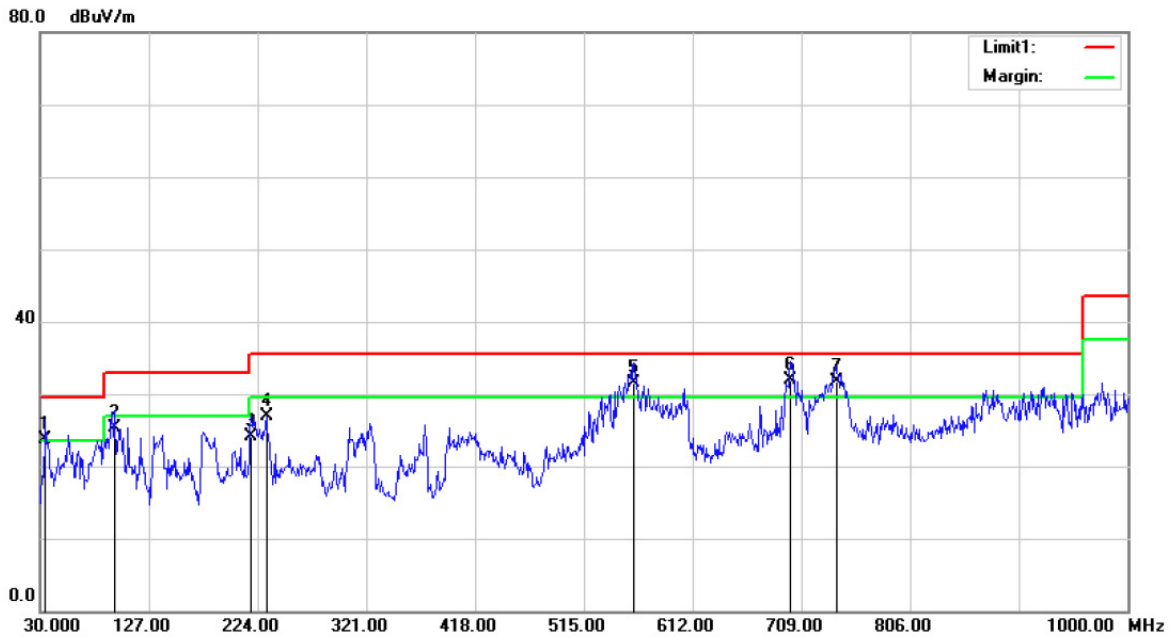

Site :10m Chamber #1 Polarization: *Vertical* Temperature: 26
 Limit: (RE 10M)FCC 15 Class B Power: AC 120V/60Hz Humidity: 60 %
 Mode:AV IN
 Note:

No.	Mk.	Freq.	Reading Level	Correct Factor	Measurement	Limit	Over	Antenna Height	Table Degree	
		MHz	dBuV	dB	dBuV/m	dBuV/m	dB	cm	degree	Comment
1	!	34.8500	54.59	-30.79	23.80	29.50	-5.70	QP		
2		95.9600	56.06	-30.76	25.30	33.00	-7.70	QP		
3		218.1800	52.96	-28.76	24.20	35.50	-11.30	QP		
4		231.7600	55.33	-28.33	27.00	35.50	-8.50	QP		
5	!	559.6200	50.25	-18.65	31.60	35.50	-3.90	QP		
6	*	699.3000	47.29	-15.39	31.90	35.50	-3.60	QP		
7	!	740.0400	47.05	-15.25	31.80	35.50	-3.70	QP		

*:Maximum data x:Over limit !:over margin

Operator: CSL

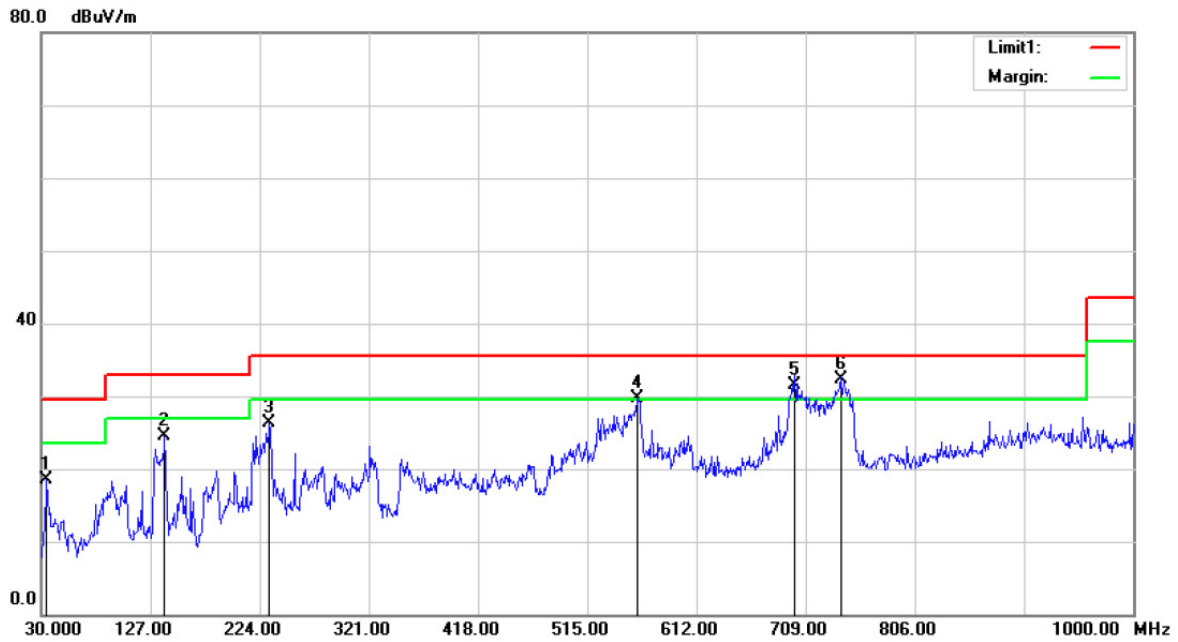

Site :10m Chamber #1 Polarization: **Horizontal** Temperature: 26
 Limit: (RE 10M)FCC 15 ClassB Power: AC 120V/60Hz Humidity: 60 %
 Mode:Y+Pb+Pr IN
 Note:

No.	Mk.	Freq. MHz	Reading Level dBuV	Correct Factor dB	Measure- ment dBuV/m	Limit dBuV/m	Over dB	Antenna Height cm	Table Degree degree	Comment
1		34.8500	49.18	-30.68	18.50	29.50	-11.00	QP		
2		139.6100	58.93	-34.43	24.50	33.00	-8.50	QP		
3		232.7300	55.54	-29.24	26.30	35.50	-9.20	QP		
4	!	559.6200	49.70	-20.00	29.70	35.50	-5.80	QP		
5	!	699.3000	49.58	-18.08	31.50	35.50	-4.00	QP		
6	*	740.0400	50.05	-17.75	32.30	35.50	-3.20	QP		

*:Maximum data x:Over limit !:over margin

Operator: CSL

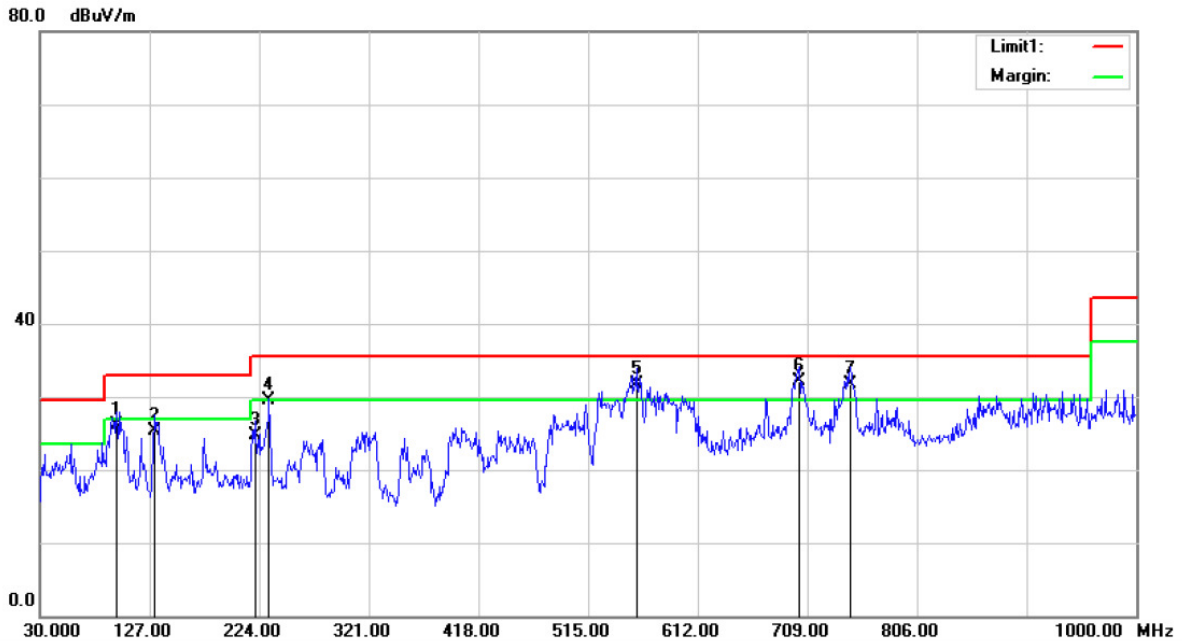

Site :10m Chamber #1 Polarization: **Vertical** Temperature: 26
 Limit: (RE 10M)FCC 15 ClassB Power: AC 120V/60Hz Humidity: 60 %
 Mode:Y+Pb+Pr IN
 Note:

No.	Mk.	Freq.	Reading Level	Correct Factor	Measurement	Limit	Over	Antenna Height	Table Degree	
		MHz	dBuV	dB	dBuV/m	dBuV/m	dB	cm	degree	Comment
1		97.9000	56.64	-30.54	26.10	33.00	-6.90	QP		
2		131.8500	58.56	-33.26	25.30	33.00	-7.70	QP		
3		220.1200	53.41	-28.71	24.70	35.50	-10.80	QP		
4	!	232.7300	57.91	-28.31	29.60	35.50	-5.90	QP		
5	!	557.6800	50.48	-18.68	31.80	35.50	-3.70	QP		
6	*	702.2100	47.47	-15.37	32.10	35.50	-3.40	QP		
7	!	746.8300	47.03	-15.23	31.80	35.50	-3.70	QP		

*:Maximum data x:Over limit !:over margin

Operator: CSL

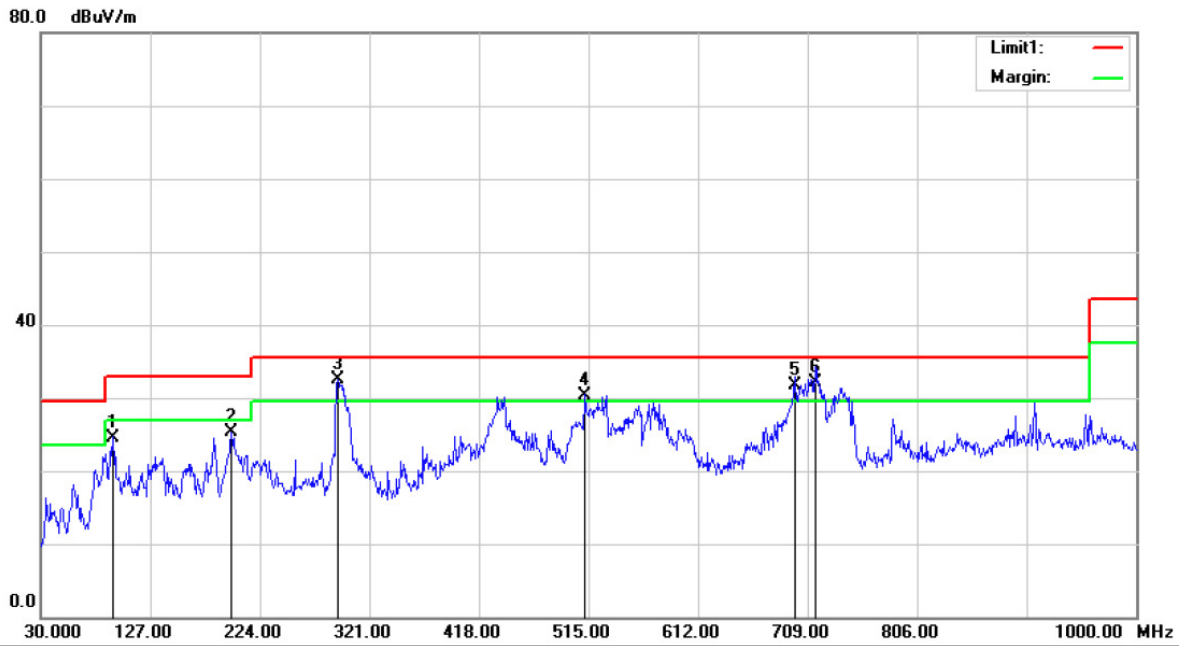

Site :10m Chamber #1 Polarization: **Horizontal** Temperature: 26
 Limit: (RE 10M)FCC 15 Class B Power: AC 120V/60Hz Humidity: 60 %
 Mode:USB Play
 Note:

No.	Mk.	Freq.	Reading Level	Correct Factor	Measurement	Limit	Over	Antenna Height	Table Degree	
		MHz	dBuV	dB	dBuV/m	dBuV/m	dB	cm	degree	Comment
1		94.0200	56.72	-32.12	24.60	33.00	-8.40	QP		
2		198.7800	56.27	-30.97	25.30	33.00	-7.70	QP		
3	*	292.8700	59.54	-27.04	32.50	35.50	-3.00	QP		
4	!	512.0900	51.83	-21.43	30.40	35.50	-5.10	QP		
5	!	697.3600	49.82	-18.12	31.70	35.50	-3.80	QP		
6	!	715.7900	50.04	-17.94	32.10	35.50	-3.40	QP		

*:Maximum data x:Over limit !:over margin

Operator: CSL

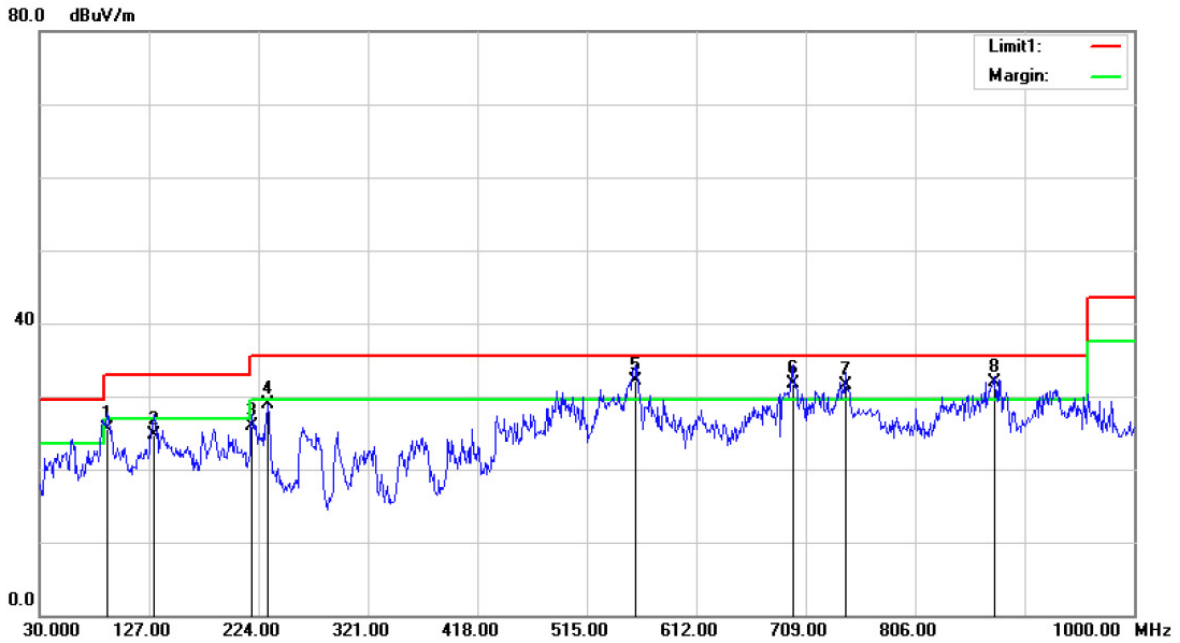

Site :10m Chamber #1 Polarization: **Vertical** Temperature: 26
 Limit: (RE 10M)FCC 15 ClassB Power: AC 120V/60Hz Humidity: 60 %
 Mode:USB Play
 Note:

No.	Mk.	Freq.	Reading Level	Correct Factor	Measurement	Limit	Over	Antenna Height	Table Degree	
		MHz	dBuV	dB	dBuV/m	dBuV/m	dB	cm	degree	Comment
1		90.1400	56.93	-31.43	25.50	33.00	-7.50			QP
2		131.8500	58.06	-33.26	24.80	33.00	-8.20			QP
3		218.1800	54.66	-28.76	25.90	35.50	-9.60			QP
4		232.7300	57.21	-28.31	28.90	35.50	-6.60			QP
5	*	557.6800	50.88	-18.68	32.20	35.50	-3.30			QP
6	!	697.3600	47.25	-15.45	31.80	35.50	-3.70			QP
7	!	743.9200	46.74	-15.24	31.50	35.50	-4.00			QP
8	!	875.8400	44.76	-12.76	32.00	35.50	-3.50			QP

*:Maximum data x:Over limit !:over margin

Operator: CSL

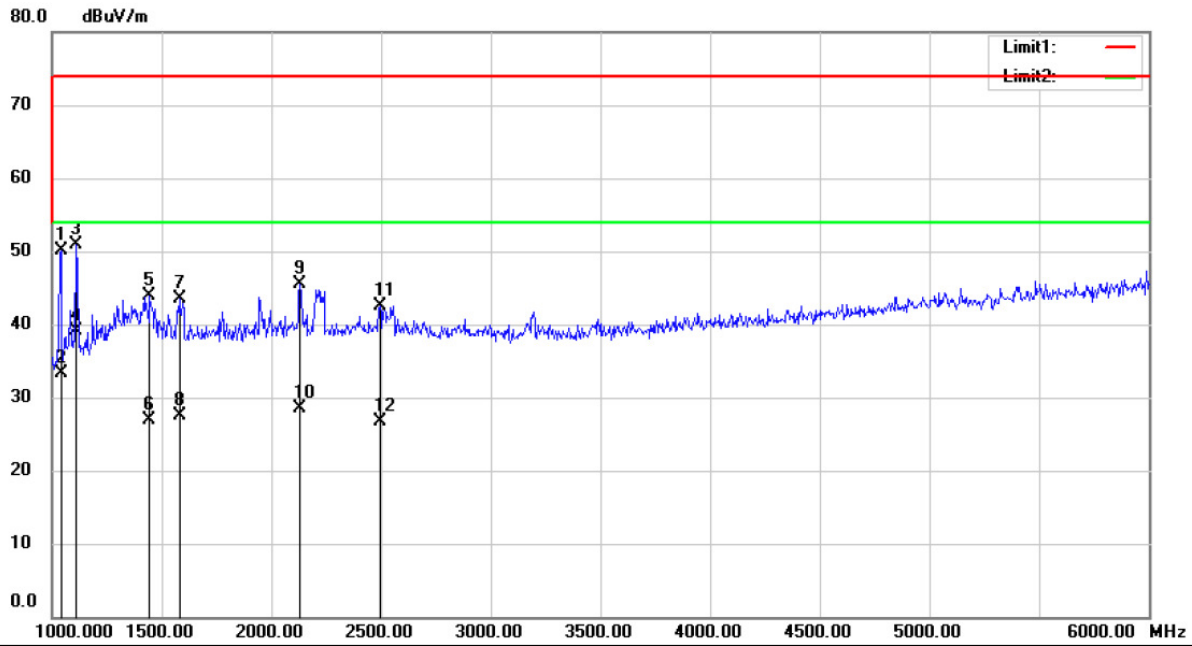

Site 3m Chamber #1

Polarization: **Horizontal**

Temperature: 24 C

Limit: (RE)FCC PART 15 CLASS B

Power: AC 120V/60Hz

Humidity: 53 %

Mode:VGA

Note:

No.	Mk.	Freq. MHz	Reading Level dBuV	Correct Factor dB	Measure- ment dBuV/m	Limit dBuV/m	Over dB	Antenna Height cm	Table Degree degree	Comment
1		1040.000	73.68	-23.57	50.11	74.00	-23.89			peak
2		1040.000	56.97	-23.57	33.40	54.00	-20.60			AVG
3		1110.000	74.46	-23.62	50.84	74.00	-23.16			peak
4	*	1110.000	62.78	-23.62	39.16	54.00	-14.84			AVG
5		1445.000	67.27	-23.29	43.98	74.00	-30.02			peak
6		1445.000	50.19	-23.29	26.90	54.00	-27.10			AVG
7		1580.000	67.06	-23.57	43.49	74.00	-30.51			peak
8		1580.000	51.07	-23.57	27.50	54.00	-26.50			AVG
9		2130.000	68.20	-22.74	45.46	74.00	-28.54			peak
10		2130.000	51.34	-22.74	28.60	54.00	-25.40			AVG
11		2495.000	64.36	-21.81	42.55	74.00	-31.45			peak
12		2495.000	48.61	-21.81	26.80	54.00	-27.20			AVG

*:Maximum data x:Over limit !:over margin

Operator: CSL

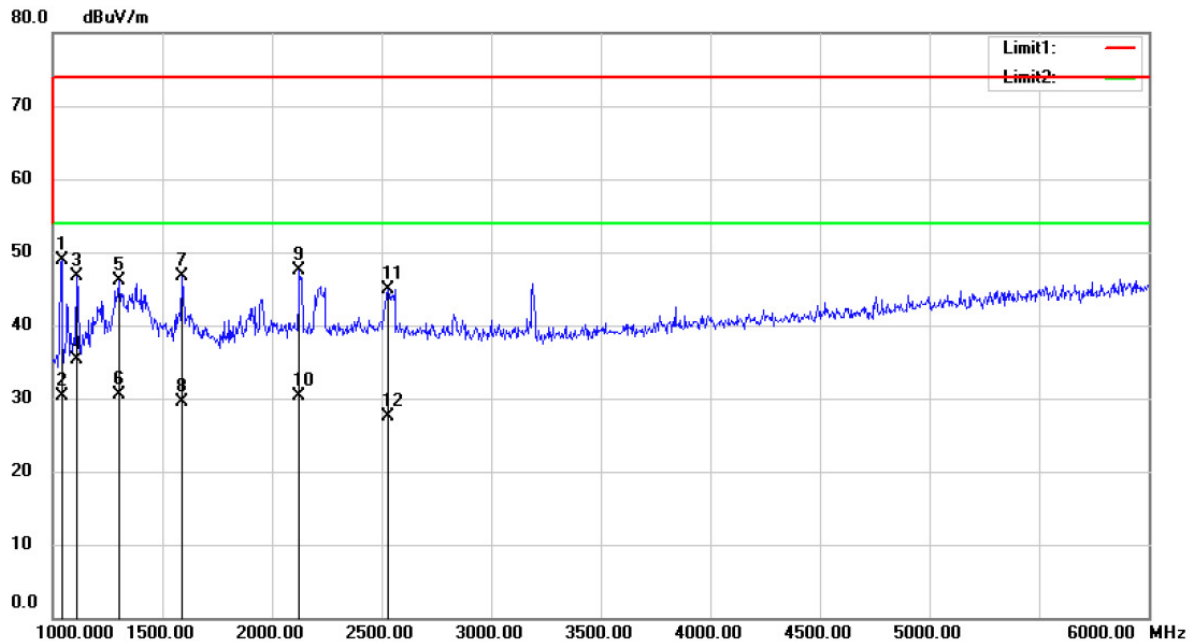

Site 3m Chamber #1 Polarization: **Vertical** Temperature: 24 C
 Limit: (RE)FCC PART 15 CLASS B Power: AC 120V/60Hz Humidity: 53 %
 Mode:VGA
 Note:

No.	Mk.	Freq.	Reading Level	Correct Factor	Measurement	Limit	Over	Antenna Height	Table Degree	
		MHz	dBuV	dB	dBuV/m	dBuV/m	dB	cm	degree	Comment
1		1040.000	72.43	-23.57	48.86	74.00	-25.14			peak
2		1040.000	53.97	-23.57	30.40	54.00	-23.60			AVG
3		1110.000	70.36	-23.62	46.74	74.00	-27.26			peak
4	*	1110.000	58.93	-23.62	35.31	54.00	-18.69			AVG
5		1300.000	69.46	-23.44	46.02	74.00	-27.98			peak
6		1300.000	53.94	-23.44	30.50	54.00	-23.50			AVG
7		1590.000	70.21	-23.60	46.61	74.00	-27.39			peak
8		1590.000	53.20	-23.60	29.60	54.00	-24.40			AVG
9		2125.000	70.20	-22.75	47.45	74.00	-26.55			peak
10		2125.000	53.15	-22.75	30.40	54.00	-23.60			AVG
11		2530.000	66.73	-21.78	44.95	74.00	-29.05			peak
12		2530.000	49.28	-21.78	27.50	54.00	-26.50			AVG

*:Maximum data x:Over limit !:over margin

Operator: CSL

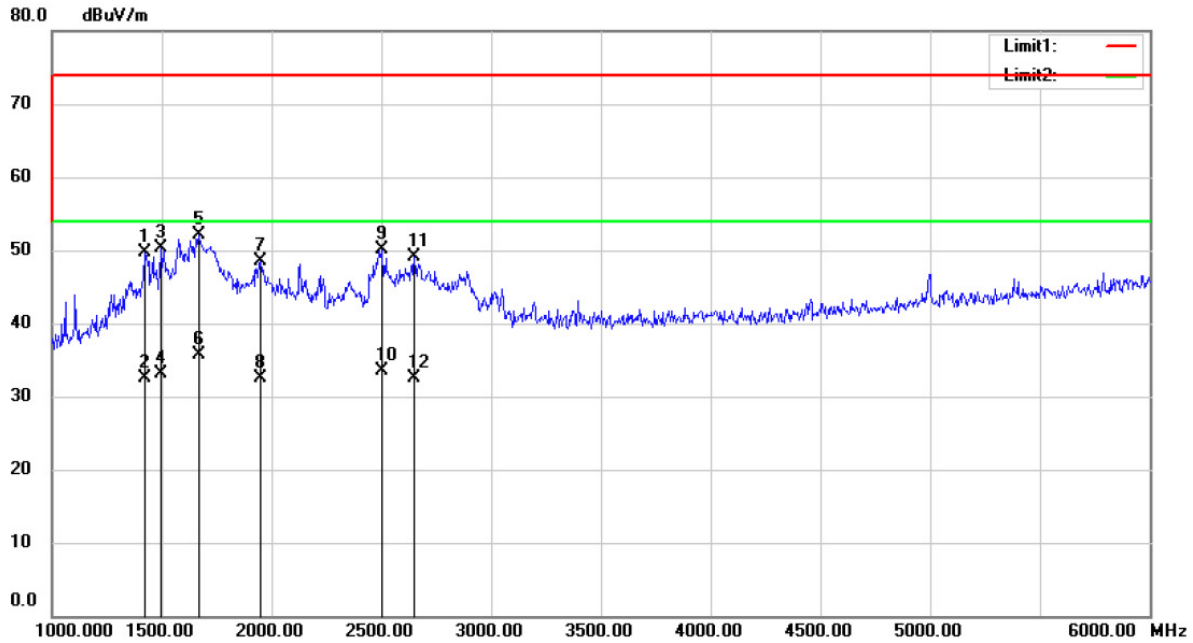

Site 3m Chamber #1 Polarization: **Horizontal** Temperature: 24 C
 Limit: (RE)FCC PART 15 CLASS B Power: AC 120V/60Hz Humidity: 53 %
 Mode:HDMI IN
 Note:

No.	Mk.	Freq.	Reading Level	Correct Factor	Measurement	Limit	Over	Antenna Height	Table Degree	
		MHz	dBuV	dB	dBuV/m	dBuV/m	dB	cm	degree	Comment
1		1420.000	73.04	-23.24	49.80	74.00	-24.20			peak
2		1420.000	55.74	-23.24	32.50	54.00	-21.50			AVG
3		1495.000	73.78	-23.39	50.39	74.00	-23.61			peak
4		1495.000	56.59	-23.39	33.20	54.00	-20.80			AVG
5		1670.000	75.72	-23.66	52.06	74.00	-21.94			peak
6	*	1670.000	59.36	-23.66	35.70	54.00	-18.30			AVG
7		1950.000	71.82	-23.24	48.58	74.00	-25.42			peak
8		1950.000	55.74	-23.24	32.50	54.00	-21.50			AVG
9		2500.000	71.86	-21.80	50.06	74.00	-23.94			peak
10		2500.000	55.40	-21.80	33.60	54.00	-20.40			AVG
11		2650.000	70.88	-21.74	49.14	74.00	-24.86			peak
12		2650.000	54.24	-21.74	32.50	54.00	-21.50			AVG

*:Maximum data x:Over limit !:over margin

Operator: CSL

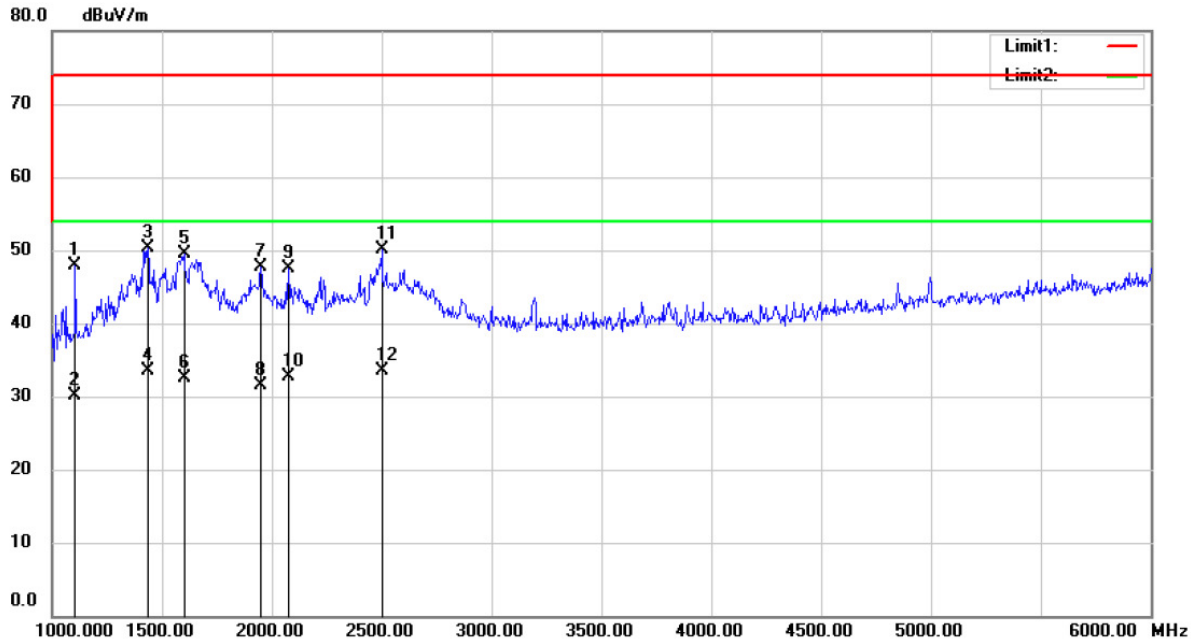

Site 3m Chamber #1

Polarization: **Vertical**

Temperature: 24 C

Limit: (RE)FCC PART 15 CLASS B

Power: AC 120V/60Hz

Humidity: 53 %

Mode:HDMI IN

Note:

No.	Mk.	Freq.	Reading Level	Correct Factor	Measurement	Limit	Over	Antenna Height	Table Degree	
		MHz	dBuV	dB	dBuV/m	dBuV/m	dB	cm	degree	Comment
1		1105.000	71.59	-23.62	47.97	74.00	-26.03			peak
2		1105.000	53.82	-23.62	30.20	54.00	-23.80			AVG
3		1435.000	73.61	-23.26	50.35	74.00	-23.65			peak
4	*	1435.000	56.76	-23.26	33.50	54.00	-20.50			AVG
5		1600.000	73.04	-23.62	49.42	74.00	-24.58			peak
6		1600.000	56.12	-23.62	32.50	54.00	-21.50			AVG
7		1950.000	70.87	-23.24	47.63	74.00	-26.37			peak
8		1950.000	54.74	-23.24	31.50	54.00	-22.50			AVG
9		2075.000	70.32	-22.87	47.45	74.00	-26.55			peak
10		2075.000	55.67	-22.87	32.80	54.00	-21.20			AVG
11		2500.000	71.86	-21.80	50.06	74.00	-23.94			peak
12		2500.000	55.30	-21.80	33.50	54.00	-20.50			AVG

*:Maximum data x:Over limit !:over margin

Operator: CSL

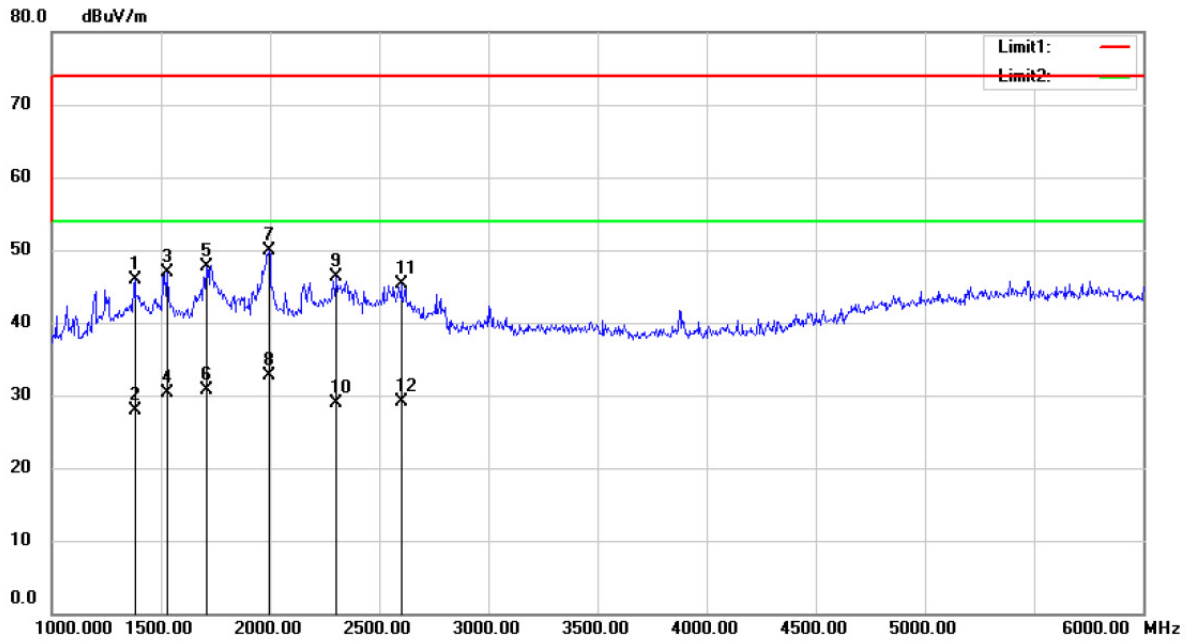

Site 3m Chamber #1

Polarization: **Horizontal**

Temperature: 24 C

Limit: (RE)FCC PART 15 CLASS B

Power: AC 120V/60Hz

Humidity: 53 %

Mode: USB PLAY

Note:

No.	Mk.	Freq.	Reading Level	Correct Factor	Measurement	Limit	Over	Antenna Height	Table Degree	
		MHz	dBuV	dB	dBuV/m	dBuV/m	dB	cm	degree	Comment
1		1380.000	69.13	-23.24	45.89	74.00	-28.11			peak
2		1380.000	51.10	-23.24	27.86	54.00	-26.14			AVG
3		1530.000	70.32	-23.47	46.85	74.00	-27.15			peak
4		1530.000	53.86	-23.47	30.39	54.00	-23.61			AVG
5		1710.000	71.45	-23.69	47.76	74.00	-26.24			peak
6		1710.000	54.48	-23.69	30.79	54.00	-23.21			AVG
7		1995.000	73.01	-23.07	49.94	74.00	-24.06			peak
8	*	1995.000	55.68	-23.07	32.61	54.00	-21.39			AVG
9		2305.000	68.52	-22.29	46.23	74.00	-27.77			peak
10		2305.000	51.16	-22.29	28.87	54.00	-25.13			AVG
11		2600.000	67.09	-21.76	45.33	74.00	-28.67			peak
12		2600.000	50.81	-21.76	29.05	54.00	-24.95			AVG

*:Maximum data x:Over limit !:over margin

Operator: CSL

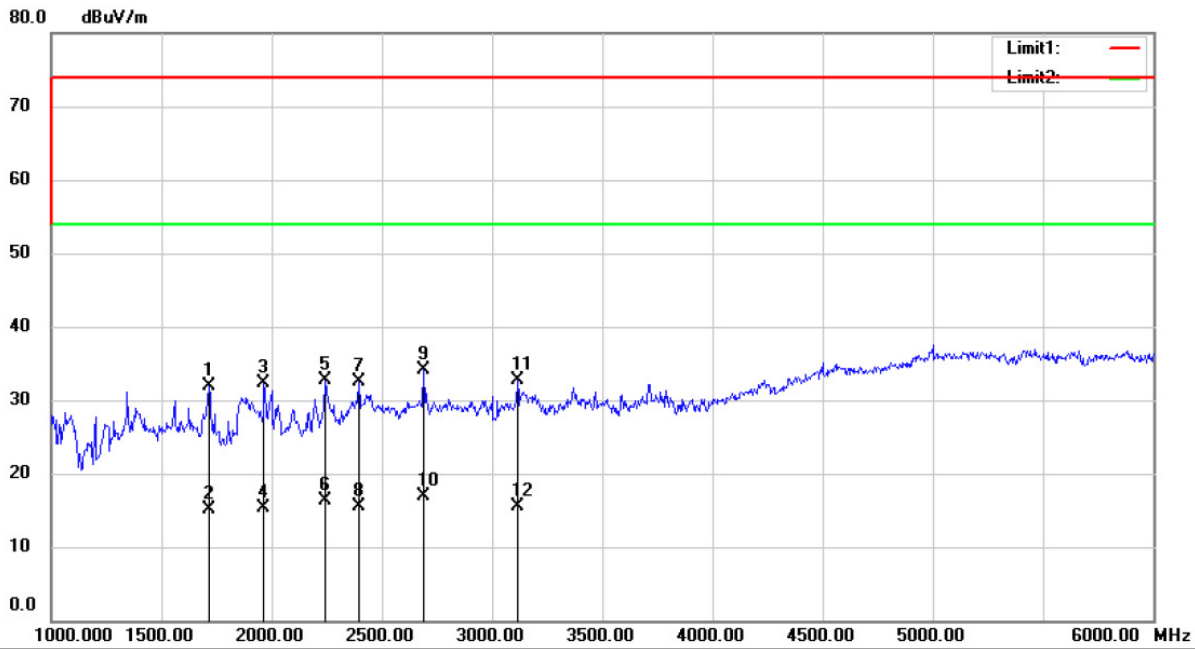

Site 3m Chamber #1 Polarization: **Vertical** Temperature: 24 C
 Limit: (RE)FCC PART 15 CLASS B Power: AC 120V/60Hz Humidity: 53 %
 Mode:USB PLAY
 Note:

No.	Mk.	Freq.	Reading Level	Correct Factor	Measurement	Limit	Over	Antenna Height	Table Degree	
		MHz	dBuV	dB	dBuV/m	dBuV/m	dB	cm	degree	Comment
1		1715.000	55.69	-23.69	32.00	74.00	-42.00			peak
2		1715.000	38.76	-23.69	15.07	54.00	-38.93			AVG
3		1965.000	55.40	-23.18	32.22	74.00	-41.78			peak
4		1965.000	38.41	-23.18	15.23	54.00	-38.77			AVG
5		2245.000	55.19	-22.44	32.75	74.00	-41.25			peak
6		2245.000	38.65	-22.44	16.21	54.00	-37.79			AVG
7		2395.000	54.57	-22.06	32.51	74.00	-41.49			peak
8		2395.000	37.55	-22.06	15.49	54.00	-38.51			AVG
9		2690.000	55.92	-21.73	34.19	74.00	-39.81			peak
10	*	2690.000	38.66	-21.73	16.93	54.00	-37.07			AVG
11		3115.000	54.06	-21.38	32.68	74.00	-41.32			peak
12		3115.000	36.87	-21.38	15.49	54.00	-38.51			AVG

*:Maximum data x:Over limit !:over margin

Operator: CSL

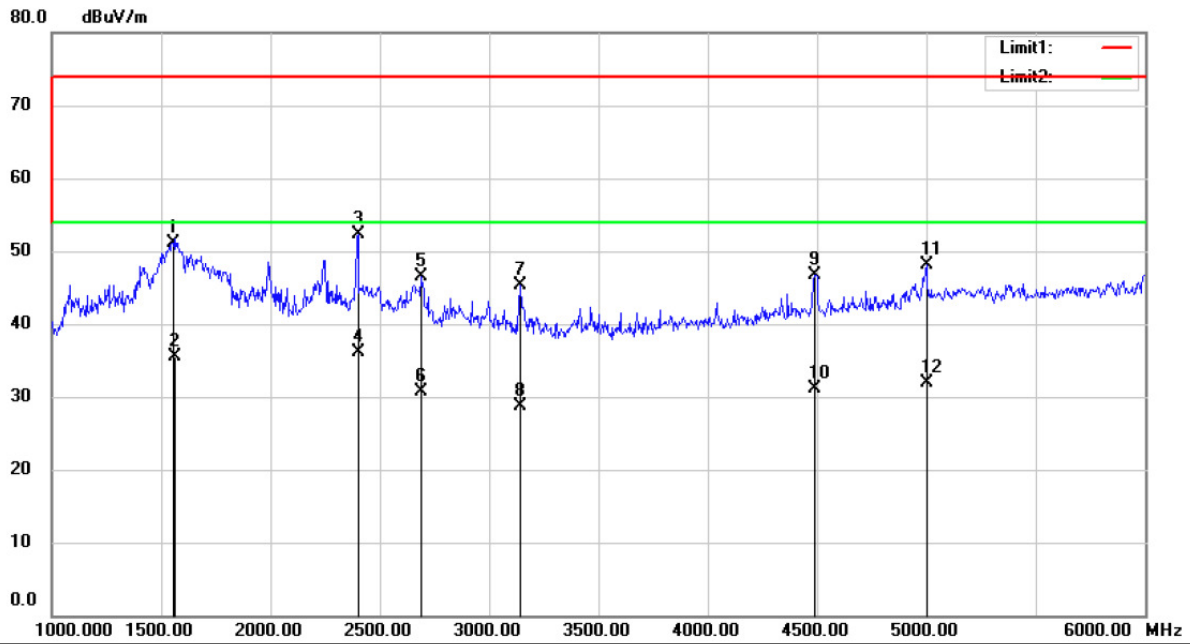

Site 3m Chamber #1 Polarization: **Horizontal** Temperature: 24 C
 Limit: (RE)FCC PART 15 CLASS B Power: AC 120V/60Hz Humidity: 53 %
 Mode:Y+Pb+Pr in
 Note:

No.	Mk.	Freq.	Reading Level	Correct Factor	Measurement	Limit	Over	Antenna Height	Table Degree	
		MHz	dBuV	dB	dBuV/m	dBuV/m	dB	cm	degree	Comment
1		1555.000	74.70	-23.52	51.18	74.00	-22.82			peak
2		1565.000	59.03	-23.55	35.48	54.00	-18.52			AVG
3		2400.000	74.42	-22.05	52.37	74.00	-21.63			peak
4	*	2400.000	58.09	-22.05	36.04	54.00	-17.96			AVG
5		2690.000	68.16	-21.73	46.43	74.00	-27.57			peak
6		2690.000	52.43	-21.73	30.70	54.00	-23.30			AVG
7		3145.000	66.57	-21.31	45.26	74.00	-28.74			peak
8		3145.000	49.98	-21.31	28.67	54.00	-25.33			AVG
9		4490.000	63.76	-17.05	46.71	74.00	-27.29			peak
10		4490.000	48.11	-17.05	31.06	54.00	-22.94			AVG
11		5000.000	63.53	-15.36	48.17	74.00	-25.83			peak
12		5000.000	47.32	-15.36	31.96	54.00	-22.04			AVG

*:Maximum data x:Over limit !:over margin

Operator: CSL

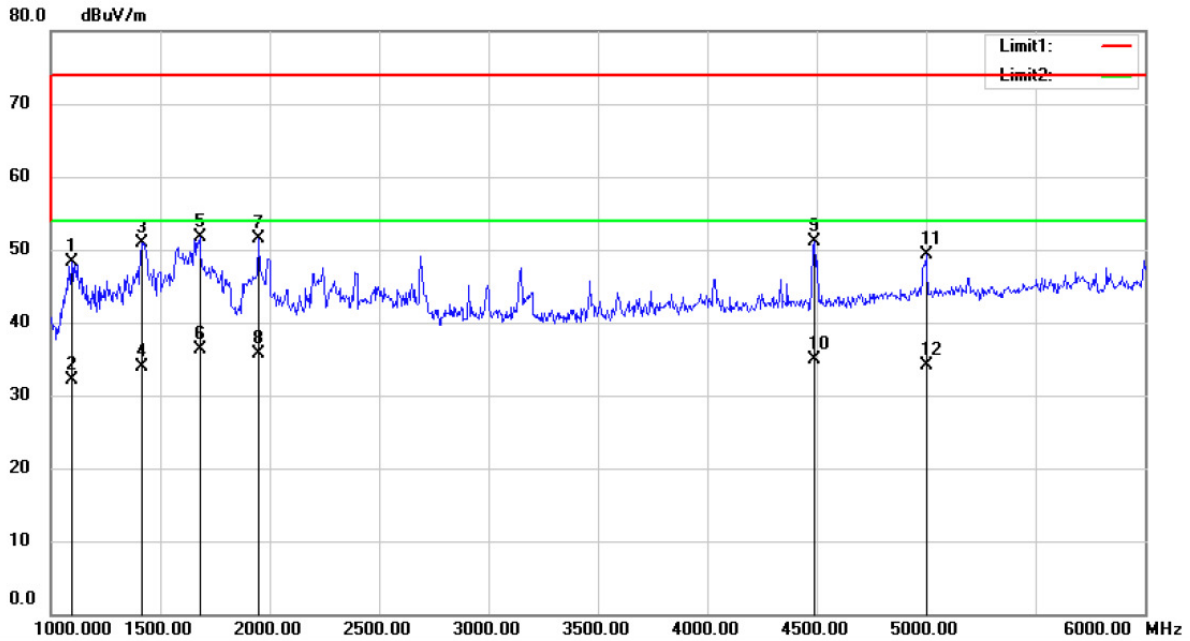

Site 3m Chamber #1

Polarization: **Vertical**

Temperature: 24 C

Limit: (RE)FCC PART 15 CLASS B

Power: AC 120V/60Hz

Humidity: 53 %

Mode: Y+Pb+Pr in

Note:

No.	Mk.	Freq.	Reading Level	Correct Factor	Measurement	Limit	Over	Antenna Height	Table Degree	
		MHz	dBuV	dB	dBuV/m	dBuV/m	dB	cm	degree	Comment
1		1095.000	71.93	-23.60	48.33	74.00	-25.67			peak
2		1095.000	55.77	-23.60	32.17	54.00	-21.83			AVG
3		1415.000	74.20	-23.22	50.98	74.00	-23.02			peak
4		1415.000	57.18	-23.22	33.96	54.00	-20.04			AVG
5		1680.000	75.31	-23.66	51.65	74.00	-22.35			peak
6	*	1680.000	59.87	-23.66	36.21	54.00	-17.79			AVG
7		1950.000	74.82	-23.24	51.58	74.00	-22.42			peak
8		1950.000	58.90	-23.24	35.66	54.00	-18.34			AVG
9		4490.000	68.23	-17.05	51.18	74.00	-22.82			peak
10		4490.000	52.01	-17.05	34.96	54.00	-19.04			AVG
11		5000.000	64.60	-15.36	49.24	74.00	-24.76			peak
12		5000.000	49.42	-15.36	34.06	54.00	-19.94			AVG

*:Maximum data x:Over limit !:over margin

Operator: CSL

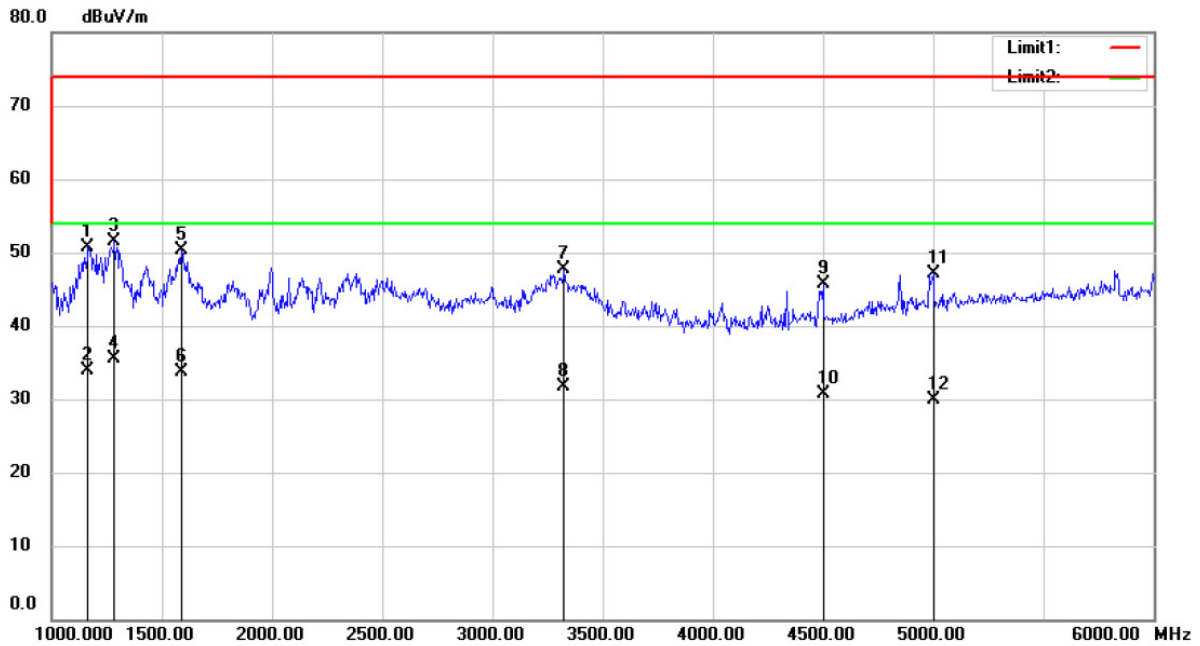

Site 3m Chamber #1

Polarization: **Horizontal**

Temperature: 24 C

Limit: (RE)FCC PART 15 CLASS B

Power: AC 120V/60Hz

Humidity: 53 %

Mode:AV IN

Note:

No.	Mk.	Freq.	Reading Level	Correct Factor	Measurement	Limit	Over	Antenna Height	Table Degree	
		MHz	dBuV	dB	dBuV/m	dBuV/m	dB	cm	degree	Comment
1		1165.000	74.26	-23.65	50.61	74.00	-23.39			peak
2		1165.000	57.51	-23.65	33.86	54.00	-20.14			AVG
3		1285.000	74.87	-23.46	51.41	74.00	-22.59			peak
4	*	1285.000	59.06	-23.46	35.60	54.00	-18.40			AVG
5		1590.000	73.97	-23.60	50.37	74.00	-23.63			peak
6		1590.000	57.25	-23.60	33.65	54.00	-20.35			AVG
7		3325.000	68.70	-20.94	47.76	74.00	-26.24			peak
8		3325.000	52.66	-20.94	31.72	54.00	-22.28			AVG
9		4500.000	62.75	-17.02	45.73	74.00	-28.27			peak
10		4500.000	47.67	-17.02	30.65	54.00	-23.35			AVG
11		5000.000	62.49	-15.36	47.13	74.00	-26.87			peak
12		5000.000	45.32	-15.36	29.96	54.00	-24.04			AVG

*:Maximum data x:Over limit !:over margin

Operator: CSL

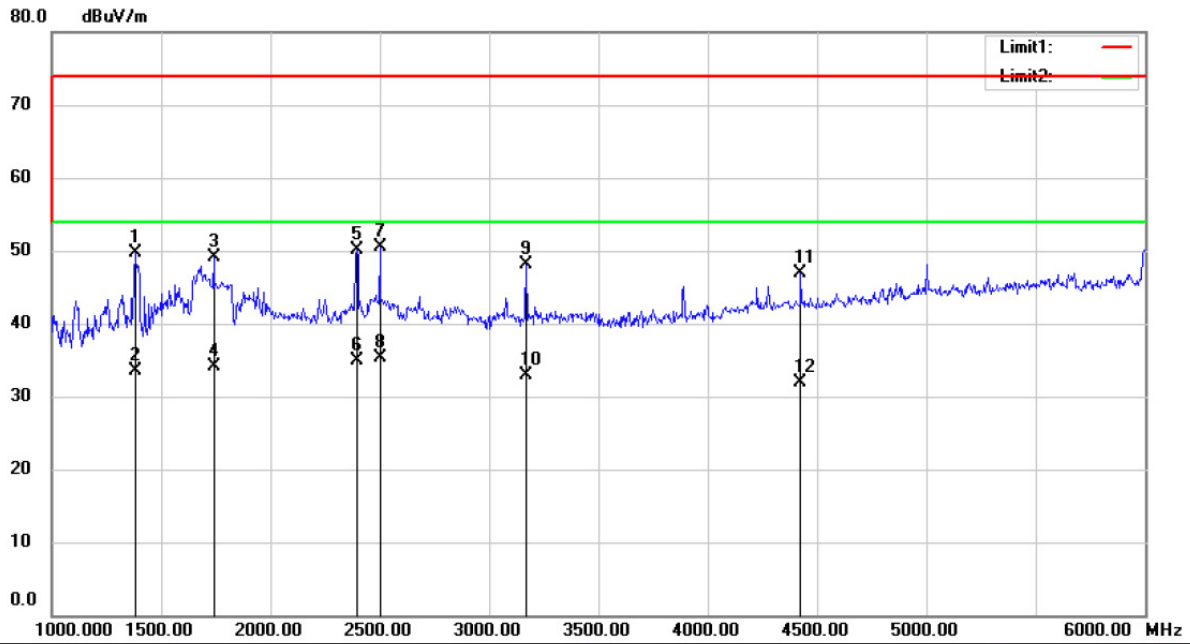

Site 3m Chamber #1 Polarization: **Horizontal** Temperature: 24 C
 Limit: (RE)FCC PART 15 CLASS B Power: AC 120V/60Hz Humidity: 53 %
 Mode: TOUCH MODE
 Note: Running with full system+VGA+DP:1920*1200,60HZ

No.	Mk.	Freq.	Reading Level	Correct Factor	Measurement	Limit	Over	Antenna Height	Table Degree	
		MHz	dBuV	dB	dBuV/m	dBuV/m	dB	cm	degree	Comment
1		1380.000	72.88	-23.24	49.64	74.00	-24.36			peak
2		1380.000	56.70	-23.24	33.46	54.00	-20.54			AVG
3		1740.000	72.75	-23.70	49.05	74.00	-24.95			peak
4		1740.000	57.89	-23.70	34.19	54.00	-19.81			AVG
5		2395.000	72.10	-22.06	50.04	74.00	-23.96			peak
6		2395.000	56.98	-22.06	34.92	54.00	-19.08			AVG
7		2500.000	72.33	-21.80	50.53	74.00	-23.47			peak
8	*	2500.000	57.03	-21.80	35.23	54.00	-18.77			AVG
9		3170.000	69.43	-21.26	48.17	74.00	-25.83			peak
10		3170.000	54.09	-21.26	32.83	54.00	-21.17			AVG
11		4425.000	64.09	-17.25	46.84	74.00	-27.16			peak
12		4425.000	49.15	-17.25	31.90	54.00	-22.10			AVG

*:Maximum data x:Over limit !:over margin

Operator: CSL

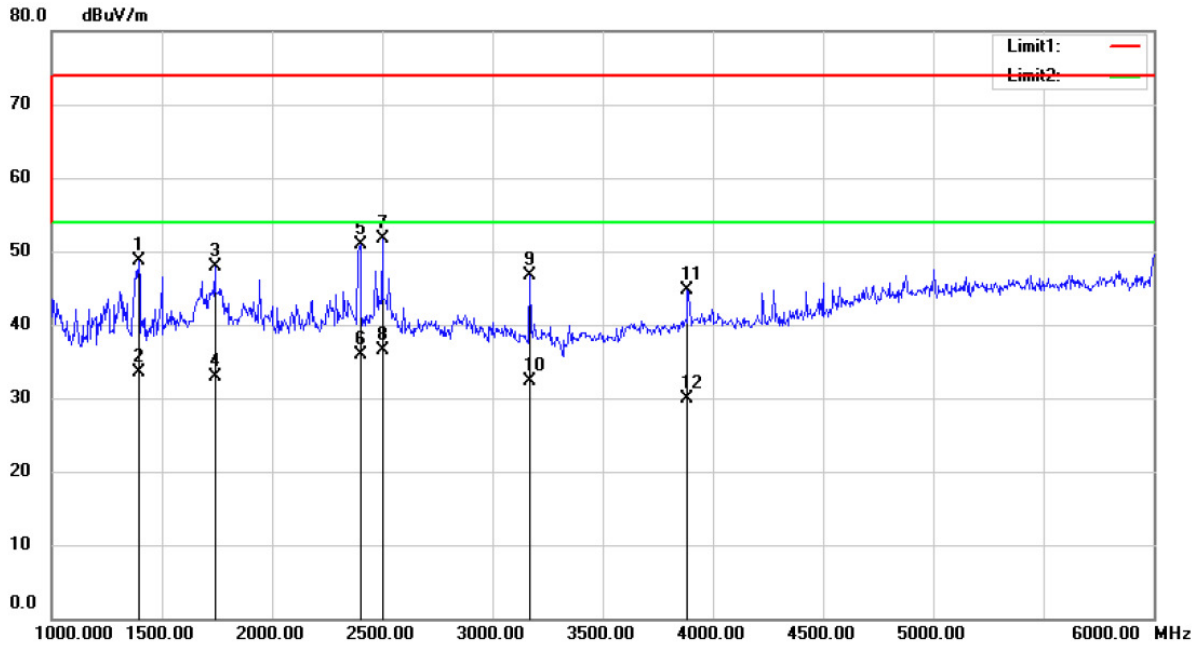

Site 3m Chamber #1 Polarization: **Vertical** Temperature: 24 C
 Limit: (RE)FCC PART 15 CLASS B Power: AC 120V/60Hz Humidity: 53 %
 Mode: TOUCH MODE
 Note:

No.	Mk.	Freq.	Reading Level	Correct Factor	Measurement	Limit	Over	Antenna Height	Table Degree	
		MHz	dBuV	dB	dBuV/m	dBuV/m	dB	cm	degree	Comment
1		1395.000	71.88	-23.21	48.67	74.00	-25.33			peak
2		1395.000	56.72	-23.21	33.51	54.00	-20.49			AVG
3		1740.000	71.53	-23.70	47.83	74.00	-26.17			peak
4		1740.000	56.59	-23.70	32.89	54.00	-21.11			AVG
5		2400.000	73.03	-22.05	50.98	74.00	-23.02			peak
6		2400.000	57.86	-22.05	35.81	54.00	-18.19			AVG
7		2500.000	73.45	-21.80	51.65	74.00	-22.35			peak
8	*	2500.000	58.23	-21.80	36.43	54.00	-17.57			AVG
9		3170.000	67.89	-21.26	46.63	74.00	-27.37			peak
10		3170.000	53.49	-21.26	32.23	54.00	-21.77			AVG
11		3885.000	63.75	-19.03	44.72	74.00	-29.28			peak
12		3885.000	48.99	-19.03	29.96	54.00	-24.04			AVG

*:Maximum data x:Over limit !:over margin

Operator: CSL

6. PHOTOGRAPHS

6.1. Photos of Conducted Emission Measurement

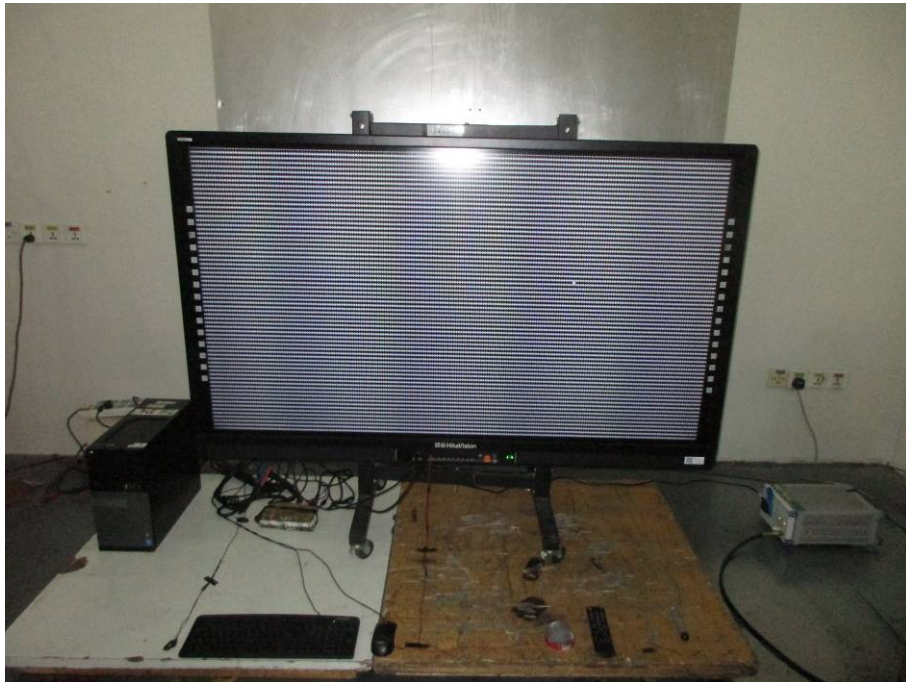

6.2. Photos of Radiation Emission Measurement

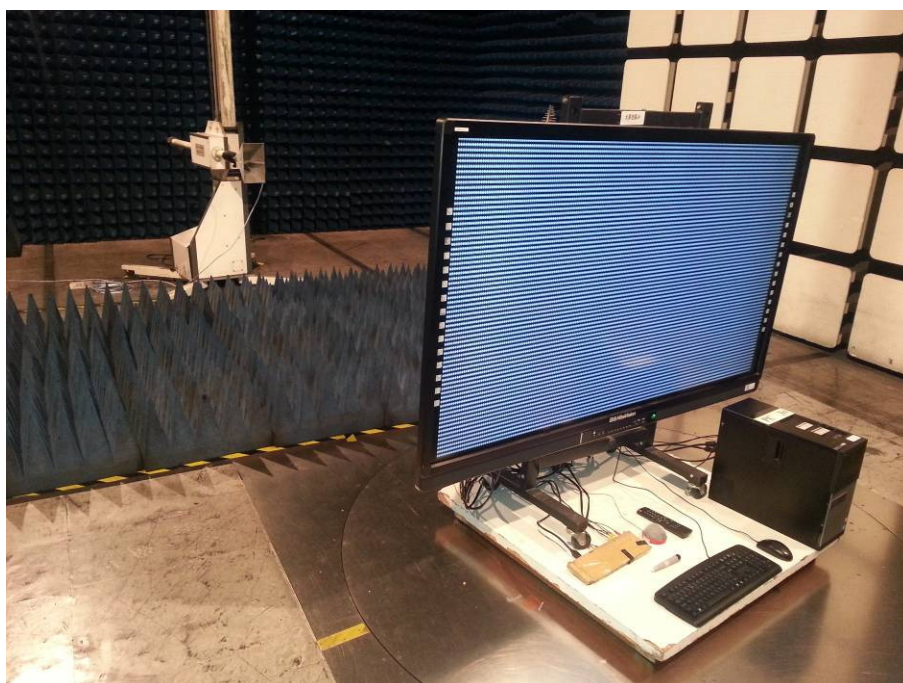

APPENDIX
(Photos of EUT)









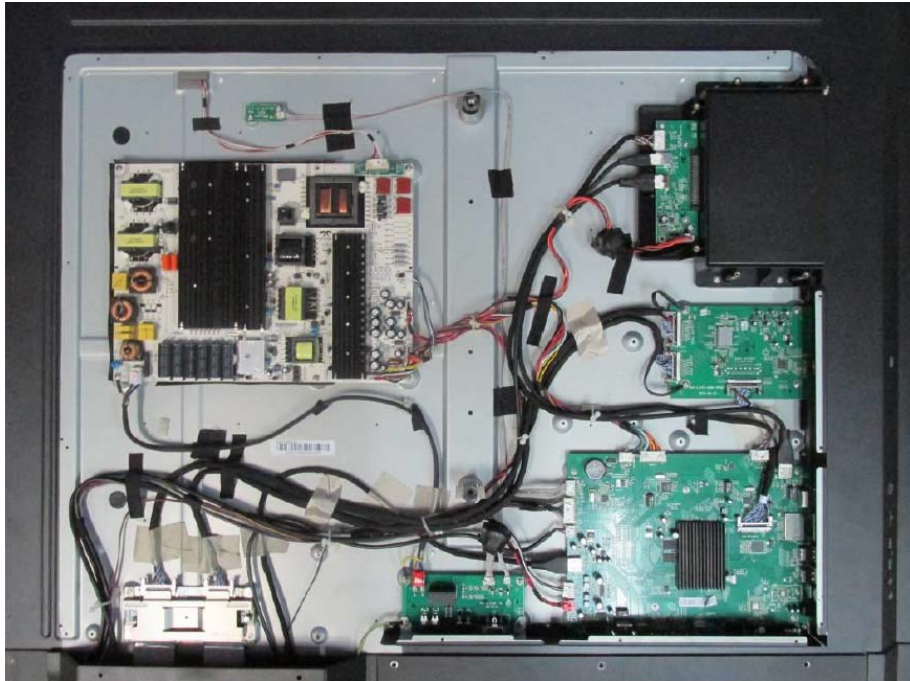

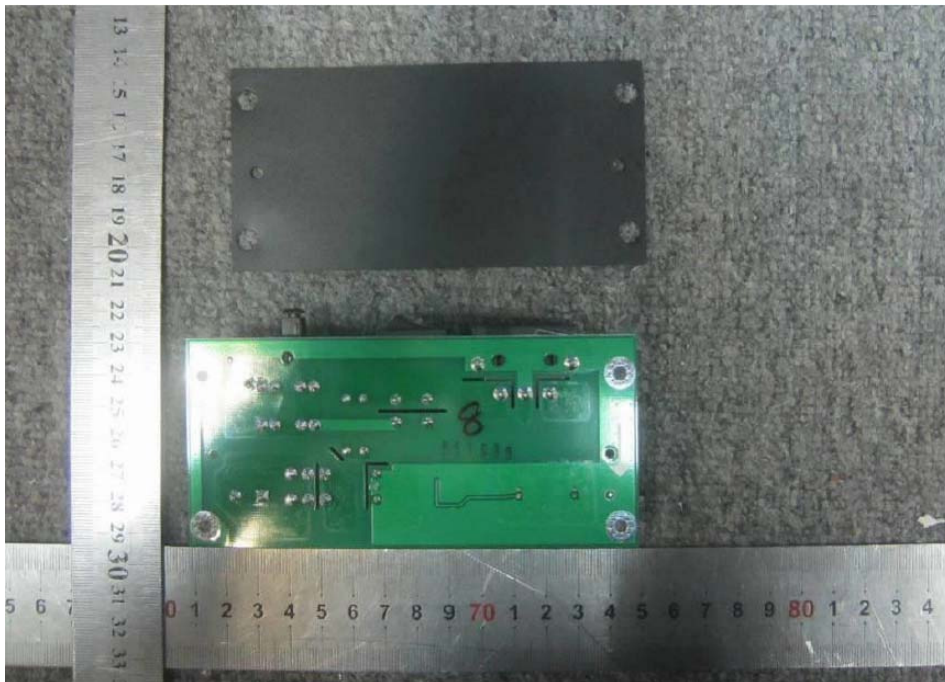
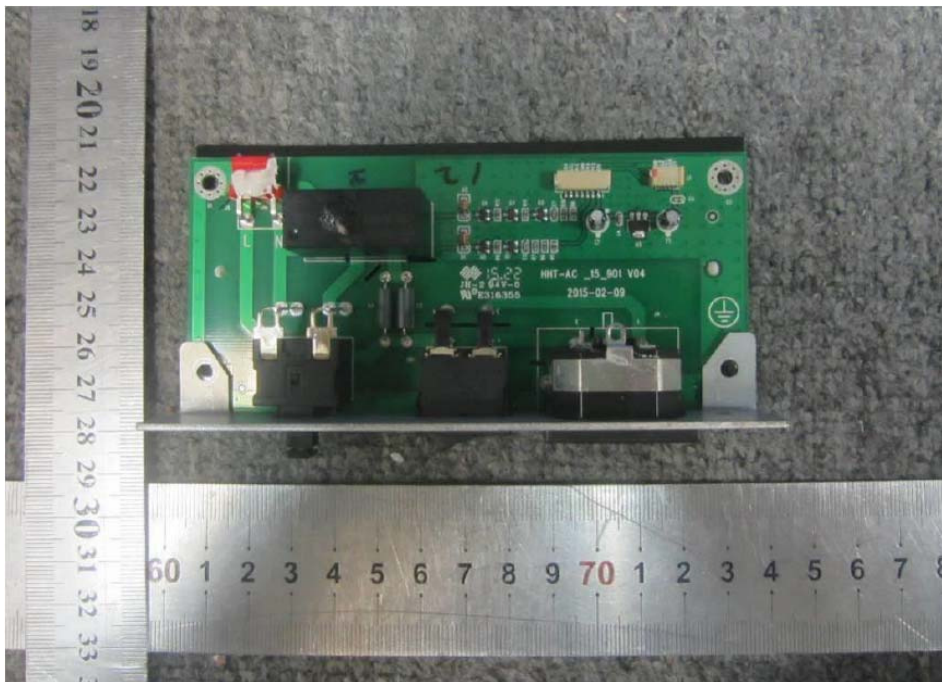

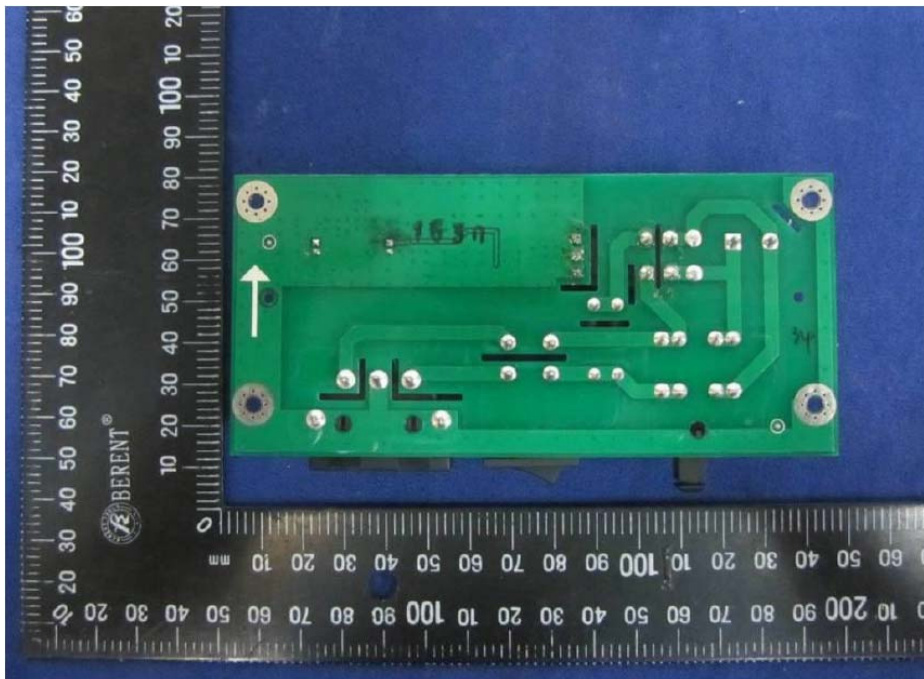
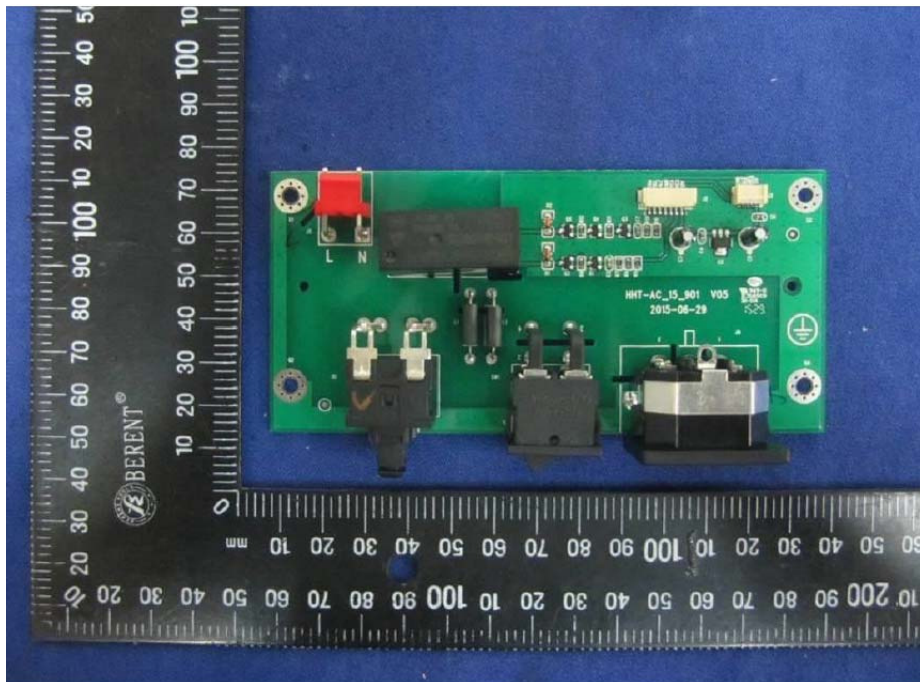

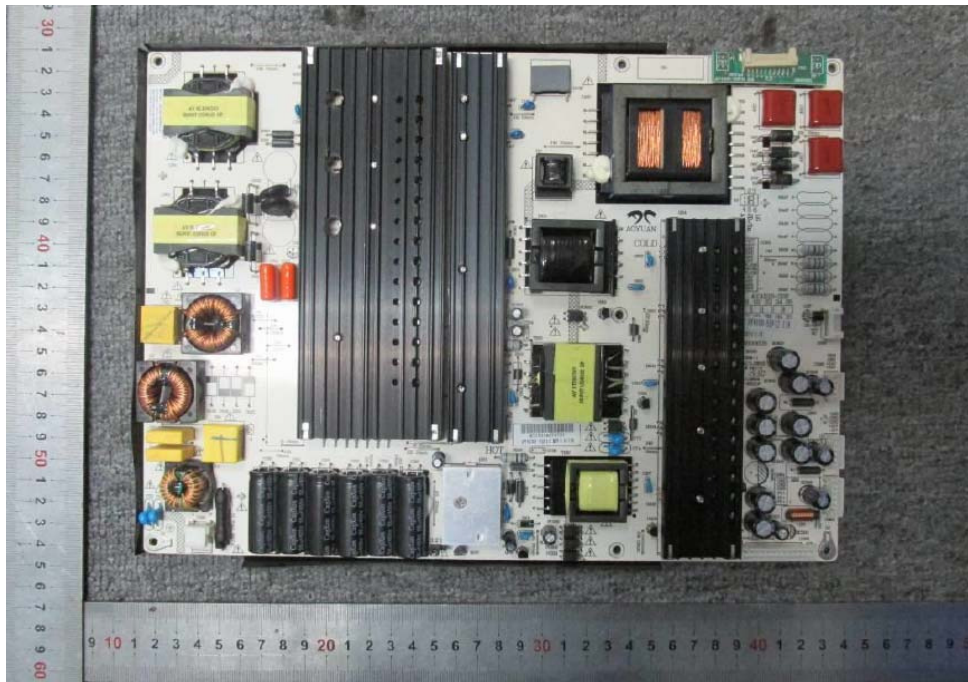

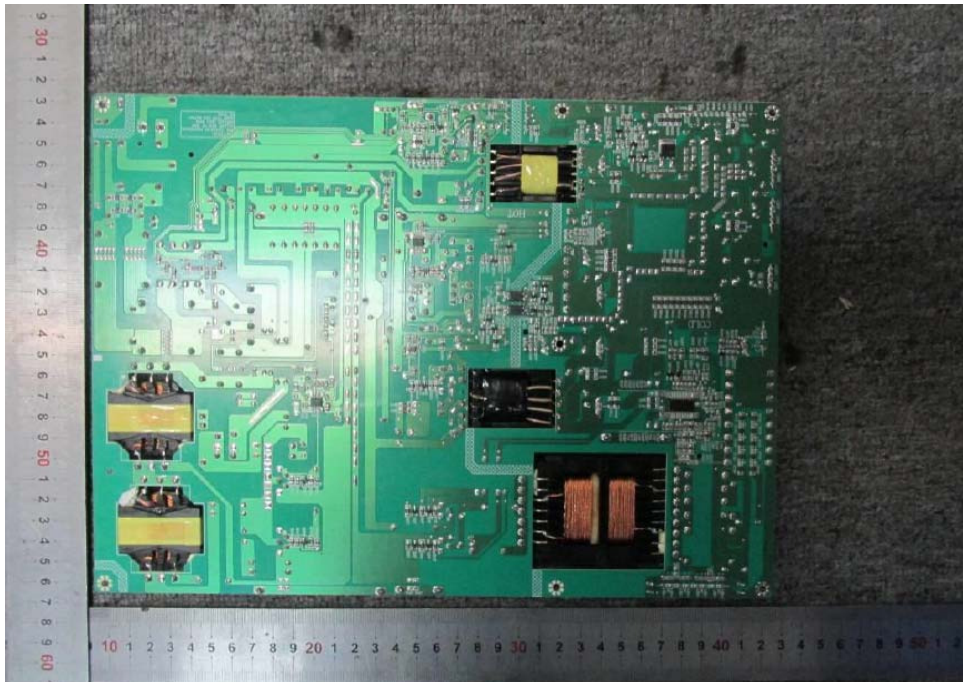



-----The end-----