

LED Interactive Multi-Touch Display User Manual



Please properly keep the manual for further reference. This is the general user manual for all interactive panels. Therefore, it may be different from the actual product.

Welcome:

Thanks for purchasing this product. Please read the instructions carefully before using this product.

This device complies with part 15 of the FCC Rules. Operation is subject to the following two conditions: (1) This device may not cause harmful interference, and (2) this device must accept any interference received, including interference that may cause undesired operation.

This equipment has been tested and found to comply with the limits for a Class B digital device, pursuant to part 15 of the FCC Rules. These limits are designed to provide reasonable protection against harmful interference in a residential installation. This equipment generates, uses and can radiate radio frequency energy and, if not installed and used in accordance with the instructions, may cause harmful interference to radio communications. However, there is no guarantee that interference will not occur in a particular installation. If this equipment does cause harmful interference to radio or television reception, which can be determined by turning the equipment off and on, the user is encouraged to try to correct the interference by one or more of the following measures:

- Reorient or relocate the receiving antenna.
- Increase the separation between the equipment and receiver.
- Connect the equipment into an outlet on a circuit different from that to which the receiver is connected.
- Consult the dealer or an experienced radio/ TV technician for help.

Any changes or modifications to this unit not expressly approved by the party responsible for compliance could void the user's authority to operate the equipment.

The symbol of the crossed out wheeled bin indicates this product should not be placed in municipal waste. Instead, you need to dispose of the waste equipment by handing it over to a designated collection point for the recycling of waste electrical and electronic equipment.





Contents

1 Mounting Requirements	6
1.1 Bearing	6
1.2 Ventilation.....	6
2 Product Introduction.....	8
2.1 Outer Appearance	9
2.2 Front Panel	9
2.2.1 Front Panel Port.....	10
2.2.2 Front Panel Button.....	11
2.3 Rear Port Panel 1	12
2.4 Rear Port Panel 2	12
2.5 Remote Controller	14
3 Basic Operation	18
3.1 Power on.....	18
3.2 Power off	19
3.3 Software Installation.....	19
3.4 Software Uninstall	20
3.5 Software Calibration.....	20
3.6 Calibration Method for Windows 7	22
3.7 OPS Installation	25
3.8 Select Signal Channel.....	26
4 Menu	27
4.1 Time.....	27
4.2 Picture.....	30
4.3 Sound.....	33
4.4 Option.....	37
5 Multi-Media	40
6 ECO Mode.....	46
7 Serial Port Control	47
8 Specifications of PC Mode (VGA Input)	49
9 Formats Supported by Multi-media	50
10 FAQ & Troubleshooting.....	51

11 Maintenance Tips	54
12 Clean the Infrared Tube.....	55
13 Technical Parameters	56

Safety Instruction

For your safety, please read the following instruction before you use the product. Serious injury or property loss may be caused by improper operations. Do not try to repair the product by your own.

 WARNING	
	<p>Disconnect the product from power supply immediately if major failures occur.</p> <p>The major failures include the following:</p> <ul style="list-style-type: none">• Smoke, peculiar smell or abnormal sound is discharged from the product.• No image or sound is displayed, or the image error occurs.• Where the mains plug or an appliance coupler is used as the disconnect device the disconnect device shall remain readily operable. <p>In the preceding scenarios, do not continue to use the product, disconnect power supply immediately and contact professional staff for troubleshooting.</p>
	<p>Do not drop liquid, metal or combustible into the product.</p> <ul style="list-style-type: none">• If any liquid or metal is dropped into the product, power off the product and disconnect power supply, then contact professional staff for solutions.• Pay attention to the children when they are close to the product.
	<p>Do not damage the power cable.</p> <ul style="list-style-type: none">• Do not damage, change, wind, bend, heat or drag the power cable forcibly.• Do not put weights (such as the product itself) on the power cable.• Do not drag the cable forcibly when you pull out the power plug. If the power cable is damaged, please contact the local distributor to repair or replace it.
	<p>Put the product on a stable surface.</p> <p>An unstable surface includes and does not limited to an inclined plane, a shaky stand, desk or platform, which might cause the turnover and damage.</p>
	<p>Use the battery correctly.</p> <ul style="list-style-type: none">• Galvanic corrosion, electric leakage and even fire may be caused by improper battery usage.• It is recommended to use the designated type of battery and install the battery by correct electrodes (positive and negative electrodes).• Do not install and use new battery with the used one.• Take out the battery if the remote control is not used in a long period.• Do not expose the battery under overheated environments such as sunlight and firing.• Dump the used battery based on local regulations.



WARNING



Do not open the cover or change the product by your own.

High voltage components are installed in the product. When you open the cover, high voltage, electric shock or other dangerous situations may occur. If inspection, adjustment or maintenance is required, contact the local distributor for help.



Use the specified power supply.

- Do not use any types of power cables other than the one provided with the product to prevent the product from being damaged.
- Use a three-wire socket and ensure that it is properly grounded.
- Pull out the power plug from the socket if the product is not used in a long period.

Before you move the product, disconnect all the external connections and separate all the toppling preventing devices.

Move the product carefully to prevent it from being hit or squeezed, especially the screen, which may cause injury if broken.

Clean the dust and metal on the power plug regularly.

- When you are cleaning, fire or electric shock may be caused if the product is powered on.
- Keep in mind to pull out the power plug before cleaning it by using a dried cloth.



Do not put items on the top of the product.

- Do not put items, such as a container for liquid (a vase, flowerpot, cosmetics or liquid medicine), on the top of the product.
- If any water or liquid is spilled on the product, short circuit may occur and cause fire or electric shock.
- Do not tread on the product or hang any items on the product.



Do not install the product in an improper place.

- Do not install the product in humid places, such as the bathroom, the shower room, the place near windows or outdoor environments where experience rain, snow or other harsh weather. The product installation is also required to avoid a place around by hot spring vapor. The preceding environments may cause faults or electric shock under extreme conditions.
- Do not put exposed fire source, such as an ignited candle, on the product.



Pull out the power plug during thunderstorms.

- Do not touch the product when lightning to avoid electric shock.
- Install or place components which power supply voltage is high enough to cause personal injury in places out of the reach of children.



Do not cover or block up any vents on the product.





- The overheated components may cause fire, damage the product and shorten the service life.
- Do not put the venting surface of the product facedown.
- Do not install the product on a carpet or bed clothes.
- Do not use a cloth such as the table cloth to cover the product.



Do not touch the power cable with wet hands to avoid electric shock.

 **NOTE**

Please pay attention to the preceding warning information. Otherwise, serious injury, incidents, even death may be caused.

 CAUTION	
	<p>Do not install the product in high temperature environments.</p> <ul style="list-style-type: none">• Do not install the product near heat source, such as the radiator, the heat reservoir, the stove or other heating devices.• Do not expose the product under sunlight, which may cause high temperature and subsequent faults in the product.
	<p>For transport:</p> <ul style="list-style-type: none">• Pack the product for mobility or maintenance by using the cartons and cushioning material provided with the product.• Vertically move the product during transport. The screen or other components are easily broken if the product is moved by an improper way.
	<p>Keep away from the product when you use a radio.</p> <p>The product design to prevent radio interference complies with the international EMI standard. However, the interference still exists and causes noise in the radio.</p> <p>If noise occurs in the radio, try the following solutions.</p> <ul style="list-style-type: none">• Adjust the direction of the radio antenna to avoid the interference from the product.• Keep the radio away from the product. <p>Advice for watching:</p> <ul style="list-style-type: none">• Use the product in an environment with comfortable light. It is harmful to your eyes to watch in a too bright or too dark environment.• Relax your eyes after a period of time for watching.• When you are watching, the distance which is 3 to 7 times of the screen height should be kept, and it is the best distance to protect eyes and prevent eyestrain.• Adjust the volume to an appropriate level, especially at night.

 **NOTE**

Please pay attention to the preceding caution information. Otherwise, minor injury or product damage may be caused.

1 Mounting Requirements

1.1 Bearing

You can choose the portable or wall mounting method according to your needs. Wall mounting can substantially save the space.

If you choose portable mounting, use the mounting rack or support. If you want to use a self-made mounting rack, the bearing capacity of the rack should be at least four times of the actual weight of the display. The bearing capacity of the mounting support must be at least four times of the actual weight of the display to ensure steadiness of the interactive panel.

When you choose wall mounting, the bearing capacity of the mounting surface must be at least four times of the weight of the display. When the mounting surface is a wall or ceiling of a building, the wall must be built with solid bricks, concrete or materials of equal intensity. If you need to mount the display on a loose surface such as an old brick wall, wood plank wall, solid brick wall, metal or non-metal structure wall, or a wall with a thick decoration layer, take necessary consolidating measures to ensure that the display is steadily mounted.

1.2 Ventilation

Ventilation requirements	Distance to the mounting surface (cm)			
	Left and right side	Top	Bottom	Back
Nominal power				
Larger than 100W	10	20	20	10



WARNING

If the product is mounted inside a wall or a cabinet, in addition to the above-mentioned requirements, the area of ventilation holes at the bottom, top and two sides must be at least 50% of the sealing surface to ensure proper ventilation.

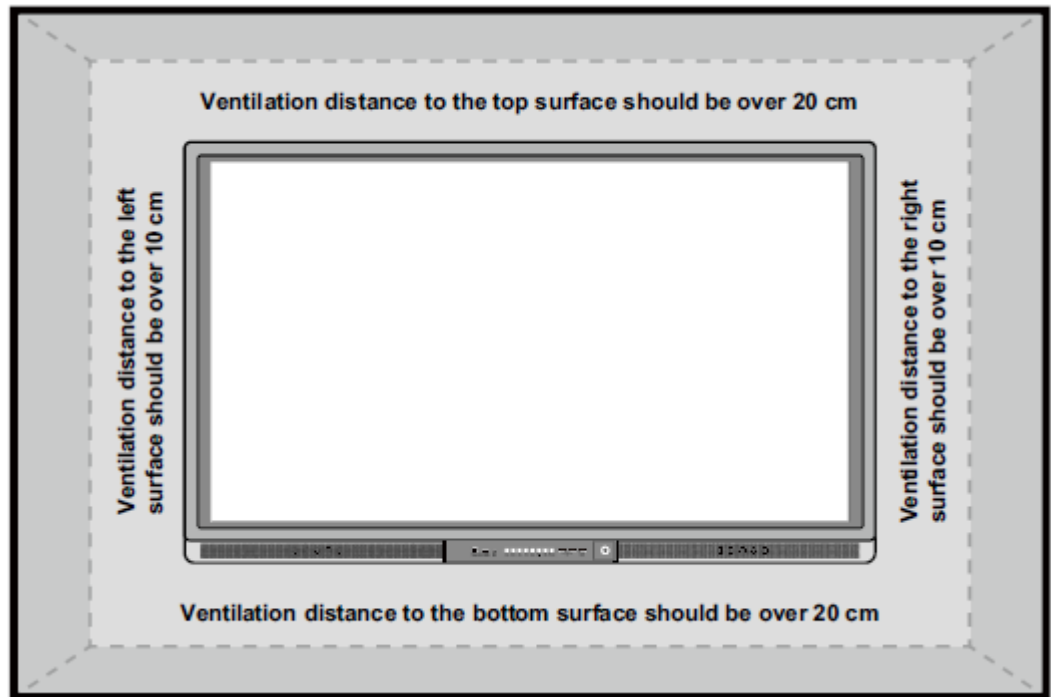

* See CAS 132-2006

2 Product Introduction

Thank you for buying Interactive touch screen. As our latest independently developed and produced human-machine interactive products, the Interactive touch screen are multi-functional teaching displays for interactive teaching, digital demonstration, multi-media presentation, touch operations and handwriting. They are well designed and produced to meet needs of education applications, and provide a user-friendly experience, digital intelligent control as ideal apparatus for modern education. You can use your fingers or opaque objects to write, edit and delete anything on them.

Features:

- Specially designed for teaching and meeting systems.
- Integrating user management module to realize user adding/deleting, switching and user information customizing functions that coincide with users' preference.
- Adopting infrared array scanning and sensing technology, HID drive-free, plug-and-play
- Outstanding display edit functions, supporting instant edit.
- Multiple optional pens, width and colors; simulative brushes that are vigorous.
- Multiple backgrounds, supporting customized background with any images and graphs inserted.
- Supporting dual-point touch and multi-finger roaming; simulative mouse operation.
- Supporting identification of handwritten Chinese, English, number and special characters.
- Supporting conversion of handwritten files into other formats including PDF, JPEG, GIF, PNG, TIFF and BMP.
- Intelligent geometric figure identification, able to identify multiple figures with high recognition rate and multi-pen identification.
- Vector-based graphic processing with high compression rate and low distortion
- One-key economy mode.
- High brightness and contrast display to ensure clear display under straight light or in outdoor environment.

2.1 Outer Appearance

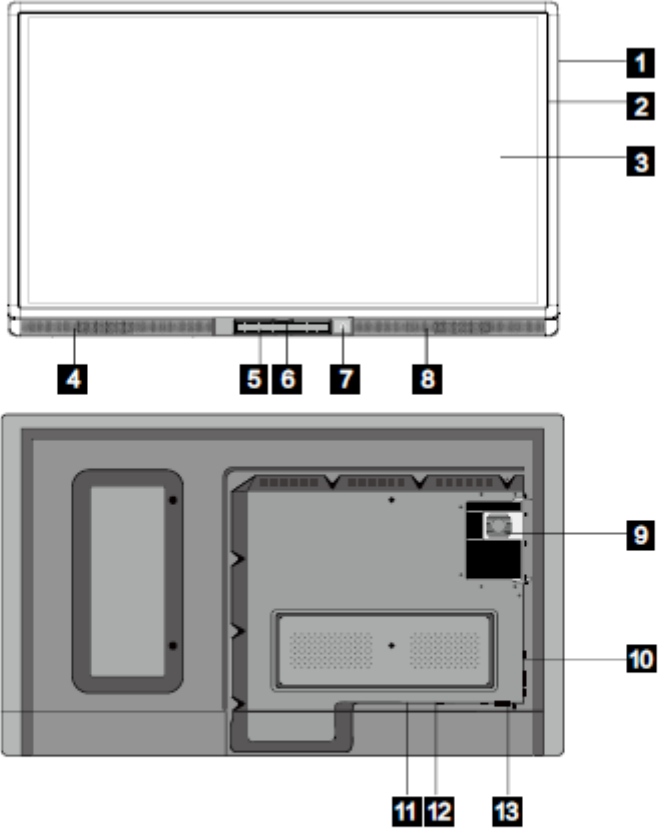

- 1** Enclosure
- 2** Infrared Frame
- 3** Screen
- 4** Left Loudspeaker
- 5** Front Panel
- 6** Front Cover Plate *
- 7** Power on/off
- 8** Right Loudspeaker
- 9** OPS Port
- 10** Rear Port Panel 1
- 11** Rocker Switch
- 12** Power Outlet
- 13** Rear Port Panel 2

 **NOTE**
 “*” indicates optional.

2.2 Front Panel

2.2.1 Front Panel Port

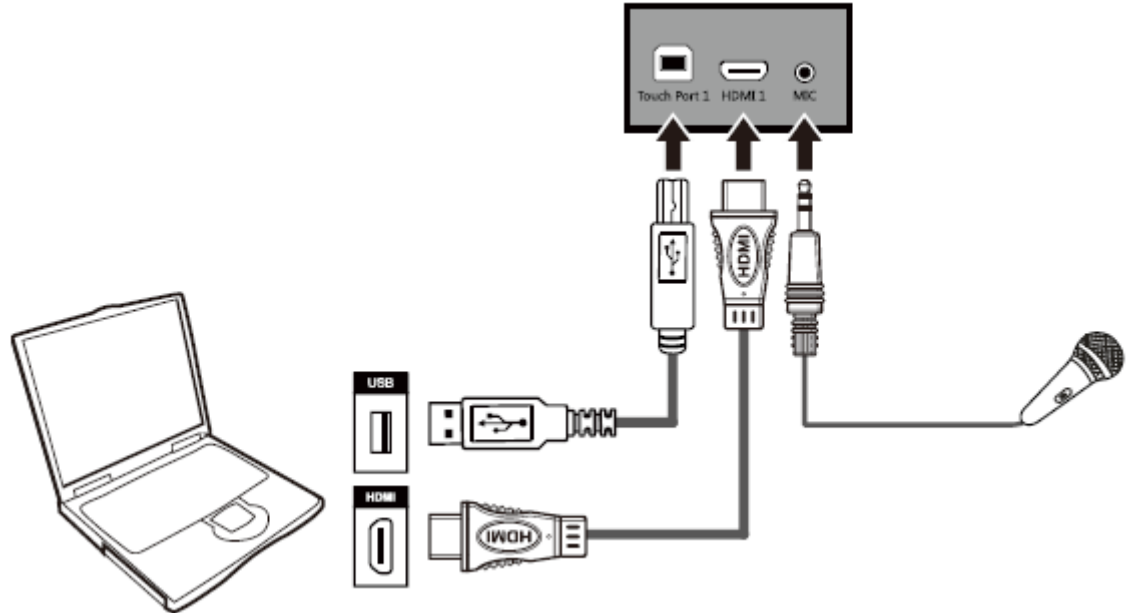

Name	Function Description
Touch Port 1	The touch control terminal 1 which is used to connect to a PC.
HDMI 1	The input terminal 1 for high definition signal, which is used with the “Touch Port 1” to operate PC in the way of touch control.
MIC	The external microphone port.



NOTE

Touch Port 1 corresponds to HDMI 1, and Touch Port 2 corresponds to VGA In, HDMI 2 and HDMI 3.

2.2.2 Front Panel Button

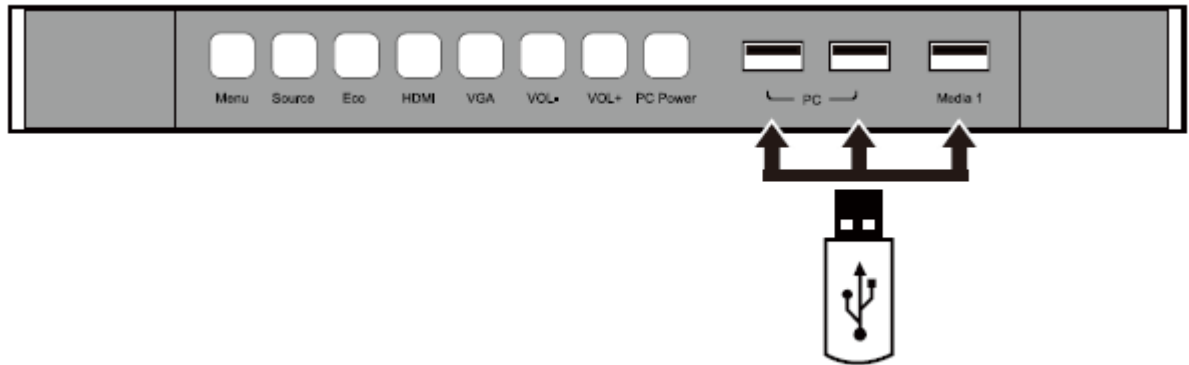

Name	Function Description
Menu	Enter the function menu.
Source	Enter the menu to select a signal source.
Eco	Switch among three modes: energy-saving, automatic, and standard.
HDMI	Switch over to HDMI signal source.
VGA	Switch over to VGA signal source.
VOL-	Decrease volume.
VOL+	Increase volume.
PC Power	Power on or power off the OPS.
PC	The USB 2.0 and USB 3.0 ports for the OPS.
Media 1	External multimedia USB port 1. Rating: 5Vdc 500mA

2.3 Rear Port Panel 1

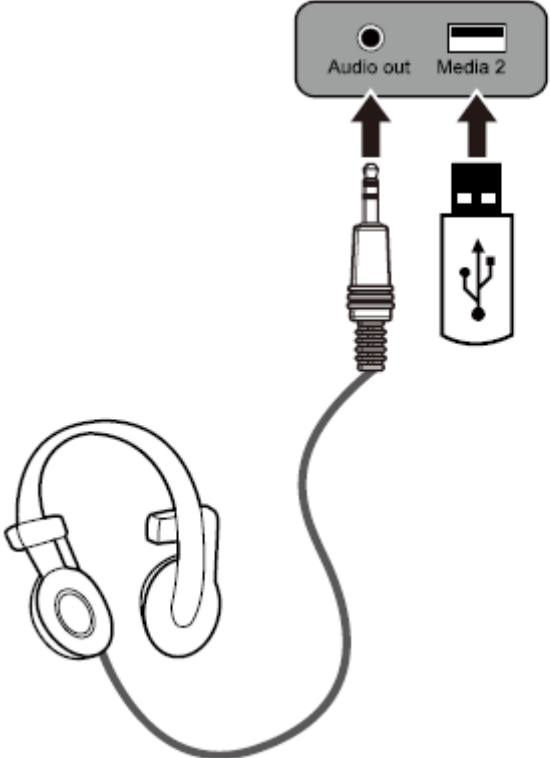

Name	Function Description
Audio out	The terminal for external loudspeaker boxes or headphones.
Media 2	External multimedia USB port 2, which can be used to connect with a U disk or a hard disk. Rating: 5Vdc 500mA

2.4 Rear Port Panel 2

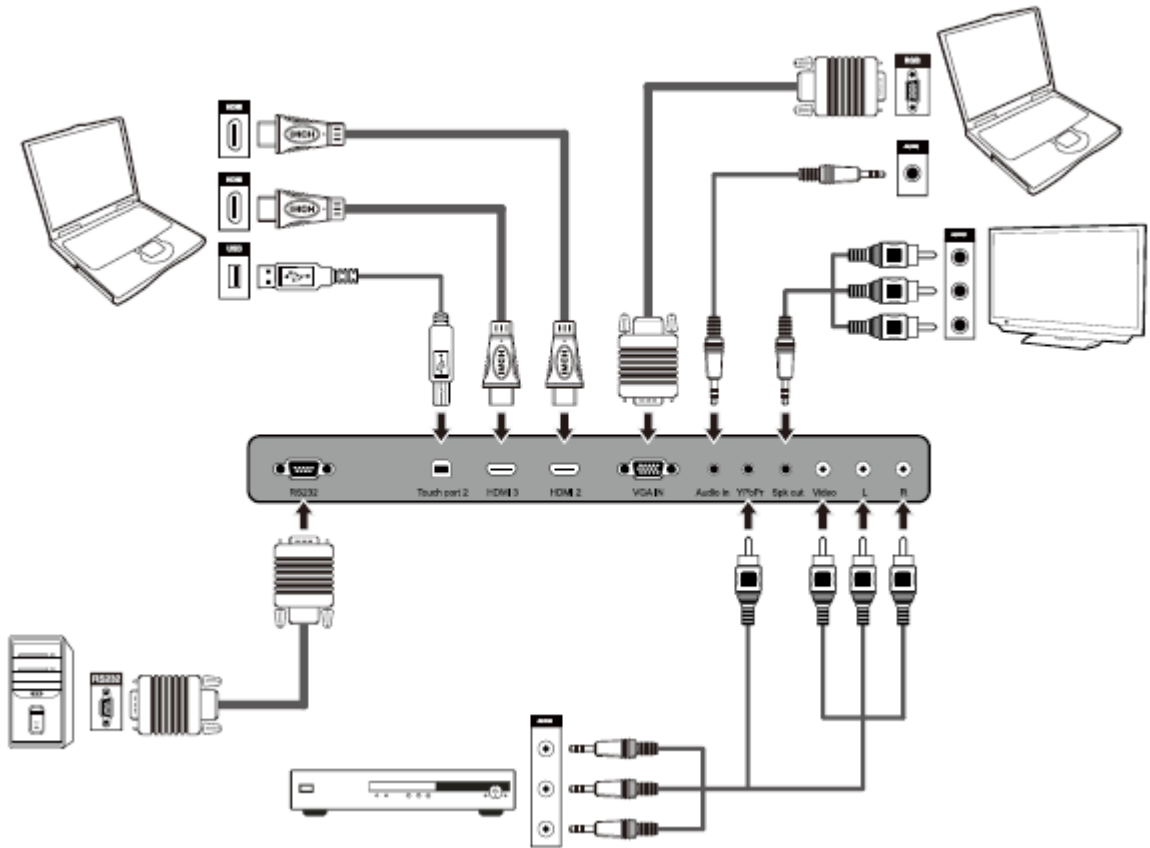

























Name	Function Description
RS232	The input port for series signals, which is used by specific control device of serial port to input serial port protocol in order to control the panel.
Touch port 2	The terminal 2 for touch control signal.
HDMI 3	The input terminal 3 for high definition signal, which is used with the “Touch port 2” to operate PC in the way of touch control.
HDMI 3	The input terminal 2 for high definition signal, which is used with the “Touch port 2” to operate a PC in the way of touch control.
VGA IN	The VGA port for an external PC, which is used with the “Touch port 2” to operate the PC in the way of touch control.
Audio in	The “Audio in” is used with the VGA port for an external PC.
YPbPr	The component video terminal, which is used to connect to video devices such as the HD digital signal STB, the satellite receiver, DVD players and other HD displays or TV equipment.
Spk out	Audio and video output terminal.
Video	An array of audio and video input terminals, which are used to input audio and video signal.
L	

Name	Function Description
R	Video: Video input terminal. L: Left audio input terminal. R: Right audio input terminal.

2.5 Remote Controller



Items	Functions Description
	Power on or standby
	Mute
	Menu or return to parent menu

Items	Functions Description
	Quit
0-9	Select TV channel or enter number
	Freeze
	Enable listen alone mode
	Display or quit signal source menu
	Show current signal status or information
	Confirm selected item
	Up direction button
	Down direction button
	Left direction button
	Right direction button
	Adjust volume
	Select channel
	Previous media file
	Next media file
	Rewind
	Play
	Fast forward
	Auto adjust window under PC signal source
	Switch to PC input signal
	Switch to HDMI input signal
	Switch to OPS input signal
	Switch to ECO mode

Remote Controller Instructions

The usage scope of the remote controller includes the vertical distance within five meters in front of the product, and the area within an angle of 30 degrees from the vertical point to the left and the right.



The effective receiving area is about 3 meters with 30° angle from vertical point to the left.



The effective receiving area is about 3 meters with 30° angle from vertical point to the right.



The effective receiving distance is about 5 meters from the front of device.



WARNING

To avoid probable faults, please read the following instructions and use the remote controller properly.

- Do not drop or beat the remote controller.
 - Do not spill water or other liquid on the remote controller.
 - Do not put the remote controller on wet items.
 - Do not expose the remote controller under sunlight or put it near overheated source.
-

3 Basic Operation

3.1 Power on

Step 1 Power the interactive panel with 100V-240V 50Hz/60Hz AC power supply.

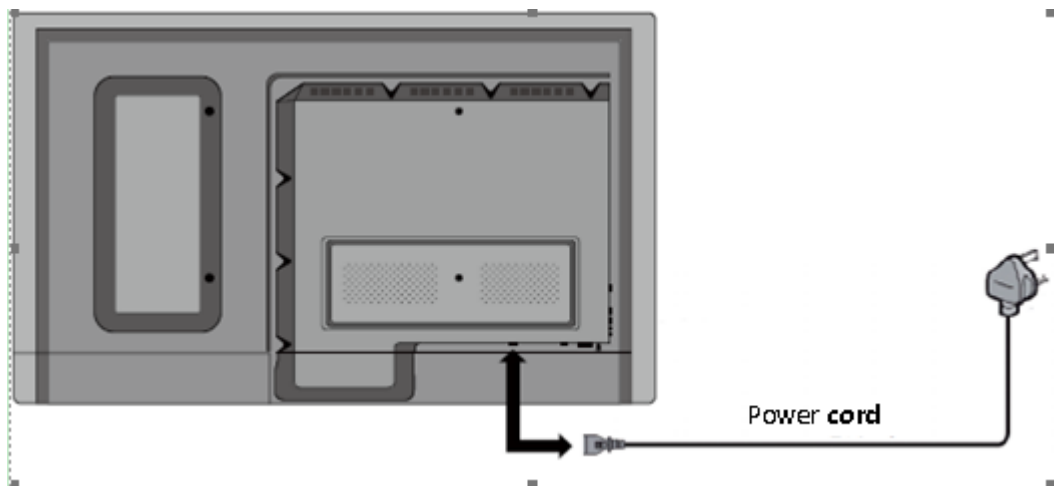

Step 2 Turn on the rocker switch at the bottom of the interactive panel (next to the power port) to enable power supply. In this case, the indicator is in red.

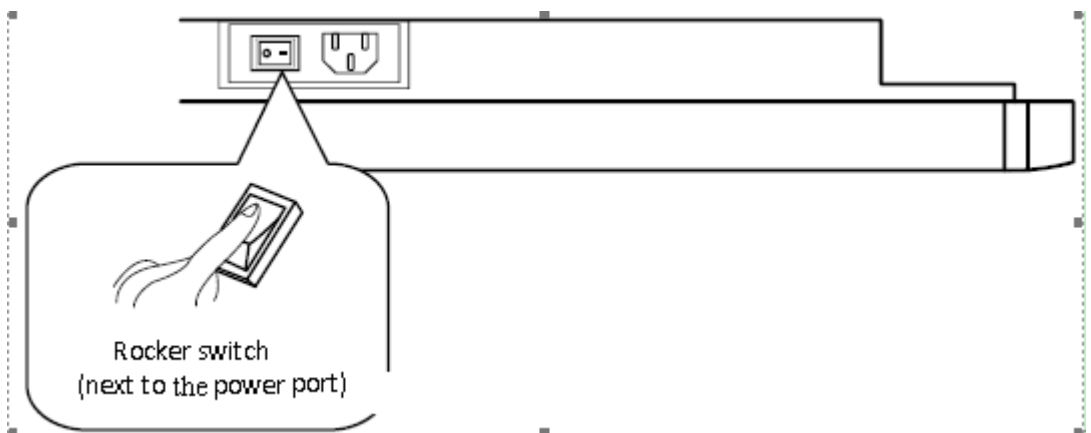

- Step 3** Press power switch on the interactive panel or  on the remote controller to turn on the interactive panel. In this case, the indicator is in green. Press **PC Power** on the front panel to power on the OPS (for all-in-one models only).

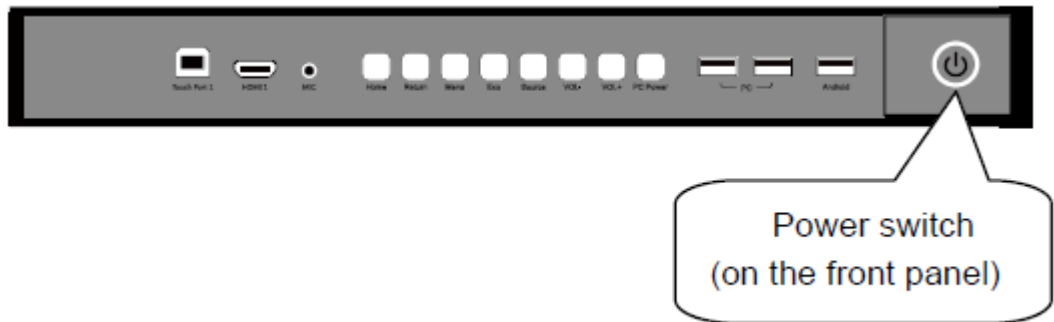

3.2 Power off

- Standby status: When the interactive panel is in running status, press **Power** or  on the remote controller. The interactive panel enters in standby status. When the OPS is in running status, Press **PC Power** on the front panel. The OPS enters in standby status (for all-in-one models only).

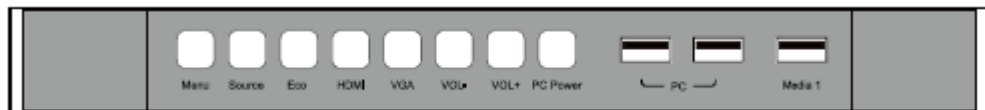

- Power off: Turn off the rocker switch at the bottom of the interactive panel (next to the power port) or pull out the power plug to switch off the interactive panel completely.
- For all-in-one models, turn off the OPS before powering off the interactive panel.



NOTE

*If the **PowerKey Turn On PC** is enabled, you do not need to press **PC power** to control the OPS during the power-on and power-off processes.*

Status of the power indicator is as follows:

Power Indicator	Status
No light	Powered off
Red	Standby
Green	Powered on

3.3 Software Installation

- Recommended configuration
 - CPU: Inter (R) Core i3 2.27GHz or AMD CPU with equivalent performance
 - Memory: 1GB
 - Hard drive: 1GB

- Graphics card: supports DirectX 9 or above
- If the interactive panel is equipped with the latest version of handwriting software in the PC before being delivered, please skip the step.
- HID drive-free function only applies for Vista, Windows 7 or higher version (realize the functions of multi-touch etc.). The touch LCD display with Windows XP version should install/run the software for normal use.

Step 1 Insert the official USB cable into the USB ports of the computer and touch LCD display.

Step 2 Insert the official software installation disk into the computer.

Step 3 Double click the  Application.exe, follow the instructions and complete the installation of the touch LCD display software.

Step 4 The computer needs to restart so as to activate the software after installation completed. Save all the files in the computer and restart.

3.4 Software Uninstall

If you determine to uninstall the Teach Infinity Pro from your computer, choose **Control Panel > Programs > Programs and Features** to uninstall the program, as shown in the following figure.

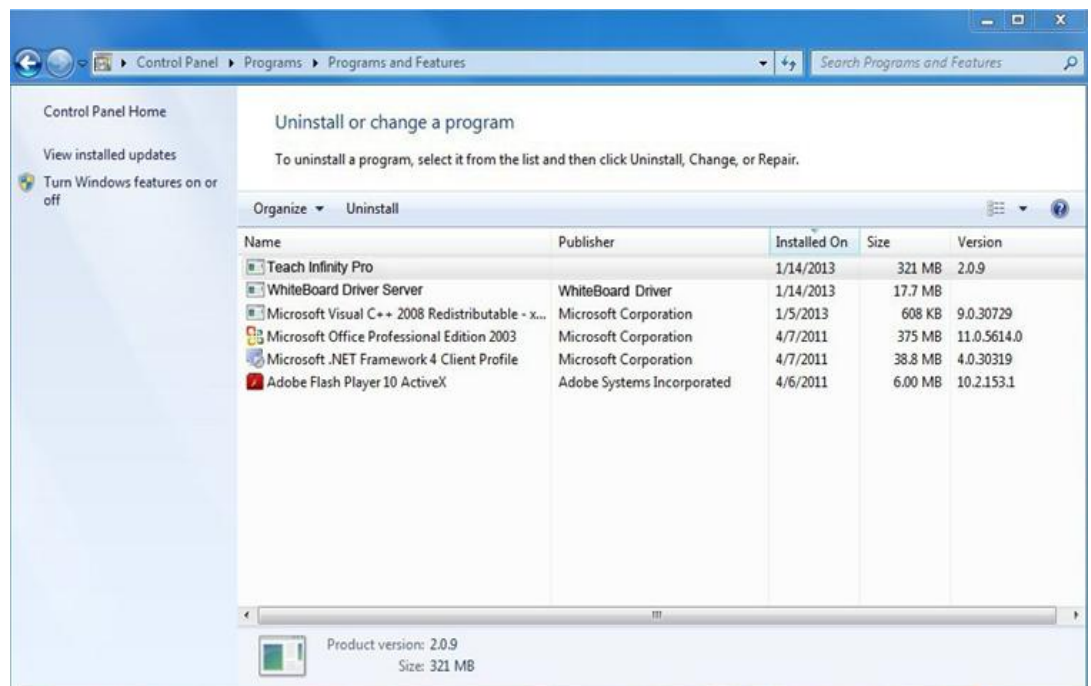

3.5 Software Calibration

To work normally, the handwriting of the projected image on the touch LCD display should coincide with the actual one so as to calibrate accurately. The following situations need calibration.

- When you first use the interactive LCD panel.
- Re-install the drive program.
- When you connect the panel to another PC.

The handwriting panel adopts nine-point calibration method. The position process is described as follows:

Step 1 Connect the panel and run the drive program.

Step 2 Click the handwriting drive icon on the right bottom of the panel to show the following image.

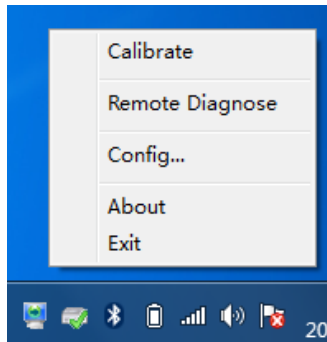

Step 3 Select **9 Points** and click **Calibrate**.

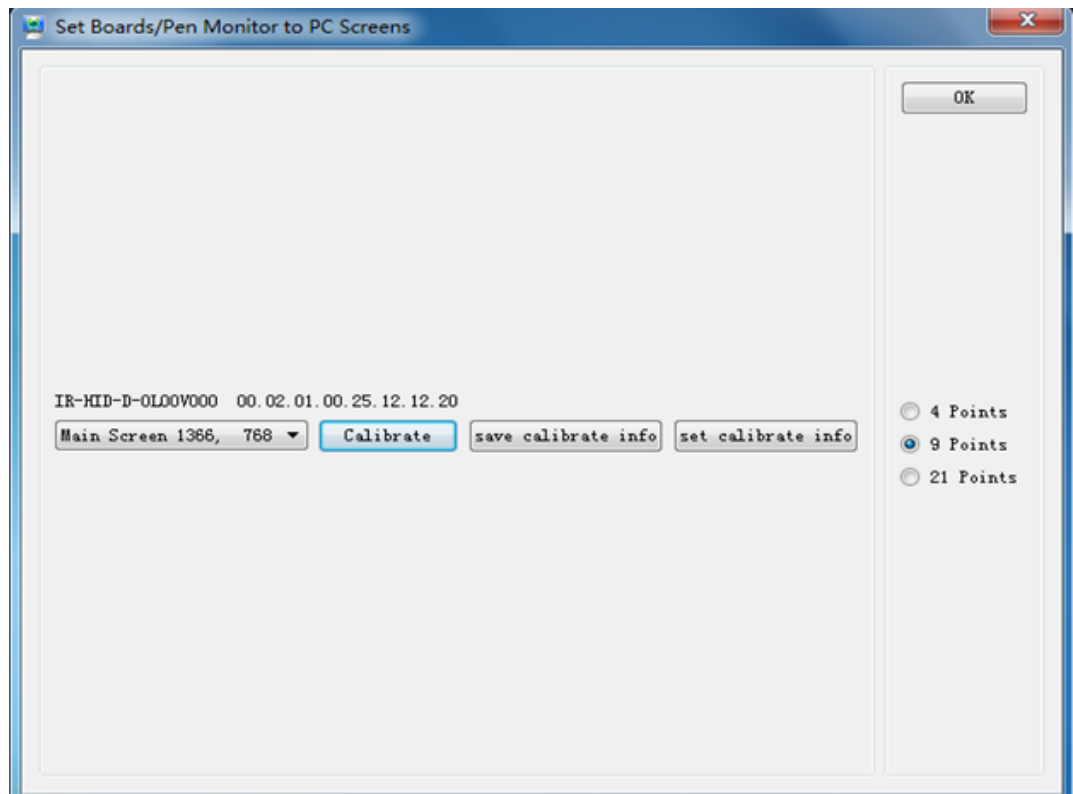

Step 4 Use the pen to click and hold the center of the flickering cross. Do not release it until the flickering cross moves to the next calibration point. Complete the calibration process as instructed. After it completes, you will return to the desktop automatically.

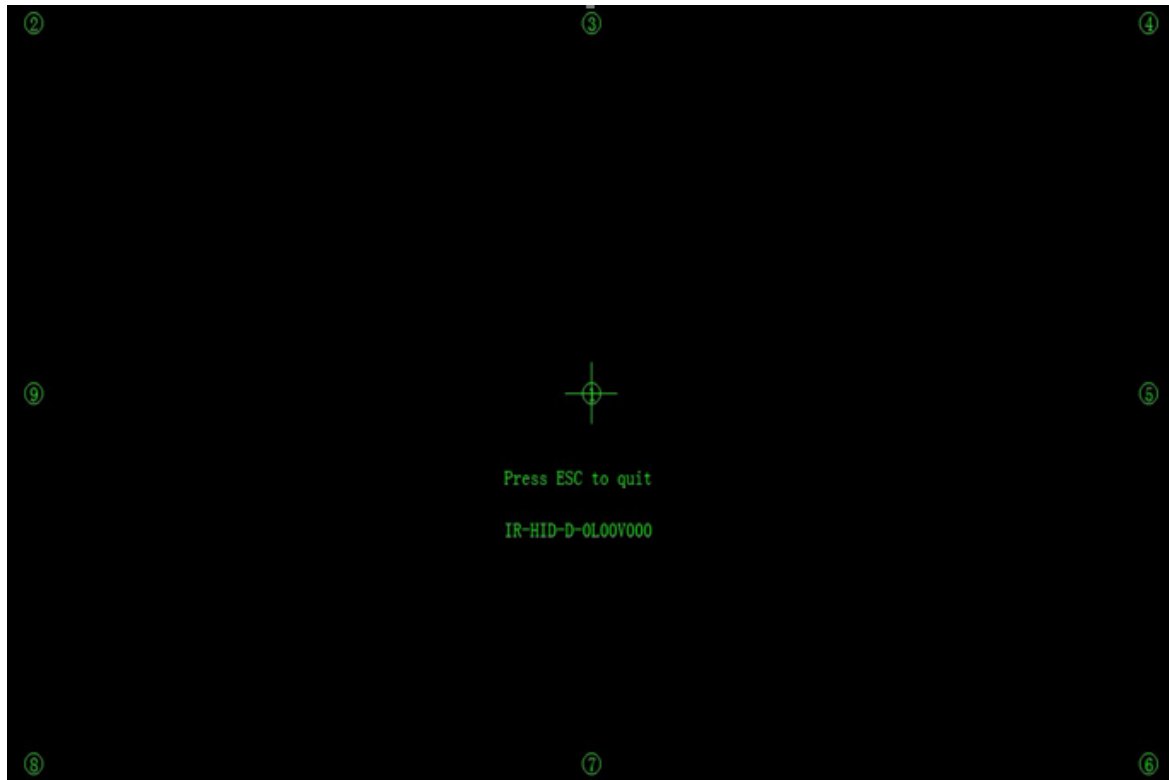

3.6 Calibration Method for Windows 7

- Step 1** Connect the interactive panel to a PC using the USB cable via the touch control USB port.
- Step 2** Select Tablet PC Setting on Control Panel.

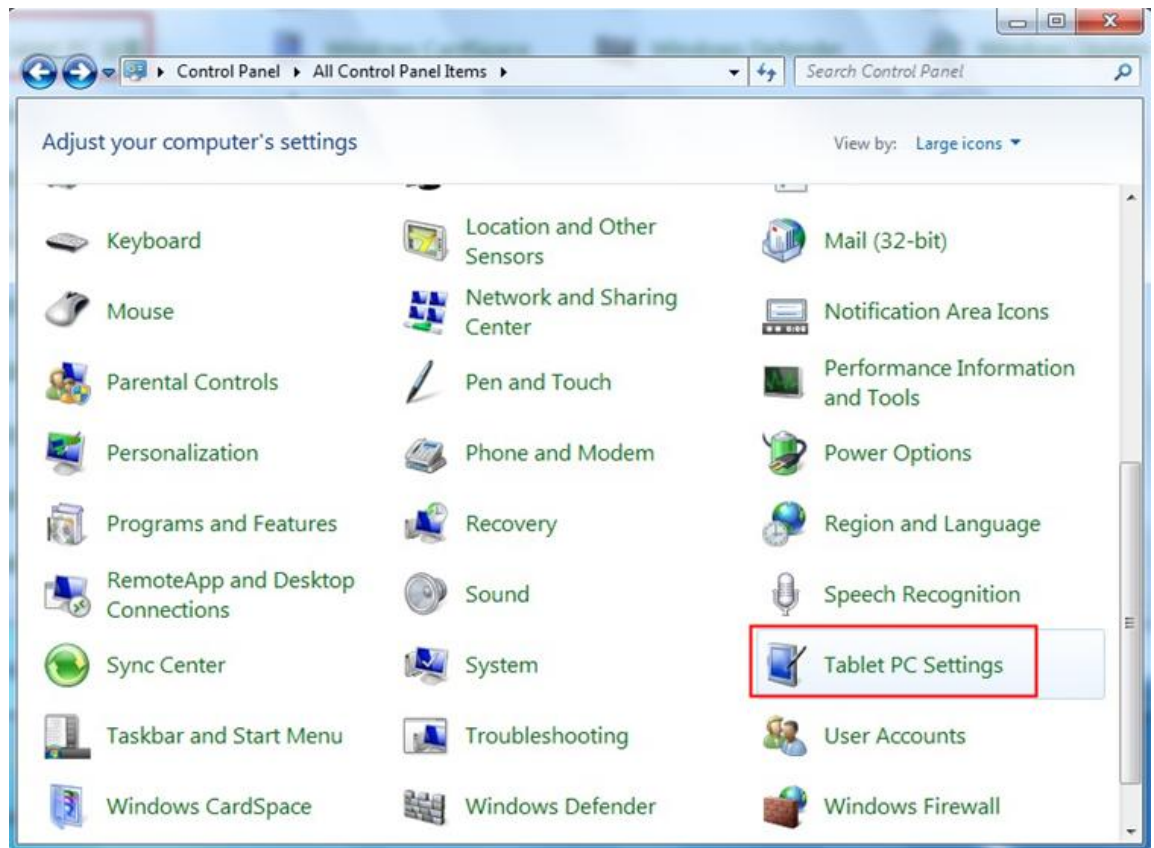

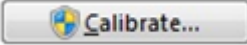
Step 3 Select  on the setting window.

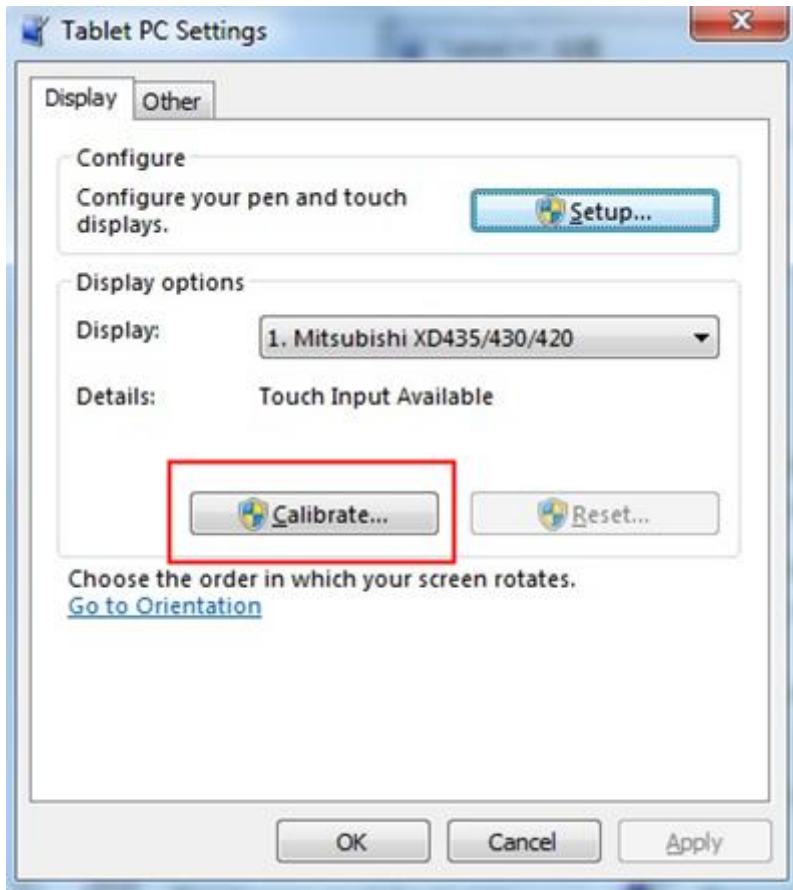

Step 4 Use the pen to click and hold the center of the flickering cross. Do not release it until the flickering cross moves to the next calibration point. Complete the calibration process as instructed.



Step 5 Click **Yes** after it completes.

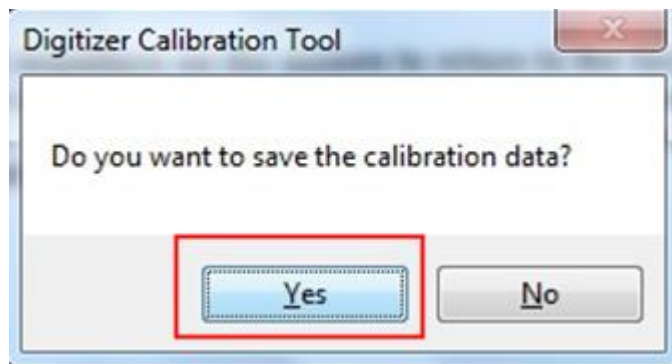

Tips

- To ensure the handwriting accuracy, use the pen provided together with the interactive panel rather a finger to perform calibration.
- Calibration errors may cause failures in touch functions of the interactive panel. In that case, please perform calibration again.
- Tap ESC on the keyboard during the calibration process to cease calibration.
- The calibration interface varies between different software versions. Please follow instructions provided on the actual interface.

3.7 OPS Installation

Insert the OPS into the slot and fasten it with two M4 screws respectively on the top and bottom. Both the standard OPS and non-standard OPS are supported.

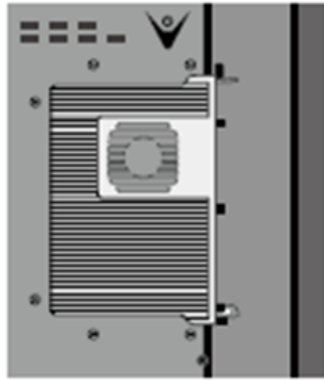

Standard OPS



Non-standard OPS

 **NOTE**

The OPS does not support hot-plugging. Please insert or pull out the OPS after the interactive panel is disconnected from the power supply.

3.8 Select Signal Channel

Press **Source** to display the list of signal sources. Press **▲/▼** to select an option and press **OK** to enter the sub-menu.

If no signal source is available, press **MENU**. In the displayed list, set **Signal Search** to **On**. After 30 seconds, the interactive panel automatically detects signal sources and switches to a signal source. The signal source searching scope and priority sequence is: PC, HDMI1, HDMI2, HDMI3, OPC-PC, Component, AV.

 **NOTE**

- *The panel has signal source memory. Therefore, the panel automatically selects the signal source of last use after it is switched on.*
- *Only when the OPS is inserted, **OPS-PC** is displayed in the **Input Source** list.*



4 Menu

Press **MENU** on the remote controller to display the menu (**TIME**-> **PICTURE**-> **SOUND**-> **OPTION**). Press **▲/▼** to choose a sub-menu and press **OK** to enter the sub-menu. Press **EXIT** to quit the menu.

4.1 Time

Enter the **TIME** menu to display items including **Clock**, **Off Time**, **On Time**, **Sleep Timer**, **Auto Sleep** and **OSD Duration**. Press **▲/▼** to select an item and press **OK** to enter the sub-menu.

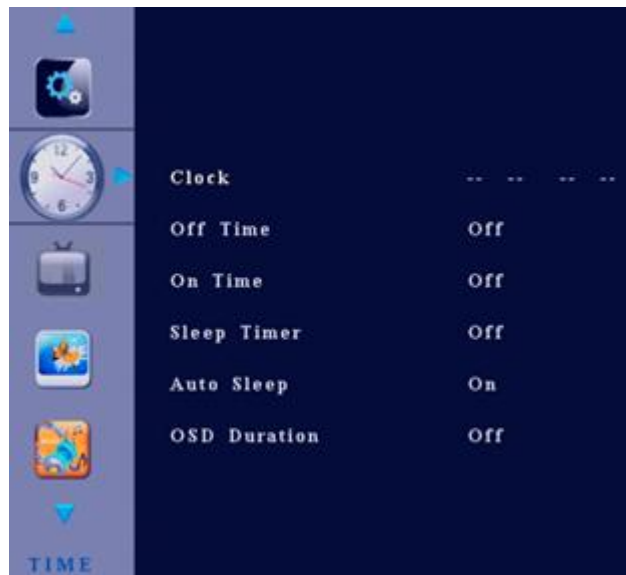

Clock

After you enter the **Clock** sub-menu, the interface shows items including the day, month, year, hour and minute.

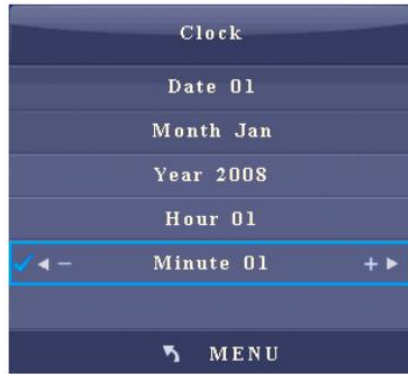

- Press ▲/▼ to select an item.
- Press ◀/▶ to adjust the value of the selected item.
- Press **MENU** to return to the parent menu.
- Press **EXIT** to quit the menu.

Off Time

After you enter the **Off Time** sub-menu, the interface will show items including hour and minute. Press ◀/▶ to change the off time mode: **Once, Everyday, Mon - Fri, Mon - Sat, Sat - Sun, Sunday** and **Off**.



- Press ▲/▼ to select an item.
- Press ◀/▶ to adjust the value of the selected item.
- Press **MENU** to return to the parent menu.
- Press **EXIT** to quit the menu.

On Time

After you enter the **On Time** sub-menu, the interface will show items including hour, minute, signal source, and volume. Press ◀/▶ to change the on time mode: **Once, Everyday, Mon - Fri, Mon - Sat, Sat - Sun, Sunday** and **Off**.

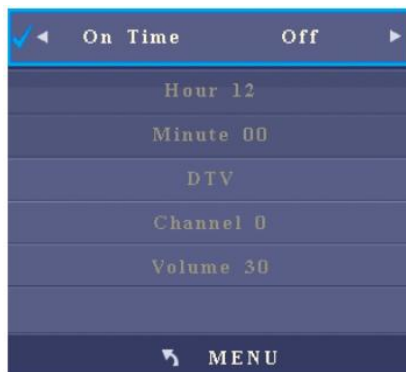

- Press ▲/▼ to select an item.
- Press ◀/▶ to adjust the value of the selected item.
- Press **MENU** to return to the parent menu.
- Press **EXIT** to quit the menu.

Sleep Timer

After you enter the **Sleep Timer** sub-menu, the interface shows **Off**, **10 min**, **20 min**, **30 min**, **60 min**, **90 min**, **120 min**, **180 min**, and **240 min**.

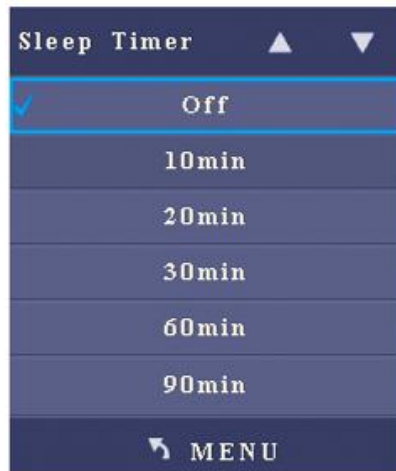

- Press ▲/▼ to select an item.
- Press **MENU** to return to the parent menu.
- Press **EXIT** to quit the menu.

Auto Sleep

After you enter the **Auto Sleep** sub-menu, the interface shows **On** and **Off** options.



- Press ▲/▼ to select an item.
- Press **MENU** to return to the parent menu.
- Press **EXIT** to quit the menu.

OSD Duration

After you enter the **OSD Duration** sub-menu, the interface shows options including **Off**, **5 Sec**, **10 Sec** and **15 Sec**.

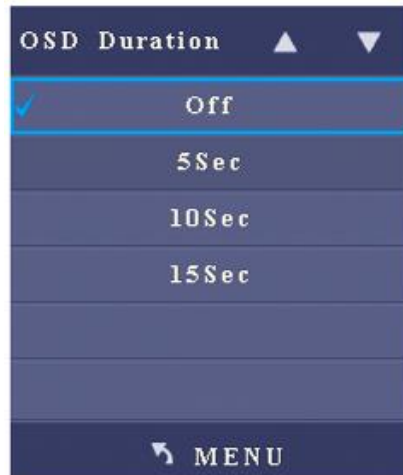

- Press ▲/▼ to select an item.
- Press **MENU** to return to the parent menu.

4.2 Picture

After you enter the **PICTURE** menu, the interface shows options including **Picture Mode**, **Color Temperature**, **Aspect Ratio**, **Noise Reduction**, **Screen**, and **Backlight**. Press ▲/▼ to select an item and **OK** to enter the sub-menu.



Picture Mode

After you enter the **Picture Mode** sub-menu, the interface shows options including **Contrast**, **Brightness**, **Color**, **Sharpness**, and **Tint**. Press ◀/▶ to choose **Standard** – **Mild** – **User** – **Dynamic** image.



- Press ▲/▼ to select an item.
- Press ◀/▶ to adjust the value of the selected item.
- Press **MENU** to return to the parent menu.
- Press **EXIT** to quit the menu.

Note:

The Tint option is only effective when the signal system is NTSC.

Color Temperature

When you enter the **Color Temperature** sub-menu, the interface shows options including **Red**, **Green** and **Blue**. Press ◀/▶ to choose **Medium**, **Warm**, **User** or **Cold**.

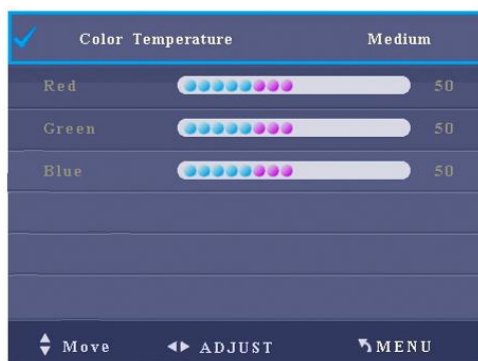

- Press ▲/▼ to select an item.
- Press ◀/▶ to adjust the value of the selected item.
- Press **MENU** to return to the parent menu.
- Press **EXIT** to quit the menu.

Aspect Ratio

After you enter the **Aspect Ratio** sub-menu, the interface shows options including **Auto**, **4:3**, **16:9**, **Zoom 1**, **Zoom 2**, **Just Scan**, and **Panorama**.



- Press ▲/▼ to select an item.
- Press **MENU** to return to the parent menu.
- Press **EXIT** to quit the menu.

Note

Adjustable options may vary under different signal sources.

Noise Reduction

After you enter the **Noise Reduction** sub-menu, the interface shows options including **Off**, **Low**, **Middle**, **High**, and **Default**.



- Press ▲/▼ to select an item.
- Press **MENU** to return to the parent menu.
- Press **EXIT** to quit the menu.

Screen

After you enter the **Screen** sub-menu, the interface shows options including **Auto Adjust**, **Horizontal Position**, **Vertical Position**, **Size** and **Phase**. When **Auto Adjust** is selected, press **OK** to automatically adjust the window. The brighter the surrounding is, the more accurate the automatic adjustment will be.



- Press ▲/▼ to select an item.
- Press ◀/▶ to adjust the value of the selected item.
- Press **MENU** to return to the parent menu.
- Press **EXIT** to quit the menu.

NOTE

The option is only effective when the signal source is PC.

Backlight

When the ECO mode is set to **Standard**, press ◀/▶ to adjust the value. Press **MENU** to return to the parent menu. Press **EXIT** to quit the menu.

Note:

In the ECO and Auto mode, the Backlight option is in grey and cannot be adjusted.

4.3 Sound

After you enter the **SOUND** menu, the interface shows options including **Sound Mode**, **Balance**, **Auto Volume**, **Surround Sound**, **SPDIF MODE**, **EQ**, and **Listen Without Display**. Press ▲/▼ to select an option and **OK** to enter the sub-menu.



Sound Mode

After you enter the **Sound Mode** sub-menu, the interface shows options including **Treble** and **Bass**. Press ◀/▶ to set the **Sound Mode** to **Standard**, **Music**, **Movie**, **Sports** and **User**. When the sound mode is set to **User**:

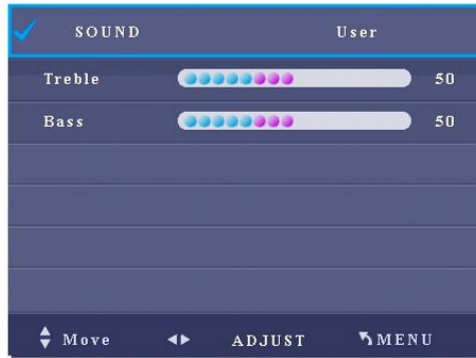

- Press ▲/▼ to select an item.
- Press ◀/▶ to adjust the value of the selected item.
- Press **MENU** to return to the parent menu.
- Press **EXIT** to quit the menu.

Balance

After you enter the **Balance** sub-menu, press ◀/▶ to adjust the value. Press **MENU** to return to the parent menu. Press **EXIT** to quit the menu.

Auto Volume

After you enter the **Auto Volume** sub-menu, the interface shows **On** and **Off** options.

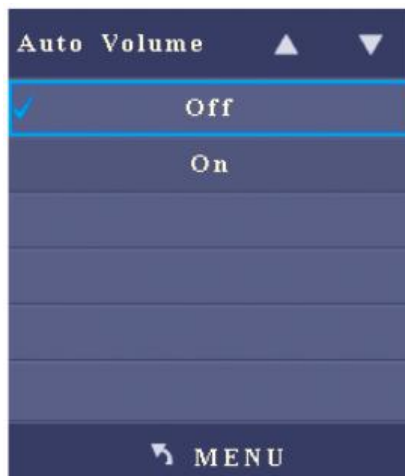

- Press ▲/▼ to select an item.
- Press **MENU** to return to the parent menu.
- Press **EXIT** to quit the menu.

Surround Sound

After you enter the **Surround Sound** sub-menu, the interface shows options including **Off**, **Surround**, and **SRS TruSurround XT**.



- Press ▲/▼ to select an item.
- Press **MENU** to return to the parent menu.
- Press **EXIT** to quit the menu.

SPDIF Mode

After you enter the **SPDIF MODE** sub-menu, the interface shows options including **PCM** and **Auto**.

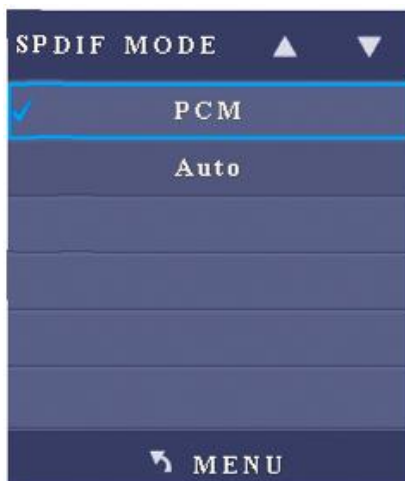

- Press ▲/▼ to select an item.
- Press **MENU** to return to the parent menu.
- Press **EXIT** to quit the menu.

EQ

After you enter the **EQ** sub-menu, the interface shows options including **120Hz**, **500Hz**, **1.2KHz**, **7.5KHz** and **12KHz**. When the EQ mode is set to **User**:

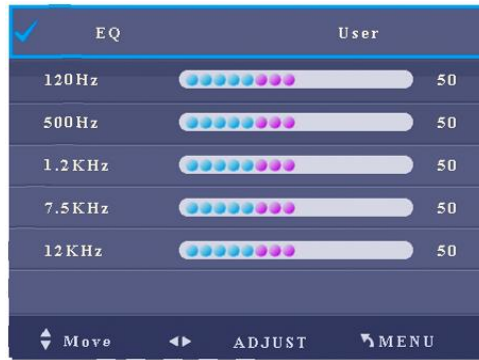

- Press ▲/▼ to select an item.
- Press ◀/▶ to adjust the value of the selected item.
- Press **MENU** to return to the parent menu.
- Press **EXIT** to quit the menu.

Listen Without Display

Press ▲/▼ to switch to **Listen Without Display (Off)** option. Press **OK** and the screen turns black. Press any button on the remote controller under the **Listen Without Display** mode to restore to the normal mode.

4.4 Option

After you enter the **OPTION** menu, the interface shows options including **OSD Language**, **Blending**, **Restore Factory Default**, **Signal Search**, **PowerKey Turn On PC** and **Key Lock**. Press **▲/▼** to select an item and **OK** to enter the sub-menu.



OSD Languages

After you enter the **OSD Language** sub-menu, the interface shows options including **Chinese**, **English** and so on.

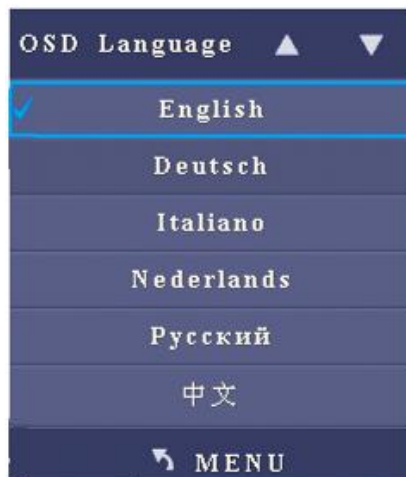

- Press **▲/▼** to select an item.
- Press **MENU** to return to the parent menu.
- Press **EXIT** to quit the menu.

Blending

After you enter the **Blending** sub-menu, the interface shows options including **Off**, **Low**, **Middle** and **High**.



- Press ▲/▼ to select an item.
- Press **MENU** to return to the parent menu.
- Press **EXIT** to quit the menu.

Restore Factory Default

After you enter the **Restore to Factory Default** sub-menu, the interface shows options including **Yes** and **No**. Press ◀ to reset it and ▶ to quit.

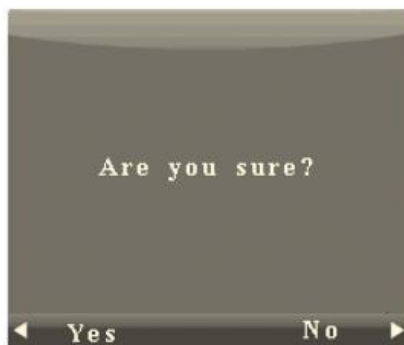

Signal Search

After you enter the **Signal Search** sub-menu, press ▲/▼ to select the signal search item. Press **OK** to enable or disable signal search. When it is **On**, it will automatically search for signals.

Power Key Turn On PC

After you enter the **OPTION** menu, press ▲/▼ to select **PowerKey Turn On PC**. Press **OK** to enable or disable **PowerKey Turn On PC**.

When it is **On**, the OPS computer will be started or shut down when the interactive panel is started or shut down. (Press **Source** and the list of signal sources shows **OPS -PC**.)



When it is **Off**, the OPS computer will not be started when the interactive panel is started. (Press **Source** and the list of signal sources does not show **OPS-PC**.)

Key Lock

- After you enter the **OPTION** menu, press **▲/▼** to select **Key Lock**. Press **OK** to enable or disable **Key Lock**.
 - When **Key Lock** is **On**, the function is enabled.
 - When **Key Lock** is **Off**, the function is disabled.
- You can also press **Menu** and **Vol +** on the front panel over two seconds to switch on or off the key lock.

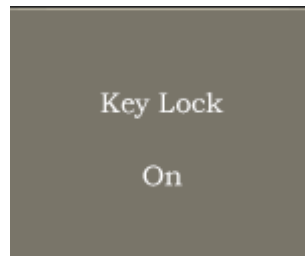

5 Multi-Media

Press **Source** on the remote controller to display the list of signal sources. Press **▲/▼** to switch to **DMP** signal channel. Press **OK** to enter the channel.

After you enter the multi-media signal source, the interface shows options including **PHOTO**, **MUSIC**, **MOVIE** and **TEXT**. The color of the USB icon indicates if USB is detected. Blue means USB is detected. Grey means no USB is detected.

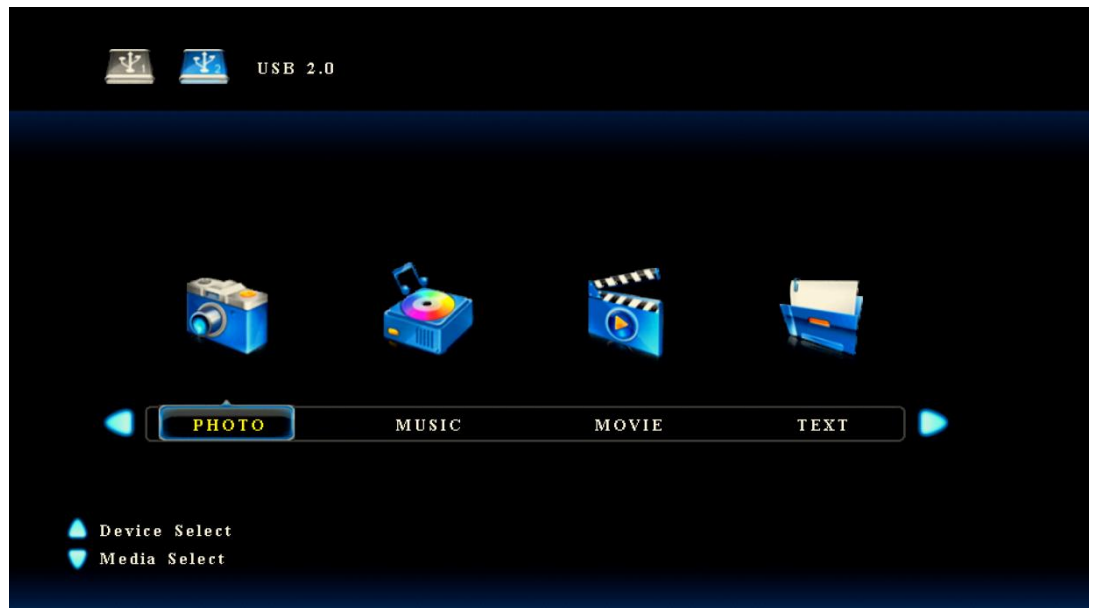

- Press **▲/▼** to select flash disk.
- Press **◀/▶** to select the type of content to be played.
- Press **OK** to enter the category.
- Press **EXIT** to return to the main menu.

When USB is detected, press **OK** to show content in the flash disk.

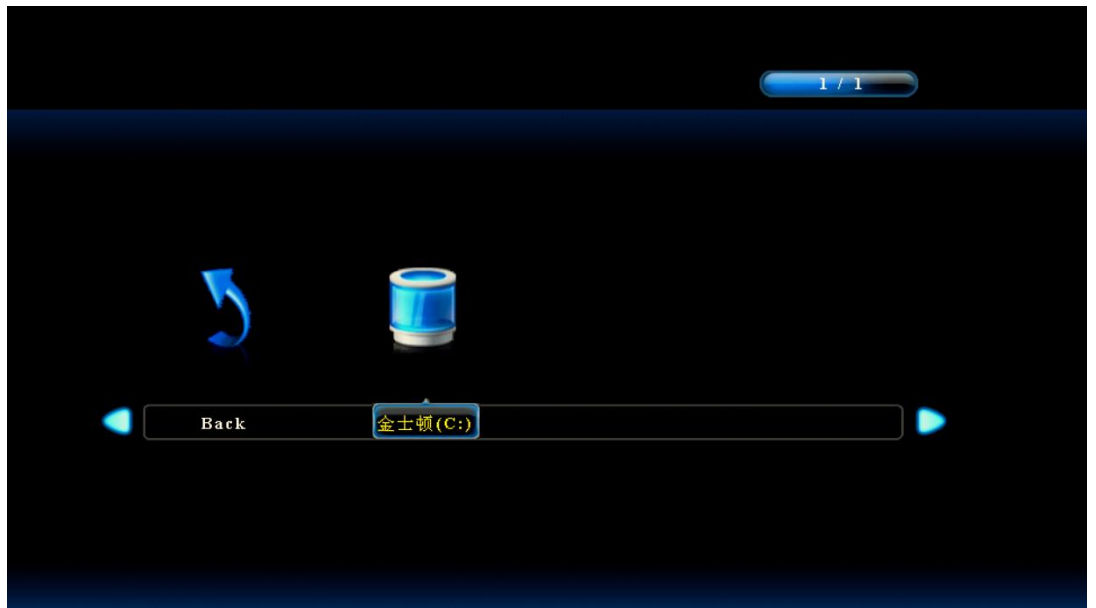

Photo

After you enter **PHOTO** option, press **▲/▼/◀/▶** to select images to be displayed. Press **OK** to select or de-select an image. Press **▶II** to start or stop displaying.

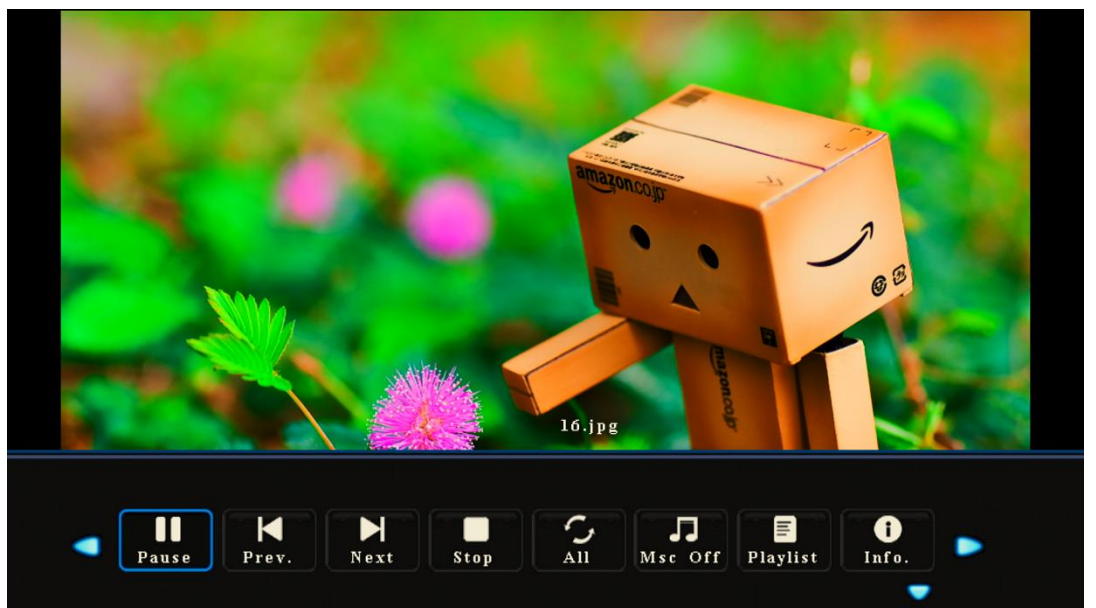

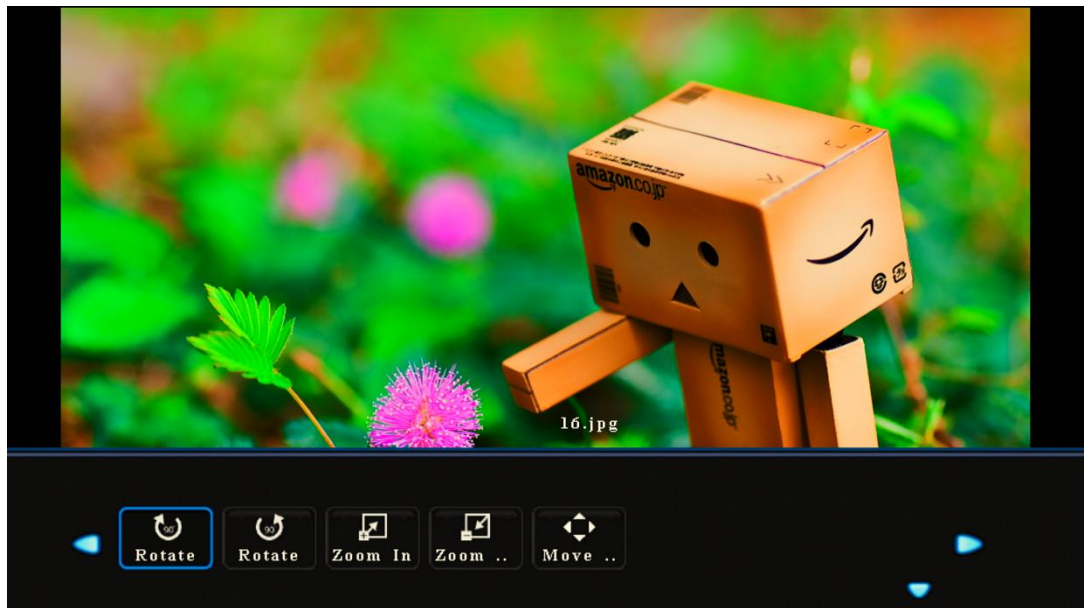

- Press **DISPLAY** to show the operation function menu. Press ◀/▶ to select a function and press **OK** to use the function.(The functions include: Play/Pause, Previous, Next, Stop, All, Music Off, Playlist, Information, Clockwise Rotation, Counterclockwise Rotation, Zoom In, Zoon Out, and Move.)
- Press **I**◀◀ to display the previous image and ▶▶**I** to display the next image.
- Press ◀◀ to change the fast reverse speed and ▶▶ to change the fast forward speed.
- Press **EXIT** to quit playing.

Music

After you enter **MUSIC** option, press ▲/▼/◀/▶ to select music to be played. Press **OK** to select or de-select a song. Press ▶**II** to start or stop playing and shortcut buttons on the remote controller to use relevant functions.

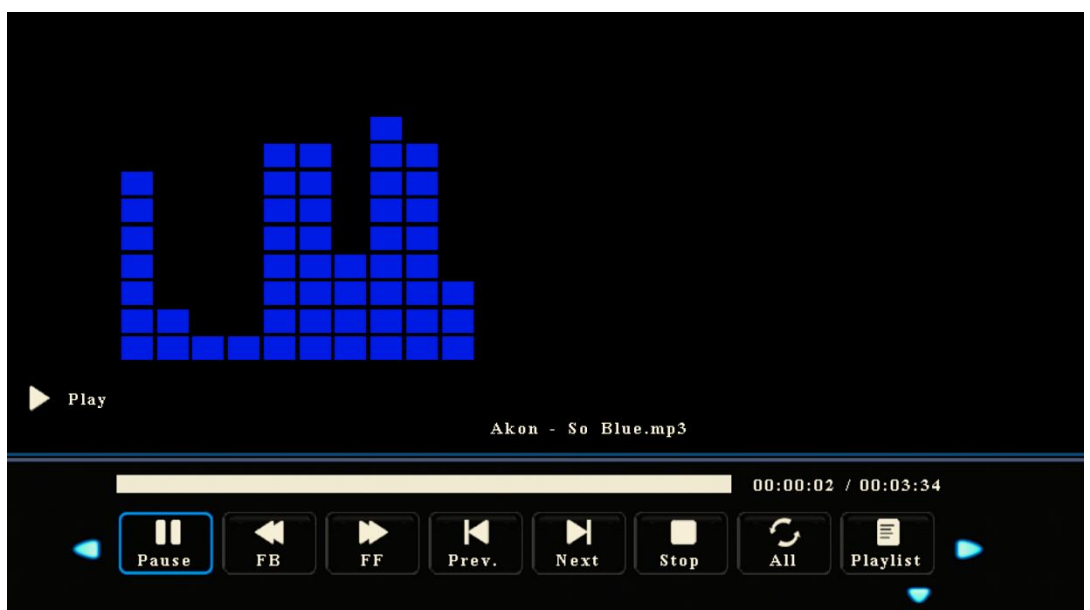



- Press **DISPLAY** to show the operation function menu. Press **◀/▶** to select a function and press **OK** to use the function.

(The functions include: Play/Pause, Fast Reverse, Fast Forward, Previous, Next, Stop, All, Playlist, Information, and Jump To.)
- Press **I◀◀** to play the previous song and **▶▶I** to play the next one.
- Press **◀◀** to change the fast reverse speed and **▶▶** to change the fast forward speed.
- Press **EXIT** to quit playing.

Movie

After you enter **MOVIE** option, press **▲/▼/◀/▶** to select movies to be displayed. Press **OK** to select or de-select a movie. Press **▶II** to start or stop playing.

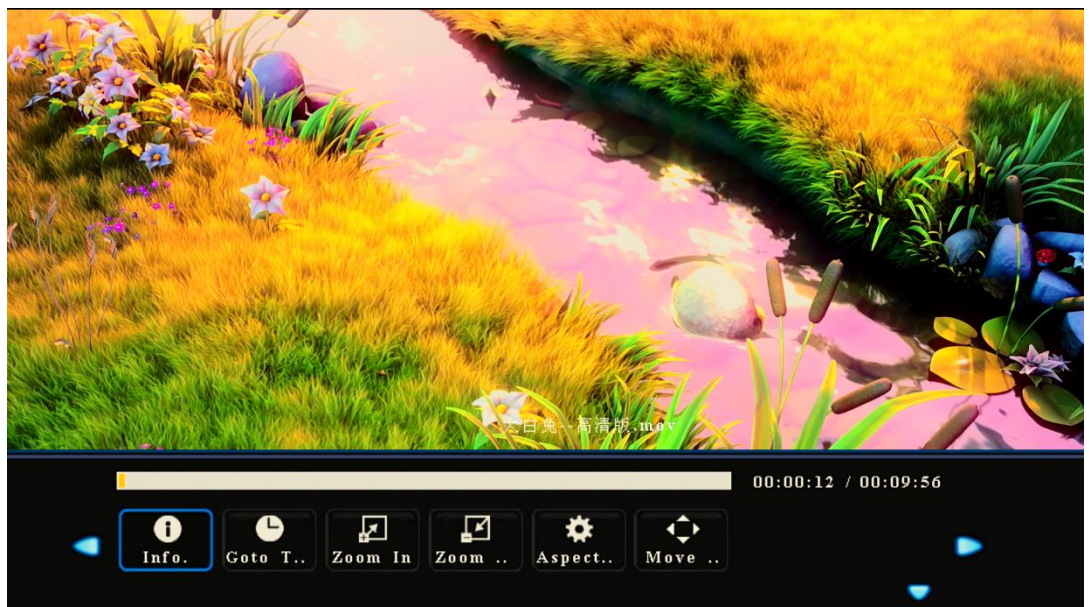
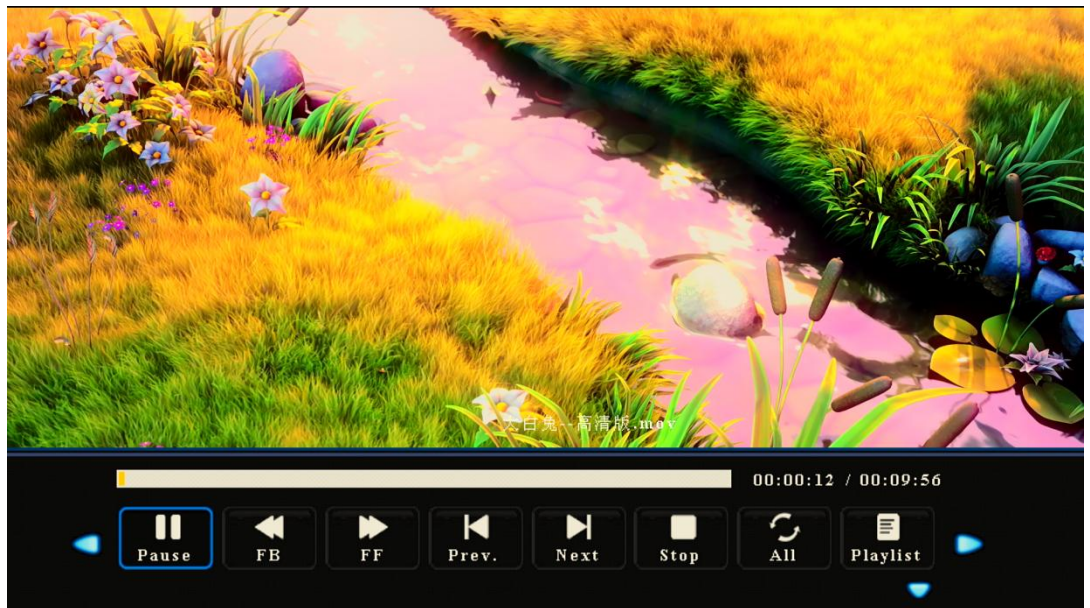

- Press **DISPLAY** to show the operation function menu. Press ◀/▶ to select a function and press **OK** to use the function.
- Press ◀/▶ to select a function and press **OK** to use the function. (The functions include: Play/Pause, Fast Reverse, Fast Forward, Previous, Next, Stop, All, Playlist, Information, Zoom In, Zoon Out, Zoom Down, Zoom Mode, and Move.)
- Press **EXIT** to quit playing.

Text

After you enter **EXIT** option, press ▲/▼/◀/▶ to select files to be displayed. Press **OK** to select or de-select a file. Press ▶|| to start or stop displaying.

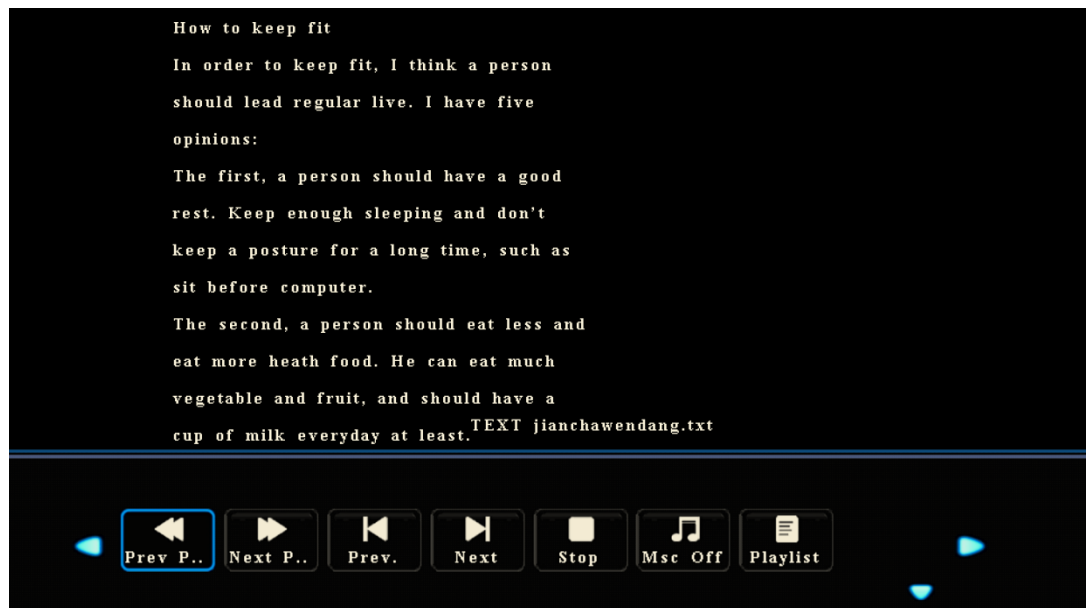

- Press **DISPLAY** to show the operation function menu. Press ◀/▶ to select a function and press **OK** to use the function.
(The functions include: Previous Page, Next Page, Previous, Next, Stop, Music Off, and Playlist.)
- Press **EXIT** to quit playing.

6 ECO Mode

Press **ECO** on the remote controller to enter the ECO mode (**Standard-Power Save-Auto Backlight**). Hold the button to switch between the three modes.

- Under the **Standard** mode, you can select the **Backlight** item on the **PICTURE** menu and press ◀/▶ to adjust the backlight.
- Under the **Power Save** mode, the display will darken.
- Under the **Auto Backlight** mode, the display will automatically adjust the backlight according to the intensity of light from the environment. When the surrounding light is strong, the screen will bright up. When the surround light is weak, the screen will darken.



NOTE

To save energy, please switch off the panel when it is idle. You can also lower the brightness of the display to decelerate the consumption of power.

7 Serial Port Control

The RS-232 port of the interactive panel is defined as follows:

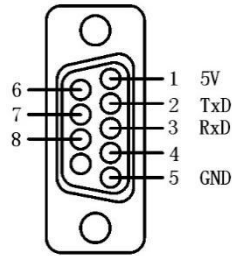

Connect RS-232 port to the PC or controlling device. Enable RS-233 serial port connection and complete the following configuration.

Port: COM1 (Set according to PC or controlling device's port number)			
Bit rate	19200	Odd/even check	None
Data bits	8	Stop bit	1

The following table lists button controlling codes. The buttons share same functions with corresponding buttons on the remote controller:

Function	Controlling codes	Function	Controlling codes
Power on	7F 08 99 A2 B3 C4 02 FF 01 00 CF	Power off	7F 08 99 A2 B3 C4 02 FF 01 01 CF
Mute	7F 08 99 A2 B3 C4 02 FF 01 02 CF	Sound mode	7F 08 99 A2 B3 C4 02 FF 01 05 CF
Signal source	7F 08 99 A2 B3 C4 02 FF 01 06 CF	ATV	7F 08 99 A2 B3 C4 02 FF 01 08 CF
Display status	7F 08 99 A2 B3 C4 02 FF 01 09 CF	HD 1	7F 08 99 A2 B3 C4 02 FF 01 0A CF
HD 2	7F 08 99 A2 B3 C4 02 FF 01 0B CF	HD 3	7F 08 99 A2 B3 C4 02 FF 01 0C CF
OPS computer	7F 08 99 A2 B3 C4 02 FF 01 38 CF	Computer	7F 08 99 A2 B3 C4 02 FF 01 0D CF
DTV	7F 08 99 A2 B3 C4 02 FF 01 0F CF	YPbPr	7F 08 99 A2 B3 C4 02 FF 01 10 CF
Video 1	7F 08 99 A2 B3 C4 02 FF 01 11 CF	Listen Alone	7F 08 99 A2 B3 C4 02 FF 01 15 CF

Function	Controlling codes	Function	Controlling codes
ECO	7F 08 99 A2 B3 C4 02 FF 01 16 CF	Volume-	7F 08 99 A2 B3 C4 02 FF 01 17 CF
Volume+	7F 08 99 A2 B3 C4 02 FF 01 18 CF	Channel-	7F 08 99 A2 B3 C4 02 FF 01 19 CF
Channel+	7F 08 99 A2 B3 C4 02 FF 01 1A CF	Menu	7F 08 99 A2 B3 C4 02 FF 01 1B CF
Return(quit)	7F 08 99 A2 B3 C4 02 FF 01 1D CF	Auto ADJ	7F 08 99 A2 B3 C4 02 FF 01 20 CF
1	7F 08 99 A2 B3 C4 02 FF 01 21 CF	2	7F 08 99 A2 B3 C4 02 FF 01 22 CF
3	7F 08 99 A2 B3 C4 02 FF 01 23 CF	4	7F 08 99 A2 B3 C4 02 FF 01 24 CF
5	7F 08 99 A2 B3 C4 02 FF 01 25 CF	6	7F 08 99 A2 B3 C4 02 FF 01 26 CF
7	7F 08 99 A2 B3 C4 02 FF 01 27 CF	8	7F 08 99 A2 B3 C4 02 FF 01 28 CF
9	7F 08 99 A2 B3 C4 02 FF 01 29 CF	0	7F 08 99 A2 B3 C4 02 FF 01 2A CF
OK	7F 08 99 A2 B3 C4 02 FF 01 2B CF	←	7F 08 99 A2 B3 C4 02 FF 01 2C CF
→	7F 08 99 A2 B3 C4 02 FF 01 2D CF	↑	7F 08 99 A2 B3 C4 02 FF 01 2E CF
↓	7F 08 99 A2 B3 C4 02 FF 01 2F CF	USB Multi-media	7F 08 99 A2 B3 C4 02 FF 01 3A CF
Freeze	7F 08 99 A2 B3 C4 02 FF 01 3B CF	-	-

8 Specifications of PC Mode (VGA Input)

SN	Standard	Resolution	Refresh Rate (Hz)	Horizontal Frequency (Khz)	Vertical Frequency (Hz)	Horizontal/ Vertical Sync Polarity (TTL)
1	VESA	640x480	60	31.5	60	N/N
2	VESA	640x480	72	37.9	72	N/N
3	VESA	640x480	75	37.5	75	N/N
4	VESA	800x600	56	35.1	56	P/P
5	VESA	800x600	60	37.9	60	P/P
6	VESA	800x600	72	48.1	72	P/P
7	VESA	800x600	75	46.9	75	P/P
8	VESA	1024x768	60	48.4	60	N/N
9	VESA	1024x768	70	56.5	70	N/N
10	VESA	1024x768	75	60	75	N/N
11	VESA	1280x960	60	60	60	N/N
12	VESA	1280x960	75	75.159	75	N/N
13	VESA	1280x1024	60	64	60	P/P
14	VESA	1280x1024	75	80	75	P/P
15	VESA	1600x1200	60	75	60	P/P
16	VESA	1920x1080	60	66.547	59.988	P/P

9

Formats Supported by Multi-media

Media category	Formats	Extension
Photo	Progressive JPEG, Baseline JPEG, Non-Interlaced, Interlaced	.jpg, .jpeg, .bmp, .png
Movie	MPEG1, MPEG2, MPEG4, H.264, RV8, RV9, RV10, RV8-LBR, MJPEG, DivX, Xvid	.avi, .mpg, .dat, .vob, .mov, .mkv, .rm, .rmvb, .mp4, .ts, .trp
Music	WMA, MP3, AAC	.wma, .mp3, .m4a, .aac
Text	TXT	.txt

10 FAQ & Troubleshooting

Before you contact the technical support staff, please identify a fault according to the following table. If the fault cannot be restored based on the solutions, contact the local distributor for help. For your safety, please do not repair the product by your own.

Failure	Possible Cause	Solution
The service program fails to be connected.	The drive program is not correctly installed.	Install the drive program correctly.
	The USB port (lead) is not connected or is faulty.	Change the USB lead or check if the USB port is faulty.
	The infrared tube is blocked.	Ensure that the surrounding infrared tubes are not blocked.
Repositioning is required every time the panel is switched on.	The computer is equipped with a recovery card.	Disable computer protection and perform the positioning again.
The calibration is inaccurate.	The positioning is not performed properly.	Press AUTO on the remote controller to show the full screen, and use the pen provided with the panel to perform positioning again.
The cursor of the pen is unstable when the pen is used.	The writing method is incorrect.	You are advised to use the pen rather than a finger to write. Hold the pen as far to the nib as possible. The angle between the pen and display needs to be greater than 60 degrees. Do not touch the display with your sleeve or wrist.
	Strong light or infrared interference exists.	Remove the interference source or change the using environment.
The handwriting is discontinuous.	The writing method is incorrect.	You are advised to use the pen rather than a finger to write. Hold the pen as far to the nib as possible. The angle between the pen and display needs to be greater than 60 degrees. Do not touch the display with your sleeve or wrist.
	The covering area of the nib does not meet the requirement or the nib is too small.	Change the nib or use a pen with larger covering area.
	The infrared tube is blocked.	Check if infrared tubes are blocked.

Failure	Possible Cause	Solution
	Strong light or infrared interference exists.	Remove the interference source or change the using environment.
Unable to write	The color of the pen is the same as or similar to the background color.	Change the color of the pen.
	You hand or other objects are on the display when you are writing.	You are advised to use the pen rather than a finger to write. Hold the pen as far to the nib as possible. The angle between the pen and display needs to be greater than 60 degrees. Do not touch the display with your sleeve or wrist.
	Strong light or infrared interference	Remove the interference source or change the using environment.
	The writing method is incorrect.	You are advised to use the pen rather than a finger to write. Hold the pen as far to the nib as possible. The angle between the pen and display needs to be greater than 60 degrees. Do not touch the display with your sleeve or wrist.
Not sound and image	<ul style="list-style-type: none"> • Check whether the power plug is inserted into the power socket and whether the panel is powered on. • Check whether the rocker switch on the interactive panel is switched on. • Check whether the standby button on the panel is pressed. • Check whether the video and audio input cables are connected correctly. • Check whether the panel is switched to the right signal source. • Check the settings on image brightness and contrast. • Check the volume. 	
Image is normal, but no sound	<ul style="list-style-type: none"> • Check the volume. • Check whether the MUTE button on the remote controller is pressed. • Check whether the audio cable between the PC and interactive panel is connected correctly. 	
No image or the image is black and white	<ul style="list-style-type: none"> • Modify the color settings. • Check the color system. 	
Image or sound is interrupted	<ul style="list-style-type: none"> • Find out the electric appliance that causes the interference and move it away from the interactive panel. • Do not share the power socket of the panel with the electric appliance that causes interference. 	

Failure	Possible Cause	Solution
The remote controller fails	<ul style="list-style-type: none"> • Change the batteries. • Clean the signal emitter at the top of the remote controller. (Check whether it is blocked.) • Check contacts of the batteries. 	
Computer cannot be started (applicable for models with computers)	<ul style="list-style-type: none"> • Check whether the PC adapter is correctly connected and whether the PC is powered on. • Check whether the PC is connected correctly to the interactive panel. 	

The following symptoms are not faults:

- A very few of constantly bright or dark pixels, such as tiny red, blue, green or dark points, may exist on the LCD. This symptom is not a fault and does not affect running functions of the panel.
- Slight sound may occur due to the backlight adjustment or ventilation. This is a normal symptom.
- The image and sound are normal. However, you can sense static electricity when you touch the LCD and metal back cover. This is a normal symptom.

11 Maintenance Tips

- Do not put or install the product near a heat source or under direct sunlight, or in dusty or humid places, or somewhere the product may be hit or damaged by mechanical vibration. To maximize the performance, it needs to be put away from equipment such as grid, large metal objects and radar stations as far as possible.
- Do not wipe the panel with any chemical reagent. Solvents may damage the enclosure or paint. If the panel is stained by dust, cut off the power and then clean the panel using a dried cloth with a little of warm water. Use a clean soft cloth to clean the LCD of the panel.
- Do not frequently switch on and off the product, which may shorten the product service life. After the panel is switched off, wait for three minutes before switching it on again. If the product is not to be used for a long period of time, please power off the product and pull out the power plug.
- Do not maximize the brightness and contrast of the LCD for a long period of time, which may shorten the LCD service life.
- Do not use a hard object to write on the touch screen, which may scratch the LCD.

12 Clean the Infrared Tube

The interactive panel uses the horizontal and vertical infrared matrix to detect and locate the user's touch. The screen is surrounded by an infrared tube (including the infrared acceptor and emitter), which forms an infrared net covering on the screen surface. When a user touches the screen, fingers or other opaque objects block the infrared rays that cross the touch point, which helps the controller detect the coordinate position of the touch point.

Dust is easily retained on the screen surface due to its long-term exposure in the air and causes ineffective touch or inaccurate positioning. Therefore, you need to clean the infrared tube around the screen regularly.

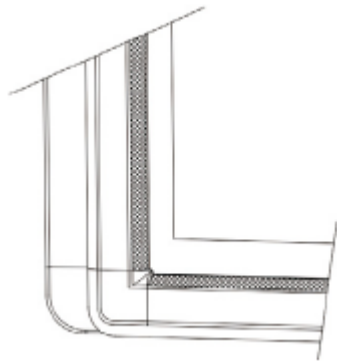

13 Technical Parameters

Specification	Parameter
Backlight type	LED
Aspect ratio	16:9
Viewing angle	178 °
Physical resolution	1920x1080 Pixel
Image/Sound system	PAL/DK, I
Working voltage	100~240V, 50/60Hz
Standby power consumption	≤0.5W
Audio output	Loudspeaker power output 15 W*2
Touch screen material	Tempered glass
Sensing method	Infrared
Technical feature	HID drive-free
Touch point	Multi-touch
Writing method	Finger or pen
Resolution of touch screen	32767*32767
Communication interface	USB
Storage temperature/humidity	-20 ℃ - 60 ℃, 10% - 90%
Working temperature/humidity	5 ℃ - 50 ℃, 10% - 90%
Installation method	Wall-mounted or moveable

- * Hitevision may modify the user manual without prior notice.
- * If you discover any unclear presentation, mistake or omission in this manual, please contact us immediately. Hitevision is not liable for any loss or damage if you fail to contact us.