

LED Interactive Multi-Touch Display User Manual



V901.20150420 Please properly keep the manual for further reference. This is the general user manual for all interactive panels. Therefore, it may be different from the actual product.

Welcome:

Thanks for purchasing this product. Please read the instructions carefully before using this product.

This device complies with part 15 of the FCC Rules. Operation is subject to the following two conditions: (1) This device may not cause harmful interference, and (2) this device must accept any interference received, including interference that may cause undesired operation. changes or modifications not expressly approved by the party responsible for compliance could void the user's authority to operate the equipment.

This equipment has been tested and found to comply with the limits for a Class B digital device, pursuant to part 15 of the FCC Rules. These limits are designed to provide reasonable protection against harmful interference in a residential installation. This equipment generates, uses and can radiate radio frequency energy and, if not installed and used in accordance with the instructions, may cause harmful interference to radio communications. However, there is no guarantee that interference will not occur in a particular installation. If this equipment does cause harmful interference to radio or television reception, which can be determined by turning the equipment off and on, the user is encouraged to try to correct the interference by one or more of the following measures:

- Reorient or relocate the receiving antenna.
- Increase the separation between the equipment and receiver.
- Connect the equipment into an outlet on a circuit different from that to which the receiver is connected.
- Consult the dealer or an experienced radio/ TV technician for help.

The symbol of the crossed out wheeled bin indicates this product should not be placed in municipal waste. Instead, you need to dispose of the waste equipment by handing it over to a designated collection point for the recycling of waste electrical and electronic equipment.



Contents

Safety Instruction	5
1 Installation Requirement	8
2 Introduction	10
3 Basic Operation	19
3.1 Power on.....	19
3.2 Power off.....	20
3.3 Software Installation.....	21
3.4 Software Uninstall	21
3.5 Software Positioning.....	22
3.6 Positioning in the Windows 7 System	24
3.7 OPS Installation.....	26
4 Toolbar Introduction	27
4.1 Home Page.....	27
4.2 Task Manager.....	29
4.3 White Board.....	31
4.4 Gallery	33
4.5 File Manager.....	35
4.5.1 File Preview	35
4.5.2 File Filter	37
4.5.3 File Search	38
4.5.4 File Operations.....	40
4.6 System Settings.....	40
4.6.1 Network	41
4.6.2 Language and Input Method	50
4.6.3 Date and Time.....	52
4.6.4 Timer Switch.....	54
4.6.5 Clear Screenshots.....	56
4.6.6 Printer	57
4.6.7 Storage.....	57
4.6.8 Application Program.....	58
4.6.9 Starting Signals.....	59

4.6.10 Smart Eyes Protection.....	60
4.6.11 Reset	61
4.7 Browser.....	62
4.8 Audio Only	63
4.9 Kids Safety Lock	63
4.10 Application Programs	65
4.11 Temperature Reminder and Thermal Shutdown.....	67
5 Signal Channel Selection	69
6 Menu.....	70
7 ECO Mode	73
8 Serial Port Control	74
9 VGA Signal Input	76
10 Multimedia Format Support.....	77
11 Common Faults and Solutions	78
12 Care and Maintenance.....	81
13 Technical Parameters.....	82

Safety Instruction

For your safety, please read the following instruction before you use the product. Serious injury or property loss may be caused by improper operations. Do not try to repair the product by your own.



WARNING



Disconnect the product from power supply immediately if major failures occur.

The major failures include the following:

- Smoke, peculiar smell or abnormal sound is discharged from the product.
- No image or sound is displayed, or the image error occurs.
- Where the mains plug or an appliance coupler is used as the disconnect device the disconnect device shall remain readily operable.

In the preceding scenarios, do not continue to use the product, disconnect power supply immediately and contact professional staff for troubleshooting.



Do not drop liquid, metal or combustible into the product.

- If any liquid or metal is dropped into the product, power off the product and disconnect power supply, then contact professional staff for solutions.
- Pay attention to the children when they are close to the product.

Do not damage the power cable.

- Do not damage, change, wind, bend, heat or drag the power cable forcibly.
- Do not put weights (such as the product itself) on the power cable.
- Do not drag the cable forcibly when you pull out the power plug. If the power cable is damaged, please contact the local distributor to repair or replace it.

Put the product on a stable surface.

An unstable surface includes and does not limited to an inclined plane, a shaky stand, desk or platform, which might cause the turnover and damage.

Use the battery correctly.

- Galvanic corrosion, electric leakage and even fire may be caused by improper battery usage.
- It is recommended to use the designated type of battery and install the battery by correct electrodes (positive and negative electrodes).
- Do not install and use new battery with the used one.
- Take out the battery if the remote control is not used for a long period.
- Do not expose the battery under overheated environments such as sunlight and firing.
- Dump the used battery based on local regulations.



WARNING



Do not open the cover or change the product by your own.

High voltage components are installed in the product. When you open the cover, high voltage, electric shock or other dangerous situations may occur. If inspection, adjustment or maintenance is required, contact the local distributor for help.



Use the specified power supply.

- Do not use any types of power cables other than the one provided with the product to prevent the product from being damaged.
- Use a three-wire socket and ensure that it is properly grounded.
- Pull out the power plug from the socket if the product is not used for a long period.

Before you move the product, disconnect all external connections and separate all toppling preventing devices.

Move the product carefully to prevent it from being hit or squeezed, especially the screen, which may cause injury if broken.

Clean the dust and metal on the power plug regularly.

- When you are cleaning, fire or electric shock may be caused if the product is powered on.
- Keep in mind to pull out the power plug before cleaning it by using a dried cloth.



Do not put items on the top of the product.

- Do not put items, such as a container for liquid (a vase, flowerpot, cosmetics or liquid medicine), on the top of the product.
- If any water or liquid is spilled on the product, short circuit may occur and cause fire or electric shock.
- Do not tread on the product or hang any items on the product.



Do not install the product in an improper place.

- Do not install the product in humid places, such as the bathroom, the shower room, the place near windows or outdoor environments where experience rain, snow or other harsh weather. The product installation is also required to avoid a place around by hot spring vapor. The preceding environments may cause faults or electric shock under extreme conditions.
- Do not put exposed fire source, such as an ignited candle, on the product.



Pull out the power plug during thunderstorms.

- Do not touch the product when lightning to avoid electric shock.
- Install or place components which power supply voltage is high enough to cause personal injury in places out of the reach of children.



Do not cover or block up any vents on the product.

- The overheated components may cause fire, damage the product and shorten the service life.
- Do not put the venting surface of the product facedown.
- Do not install the product on a carpet or bed clothes.
- Do not use a cloth such as table cloth to cover the product.



WARNING



Do not touch the power cable with wet hands to avoid electric shock.



CAUTION



Do not install the product in high temperature environments.

- Do not install the product near heat source, such as the radiator, the heat reservoir, the stove or other heating devices.
- Do not expose the product under sunlight, which may cause high temperature and subsequent faults in the product.



For transport:

- Pack the product for mobility or maintenance by using the cartons and cushioning material provided with the product.
- Vertically move the product during transport. The screen or other components are easily broken if the product is moved by an improper way.



Keep away from the product when you use a radio.

The product design to prevent radio interference complies with the international EMI standard. However, the interference still exists and causes noise in the radio.

- If noise occurs in the radio, try the following solutions.
- Adjust the direction of the radio antenna to avoid the interference from the product.
- Keep the radio away from the product.

Advice for watching:

- Use the product in an environment with comfortable light. It is harmful to your eyes to watch in a too bright or too dark environment.
- Relax your eyes after a period of time for watching.
- When you are watching, the distance which is 3 to 7 times of the screen height should be kept, and it is the best distance to protect eyes and prevent eyestrain.
- Adjust the volume to an appropriate level, especially at night.
- Use amplifier equipment as the audio input source with caution. If you must use amplifier equipment, the input power should not exceed the maximum of speaker power. Otherwise, problems occur, such as the speaker is overpowered and damaged.

1 Installation Requirement

Bearing

You can install the product in an unfixd or a wall-mounted way based on your needs. The wall-mounted way can save a large amount of space.

If the product is installed in an unfixd way, use the designated hanger or holder. If you want to use a self-made hanger or holder, ensure that the bearing capacity of it is at least four times of the weight of the product, and the product is installed stably on it.

If the product is installed in a wall-mounted way, the bearing capacity of the surface for installation must be at least four times of the weight of the product. If the surface for installation is the wall or the ceiling of a building, the surface must be made of solid bricks, concrete or other materials with equal intensity. If the product is installed on a surface made of loose material such as an old brick wall, wood plank wall, solid brick wall, or a metal or non-metal structure surface, or a surface with a thick decoration layer, take necessary consolidating measures to ensure that the product is stably installed.

Ventilation

Ventilation requirements	Distance to the surface for installation (cm)			
	Left and right sides	Top	Bottom	Back
Nominal power				
Greater than 100 W	10	20	20	10



WARNING

If the product is installed inside a wall or a cabinet, in addition to the preceding requirements, the ventilation area around the bottom, top and two sides must be at least 50% of the sealing surface to ensure proper ventilation.

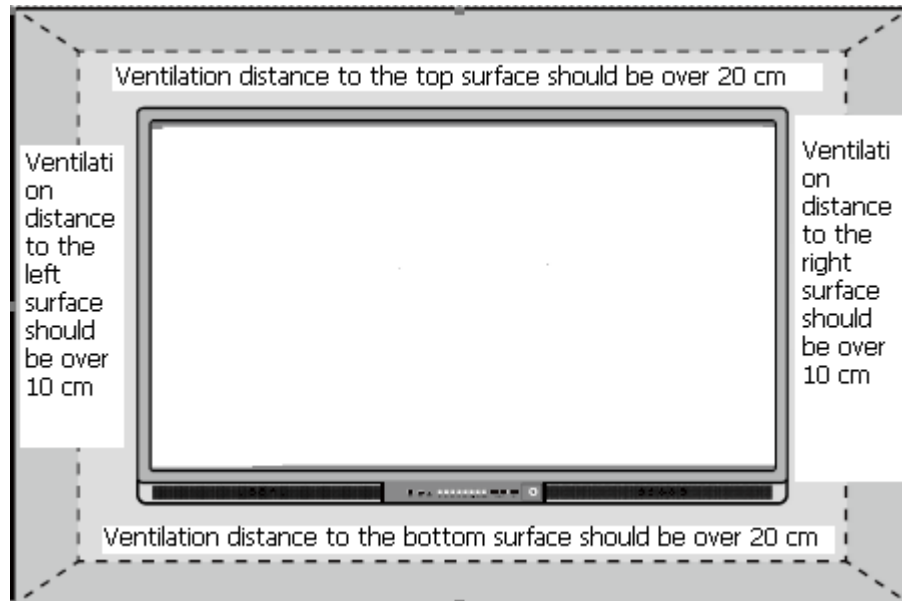

 **NOTE**

- When the product is installed in a wall-mounted way, the screws need to be installed deeper than 10 mm in the wall.
- Do not block ventilation vents.
- See the installation standard of CAS 132-2006 for reference.

2 Introduction

Thank you for choosing our interactive touch screen. As our latest independently developed and produced human-machine interactive product, the hitevision interactive touch screen is a multi-functional display for interactive teaching, digital demonstration, multi-media presentation, touch operations and handwriting. They are well designed and produced to meet the needs of education and corporate applications, and provide a user-friendly experience, digital intelligent control as an ideal equipment for schools and companies. You can use your fingers or opaque objects to write, edit and delete any things on the screen.

The product features are as follows:

- Specially designed for teaching and meeting systems.
- Adopt advanced infrared array scanning and sensing technology, HID driver-free, meaning the product is activated soon after it is powered on.
- Multi-signal sources can be previewed in the window and be switched by touching the screen.
- A special button is set to adjust the brightness automatically with no impact on watching and save up to 50% energy.
- Support front-facing high-power amplifiers.
- When the screen display function is disabled, the product can still play audio to save energy.
- Sense the illumination and brightness automatically to adjust the screen backlight so that the most comfortable screen brightness can be displayed to teachers and students.
- The interactive lesson preparation and teaching system uses a new separation mode of lesson preparation and teaching, which provides a large number of tools for teacher to assist teaching and improve class interaction.

Outer Appearance

The front view and back view of the product are displayed as follows.

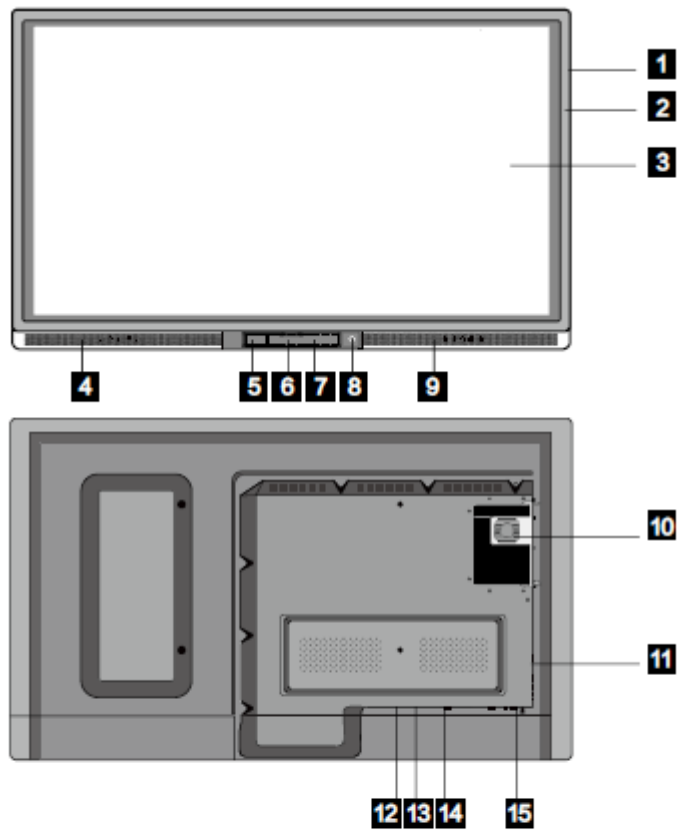

- | | | |
|-----------------------------|-----------------------------|-------------------------------------|
| 1 Enclosure | 6 Front Cover Plate* | 11 Connection Panel 2 |
| 2 Infrared Frame | 7 Control Panel | 12 Temperature Control Reset |
| 3 Screen | 8 Power on/off | 13 Rocker Switch |
| 4 Left Loudspeaker | 9 Right Loudspeaker | 14 Power Outlet |
| 5 Connection Panel 1 | 10 OPS Port | 15 Connection Panel 3 |

 **NOTE**
 “*” indicates optional.

Control Panel

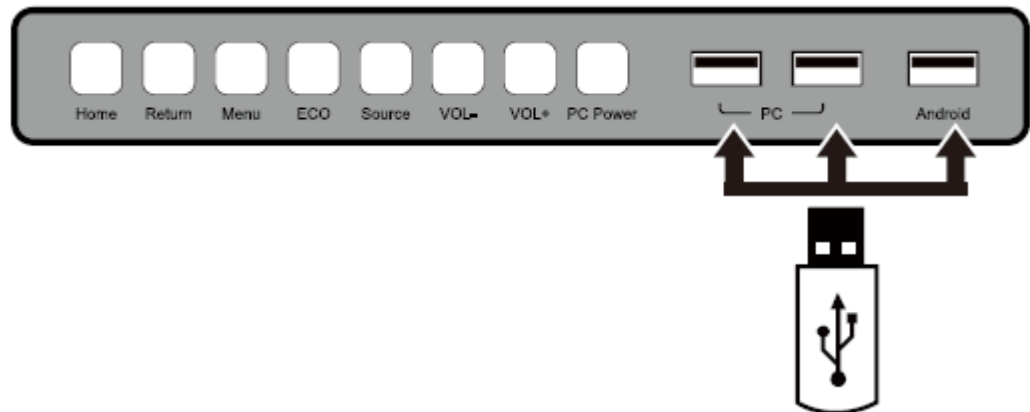

Name	Function Description
Home	Enter/Exit the Android home page.
Return	Return to previous menu.
Menu	Enter/Exit the function menu of screen.
ECO	Switch among three modes: energy-saving, automatic, and standard.
Source	Enter the menu to select the signal source.
VOL-	Decrease volume.
VOL+	Increase volume.
PC Power	Power on or off the OPS.
PC	The USB 2.0 and USB 3.0 ports for the OPS.
Android	Android USB port.

Connection Panel 1

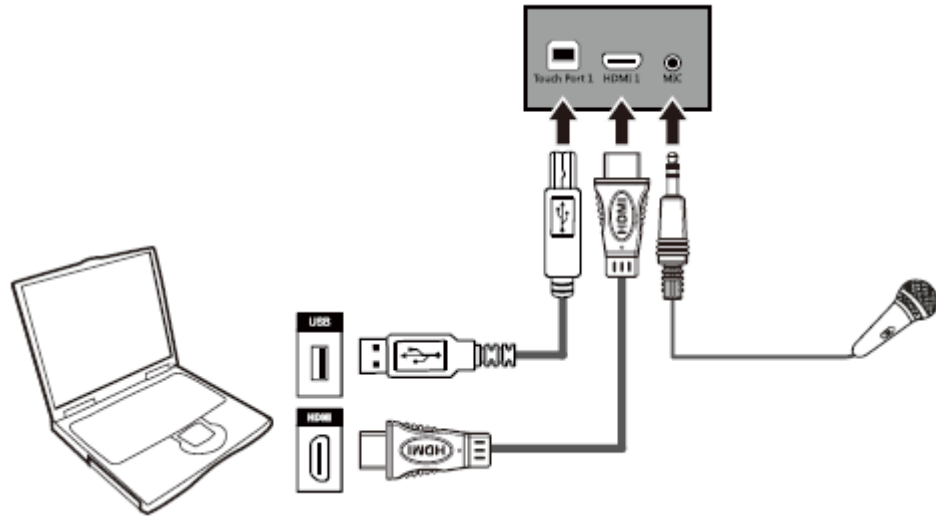

Name	Function Description
Touch Port 1	The touch control terminal 1 which is used to connect to a PC.
HDMI 1	The input terminal 1 for high definition signal, which is used with the touch port 1 to operate PC in the way of touch control.
MIC	The external microphone port.



NOTE

Touch Port 1 corresponds to HDMI 1, and Touch Port 2 corresponds to VGA In, HDMI 2 and HDMI 3.

Connection Panel 2

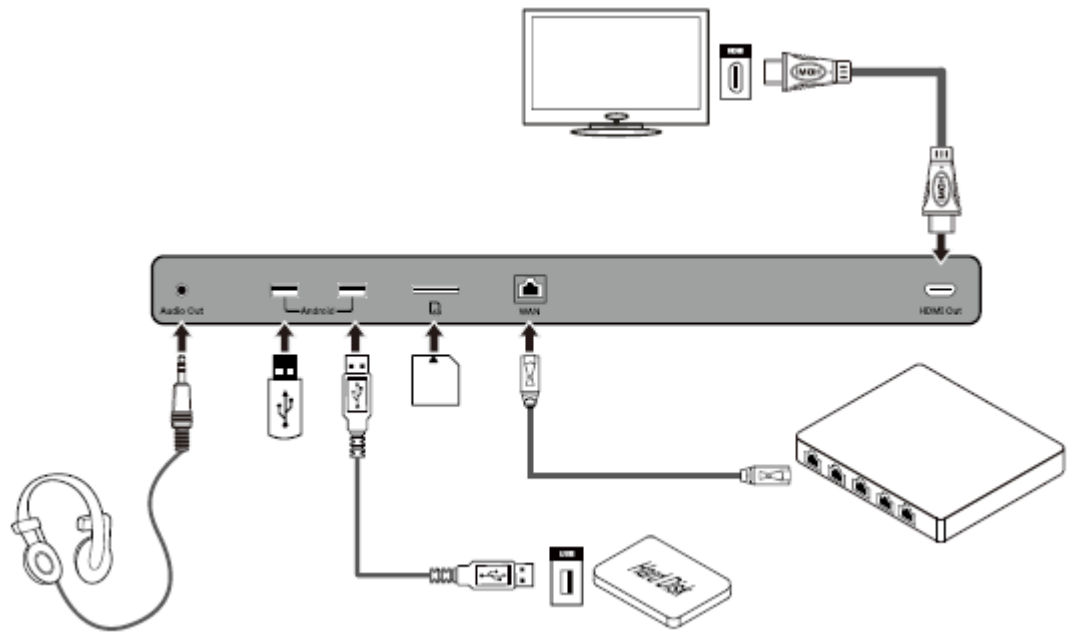

Name	Function Description
Audio Out	The terminal for external loudspeaker boxes or headphones.
Android	The USB 2.0 and USB 3.0 ports for connecting to the Android system.
SD	The external port for the SD card.
WAN	The port for wide area network, which is used to connect to external network.
HDMI Out	The output terminal for high definition signal, which can transmit the signal to other display equipment with high definition.

Connection Panel 3

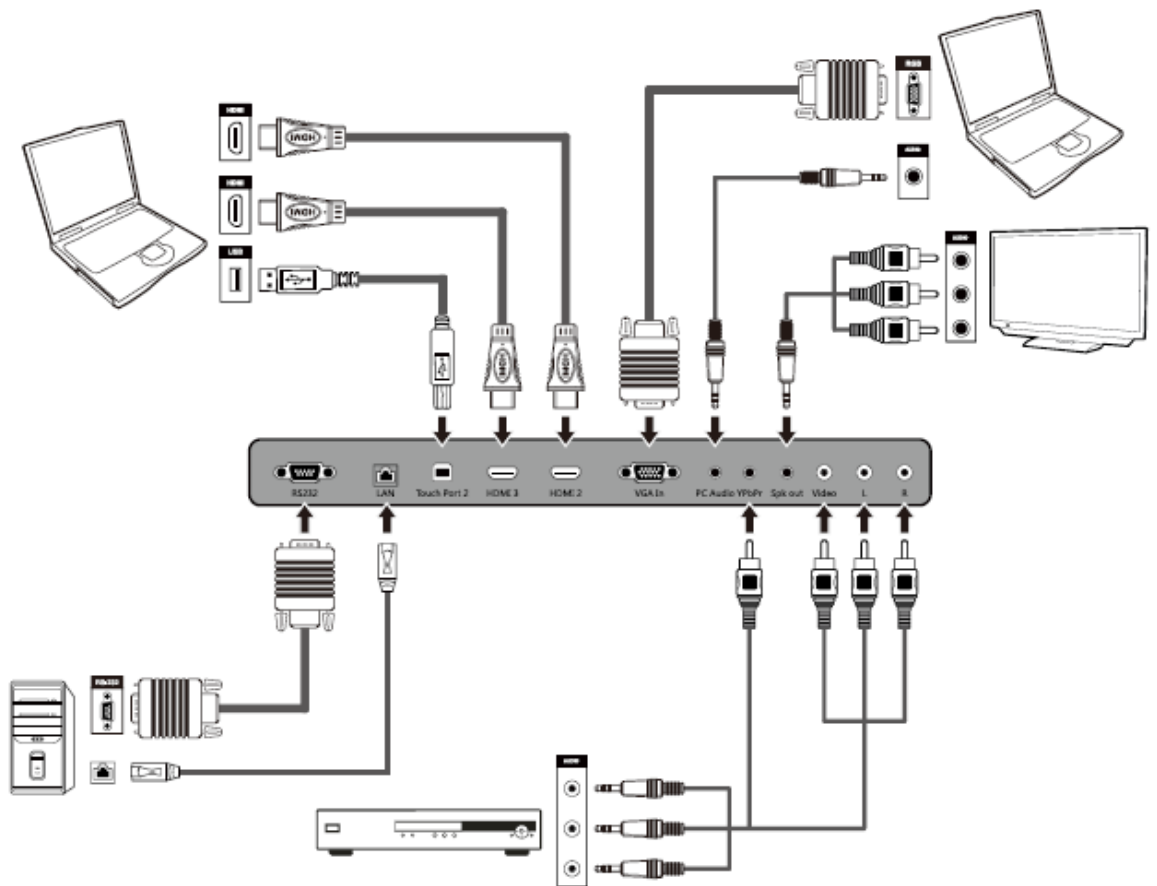

Name	Function Description
RS232	The input port for series signals, which is used by specific control device of serial port to input serial port protocol in order to control the panel.
LAN	The port for local area network, which is used to connect to internal network.
Touch Port 2	The terminal 2 for touch control signal.
HDMI 3	The input terminal 3 for high definition signal, which is used with the touch port 2 to operate PC in the way of touch control.
HDMI 2	The input terminal 2 for high definition signal, which is used with the touch port 2 to operate a PC in the way of touch control.
VGA In	The VGA port for an external PC, which is used with the touch port 2 to operate the PC in the way of touch control.
PC Audio	The PC Audio is used with the VGA port for an external PC.
YPbPr	The component video terminal, which is used to connect to video devices such as the HD digital signal STB, the satellite receiver, DVD players and other HD displays or TV equipment.
Spk out	Audio and video output terminal.

Name	Function Description
Video	An array of audio and video input terminals, which are used to input audio and video signal.
L	
R	





















NOTE

- Please use the cable provided with the product to connect to device.
- HDMI 1, HDMI 2 and HDMI 3 are high-definition multimedia ports, which are used to provide home theatre experience with the best quality for consumers by transmitting high-definition, all-digital audio and video. If there is an HDMI port on the external device, you are advised to connect it with the product by using the HDMI cable in order to display better image and sound effect.

Functions of the Remote Controller



1. : On or standby
2. : Mute
3. 0--9: Select TV channel or enter number
4. : Open the Android home page.
5. : Go back or return to the parent menu.

6.  : Show or hide menu.
7.  : Show or exit from the list of signal sources.
8.  : Enable audio only mode.
9.  : Freeze.
10.  : Up/Down/Left/Right direction buttons
11.  : Confirm.
12.  : Capture screen shots.
13.  : Show the current signal source. You cannot show it in Android.
14.  : Adjust screen displaying.
15.  : Open WIFI on the computer.
16.  : Change the display mode.
17.  : Turn to the previous page on white board software and PPT.
18.  : Turn to the next page on white board software and PPT.
19.  : Open white board software.
20.  : Switch over to VGA signal source.
21.  : Switch over to HDMI signal source.
22.  : Switch over to OPS signal source.
23.  : Zoom in and out.

Instructions of Remote Controller

The usage scope of the remote controller includes the vertical distance within five meters in front of the product, and the area within an angle of 30 degrees from the vertical point to the left and the right.



The effective receiving area is about 3 meters with 30° angle from vertical point to the left.



The effective receiving area is about 3 meters with 30° angle from vertical point to the right.



The effective receiving distance is about 5 meters from the front of device.



WARNING

To avoid probable faults, please read the following instructions and use the remote controller properly.

- Do not drop or beat the remote controller.
 - Do not spill water or other liquid on the remote controller.
 - Do not put the remote controller on wet items.
 - Do not expose the remote controller under sunlight or put it near overheated source.
-

3 Basic Operation

3.1 Power on

Step 1 Power the interactive panel with the 100V-240V 50Hz/60Hz AC power supply.

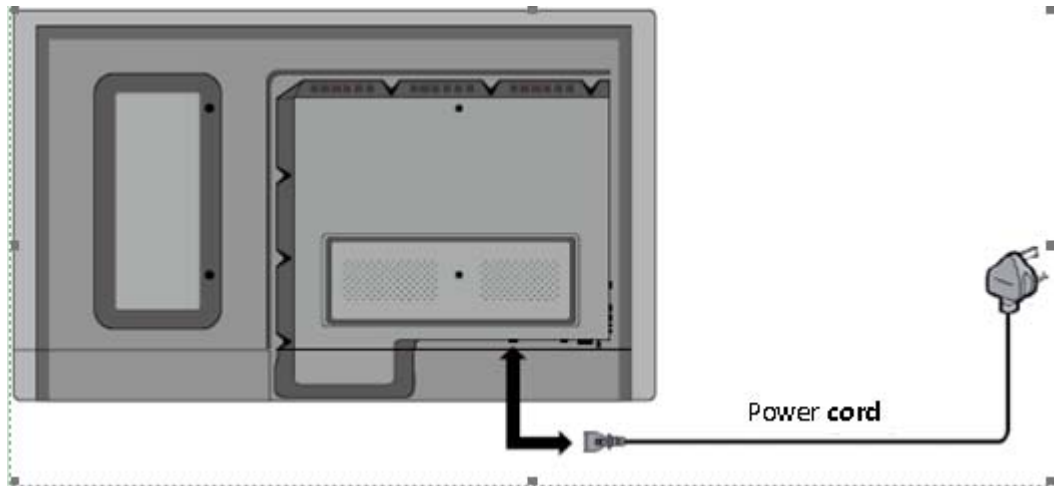

Step 2 Connect the panel to the power supply. Switch on the rocker switch (on the right bottom of the rear of the panel, next to the power port) to enter the standby status. The power indicator turns red.

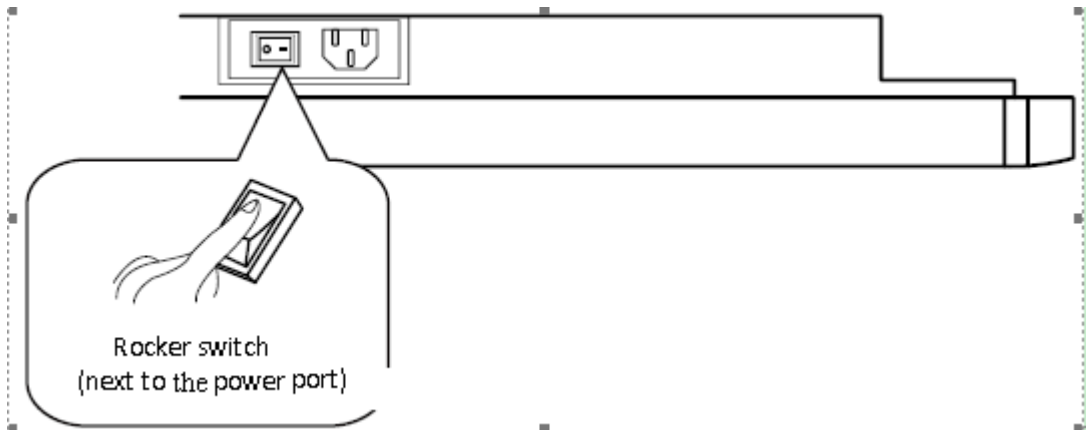

Step 3 Press power switch on the control panel or **Power** on the remote controller to turn on the interactive panel. The OPS is started. The power indicator turns green.

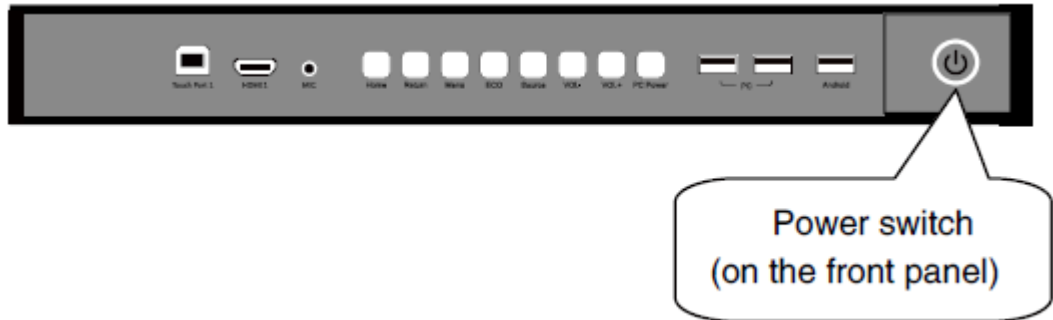

3.2 Power off

Step 1 Press **PC Power** to turn off the OPS (for all-in-one models only).

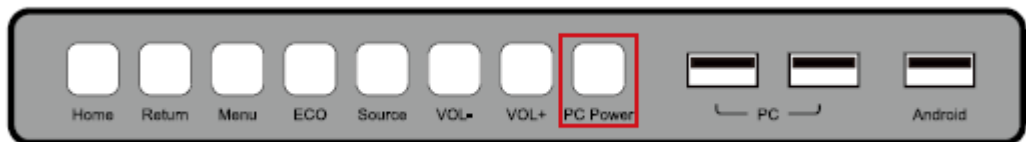

Step 2 Press **Power** on the control panel or **Power** on the remote controller to enter the standby status. The power indicator turns red.

Step 3 In the standby status, switch off the rocker switch to turn off the interactive panel.



WARNING

- Turn off the OPS before you turn off the interactive panel. Otherwise, the computer may be damaged.
- Disconnect the interactive panel from power after the panel enters standby status. Otherwise, the panel may be damaged. A sudden power failure may damage the interactive panel.
- Frequent power on and off in a short time may cause faults.

Status of the power indicator is as follows:

Power Indicator	Status
No light	Powered off
Red	Standby

Green	Powered on
-------	------------

3.3 Software Installation

- Recommended configuration:
 - CPU: Inter (R) Core i3 2.27GHz or AMD CPU with equivalent performance
 - Memory: 1GB
 - Hard drive: 1GB
 - Graphics card: supports DirectX 9 or above
- If the interactive panel is equipped with the latest version of handwriting software in the PC before being delivered, please skip the step.
- HID drive-free function only applies for Vista, Windows 7 or higher version (realize the functions of multi-touch etc.). The touch LCD display with Windows XP version should install/run the software for normal use.

Step 1 Insert the official USB cable into the USB ports of the computer and touch LCD display.

Step 2 Insert the official software installation disk into the computer.

Step 3 Double click the  Application.exe, follow the instructions and complete the installation of the touch LCD display software.

Step 4 The computer needs to restart so as to activate the software after installation completed. Save all the files in the computer and restart.

3.4 Software Uninstall

If you determine to uninstall the Teach Infinity Pro from your computer, choose **Control Panel > Add or Remove Programs > Teach Infinity Pro > Uninstall** to uninstall the program, as shown in the following figure.

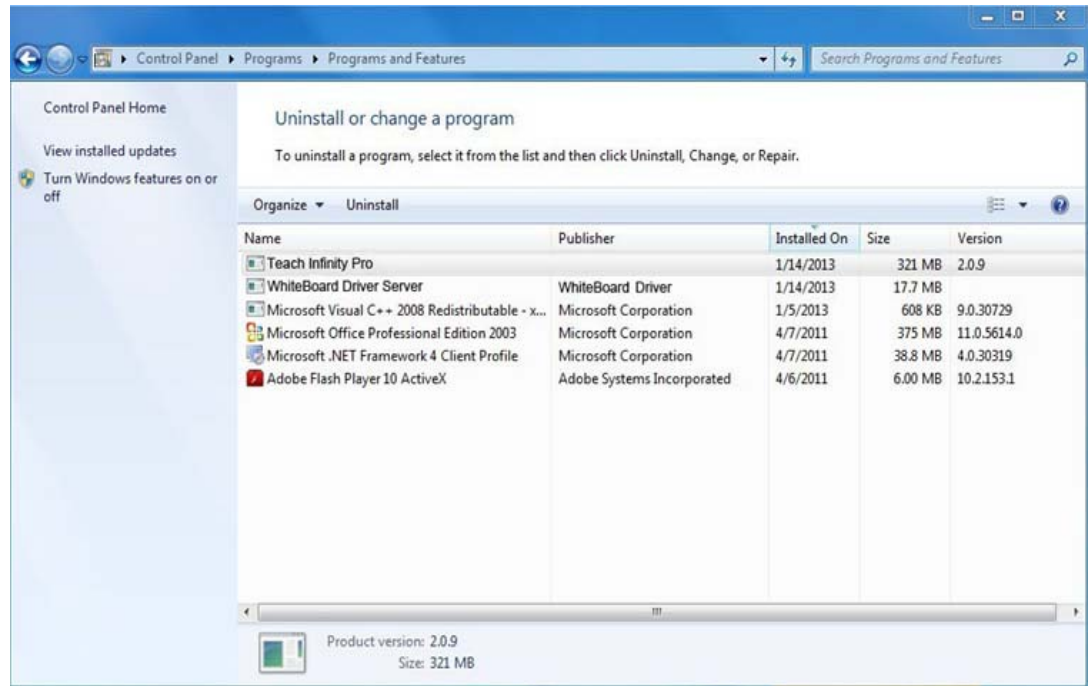

3.5 Software Positioning

To ensure that the handwriting display works properly, you need to make the handwriting shown on the display coincide with the actual handwriting. The highly accurate coincidence can be achieved by software positioning. Software positioning must be implemented in the following scenarios:

- The first time to use the interactive handwriting LCD.
- The driver program is reinstalled.
- The handwriting display is connected to another PC.

The handwriting display adopts nine-point positioning method. The positioning process is described as follows:

Step 1 Connect the display and run the drive program.

Step 2 Click the handwriting drive icon on the right bottom of the screen. The following figure is displayed.

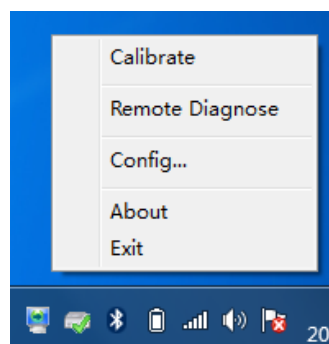

Step 3 Select **9 Points**, click **Calibrate** and the following figure is displayed.

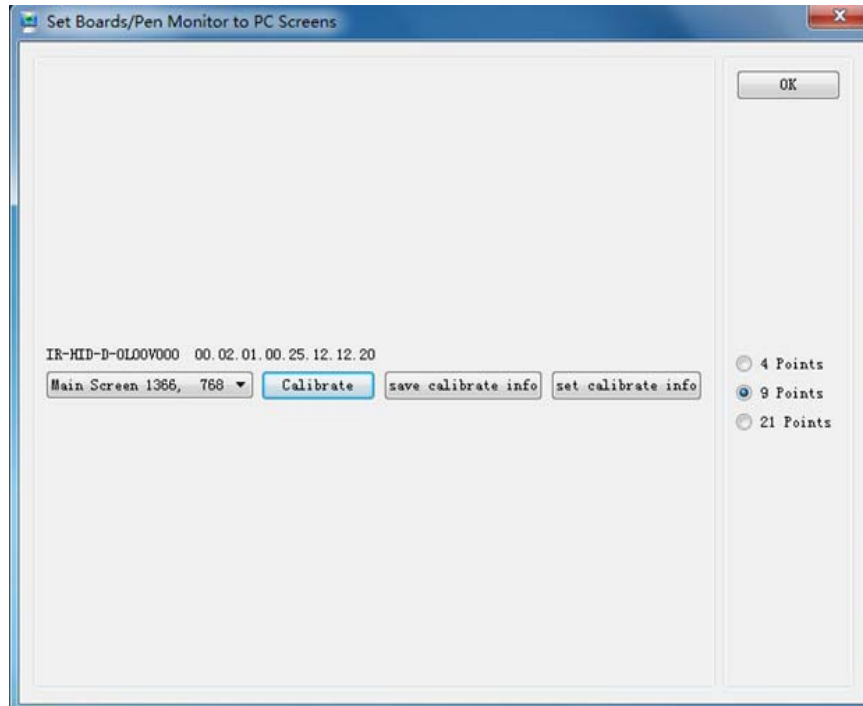

Step 4 Use the pen to click and hold the center of the flickering cross. Do not release it until the flickering cross moves to the next point. Repeat and complete the positioning process according to the instructions on the interface. The software interface returns to the desktop automatically after the positioning is completed successfully.

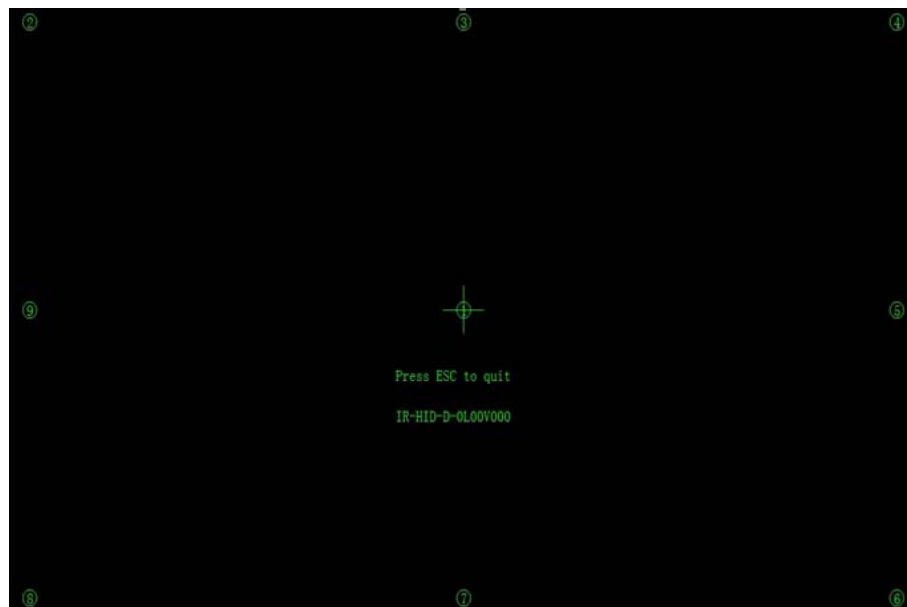

3.6 Positioning in the Windows 7 System

Step 1 Connect the interactive panel to PC using the USB cable via the USB interface on the panel;

Step 2 Choose **Control Panel > Tablet PC Settings**.

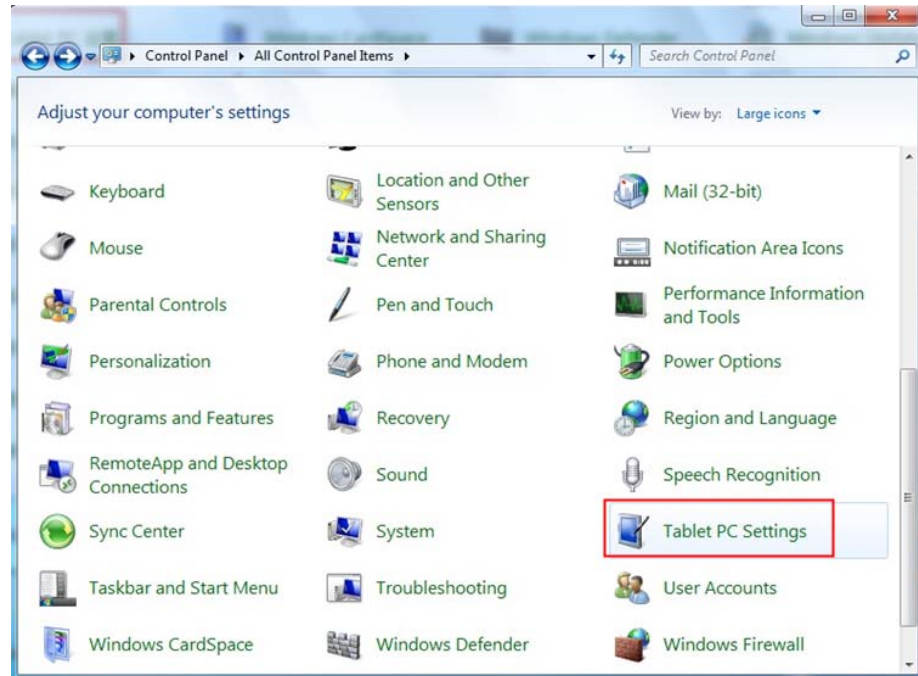

Step 3 Click **Calibrate** in **Tablet PC Settings** window.

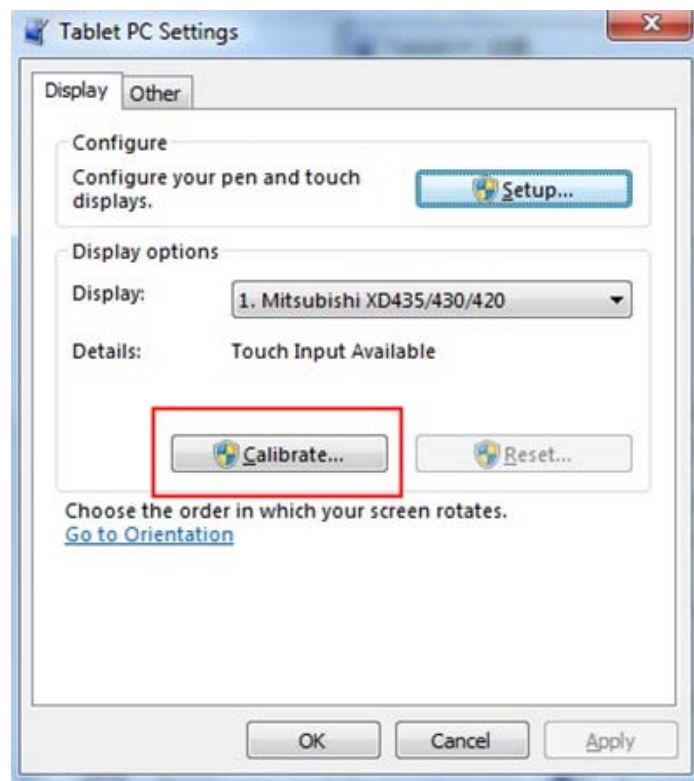

Step 4 Use the pen to click and hold the center of the flickering cross. Do not release it until the flickering cross moves to the next point. Repeat and complete the positioning process according to instructions on the interface.



Step 5 Click **Yes** after the calibration is completed.

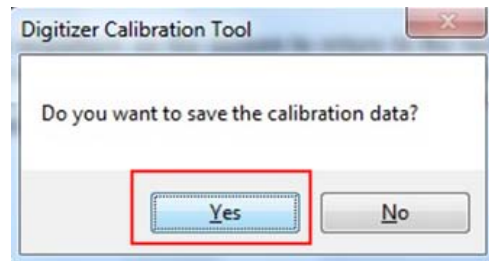

 **TIP**

- To ensure the handwriting accuracy, use the pen provided with the interactive panel to implement positioning. Do not use your fingers.
- Positioning errors may cause touch function failure on the interactive panel. In this case, you need to implement positioning again.
- During the positioning process, you can press **ESC** on the keyboard to exit the positioning operation.
- The positioning interface varies among different software versions. Please follow the actual instructions provided on the interface.

3.7 OPS Installation



WARNING

The OPS does not support hot-plugging. Please insert the plug of the OPS after the interactive panel is disconnected from the power.

Install the OPS by following the following steps:

Step 1 Insert the OPS into the special slot on the rear of the interactive panel.

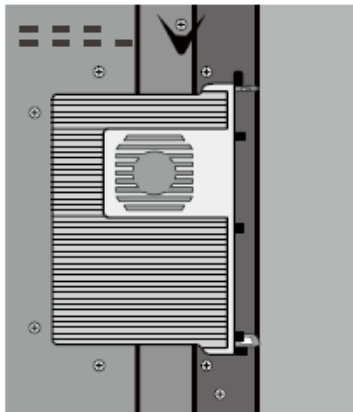

Step 2 Tighten the screws.

Step 3 Confirm that the OPS is installed correctly.



4 Toolbar Introduction

The SmartBar includes three modes: Home Page, White Board, and Remarks.

In any of the three modes, you can click  on the toolbar to go back to the previous page and click  to exit from other programs or go back to the home page from other signal sources.

- On the home page, the SmartBar is in the home page mode and shows icons of the white board, gallery, file manager, system setting, browser and search engine. You can click an icon to open the corresponding program.



- After the white board program is started, the SmartBar enters the white board mode, in which you can choose a pen, line and color to write on the white board. Click . In the displayed menu, the functions of **New Page**, **Overview**, **DeleteAll** and **Settings** are listed.



- In programs other than the white board, the SmartBar is in the Remarks mode. You can select a pen, line and color to write and add remarks on the opened file (including image, PPT and PDF). Click  on the right to hide the SmartBar. Scroll down with your finger to display the SmartBar.



4.1 Home Page

The home page provides the preview function that displays three items:

- Preview the OPS.

- Preview external PC, such as the laptop.
- Preview external portable device, such as U flash disk and SD card.

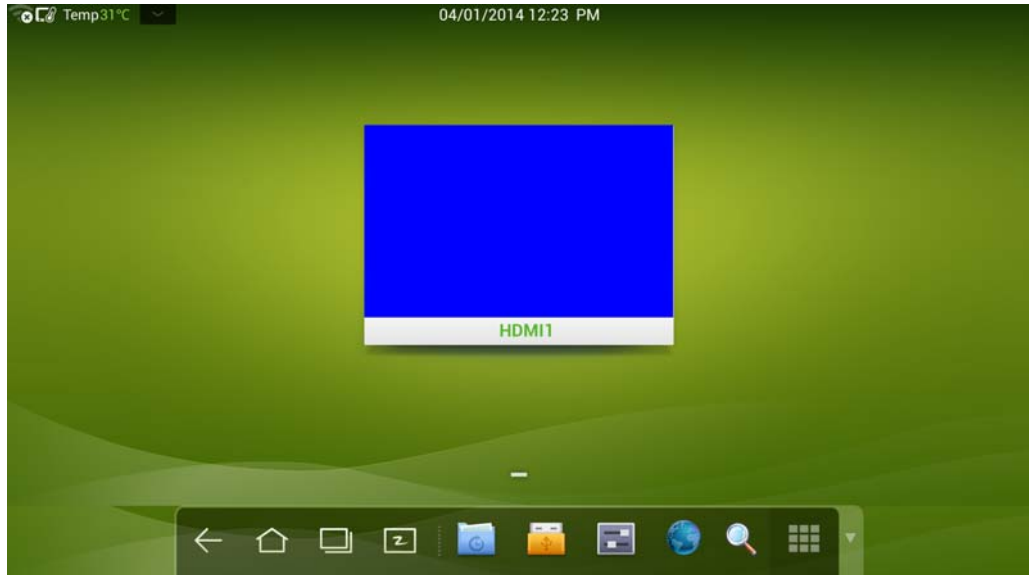

The operation interface for preview is as follows:

- Click  on the SmartBar or press **HOME** button to enter the home page. The preview window is displayed. When more than three preview windows are displayed, additional windows will be displayed on the second page. Scroll left and right to turn page.

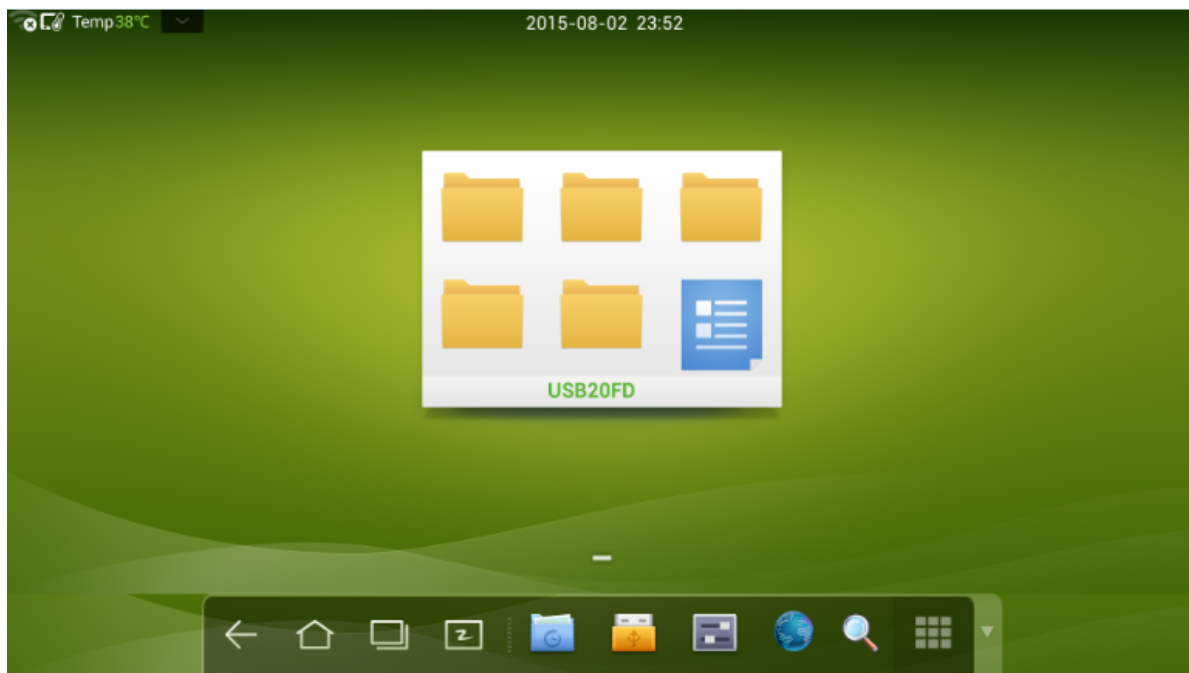

- The following figure shows the interface when a USB drive is inserted into an all-in-one interactive panel. The desktop of the OPS and files in the portable device can be previewed.



- Click any place on the OPS desktop to display the interface information. Click the blank in the SD card preview window to open the SD card portable device.
- Click  on the upper left corner of the home page to show tools, clock, calendar and calculator. Click  at the bottom to hide tools and go back to the home page, as shown in the following figure:



4.2 Task Manager

In the task manager, you can view current running programs, switch and end programs. Click  to enter the task manager as shown in the following figure:

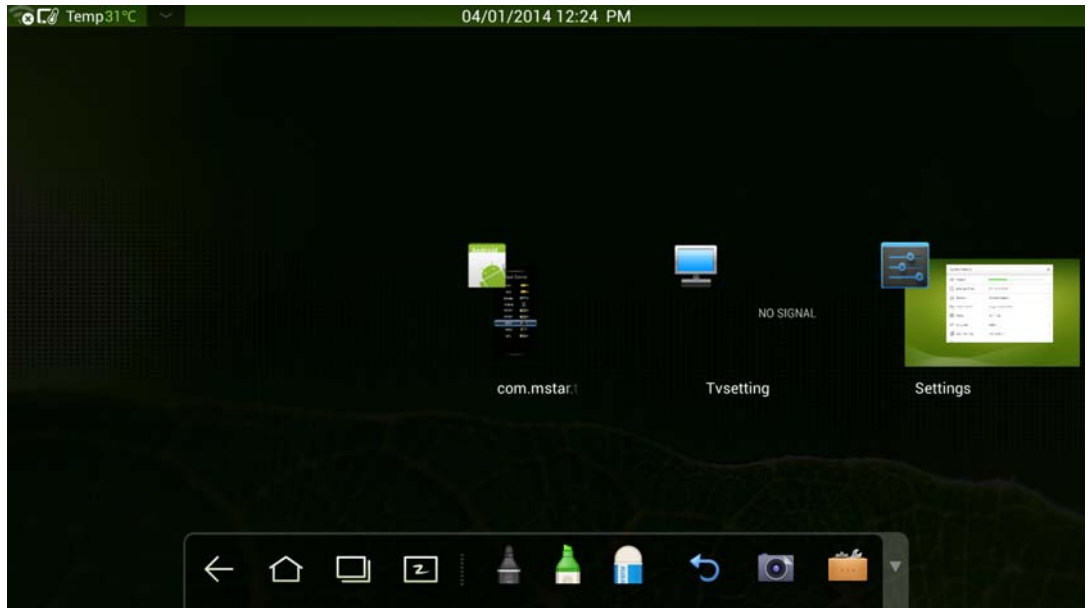

View Running Programs

In the task manager, scroll left and right to view current running programs.

Switch Programs

In the task manager, click an application program icon to switch programs. For example, click **Gallery** to switch to the gallery application program, or click **Browser** to switch to the browser application program.

End Programs

In the task manager, click a program icon and scroll it up or down to end the program. You can also click a program and hold it for several seconds. After a message box is displayed, click **Remove from list** in the box to end the program.

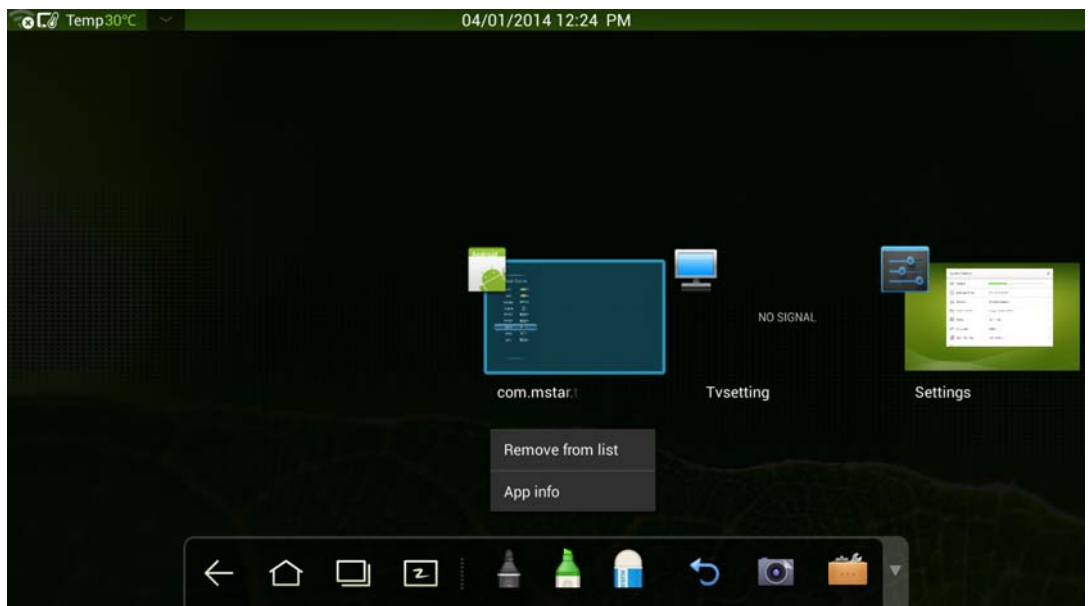

4.3 White Board

The white board provides the writing function. In the white board program, you can select a pen, line and color to write and use an eraser to erase content on the white board. You can also print and clear the content on the white board.

Click  on the SmartBar or press **White Board** on the remote controller to enter the white board interface:



New White Board and Settings

Click . In the displayed menu, the functions of **New Page**, **Overview**, **DeleteAll** and **Settings** are listed.

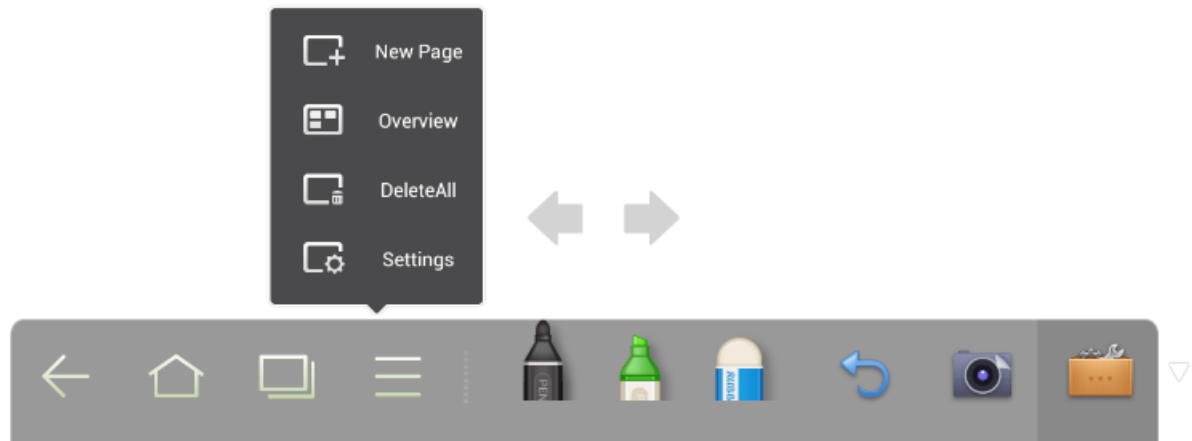

Click **Settings** to set the color and shade of the white board, as shown in the following figure:

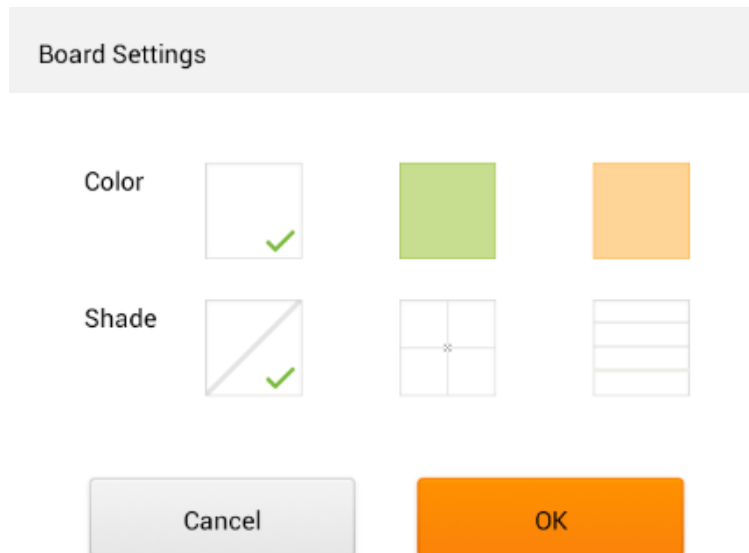

Pen, Line and Color

If the marker is selected, click and hold  for two seconds to set its line and color.



If the highlighter is selected, click and hold  for two seconds to set its line and color.



Eraser

Two methods are available to erase written errors or content as follows:

- Click  to select the eraser, and then you can use it to erase the content on the white board.
- Use five fingers to touch the screen and a circle is displayed indicating the scope for erasing. Move the circle to erase the content that you are writing.





Cancel

Click  to cancel operations.

Screen Capture

The following two methods are used to capture screen:

- Click  to capture current content on the white board and save it as an image in **ScreenImage** directory. (The SmartBar is not captured in the image.) You can open the directory by two ways:
 - Go back to the home page and click  on the SmartBar to enter the file manager. In the system file, find and click the ScreenImage folder to check.
 - Click  in application programs to enter the image browsing interface. In the system file, find and click the ScreenImage folder to check.
- Press **CAPTURE** on the remote controller to save current content on the white board as an image in **Pictures > Screenshot** directory in the file manager.

Print and Clear

Click , **Print** and **Clear** are displayed. Click **Print** to print current content on the white board. Click **Clear** to clear all current content on the white board.



4.4 Gallery

You can enter the gallery to view images one by one or play them as slides.

Click  on the SmartBar to enter the gallery. All folders containing images are displayed.



Click a folder to display images in it.

- View images one by one
Click one image in a folder. Scroll left to show the previous image and scroll right to show the next image.
In the single image mode, you can click icons on upper right corner of the screen to delete, cut and edit the image.
- Play slides
Click  on the upper right corner of the folder and select Slide to play images as slides.



4.5 File Manager

The file manager provides various functions, such as preview, filter, search, select, copy and delete files.

4.5.1 File Preview

Click  on the SmartBar to enter the file manager interface. Current system files are displayed. External device files are also displayed, such as the files in the SD card and U flash disk.

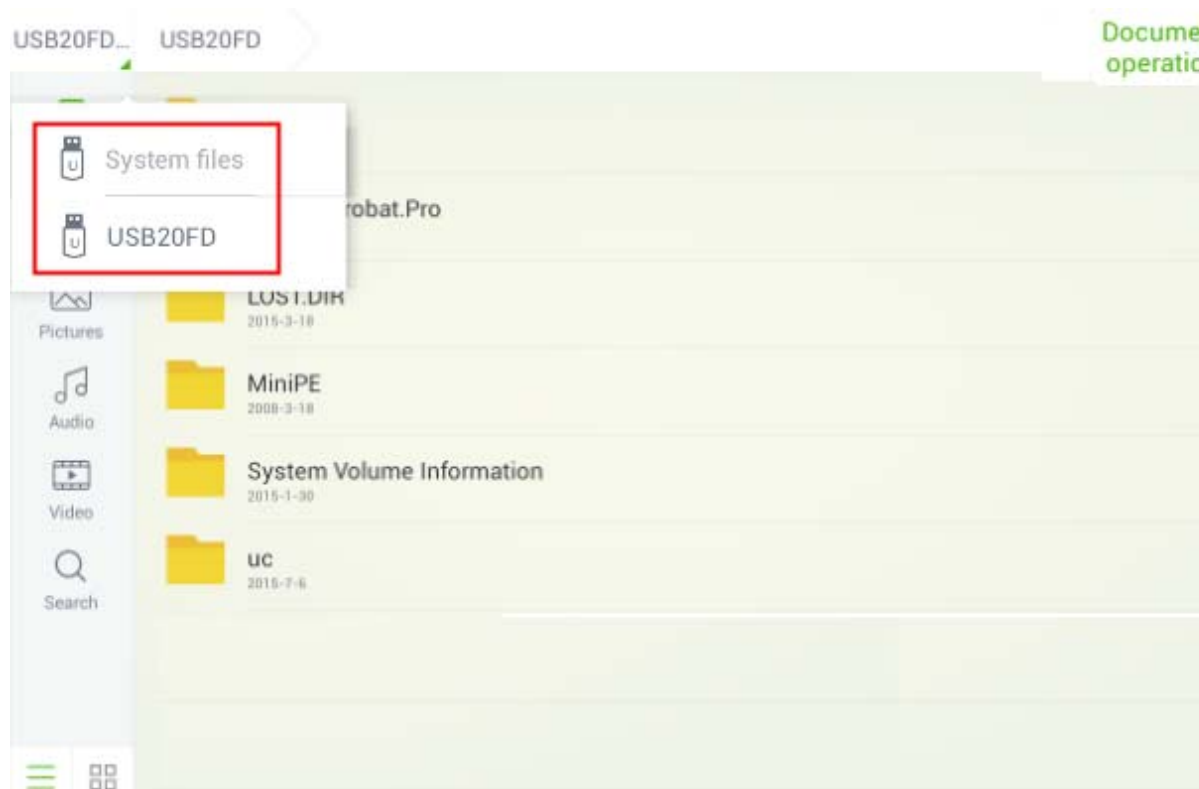

- System file preview

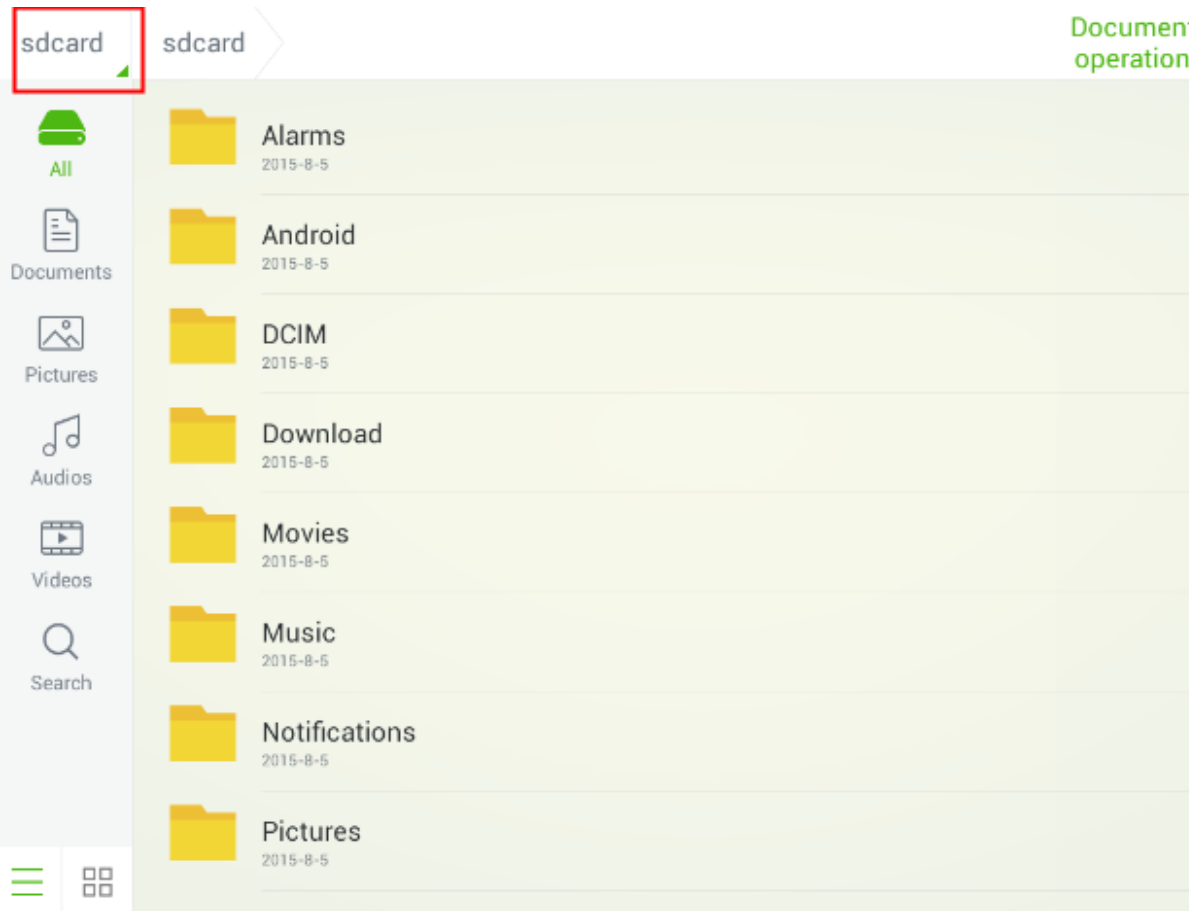

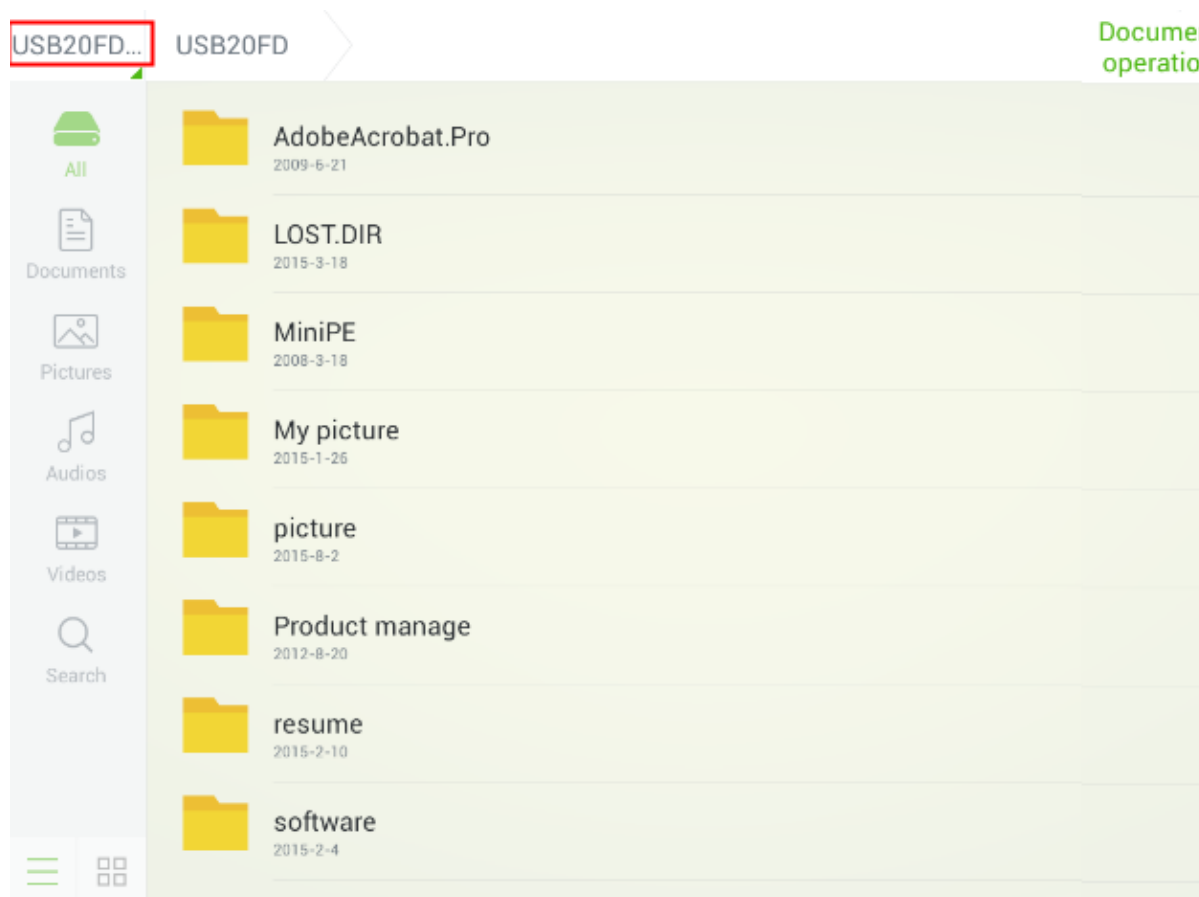

- Preview of external device file



4.5.2 File Filter

In the system, documents, images, audios and videos can be displayed by sort to help you find the file. Click icons on the left toolbar to view files by sort.

Two ways are available to view the files: by list or by thumbnail. Click  or  at the bottom of the toolbar to switch the way to view files, as shown in the following figure:

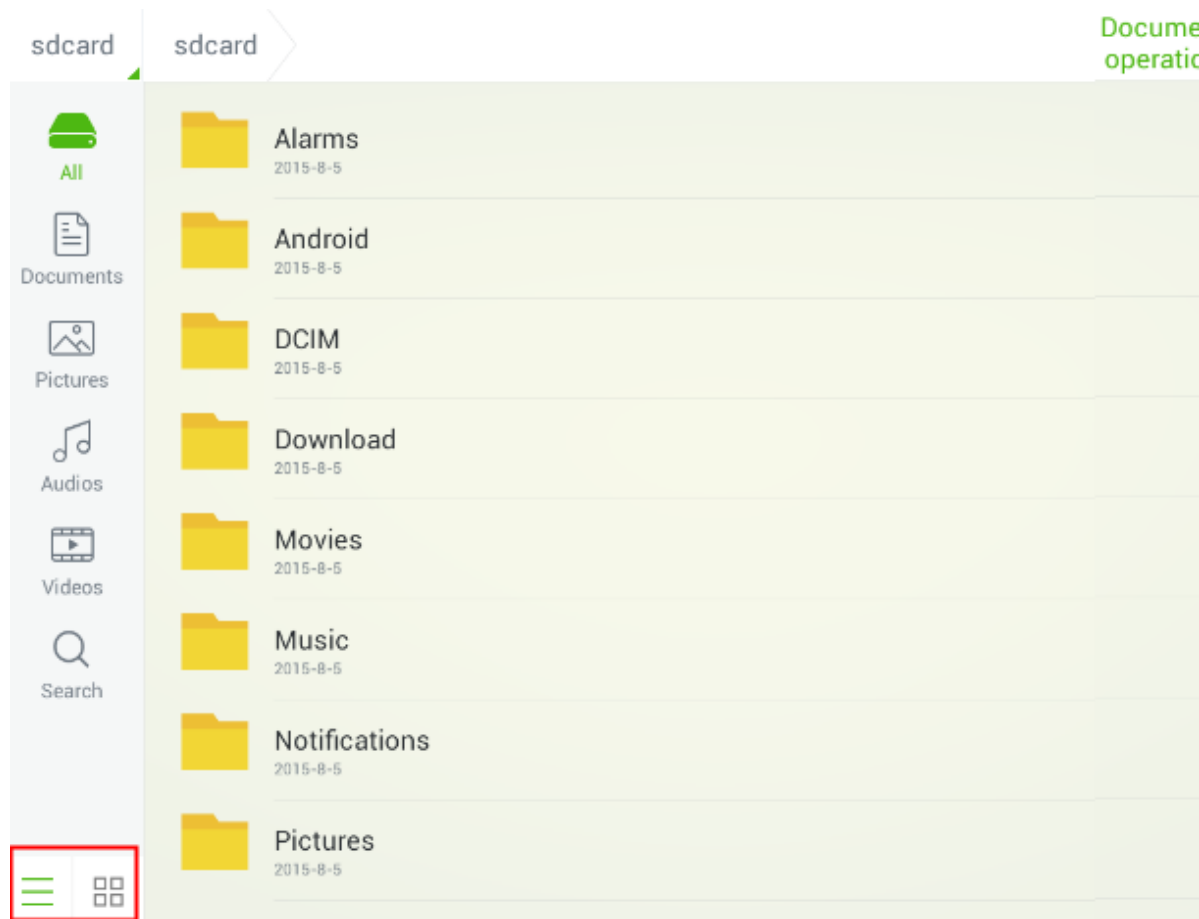

4.5.3 File Search

Click **Search** on the left toolbar and type keywords in the search box. The search results matching the keywords are displayed, as shown in the following figure:

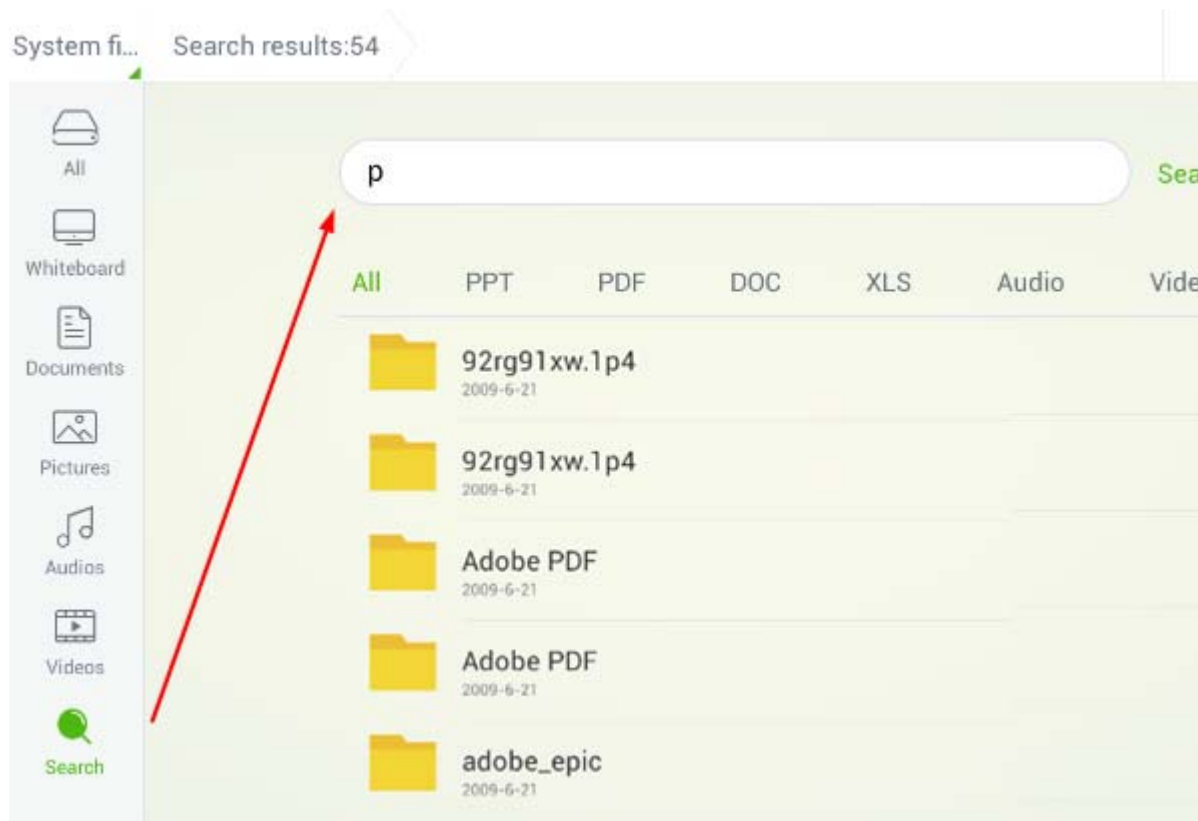

The search results can be displayed by sort. A filter toolbar including the file types of **All**, **PPT**, **PDF**, **DOC**, **XLS**, **Audio** and **Video** is displayed under the search box, as shown in the following figure:

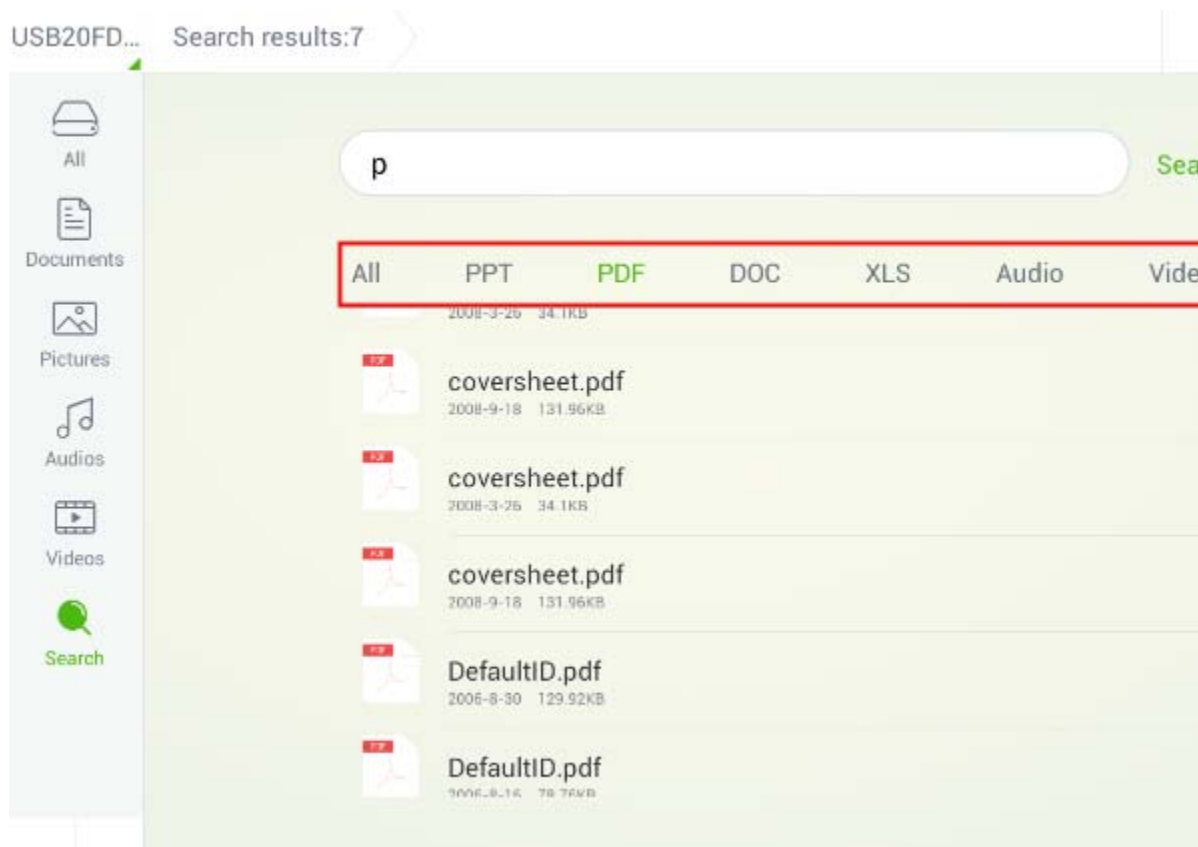

4.5.4 File Operations

Click **Document operation** on upper right corner of the file manager. The functions, select all, select one, copy, delete and cancel, are provided, as shown in the following figure:

- Click a file: The current file is selected.
- Select all: All files displayed are selected.
- Copy: Copy the file selected.
- Delete: Delete the file selected.
- Cancel: Cancel current operation.

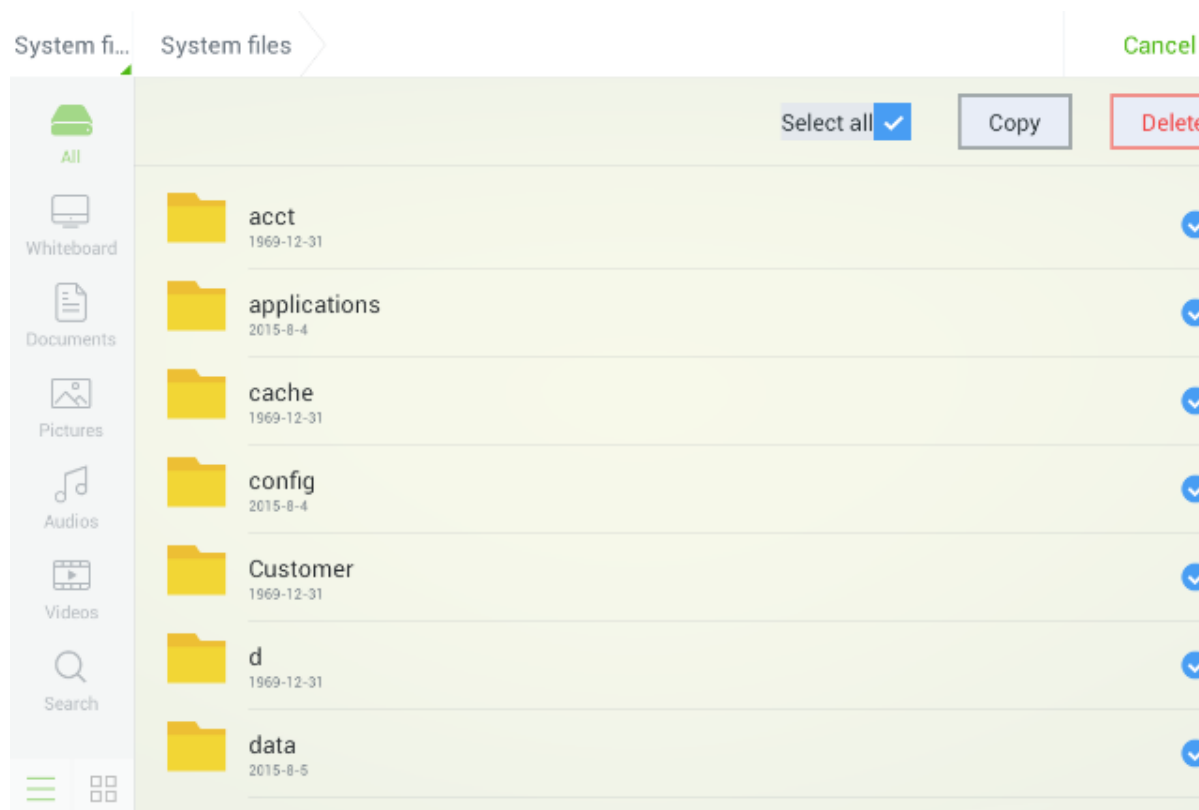

4.6 System Settings

Click  on the SmartBar to enter the system settings interface. The **Network**, **Language and input method**, **Date and time**, **Scheduled power on/off**, **Clear screen shots**, **Printer**, **Storage**, **Application**, **Starting signals**, **Smart eye protection**, **About**, are displayed on the screen. Click the area outside of the system settings interface to exit.

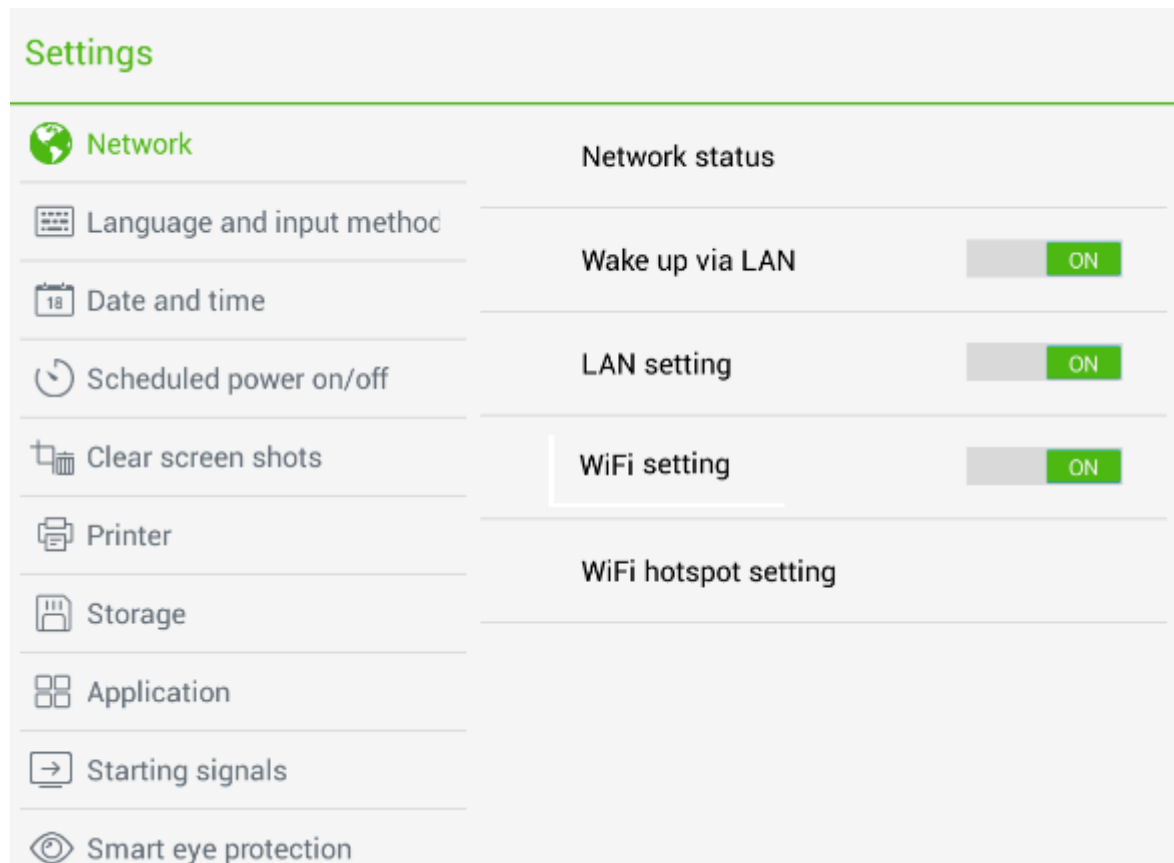





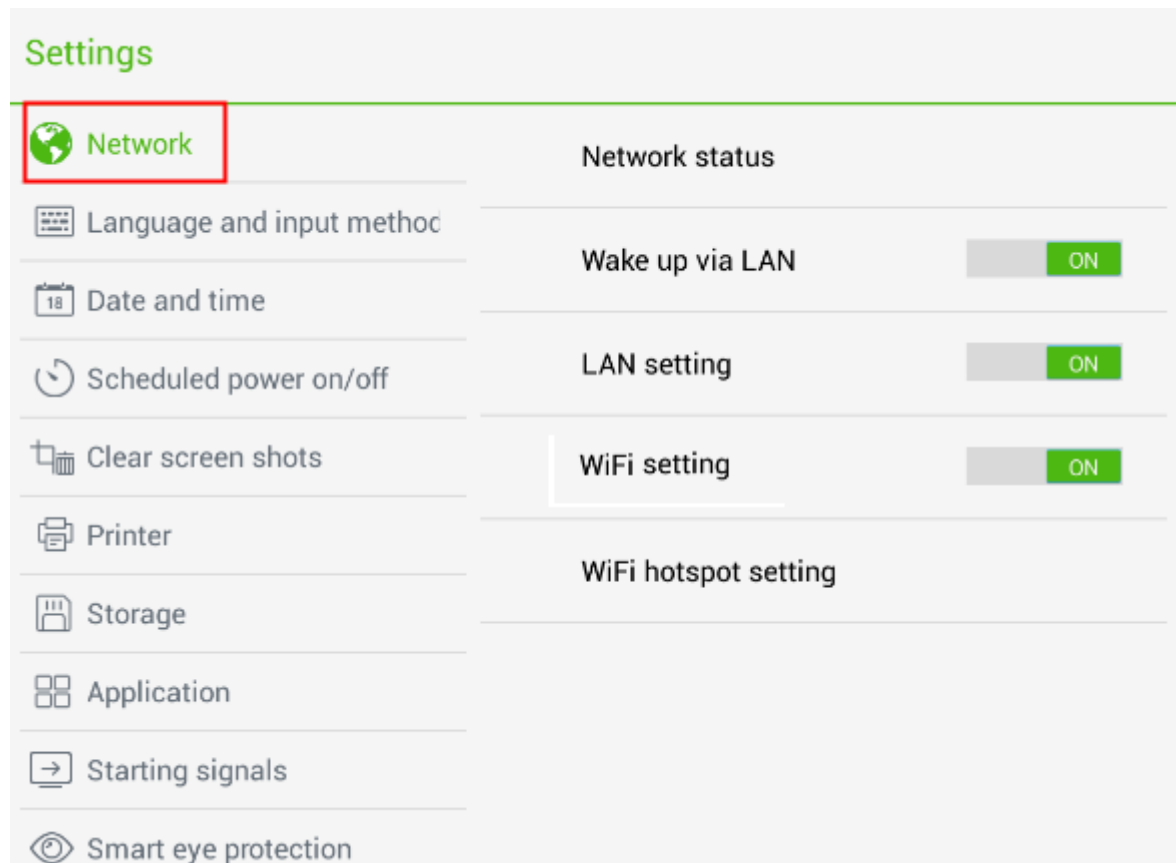



4.6.1 Network

Click **Wireless & network** to check the **Network status**, **Wake up via LAN**, **LAN setting**, **WiFi setting** and **WiFi hotspot setting**. Select a network connection and set related parameters correctly.



Network Status

The network status includes the information about current network connection.

Settings	
 Network	Connection method: Cable connection
 Language and input method	Network connecting status: Network connected
 Date and time	MAC ID: FE:20:5B:E4:12:B7
 Scheduled power on/off	IP address: 192.168.45.35
 Clear screen shots	Mask code: 255.255.255.0
 Printer	Gateway: 192.168.45.1
 Storage	
 Application	
 Starting signals	
 Smart eye protection	

Wake up Via LAN

When “**Wake up via LAN**” function is “**ON**”, administrator of control center can send requests via LAN using MAC address of touch screen to power on touch screen remotely. To use the function successfully, touch screen should be power off and connected to control center with LAN cable in the same network.

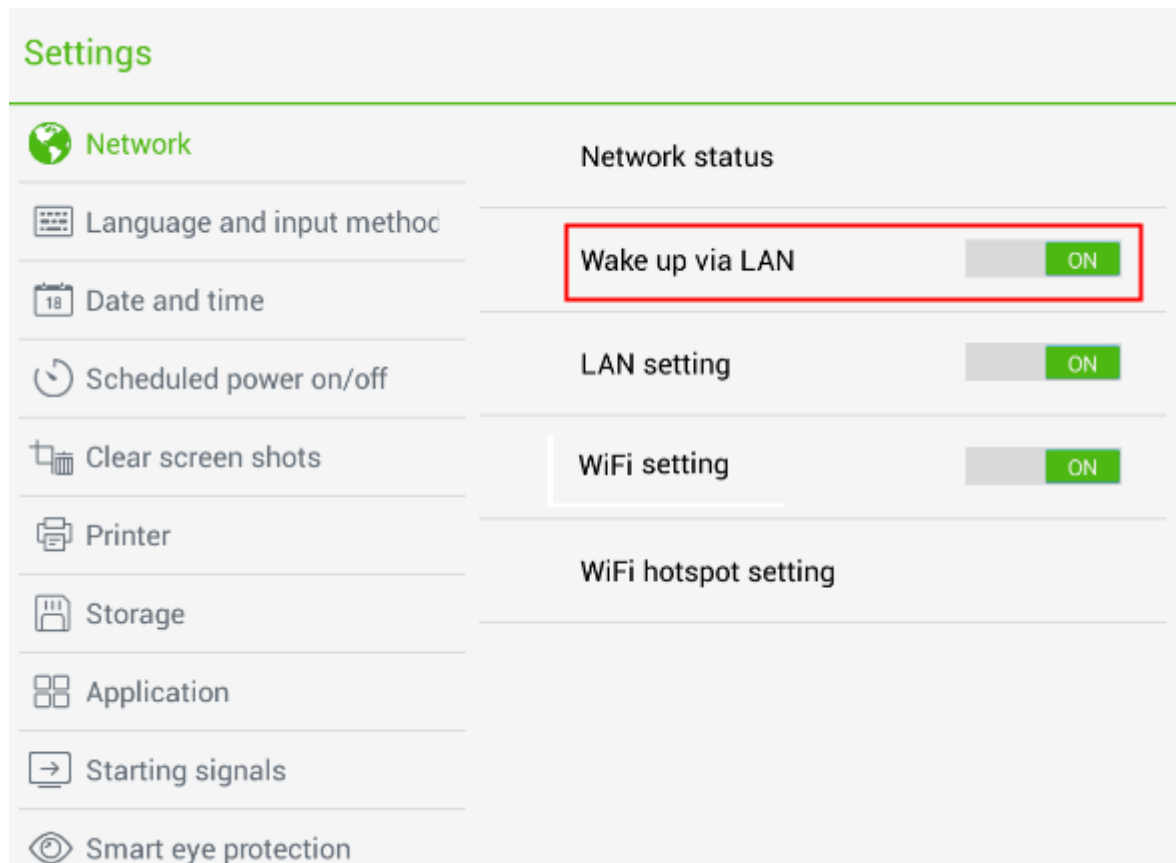

Steps of obtaining MAC address of touch screen:

Step 1 Using “SOURCE” on the remote control or “Source” on the front control panel of touch screen to enter **Input Source** page.

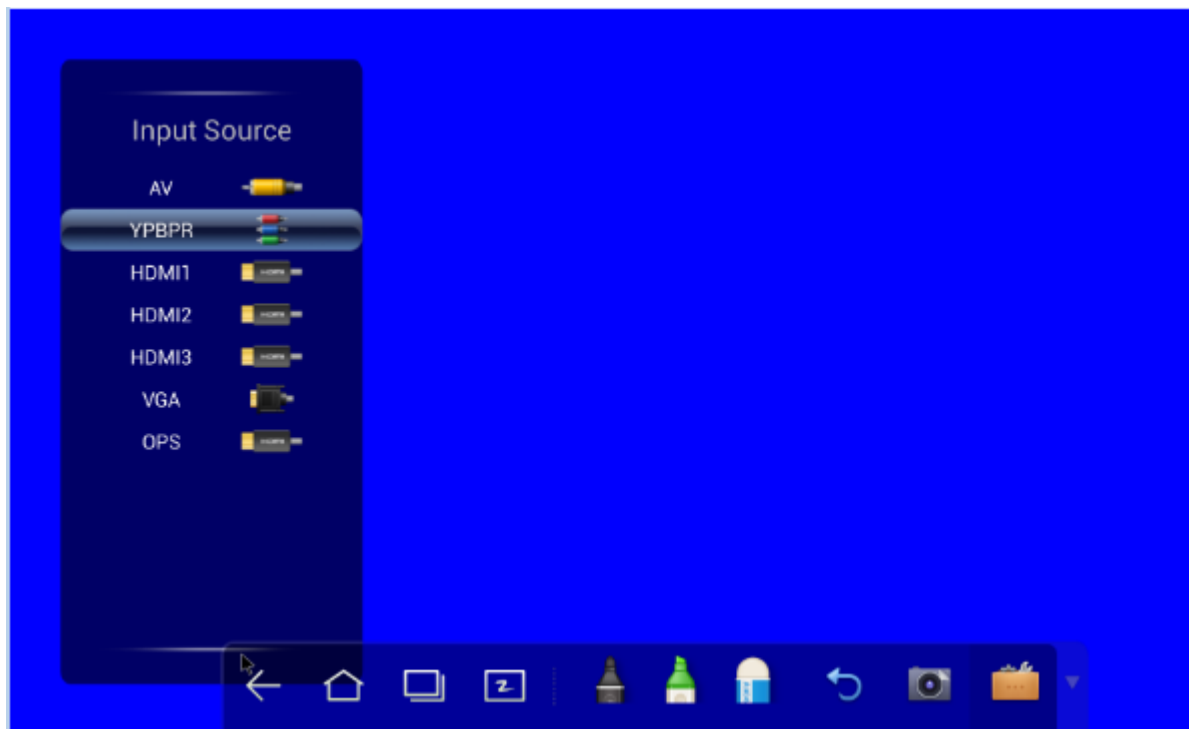

Step 2 Using remote control to enter number “2580” in input signal page to enter “**Design Menu**” page.

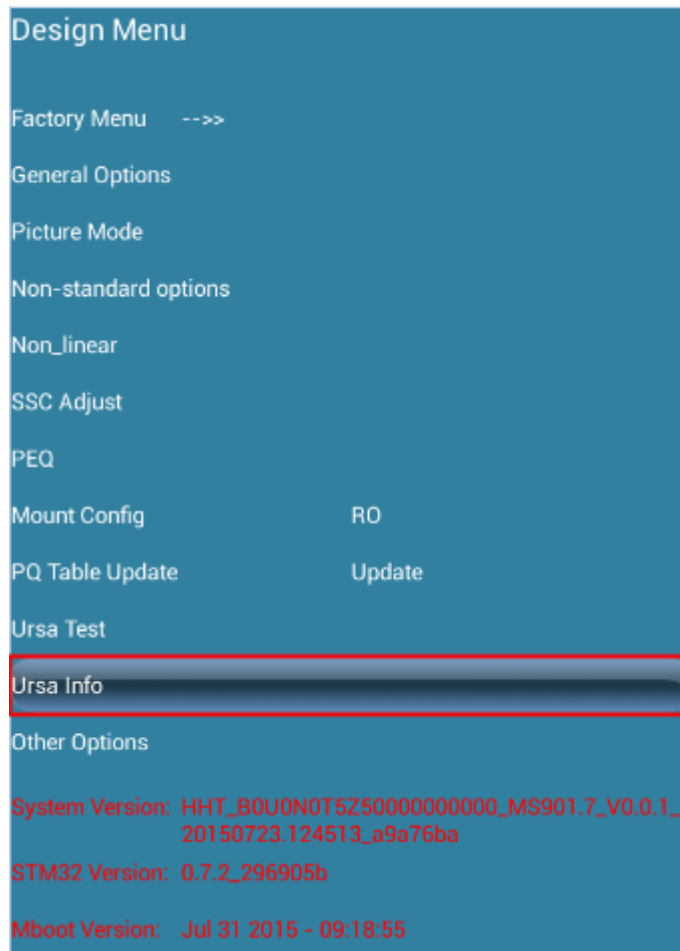











Step 3 Click “Ursa Info” in “**Design Menu**” page to enter “**Ursa Info**” page and get “WOL_MAC” as MAC address of touch screen.

Ursa Info	
Main Version	20150723.124513
Source Code	a9a76ba
Screen	FullHD_LTI750HF02_SAMSUNG
Mboot Version	Jul 31 2015 - 09:18:55
6M40:	0000
System Version:	HHT_BOU0N0T5Z50000000000_MS901.7_V0 .0.1_20150723.124513_a9a76ba
STM32 Version:	0.7.2_296905b
WOL_MAC:	8c:33:57:b9:14:66
BASE_CODE	HHT_BOU0N0T5Z50000000000_MS901.7_V0 .0.1_20150804.214634_f7b84a4

LAN Setting

- If the panel is connected with LAN cable and supports Dynamic Host Configuration Protocol (DHCP), the system will automatically configure the internet protocol (IP) value.

Settings

-  Network
-  Language and input method
-  Date and time
-  Scheduled power on/off
-  Clear screen shots
-  Printer
-  Storage
-  Application
-  Starting signals
-  Smart eye protection

Automatic obtaining IP address



IP address:



Subnet mask

Default gateway

Primary DNS

Backup DNS

Save

- If the network protocol needs to be set manually, enter the IP address, default gateway and DNS server parameters by using the soft keyboard or remote controller. Slide  or  to select the subnet mask to be changed.

Settings

Network

Language and input method

Date and time

Scheduled power on/off

Clear screen shots

Printer

Storage

Application

Starting signals

Smart eye protection

Automatic obtaining IP address

Off

IP address: 192 168 45 35

Subnet mask 255 255 255 0

Default gateway 192 168 45 1

Primary DNS 192 168 33 10

Backup DNS 0 0 0 0

Save

WiFi Setting

When the Android USB port on the panel is connected with an external wireless card (customized) and **WiFi setting** is enabled, the system automatically searches available wireless network APs. In the result list, select the AP to be connected.

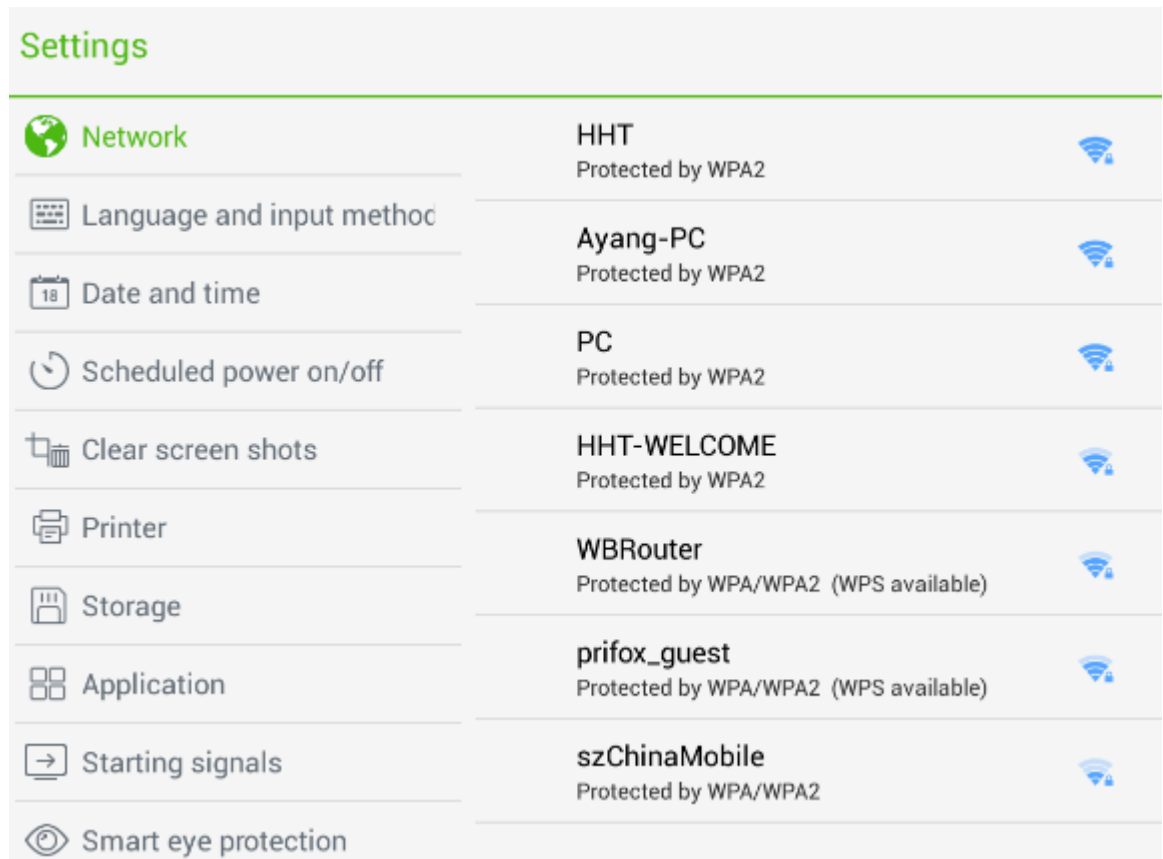

After an AP with safety authentication is selected, an interface is displayed to ask for the password. You need to enter the password using the soft keyboard to connect to wireless network.

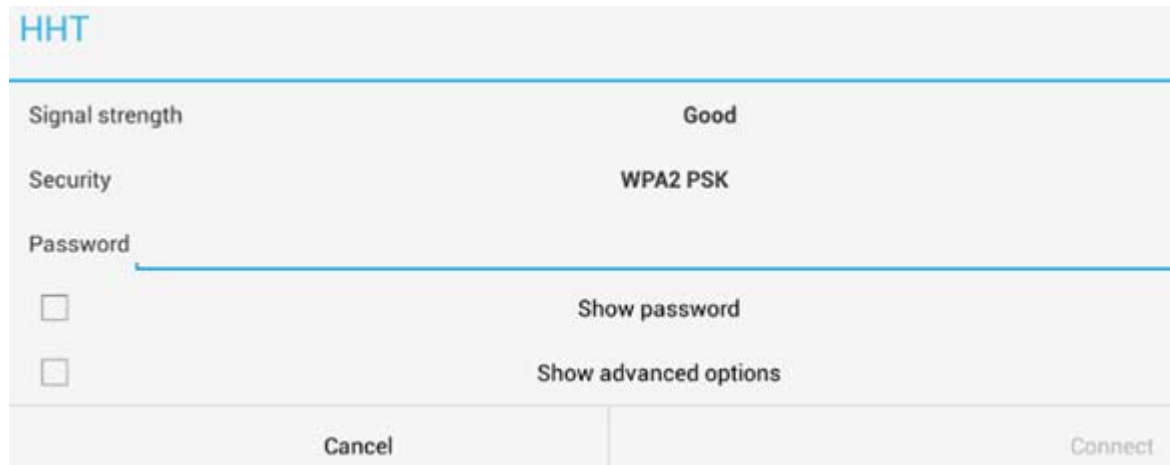

WIFI Hotspot Setting

When the Android USB port on the panel is connected with an external wireless card (customized) and **Portable Wi-Fi hotspot** enabled, perform the following operations:

- Select **Portable Wi-Fi Hotspot** to set the panel as a WIFI hotspot.

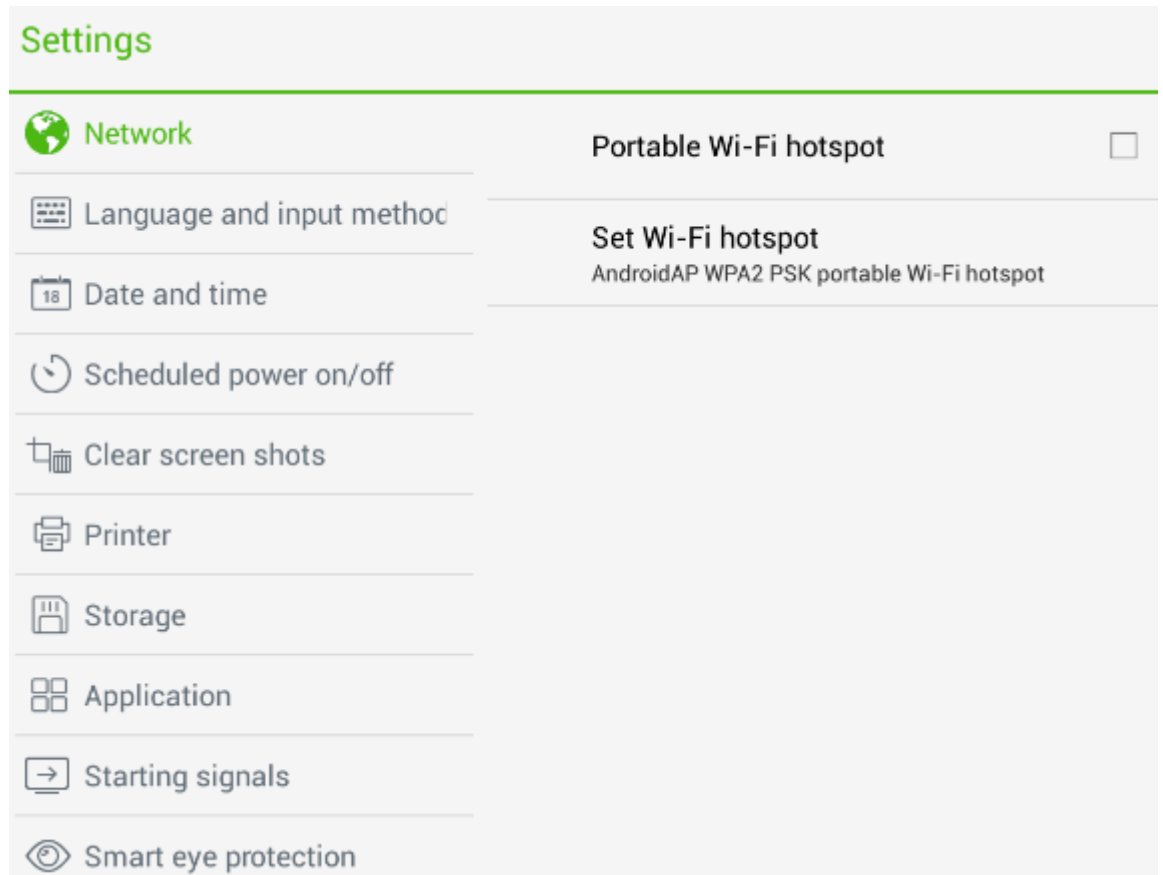

- Or, click **Set Wi-Fi hotspot** and set related WIFI hotspot attributes in the displayed window.

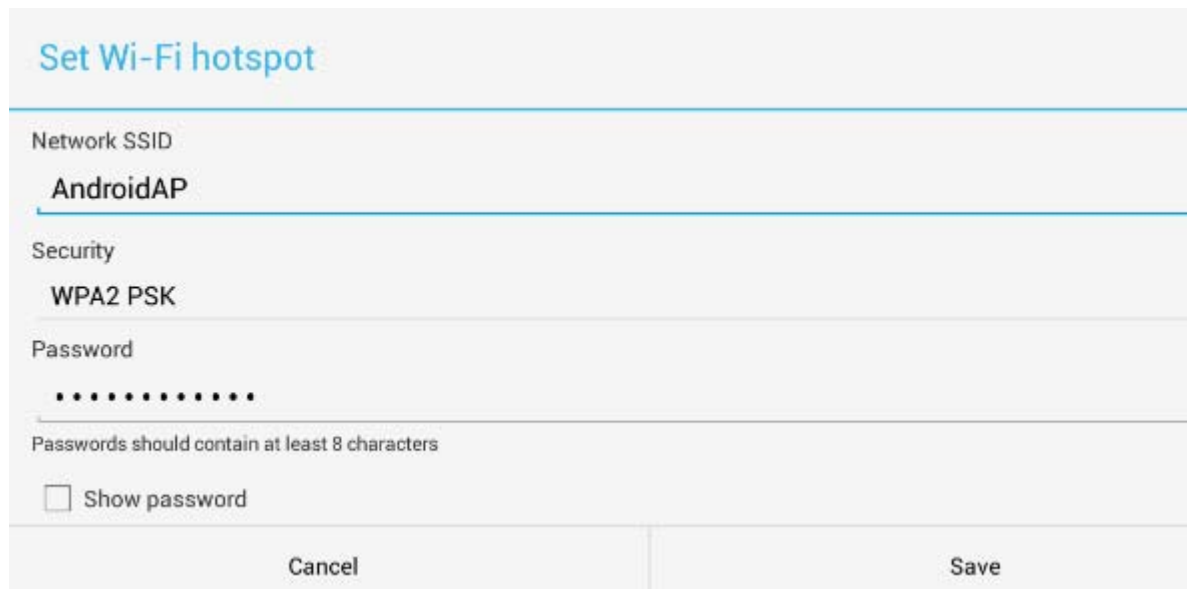

4.6.2 Language and Input Method

- Click **Language and Input method**. A setting interface is displayed.

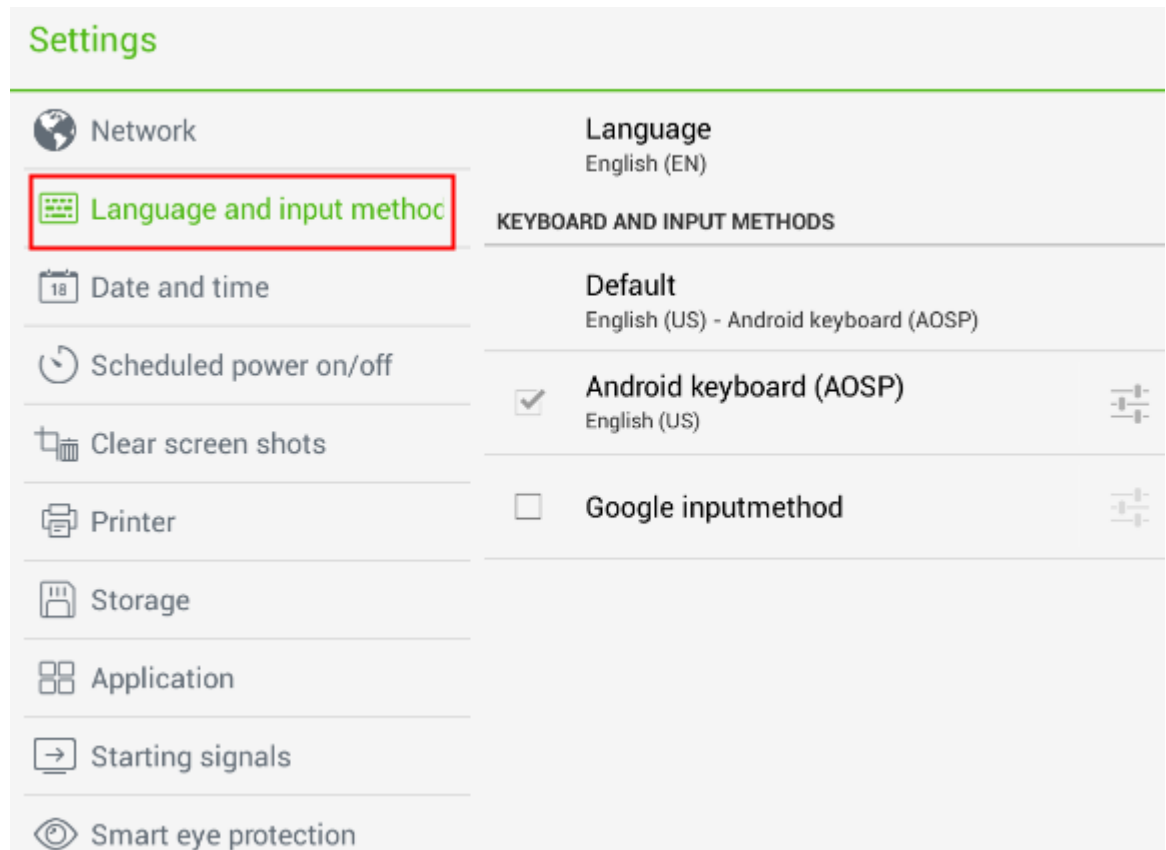

- Click **Language**. Chinese (China) and English are displayed.



- Click **KEYBOARD & INPUT METHODS**. Two input methods, AOSP and Google Pinyin, are displayed. You can choose one according to your preference.
- Click **Android Keyboard (AOSP)** to enter the related setting interface.

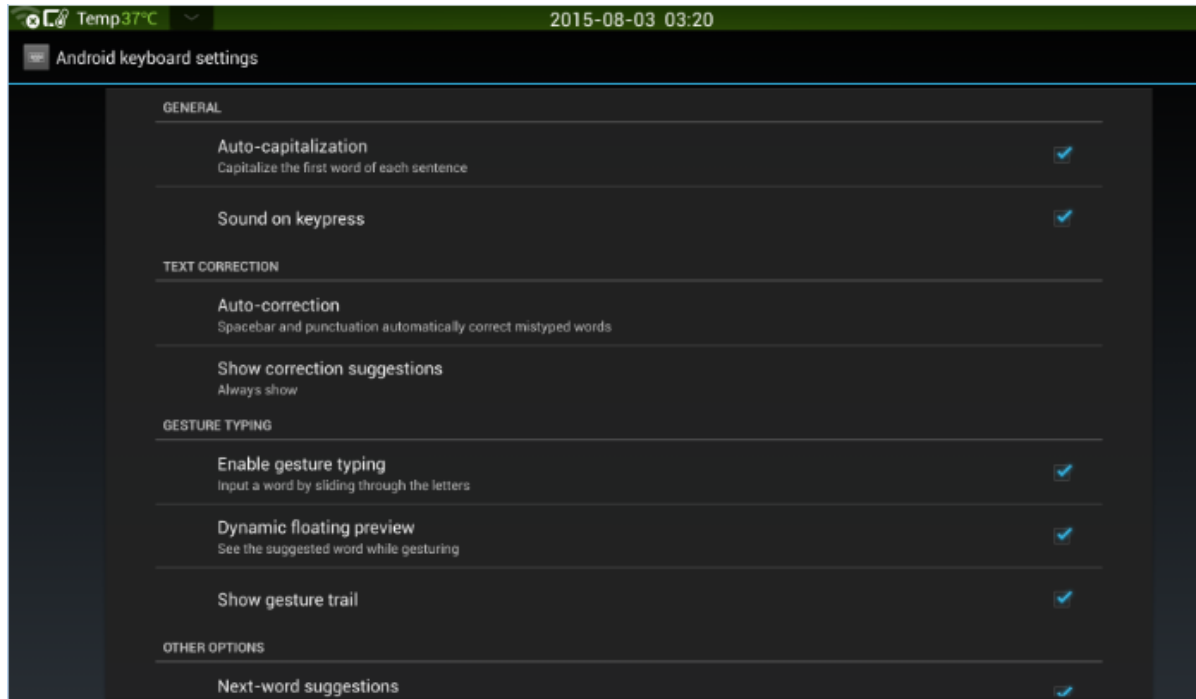

4.6.3 Date and Time

Click **Date and time** to enter the setting interface.

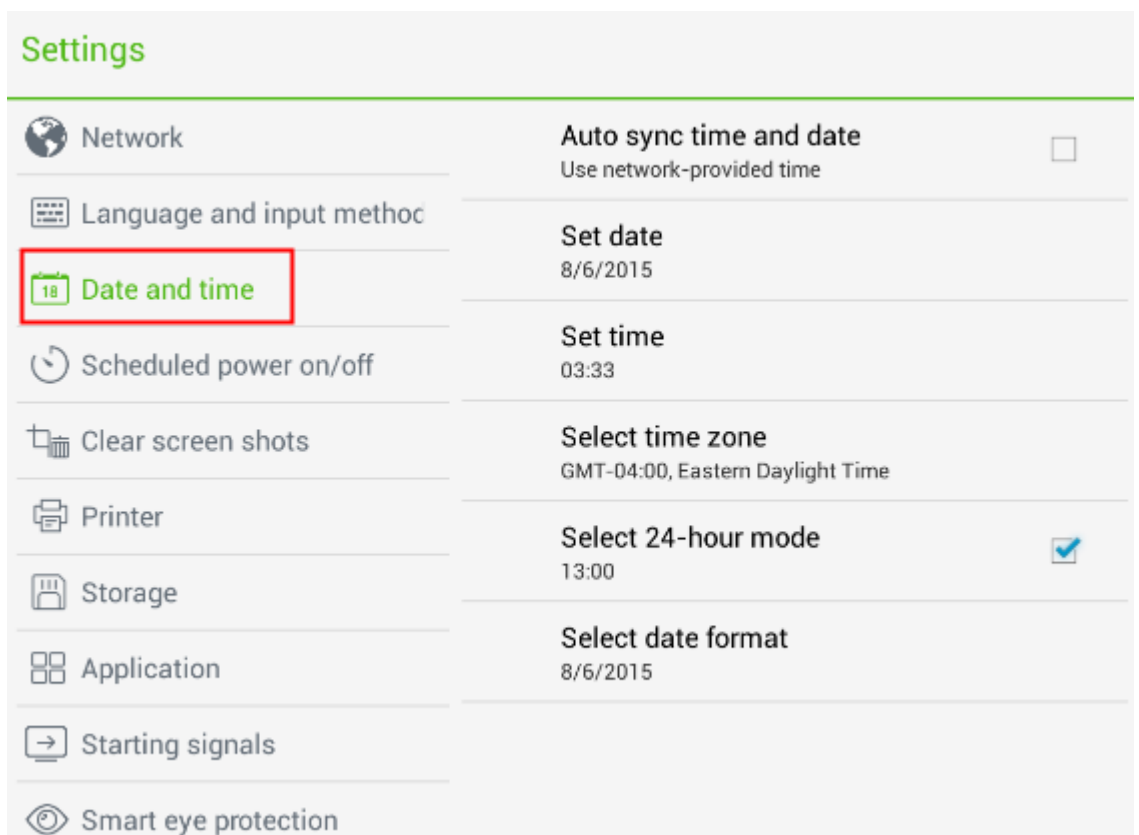

- Click **Select 24-hour mode** to set the time format of 24 hours. Otherwise, the time format is displayed as 12-hour time.

- Click **Select date format** to set the date format to be displayed.



- When **Auto sync time and date** is selected, the date and time of the system are displayed and you do not need to change them manually.

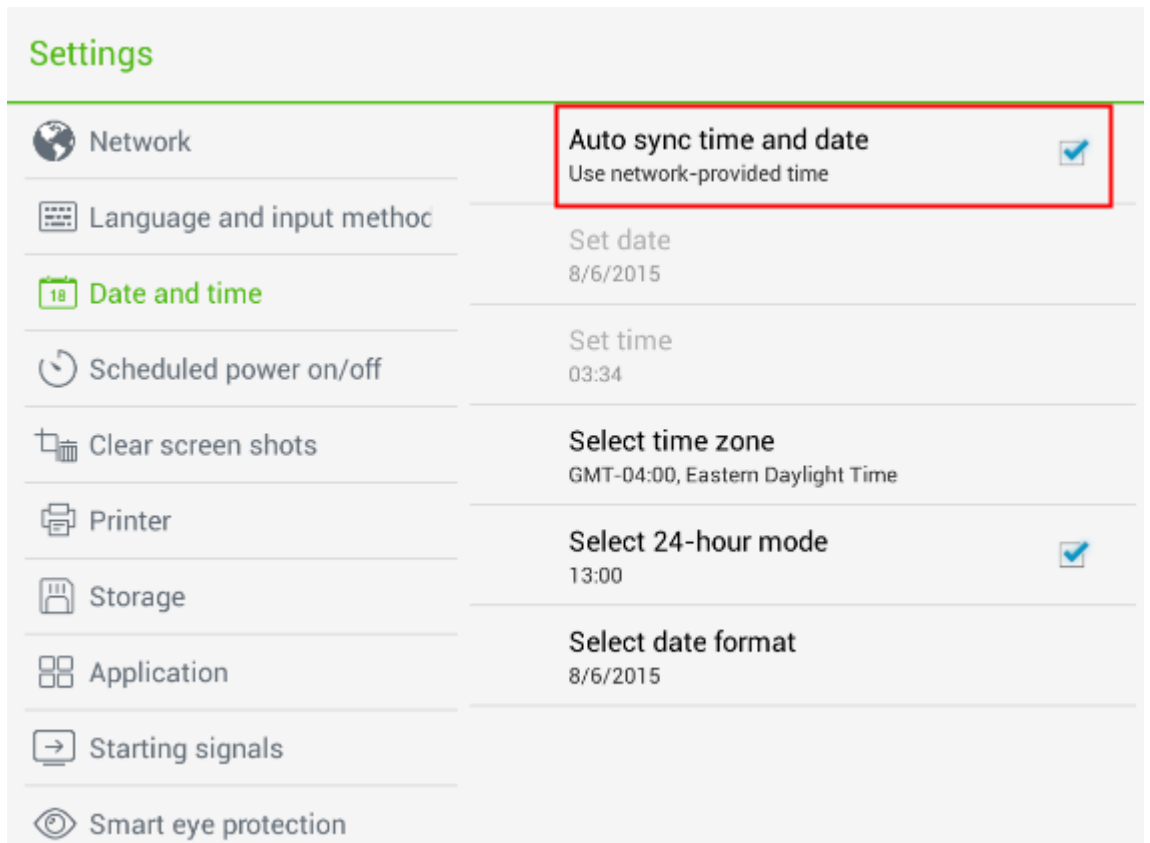

- Deselect **Auto sync time and date** and then you can click **Set date**, **Set time**, **Set time zone** to set the date, time and time zone manually.

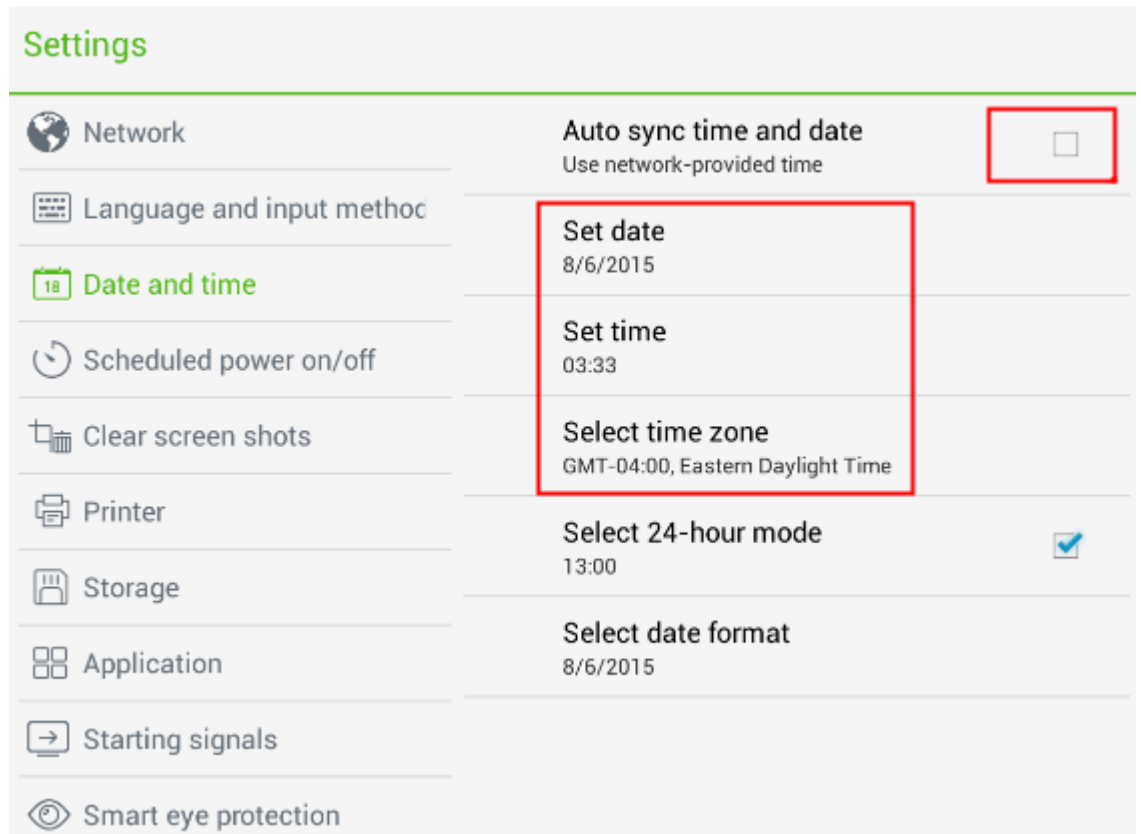

4.6.4 Timer Switch

Click **Scheduled power on/off** to enter the interface for setting the automatic startup and shutdown time.

Settings

- Network
- Language and input method
- Date and time
- Scheduled power on/off**
- Clear screen shots
- Printer
- Storage
- Application
- Starting signals
- Smart eye protection

Automatic power on ON

Power on time
00 : 00

Automatic power off ON

Power off time
00 : 00

- Click **Power on time** to set the automatic startup time in the displayed window.

Power on time

Power on time

23 59

00 : 00

01 01

Sunday Monday **Tuesday** Wednesday Thursday Friday Saturday

Cancel OK

- Click **Power off time** to set the automatic shutdown time in the displayed window.

Power off time

Power off time

23 59

00 : 00

01 01

Sunday Monday Tuesday **Wednesday** Thursday Friday Saturday

Cancel OK

4.6.5 Clear Screenshots

Click **Clear screen shots**. A list is displayed and sorted by one month, two months, three months, six months and twelve months. Select a time to clear the screenshots included this period.

Settings

Network Regular clearance of screen shots
One month

Please select

One month

Two months

Three months

Six months

Twelve months

Cancel

Application

Starting signals

Smart eye protection

4.6.6 Printer

Click **Printer** to enter the printer setting interface. The connecting printer is displayed on the interface. You can also add other printers.

The printer type includes Generic BW LaserJet PCL5, Generic Color LaserJet PCL5 and Generic Postscript BW. Printers compatible with the laser printer are supported. (HP, Canon, Brother, Lexmark, Samsung, Xerox)

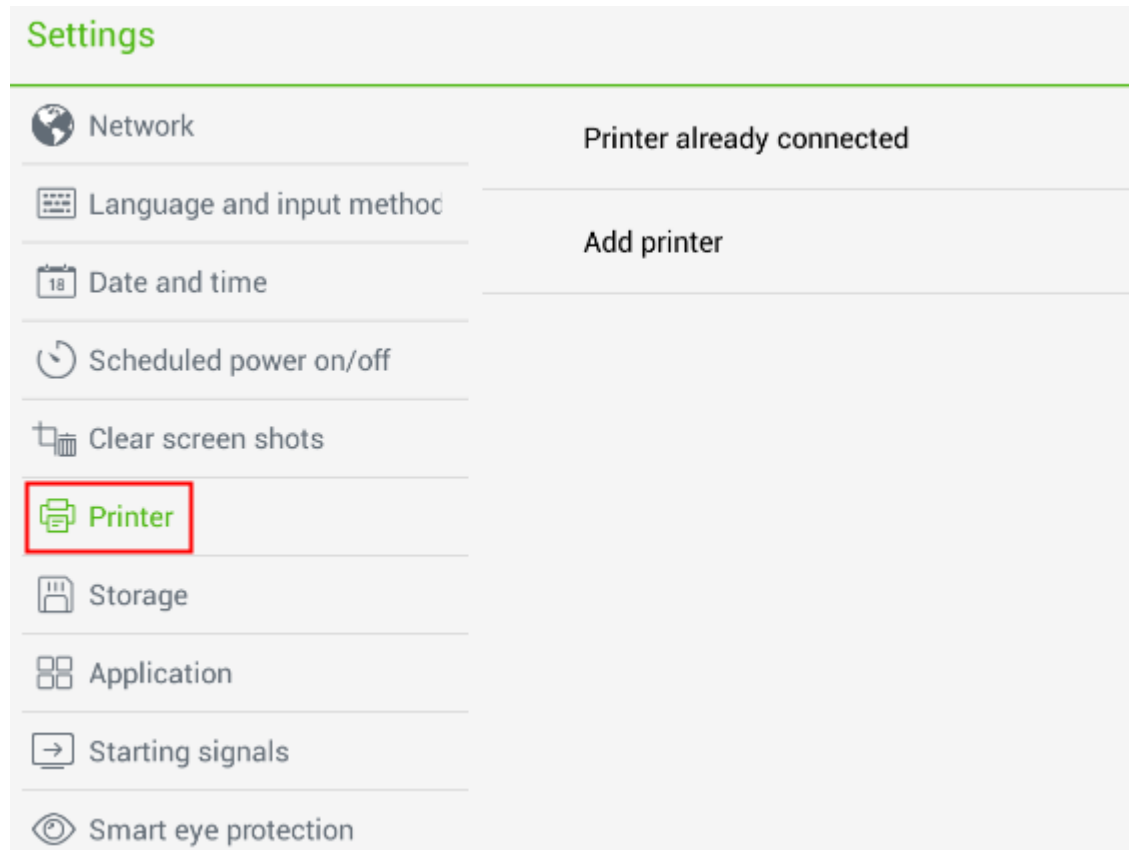

4.6.7 Storage

Click **Storage** to check the usage of internal storage space and USB storage device in the displayed window.

Settings

- Network
- Language and input method
- Date and time
- Scheduled power on/off
- Clear screen shots
- Printer
- Storage**
- Application
- Starting signals
- Smart eye protection

INTERNAL STORAGE SPACE

Total storage	1.04GB
Space available	335MB
Application (application data and media content)	96.98MB
Buffer data	684KB
Others	678MB

USB STORAGE

4.6.8 Application Program

Click **Application** to check the application programs in **DOWNLOADED, IN SD CARD, PROCESSING** and **ALL**.

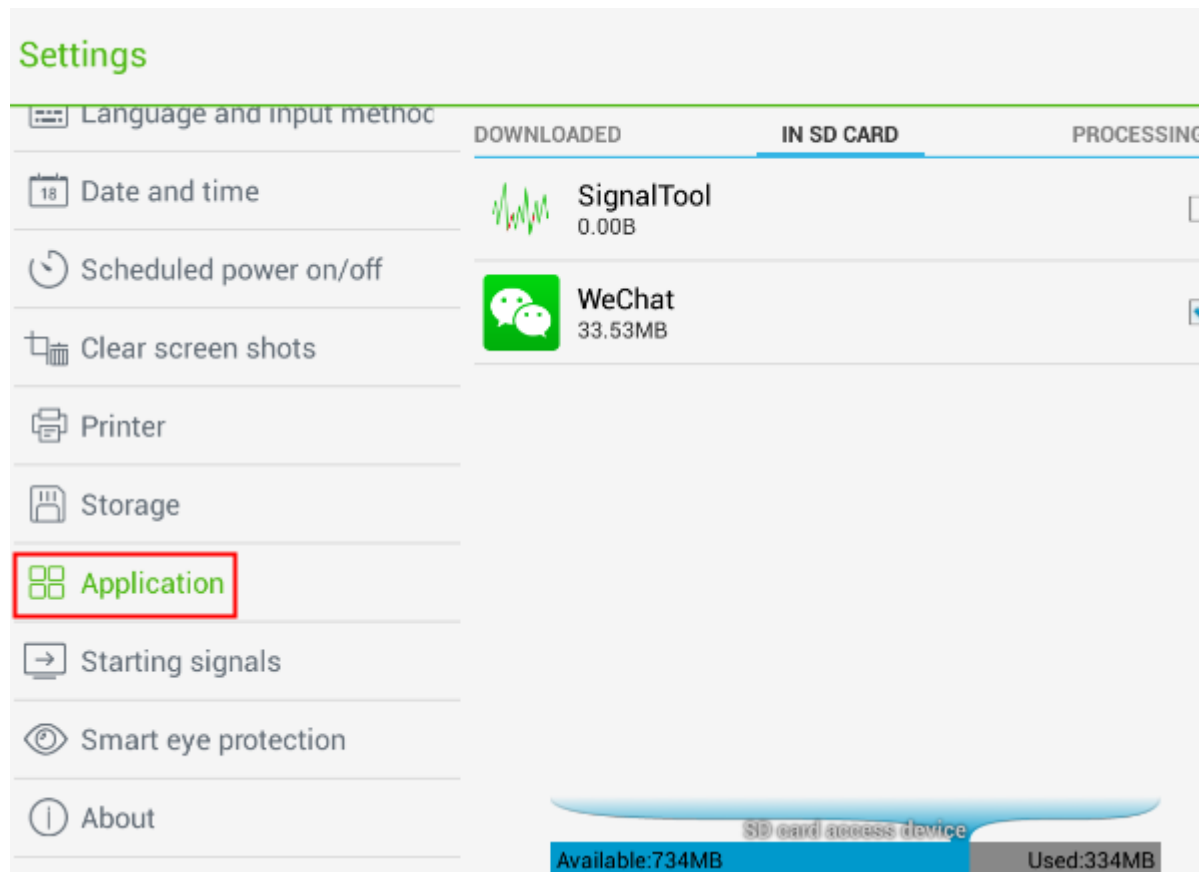

4.6.9 Starting Signals

Click **Starting signals**. On the displayed interface, click **Default startup** to set the default signal source after each startup.

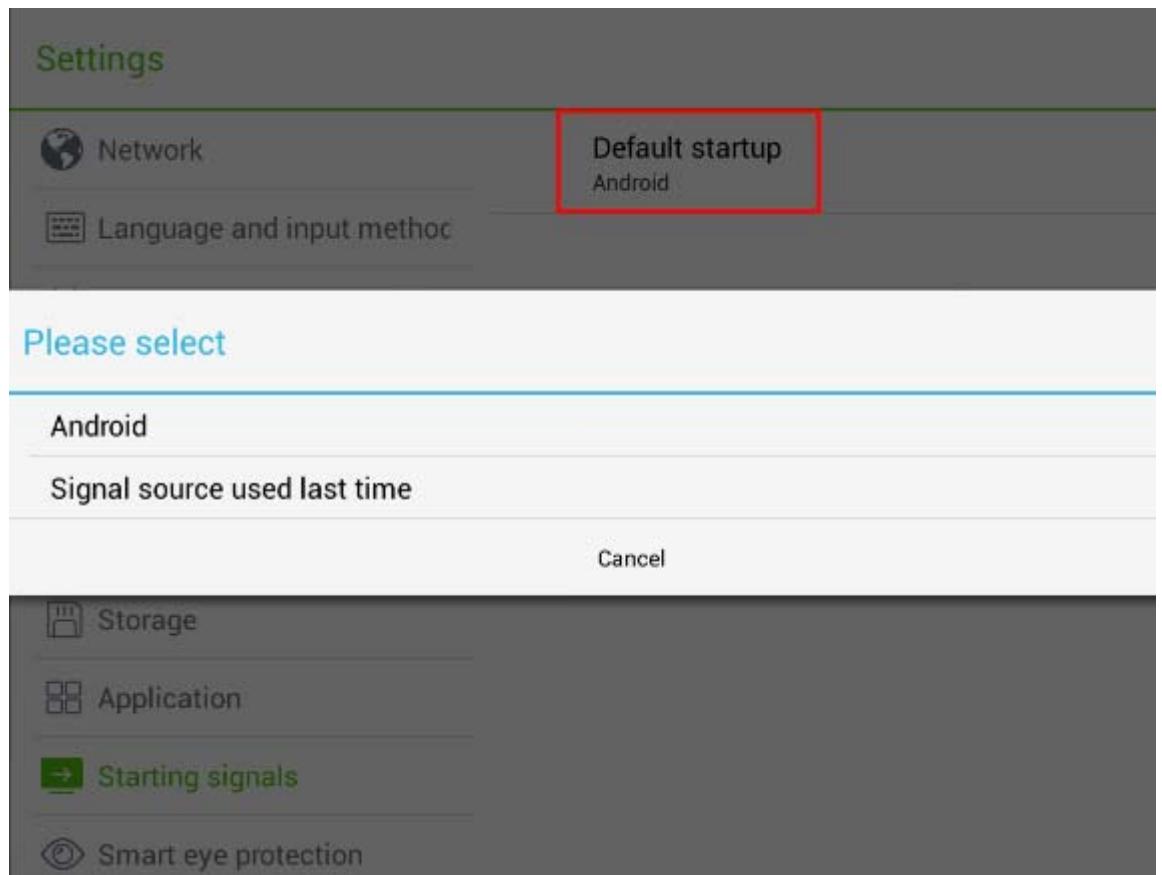

4.6.10 Smart Eyes Protection

Click Smart eyes protection to set **Eye protection mode**, **Eye protection writing mode** and **Eye protection brightness control mode** on the displayed interface.

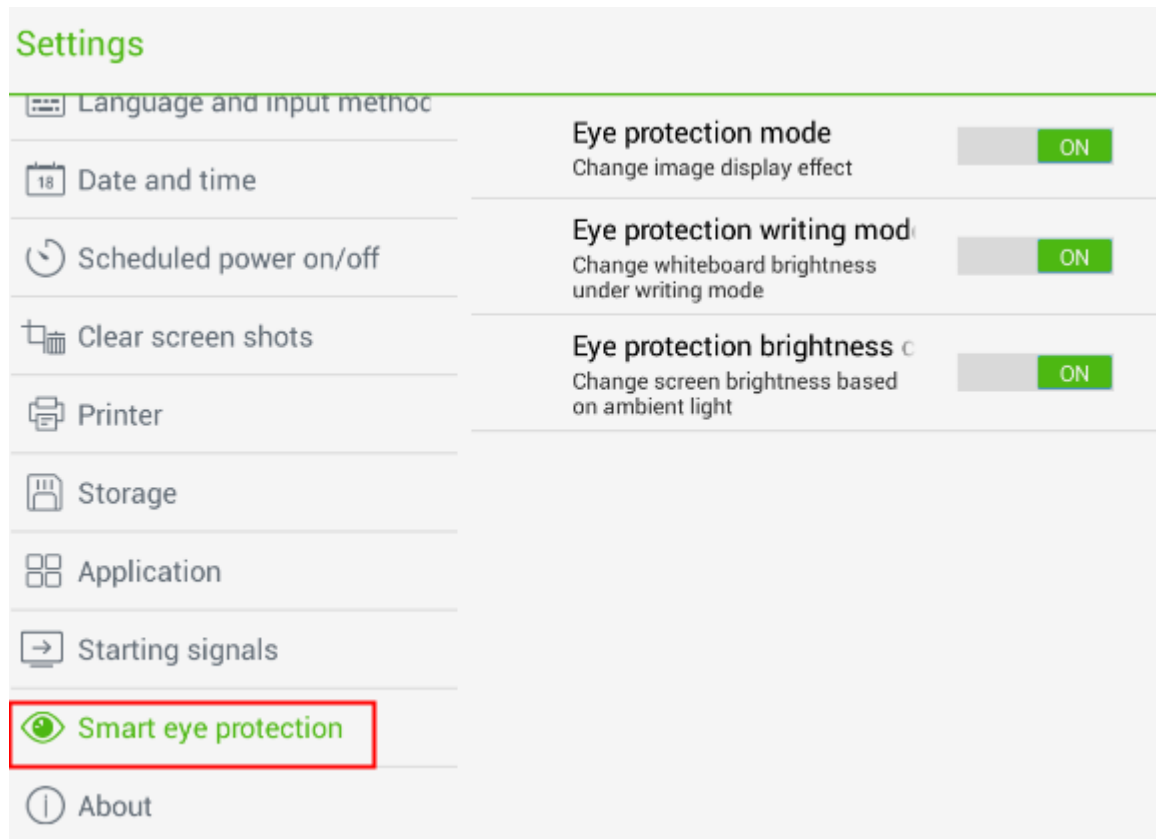

4.6.11 Reset

Click **About** to check **Android version**, **Activation**, **Reset**, and **Firmware update** on the displayed interface.

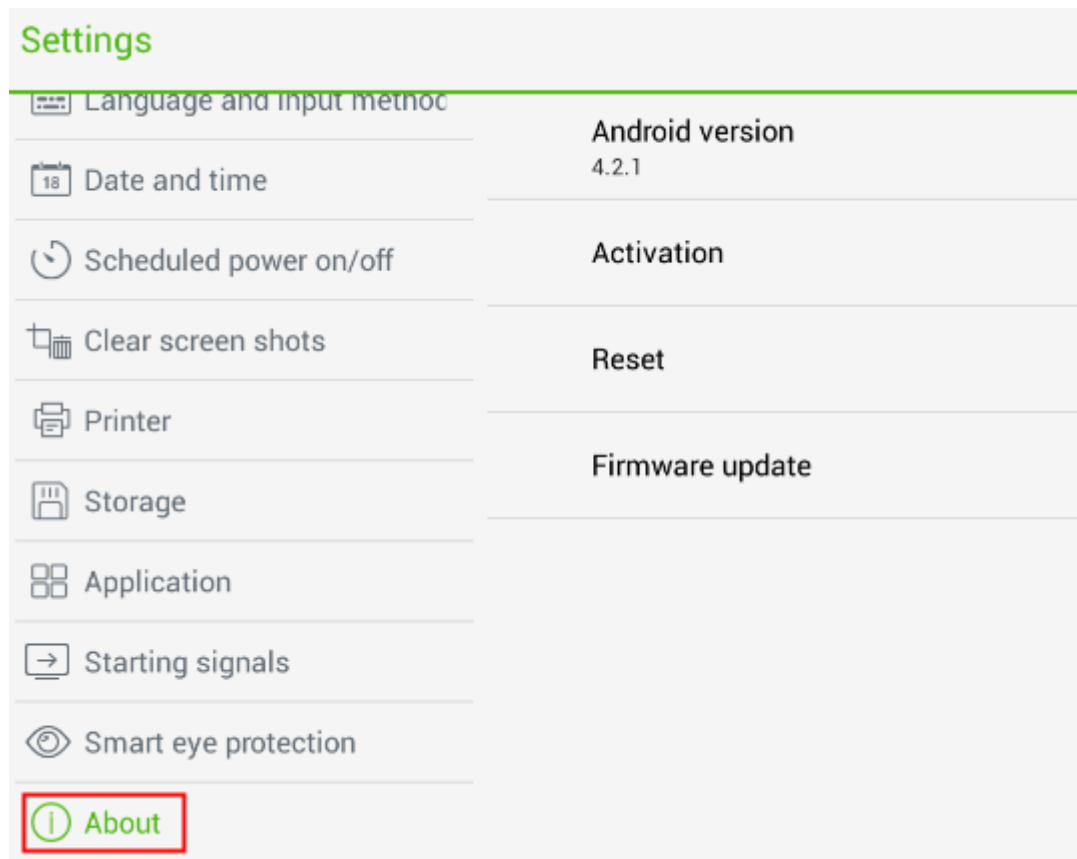

- Click **Reset** and then click **OK** to restore factory settings.

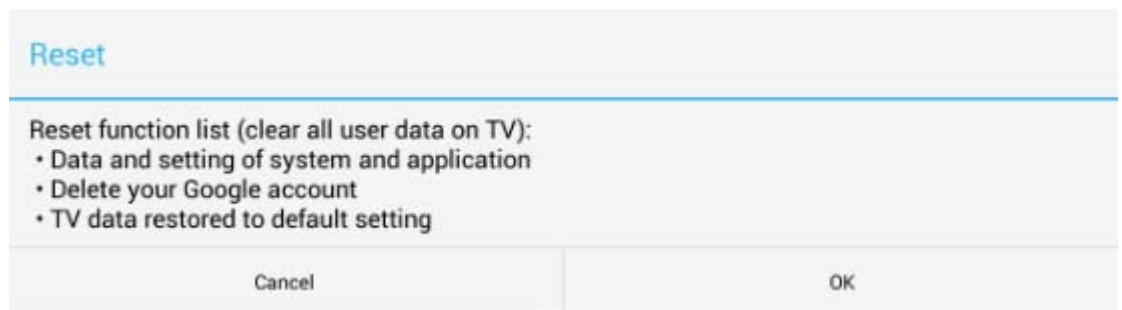

- If a new Android version is available, **New** is displayed on the left of **Firmware update**. Click **Firmware update** to update the system.

4.7 Browser

Click  on the SmartBar to open the web browser. Enter a website in the address bar and enter keywords in the search box by using the soft keyboard or remote controller.

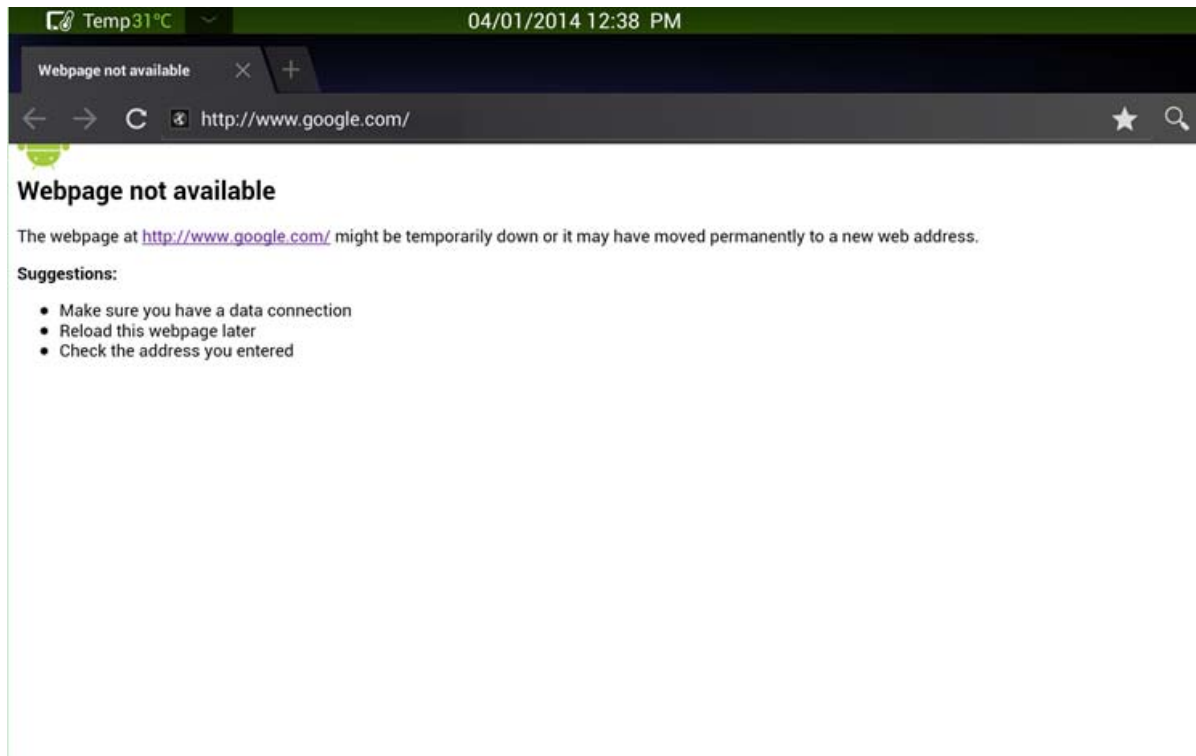

4.8 Audio Only

Click **AUDIO ONLY** on the remote controller to turn off the screen but keep audio on. To turn on screen again, touch any place on screen or click **AUDIO ONLY** again to return to normal operation mode.

4.9 Kids Safety Lock

You can turn on/off **Kids Safety Lock** function via three methods below:

- Turn on/off the function in **Parental Control** menu.

Step 1 After switching to selected signal source, click **MENU** on remote controller and choose **Parental Control**.

Step 2 Choose **Lock System** in **Parental Control** menu, and press OK on remote controller. Enter password in the pop-up window. (Default password: 0000)

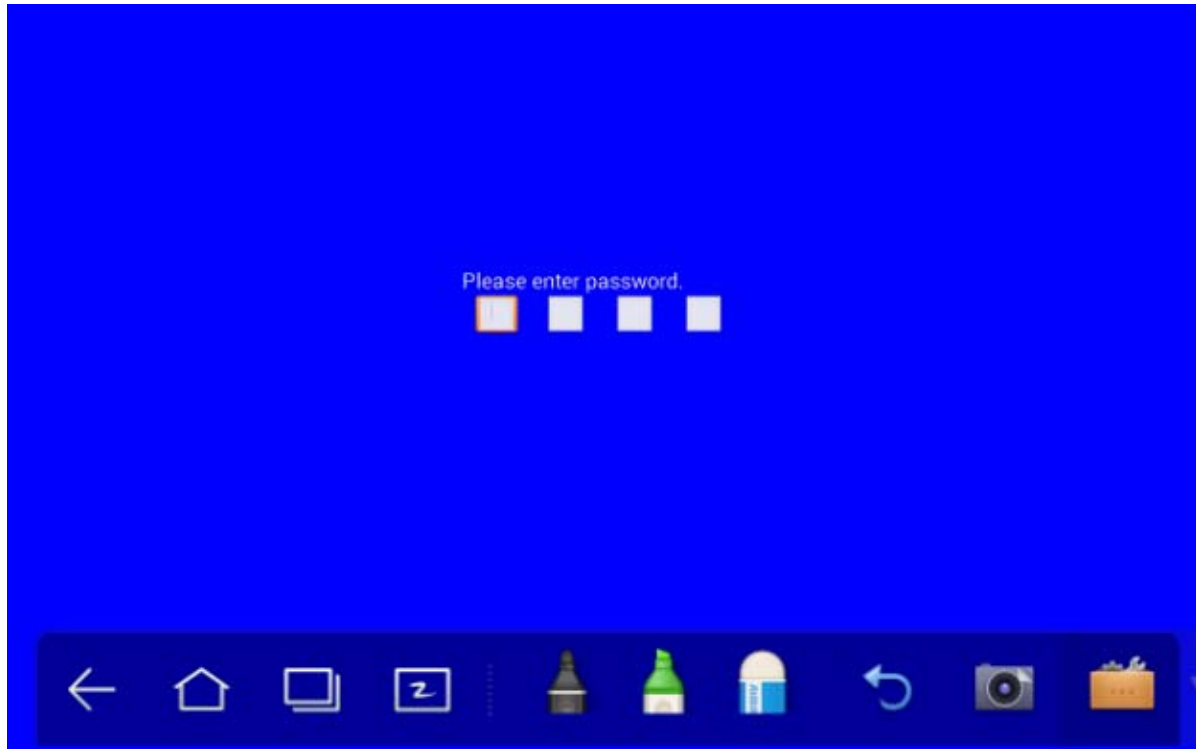

Step 3 Kids Safety Lock will be activated after successful setting. To turn on the function, switch to **On** to lock the device. To turn off the function, change the setting to **Off**.

- Press **ECO** button on the front panel for more than 5 seconds to enter screen locked mode. Under screen locked mode, press **ECO** for more than 5 seconds again to unlock.
- Press **ECO** button on the remote controller for more than 5 seconds to enter screen locked mode. Under screen locked mode, press **ECO** for more than 5 seconds again to unlock.

An icon in the following figure will show on the top-right corner on the screen if the device is under screen locked mode.



4.10 Application Programs

Click  on the SmartBar to enter the application program page. All application programs in the system are displayed. Scroll right and left to turn the page, as shown in the following figure:



Calculator

Click  to enter the calculation page. Click digits and operators on the keyboard to perform calculation.

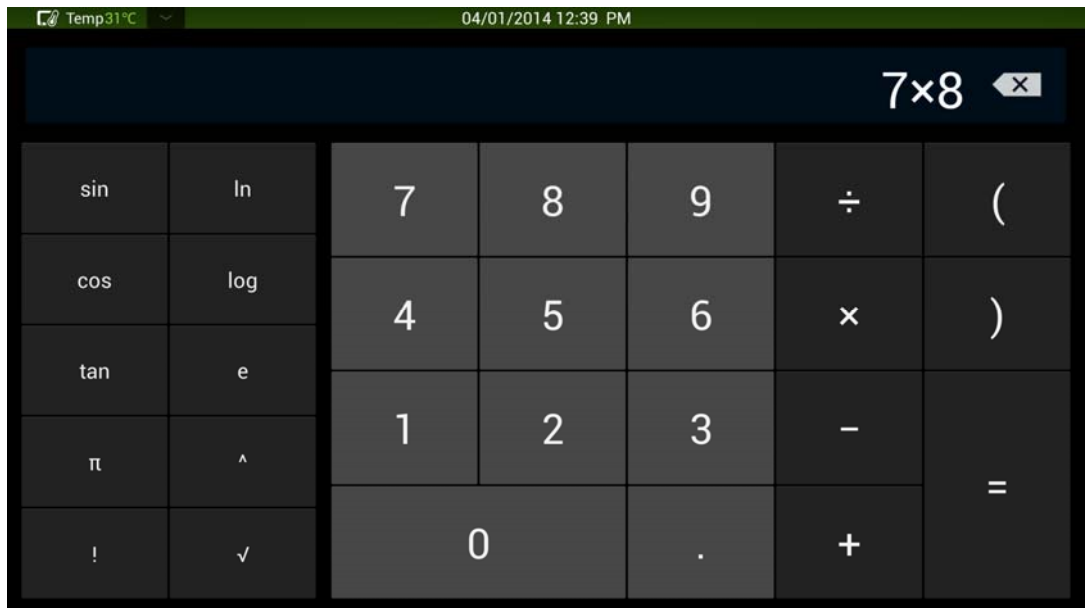

Clock

Click  to enter the clock page. Click **Start** to start timing and click **Stop** to stop timing.



Music

Click  to start the music program. The music in the local disk is displayed by artists, albums, songs, playlist and playing status.

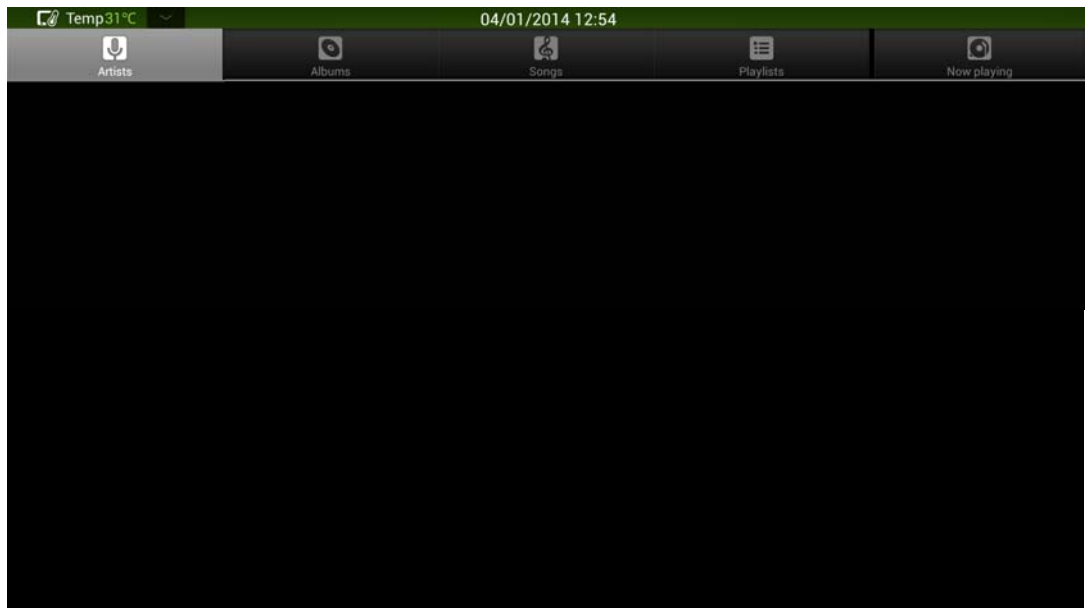

4.11 Temperature Reminder and Thermal Shutdown

Temperature Reminder

The real-time temperature in the interactive panel is displayed on upper left corner of the home page. Click the temperature display area on the top-left corner of screen to switch between Celsius and Fahrenheit.

Thermal Shutdown

In the running status, the overall temperature of the panel increases due to unfavorable ventilation environment and long working hours. When the system detects that the actual temperature is higher than the set value, the internal thermal shutdown is activated. Before the panel is powered off, a reminder is displayed on the screen indicating that "**The panel is going to be turned off due to overheat**".

Restoration Method to Thermal Shutdown

Restoration method: After the panel is connected to power supply correctly, press **Reset** at the bottom of the rear of the panel to reset the panel. (If the thermal shutdown is activated due to overheat, please improve the ventilation environment before you perform the restoration.)

TIP

Some protection switches are turned off during long distance transport, which causes the failure to start the panel. For first use, please power on the panel and then start installation based on the preceding restoration method.

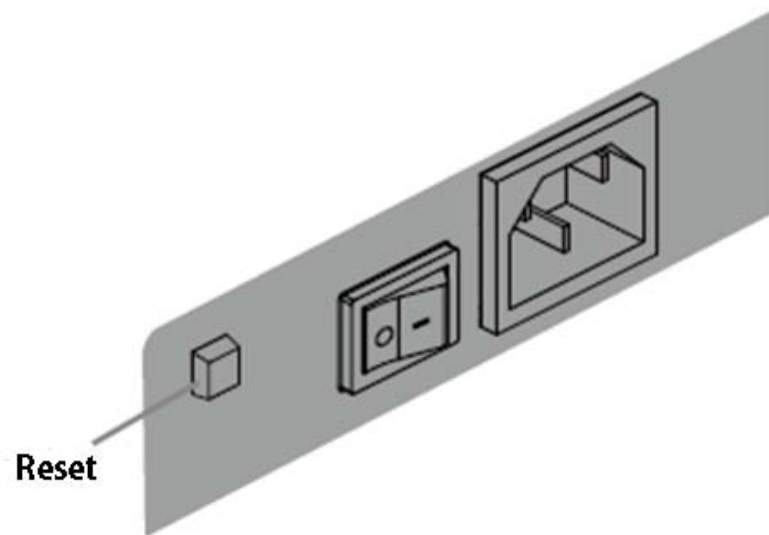

5 Signal Channel Selection

The following three ways are used to select a signal channel:

- Press **SOURCE** on the remote controller.
- Press **Source** on the control panel of the interactive panel.
- Click  in the application program page.

In the signal source page, press **▲** or **▼** to select a channel and press **OK**. You can also select directly by clicking an icon, as shown in the following figure:



NOTE

The interactive panel will automatically detect signals when it is started or no signal is available.

6 Menu

After switching to selected signal source, press **MENU** on the remote controller. A menu is displayed, including **Picture**, **Sound Mode**, **Parental Control** and **Settings**. Scroll left and right on the screen or press ◀ or ▶ to switch between entries.

Picture

The Image page displays options including **Picture Mode**, **Color Temperature**, **Zoom Mode**, **Image Noise Reduction**, and **MPEG Noise Reduction**.



NOTE

- When the picture mode is **user**, the contrast, brightness, hue, sharpness and saturation are adjustable.
- If an option in the menu is in grey, it cannot be selected or adjusted.

Two ways are used to set the options:

- Click an icon and set the option.
- Press ▲ or ▼ to move the cursor onto an option. Press **OK** and press ◀ or ▶ to modify the value. Press **RETURN** to exit the menu.

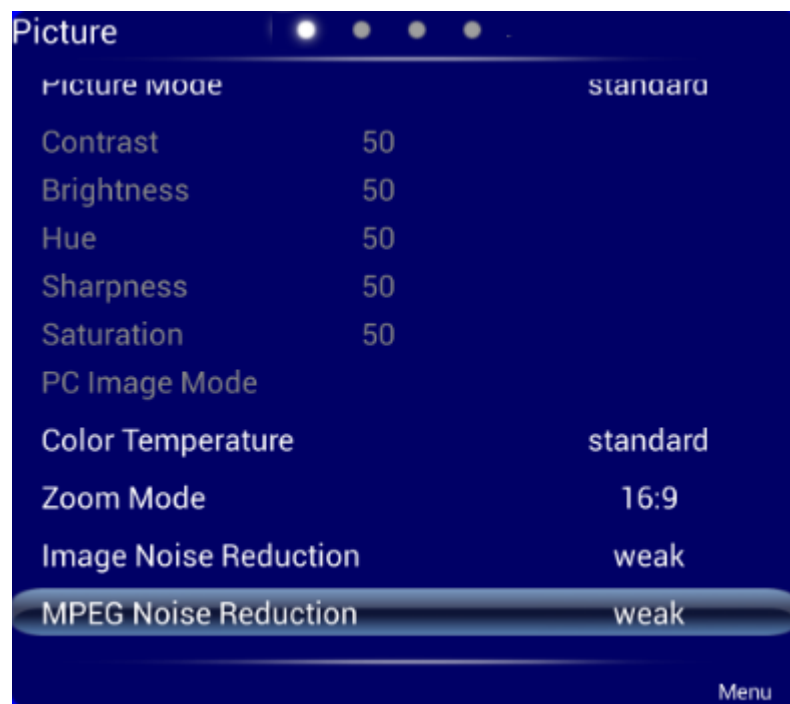

Sound Mode

The **Sound Mode** page displays options including **Sound Mode**, **Equalizer**, **Balance**, **Surround** and **Alone**.

**NOTE**

When the sound mode is **User**, **High Pitch** and **Low Pitch** are adjustable.

Two ways are used to set the options:

- Click an icon and set the option.
- Press ▲ or ▼ to move the cursor onto an option. Press **OK** and press ◀ or ▶ to modify the value. Press **RETURN** to exit the menu. When the sound mode is **User**, **High Pitch** and **Low Pitch** are adjustable.



Settings

The Settings page displays options including **Menu Time**, **Switch Mode**, **Color Range**, **MHL Auto Switch**, **Movie Mode** and **Restore To Default**.

**NOTE**

If an option in the menu is in grey, it cannot be selected or adjusted.

Two ways are used to set the options:

- Click an icon and set the option.
- Press ▲ or ▼ to move the cursor onto an option. Press **OK** and press ◀ or ▶ to modify the value. Press **RETURN** to exit the menu.

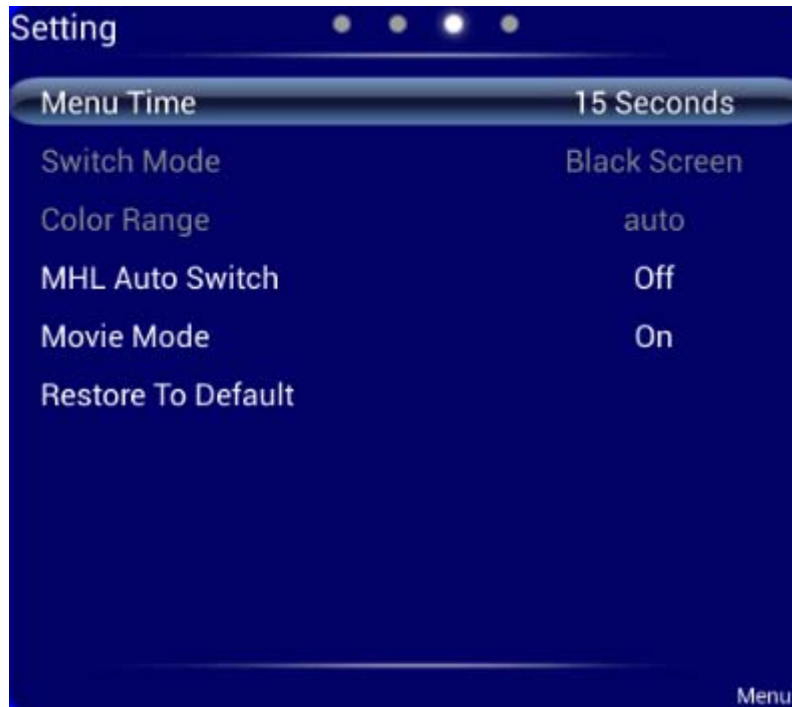

Parental Control

The **Parental Control** menu shows options including **Lock System**, **Set Password**, **Block Program**, and **Kids Safety Lock**. There are two ways to set it:

- Click an icon and set option.
- Press ▲/▼ to move the cursor onto an option. Press **OK** and press ◀/▶ to adjust the value. Press **RETURN** to quit the menu.

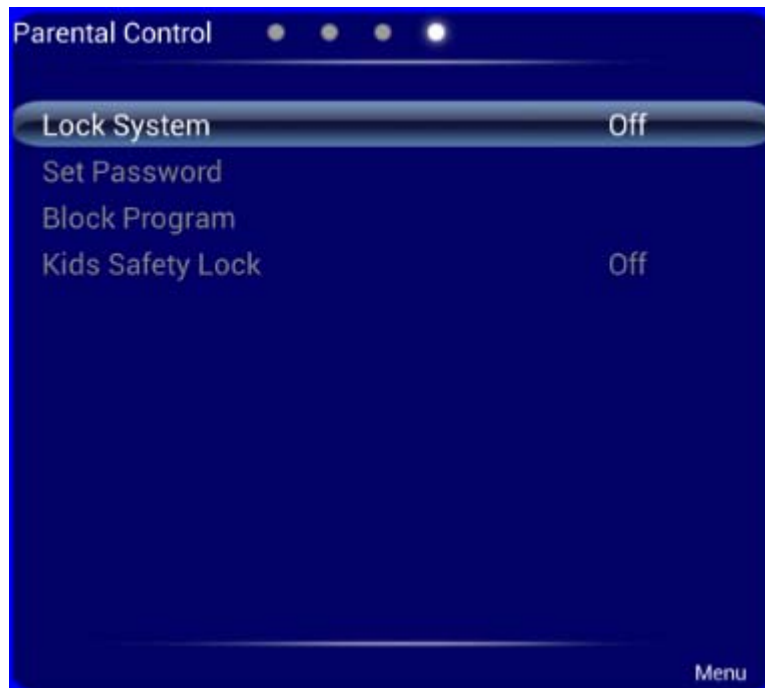

NOTE

This menu is only available when TV signal source is used.

7 ECO Mode



CAUTION

- *Please switch off the panel when it is not used, and enable the function of Listen Alone when you do not need to watch the display, which help reduce power consumption and save energy.*
- *On the premise of ensuring viewing effect, the energy consumption can be reduced by lowering display brightness.*
- *To better save energy, the automatic power-off function is configured for the panel and the default duration is 10 minutes. If no operation is performed in 10 minutes, the panel is switched automatically to sleep mode (the same as power off) for reducing energy consumption.*

Press **ECO** on the remote controller to enter the backlight mode page. Press **ECO** to switch among **ECO**, **Auto** and **Standard**.

- In the ECO mode, the power output is reduced 50%.
- In the Auto mode, the display automatically adjusts the screen brightness according to the light in the environment. When the light is strong, the screen brightens. When the light is weak, the screen darkens.
- In the Standard mode, the screen brightness keeps the same.

8 Serial Port Control

The RS-232 port of the interactive panel is defined as follows:

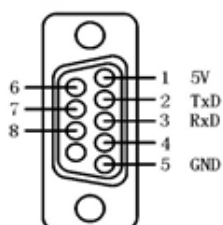

Connect RS-232 port to the PC or controlling device. Enable RS-232 serial port connection and complete the following configuration.

Port Number: COM 1 (Set the value according to the port number of the PC or controlling device.)			
Bit rate	19200	Odd/even check	None
Data bit	8	Stop bit	1

The following table lists button controlling codes. The buttons share same functions with corresponding buttons on the remote controller.

Function	Controlling Code	Function	Controlling Code
Power on	7F 08 99 A2 B3 C4 02 FF 01 00 CF	1	7F 08 99 A2 B3 C4 02 FF 01 21 CF
Power off	7F 08 99 A2 B3 C4 02 FF 01 01 CF	2	7F 08 99 A2 B3 C4 02 FF 01 22 CF
Mute	7F 08 99 A2 B3 C4 02 FF 01 02 CF	3	7F 08 99 A2 B3 C4 02 FF 01 23 CF
Sound mode	7F 08 99 A2 B3 C4 02 FF 01 05 CF	4	7F 08 99 A2 B3 C4 02 FF 01 24 CF

Function	Controlling Code	Function	Controlling Code
Signal source	7F 08 99 A2 B3 C4 02 FF 01 06 CF	5	7F 08 99 A2 B3 C4 02 FF 01 25 CF
Display status	7F 08 99 A2 B3 C4 02 FF 01 09 CF	6	7F 08 99 A2 B3 C4 02 FF 01 26 CF
HDMI 1	7F 08 99 A2 B3 C4 02 FF 01 0A CF	7	7F 08 99 A2 B3 C4 02 FF 01 27 CF
HDMI 2	7F 08 99 A2 B3 C4 02 FF 01 0B CF	8	7F 08 99 A2 B3 C4 02 FF 01 28 CF
HDMI 3	7F 08 99 A2 B3 C4 02 FF 01 0C CF	9	7F 08 99 A2 B3 C4 02 FF 01 29 CF
OPS (HDMI 4)	7F 08 99 A2 B3 C4 02 FF 01 38 CF	0	7F 08 99 A2 B3 C4 02 FF 01 2A CF
PC 1	7F 08 99 A2 B3 C4 02 FF 01 0D CF	OK	7F 08 99 A2 B3 C4 02 FF 01 2B CF
YPbPr	7F 08 99 A2 B3 C4 02 FF 01 10 CF	←	7F 08 99 A2 B3 C4 02 FF 01 2C CF
Video 1	7F 08 99 A2 B3 C4 02 FF 01 11 CF	→	7F 08 99 A2 B3 C4 02 FF 01 2D CF
Up	7F 08 99 A2 B3 C4 02 FF 01 13 CF	↑	7F 08 99 A2 B3 C4 02 FF 01 2E CF
Down	7F 08 99 A2 B3 C4 02 FF 01 14 CF	↓	7F 08 99 A2 B3 C4 02 FF 01 2F CF
Listen Alone	7F 08 99 A2 B3 C4 02 FF 01 15 CF	Menu	7F 08 99 A2 B3 C4 02 FF 01 1B CF
ECO	7F 08 99 A2 B3 C4 02 FF 01 16 CF	Home Page	7F 08 99 A2 B3 C4 02 FF 01 1C CF
VOL -	7F 08 99 A2 B3 C4 02 FF 01 17 CF	Return (Exit)	7F 08 99 A2 B3 C4 02 FF 01 1D CF
VOL +	7F 08 99 A2 B3 C4 02 FF 01 18 CF	Capture	7F 08 99 A2 B3 C4 02 FF 01 1F CF
Auto ADJ	7F 08 99 A2 B3 C4 02 FF 01 20 CF	-	-

9 VGA Signal Input

VGA (Video Graphics Array) is the computer display standard for analog signal. VGA port is the special port on the computer which uses the VGA standard for data input. The following table lists the specifications of various VGA signal input.



NOTE

The VGA signal input is available only when the panel is in PC mode.

SN	Standard	Resolution	Refresh Rate (Hz)	Horizontal Frequency (Khz)	Vertical Frequency (Hz)	Horizontal/Vertical Sync Polarity (TTL)
1	VESA	640x480	60	31.5	60	N/N
2	VESA	640x480	72	37.9	72	N/N
3	VESA	640x480	75	37.5	75	N/N
4	VESA	800x600	56	35.1	56	P/P
5	VESA	800x600	60	37.9	60	P/P
6	VESA	800x600	72	48.1	72	P/P
7	VESA	800x600	75	46.9	75	P/P
8	VESA	1024x768	60	48.4	60	N/N
9	VESA	1024x768	70	56.5	70	N/N
10	VESA	1024x768	75	60	75	N/N
11	VESA	1280x960	60	60	60	N/N
12	VESA	1280x960	75	75.159	75	N/N
13	VESA	1280x1024	60	64	60	P/P
14	VESA	1280x1024	75	80	75	P/P
15	VESA	1600x1200	60	75	60	P/P
16	VESA	1920x1080	60	66.547	59.988	P/P

10 Multimedia Format Support

Media Type	File Format	File Extension
Image	JPEG, BMP, PNG	.jpg, .bmp, .png
Movie	MPEG1, MPEG2, MPEG4, H264, RM, RMVB, VC1, Divx, FLV	.avi, mpg, .dat, .vob, .div, .mov, .mkv, .rm, .rmvb, .mp4, .ts, .trp, .asf, .flv
Music	WMA, MP3, M4A, (AAC)	.mp3, .m4a
Text	TXT	.txt

11 Common Faults and Solutions

Symptom	Possible Cause	Solution
The service program fails to be connected.	The drive program is not correctly installed.	Install the drive program correctly.
	The USB port (lead) is not connected or is faulty.	Change the USB lead or check if the USB port is faulty.
	The infrared tube is blocked.	Ensure that the surrounding infrared tubes are not blocked.
Repositioning is required every time the panel is switched on.	The computer is equipped with a recovery card.	Disable computer protection and perform the positioning again.
The positioning is inaccurate.	The positioning is not performed properly.	Press Auto on the remote controller to show the full screen, and use the pen provided with the panel to perform positioning again.
The cursor of the pen is unstable when the pen is used.	The writing method is incorrect.	You are advised to use the pen rather than a finger to write. Hold the pen as far to the nib as possible. The angle between the pen and display needs to be greater than 60 degrees. Do not touch the display with your sleeve or wrist.
	Strong light or infrared interference exists.	Remove the interference source or change the using environment.
The handwriting is discontinuous. (Part of the handwriting cannot be displayed.)	The writing method is incorrect.	You are advised to use the pen rather than a finger to write. Hold the pen as far to the nib as possible. The angle between the pen and display needs to be greater than 60 degrees. Do not touch the display with your sleeve or wrist.

Symptom	Possible Cause	Solution
	The covering area of the nib does not meet the requirement or the nib is too small.	Change the nib or use a pen with larger covering area.
	The infrared tube is blocked.	Check if infrared tubes are blocked.
	Strong light or infrared interference exists.	Remove the interference source or change the using environment.
The handwriting cannot be displayed.	The color of the pen is the same as or similar to the background color.	Change the color of the pen.
	You hand or other objects are on the display when you are writing.	You are advised to use the pen rather than a finger to write. Hold the pen as far to the nib as possible. The angle between the pen and display needs to be greater than 60 degrees. Do not touch the display with your sleeve or wrist.
	Strong light or infrared interference	Remove the interference source or change the using environment.
	The writing method is incorrect.	You are advised to use the pen rather than a finger to write. Hold the pen as far to the nib as possible. The angle between the pen and display needs to be greater than 60 degrees. Do not touch the display with your sleeve or wrist.
Not sound is played and no image is displayed.	<ul style="list-style-type: none"> • Check whether the power plug is inserted into the power socket and whether the panel is powered on. • Check whether the rocker switch on the interactive panel is switched on. • Check whether the Standby button on the panel is pressed. • Check whether the video and audio input cables are connected correctly. • Check whether the panel is switched to the right signal source. • Check the settings on image brightness and contrast. • Check the volume. 	
Image is displayed properly, but no sound is played.	<ul style="list-style-type: none"> • Check the volume. • Check whether the Mute button on the remote controller is pressed. • Check whether the audio cable between the PC and interactive panel is connected correctly. 	
No image is displayed or the image is black and white.	<ul style="list-style-type: none"> • Modify the color settings. • Check the color system. 	

Symptom	Possible Cause	Solution
The image or sound is interrupted.	<ul style="list-style-type: none"> Find out the electric appliance that causes the interference and move it away from the interactive panel. Do not share the power socket of the panel with the electric appliance that causes interference. 	
The remote controller fails.	<ul style="list-style-type: none"> Change the batteries. Clean the signal emitter at the top of the remote controller. (Check whether it is blocked.) Check contacts of the batteries. 	
The PC cannot be started. (This scenario is applicable only to panel models operating with the PC.)	<ul style="list-style-type: none"> Check whether the PC adapter is correctly connected and whether the PC is powered on. Check whether the PC is connected correctly to the interactive panel. 	

The following symptoms are not faults:

- A very few of constantly bright or dark pixels, such as tiny red, blue, green or dark points, may exist on the LCD. This symptom is not a fault and does not affect running functions of the panel.
- Slight sound may occur due to the backlight adjustment or ventilation. This is a normal symptom.
- The image and sound are normal. However, you can sense static electricity when you touch the LCD and metal back cover. This is a normal symptom.

12 Care and Maintenance

Maintenance Tips

- Do not put or install the product near a heat source or under direct sunlight, or in dusty or humid places, or somewhere the product may be hit or damaged by mechanical vibration. To maximize the performance, it needs to be put away from equipment such as grid, large metal objects and radar stations as far as possible.
- Do not wipe the panel with any chemical reagent. Solvents may damage the enclosure or paint. If the panel is stained by dust, cut off the power and then clean the panel using a dried cloth with a little of warm water. Use a clean soft cloth to clean the LCD of the panel.
- Do not frequently switch on and off the product, which may shorten the product service life. After the panel is switched off, wait for three minutes before switching it on again. If the product is not to be used for a long period of time, please power off the product and pull out the power plug.
- Do not maximize the brightness and contrast of the LCD for a long period of time, which may shorten the LCD service life.
- Do not use a hard object to write on the touch screen, which may scratch the LCD.

Clean the Infrared Tube

The interactive panel uses the horizontal and vertical infrared matrix to detect and locate the user's touch. The screen is surrounded by an infrared tube (including the infrared acceptor and emitter), which forms an infrared net covering on the screen surface. When a user touches the screen, fingers or other opaque objects block the infrared rays that cross the touch point, which helps the controller detect the coordinate position of the touch point.

Dust is easily retained on the screen surface due to its long-term exposure in the air and causes ineffective touch or inaccurate positioning. Therefore, you need to clean the infrared tube around the screen regularly.

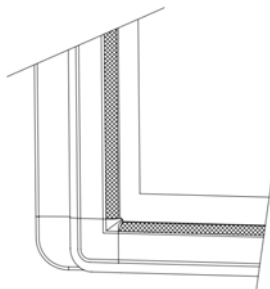

13 Technical Parameters

Specification	Parameter
Backlight type	LED
Aspect ratio	16:9
Viewing angle	178°
Physical resolution	1920x1080 Pixel
Image/Sound system	PAL/DK, I
Working voltage	100V-240V, 50 Hz /60Hz
Standby power consumption	≤0.5W
Audio output	Loudspeaker power output 15 W*2
Touch screen material	Tempered glass
Sensing method	Infrared
Technical feature	HID drive-free
Touch point	Multi-touch
Writing method	Finger or pen
Resolution of touch screen	32767x32767
Communication interface	USB
Storage temperature/humidity	-20°C~60°C, 10%~90%
Working temperature/humidity	5°C ~50°C, 10%~90%
Installation method	Wall-mounted or moveable

* Hitevision Interactive may modify the user manual without prior notice.

* If you discover any unclear presentation, mistake or omission in this manual, please contact us immediately. Hitevision Interactive is not liable for any loss or damage if you fail to contact us.