



Shenzhen Certification Technology Service Co., Ltd
2F, Building B, East Area of Nanchang Second Industrial Zone,
Gushu 2nd Road, Bao'an District, Shenzhen 518126, P.R. China.

TEST REPORT

FCC ID: 2ACYPMC-36R

Applicant : SHENZHEN YONGNUO PHOTOGRAPHIC EQUIPMENT CO., LTD
Address : B509 5/F, BUILDING 2, SAIGE SCIENCE AND TECHNOLOGY PARK, NORTH OF HUAQIANG ROAD, FUTIAN, SHENZHEN, CHINA .

Equipment under Test (EUT):

Name : Wireless Timer Remote Controller
Model : MC-36R

Standards : FCC PART 15, SUBPART C : 2013 (Section 15.249)

Report No. : CST-TCB140624029

Date of Test : August 02 - 08, 2014

Date of Issue : August 09, 2014

| | |
|----------------------|---------------|
| Test Result : | PASS * |
|----------------------|---------------|

* In the configuration tested, the EUT complied with the standards specified above

Authorized Signature

(Mark Zhu)
General Manager

The manufacture should ensure that all the products in series production are in conformity with the product sample detailed in this report.

If the product in this report is used in any configuration other than that detailed in the report, the manufacturer must ensure the new system complies with all relevant standards. Any mention of Shenzhen Certification Technology Service Co., Ltd. Or test done by Shenzhen Certification Technology Service Co., Ltd. Approvals in connection with, distribution or use of the product described in this report must be approved by Shenzhen Certification Technology Service Co., Ltd. Approvals in writing.

TABLE OF CONTENT

| Description | Page |
|---|-----------|
| 1 General Information----- | 3 |
| 1.1 Description of Device (EUT)----- | 3 |
| 1.2 Description of Test Facility----- | 3 |
| 2 EMC Equipment List----- | 4 |
| 3 Test Procedure----- | 5 |
| 4 Summary of Measurement ----- | 6 |
| 4.1 Summary of test result ----- | 6 |
| 4.2 Test mode ----- | 6 |
| 5 POWER LINE CONDUCTED EMISSION ----- | 8 |
| 5.1 Conducted Emission Limits(15.209&249) ----- | 8 |
| 5.2 Test Setup----- | 8 |
| 5.3 Test Procedure----- | 9 |
| 5.4 Test Results----- | 9 |
| 6 Radiation Emission ----- | 10 |
| 6.1 Radiation Emission Limits(15.209&249 (a)) ----- | 10 |
| 6.2 Test Setup----- | 11 |
| 6.3 Test Procedure----- | 12 |
| 6.4 Test Equipment Setting For emission test. ----- | 13 |
| 6.5 Test Condition----- | 13 |
| 6.6 Test Result ----- | 13 |
| 7 Occupied bandwidth----- | 17 |
| 7.1 Test limit ----- | 17 |
| 7.2 Method of measurement ----- | 17 |
| 7.3 Test Setup----- | 17 |
| 7.4 Test Results----- | 17 |
| 8 Band Edge Check ----- | 19 |
| 8.1 Test limit ----- | 19 |
| 8.2 Test Procedure----- | 19 |
| 8.3 Test Setup----- | 19 |
| 8.4 Test Result ----- | 19 |
| 9 Antenna Requirement ----- | 24 |
| 9.1 Standard Requirement----- | 24 |
| 9.2 Antenna Connected Construction----- | 24 |
| 9.3 Result----- | 24 |
| 10 Photographs of Test Setup----- | 25 |
| 11 Photographs of EUT ----- | 27 |

1 General Information

1.1 Description of Device (EUT)

Trade Name : **YONGNUO**

EUT : Wireless Timer Remote Controller

Model No. : MC-36R

DIFF. : N/A

Type of Antenna : PCB Antenna, Max. Gain: 1.5dBi

Operation Frequency : 2410MHz

Channel number : 1

Modulation type : FSK

Power Supply : DC 3V Supply by battery

Applicant : SHENZHEN YONGNUO PHOTOGRAPHIC EQUIPMENT
CO., LTD

Address : B509 5/F, BUILDING 2, SAIGE SCIENCE AND
TECHNOLOGY PARK, NORTH OF HUAQIANG ROAD,
FUTIAN, SHENZHEN, CHINA .

Manufacturer : SHENZHEN YONGNUO PHOTOGRAPHIC EQUIPMENT
CO., LTD

Address : B509 5/F, BUILDING 2, SAIGE SCIENCE AND
TECHNOLOGY PARK, NORTH OF HUAQIANG ROAD,
FUTIAN, SHENZHEN, CHINA .

1.2 Description of Test Facility

Shenzhen Certification Technology Service Co., Ltd.
2F, Building B, East Area of Nanchang Second Industrial Zone,
Gushu 2nd Road, Bao'an District, Shenzhen 518126, P.R. China
FCC Registered No.:197647

2 EMC Equipment List

| Equipment | Manufacture | Model No. | Serial No. | Last cal. | Cal Interval |
|------------------------|--------------|-----------------|----------------------|-------------|--------------|
| 3m Semi-Anechoic | ETS-LINDGREN | N/A | SEL0017 | Nov. 16, 13 | 1 Year |
| Spectrum analyzer | Agilent | E4407B | MY49510055 | Oct. 30, 13 | 1 Year |
| Receiver | R&S | ESCI | 101165 | Oct. 30, 13 | 1 Year |
| Receiver | R&S | ESCI | 101202 | Oct. 30, 13 | 1 Year |
| Bilog Antenna | SCHWARZBECK | VULB 9168 | 9168-438 | Mar.11, 14 | 1 Year |
| Horn Antenna | SCHWARZBECK | BBHA 9120 D | BBHA 9120 D(1201) | Mar.11, 14 | 1 Year |
| Horn Antenna | SCHWARZBECK | BBHA 9170 | BBHA 9170 D(1432) | Mar.11, 14 | 1 Year |
| Active Loop Antenna | Beijing Daze | ZN30900A | SEL0097 | Mar.12, 14 | 1 Year |
| Cable | Resenberger | SUCOFLEX 104 | MY6562/4 | Oct. 30, 13 | 1 Year |
| Cable | Resenberger | SUCOFLEX 104 | 309972/4 | Oct. 30, 13 | 1 Year |
| Cable | Resenberger | SUCOFLEX 104 | 329112/4 | Oct. 30, 13 | 1 Year |
| Pre-amplifier | SCHWARZBECK | BBV9743 | 9743-019 | Oct. 30, 13 | 1 Year |
| Pre-amplifier | Quietek | AP-180C | CHM-0602012 | Oct. 30, 13 | 1 Year |

3 Test Procedure

POWER LINE CONDUCTED INTERFERENCE: The test procedure used was ANSI Standard C63.4-2003 using a 50 u H LISN. Both Lines were observed. The bandwidth of the receiver was 10kHz with an appropriate sweep speed. The ambient temperature of the EUT was 25°C with a humidity of 58%.

RADIATION INTERFERENCE: The test procedure used was ANSI Standard C63.4-2003 using a ANRITSU spectrum analyzer with a pre-selector. The analyzer was calibrated in dB above a micro volt at the output of the antenna. The resolution bandwidth was 100kHz and the video bandwidth was 300 kHz up to 1 GHz and 1 MHz with a video BW of 3MHz above 1 GHz. The ambient temperature of the EUT was 25°C with a humidity of 58%.

FORMULA OF CONVERSION FACTORS: The Field Strength at 3m was established by adding the meter reading of the spectrum analyzer (which is set to read in units of dBuV) to the antenna correction factor supplied by the antenna manufacturer and cable loss. The antenna correction factors and cable loss are stated in terms of dB. The gain of the Pre-selector was accounted for in the Spectrum Analyzer Meter Reading.

Example:

Freq (MHz) METER READING + ACF + CABLE = FS

33.20 dBuV + 10.36 dB + 0.9 dB= 44.46 dBuV/m @ 3m

ANSI STANDARD C63.4-2003 10.1.7 MEASUREMENT PROCEDURES: The EUT was placed on a table 80 cm high and with dimensions of 1m by 1.5m. The EUT was placed in the center of the table (1.5m side). The table used for radiated measurements is capable of continuous rotation. When an emission was found, the table was rotated to produce the maximum signal strength. At this point, the antenna was raised and lowered from 1m to 4m. The antenna was placed in both the horizontal and vertical planes. The situation was similar for the conducted measurement except that the table did not rotate. The EUT was setup as described in ANSI Standard C63.4-2003 10.1.7 with the EUT 40 cm from the vertical ground wall.

4 Summary of Measurement

4.1 Summary of test result

| Test Item | Test Requirement | Standard Paragraph | Result |
|-----------------------|-------------------|-----------------------|----------------|
| Spurious Emission | FCC PART 15: 2013 | Section 15.249&15.209 | Compliance |
| Conduction Emission | FCC PART 15: 2013 | Section 15.207 | Not applicable |
| Occupied bandwidth | FCC PART 15: 2013 | Section 15.249 | Compliance |
| Band edge Requirement | FCC PART 15: 2013 | Section 15.249 | Compliance |
| Antenna Requirement | FCC PART 15: 2013 | Section 15.203 | Compliance |

Note: EUT can be powered with inside battery, according to exploratory test, when powered by battery have worse emissions, and also can make sure EUT have enough power for wireless work, so all the final test were performed with new battery.

4.2 Test mode

| Tested mode, channel information | | |
|----------------------------------|---------|-----------------|
| Mode | Channel | Frequency (MHz) |
| FSK | CH1 | 2410 |

| Channel list | | | |
|--------------|---------|---|---|
| CH1 | 2410MHz | / | / |

4.3 Block Diagram



4.4 Assistant equipment used for test

Description : N/A
 Manufacturer : N/A
 Model No. : N/A

4.5 Test Conditions

| | |
|-------------------|-----------|
| Temperature range | 21-25°C |
| Humidity range | 40-75% |
| Pressure range | 86-106kPa |

4.6 Measurement Uncertainty (95% confidence levels, k=2)

| Item | MU | Remark |
|---|--------------------|-------------|
| Uncertainty for Power point Conducted Emissions Test | 2.50dB | |
| Uncertainty for Radiation Emission test in 3m chamber (below 30MHz) | 2.13 dB | Polarize: V |
| | 2.57dB | Polarize: H |
| Uncertainty for Radiation Emission test in 3m chamber (30MHz to 1GHz) | 3.04dB | Polarize: V |
| | 3.02dB | Polarize: H |
| Uncertainty for Radiation Emission test in 3m chamber (1GHz to 25GHz) | 3.84dB | Polarize: H |
| | 3.56dB | Polarize: V |
| Uncertainty for radio frequency | 1×10^{-9} | |
| Uncertainty for temperature | 0.2°C | |
| Uncertainty for humidity | 3% | |
| Uncertainty for DC and low frequency voltages | 0.06% | |

5 POWER LINE CONDUCTED EMISSION

5.1 Conducted Emission Limits(15.209&249)

| Frequency MHz | Limits dB(μ V) | |
|------------------|---------------------|---------------|
| | Quasi-peak Level | Average Level |
| 0.15 -0.50 | 66 -56* | 56 - 46* |
| 0.50 -5.00 | 56 | 46 |
| 5.00 -30.00 | 60 | 50 |

Notes: 1. *Decreasing linearly with logarithm of frequency.

2. The lower limit shall apply at the transition frequencies.

3.The limit decreases in line with the logarithm of the frequency in the rang of 0.15 to 0.50 MHz.

5.2 Test Setup

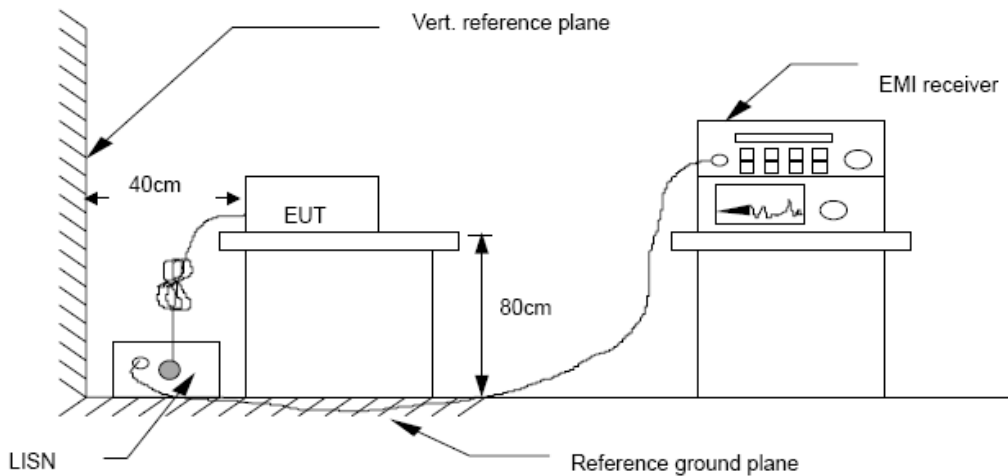

5.3 Test Procedure

The EUT is put on the plane 0.8m high above the ground by insulating support and is connected to the power mains through a line impedance stabilization network (L.I.S.N.). This provides a 50ohm coupling impedance for the EUT system. Please refer the block diagram of the test setup and photographs. Both sides of AC lines are checked to find out the maximum conducted emission. In order to find the maximum emission levels, the relative positions of equipment and all of the interface cables shall be changed according to ANSI C63.4-2003 on Conducted Emission Measurement. The bandwidth of test receiver (R & S ESCS30) is set at 9 kHz.

5.4 Test Results

EUT Supply by DC battery, so the test is not applicable.

.

6 Radiation Emission

6.1 Radiation Emission Limits(15.209&249 (a))

| Frequency (MHz) | Field Strength Limits at 3 metres (watts,e.i.r.p.) | | |
|----------------------|---|------------|----------------------------|
| | uV/m | dB uV/m | Measurement distance(m) |
| 0.009-0.490 | 2400/F(kHz) | XX | 300 |
| 0.490-1.705 | 24000/F(kHz) | XX | 30 |
| 1.705-30 | 30 | 29.5 | 30 |
| 30~88 | 100(3nW) | 40 | 3 |
| 88~216 | 150(6.8nW) | 43.5 | 3 |
| 216~960 | 200(12nW) | 46 | 3 |
| Above960 | 500(75nW) | 54 | 3 |
| Carrier frequency | | 93.97(AV) | 3 |
| Carrier frequency | | 113.97(PK) | 3 |

NOTE:

- a) The tighter limit applies at the band edges.
- b) Emission Level(dB uV/m)=20log Emission Level(Uv/m)

6.2 Test Setup

See the next page

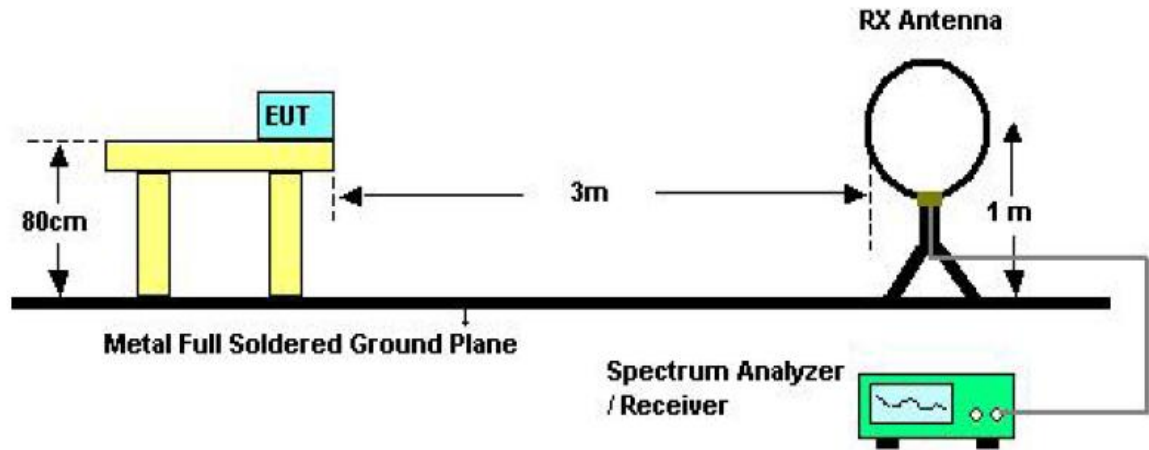

Below 30MHz Test Setup

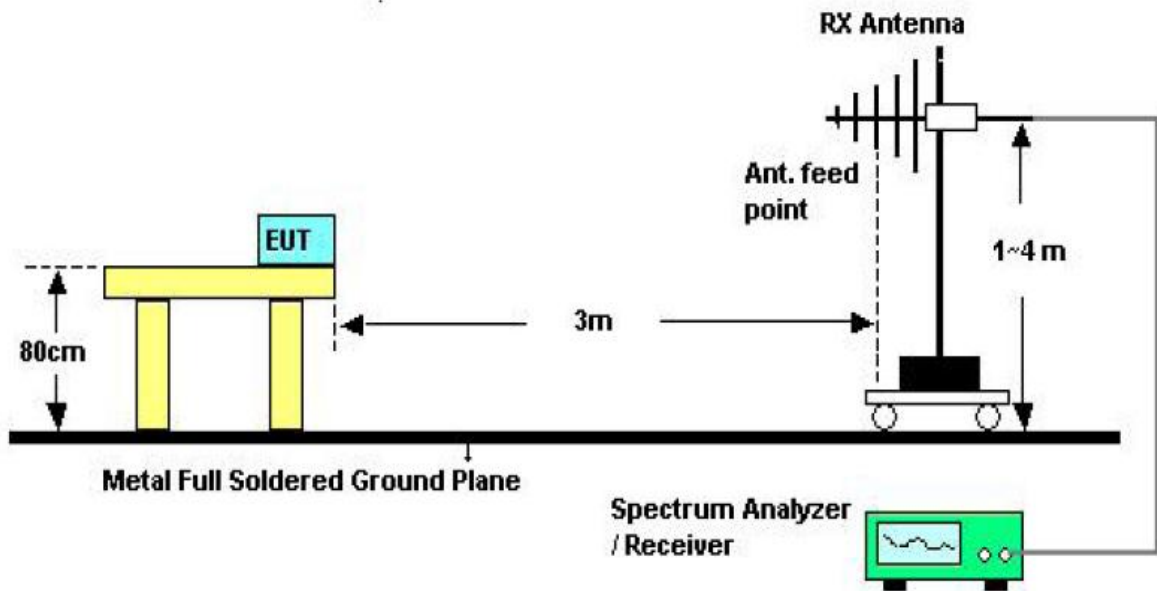

Above 30MHz Test Setup

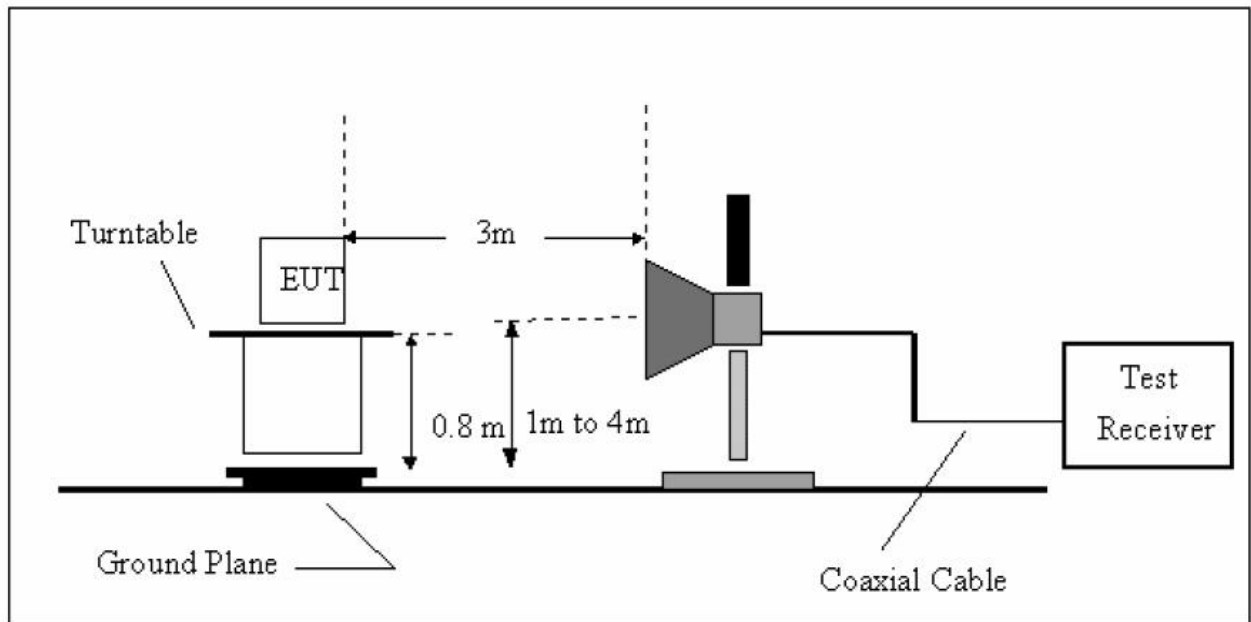

Above 1GHz Test Setup

6.3 Test Procedure

- a) The measuring distance of 3m shall be used for measurements at frequency up to 1GHz and above 1GHz, The EUT was placed on a rotating 0.8 m high above ground, The table was rotated 360 degrees to determine the position of the highest radiation
- b) The Test antenna shall vary between 1m and 4m,Both Horizontal and Vertical antenna are set ot make measurement.
- c) The initial step in collecting conducted emission data is a spectrum analyzer Peak detector mode pre-scanning the measurement frequency range. Significant Peaks are then marked. and then Qusia Peak Detector mode remeasured
- d) If Peak value comply with QP limit Below 1GHz.The EUT deemed to comply with QP limit. But the Peak value and average value both need to comply with applicable limit above 1GHz.
- e) Rotated EUT though three orthogonal axes to determine the attitude of EUT arrangement produces highest emissions.
- f) For the actual test configuration, please see the test setup photo.

6.4 Test Equipment Setting For emission test.

| | | |
|--------------|------------|------------|
| 9KHz~150KHz | RBW 200Hz | VBW1KHz |
| 150KHz~30MHz | RBW 9KHz | VBW 30KHz |
| 30MHz~1GHz | RBW 120KHz | VBW 300KHz |
| Above 1GHz | RBW 1MHz | VBW 3MHz |

6.5 Test Condition

Continual Transmitting in maximum power.

6.6 Test Result

PASS.

We have scanned the 10th harmonic from 9KHz to the EUT.

Note: The Radiated emissions is showed the maximum power data of TX test mode and showed worst orthogonal axes with Y orthogonal axes.

Detailed information please see the following page.

From 9KHz to 30MHz: Conclusion: **PASS**

Note: The amplitude of spurious emissions which are attenuated by more than 20dB below the permissible value hasno need to be reported.

Below 1GHz test data:



Shenzhen Certification Technology Service Co., Ltd
 2F, Building B, East Area of Nanchang Second Industrial Zone,
 Gushu 2nd Road, Bao'an District, Shenzhen 518126, P.R. China
 Tel: 4006786199 FAX: +86-755-26736857
 Website: <http://www.cessz.com> Email: Service@cessz.com

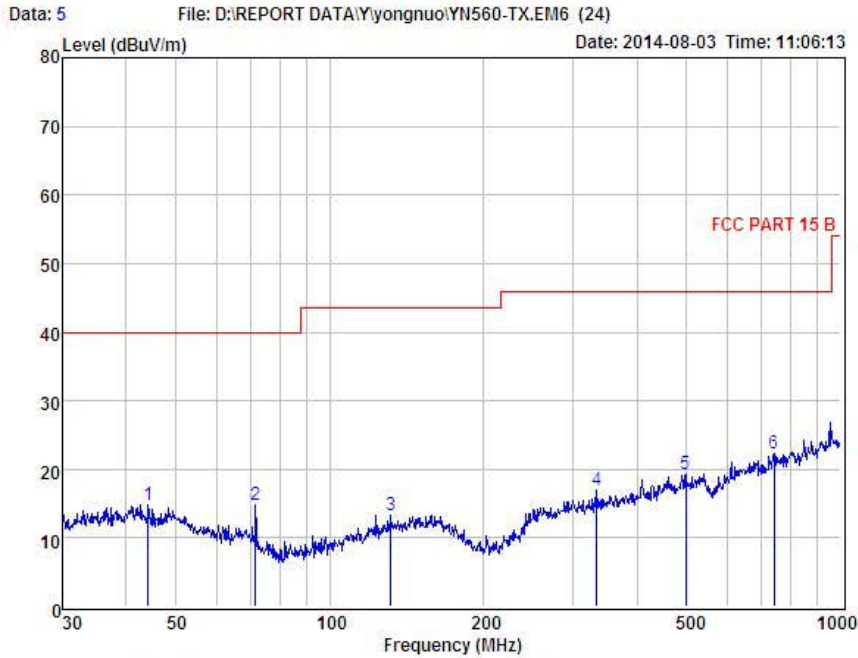

Condition : FCC PART 15 B 3m POL: VERTICAL
 EUT : Wireless Timer Remote Controller
 Model No : MC-36R
 Test Mode : TX 2410MHz
 Power : DC 3V from battery
 Test Engineer : Store
 Remark :
 Temp : 24.2°C
 Hum : 54%

| Item | Freq MHz | Read Level dBuV | Antenna Factor dB | Preamp Factor dB | Cable Loss dB | Level dBuV | Limit dBuV | Margin dBuV | Remark |
|------|-------------|-----------------------|-------------------------|------------------------|---------------------|---------------|---------------|----------------|--------|
| 1 | 44.12 | 26.81 | 13.79 | 25.82 | 0.03 | 14.81 | 40.00 | -25.19 | QP |
| 2 | 71.58 | 30.88 | 10.51 | 26.77 | 0.19 | 14.81 | 40.00 | -25.19 | QP |
| 3 | 131.76 | 26.92 | 12.79 | 26.89 | 0.57 | 13.39 | 43.50 | -30.11 | QP |
| 4 | 333.69 | 26.83 | 13.55 | 24.24 | 0.81 | 16.95 | 46.00 | -29.05 | QP |
| 5 | 497.68 | 26.39 | 16.48 | 24.61 | 1.05 | 19.31 | 46.00 | -26.69 | QP |
| 6 | 739.66 | 26.81 | 20.13 | 25.70 | 1.00 | 22.24 | 46.00 | -23.76 | QP |

Remark: Level = Read Level + Antenna Factor - Preamp Factor + Cable Loss



Shenzhen Certification Technology Service Co., Ltd
 2F, Building B, East Area of Nanchang Second Industrial Zone,
 Gushu 2nd Road, Bao'an District, Shenzhen 518126, P.R. China
 Tel: 4006786199 FAX: +86-755-26736857
 Website: <http://www.cessz.com> Email: Service@cessz.com

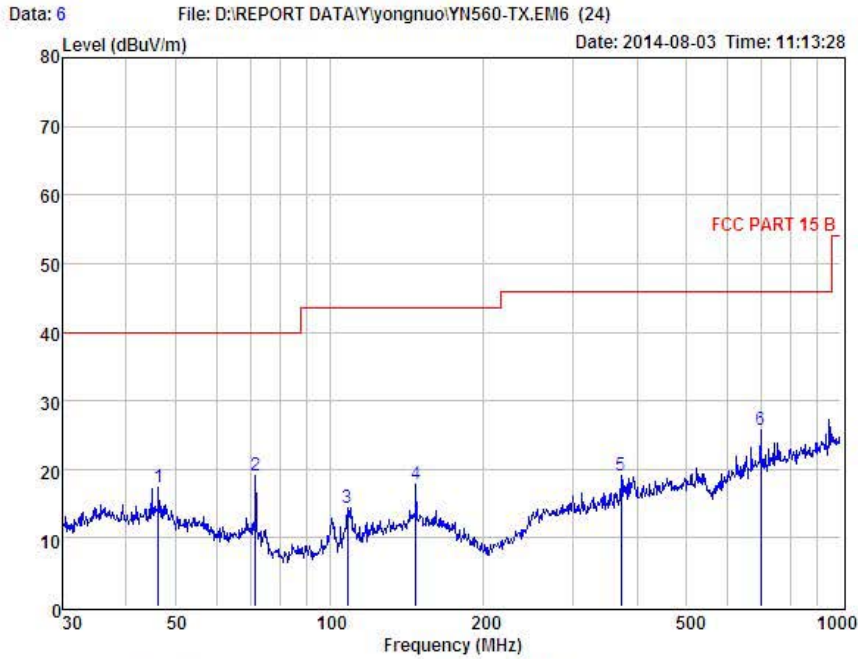

Condition : FCC PART 15 B 3m POL: HORIZONTAL
 EUT : Wireless Timer Remote Controller
 Model No : MC-36R
 Test Mode : TX 2410MHz
 Power : DC 3V from battery
 Test Engineer : Store
 Remark :
 Temp : 24.2°C
 Hum : 54%

| Item | Freq MHz | Read Level dBuV | Antenna Factor dB | Preamp Factor dB | Cable Loss dB | Level dBuV | Limit dBuV | Margin dBuV | Remark |
|------|-------------|-----------------------|-------------------------|------------------------|---------------------|---------------|---------------|----------------|--------|
| 1 | 46.18 | 29.48 | 13.65 | 25.82 | 0.06 | 17.37 | 40.00 | -22.63 | QP |
| 2 | 71.58 | 35.13 | 10.51 | 26.77 | 0.19 | 19.06 | 40.00 | -20.94 | QP |
| 3 | 108.27 | 29.75 | 11.13 | 26.86 | 0.41 | 14.43 | 43.50 | -29.07 | QP |
| 4 | 147.40 | 30.48 | 13.90 | 26.90 | 0.37 | 17.85 | 43.50 | -25.65 | QP |
| 5 | 372.00 | 27.99 | 14.28 | 24.34 | 1.11 | 19.04 | 46.00 | -26.96 | QP |
| 6 | 696.86 | 30.69 | 19.62 | 25.75 | 1.19 | 25.75 | 46.00 | -20.25 | QP |

Remark: Level = Read Level + Antenna Factor - Preamp Factor + Cable Loss

Notes: --Means other frequency and mode comply with standard requirements and at least have 20dB margin.

Radiated Emissions Result of Inside band (2410MHz)

| | | | |
|--------------------|----------------------------------|-----------------------------|-------------------------|
| EUT | Wireless Timer Remote Controller | Model Name | MC-36R |
| Temperature | 25°C | Relative Humidity | 56% |
| Pressure | 960hPa | Test voltage | DC 3V supply by battery |
| Test Mode | TX | Antenna polarization | Horizontal/Vertical |

| Channel (2410MHz) | | | | | | | | | |
|-------------------|-------------|--------------|-------------------|---------------|-------------------|-------------------|-----------------------|--------------|-----------|
| Fre. MHz | Plority H/V | Reading dBuV | Antenna Factor dB | Cable Loss dB | Amplifier Gain dB | Correct Factor dB | Measure Result dBuV/m | Limit dBuV/m | Margin dB |
| 2410 | H | 82.67 (PK) | 27.62 | 3.92 | 34.97 | -3.43 | 79.24 | 113.97 | -34.73 |
| 2410 | H | 73.56 (AV) | 27.62 | 3.92 | 34.97 | -3.43 | 70.13 | 93.97 | -23.84 |
| -- | H | -- | -- | -- | -- | -- | -- | -- | -- |
| 2410 | V | 84.23 (PK) | 27.62 | 3.92 | 34.97 | -3.43 | 80.80 | 113.97 | -33.17 |
| 2410 | V | 76.85(AV) | 27.62 | 3.92 | 34.97 | -3.43 | 73.42 | 93.97 | -20.55 |
| -- | V | -- | -- | -- | -- | -- | -- | -- | -- |

| Freq. (MHz) | Ant. Pol H/V | Peak Reading (dBuV) | AV Reading (dBuV) | Ant. / CL CF (dB) | Actual Fs | | Peak Limit (dBuV/m) | AV Limit (dBuV/m) | Margin (dB) | Remark |
|-------------|--------------|---------------------|-------------------|-------------------|---------------|-------------|---------------------|-------------------|-------------|--------|
| | | | | | Peak (dBuV/m) | AV (dBuV/m) | | | | |
| 1489.53 | H | 46.81 | --- | -10.27 | 36.54 | --- | 74.00 | 54.00 | -17.46 | Peak |
| 1942.13 | H | 46.94 | --- | -8.86 | 38.08 | --- | 74.00 | 54.00 | -15.92 | Peak |
| 2654.72 | H | 46.73 | --- | -6.94 | 39.79 | --- | 74.00 | 54.00 | -14.21 | Peak |
| 4820.00 | H | 40.92 | --- | 0.64 | 41.56 | --- | 74.00 | 54.00 | -12.44 | Peak |
| N/A | | | | | | | | | | |
| 1218.43 | V | 49.88 | --- | -11.52 | 38.36 | --- | 74.00 | 54.00 | -15.64 | Peak |
| 1821.56 | V | 46.81 | --- | -9.16 | 37.65 | --- | 74.00 | 54.00 | -16.35 | Peak |
| 2794.23 | V | 45.29 | --- | -6.38 | 38.91 | --- | 74.00 | 54.00 | -15.09 | Peak |
| 4820.00 | V | 41.88 | | 0.64 | 42.52 | --- | 74.00 | 54.00 | -11.48 | Peak |
| N/A | | | | | | | | | | |

Notes: 1 --Means other frequency and mode comply with standard requirements and at least have 20dB margin. Correct Factor=Cable Loss+ Antenna Factor-Amplifier Gain
 Measurement Result=Reading + Correct Factor
 Margin=Measurement Result-Limit

2 -Spectrum setting:

a. Peak setting 30MHz-1GHz, RBW=120KHz, VBW=300KHz.

Above 1G: RBW=1MHz, VBW=3MHz

b. AV setting 30MHz-1GHz, RBW=1MHz, VBW=10Hz.

Above 1G: RBW=1MHz, VBW=10Hz

7 Occupied bandwidth

7.1 Test limit

Please refer section 15.249

7.2 Method of measurement

- a) The bandwidth is measured at an amplitude level reduced 20dB from the reference level. The reference level is the level of the highest amplitude signal observed from the transmitter at the fundamental frequency. Once the reference level is established, the equipment is conditioned with typical modulating signal to produce the worst-case (i.e. the widest) bandwidth.
- b) The test receiver RBW set 30KHz, VBW set 30KHz, Sweep time set auto.

7.3 Test Setup

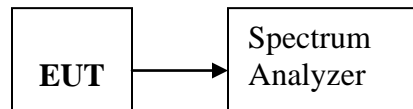

7.4 Test Results

| Mode | Freq (MHz) | 20dB Bandwidth (MHz) | 99% Bandwidth (MHz) | Limit (kHz) | Conclusion |
|------|------------|----------------------|---------------------|-------------|------------|
| FSK | 2410 | 0.524 | 0.561 | / | PASS |

Note: Detailed information please see the following page.

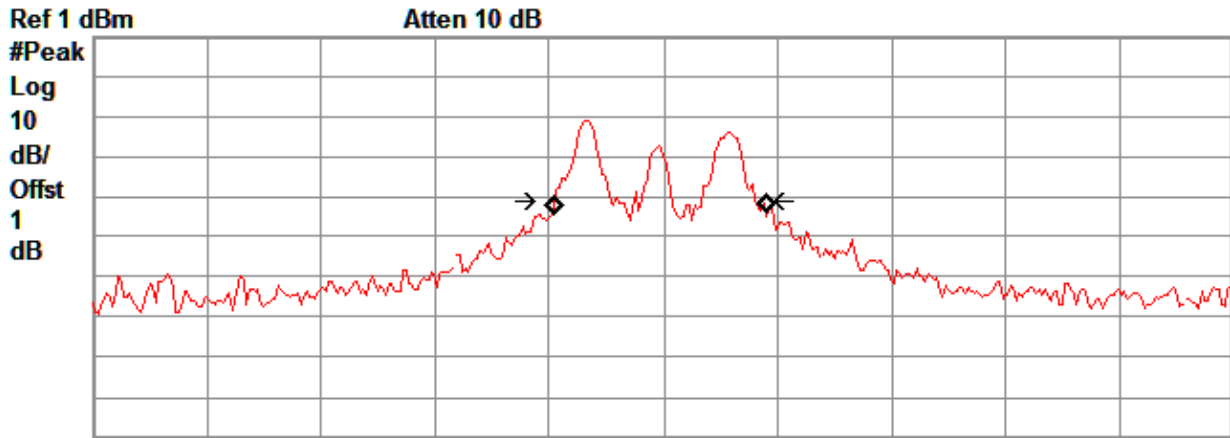

Center 2.41 GHz Span 3 MHz
#Res BW 30 kHz #VBW 30 kHz Sweep 5 ms (401 pts)

Occupied Bandwidth
561.2568 kHz

Occ BW % Pwr 99.00 %
x dB -20.00 dB

Transmit Freq Error -7.917 kHz
x dB Bandwidth 524.144 kHz

8 Band Edge Check

8.1 Test limit

Please refer section 15.249 and section 15.205.

249(d) Emissions radiated outside of the specified frequency bands, except for harmonics, shall be attenuated by at least 50 dB below the level of the fundamental or to the general radiated emission limits in section 15.209, whichever is the lesser attenuation.

249(e) As show in section 15.35(b), for frequencies above 1000MHz, the above field strength limits in paragraphs (a) and (b) of this section are based on average limits. However, the peak field strength of any emission shall not exceed the maximum permitted average limits specified above by more than 20 dB under any condition of modulation. For point-to-point operation under paragraph (b) of this section, the peak field strength shall not exceed 2500 millivolts/meter at 3 meters along the antenna azimuth.

8.2 Test Procedure

8.2.1. Remove the antenna from the EUT and then connect a low loss RF cable from the antenna port to the spectrum analyzer.

8.2.2. Set spectrum analyzer please see the following test plot.

8.2.3. Set the spectrum analyzer as RBW, VBW=1000 KHz,

8.2.4. Max hold, view and count how many channel in the band.

8.3 Test Setup

Please see the section 6.2, above 1GHz Test Setup.

8.4 Test Result

Pass.

Detailed information please see the following page.



Shenzhen Certification Technology Service Co., Ltd.
 2F, Building B, East Area of Nanchang Second Industrial Zone,
 Gushu 2nd Road, Bao'an District, Shenzhen 518126, P.R. China
 Tel: 4006786199 FAX: +86-755-26736857
 Website: <http://www.cessz.com> Email: Service@cessz.com

Data: 11 File: D:\Wireless test\2.4G\yongnuo\Biandai.EM6 (36)

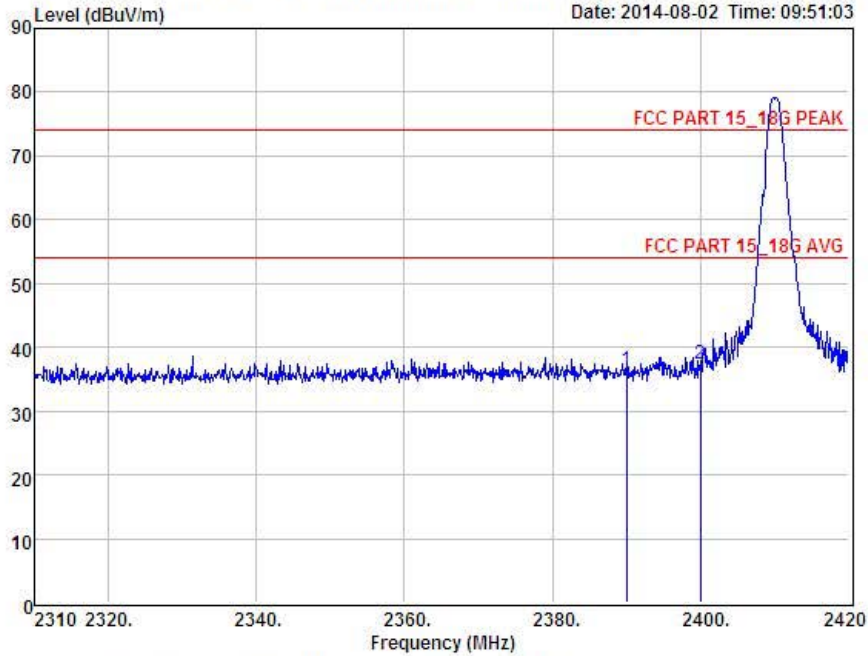

Condition : FCC PART 15_18G PEAK 3m POL: HORIZONTAL
 EUT : Wireless Timer Remote Controller
 Model No : MC-36R
 Test Mode : TX 2410MHz
 Power : DC 3V from battery
 Test Engineer : Simple
 Remark :
 Temp :
 Hum :

| Item | Freq MHz | Read Level dBuV | Antenna Factor dB | Preamp Factor dB | Cable Loss dB | Level dBuV | Limit dBuV | Margin dBuV | Remark |
|------|-------------|-----------------------|-------------------------|------------------------|---------------------|---------------|---------------|----------------|--------|
| 1 | 2390.00 | 39.83 | 27.62 | 34.97 | 3.92 | 36.40 | 74.00 | -37.60 | Peak |
| 2 | 2400.00 | 40.72 | 27.62 | 34.97 | 3.94 | 37.31 | 74.00 | -36.69 | Peak |

Remark: Level = Read Level + Antenna Factor - Preamp Factor + Cable Loss



Shenzhen Certification Technology Service Co., Ltd.
 2F, Building B, East Area of Nanchang Second Industrial Zone,
 Gushu 2nd Road, Bao'an District, Shenzhen 518126, P.R. China
 Tel: 4006786199 FAX: +86-755-26736857
 Website: <http://www.cessz.com> Email: Service@cessz.com

Data: 29 File: D:\Wireless test\2.4G\yongnuo\Biandai.EM6 (36)

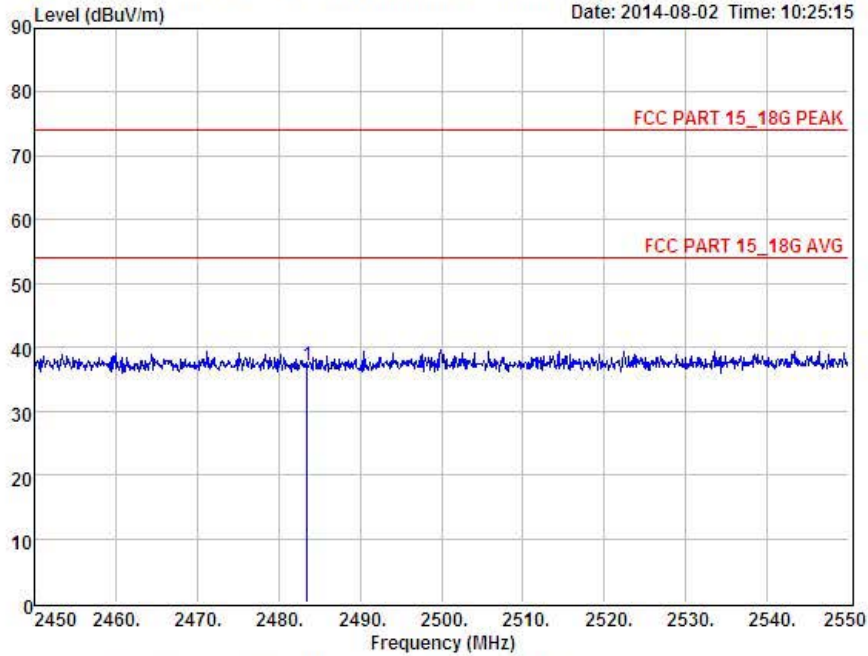

Condition : FCC PART 15_18G PEAK 3m POL: HORIZONTAL
 EUT : Wireless Timer Remote Controller
 Model No : MC-36R
 Test Mode : TX 2410MHz
 Power : DC 3V from battery
 Test Engineer : Simple
 Remark :
 Temp :
 Hum :

| Item | Freq MHz | Read Level dBuV | Antenna Factor dB | Preamp Factor dB | Cable Loss dB | Level dBuV | Limit dBuV | Margin dBuV | Remark |
|------|-------------|-----------------------|-------------------------|------------------------|---------------------|---------------|---------------|----------------|--------|
| 1 | 2483.50 | 40.58 | 27.59 | 34.97 | 4.00 | 37.20 | 74.00 | -36.80 | Peak |

Remark: Level = Read Level + Antenna Factor - Preamp Factor + Cable Loss



Shenzhen Certification Technology Service Co., Ltd.
 2F, Building B, East Area of Nanchang Second Industrial Zone,
 Gushu 2nd Road, Bao'an District, Shenzhen 518126, P.R. China
 Tel: 4006786199 FAX: +86-755-26736857
 Website: <http://www.cessz.com> Email: Service@cessz.com

Data: 12 File: D:\Wireless test\2.4G\yongnuo\Biandai.EM6 (36)

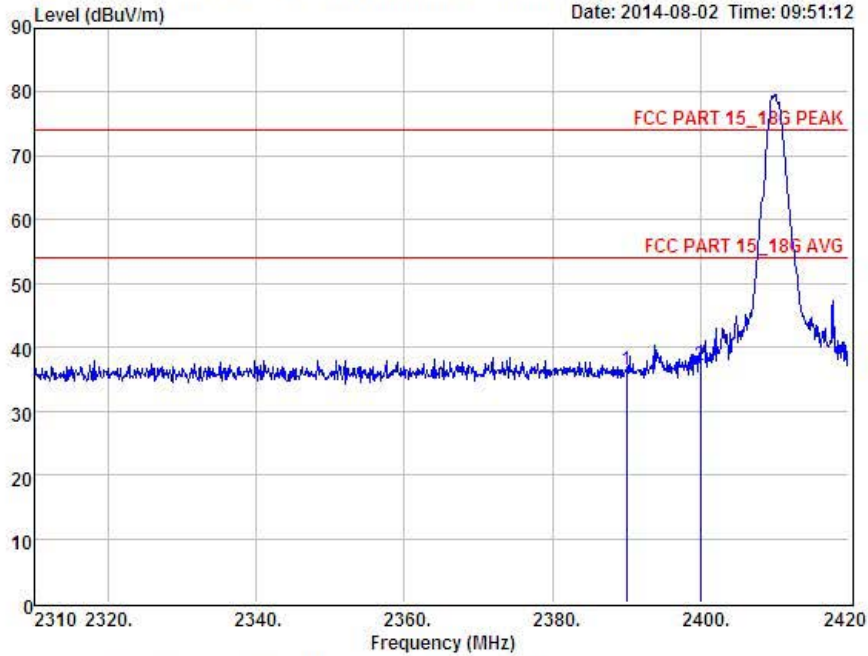

Condition : FCC PART 15_18G PEAK 3m POL: VERTICAL
 EUI : Wireless Timer Remote Controller
 Model No : MC-36R
 Test Mode : TX 2410MHz
 Power : DC 3V from battery
 Test Engineer : Simple
 Remark :
 Temp :
 Hum :

| Item | Freq MHz | Read Level dBuV | Antenna Factor dB | Preamp Factor dB | Cable Loss dB | Level dBuV | Limit dBuV | Margin dBuV | Remark |
|------|-------------|-----------------------|-------------------------|------------------------|---------------------|---------------|---------------|----------------|--------|
| 1 | 2390.00 | 39.91 | 27.62 | 34.97 | 3.92 | 36.48 | 74.00 | -37.52 | Peak |
| 2 | 2400.00 | 40.64 | 27.62 | 34.97 | 3.94 | 37.23 | 74.00 | -36.77 | Peak |

Remark: Level = Read Level + Antenna Factor - Preamp Factor + Cable Loss



Shenzhen Certification Technology Service Co., Ltd.
 2F, Building B, East Area of Nanchang Second Industrial Zone,
 Gushu 2nd Road, Bao'an District, Shenzhen 518126, P.R. China
 Tel: 4006786199 FAX: +86-755-26736857
 Website: <http://www.cessz.com> Email: Service@cessz.com

Data: 30 File: D:\Wireless test\2.4G\yongnuo\Biandai.EM6 (36)

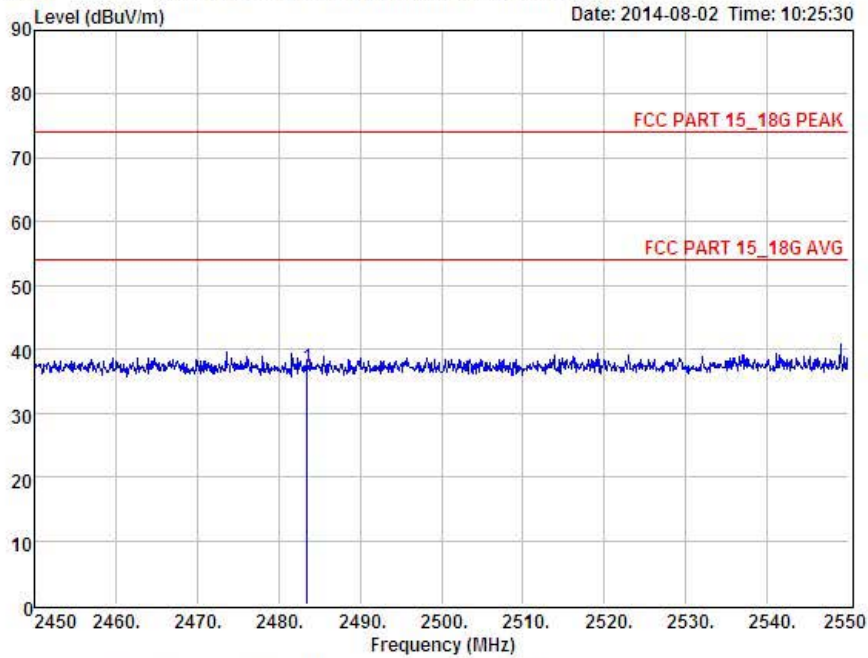

Condition : FCC PART 15_18G PEAK 3m POL: VERTICAL
 EUT : Wireless Timer Remote Controller
 Model No : MC-36R
 Test Mode : TX 2410MHz
 Power : DC 3V from battery
 Test Engineer : Simple
 Remark :
 Temp :
 Hum :

| Item | Freq MHz | Read Level dBuV | Antenna Factor dB | Preamp Factor dB | Cable Loss dB | Level dBuV | Limit dBuV | Margin dBuV | Remark |
|------|-------------|-----------------------|-------------------------|------------------------|---------------------|---------------|---------------|----------------|--------|
| 1 | 2483.50 | 40.64 | 27.59 | 34.97 | 4.00 | 37.26 | 74.00 | -36.74 | Peak |

Remark: Level = Read Level + Antenna Factor - Preamp Factor + Cable Loss

9 Antenna Requirement

9.1 Standard Requirement

An intentional radiator shall be designed to ensure that no antenna other than that furnished by the responsible party shall be used with the device. The use of a permanently attached antenna or of an antenna that uses a unique coupling to the intentional radiator shall be considered sufficient to comply with the provisions of this Section. The manufacturer may design the unit so that a broken antenna can be replaced by the user, but the use of a standard antenna jack or electrical connector is prohibited.

9.2 Antenna Connected Construction

The directional gains of antenna used for transmitting is 1.5dBi, and the antenna is PCB Antenna . Please see EUT photo for details.

9.3 Result

The EUT antenna is PCB Antenna. It complies with the standard requirement.

10 Photographs of Test Setup

Photographs-Radiated Emission Test Setup in Chamber

Below 1G

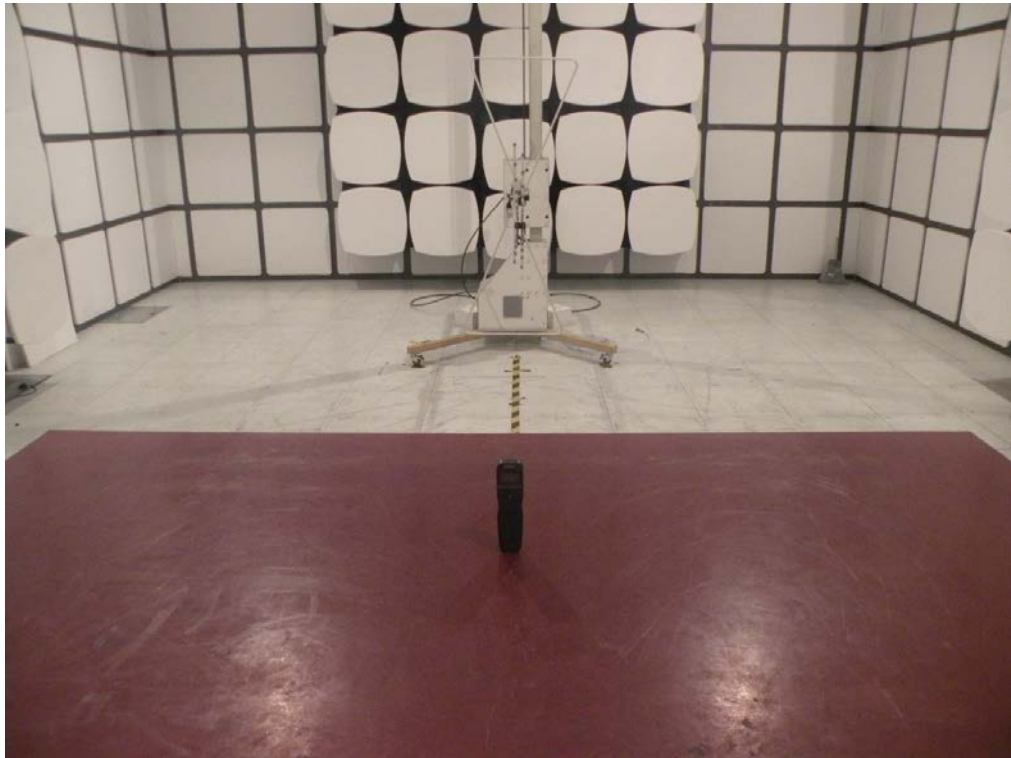

Above 1G

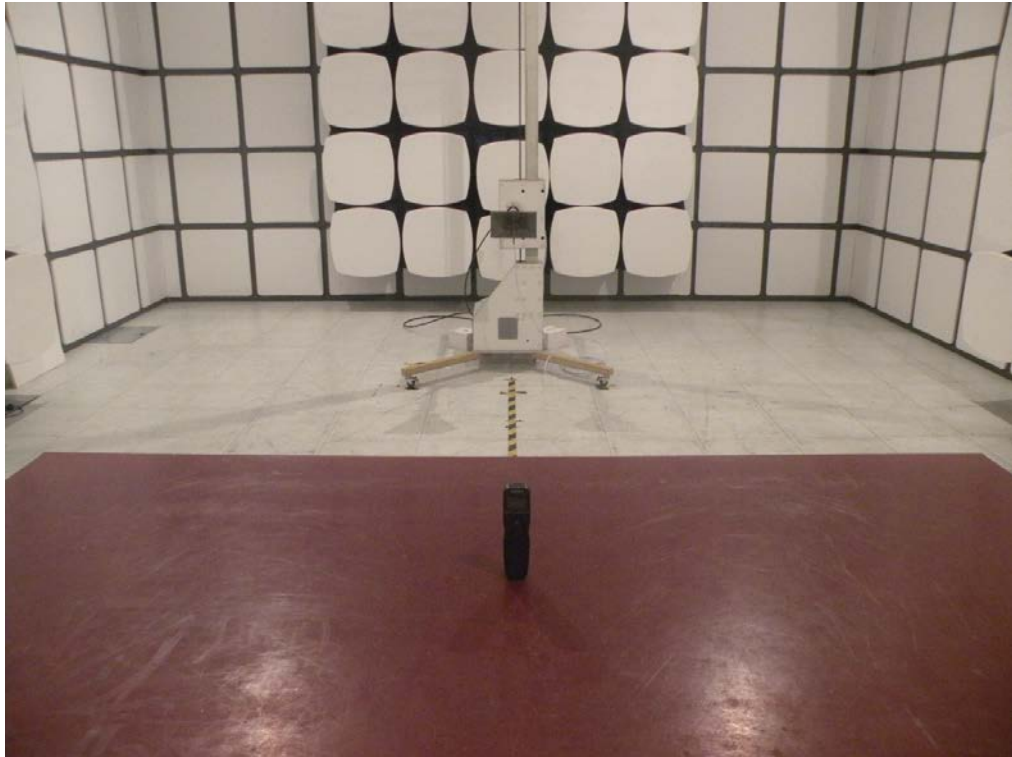

11 Photographs of EUT







