

Precaution

To avoid fire or electrical shock, do not expose this product to rain or moisture.

To avoid short circuit, please sure the batteries contacts are securely packed and in accordance with local provisions when handling the battery.

Please place the batteries and the parts which can be swallowed mistakenly away from children. Contact a doctor immediately when it occurs.

To avoid possible injury to eyes, do not use the flash light in a short distance from the eyes.

To avoid possible safety accident, do not use the flash light on the people who need a high degree of attention.

- This product is dropped or shocked seriously and the inner part of this product is bared.
- Wear gloves and take the batteries out if the corrosive liquid inside the batteries leaks.
- This product gives off strange smell, heat or smokes.

Do not disassemble or maintain this product because the internal high voltage circuit may cause the electric shock.

Please take out all the batteries if this product is not used for a long time.

Features

- **Portable Li-ion Battery System**

YN686EX-RT is equipped with 2000mAh Li-ion battery, which makes YN686EX-RT fires at least 600 times in full power possible.

- **Battery built-in Protective Circuit.**

Battery built-in overcharge protection, short-circuit protection and thermal-shutdown circuit, with advantages of long service life, high safety.

- **Ultrafast Charging Recycle System**

Every great moment can be caught because it takes just 1.5s for YN686EX-RT to finish charging recycle when it is used in full power.

- **Compatible with Canon Wireless RT System**

In wireless radio transmission flash shooting, one YN686EX-RT can be used as master unit to trigger YONGNUO RT speedlites and Canon RT speedlites, and remotely control the flash mode and flash intensity of the slave unit. One YN686EX-RT can be used as slave unit to receive wireless signal from YONGNUO RT speedlites and Canon RT speedlites, and realize remote TTL/M/MULTI/Gr flash.

- **Supports Wireless Optical Master Function**

In wireless optical shooting, YN686EX-RT can be used as master unit to trigger YONGNUO EX speedlites (except YN585EX) and Canon EX series speedlite, and realize wireless flash in TTL/M/MULTI mode.

- **Supports Wireless Optical Slave Function**

YN686EX-RT supports receiving wireless master signal from Canon speedlites or Nikon speedlites, and it supports S1 and S2 flash mode.

- **High Guide Number, High-speed Sync**

GN60@ISO100, 200mm, supports TTL, M, MULTI and Gr flash, the highest sync speed up to 1/8000s.

- **Supports USB Firmware Upgrade**

YN686EX-RT is equipped with USB port. Please visit YONGNUO official website to download the upgrade firmware and update the flash.

- **Supports Real-time Display of Battery Remaining Capacity**

YN686EX-RT supports real-time display of battery remaining capacity, which is convenient for you to learn the status of charge.

- **Supports Power Zoom**

YN686EX-RT supports auto zooming and manual zooming. The flash range can be adjusted from 20mm to 200mm.

- **Supports Auto-save, Custom Function (C.Fn)**

- **Equipped with Big Size LCD Display Screen**



Contents

Precaution	1
Features	2
Quick Start	4
Components Description.....	5~9
Mount and Remove	10
Basic Functions.....	11~16
Advanced Applications.....	17~20
Wireless Flash Shooting.....	21~26
C.Fn: Custom Settings.....	27~28
Troubleshooting Guide	29
Specifications	30~31

Conventions used in this user manual:

- In order to learn and master the operation of this speed-lite, at the meanwhile you read this manual, please take user manual of your camera as reference.
- In every operating step, we assume that both camera and speed-lite are power on.

Icons used in this user manual

-  : Supplementary information
-  : Long press the button
-  : Short press the button

Quick Start

If you don't have much time to read the whole user manual, we advise you to read this section.

1. Please avoid the excessive user of the output with maximum power. It can effectively extend the service life of this product. (It's recommended that the speedlite should be idle for more than 10 minutes when entering the overheat protection)
2. Long press [MODE] button to enter into trigger method selection interface, and rotate [⊙] to select trigger method.
3. Short press [MODE] button to switch flash mode: ETTL/M/MULTI/Gr. (Gr mode can only work in wireless master mode.)
4. Rotate [⊙] to adjust the selected parameters, and press [SET] button to confirm and save the settings.
5. Short press [**Zm/C.Fn**] button to enter into focal length setting status; long press [**Zm/C.Fn**] to enter into custom setting status.
6. Functional button 1-4 corresponding to different function according to current state of the flash, operation and details please refer to the following chapters.
7. By pressing and holding button 1 and button 3 simultaneously, the flash parameters of the speedlite will be restored to default.
8. In off status, press and hold [MODE] button, the speedlites will be turned on and it will enter into firmware upgrade interface.

Components Description

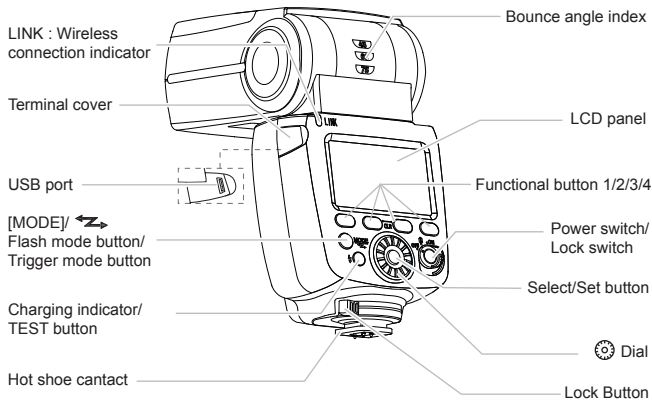
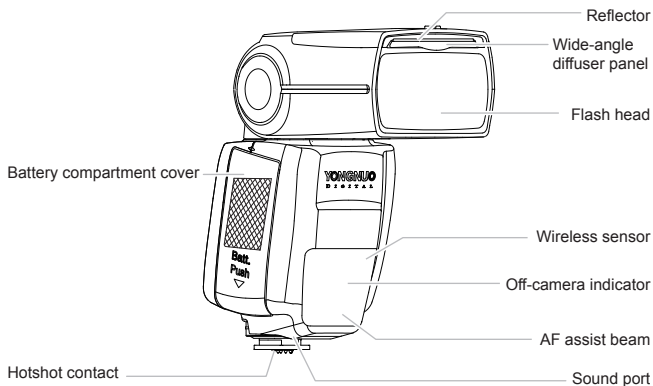

Components Description

LCD Panel

ETTL Mode

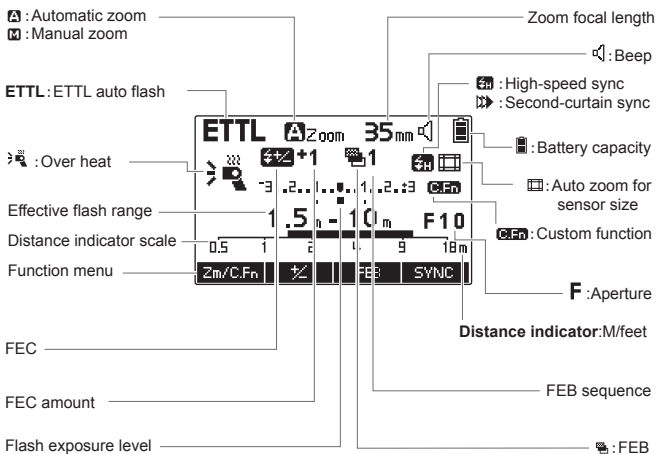

M Mode



MULTI Mode

MULTI: Multi flash

Number of flashes

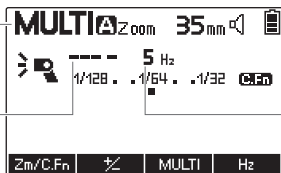

Flash frequency

Master Unit

Flash mode

: Master unit fires ON
 : Master unit fires OFF

Flash group

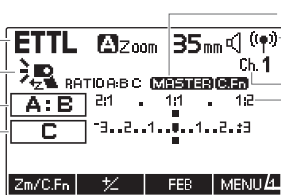

MASTER : Master control

: Wireless transmission

: Optical transmission

Ch : Channel

AUTO : Channel auto-set

Flash light ratio

Wireless Slave Unit

: Slave icon



SLAVE : Slave

Status of Indicator

Meaning of Indicator Light

Status of Charging Indicator	Meaning	Method
Red light	The speed-lite is fully charged and can be used.	Normal.
Blue light	The speed-lite has not been fully charged.	Waiting for completion of charging.
Blue light blinking	A. Low battery; the speed-lite is about to shut down B. Overheat prompt	A. Please replace batteries. B.Reduce flash frequency or stop using the speed-lite until it cools down.
Red light blinking	Overheat prompt	Reduce flash frequency or stop using the speed-lite until it cools down.
Red light and blue light blinking	Overheat protection mechanism is activated.	Stop using the speed-lite/shut down the speed-lite until it cools down.

LINK indicator

Status of LINK Indicator	Meaning	Method
Green	Wireless master unit and slave unit are in normal transmission.	Normal
Blue	Wireless master unit and slave unit are not connected.	Check if the channel and ID of the master unit and slave unit are consistent.
Green light + Blue light	Used as a slave unit	Normal

Sound Prompt

The Sound Form	Meaning	Method
Tick twice	The sound indicator is enabled; the speed-lite is started and ready to fire.	Normal
Three ticks, two times	The exposure is possibly excessive.	Adjust exposure compensation or change the shooting condition.
Tick Tick Tick	The exposure is possibly insufficient.	Adjust exposure compensation or change the shooting.
Tick-tick twice -tick twice	The charging has not been completed.	Wait for completion of charging.
Tick-a long sound	The speed-lite is fully charged and can be used.	Normal
Tick continuously and quickly	Low battery; the speed-lite is about to shut down.	Please replace the batteries.
Tick-tick-tick-	The speed-lite is in sleep mode and it shuts down automatically.	Please turn off the speed-lite and restart it.

Mount and Remove

1. Install Batteries

Slide the battery compartment cover in the direction of the arrow as shown.

Insert the batteries according to the label inside the battery compartment and make sure the direction of the battery contact (+/-) is correct.

Close the battery compartment cover in the direction of the arrow as shown.

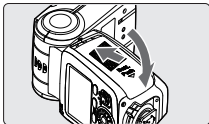
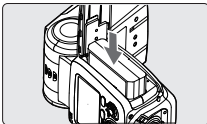
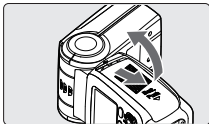

2. Attaching to the Camera & Detaching from the Camera

Slip the speedlite's mounting foot all the way into the camera's hot shoe.

Slide the mounting foot lock lever to the right side as the arrow shown until a "click" sound is heard.

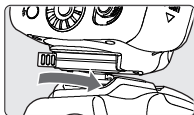
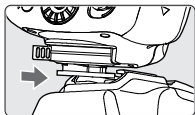

3. Detaching

Slide the [lock button] to the left side and detach the speedlite.

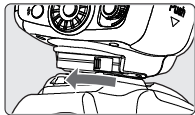

Basic Function

1. Power-on and Power-off

Set the power switch to [ON] position, the speedlite will turn on and start charging. After turned on, the [Charging Indicator] will bright with red light which indicates it can flash.

If the battery is low, and the speedlite cannot be fully charged in 25s, the <Charging Indicator> will bright with blue light, the LCD screen shows low-battery icon, and the speedlite will shut down automatically. At this moment, please change batteries.

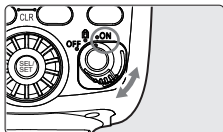

2. Key Lock Function

Slide [Power Switch] to <LOCK> position, the [⚙️] and buttons of speedlite will be locked. This function prevents the selected parameters from being changed accidentally.

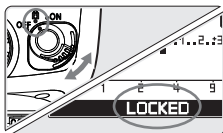

3. Test Flash

When the charging indicator turns red, pressing [⚡] button to test if the flash is normal or not.

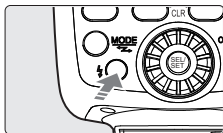

4. E TTL Mode

Short press [MODE] button to set the flash mode as E TTL mode. In E TTL mode, the light measuring system of the camera can detect the flash lighting reflected from the subject, adjust the flash output amount automatically and makes the subject and the background expose evenly. YN686EX-RT supports FEC, FEB, high-speed sync, second-curtain sync, exposure lock, aperture preview, menu access of Canon camera, etc.

In E TTL mode, the flash intensity can be compensated. The compensation range is -3EV~+3EV; the accuracy is 1/3EV or 1/2EV.

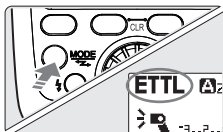

5.M Mode

Short press [MODE] button to set the flash mode as M mode. In M mode, the flash intensity can be adjusted according to your own need. By short pressing functional button [**+/-**], after <Flash Output> is highlighted, the flash output power can be adjusted when you rotate [**⊙**]. Adjustment range of flash output in M mode is 1/128~1/1. The output can be divided into 8 grades. Each grade has maximum 3 grades for fine adjustment. With 1/3EV as adjustment increment, there are totally 22 grades for fine adjustment. In shooting, you just need to set flash output, adjust the camera and press camera shutter, the flash fires when it receives sync signal from the camera.

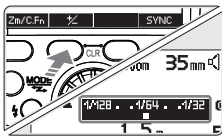
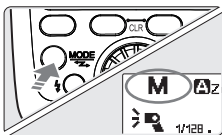

6.Multi (Stroboscopic) Mode

Short press [MODE] button to set the flash mode as Multi (stroboscopic) mode. In Multi mode, the speedlite fires according to the selected flash output, flash frequency and number of flashes. The setting method of flash output is same as setting method in M mode. The flash output range is 1/128-1/64-1/32-1/16-1/8-1/4. Select number of flashes through functional button [**MULTI**] and select flash frequency through [**Hz**] button. Enter into parameter setting status and rotate [**⊙**] to adjust number of flashes and flash frequency. The range of number of flashes is 1~100; the range of flash frequency is 1~100.

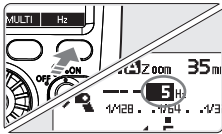
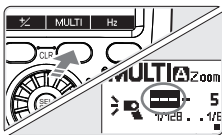

When the speedlite is in low battery, the charging speed is slow. It possibly results in flash missing when the speedlite fires with high frequency. In this situation, please reduce flash frequency and change batteries.

7.ZOOM: Setting Flash Range

Automatically zooming: Short press [Zm/C.Fn] button, wait for the focal length value highlighted on the LCD screen and adjust the coverage range through [Z]. When <A> displays at the left side of <ZOOM> button, put the speedlite on the camera, the flash light cup will move back and forth along with the change of the focal length of the lens to fit different flash coverage range (Defaults to 35mm).

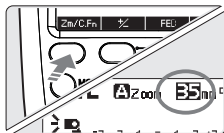

Manually Set the zooming position: Press[Zm/C.Fn] button to select focal length value, and adjust the focal length value with [Z] button. When <M> displays at the left side of [ZOOM] icon, the flash coverage (24, 28, 35, 50, 70, 80, 105, 200mm) can be manually adjusted.



When using wide-angle diffuser, the flash coverage will be extended to 14mm and the focal length will be locked.

8. Camera Menu (Supports newer versions of Canon cameras only)

For the newer versions of Canon cameras which supports E-TTL, you can operate the flash through the camera menu. On the Flash Control Menu, you can set relevant parameters of the flash through “External flash func. Settings” or “External Flash C.Fn settings”, for example, E-TTL switching mode, M mode, MULTI mode, Gr mode, Wireless Flash mode, Synchronization method, Exposure bracketing, Exposure compensation, zoom and self-defined functions.

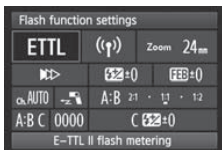

Example of EOS 1DX screen

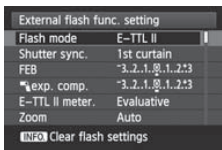

Example of EOS 60D screen

Basic Function

9.AF -Assist Beam

When it is difficult to autofocus on the subject in low-light or low-contrast shooting environment,the flash will activate the built-in AF-Assist Beam to help autofocus,the AF-Assist Beam can be set to be enable or disable.



When using this function,the focus mode of the camera should be set to one-shot AF (one shot) ,otherwise the assist beam might not work.

10.Modeling Flash

When the camera' s depth-of-field preview button is pressed,the flash fires continuously for approx.1 second,this feature is called “Modeling Flash” .For detailed operation,please refer to the user manual of the camera.



Please try to keep the times of continuous modeling flash within 10 in case of the excess temperature or burn out of the flash.

11. Power Saving Mode

This product is designed with power saving mode,and the power saving mode can be achieved by setting self-defined function,for detailed settings,please refer to subsequent “Self-defined function setting” chapter.When the power saving mode is on ,the flash will keep idle for a while and go to sleep,in sleeping mode,the flash keeps idle for a while and powers off automatically.

If the flash is in sleeping mode,you can half press the shutter of the camera or press [⚡] to wake up the flash.

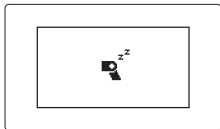

12. Overheat Protection

Sequential flash causes the increase of the internal temperature of the speedlite,when the temperature reaches to a certain amount,the

overheat warning appears.

If the speedlite is used too frequently, the overheat protection will be triggered, and the LCD screen shows the icon of <overheat protection>, with red and blue light of [recycling indicator light] flashing alternatively. When the overheat protection is triggered, the speedlite will be locked, the parameter cannot be adjusted and the speedlite cannot flash. In this case, please keep the speedlite idle for over 10 minutes until the speedlite cools down for continual use. In order not to affect shooting, please try to use 1/4 output or lower output level when fast shooting is needed.

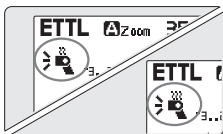

Overheat warning



Overheat protection



When the overheat warning appears, the recycling time may be increased.

When the overheat warning appears, please lower flash rate or output level appropriately.

When you take out the batteries after sequential flash, please be careful that the batteries are very hot.

13. Sound Prompt Function

Through the C.FN20 option of Self-defined setting, you can turn on or off the sound prompt function. When this function is on, the speedlite will make different sounds to remind the working mode, for the specific sound method and meaning, please refer to “Component Description” chapter.

14. Automatic Setting Saving

The speedlite will save the current settings automatically, which is convenient for your next use.

15. Clear Settings

Press the function button 2 and 3 at the same time for about 2 seconds, apart from the self-defined function setting, the parameters

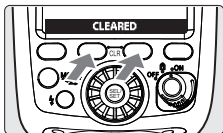

Basic Function

such as the trigger mode,flash mode,flash brightness and focal length will be restored to default setting.

16. Firmware Upgrade

This product supports firmware upgrade,please visit YONGNUO official website www.hkyongnuo.com to download the latest update software and firmware to upgrade the speedlite.The upgrading method is as follows,

- (1) Connect with the PC through USB cord(USB cord is required to buy separately)
- (2) Turn off the speedlite, press [MODE] until it enters the upgrade interface.
- (3) Enter upgrade software, upgrade the speedlite according to the software prompts.

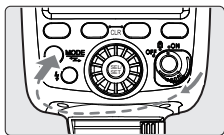
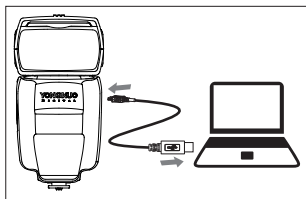

YN686C-update

Advanced Applications

1. High-speed Sync Flash

With high-speed sync flash(FP flash),the speedlite can be synchronized with all shutter speeds,the maximum shutter sync speed is up to 1/8000s.High-speed synchronization makes it very convenient for you to shoot in aperture-priority to fill flash for portrait.Short press [**SYNC**] to turn on or off high-speed synchronization function,when the function is on,the high-speed sync icon will be displayed on the LCD screen.

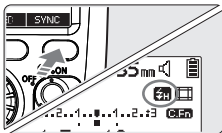

When this product is used as slave unit,the synchronization method should be set through the master control unit.

2. Second-curtain Sync

With Second-curtain Syn,the speedlite flashes at the moment that the shutter is closing.Using slow shutter speed and second-curtain sync captures the trail of light source of the subject.The second-curtain sync function needs to be supported by the camera itself,for the setting method,please refer to the user manual of the camera.In the case that your camera supports this function,you can press [**SYNC**] on the control panel to turn on or off second-curtain sync When the second-curtain sync is on,the LCD screen shows the icon of second-curtain sync.

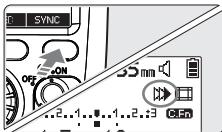

3. Remote Wireless Flash

YN686EX-RT supports remote wireless flash:The effective trigger distance of shooting with 2.4GHz radio flash is up to 100 meters;In shooting with optical transmission wireless flash,the longest distance is 25 meters for indoors,15 meters for outdoors.

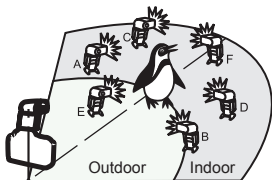



In shooting with optical transmission wireless flash,when the flash is in Sc/Sn trigger mode,the flash mode and output of the slave unit is fully controlled by the master control unit.

4. Flash Exposure Compensation

In order to make the shooting effect more satisfactory,you can set the flash exposure compensation on the camera menu or on the flash.The settable range of the flash exposure compensation is $-3EV \sim +3EV$, the increment of exposure compensation level is $1/3EV$ or $1/2EV$ (the increment of exposure compensation should bet set through the camera).Short press the function button [+/-] of the flash to enter setting of exposure compensation,rotate [] to adjust exposure compensation amount,press [SET] to save setting.

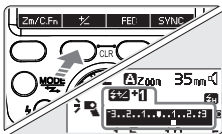

When the exposure compensation are set on flash,camera and flash trigger all at once ,the value of compensation will be added.

5. Flash Exposure Bracketing

You can set the exposure bracketing on the speedlite or on the camera.When the exposure bracketing is set,for every 3 photos,a certain amount of positive or negative compensation will be made automatically,and exposed in the sequence of ,for example, “normal→under→over” .This function will increase the success rate of your photography.The setting method on speedlite:short press [FEB],rotate [] to adjust exposure compensation value,then press [SET] to save setting.

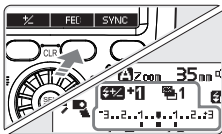

When using FEB,it is recommended to set the camera' s drive mode to “single shooting” ,and please make sure the speedlite has been recharged before shooting with FEB.

6. FE lock (Canon)

With FE lock, you should lock the center of camera's viewfinder at the subject, press the flash exposure lock button [*] of the flash, the speedlite will fire a preflash and the camera will calculate the suitable output level, at this time you have some time to recompose, after that, just press shutter to shoot. (This function can be used only when it is supported by the camera itself, for the setting, please refer to the user manual of your camera.)

7. FV Lock (Nikon)

With FE lock, you should set the "AE-L/AF-L" on the camera to "FV Lock" first. At this time, you can use the viewfinder of the camera to focus on the subject, then press [AE-L/AF-L] button on the camera, the speedlite will fire a preflash to obtain flash exposure reading for the subject, when you confirm the scene framework of your shooting, press the shutter. (This function can be used only when it is supported by the camera itself, for the setting of "AE-L/AF-L", please refer to the user manual of your camera.)

8. High-speed Burst Shooting

This product supports high-speed burst shooting, please set burst shooting mode on the camera before shooting.



The quantity of photos of burst shooting depends on the flash output setting, please use the batteries with sufficient electricity.

9. Reflection Flash

Reflection flash means using flash head aiming at the wall or ceiling, illuminate the subject with the help of reflected light for shooting. (commonly known as "bounce flash", which can decrease the shade behind the subject for more natural shooting effect.

If the wall or ceiling is out of distance, the bounce flash may be too weak to get enough exposure. The wall or

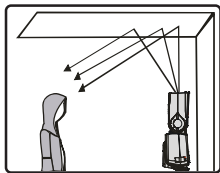

ceiling should be flat and white ,which helps to get efficient reflection,if the reflecting surface is not white,color cast may appear on the photo.

10. Use reflection board for shooting

Using reflection board for flash,pull out reflection board and wide panel at the same time from the flash head and push back the wide panel.If you take photo as this time, a highlight will be produced in the person' s eyes,which makes the eyes more charming (catchlight).It is most effective when you position the flash head toward the front and 90° up.

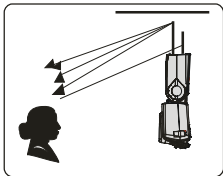

11. Use Wide-angle diffuser panel

Pull out the wide-angle diffuser panel ,push back the reflection board ,and place them according to the picture,the flash range will be increased and the flash effect will be softer and more natural.

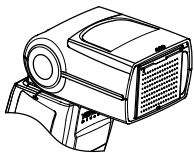

Using the wide-angle diffuser panel,the flash range will be increased and be locked at 14mm.

Wireless Flash Shooting

1. Wireless Radio Transmission

The YN686EX-RT supports wireless radio transmission flash shooting, realize wireless TTL, manual and stroboscopic function. As the master unit, the speedlite can trigger the YONGNUO and Canon RT series speedlites, such as the YN600EX-RT II/YN968EX-RT/600EX II-RT/430EX III-RT; as the slave unit, the same YN686EX-RT can respectively receive the YONGNUO and Canon RT series speedlites and the wireless signal of YN600EX-RT II/YN968EX-RT/600EX II-RT/YN-E3-RT/ST-E3-RT.

The flash mode, manual flash output, exposure compensation, exposure bracketing, exposure locking and etc settings of the master unit will be automatically transfer to each slave unit.

•Master unit setting

Long press the [Mode] button to enter the trigger mode selected interface, rotate the [Mode] dial until the LCD displays the < (FP) MASTER > to enter wireless radio master unit state. Short press the [MODE] button to swift the flash mode of the master unit.

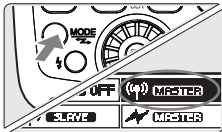

•Slave unit settings

Long press the [Mode] button to enter the trigger mode selected interface, rotate the [Mode] dial until the LCD displays the < (FP) SLAVE > to enter wireless radio slave unit state. When the YN686EX-RT used as slave unit, the flash mode will be totally controlled by the master unit. If the master unit and slave unit are set the exposure compensation, the exposure compensation value from both units will be superimposed.

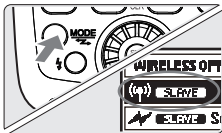

•Transmission channel/Radio ID set

In public if there are other photographers in use of the wireless radio multiple flash or other radio equipment, you can change the transmission channel and radio ID to avoid the interference. The YN686EX-RT is equipped with 15 physical channels, an automatic

Wireless Flash Shooting

channel and 10000 ID for option .

Channel setting: short press the [**CH**] button to enter the channel setting state, rotate the [⌚] to choose “AUTO” or choose the suitable channel from 1 to 15, short press the [SET] button for save.

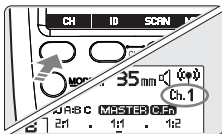

ID setting: short press the function button [**ID**] to enter ID waiting state, rotate the [⌚] to choose the position need to change, short press the [SET] button to enter the responding ID position to adjust the state, then rotate the [⌚] to choose the required number from 0 to 9, and short press the [SET] button to save the setting, press the function button [**↩**] to return to the wireless interface.

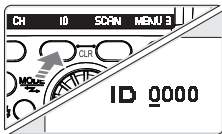

In the wireless radio transmission flash shooting process, make sure the transmission channel and ID setting of the master unit and slave unit are the same, otherwise the flash could not work normally. When the master unit and the slave unit make connection establishment, the <LINK> indicator will be in green light.



•Scan the master unit transmission channel

You can scan the radio receiving state and automatically or manually set the transmission channel of the master unit.

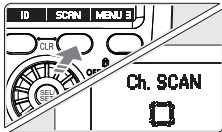

When the channel set to “AUTO” ,it will automatically set the received signal channel. When manually set the channel, you can reset the transmission channel at the same time in the reference scan results.

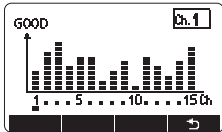

Scan setting: short press the function button [**SCAN**] to enter the scan interface, the flash LCD panel will display the scan results, the higher the peak of which channel on the chart, the stronger the radio the radio signals.



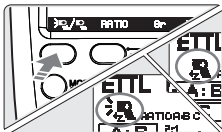

•The master flash on or forbid flash (ON/OFF)

When the YN686EX-RT as master unit to process wireless radio transmission flash shooting, you can choose if the master unit participate in the flash or not. When the master unit set to ON, the master unit will participate the flash as Group A flash. Short press the function button 4 to display <MENU 2>, short press the function button 1 [] to set the master unit to ON/OFF. < > means the master unit flash ON, < > means the master unit flash OFF.

**•Use one to three slave units for transmission flash shooting**

Short press the function button [**Gr**] on the slave unit and set the slave unit as any group of group A, B, C.

Short press the function button on the master unit to set the flash group, each short press [**RATIO**], the setting change will change by: RATIO OFF、RATIO A: B、RATIO A: B C (or RATIO A: B: C). Short press the function button [**Gr**] and rotate the [] to select the flash group which need to set the flash ratio and flash output, then short press the [*** +/-**] button to enter the flash parameter setting state, through rotate the [] to adjust the flash ratio, exposure compensation or flash output of the group flash.

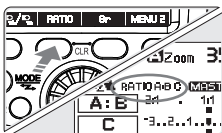
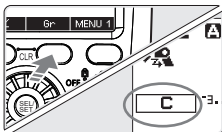

 When the master unit set as <RATIO A: B>, the slave unit set as group C, the group C of slave unit will not flash. If you need all groups A、B、C flash at the same flash output, please make the flash ALL <RATIO OFF>.

If you need larger output or hope for better lighting, you can increase the number of speedlite on one slave group for maximum total 15 units. For example: if the three slave units set to group A, they will be seen as one speedlite and controlled by the master unit.

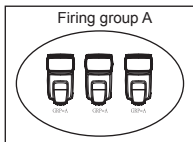

•Gr:set different flash mode and flash output on each group of speedlite to process transmission flash shooting

Short press the [mode] button on the master unit and set to Gr mode, then set the slave units group with different flash mode and flash output through the master unit. When in Gr mode flashing, up to 5 groups (A/B/C/D/E/F) of speedlite can be triggered at the same time. Short press the [Gr] button, rotate the [⊙] to select the flash group which need to set the parameter, short press the [MODE] button to select the flash mode (ETTL, M, OFF), short press the [+/-] button and rotate the [⊙] to adjust the exposure compensation and flash output. After the parameter set press the [→] button to return to the shooting ready state.

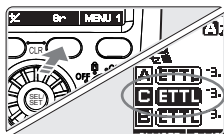
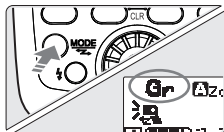
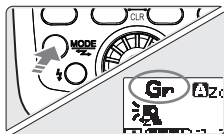

For the cameras launched before 2011, when using the <Gr> flash mode to process transmission flash shooting, all groups of flash mode will be forced to set as M mode.

2.Optical Transmission

The YN686EX-RT supports optical transmission wireless flash shooting, realize wireless TTL, manual and stroboscopic function. As master unit, the speedlite can trigger the YONGNUO EX series speedlite (excluding the YN585EX) through the wireless radio transmission; as the slave unit, the same YN600EX-RT II can respectively receive the wireless signal of YN686EX-RT, YN600EX-RT (II), YN568EX II, Canon 600EX (II) -RT, 580EX II, 7D/60D/600D cameras built-in flash, Nikon built-in flash C command and optical transmission wireless signal.

The flash mode, manual flash output, exposure compensation, exposure bracketing, exposure locking and etc settings of the master unit will be

automatically transfer to each subordinate unit.

The YN686EX-RT in optical transmission wireless flash shooting, up to supports A、B、C three groups of slave unit flash control, with total four channels (CH1/2/3/4) for option. The setting method of flash grouping and transmission channel is the same as the wireless radio transmission flash shooting.

•Master unit setting

Long press the [Mode] button to enter the trigger mode selected interface, rotate the [◀] until the LCD displays the < ⚡ MASTER > to enter wireless radio master unit state. Short press the [MODE] button to switch the flash modes between the ETTL、M、MULTI three flash modes.

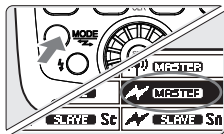

•Slave unit settings

Long press the [Mode] button to enter the trigger mode selected interface, rotate the [◀] until the LCD displays the < ⚡ SLAVE > to enter wireless radio slave unit state. When the YN686EX-RT used as slave unit, there are Sc、Sn、S1、S2 four trigger modes for option.



Sc/Sn trigger mode can respectively receive the YN686EX-RT, YN600EX-RT(II), YN568EX II, Canon 600EX (II)-RT, 580EX II, 7D/60D/600D cameras built-in flash, Nikon built-in flash C command and optical transmission wireless signal, realize off camera TTL and manual flash. When the YN686EX-RT in Sc/Sn trigger mode, the flash mode and flash output of slave unit will be totally controlled by the master unit.

Sc trigger mode: only accept the Canon optical transmission wireless flash signal

Sn trigger mode: only accept the Nikon optical transmission wireless flash signal

Wireless Flash Shooting

S1/S2 trigger mode is respectively suitable for the manual flash environment and TTL flash environment. When the YN686EX-RT in S1/S2 trigger mode, the flash mode will default to M mode, the setting method of flash output is the same as set top M mode.

S1 mode: In this mode it will work with the first flash synchronously of the master flash, with the result consistent with the use of radio slave. To use this mode properly, the master flash should be set to manual flash, should not use the TTL flash system with preflight function and the red eye reduce function with multiflash.

S2 mode: It is also called “pre-flash cancel mode”. This mode is similar with S1 mode, but it can neglect the pre-flash given by TTL flash. Therefore, it can support the master flash working in TTL mode. In particular, if S1 mode cannot flash properly and sync with your internal flash, you can try to use S2 mode.



The following situation shall be avoided when the S1 and S2 modes are used, otherwise, it may lead the flash out of sync: the red eye reduction function of the main light is used; the order mode (Nikon) or wireless mode (Canon) of the main light is used; the ST-E2 is used as the flash controller.

C.Fn: Custom Function Setting

You can custom the flash function according to your requirement. Long press the function button [Zm/C.Fn] to enter the custom function menu, rotate the [Q] to select the custom function item (Number, such as C.Fn 01), short press the [SET] button to enter the submenu, change the function settings through the [Q], short press the [SET] button for save settings and exit the submenu. After the custom function setting completed, press the [Q] button back to the shooting interface. After entering the custom function menu, short press the function button [CLEAR], then short press the function button [OK] will restore the custom function to factory default.

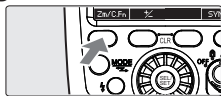

Custom Function supported by YN686EX-RT is as following:

C.Fn 00 Distance indicator display

- 0: m meter (m)
- 1: ft feet (ft)

C.Fn 01 Power saving mode

- 0: ON Turn on the power saving mode
- 1: OFF Turn off the power saving mode

C.Fn 03 Exposure bracketing auto Cancel

- 0: ON Turn on the exposure bracketing auto cancel
- 2: OFF Turn off the exposure bracketing auto cancel

C.Fn 04 Sequence of exposure bracketing

- 0: 0→→+ Sequence of FEB is "0→→+"
- 1: →→0→+ Sequence of exposure bracketing is "→→0→+"

C.Fn 08 AF-assist beam

- 0: ON Turn on the AF-assist beam
- 1: OFF Turn off the AF-assist beam

C.Fn: Custom Function Setting

C.Fn 09 Automatic identification sensor

0: ON Turn on the automatic identification sensor

1: OFF Turn off the automatic identification sensor

C.Fn 10 Power automatic off of the slave unit

0:60min Power automatic off of the slave unit is 60 minutes

1:10min Power automatic off of the slave unit is 10 minutes

C.Fn 11 Slave auto power off timer

0:8h Slave auto power off within 8 hours

1:1h Slave auto power off within 1 hours

C.Fn 20 Sound prompt

0: OFF Turn off sound prompt

1: ON Turn on sound prompt

C.Fn 22 LCD backlight

0: 12sec The display time of LCD backlight is 12 seconds

1: OFF Turn off the background light

2: ON Background light long on

C.Fn 26 Slave unit indicator light

0: ON Turn on the slave unit indicator light

1: OFF Turn off the slave unit indicator light

C.Fn 27 LCD Display contrast control

You can adjust the display contrast, total of 7 levels for option.

C.Fn 28 Background Brightness

You can adjust the background brightness, total of 11 levels for option.

C.Fn 29 Firmware Version

Display the information of current version for the flash.

Troubleshooting Guide

1.Unable to turn on the power source or unable to flash.

Please check whether the battery is installed correctly and with enough electricity;When using an external battery box, also need to install four AA batteries on flash;Please ensure that the flash hot shoe properly installed on the camera hot shoe and the flash knob lock fixed.

2.Could not flash in optical transmission wireless flash shooting.

When using outdoors, please avoid direct sunlight to the flash wireless sensor;Ensure the master unit and the slave unit channel set to consistent, and the slave unit is located in the effective wireless transmission range of the master unit.

3.Could not flash in wireless radio transmission.

Please make sure that the channel and ID of the master unit and the slave unit to consistent, and the slave units placed in the effective wireless transmission range of the master unit.

4.Photo underexposure or overexposure.

Check if the current camera shutter, aperture, sensitivity (ISO) is too close to the limit of the flash, or if the exposure compensation, exposure bracketing and relevant settings on the camera and flash are correct.

5.The photos appear dark corners or subject object can only partial light up.

Please check the current flash coverage;Please check whether the lens focal length is beyond the range of the flash, if excess you can try to pull out the wide panel to enlarge the coverage of the flash.

6.The flash control panel display blurred.

There is a layer of film on the screen when it out of the factory, you can tear it to enjoy more clear visual effect.

7.Flash in error state.

Please try to turn off the flash and remove it from the camera.Then install on the camera and restart the flash. If the problem still not be solved,please contact to YONGNUO after-sale service center with hot line 400-001-3888.

Specifications

Circuit design	Insulated Gate Bipolar Transistor (IGBT)
Guide No.	60 (ISO 100, 200mm)
Flash mode	TTL, M, MULTI, Gr
Trigger mode	Set-top, wireless master mode, wireless slave mode, wireless optical master, wireless optical slave (Sc, Sn, S1, S2)
Zoom range	20, 24, 28, 35, 50, 70, 80, 105, 135, 200mm
Vertical rotation angle	-7~90 degrees
Horizontal rotation angle	180 degrees each side
Power supply	YN-B2000 lithium battery*1
Lighting times	750 times (YONGNUO specialized lithium battery YN-B2000)
Recycle time	Approx 1.5s
Color temperature	5600k
Flash time	1/200s~1/20000s
Flash control	8 levels of output control (1/128~1/1), total of 22 levels of fine tuning
External interface	hot shoe, USB port
Wireless triggering distance	up to 100m
Optical transmission triggering distance	20~25m indoor, 10~15m outdoor
Additional features	master flash, off-camera flash, high-speed sync, rear curtain sync, FEC, FEB, FEV, the electronic flash head zooming, sound prompt, automatically saving setting, power saving mode, overheat protection, custom function, firmware update
Dimensions	Around 64×78×210mm (Extended state)
Net weight	436g
Contains items (Kit)	Speedlite(1), Protecting bag(1), Mini stand (1), Manual (1), Manufacturer certificate(1), Power adapter (1), Cable cord(1), Charger (1), Lithium battery(1)
Contains items (only flash unit)	Speedlite(1), Protecting bag(1), Mini stand (1), Manual (1), Manufacturer certificate(1)

Guide Number (ISO 100, in meters / feet)

Flash Output	Flash Coverage (mm)					
	14	20	24	28	35	50
1/1	15/49.2	26/85.3	28/91.9	30/98.4	36/118.1	42/137.8
1/2	10.6/34.8	18.4/60.4	19.8/65	21.2/69.6	25.5/83.7	29.7/97.4
1/4	7.5/24.6	13/42.7	14/45.9	15/49.2	18/59.1	21/68.9
1/8	5.3/17.4	9.2/30.2	9.9/32.5	10.6/34.8	12.7/41.7	14.8/48.6
1/16	3.8/12.5	6.5/21.3	7/23	7.5/24.6	9/29.5	10.5/34.4
1/32	2.7/8.9	4.6/15.1	4.9/16.1	5.3/17.4	6.4/21	7.4/24.3
1/64	1.9/6.2	3.3/10.8	3.5/11.5	3.8/12.5	4.5/14.8	5.3/17.4
1/128	1.3/4.3	2.3/7.5	2.5/8.2	2.7/8.9	3.2/10.5	3.7/12.1

Flash Output	Flash Coverage (mm)				
	70	80	105	135	200
1/1	50/164	53/173.9	58/190.3	59/193.6	60/196.9
1/2	35.4/116.1	37.5/123	41/134.5	41.7/136.8	42.4/139.1
1/4	25/82	26.5/86.9	29/95.1	29.5/96.8	30/98.4
1/8	17.7/58.1	18.7/61.4	20.5/67.3	20.9/68.6	21.2/69.6
1/16	12.5/41	13.3/43.6	14.5/47.6	14.8/48.6	15/49.2
1/32	8.8/28.9	9.4/30.8	10.3/33.8	10.4/34.1	10.6/34.8
1/64	6.3/20.7	6.6/21.7	7.3/24	7.4/24.3	7.5/24.6
1/128	4.4/14.4	4.7/15.4	5.1/16.7	5.2/17.1	5.3/17.4

FCC Warning:

This equipment has been tested and found to comply with the limits for a Class B digital device, pursuant to part 15 of the FCC Rules. These limits are designed to provide reasonable protection against harmful interference in a residential installation. This equipment generates, uses and can radiate radio frequency energy and, if not installed and used in accordance with the instructions, may cause harmful interference to radio communications. However, there is no guarantee that interference will not occur in a particular installation. If this equipment does cause harmful interference to radio or television reception, which can be determined by turning the equipment off and on, the user is encouraged to try to correct the interference by one or more of the following measures:

- o Reorient or relocate the receiving antenna.
- o Increase the separation between the equipment and receiver.
- o Connect the equipment into an outlet on a circuit different from that to which the receiver is connected.
- o Consult the dealer or an experienced radio/TV technician for help.

Caution: Any changes or modifications to this device not explicitly approved by manufacturer could void your authority to operate this equipment.

This device complies with part 15 of the FCC Rules. Operation is subject to the following two conditions: (1) This device may not cause harmful interference, and (2) this device must accept any interference received, including interference that may cause undesired operation.

The device has been evaluated to meet general RF exposure requirement. The device can be used in portable exposure condition without restriction.

The electronic version manual can be downloaded from www.hkyongnuo.com
The functions of this manual are based on the test conditions of our company. Further notice will not be given if the design and specifications change;
The YONGNUO logo in this manual includes the registered trademark or trademark of SHENZHEN YONGNUO PHOTOGRAPHY EQUIPMENT Co., Ltd in China or/and other countries (regions). All other trademarks are the property of their respective owners.