

# YN320

Pro LED Video Light  
(User manual for 3200K-5500K)

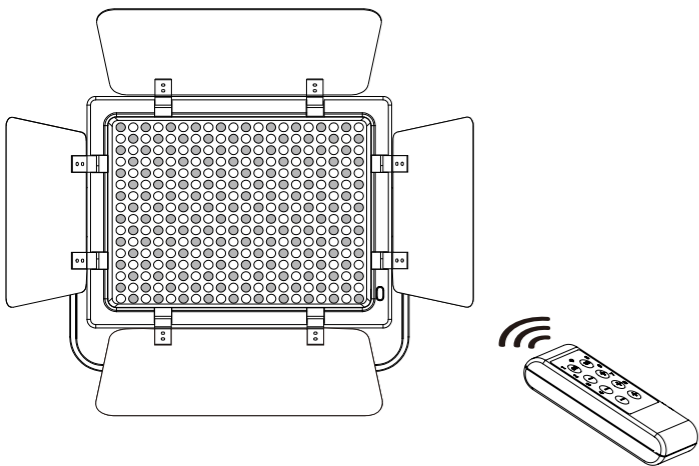

Thank you for using the YN320 LED video light. Please read the manual carefully and keep this user manual properly for reference.

## Function Introduction

- The YN320 is equipped with multi-channel wireless remote control, which can respectively control 8 groups of the luminance and power switch of the video light, allowing you to operate more easily.
- You can download the mobile APP from the official website, control the LED video light through the mobile phone, read the current luminance and channel of the LED video light. It can respectively control 8 groups of luminance and power switch of the video light, allowing you to control the LED video light as needed.
- YN320 is formed by 160 LED lamp beads with 3200k color temperature and another 160 LED lamp beads with 5500k color temperature, which are high-quality lamp beads of extra-large luminous chips, with higher luminance in same energy consumption. The color temperature can be adjusted from 3200-5500K as needed, with more practical use.
- The YN320 adopts the Yongnuo proprietary LED driving technology, more stable and reliable when shooting.
- The YN320 adopts the encoder digital dimming which can be separately adjusted to rough dimming and fine dimming modes, more convenient to use.
- The YN320 adopts LED digital display screen, real-time display the battery power, current channel and power output, more intuitive and practical.
- The YN320 supports external DC power input, which is convenient for your long shooting (the power adapter is optional).
- The YN320 is equipped with U-shaped holder, convenient and quick to adjust the light angle, and equipped with hot shoe base, which is better for SLR camera and video camera.
- The YN320 is attached with two color temperature plates, suitable for use in different environments.

## precautions

- This product should be used under the ventilated environment. Please make sure the heat emission hole won't be blocked when you are using this speed-lite.
- Do not disassemble the product, maintenance or repair of this product should be carried through by technical maintenance personnel of our company or technical maintenance personnel authorized.
- Do not use this product in flammable and explosive place, or where it can be exposed to moisture.
- Please keep this product away from the children.

## Product Specification

Light Source	320 LED lamp beads	Luminance Angle	55°
Color Temperature	3200K-5500K	Compatible batteries	One NP-F750 series lithium batteries
Color Rendering Index	≥95	External power source	12V 2A DC power supply
Output power	20W	dimension	252*200*62MM
Lumen	2480LM	Average Service Life	50000H
Weight	780G	Control distance	<15M

Contents: Video light (1); user manual (1); remote controller (1); color temperature filter (2) Note: Please contact your dealer if the contents missing.

## Product Structure

- Reflector
- Softbox lock
- DC Power Jack
- Battery slot
- Power switch
- Battery lock
- Brightness adjusting knob
- Holder fastening knob
- LCD digital display screen
- Hot shoe base
- 3200k brightness value
- 5500k brightness value
- Electric quantity test value
- Coarse/Fine adjusting switch display
- Bluetooth connection indicator
- Channel value
- 3200k/5500k color temperature switch button  
(long press to turn on/off the back light)
- Coarse/Fine adjusting switch button  
(Continue long press to switch channels)
- SET memory button  
(Long press to update the saved brightness value, short press to restore the saved brightness value)

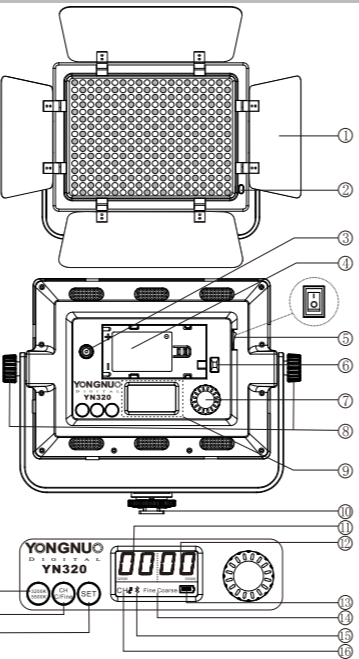

## Remote Controller Structure

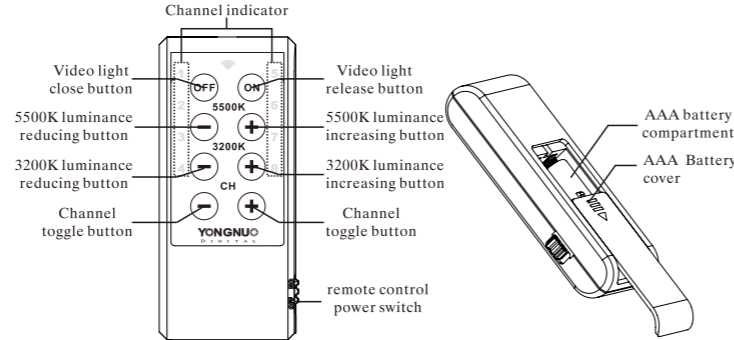

## Installation and fixed

- Battery Installation**  
a. When the lithium battery is mounted, the battery is mounted to a card groove according to the arrow direction.  
NOTE: It's recommended to use YONGNUO NP-F750 battery to get a more lasting shooting experience. The battery capacity of YONGNUO NP-F750 reaches up to 5200mAh. When YN320 is set to the maximum luminous intensity, it will keep working about 120 minutes. Please take the batteries out when this video light is not used.

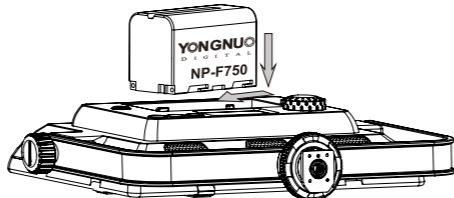

- When removing the lithium batteries, please press the battery lock and then take out the lithium batteries.

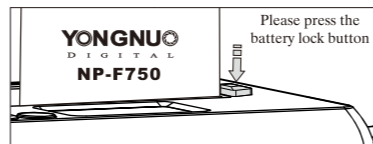

## 2.External Power Supply

It is recommended to use YONGNUO power adapter with YN320 to obtain lasting service time. When using external power supply, the video light will stop the battery power supply automatically and will not get the battery charged. The external power supply interface outside is positive and the interface inside is negative. The input voltage is 12V and the electric current is 2A.  
Note: If YN320 defective when it is used with power adapter of other brands, YN320 will no longer be guaranteed for repair.

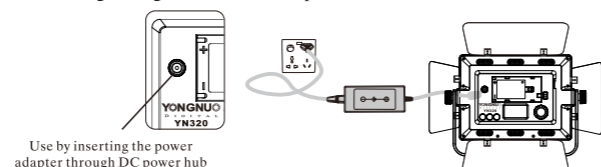

Use by inserting the power adapter through DC power hub

## 3.Fix on the DSLR/Camera hot shoe.

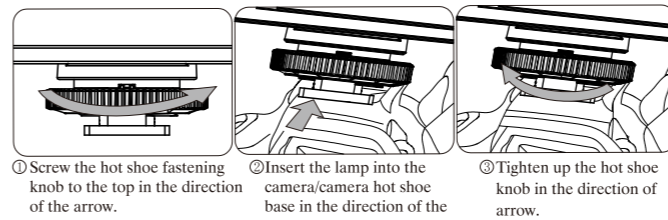

## Method Application

- Start up & Shut down and Brightness adjustment**  
When pressing the power switch button, the LED video light will light up; rotate this button rightwards the brightness of the LED video light will increase while leftwards will reduce.

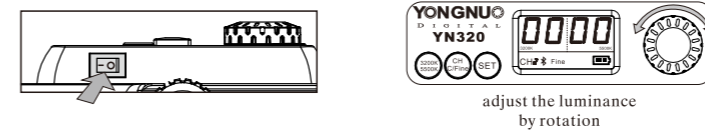

- Coarse/Fine Button**  
Press the Fine/Coarse button to led the indicator light, when the Fine indicator light enter fine adjusting mode, the luminance will be adjusted with 1% as an adjusting grade. Then press the button to switch to coarse adjusting, the luminance will be adjusted with 10% as an adjusting grade.

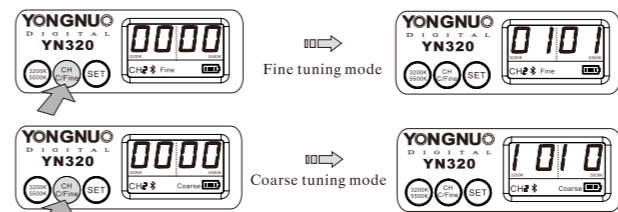

- 3.3200k/5500k color temperature switch button**  
Short press the 3200k/5500k color temperature switch button, after switching the color temperature, the display frame will display the color temperature between 3200K and 5500K by changing the brightness ratio between the two color temperature.

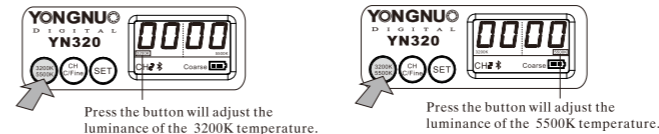

- 4.Channel Switch Button**  
Press the Coarse/Fine adjusting switch button to enter the video light automatically switch receiving channel, the displayed screen appears CH1 to CH8, release the button to select the channel. Assuming the channel of video light switch to H2, the channel of the remote controller will be also adjusted to CH2 transmit channel (as the right picture shown), then the remote controller can control the video light. If you have more than one unit of the same model, the luminance and power switch can be controlled by grouping, at most divided into eight groups. (There is numbers 1-8 on the remote controller panel, which corresponds to the corresponding channels, switch the channel through CH button).

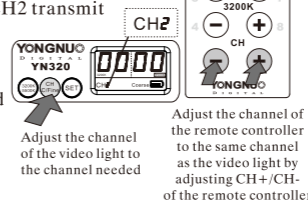

- 5.Electric Quantity Test**  
Real-time monitoring of battery power display, for example, the power of the figure A is 41% to 60%, and the power of figure B battery is 81% to 100%. (Note: the power test with low luminance is different from that with high luminance, thus the service time is based on the current luminance.)



- 6.Change the color temperature plates**  
The product comes with two color temperature plates, which can be used when the color temperature plate card slot is inserted on the front of the product, and when the color temperature plate is taken, please press the color temperature plate lock button.

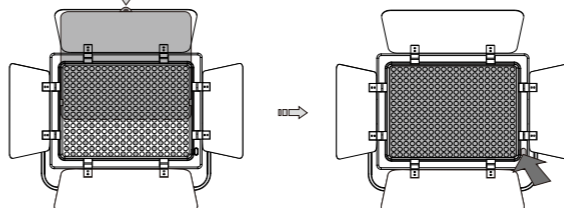

- 7.Backlight**  
a. Long press the 3200K/5500K color temperature switch button for around two seconds, after the backlight turned on, the backlight will be automatically extinguished in 10 seconds without operation, press any key or switch to turn on the back light.  
b. Long press the 3200K/5500K color temperature switch button for around two seconds, after the backlight turned off, press any key or switch to turn on the back light.

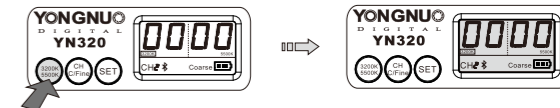

- 8.Memory Function**  
When you think the video light has been adjusted to the optimal brightness and color temperature, long press SET key, the LCD screen brightness values blink twice means successful save settings. When you need to restore previous settings after adjusting the camera light, just short press the SET button again.

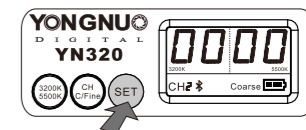

- 9. Mobile APP Remote Control**  
The product supports mobile remote control, the APP can be downloaded from the YONGNUO official website or download through scanning the two-dimension code on the gift box, Mobile phone APP will be updated continuously. Please pay attention to YONGNUO official website for latest version of APP to get better remote control experience.

## Failure Analysis and Troubleshooting

When using this product, you may encounter the following problems:

Description	Cause	Troubleshooting
No reaction after power on	Low Battery	Install new batteries or connect external power supply
	Damaged circuit board	Depot repair
Inadequate or low luminance at the greatest luminous intensity	Low battery	Install new batteries or re-charge the batteries
Inaccurate battery capacity test; low battery in high luminance and full battery in low luminance.	The battery capacity indicates the length of time available for the use in the current luminance. Higher luminance required more power and the length of time available for use will be shortened, so the battery capacity shown gets lower	Normal phenomenon and no measure needed
The video light can't be controlled remotely.	Too far away	Ensure the remote control distance is no more than 15 meters
	Remote control and LED light are on different channels	pls refer to User Manual to reset channel

The functions in this manual are based on the test conditions of our company. Further notice will not be given if the design and specifications change.  
SHENZHEN YONGNUO PHOTOGRAPHY EQUIPMENT Co.Ltd.  
Add: Building A, Shenfubao modern optics factory, Kengzi Street, Pingshan District, Shenzhen  
TEL: 0755-8376 2448  
Wed: www.hkyongnuo.com  
Manufacture address: 4/F, Building 2, Donglongxing Technology Park, East Huaning Road, Dalang Street, Longhua District, Shenzhen  
After-sales Service TEL: 400-0013-888

## **FCC STATEMENT :**

This device complies with Part 15 of the FCC Rules. Operation is subject to the following two conditions:

- (1) This device may not cause harmful interference, and
- (2) This device must accept any interference received, including interference that may cause undesired operation.

**Warning:** Changes or modifications not expressly approved by the party responsible for compliance could void the user's authority to operate the equipment.

NOTE: This equipment has been tested and found to comply with the limits for a Class B digital device, pursuant to Part 15 of the FCC Rules. These limits are designed to provide reasonable protection against harmful interference in a residential installation. This equipment generates uses and can radiate radio frequency energy and, if not installed and used in accordance with the instructions, may cause harmful interference to radio communications. However, there is no guarantee that interference will not occur in a particular installation. If this equipment does cause harmful interference to radio or television reception, which can be determined by turning the equipment off and on, the user is encouraged to try to correct the interference by one or more of the following measures:

- Reorient or relocate the receiving antenna.

- Increase the separation between the equipment and receiver.

- Connect the equipment into an outlet on a circuit different from that to which the receiver is connected.

- Consult the dealer or an experienced radio/TV technician for help.

RF warning statement:

The device has been evaluated to meet general RF exposure requirement. The device can be used in portable exposure condition without restriction.