



Hermon Laboratories Ltd.
Harakevet Industrial Zone, Binyamina 30500,
Israel
Tel. +972-4-6288001
Fax. +972-4-6288277
E-mail: mail@hermonlabs.com

TEST REPORT

ACCORDING TO: FCC 47 CFR part 15 section 15.255,
RSS-210 issue 8 Annex 13, RSS-Gen issue 4

FOR:

Siklu Communication Ltd.

**Point-to-point wireless Ethernet link
operating in 57-64 GHz**

Model: EH-600T

FCC ID:2ACYESK-60GTDD-A1

IC:12353A-60GTDDA1

This report is in conformity with ISO/IEC 17025. The "A2LA Accredited" symbol endorsement applies only to the tests and calibrations that are listed in the scope of Hermon Laboratories accreditation. The test results relate only to the items tested. This test report shall not be reproduced in any form except in full with the written approval of Hermon Laboratories Ltd.



Table of contents

1	Applicant information.....	3
2	Equipment under test attributes	3
3	Manufacturer information	3
4	Test details.....	3
5	Tests summary.....	4
6	EUT description.....	5
6.1	General information.....	5
6.2	Ports and lines	5
6.3	Support and test equipment	5
6.4	Changes made in the EUT	5
6.5	Test configuration.....	6
6.6	Transmitter characteristics	7
7	Transmitter tests	8
7.1	Transmitter power test.....	8
7.2	Occupied bandwidth test.....	14
7.3	Spurious emissions at RF antenna connector test.....	19
7.4	Out of band radiated emissions below 40 GHz	38
7.5	Frequency stability test.....	54
8	APPENDIX A Test equipment and ancillaries used for tests.....	56
9	APPENDIX B Measurement uncertainties.....	58
10	APPENDIX C Test laboratory description	59
11	APPENDIX D Specification references	59
12	APPENDIX E Test equipment correction factors.....	60
13	APPENDIX F Abbreviations and acronyms.....	69

1 Applicant information

Client name: Siklu Communication Ltd.
Address: 43 Hasivim street, Petach-Tikva 49517, Israel
Telephone: +972 3921 4015
Fax: +972 3921 4162
E-mail: baruch@siklu.com
Contact name: Mr. Baruch Schwarz

2 Equipment under test attributes

Product name: Point-to-point wireless Ethernet link operating at 57-64 GHz
Product type: Transceiver
Model(s): EH-600T
Serial number: S538000151
Hardware version: C0
Software release: 6.6
Receipt date 8/19/2015

3 Manufacturer information

Manufacturer name: Siklu Communication Ltd.
Address: 43 Hasivim street, Petach-Tikva 49517, Israel
Telephone: +972 3921 4015
Fax: +972 3921 4162
E-Mail: baruch@siklu.com
Contact name: Mr. Baruch Schwarz

4 Test details

Project ID: 27393
Location: Hermon Laboratories Ltd. Harakevet Industrial Zone, Binyamina 30500, Israel
Test started: 8/19/2015
Test completed: 8/30/2015
Test specification(s): FCC 47 CFR part 15 section 15.255:2014;
RSS-210 issue 8 Annex 13 section A13.2; RSS-Gen issue 4



5 Tests summary

Test	Status
FCC Section 15.255(b)(ii), RSS-210 section A13.2.2, Transmitter power and power spectral density	Pass
FCC Section 15.215(c), 2.1049, RSS-Gen, Section 6.6, Occupied bandwidth	Pass
FCC Section 15.255(c), RSS-210 section A13.2.2, Conducted spurious emissions	Pass
FCC Section 15.255(c)(2), RSS-210 section A13.2.2, Radiated spurious emissions below 40 GHz	Pass
FCC Section 15.255(c)(3), RSS-210 section A13.2.2, Radiated emissions outside assigned band and above 40 GHz up to 220 GHz	Pass
FCC Section 15.255(f), RSS-210 section A13.2.5, Frequency tolerance	Tested without limit
FCC Section 15.255(g), RSS-Gen, section 5.5, RF exposure	Pass, exhibit included in Application for certification
RSS-Gen section 7.1, Receiver spurious emission	Pass*

*Note: tested during the transmitter radiated spurious emissions below 40 GHz.

The product was approved by FCC under FCC ID:2ACYESK-60GTDD-A1 and IC under IC:12353A-60GTDDA1. The relevant tests to support Application for Class II permissive changes certification were done.

The test results relate only to the items tested. Pass/ fail decision was based on nominal values.

	Name and Title	Date	Signature
Tested by:	Mrs. E. Pitt, test engineer	August 30, 2015	
Reviewed by:	Mrs. M. Cherniavsky, certification engineer	September 9, 2015	
Approved by:	Mr. M. Nikishin, EMC and Radio group manager	September 24, 2015	

6 EUT description

6.1 General information

The EUT is an outdoor unit of point-to-point high BW system, the first TDD member of Siklu's EtherHaul family of wireless products, featuring carrier grade, high capacity Ethernet with flexible support of the 57-64 GHz regulated V-Band. The EUT radio supports up to 1 Gbps.

Siklu's EtherHaul EH-600T Rev C0 wireless backhaul radio link operates in the new V-band spectrum, which has clear technological and economical advantages over the existing lower frequency bands.

The EtherHaul EH-600T Rev C0 system comprises:

- the EtherHaul EH-600T-ODU outdoor unit (radio link unit and antenna);
- the EtherHaul system host software and command line interface for complete and flexible system configuration, administration and management.

During the testing the EUT system was powered by 48 VDC.

6.2 Ports and lines

Port type	Port description	Connected from	Connected to	Qty.	Cable type	Cable length, m
Telecom	Ethernet	EUT	EUT (Loop)	2	F.O.	2
Signal	USB	For debugging only	Not connected	1	NA	NA
Power	AC	AC mains	DC power supply	1	Unshielded	10
Power	48 VDCDC	DC power supply	EUT	1	Unshielded	1.5

6.3 Support and test equipment

Description	Manufacturer	Model number	Serial number
Laptop	Lenovo	ThinkPad T61	L3-E0080
AC/DC adapter	PHIHONG	PDA041B-48VB	NA
Power supply	MEAN WELL	MRD- 40-48	RB11015370

6.4 Changes made in the EUT

No changes were performed in the EUT during testing.



6.5 Test configuration

6.5.1 EUT test configuration

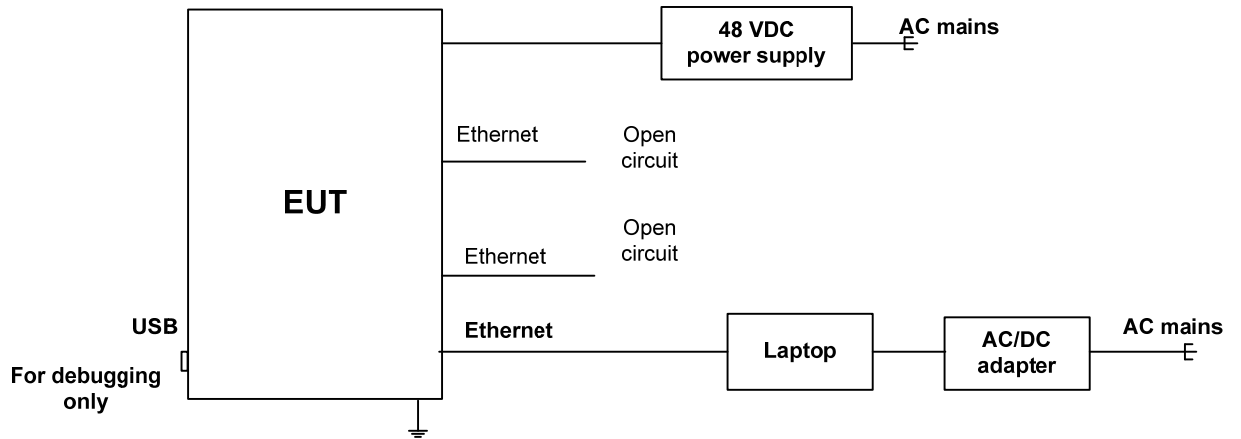



6.6 Transmitter characteristics

Type of equipment				
V	Stand-alone (Equipment with or without its own control provisions)			
	Combined equipment (Equipment where the radio part is fully integrated within another type of equipment)			
	Plug-in card (Equipment intended for a variety of host systems)			
Intended use		Condition of use		
V	fixed	Always at a distance more than 2 m from all people		
	mobile	Always at a distance more than 20 cm from all people		
	portable	May operate at a distance closer than 20 cm to human body		
Assigned frequency range		57.0 GHz – 64.0 GHz		
Operating frequencies (tested)		57375, 60375, 63375 MHz for all BW		
Maximum rated output power		At transmitter 50 Ω RF output connector 12 dBm		
Is transmitter output power variable?	V	No		
			continuous variable	
	Yes		stepped variable with stepsize	dB
			minimum RF power	dBm
		maximum RF power		
Antenna connection				
unique coupling	V	standard connector	Integral with temporary RF connector without temporary RF connector	
Antenna/s technical characteristics				
Type	Manufacturer	Model number	Gain	
Integrated (cassegrain reflector)	Siklu Ltd.	VSAN003	35 dBi	
Transmitter 99% power bandwidth, MHz	Transmitter aggregate data rate/s, Mbps		Type of modulation	
250	80		QPSK	
500	160		QPSK	
500	852		16QAM	
500	1280		64QAM	
Type of multiplexing		TDD		
Transmitter power source				
V	DC	Nominal rated voltage	Battery type	
		Nominal rated voltage	48 V	
	AC mains	Voltage range	42-57 V	
		Nominal rated voltage	Frequency	
Common power source for transmitter and receiver		V	yes no	



Test specification:	Section 15.255(b)(ii), RSS-210 section A13.2.2, Transmitter power and power spectral density		
Test procedure:	47 CFR, Section 2.1046; Section 15.255(b); KDB 200433 D02		
Test mode:	Compliance	Verdict:	PASS
Date:	8/19/2015		
Temperature: 24.3 °C	Air Pressure: 1007 hPa	Relative Humidity: 42%	Power Supply: 48 VDC
Remarks:			

7 Transmitter tests

7.1 Transmitter power test

7.1.1 General

This test was performed to measure the peak output power at RF antenna connector. Specification test limits are given in Table 7.1.1.

Table 7.1.1 Conducted output power limits

Assigned frequency range, MHz	Maximum output power			
	Peak output power		EIRP, dBm*	
	mW	dBm	Peak	Average
57000 – 64000	500	27.0	53	50

*EIRP limit was calculated as follows:

Average power: 82 dBm – 2 dB x (51-35) = 50 dBm

Peak power: 85 dBm – 2 dB x (51-35) = 53 dBm.

7.1.2 Test procedure

7.1.2.1 The EUT was set up as shown in Figure 7.1.1, energized and its proper operation was checked.

7.1.2.2 The EUT was adjusted to produce maximum available for end user RF output power.

7.1.2.3 The peak output power was measured with spectrum analyzer as provided in the associated tables and plots.

Figure 7.1.1 Peak output power test setup

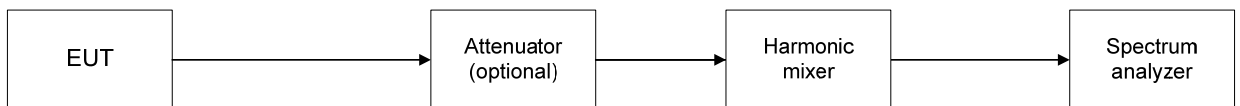



Test specification:	Section 15.255(b)(ii), RSS-210 section A13.2.2, Transmitter power and power spectral density		
Test procedure:	47 CFR, Section 2.1046; Section 15.255(b); KDB 200433 D02		
Test mode:	Compliance	Verdict:	PASS
Date:	8/19/2015		
Temperature: 24.3 °C	Air Pressure: 1007 hPa	Relative Humidity: 42%	Power Supply: 48 VDC
Remarks:			

Table 7.1.2 Peak output power test results

OPERATING FREQUENCY RANGE: 57.0 – 64.0 GHz
DETECTOR USED: Peak
RESOLUTION BANDWIDTH: 8 MHz
VIDEO BANDWIDTH: 50 MHz
TRANSMITTER OUTPUT POWER SETTINGS: Maximum

Frequency, MHz	Modulation	Emission Bandwidth MHz	Duty Cycle, %	Attenuator	Peak output power, dBm	Limit, dBm	Margin, dB*	Verdict
57375	QPSK	250	100	included	11.18	27.0	-15.82	Pass
60375			100	included	10.72	27.0	-16.28	Pass
63625			100	included	9.78	27.0	-17.22	Pass
57375	64 QAM	500	100	included	12.00	27.0	-15.00	Pass
60375			100	included	11.08	27.0	-15.92	Pass
63625			100	included	10.38	27.0	-16.62	Pass

*- Margin = RF power, dBm – Limit, dBm



Test specification:	Section 15.255(b)(ii), RSS-210 section A13.2.2, Transmitter power and power spectral density		
Test procedure:	47 CFR, Section 2.1046; Section 15.255(b); KDB 200433 D02		
Test mode:	Compliance	Verdict: PASS	
Date:	8/19/2015		
Temperature: 24.3 °C	Air Pressure: 1007 hPa	Relative Humidity: 42%	Power Supply: 48 VDC
Remarks:			

Table 7.1.3 Peak EIRP test results

OPERATING FREQUENCY RANGE: 57.0 – 64.0 GHz
DETECTOR USED: PEAK
RESOLUTION BANDWIDTH: 8 MHz
VIDEO BANDWIDTH: 50 MHz
TRANSMITTER OUTPUT POWER SETTINGS: Maximum

Frequency, MHz	Modulation	Emission Bandwidth MHz	Duty Cycle, %	Peak output power dBm	EIRP, dBm*	Limit, dBm	Margin, dB**	Verdict
57375	QPSK	250	100	11.18	46.18	53	-6.82	Pass
60375			100	10.72	45.72	53	-7.28	Pass
63375			100	9.78	44.78	53	-8.22	Pass
57375	64 QAM	500	100	12.00	47.00	53	-6.00	Pass
60375			100	11.08	46.08	53	-6.92	Pass
63375			100	10.38	45.38	53	-7.62	Pass

* - EIRP, dBm = Peak output power, dBm + Antenna Gain(dBi), where Antenna Gain = 35.0 dBi

** - Margin, dB = EIRP, dBm – Limit, dBm

Table 7.1.4 Average EIRP test results

OPERATING FREQUENCY RANGE: 57.0 – 64.0 GHz
DETECTOR USED: Average
RESOLUTION BANDWIDTH: 8 MHz
VIDEO BANDWIDTH: 50 MHz
TRANSMITTER OUTPUT POWER SETTINGS: Maximum

Frequency, MHz	Modulation	Emission Bandwidth MHz	Duty Cycle, %	Average output power, dBm	EIRP, dBm*	Limit, dBm	Margin, dB**	Verdict
57375	QPSK	250	100	6.24	41.24	50	-8.76	Pass
60375			100	5.80	40.80	50	-9.20	Pass
63375			100	4.82	39.82	50	-10.18	Pass
57375	64 QAM	500	100	6.46	41.46	50	-8.54	Pass
60375			100	5.65	40.65	50	-9.35	Pass
63375			100	5.09	40.09	50	-9.91	Pass

* - EIRP, dBm = Average output power, dBm + Antenna Gain(dBi), where Antenna Gain = 35.0 dBi

** - Margin, dB = EIRP, dBm – Limit, dBm

Reference numbers of test equipment used

HL 1303	HL 2358	HL 2909	HL 3291	HL 3295	HL 3305	HL 3433	HL 3434
---------	---------	---------	---------	---------	---------	---------	---------

Full description is given in Appendix A.



HERMON LABORATORIES

Test specification:	Section 15.255(b)(ii), RSS-210 section A13.2.2, Transmitter power and power spectral density		
Test procedure:	47 CFR, Section 2.1046; Section 15.255(b); KDB 200433 D02		
Test mode:	Compliance	Verdict:	PASS
Date:	8/19/2015		
Temperature: 24.3 °C	Air Pressure: 1007 hPa	Relative Humidity: 42%	Power Supply: 48 VDC
Remarks:			

Plot 7.1.1 Output power test result at the low frequency

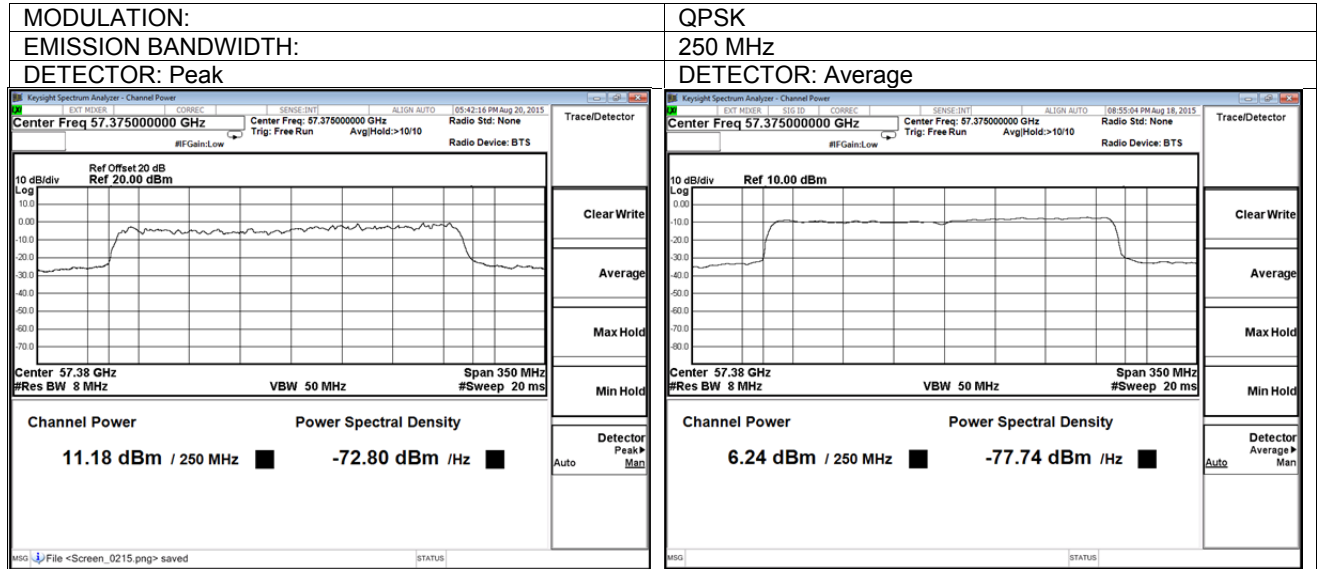

Plot 7.1.2 Output power test result at the mid frequency

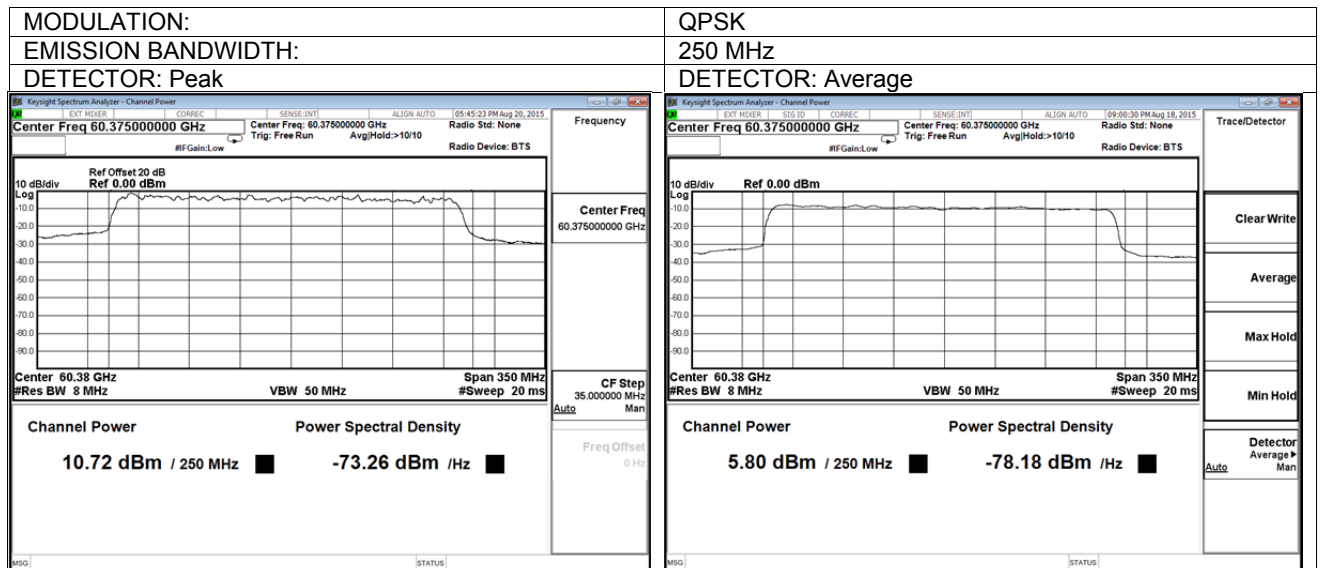



HERMON LABORATORIES

Test specification:		Section 15.255(b)(ii), RSS-210 section A13.2.2, Transmitter power and power spectral density	
Test procedure:		47 CFR, Section 2.1046; Section 15.255(b); KDB 200433 D02	
Test mode:		Compliance	
Date:		8/19/2015	
Temperature: 24.3 °C		Air Pressure: 1007 hPa	
		Relative Humidity: 42%	
		Power Supply: 48 VDC	
Remarks:			
		Verdict: PASS	

Plot 7.1.3 Output power test result at the high frequency

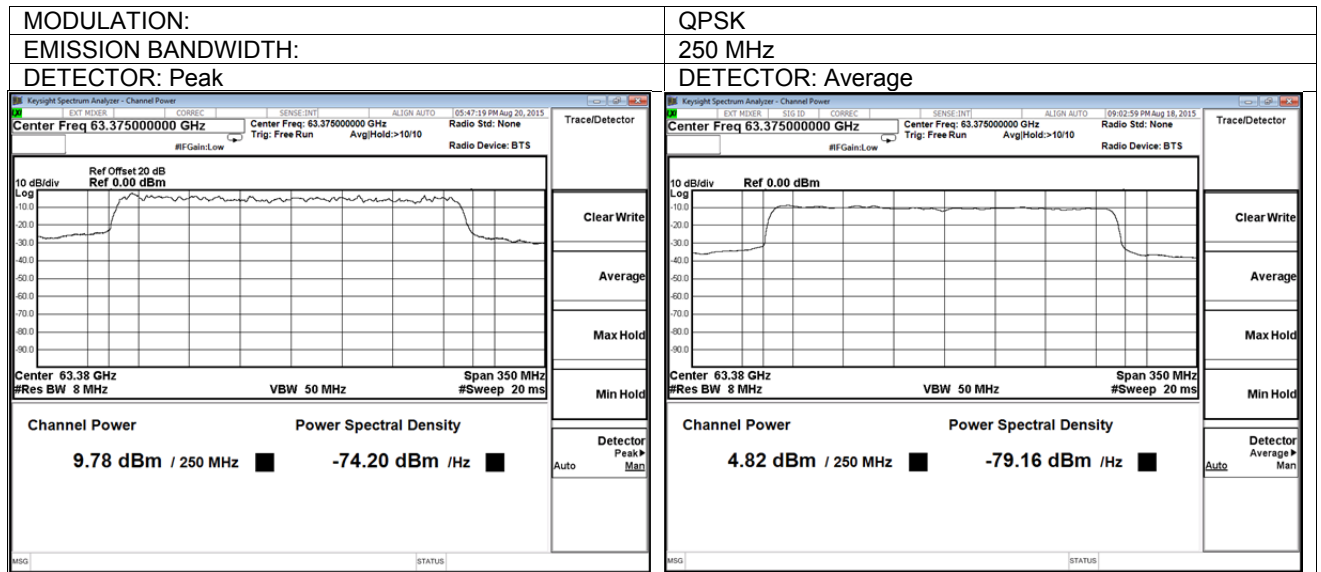

Plot 7.1.4 Output power test result at the low frequency

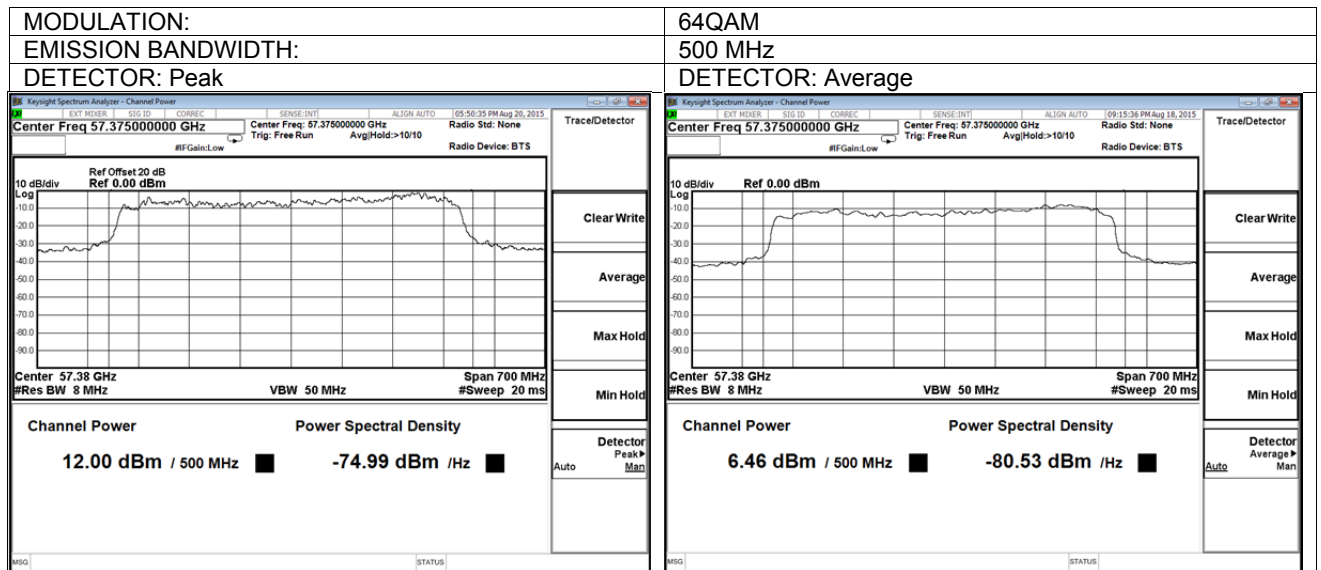



HERMON LABORATORIES

Test specification:	Section 15.255(b)(ii), RSS-210 section A13.2.2, Transmitter power and power spectral density		
Test procedure:	47 CFR, Section 2.1046; Section 15.255(b); KDB 200433 D02		
Test mode:	Compliance	Verdict:	PASS
Date:	8/19/2015		
Temperature: 24.3 °C	Air Pressure: 1007 hPa	Relative Humidity: 42%	Power Supply: 48 VDC
Remarks:			

Plot 7.1.5 Output power test result at the mid frequency

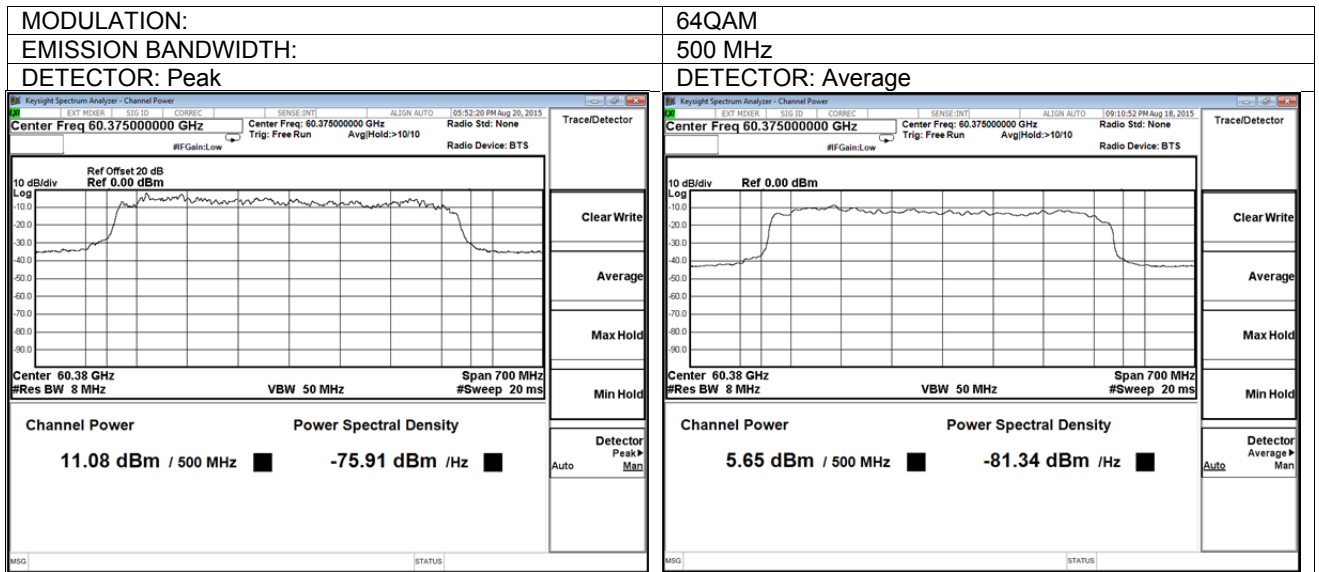

Plot 7.1.6 Output power test result at the high frequency

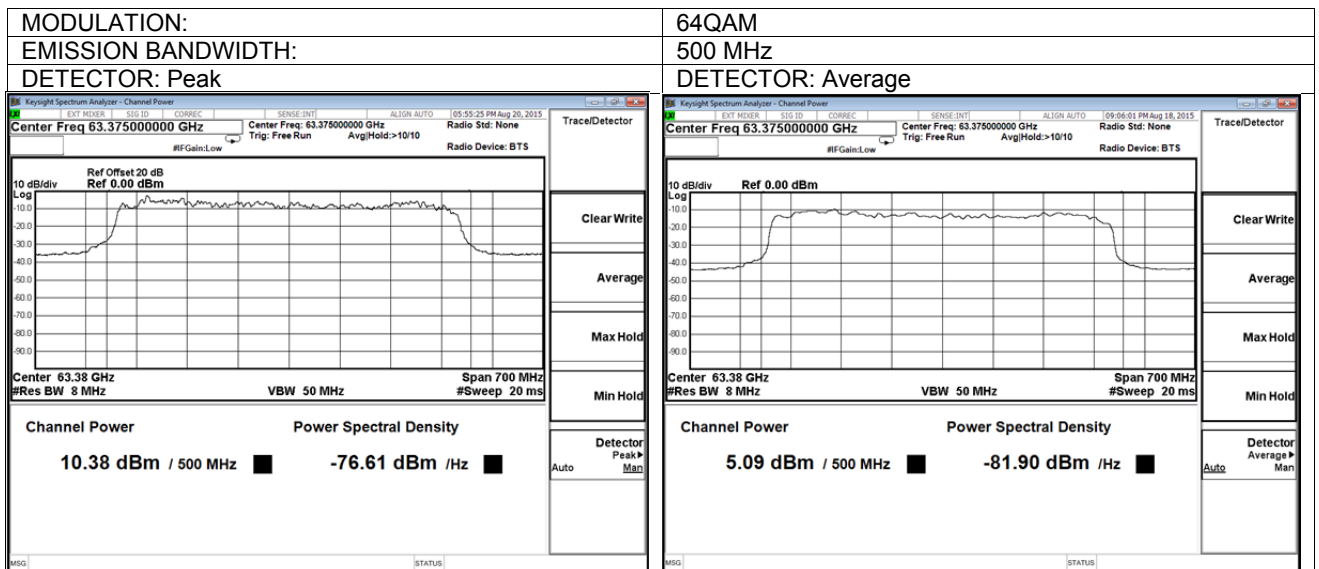



Test specification:	Section 15.215(c), RSS-Gen section 4.6.1 Occupied bandwidth		
Test procedure:	47 CFR, Section 2.1049		
Test mode:	Compliance	Verdict:	PASS
Date:	8/19/2015		
Temperature: 23 °C	Air Pressure: 1008 hPa	Relative Humidity: 42%	Power Supply: 48 VDC
Remarks:			

7.2 Occupied bandwidth test

7.2.1 General

This test was performed to measure transmitter occupied bandwidth. Specification test limits are given in Table 7.2.1.

Table 7.2.1 Occupied bandwidth limits

Assigned frequency range, MHz	Modulation envelope reference points	Max bandwidth, MHz
57000 - 64000	20 dBc	250 / 500
57000 - 64000	99%	250 / 500

NOTE: Modulation envelope reference points provided in terms of attenuation below unmodulated carrier.

7.2.2 Test procedure

7.2.2.1 The EUT was set up as shown in Figure 7.2.1, energized and its proper operation was checked.

7.2.2.2 The EUT was set to transmit modulated carrier as provided in Table 7.2.2.

7.2.2.3 The transmitter occupied bandwidth was measured with spectrum analyzer as frequency delta between reference points on modulation envelope. The test results are provided in Table 7.2.2 and the associated plots.

Figure 7.2.1 Occupied bandwidth test setup

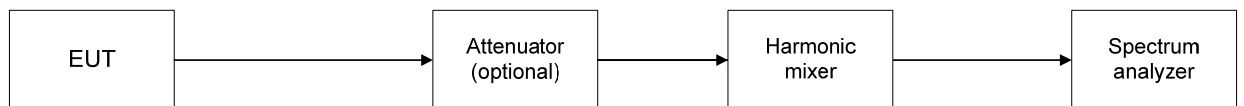



Test specification:		Section 15.215(c), RSS-Gen section 4.6.1 Occupied bandwidth	
Test procedure:		47 CFR, Section 2.1049	
Test mode:		Compliance	
Date:		8/19/2015	
Temperature: 23 °C		Air Pressure: 1008 hPa	
		Relative Humidity: 42%	
		Power Supply: 48 VDC	
Remarks:			

Table 7.2.2 Occupied bandwidth test results

OPERATING FREQUENCY RANGE: 57000 –64000 MHz
DETECTOR USED: Peak
RESOLUTION BANDWIDTH: 1% OBW

Frequency, MHz	Modulation	Occupied bandwidth 99%, MHz	Occupied bandwidth 20 dBc MHz	Verdict
EBW = 250 MHz				
57375	QPSK	235.73	245.8	Pass
60375		234.91	243.2	Pass
63375		235.21	243.5	Pass
EBW = 500 MHz				
57375	64QAM	461.60	479.4	Pass
60375		458.76	478.2	Pass
63375		460.79	479.7	Pass

Reference numbers of test equipment used

HL 1303	HL 2358	HL 2909	HL 3291	HL 3295	HL 3305	HL 3433	HL 3434
---------	---------	---------	---------	---------	---------	---------	---------

Full description is given in Appendix A.



HERMON LABORATORIES

Test specification:		Section 15.215(c), RSS-Gen section 4.6.1 Occupied bandwidth	
Test procedure:		47 CFR, Section 2.1049	
Test mode:		Compliance	
Date:		8/19/2015	
Temperature: 23 °C		Air Pressure: 1008 hPa	
Relative Humidity: 42%		Power Supply: 48 VDC	
Remarks:			
		Verdict: PASS	

Plot 7.2.1 Occupied bandwidth at low frequency

MODULATION:	QPSK
EMISSION BANDWIDTH:	250 MHz

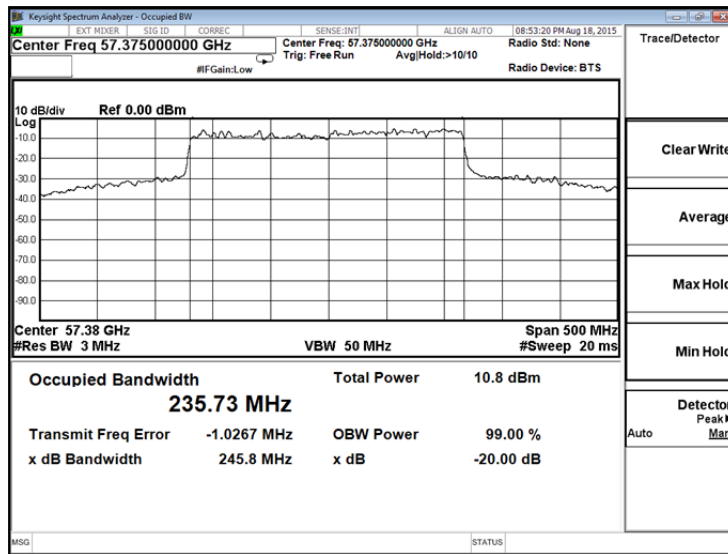

Plot 7.2.2 Occupied bandwidth at the mid frequency

MODULATION:	QPSK
EMISSION BANDWIDTH:	250 MHz

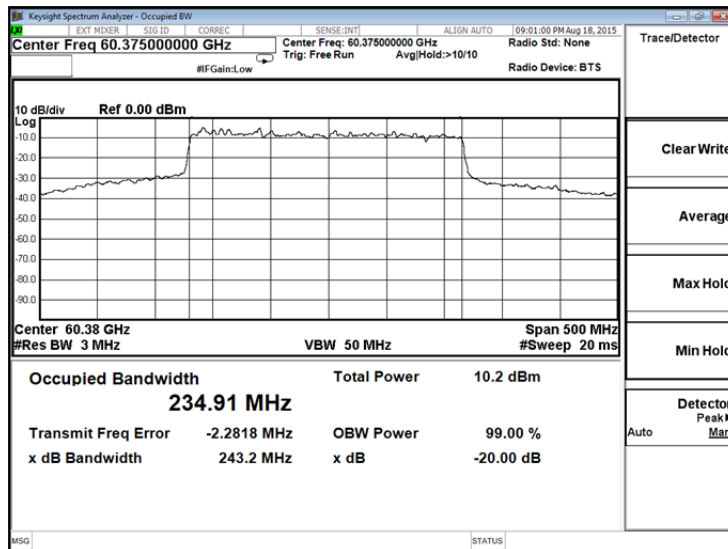



HERMON LABORATORIES

Test specification:		Section 15.215(c), RSS-Gen section 4.6.1 Occupied bandwidth	
Test procedure:		47 CFR, Section 2.1049	
Test mode:		Compliance	
Date:		8/19/2015	
Temperature: 23 °C		Air Pressure: 1008 hPa	
Relative Humidity: 42%		Power Supply: 48 VDC	
Remarks:			

Plot 7.2.3 Occupied bandwidth at the high frequency

MODULATION:	QPSK
EMISSION BANDWIDTH:	250 MHz

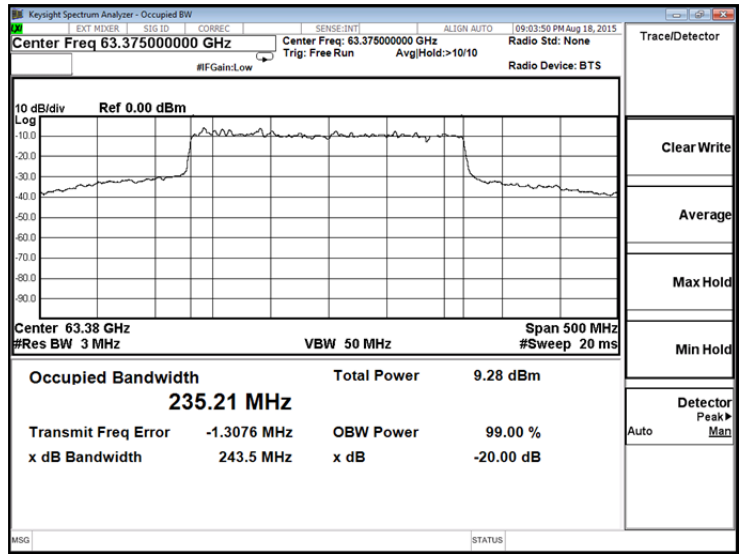

Plot 7.2.4 Occupied bandwidth at the low frequency

MODULATION:	64QAM
EMISSION BANDWIDTH:	500 MHz

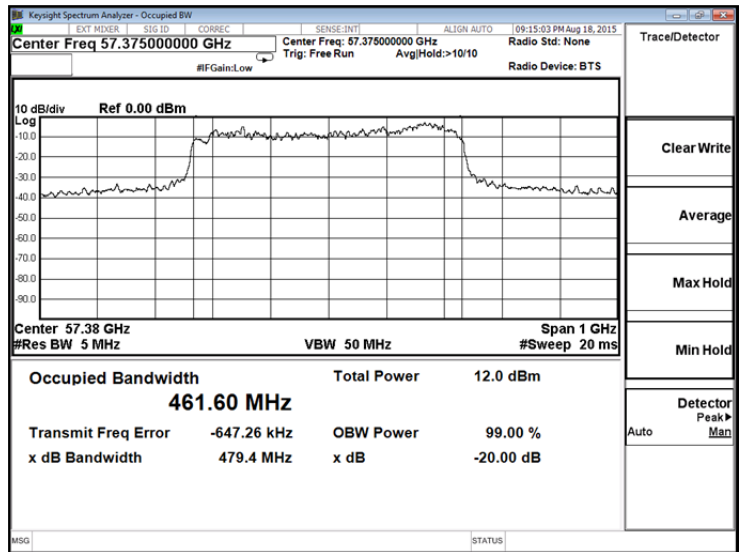



HERMON LABORATORIES

Test specification:		Section 15.215(c), RSS-Gen section 4.6.1 Occupied bandwidth	
Test procedure:		47 CFR, Section 2.1049	
Test mode:		Compliance	Verdict: PASS
Date:		8/19/2015	
Temperature: 23 °C	Air Pressure: 1008 hPa	Relative Humidity: 42%	Power Supply: 48 VDC
Remarks:			

Plot 7.2.5 Occupied bandwidth at the mid frequency

MODULATION:	64QAM
EMISSION BANDWIDTH:	500 MHz

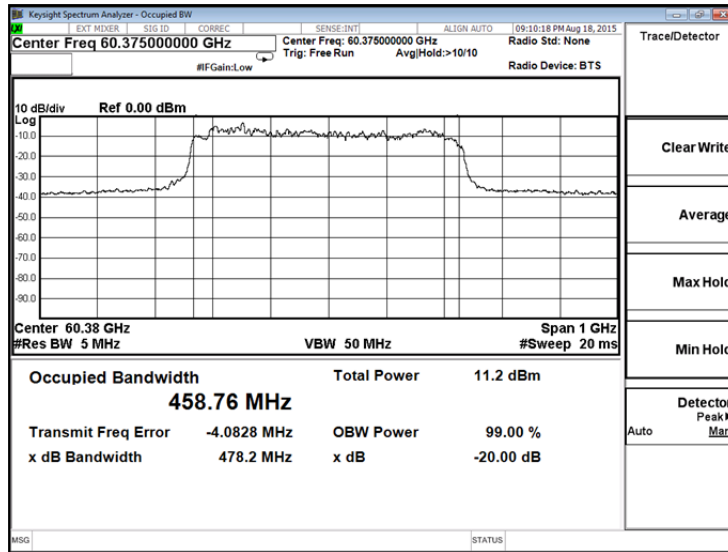

Plot 7.2.6 Occupied bandwidth at the high frequency

MODULATION:	64QAM
EMISSION BANDWIDTH:	500 MHz

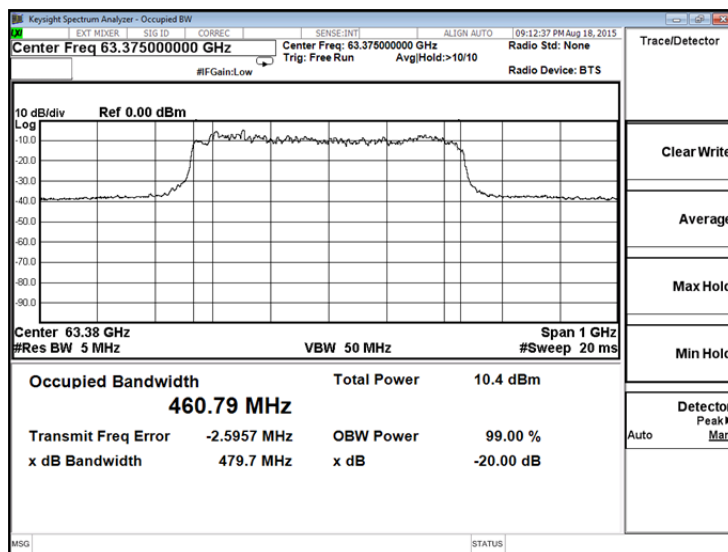



Test specification:	Section 15.255(c), RSS-210 section A13.2.2, Conducted spurious emissions		
Test procedure:	47 CFR, Section 2.1051; FCC Millimeter wave test procedures		
Test mode:	Compliance	Verdict:	PASS
Date:	8/19/2015-8/30/2015		
Temperature: 24°C	Air Pressure: 1008 hPa	Relative Humidity: 46%	Power Supply: 48 VDC
Remarks:			

7.3 Spurious emissions at RF antenna connector test

7.3.1 General

This test was performed to measure spurious emissions at RF antenna connector. Specification test limits are given in Table 7.3.1.

Table 7.3.1 Spurious emission limits

Frequency	Spurious emission level	
	pW/cm ²	Power of spurious, dBm
40 GHz – 200 GHz	90	-9.92
9 kHz –40 GHz	According to FCC section 15.209/RSS=Gen	

NOTE 1: Spurious emission limits do not apply to in band emission within ± 250 % of the authorized bandwidth from the carrier.

7.3.2 Test procedure

7.3.2.1 The EUT was set up as shown in Figure 7.3.1, energized and its proper operation was checked.

7.3.2.2 The EUT was adjusted to produce maximum available for end user RF output power.

7.3.2.3 The spurious emission was measured with spectrum analyzer as provided in Table 7.3.2 and the associated plots.

Figure 7.3.1 Spurious emission test setup

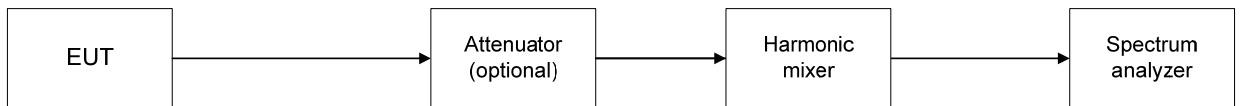



Test specification:		Section 15.255(c), RSS-210 section A13.2.2, Conducted spurious emissions	
Test procedure:		47 CFR, Section 2.1051; FCC Millimeter wave test procedures	
Test mode:		Verdict: PASS	
Date:		8/19/2015-8/30/2015	
Temperature: 24°C	Air Pressure: 1008 hPa	Relative Humidity: 46%	Power Supply: 48 VDC
Remarks:			

Table 7.3.2 Spurious emission test results

OPERATING FREQUENCY RANGE: 57000 – 64000 MHz
 INVESTIGATED FREQUENCY RANGE: 30000* - 200000 MHz
 DETECTOR USED: Peak
 RESOLUTION BANDWIDTH: 1 MHz
 VIDEO BANDWIDTH: 3 MHz
 MODULATION: QPSK
 EMISSION BANDWIDTH: 250 MHz
 TRANSMITTER OUTPUT POWER SETTINGS: Maximum

Carrier frequency, MHz	Spurious frequency, MHz	Spurious emission, dBm	Spurious attenuation, dBc	Spurious emission limit, dBm	Spurious attenuation limit, dBc	Margin, dB	Verdict
Low frequency 57375 MHz							
No emissions were found							Pass
Mid frequency 60375 MHz							
No emissions were found							Pass
High frequency 63375 MHz							
No emissions were found							Pass

* - The EUT uses a waveguide antenna connector of WR15 type.

Reference numbers of test equipment used

HL 0747	HL 0748	HL 1295	HL 1299	HL 1300	HL 1303	HL 1304
HL 1306	HL 1312	HL 1424	HL 2909	HL 3235	HL 3290	HL 3291
HL 3294	HL 3297	HL 3305	HL 3433	HL 3434	HL 3455	HL 3901
HL 4023						

Full description is given in Appendix A.



HERMON LABORATORIES

Test specification:		Section 15.255(c), RSS-210 section A13.2.2, Conducted spurious emissions	
Test procedure:		47 CFR, Section 2.1051; FCC Millimeter wave test procedures	
Test mode:		Verdict:	
Compliance		PASS	
Date:		8/19/2015-8/30/2015	
Temperature: 24°C	Air Pressure: 1008 hPa	Relative Humidity: 46%	Power Supply: 48 VDC
Remarks:			

Plot 7.3.1 Spurious emission test results frequency from 30 to 40 GHz

DETECTOR:
LIMIT:

Peak
Average*

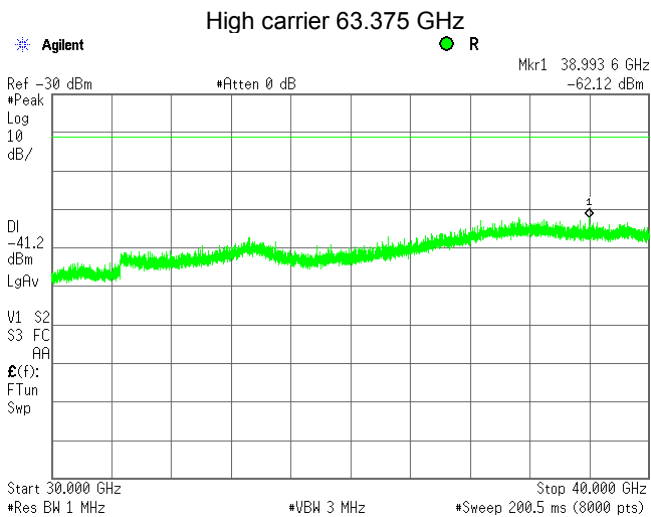
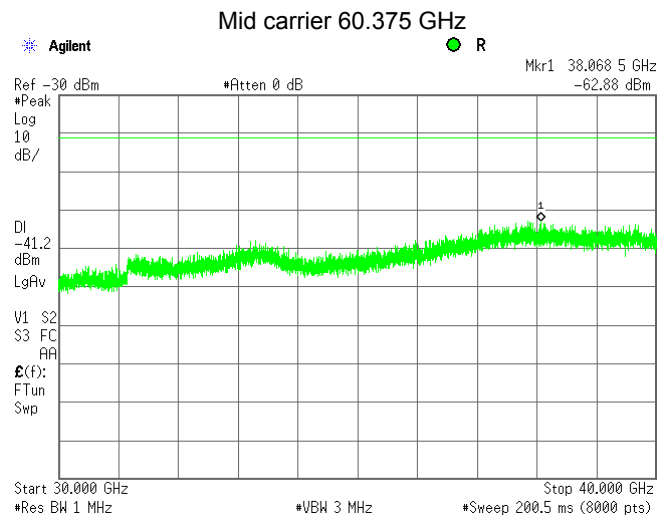
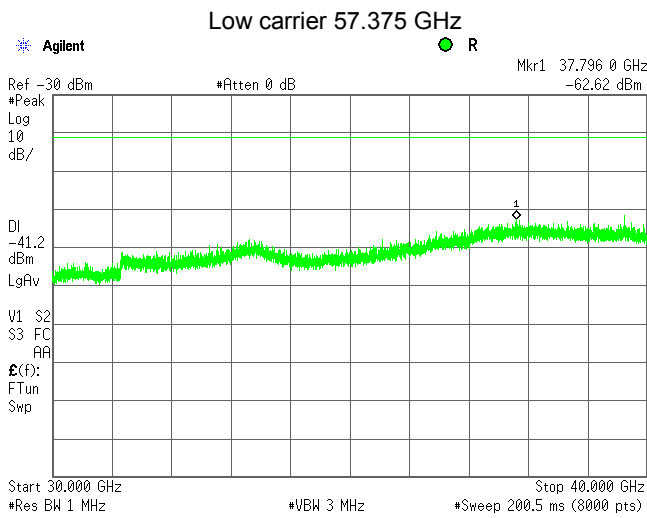

* Limit calculated as follows: 54 dBµV/m – 95.2 dB = -41.2 dBm



HERMON LABORATORIES

Test specification:		Section 15.255(c), RSS-210 section A13.2.2, Conducted spurious emissions	
Test procedure:		47 CFR, Section 2.1051; FCC Millimeter wave test procedures	
Test mode:		Verdict:	
Compliance		PASS	
Date:		8/19/2015-8/30/2015	
Temperature: 24°C	Air Pressure: 1008 hPa	Relative Humidity: 46%	Power Supply: 48 VDC
Remarks:			

Plot 7.3.2 Spurious emission measurements in 40 – 50 GHz range

DETECTOR:

Peak

Low carrier 57.375 GHz

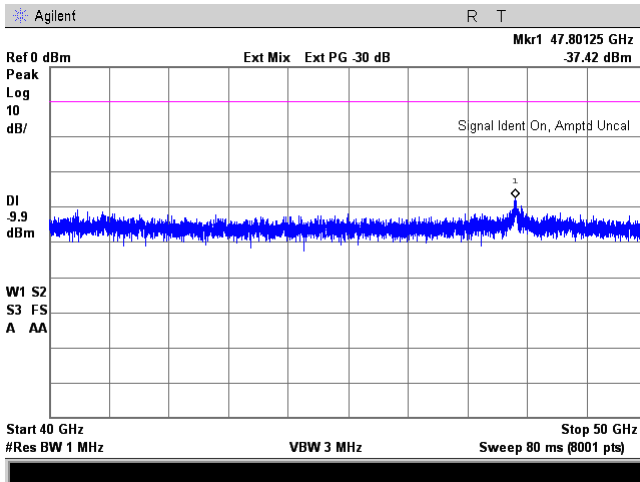

Mid carrier 60.375 GHz

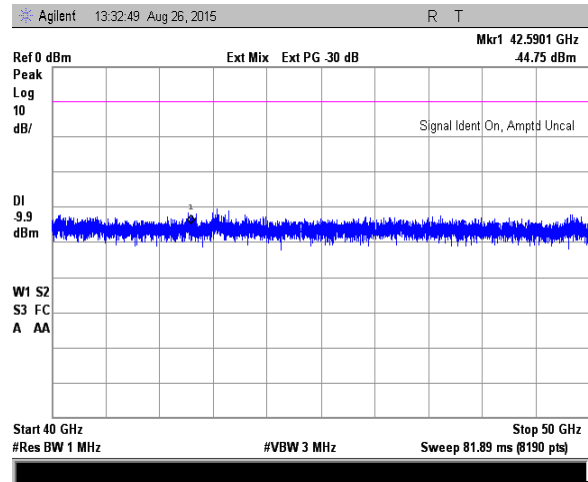

High carrier 63.375 GHz

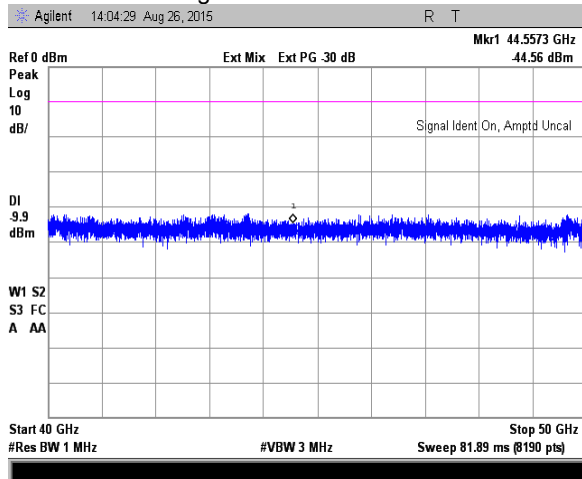



HERMON LABORATORIES

Test specification:		Section 15.255(c), RSS-210 section A13.2.2, Conducted spurious emissions	
Test procedure:		47 CFR, Section 2.1051; FCC Millimeter wave test procedures	
Test mode:		Verdict:	
Compliance		PASS	
Date:		8/19/2015-8/30/2015	
Temperature: 24°C	Air Pressure: 1008 hPa	Relative Humidity: 46%	Power Supply: 48 VDC
Remarks:			

Plot 7.3.3 Spurious emission measurements in 50 – 57 GHz range

DETECTOR:

Peak

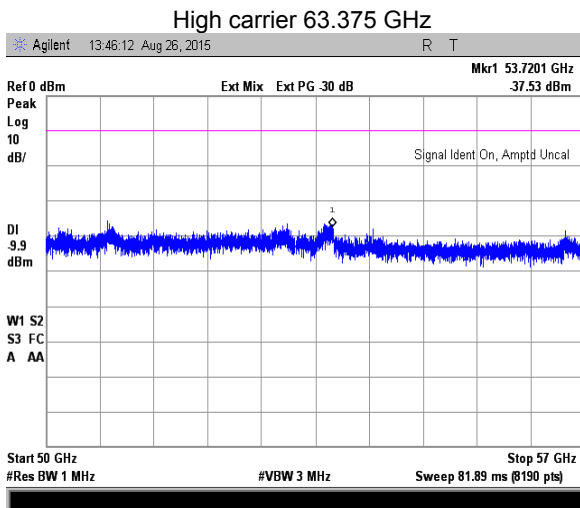
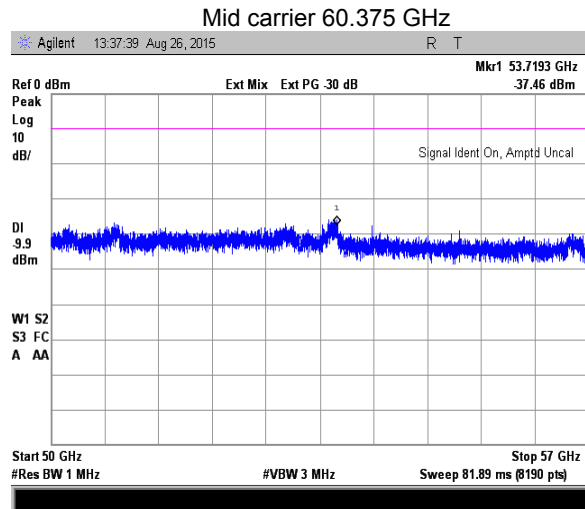
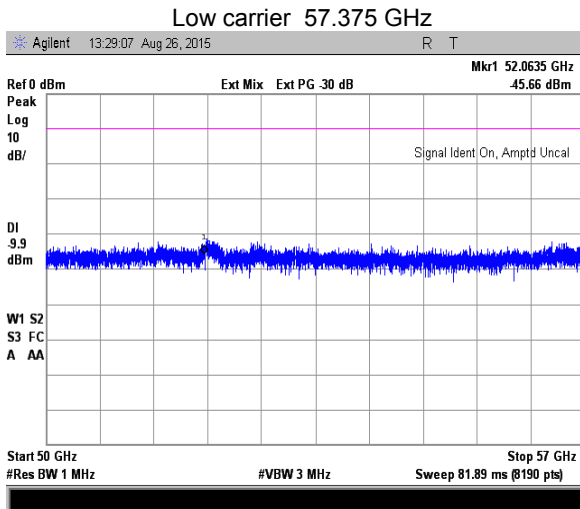



HERMON LABORATORIES

Test specification:		Section 15.255(c), RSS-210 section A13.2.2, Conducted spurious emissions	
Test procedure:		47 CFR, Section 2.1051; FCC Millimeter wave test procedures	
Test mode:		Verdict:	
Compliance		PASS	
Date:		8/19/2015-8/30/2015	
Temperature: 24°C	Air Pressure: 1008 hPa	Relative Humidity: 46%	Power Supply: 48 VDC
Remarks:			

Plot 7.3.4 Spurious emission measurements in 64 – 75 GHz range

DETECTOR:

Peak

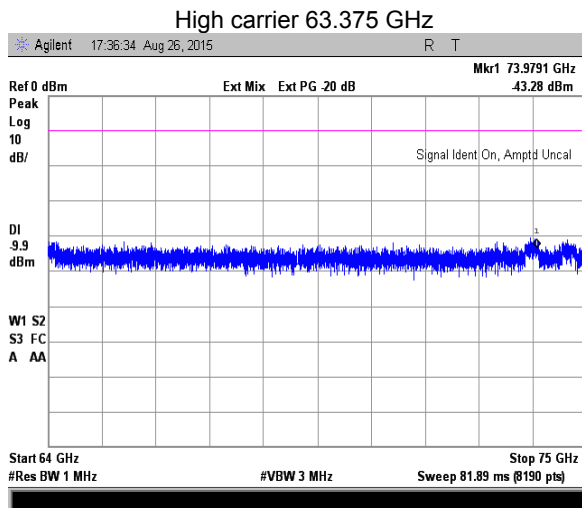
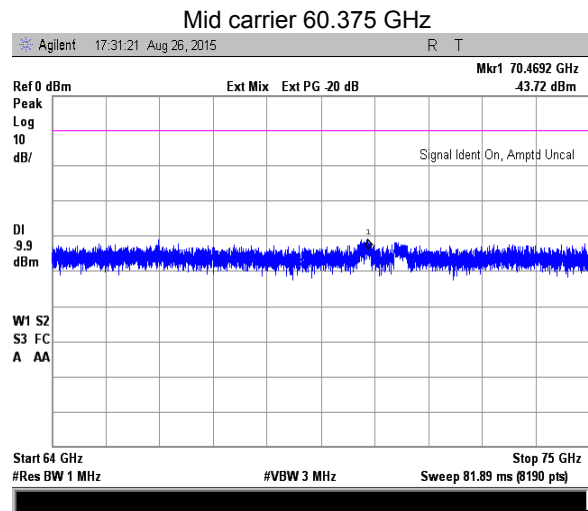
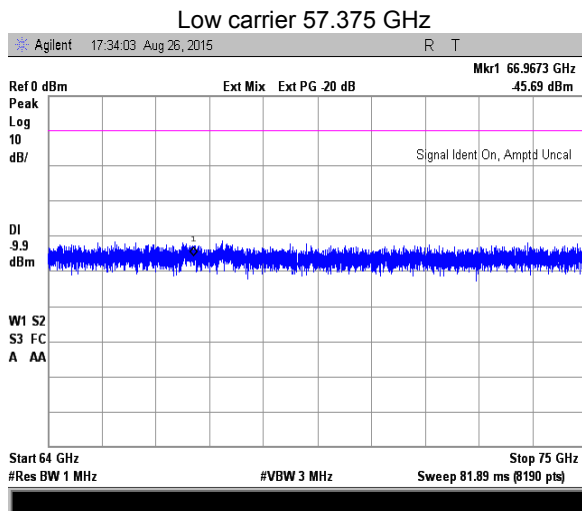



HERMON LABORATORIES

Test specification:		Section 15.255(c), RSS-210 section A13.2.2, Conducted spurious emissions	
Test procedure:		47 CFR, Section 2.1051; FCC Millimeter wave test procedures	
Test mode:		Verdict:	
Compliance		PASS	
Date:		8/19/2015-8/30/2015	
Temperature: 24°C	Air Pressure: 1008 hPa	Relative Humidity: 46%	Power Supply: 48 VDC
Remarks:			

Plot 7.3.5 Spurious emission test results at low carrier frequency from 75 to 83 GHz

DETECTOR:

Peak

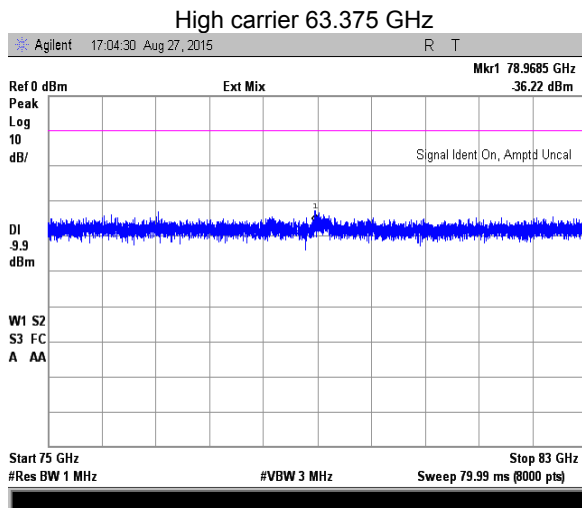
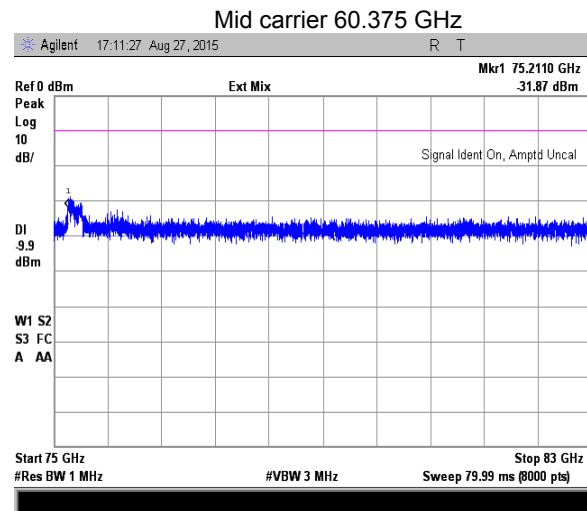
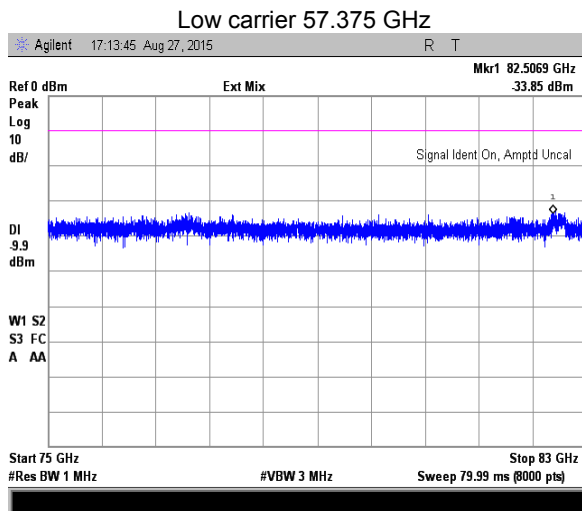



HERMON LABORATORIES

Test specification:		Section 15.255(c), RSS-210 section A13.2.2, Conducted spurious emissions	
Test procedure:		47 CFR, Section 2.1051; FCC Millimeter wave test procedures	
Test mode:		Verdict:	
Compliance		PASS	
Date:		8/19/2015-8/30/2015	
Temperature: 24°C	Air Pressure: 1008 hPa	Relative Humidity: 46%	Power Supply: 48 VDC
Remarks:			

Plot 7.3.6 Spurious emission test results at low carrier frequency from 83 to 90 GHz

DETECTOR:

Peak

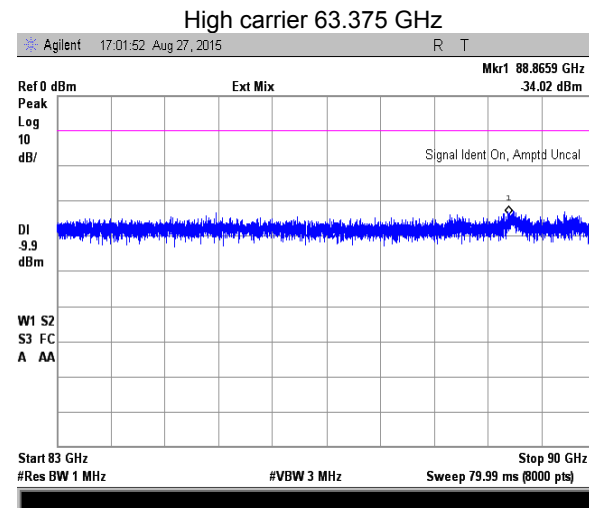
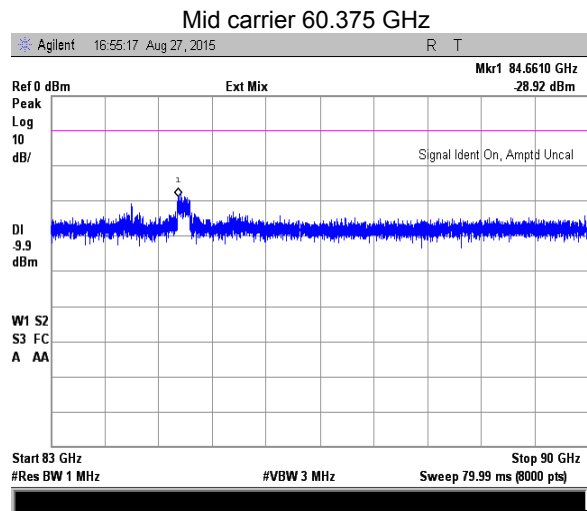
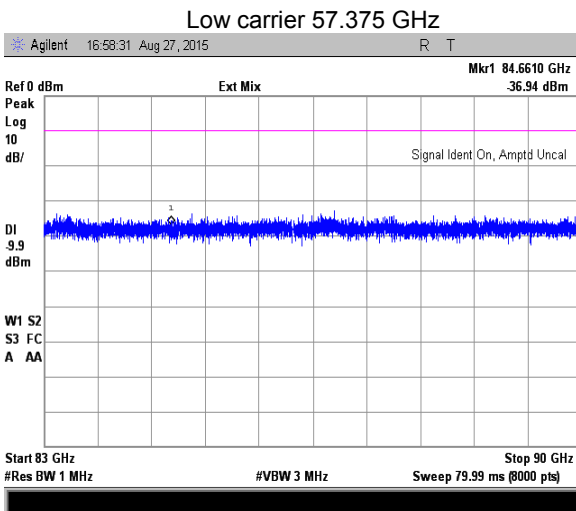



HERMON LABORATORIES

Test specification:		Section 15.255(c), RSS-210 section A13.2.2, Conducted spurious emissions	
Test procedure:		47 CFR, Section 2.1051; FCC Millimeter wave test procedures	
Test mode:		Verdict:	
Compliance		PASS	
Date:		8/19/2015-8/30/2015	
Temperature: 24°C	Air Pressure: 1008 hPa	Relative Humidity: 46%	Power Supply: 48 VDC
Remarks:			

Plot 7.3.7 Spurious emission test results at low carrier frequency from 90 to 100 GHz

DETECTOR:

Low carrier 57.375 GHz

Peak

Mid carrier 60.375 GHz

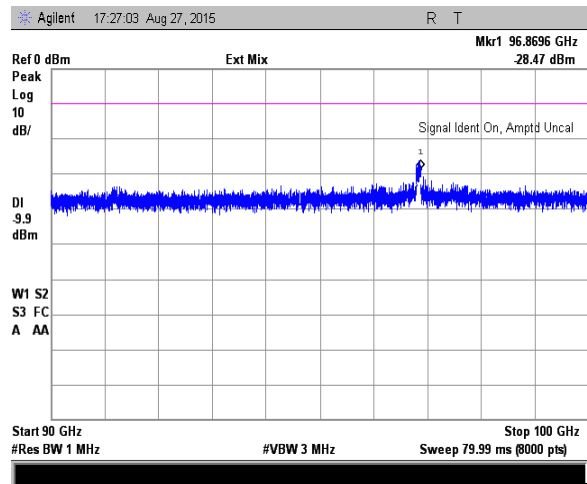
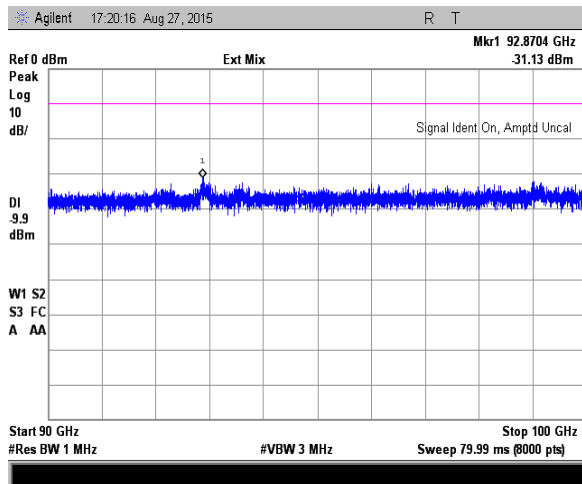

High carrier 63.375 GHz

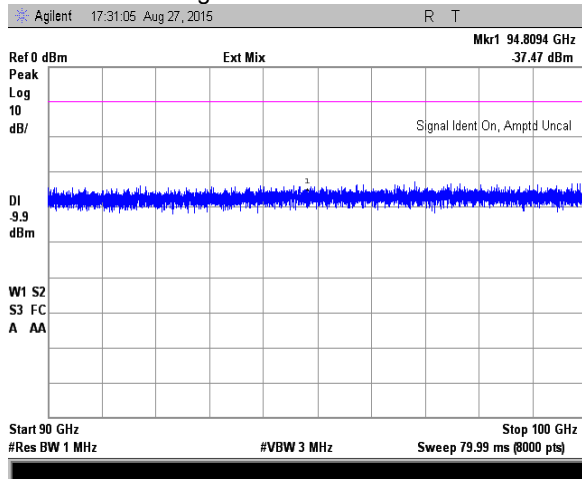



HERMON LABORATORIES

Test specification:		Section 15.255(c), RSS-210 section A13.2.2, Conducted spurious emissions	
Test procedure:		47 CFR, Section 2.1051; FCC Millimeter wave test procedures	
Test mode:		Verdict: PASS	
Date:		8/19/2015-8/30/2015	
Temperature: 24°C	Air Pressure: 1008 hPa	Relative Humidity: 46%	Power Supply: 48 VDC
Remarks:			

Plot 7.3.8 Spurious emission test results at low carrier frequency from 100 to 110 GHz

DETECTOR:

Peak

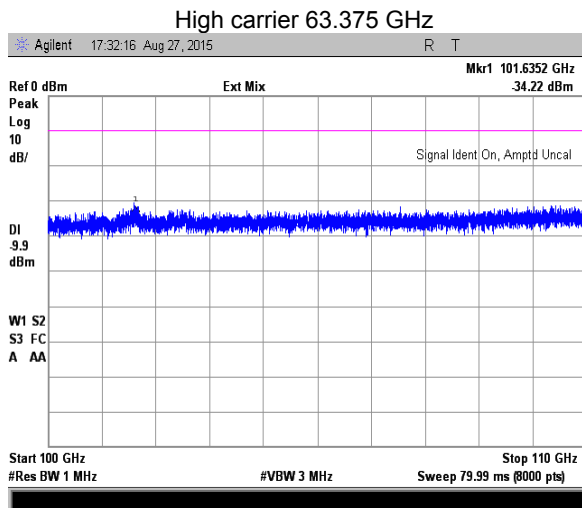
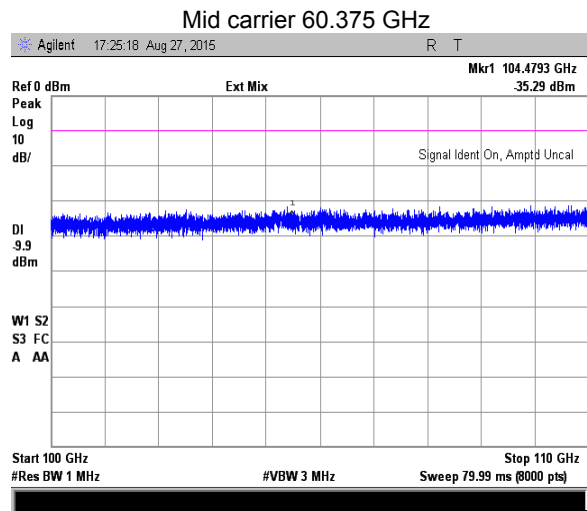
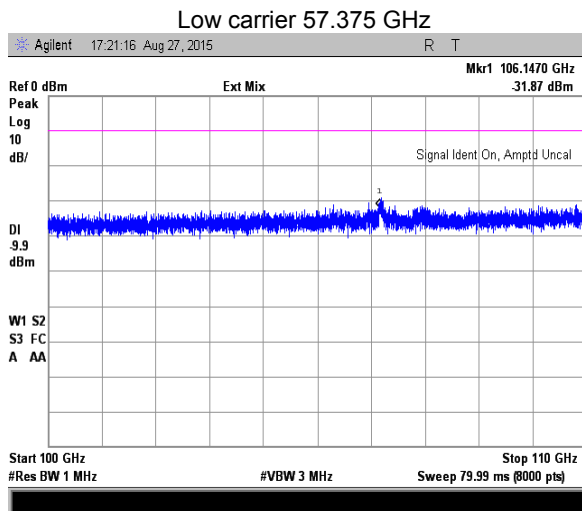



HERMON LABORATORIES

Test specification:		Section 15.255(c), RSS-210 section A13.2.2, Conducted spurious emissions	
Test procedure:		47 CFR, Section 2.1051; FCC Millimeter wave test procedures	
Test mode:		Verdict:	
Compliance		PASS	
Date:		8/19/2015-8/30/2015	
Temperature: 24°C	Air Pressure: 1008 hPa	Relative Humidity: 46%	Power Supply: 48 VDC
Remarks:			

Plot 7.3.9 Spurious emission test results at low carrier frequency from 110 to 120 GHz

DETECTOR:

Peak

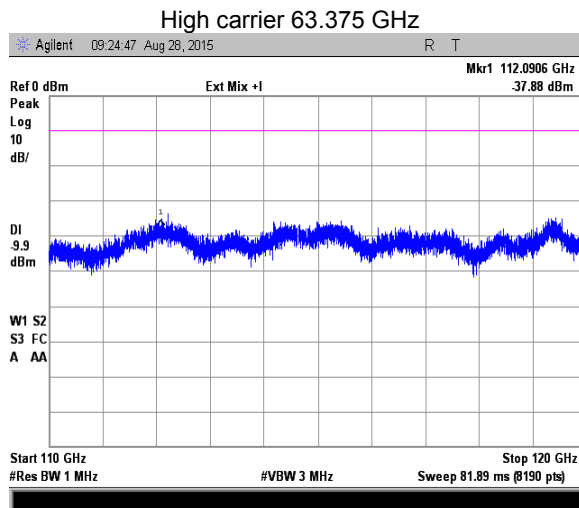
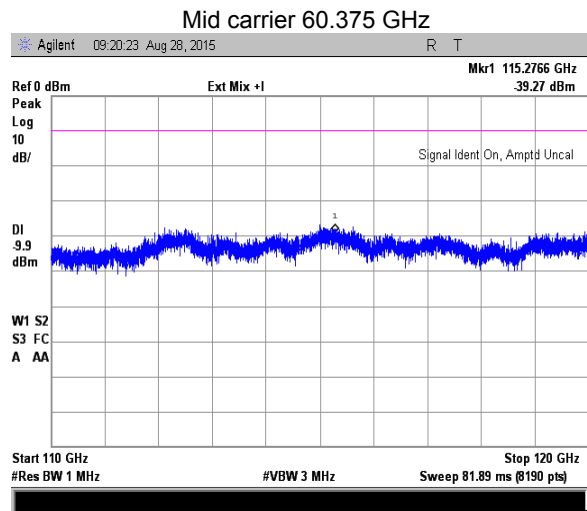
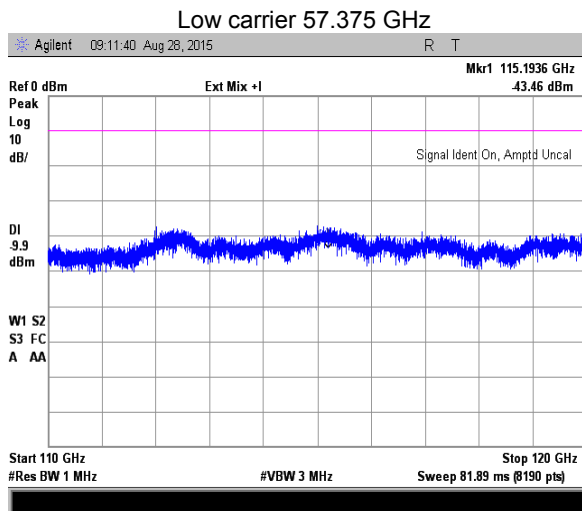



HERMON LABORATORIES

Test specification:		Section 15.255(c), RSS-210 section A13.2.2, Conducted spurious emissions	
Test procedure:		47 CFR, Section 2.1051; FCC Millimeter wave test procedures	
Test mode:		Verdict: PASS	
Date:		8/19/2015-8/30/2015	
Temperature: 24°C	Air Pressure: 1008 hPa	Relative Humidity: 46%	Power Supply: 48 VDC
Remarks:			

Plot 7.3.10 Spurious emission test results at low carrier frequency from 120 to 130 GHz

DETECTOR:

Peak

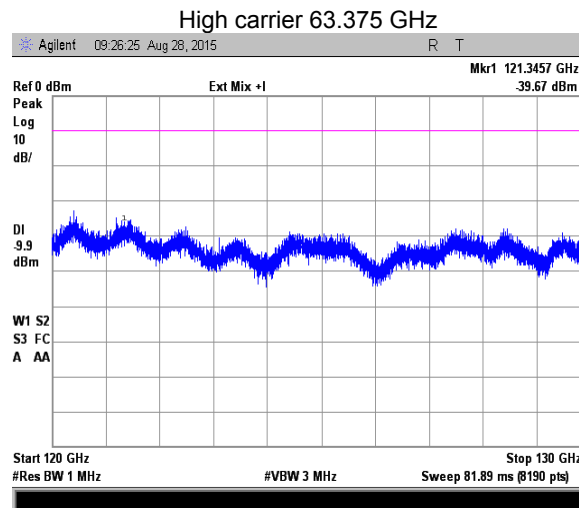
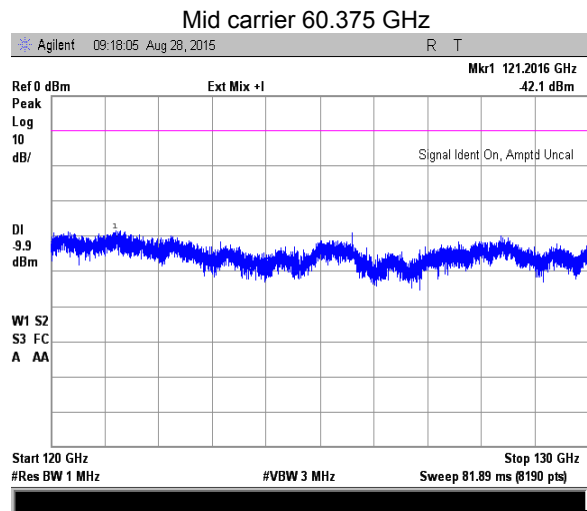
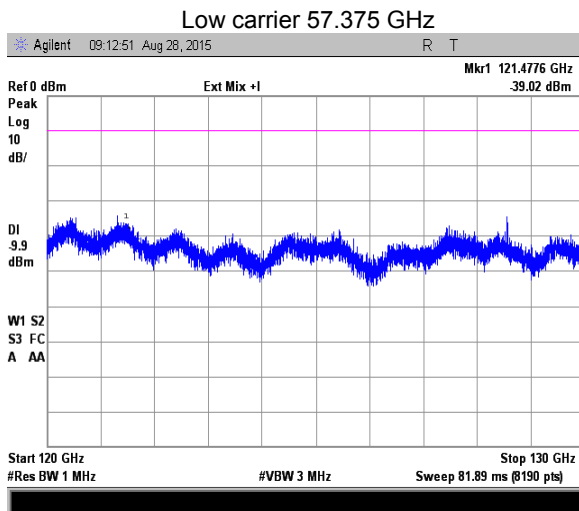



HERMON LABORATORIES

Test specification:	Section 15.255(c), RSS-210 section A13.2.2, Conducted spurious emissions		
Test procedure:	47 CFR, Section 2.1051; FCC Millimeter wave test procedures		
Test mode:	Compliance	Verdict:	PASS
Date:	8/19/2015-8/30/2015		
Temperature: 24°C	Air Pressure: 1008 hPa	Relative Humidity: 46%	Power Supply: 48 VDC
Remarks:			

Plot 7.3.11 Spurious emission test results at low carrier frequency from 130 to 140 GHz

DETECTOR:

Peak

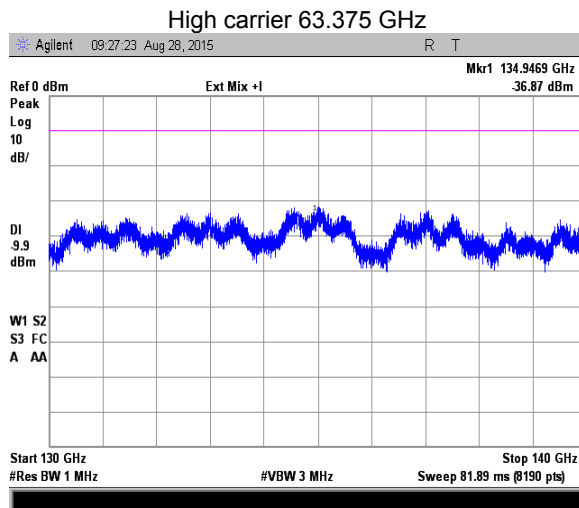
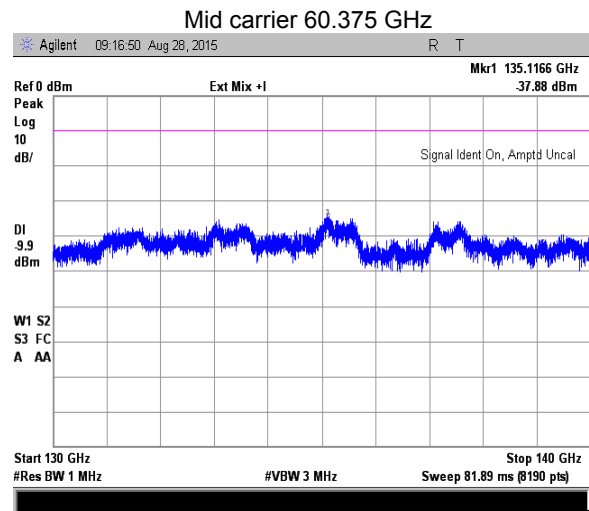
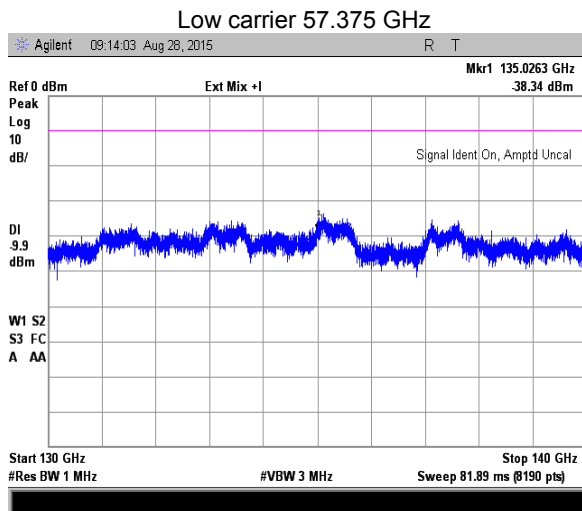



Test specification:		Section 15.255(c), RSS-210 section A13.2.2, Conducted spurious emissions	
Test procedure:		47 CFR, Section 2.1051; FCC Millimeter wave test procedures	
Test mode:		Verdict: PASS	
Date:		8/19/2015-8/30/2015	
Temperature: 24°C	Air Pressure: 1008 hPa	Relative Humidity: 46%	Power Supply: 48 VDC
Remarks:			

Plot 7.3.12 Spurious emission test results at low carrier frequency from 140 to 150 GHz

DETECTOR:

Peak

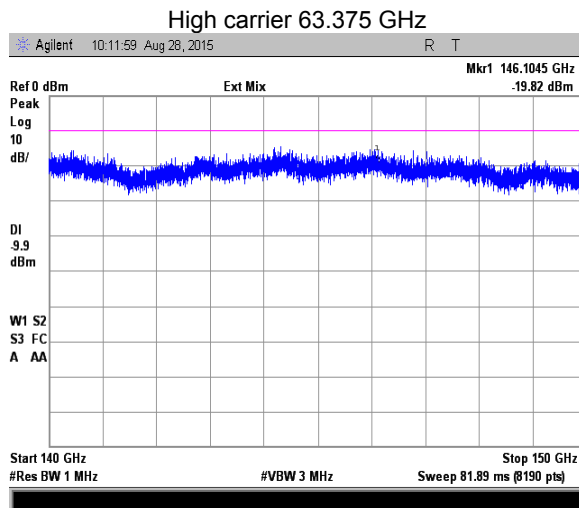
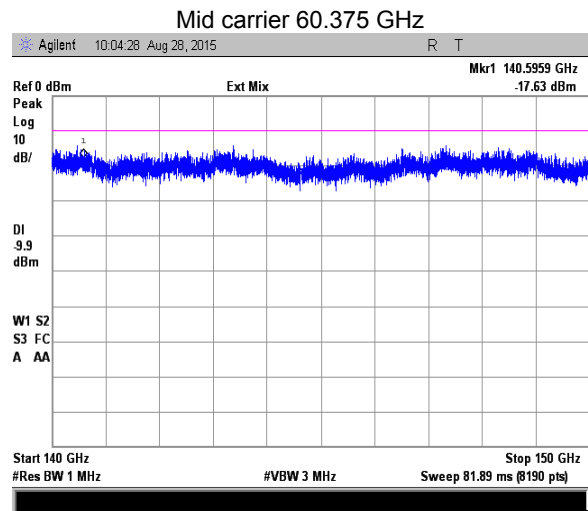
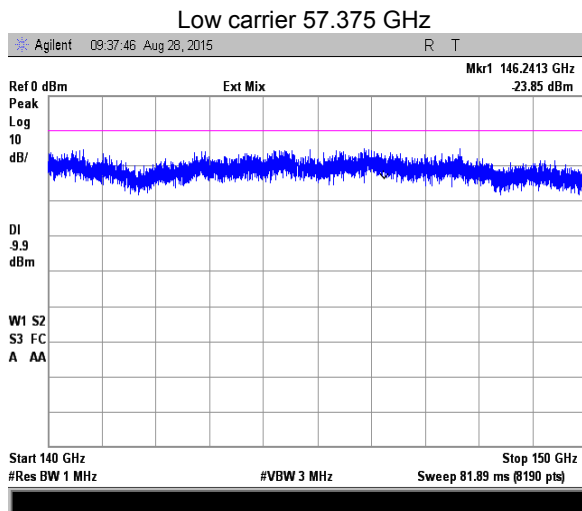



HERMON LABORATORIES

Test specification:		Section 15.255(c), RSS-210 section A13.2.2, Conducted spurious emissions	
Test procedure:		47 CFR, Section 2.1051; FCC Millimeter wave test procedures	
Test mode:		Verdict: PASS	
Date:		8/19/2015-8/30/2015	
Temperature: 24°C	Air Pressure: 1008 hPa	Relative Humidity: 46%	Power Supply: 48 VDC
Remarks:			

Plot 7.3.13 Spurious emission test results at low carrier frequency from 150 to 160 GHz

DETECTOR:

Peak

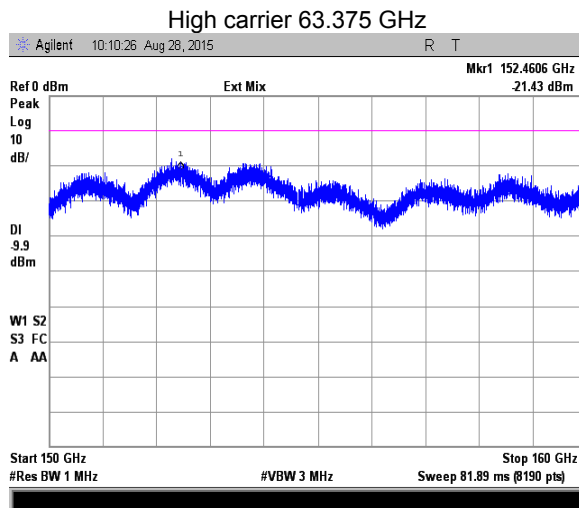
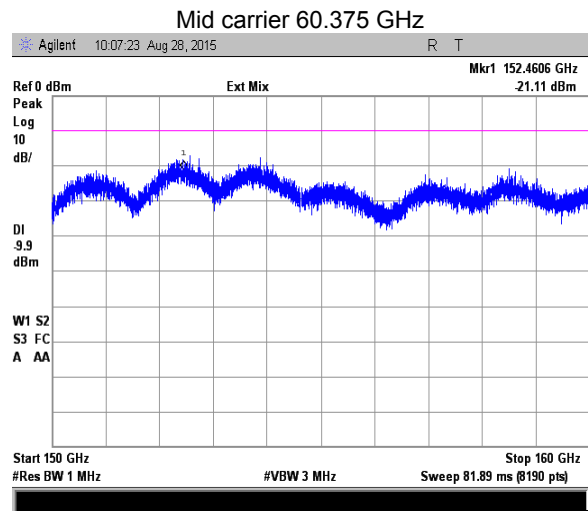
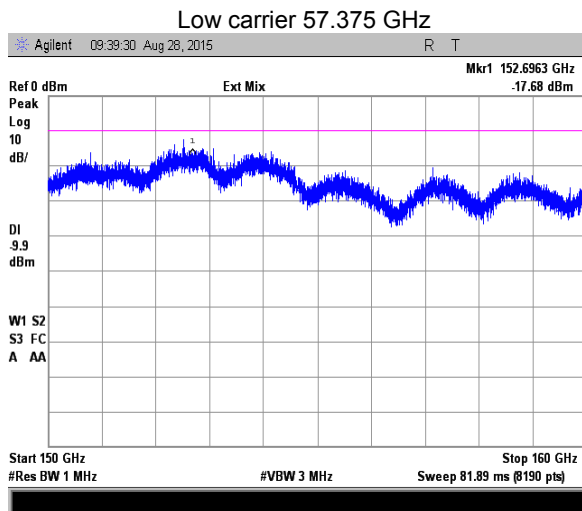



HERMON LABORATORIES

Test specification:		Section 15.255(c), RSS-210 section A13.2.2, Conducted spurious emissions	
Test procedure:		47 CFR, Section 2.1051; FCC Millimeter wave test procedures	
Test mode:		Verdict:	
Compliance		PASS	
Date:		8/19/2015-8/30/2015	
Temperature: 24°C	Air Pressure: 1008 hPa	Relative Humidity: 46%	Power Supply: 48 VDC
Remarks:			

Plot 7.3.14 Spurious emission test results at low carrier frequency from 160 to 170 GHz

DETECTOR:

Peak

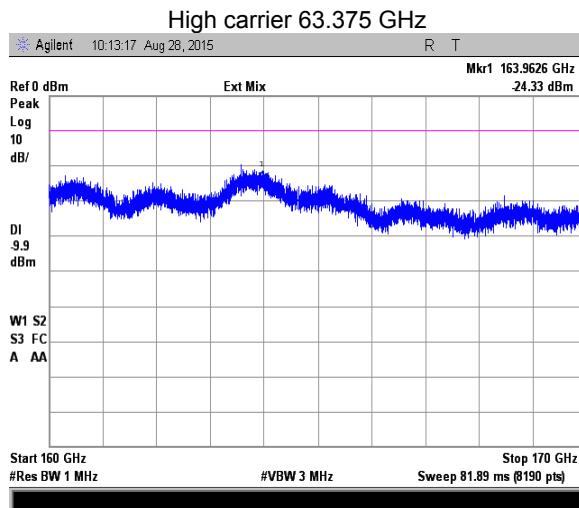
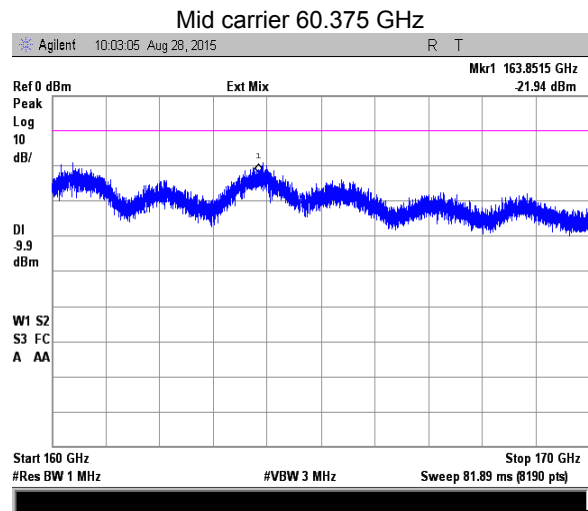
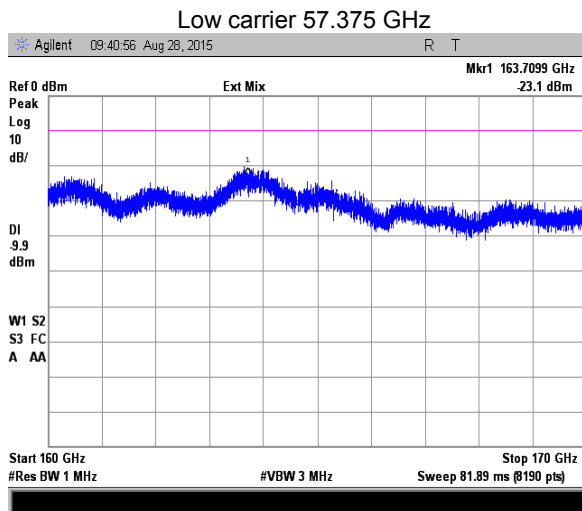



HERMON LABORATORIES

Test specification:		Section 15.255(c), RSS-210 section A13.2.2, Conducted spurious emissions	
Test procedure:		47 CFR, Section 2.1051; FCC Millimeter wave test procedures	
Test mode:		Verdict:	
Compliance		PASS	
Date:		8/19/2015-8/30/2015	
Temperature: 24°C	Air Pressure: 1008 hPa	Relative Humidity: 46%	Power Supply: 48 VDC
Remarks:			

Plot 7.3.15 Spurious emission test results at low carrier frequency from 170 to 180 GHz GHz

DETECTOR:

Peak

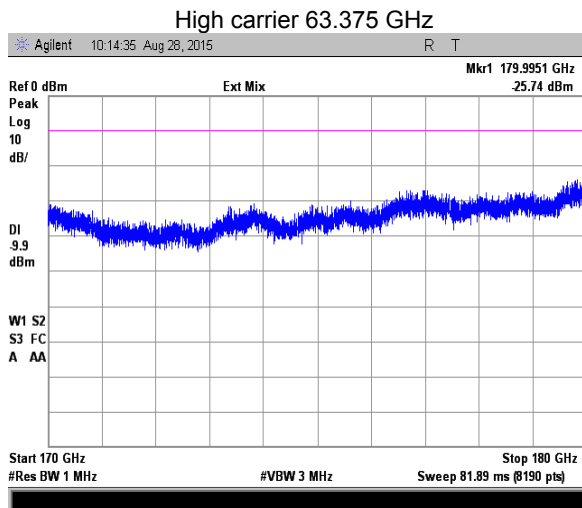
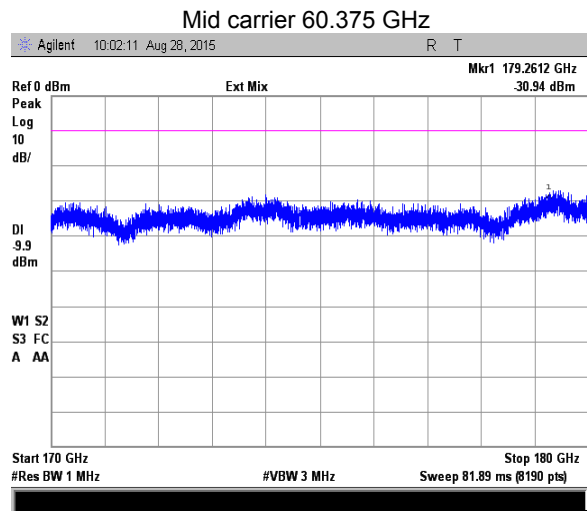
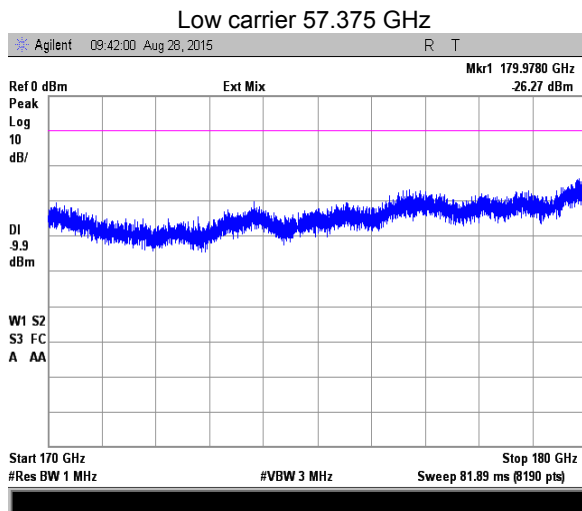



HERMON LABORATORIES

Test specification:		Section 15.255(c), RSS-210 section A13.2.2, Conducted spurious emissions	
Test procedure:		47 CFR, Section 2.1051; FCC Millimeter wave test procedures	
Test mode:		Verdict: PASS	
Date:		8/19/2015-8/30/2015	
Temperature: 24°C	Air Pressure: 1008 hPa	Relative Humidity: 46%	Power Supply: 48 VDC
Remarks:			

Plot 7.3.16 Spurious emission test results at low carrier frequency from 180 to 190 GHz GHz

DETECTOR:

Peak

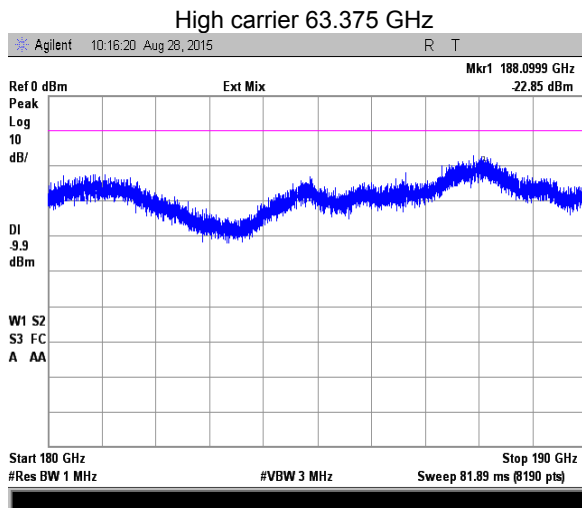
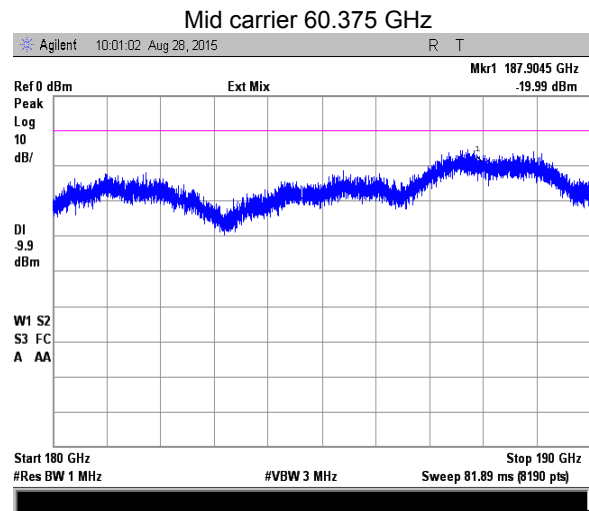
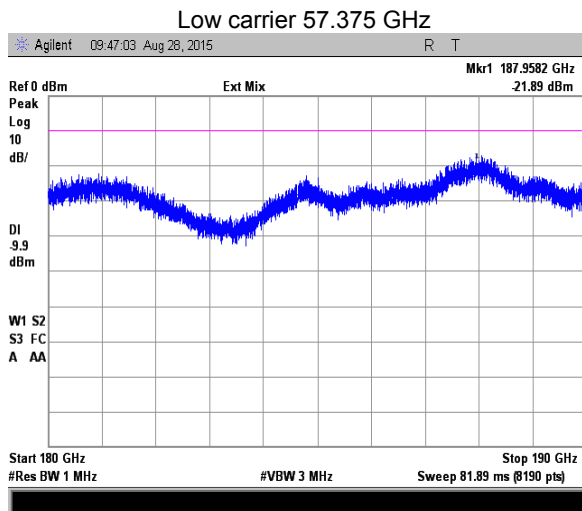



HERMON LABORATORIES

Test specification:		Section 15.255(c), RSS-210 section A13.2.2, Conducted spurious emissions	
Test procedure:		47 CFR, Section 2.1051; FCC Millimeter wave test procedures	
Test mode:		Verdict: PASS	
Date:		8/19/2015-8/30/2015	
Temperature: 24°C	Air Pressure: 1008 hPa	Relative Humidity: 46%	Power Supply: 48 VDC
Remarks:			

Plot 7.3.17 Spurious emission test results at low carrier frequency from 190 to 200 GHz GHz

DETECTOR:

Peak

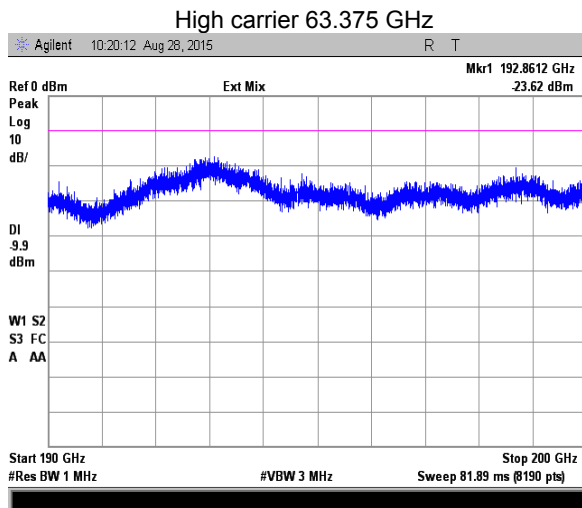
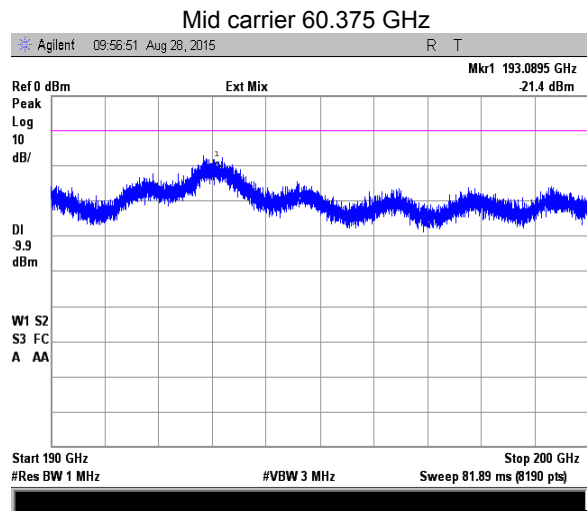
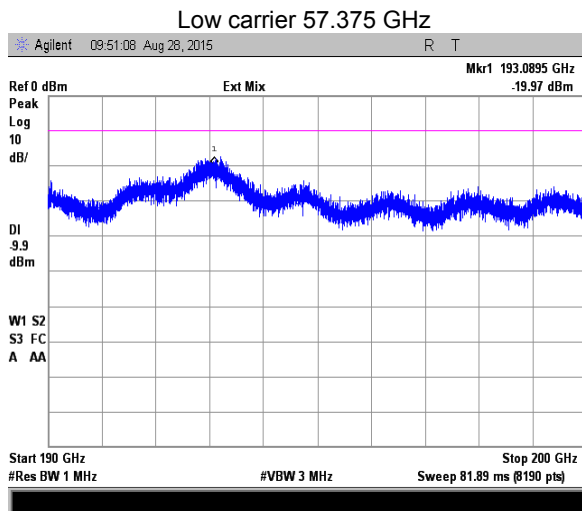



Test specification:		Section 15.255(c)(2), RSS-210 section A13.2.2, Out of band radiated emissions below 40 GHz	
Test procedure:		47 CFR, Section 2.1053; ANSI C63.4, Sections 8.3.2, 13.2, 13.4	
Test mode:		Compliance	
Date:		8/19/2015-8/30/2015	
Temperature: 24.8°C		Air Pressure: 1012 hPa	
Remarks:		Verdict: PASS	
		Relative Humidity: 51%	
		Power Supply: 48 VDC	

7.4 Out of band radiated emissions below 40 GHz

7.4.1 General

This test was performed to measure field strength of spurious emissions from the EUT. Specification test limits are given in Table 7.4.1.

Table 7.4.1 Radiated emission limits

Frequency, MHz	Field strength at 3 m within restricted bands, dB(μV/m)***		
	Peak	Quasi Peak	Average
0.009 – 0.090	148.5 – 128.5	NA	128.5 – 108.5**
0.090 – 0.110	NA	108.5 – 106.8**	NA
0.110 – 0.490	126.8 – 113.8	NA	106.8 – 93.8**
0.490 – 1.705	NA	73.8 – 63.0**	NA
1.705 – 30.0*		69.5**	
30 – 88		40.0	
88 – 216		43.5	
216 – 960		46.0	
960 - 40000	74.0	NA	54.0

*- The above field strength limits applied from the lowest radio frequency generated in the device, without going below 9 kHz up to the tenth harmonic of the highest fundamental frequency.

** - The limit for 3 m test distance was calculated using the inverse square distance extrapolation factor as follows:

$$\text{Lim}_{S_2} = \text{Lim}_{S_1} + 40 \log (S_1/S_2),$$

where S₁ and S₂ – standard defined and test distance respectively in meters.

*** - The limit decreases linearly with the logarithm of frequency.

7.4.2 Test procedure for spurious emission field strength measurements in 9 kHz to 30 MHz band

7.4.2.1 The EUT was set up as shown in Figure 7.4.1, energized and the performance check was conducted.

7.4.2.2 The specified frequency range was investigated with loop antenna connected to spectrum analyzer/ EMI receiver. To find maximum radiation the turntable was rotated 360°, the measuring antenna was rotated around its vertical axis and the measuring antenna polarization was switched from vertical to horizontal.

7.4.2.3 The worst test results (the lowest margins) were recorded in Table 7.4.2 and shown in the associated plots.

7.4.3 Test procedure for spurious emission field strength measurements above 30 MHz

7.4.3.1 The EUT was set up as shown in Figure 7.5.2, energized and the performance check was conducted.

7.4.3.2 The specified frequency range was investigated with antenna connected to spectrum analyzer/ EMI receiver. To find maximum radiation the turntable was rotated 360°, the measuring antenna height was changed from 1 to 4 m, its polarization was switched from vertical to horizontal.

7.4.3.3 The worst test results (the lowest margins) were recorded in Table 7.4.2, Table 7.4.3 and shown in the associated plots.



Test specification:		Section 15.255(c)(2), RSS-210 section A13.2.2, Out of band radiated emissions below 40 GHz	
Test procedure:		47 CFR, Section 2.1053; ANSI C63.4, Sections 8.3.2, 13.2, 13.4	
Test mode:		Verdict: PASS	
Date:			
Temperature: 24.8°C	Air Pressure: 1012 hPa	Relative Humidity: 51%	Power Supply: 48 VDC
Remarks:			

Figure 7.4.1 Radiated emissions below 30 MHz test set up

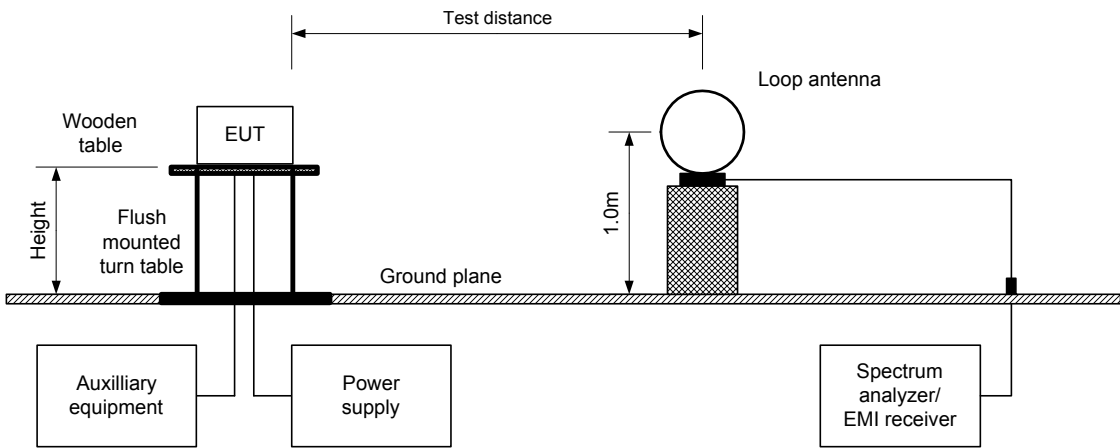
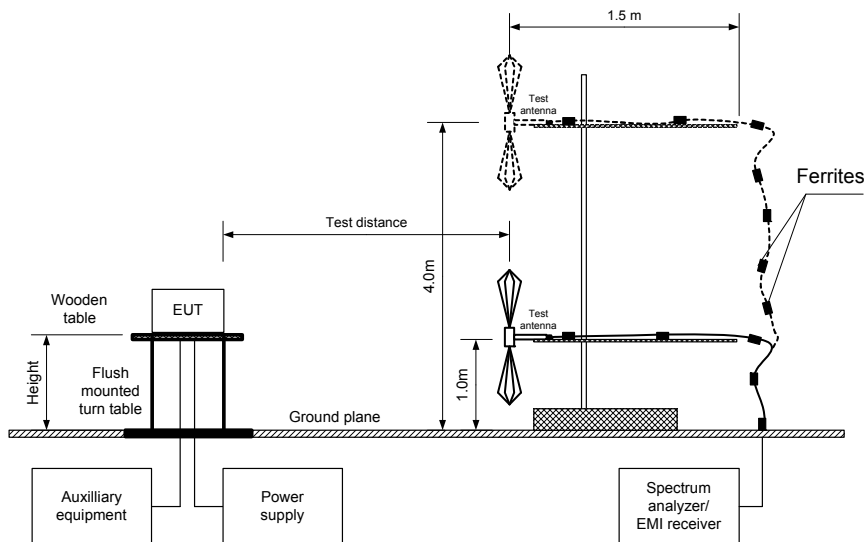

Figure 7.4.2 Radiated emissions above 30 MHz test set up





Test specification:	Section 15.255(c)(2), RSS-210 section A13.2.2, Out of band radiated emissions below 40 GHz		
Test procedure:	47 CFR, Section 2.1053; ANSI C63.4, Sections 8.3.2, 13.2, 13.4		
Test mode:	Compliance	Verdict: PASS	
Date:	8/19/2015-8/30/2015		
Temperature: 24.8°C	Air Pressure: 1012 hPa	Relative Humidity: 51%	Power Supply: 48 VDC
Remarks:			

Table 7.4.2 Radiated emissions test results below 1000 MHz

TEST SITE: Semi Anechoic Chamber
 TEST DISTANCE: 3 m
 EUT POSITION: Typical (Vertical)
 MODULATION: QPSK
 EMISSION BANDWIDTH: 250 MHz
 MODULATING SIGNAL: PRBS
 TRANSMITTER OUTPUT POWER SETTINGS: Maximum
 INVESTIGATED FREQUENCY RANGE: 0.009 – 40000 MHz
 RESOLUTION BANDWIDTH: 1.0 kHz (9 kHz – 150 kHz)
 9.0 kHz (150 kHz – 30 MHz)
 120 kHz (30 MHz – 1000 MHz)
 VIDEO BANDWIDTH: ≥ Resolution bandwidth
 TEST ANTENNA TYPE: Active loop (9 kHz – 30 MHz)
 Biconilog (30 MHz – 1000 MHz)

Frequency, MHz	Peak emission, dB(μV/m)	Quasi-peak			Antenna polarization	Antenna height, m	Turn-table position**, degrees	Verdict
		Measured emission, dB(μV/m)	Limit, dB(uV/m)	Margin, dB*				
Low frequency 53375 MHz								
30.63	40.98	39.70	40.0	-0.30	Vert	1.0	0	Pass
32.41	40.10	29.47	40.0	-10.53	Vert	1.0	50	Pass
94.36	39.41	37.90	43.5	-5.60	Vert	1.2	0	Pass
143.21	33.43	31.36	43.5	-12.14	Vert	1.0	80	Pass
250.00	44.14	42.64	46.0	-3.36	Vert	1.1	270	Pass
999.99	47.68	47.31	54.0	-6.69	Vert	1.2	0	Pass
Mid frequency 60375 MHz								
32.58	31.18	28.11	40.0	-11.89	Vert	1.0	350	Pass
96.31	37.16	34.39	40.0	-5.61	Vert	1.0	330	Pass
125.00	29.43	30.41	43.5	-13.09	Vert	1.0	190	Pass
250.00	41.64	37.58	46.0	-8.42	Vert	1.4	270	Pass
500.00	42.31	40.00	46.0	-6.00	Horiz	1.0	320	Pass
625.00	36.22	34.41	46.0	-11.59	Vert	1.0	340	Pass
999.99	46.79	44.83	54.0	-9.17	Vert	1.0	330	Pass
High frequency 63375 MHz								
30.61	38.73	37.10	40.0	-2.9	Vert	1.0	0	Pass
94.35	41.88	39.31	43.5	-4.19	Vert	1.0	120	Pass
143.28	35.23	34.34	43.5	-9.16	Verti	1.0	0	Pass
250.00	44.72	42.56	46.0	-3.44	Vert	1.0	0	Pass
500.00	38.58	37.22	46.0	-8.78	Horiz	1.0	340	Pass
550.00	39.98	38.84	46.0	-7.16	Horiz	1.0	100	Pass
999.99	46.71	46.46	54.0	-7.54	Horiz	1.0	300	Pass

*- Margin = Measured emission - specification limit.
 **- EUT front panel refer to 0 degrees position of turntable.



Test specification:	Section 15.255(c)(2), RSS-210 section A13.2.2, Out of band radiated emissions below 40 GHz		
Test procedure:	47 CFR, Section 2.1053; ANSI C63.4, Sections 8.3.2, 13.2, 13.4		
Test mode:	Compliance	Verdict: PASS	
Date:	8/19/2015-8/30/2015		
Temperature: 24.8°C	Air Pressure: 1012 hPa	Relative Humidity: 51%	Power Supply: 48 VDC
Remarks:			

Table 7.4.3 Radiated emissions test results in 1000 – 40000 MHz range

TEST SITE: OATS
 TEST DISTANCE: 3 m
 EUT POSITION: Typical (Vertical)
 MODULATION: QPSK
 EMISSION BANDWIDTH: 125 MHz
 MODULATING SIGNAL: PRBS
 TRANSMITTER OUTPUT POWER SETTINGS: Maximum
 INVESTIGATED FREQUENCY RANGE: 1000 – 40000 MHz
 RESOLUTION BANDWIDTH: 1000 kHz
 VIDEO BANDWIDTH: ≥ Resolution bandwidth
 TEST ANTENNA TYPE: Double-Ridged Waveguide Horn

Frequency, MHz	Antenna		Azimuth, degrees*	Peak field strength (VBW=3 MHz)			Average field strength (VBW=30 Hz)			Verdict
	Polariz.	Height, m		Measured, dB(μV/m)	Limit, dB(μV/m)	Margin, dB**	Measured, dB(μV/m)	Limit, dB(μV/m)	Margin, dB***	
Low frequency 57375 MHz										
1067.500	Vertical	1.1	330	46.28	74.0	-27.72	45.98	54.0	-8.02	Pass
5000.000	Vertical	1.0	0	49.64	74.0	-24.36	49.02	54.0	-4.98	
Mid frequency 60375 MHz										
1067.500	Vertical	1.1	20	47.44	74.0	-26.56	47.20	54.0	-6.80	Pass
5000.000	Vertical	1.0	350	46.20	74.0	-27.8	45.98	54.0	-8.02	
High frequency 63375 MHz										
1067.500	Vertical	1.1	340	53.58	74.0	-20.42	53.01	54.0	-0.99	Pass
5000.000	Vertical	1.0	350	48.39	74.0	-25.61	48.04	54.0	-5.96	

*EUT front panel refer to 0 degrees position of turntable
 **- Margin = Measured emission - specification limit.
 ***- Margin = Calculated emission - specification limit.

Reference numbers of test equipment used

HL 0446	HL 0521	HL 0604	HL 0768	HL 0769	HL 2909	HL 3535	HL 3901
HL 3903	HL 4114	HL 4353	HL 4722	HL 4856	HL 4932		

Full description is given in Appendix A.



HERMON LABORATORIES

Test specification:		Section 15.255(c)(2), RSS-210 section A13.2.2, Out of band radiated emissions below 40 GHz	
Test procedure:		47 CFR, Section 2.1053; ANSI C63.4, Sections 8.3.2, 13.2, 13.4	
Test mode:		Compliance	
Date:		8/19/2015-8/30/2015	
Temperature: 24.8°C		Air Pressure: 1012 hPa	
Remarks:		Verdict: PASS	
		Relative Humidity: 51%	
		Power Supply: 48 VDC	

Plot 7.4.1 Radiated emission measurements from 9 to 150 kHz

TEST SITE: Anechoic chamber
TEST DISTANCE: 3 m
ANTENNA POLARIZATION: Vertical

High frequency: 63375 MHz
Mid frequency: 60375 MHz
Low frequency: 57375 MHz

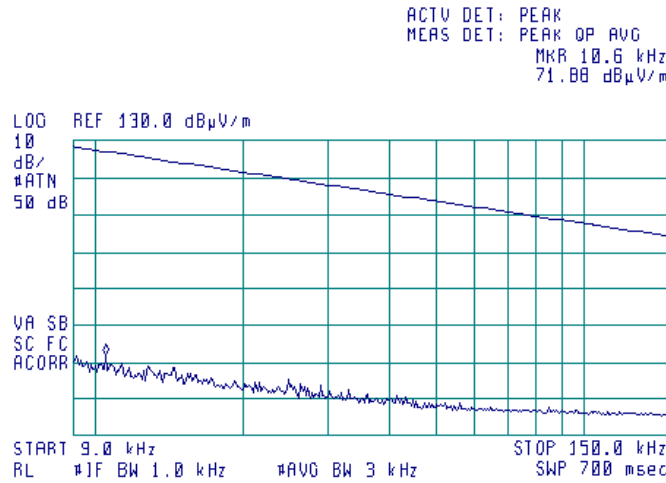



HERMON LABORATORIES

Test specification:	Section 15.255(c)(2), RSS-210 section A13.2.2, Out of band radiated emissions below 40 GHz		
Test procedure:	47 CFR, Section 2.1053; ANSI C63.4, Sections 8.3.2, 13.2, 13.4		
Test mode:	Compliance	Verdict: PASS	
Date:	8/19/2015-8/30/2015		
Temperature: 24.8°C	Air Pressure: 1012 hPa	Relative Humidity: 51%	Power Supply: 48 VDC
Remarks:			

Plot 7.4.2 Radiated emission measurements from 0.15 to 30 MHz

TEST SITE: Anechoic chamber
 TEST DISTANCE: 3 m
 ANTENNA POLARIZATION: Vertical

High frequency: 63375 MHz
 Mid frequency: 60375 MHz
 Low frequency: 57375 MHz

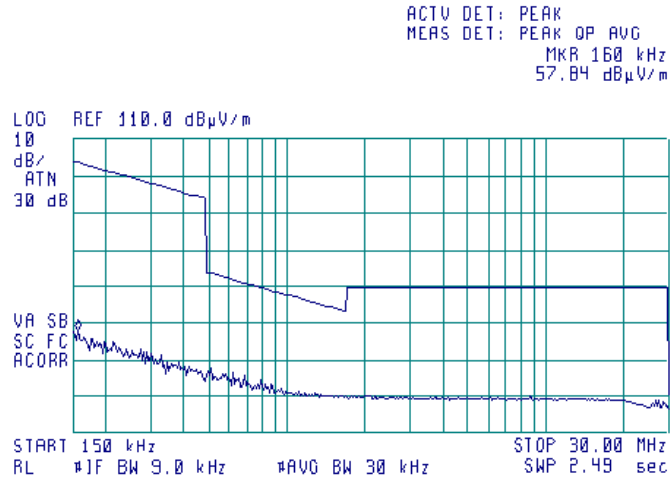



HERMON LABORATORIES

Test specification:		Section 15.255(c)(2), RSS-210 section A13.2.2, Out of band radiated emissions below 40 GHz	
Test procedure:		47 CFR, Section 2.1053; ANSI C63.4, Sections 8.3.2, 13.2, 13.4	
Test mode:		Compliance	
Date:		8/19/2015-8/30/2015	
Temperature: 24.8°C		Air Pressure: 1012 hPa	Relative Humidity: 51%
Remarks:		Power Supply: 48 VDC	
Verdict: PASS			

Plot 7.4.3 Radiated emission measurements from 30 to 1000 MHz

TEST SITE: Semi anechoic chamber
 TEST DISTANCE: 3 m
 ANTENNA POLARIZATION: Vertical
 Low frequency: 57375 MHz

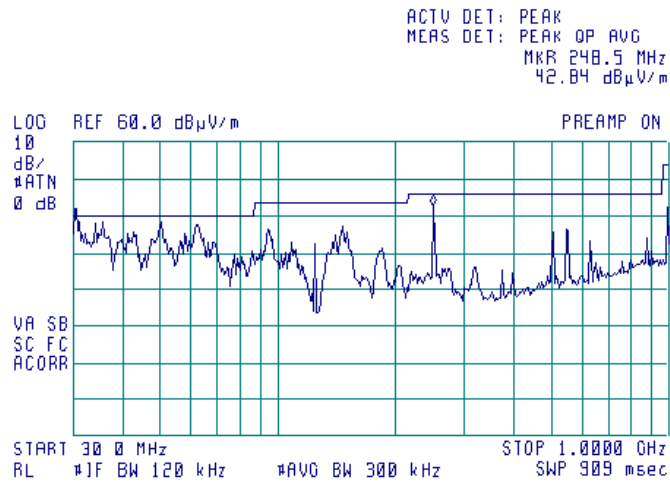

Plot 7.4.4 Radiated emission measurements from 30 to 1000 MHz

TEST SITE: Semi anechoic chamber
 TEST DISTANCE: 3 m
 ANTENNA POLARIZATION: Horizontal
 Low frequency: 57375 MHz

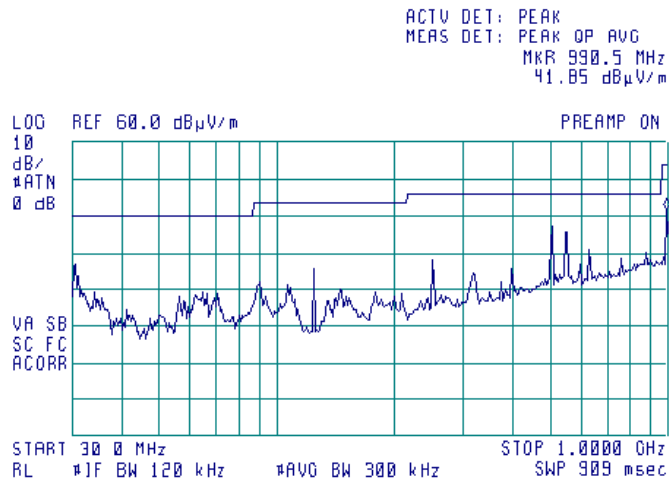



HERMON LABORATORIES

Test specification:	Section 15.255(c)(2), RSS-210 section A13.2.2, Out of band radiated emissions below 40 GHz		
Test procedure:	47 CFR, Section 2.1053; ANSI C63.4, Sections 8.3.2, 13.2, 13.4		
Test mode:	Compliance	Verdict: PASS	
Date:	8/19/2015-8/30/2015		
Temperature: 24.8°C	Air Pressure: 1012 hPa	Relative Humidity: 51%	Power Supply: 48 VDC
Remarks:			

Plot 7.4.5 Radiated emission measurements from 30 to 1000 MHz

TEST SITE: Semi anechoic chamber
TEST DISTANCE: 3 m
ANTENNA POLARIZATION: Vertical
Mid frequency: 60375 MHz

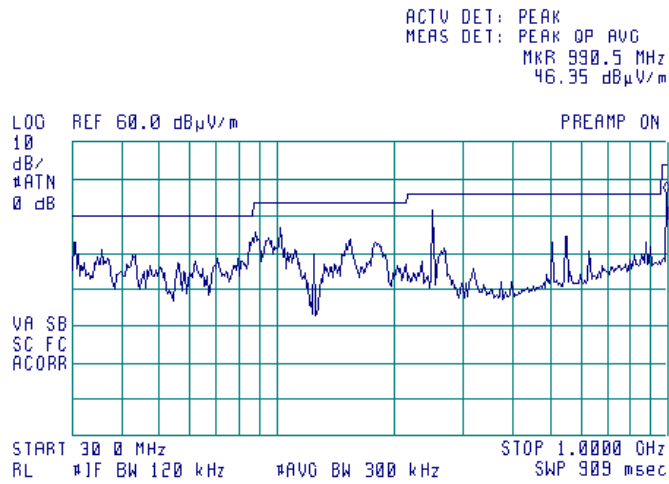

Plot 7.4.6 Radiated emission measurements from 30 to 1000 MHz

TEST SITE: Semi anechoic chamber
TEST DISTANCE: 3 m
ANTENNA POLARIZATION: Horizontal
Mid frequency: 60375 MHz

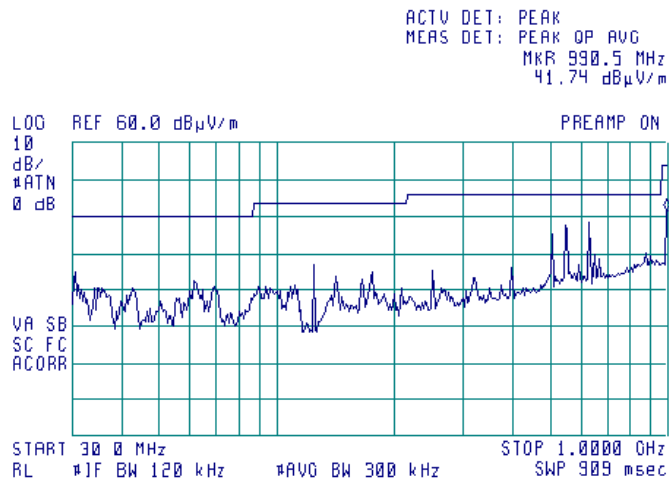



HERMON LABORATORIES

Test specification:		Section 15.255(c)(2), RSS-210 section A13.2.2, Out of band radiated emissions below 40 GHz	
Test procedure:		47 CFR, Section 2.1053; ANSI C63.4, Sections 8.3.2, 13.2, 13.4	
Test mode:		Compliance	
Date:		8/19/2015-8/30/2015	
Temperature: 24.8°C		Air Pressure: 1012 hPa	Relative Humidity: 51%
Remarks:		Power Supply: 48 VDC	
Verdict: PASS			

Plot 7.4.7 Radiated emission measurements from 30 to 1000 MHz

TEST SITE: Semi anechoic chamber
 TEST DISTANCE: 3 m
 ANTENNA POLARIZATION: Vertical
 High frequency: 63375 MHz

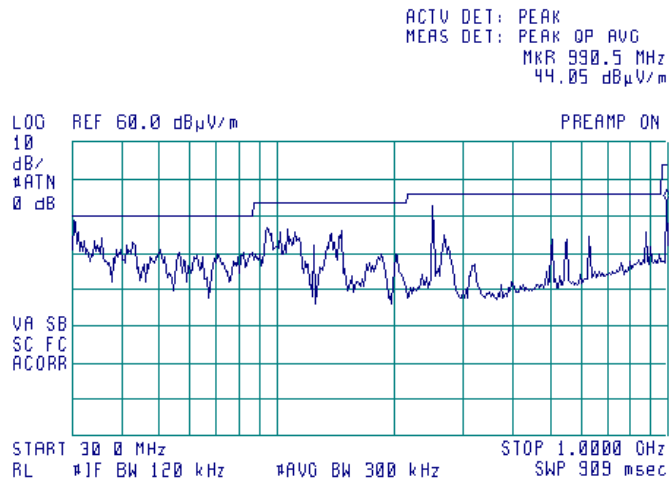

Plot 7.4.8 Radiated emission measurements from 30 to 1000 MHz

TEST SITE: Semi anechoic chamber
 TEST DISTANCE: 3 m
 ANTENNA POLARIZATION: Horizontal
 High frequency: 63375 MHz

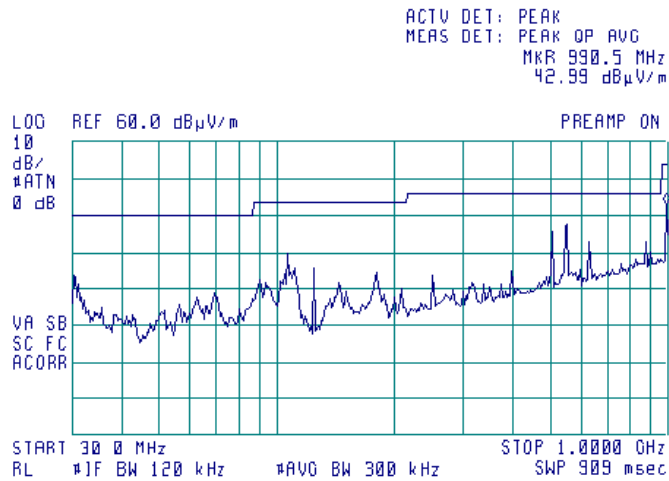



HERMON LABORATORIES

Test specification:		Section 15.255(c)(2), RSS-210 section A13.2.2, Out of band radiated emissions below 40 GHz	
Test procedure:		47 CFR, Section 2.1053; ANSI C63.4, Sections 8.3.2, 13.2, 13.4	
Test mode:		Verdict: PASS	
Date:		8/19/2015-8/30/2015	
Temperature: 24.8°C	Air Pressure: 1012 hPa	Relative Humidity: 51%	Power Supply: 48 VDC
Remarks:			

Plot 7.4.9 Radiated emission measurements from 1000 to 6000 MHz

TEST SITE:
TEST DISTANCE:
ANTENNA POLARIZATION:
DETECTOR: Peak

Anechoic chamber
3 m
Vertical and Horizontal
DETECTOR: Average

Low frequency:

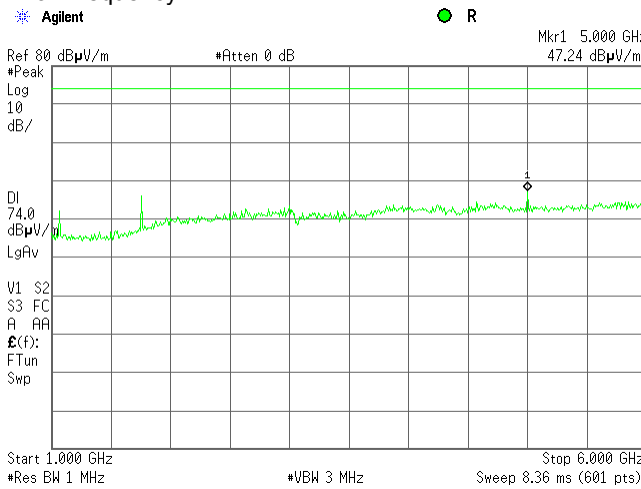

57375 MHz

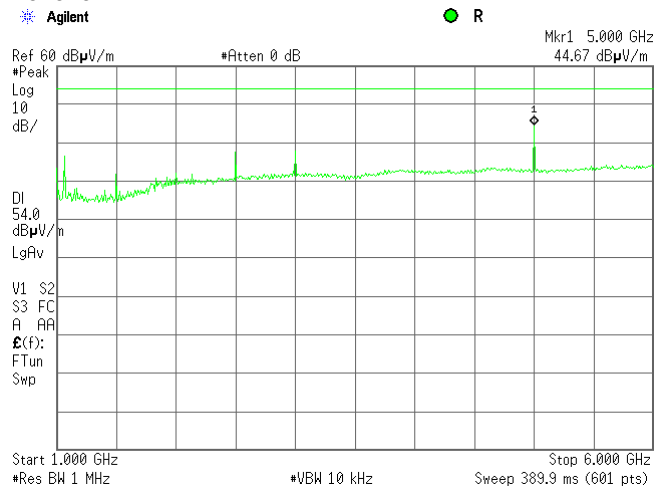

Mid frequency:

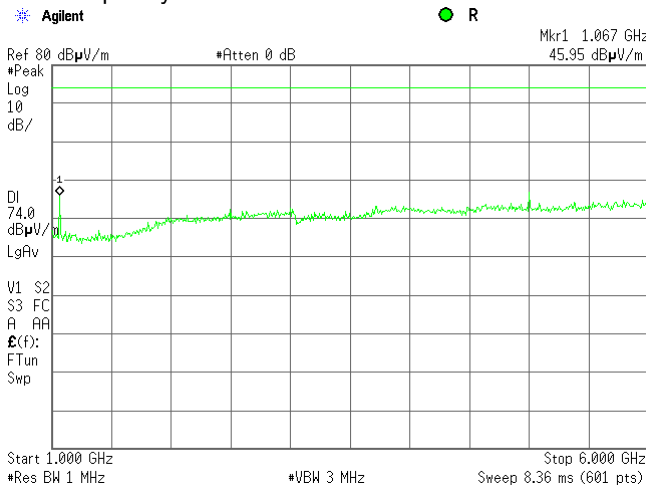

60375 MHz

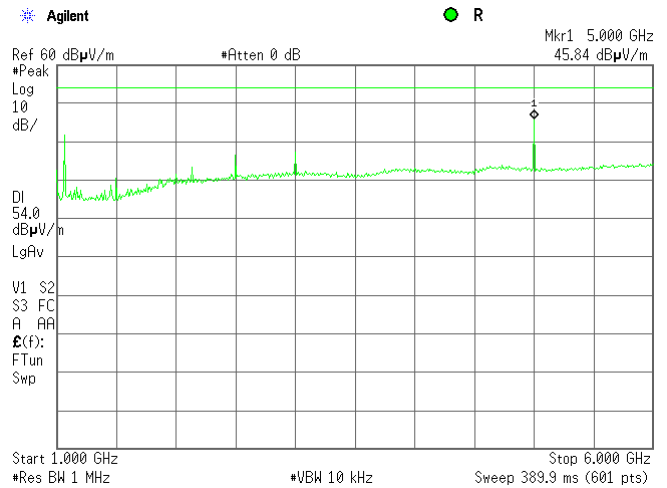



HERMON LABORATORIES

Test specification:		Section 15.255(c)(2), RSS-210 section A13.2.2, Out of band radiated emissions below 40 GHz	
Test procedure:		47 CFR, Section 2.1053; ANSI C63.4, Sections 8.3.2, 13.2, 13.4	
Test mode:		Verdict: PASS	
Date:			
Temperature: 24.8°C	Air Pressure: 1012 hPa	Relative Humidity: 51%	Power Supply: 48 VDC
Remarks:			

Plot 7.4.10 Radiated emission measurements from 1000 to 6000 MHz

TEST SITE:
TEST DISTANCE:
ANTENNA POLARIZATION:
DETECTOR: Peak

Anechoic chamber
3 m
Vertical and Horizontal
DETECTOR: Average

High frequency :

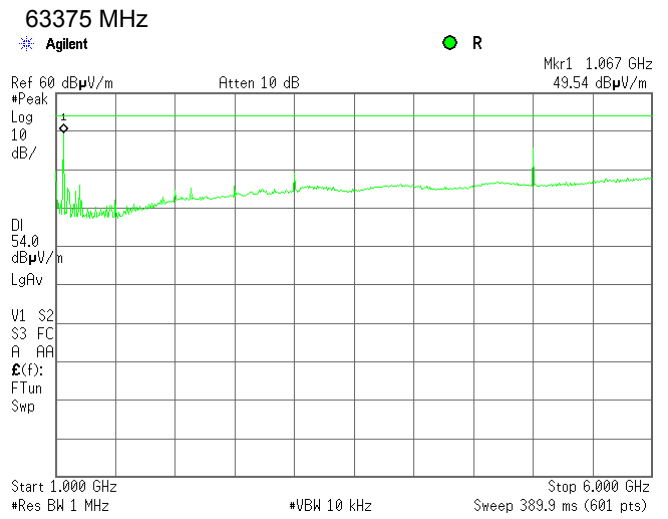
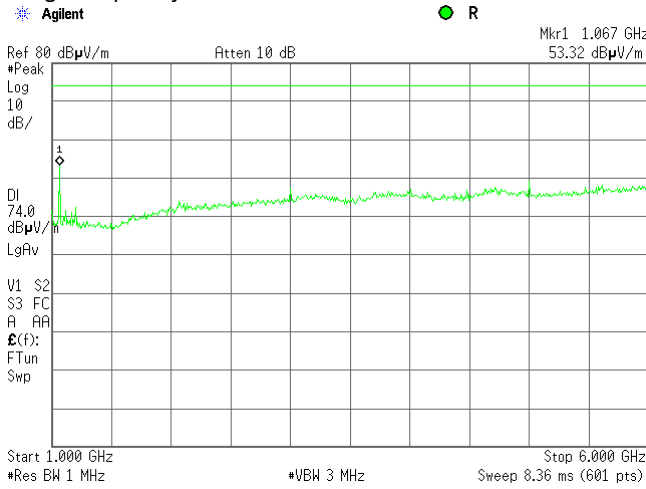



HERMON LABORATORIES

Test specification:		Section 15.255(c)(2), RSS-210 section A13.2.2, Out of band radiated emissions below 40 GHz	
Test procedure:		47 CFR, Section 2.1053; ANSI C63.4, Sections 8.3.2, 13.2, 13.4	
Test mode:		Verdict: PASS	
Date:		8/19/2015-8/30/2015	
Temperature: 24.8°C	Air Pressure: 1012 hPa	Relative Humidity: 51%	Power Supply: 48 VDC
Remarks:			

Plot 7.4.11 Radiated emission measurements from 6000 – 18000 MHz

TEST SITE:
TEST DISTANCE:
ANTENNA POLARIZATION:
DETECTOR:

Anechoic chamber
3 m
Vertical and Horizontal
Peak

Low frequency :

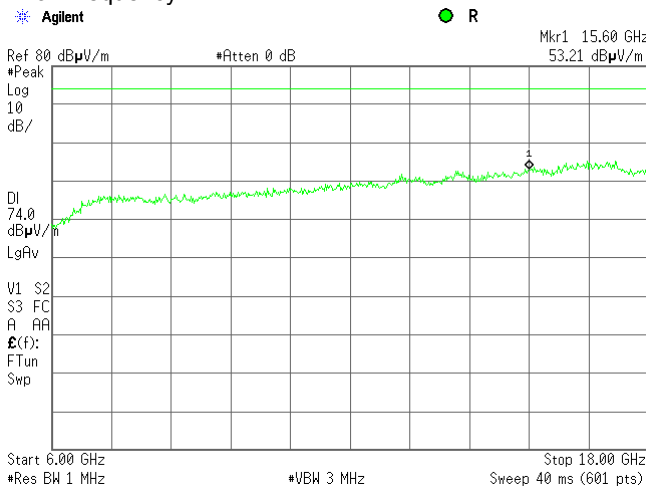

57375 MHz

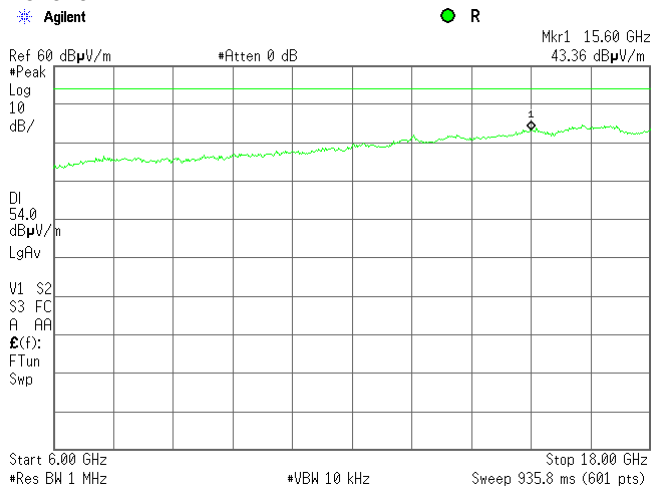

Mid frequency:

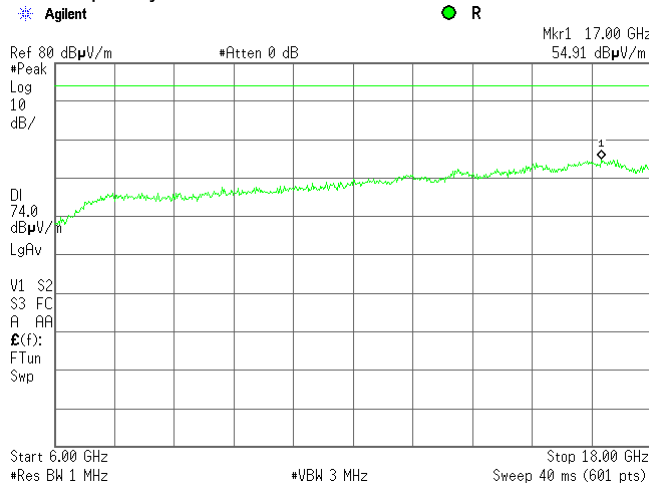

60375 MHz

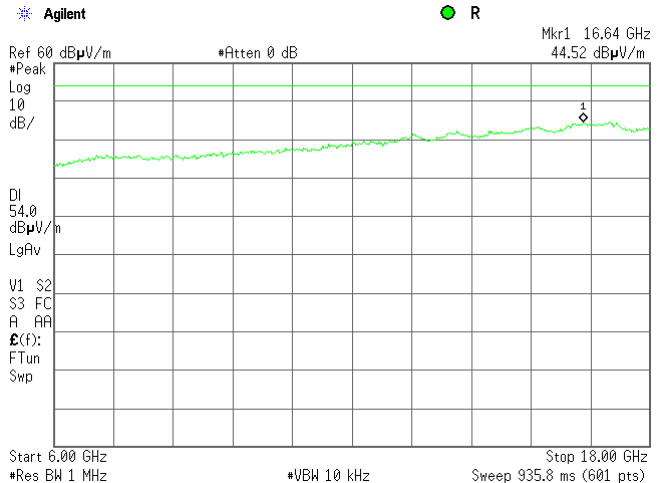



HERMON LABORATORIES

Test specification:		Section 15.255(c)(2), RSS-210 section A13.2.2, Out of band radiated emissions below 40 GHz	
Test procedure:		47 CFR, Section 2.1053; ANSI C63.4, Sections 8.3.2, 13.2, 13.4	
Test mode:		Verdict: PASS	
Date:			
Temperature: 24.8°C	Air Pressure: 1012 hPa	Relative Humidity: 51%	Power Supply: 48 VDC
Remarks:			

Plot 7.4.12 Radiated emission measurements from 6000 – 18000 MHz

TEST SITE:
TEST DISTANCE:
ANTENNA POLARIZATION:
DETECTOR:

Anechoic chamber
3 m
Vertical and Horizontal
Peak

High frequency :

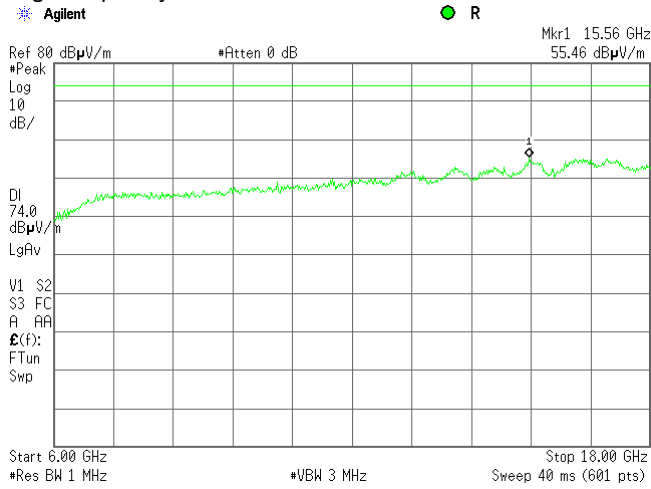

63375 MHz

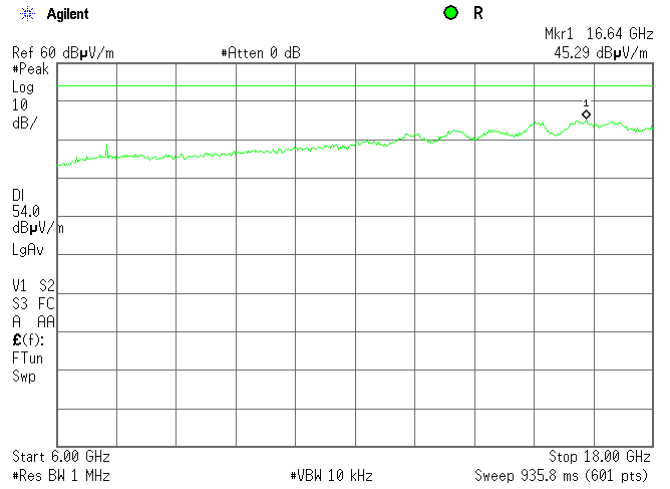



HERMON LABORATORIES

Test specification:		Section 15.255(c)(2), RSS-210 section A13.2.2, Out of band radiated emissions below 40 GHz	
Test procedure:		47 CFR, Section 2.1053; ANSI C63.4, Sections 8.3.2, 13.2, 13.4	
Test mode:		Verdict: PASS	
Date:			
Temperature: 24.8°C	Air Pressure: 1012 hPa	Relative Humidity: 51%	Power Supply: 48 VDC
Remarks:			

Plot 7.4.13 Radiated emission measurements from 18000 to 26500 MHz

TEST SITE:
TEST DISTANCE:
ANTENNA POLARIZATION:
DETECTOR:

Semi Anechoic Chamber
3 m
Vertical and Horizontal
Peak

Low frequency:

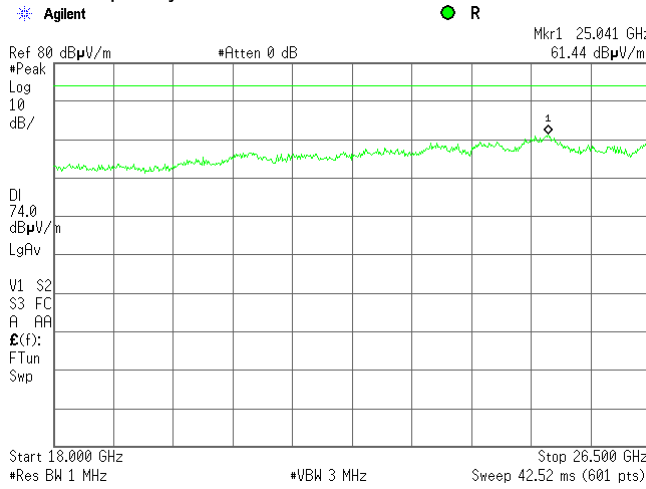

57375 MHz

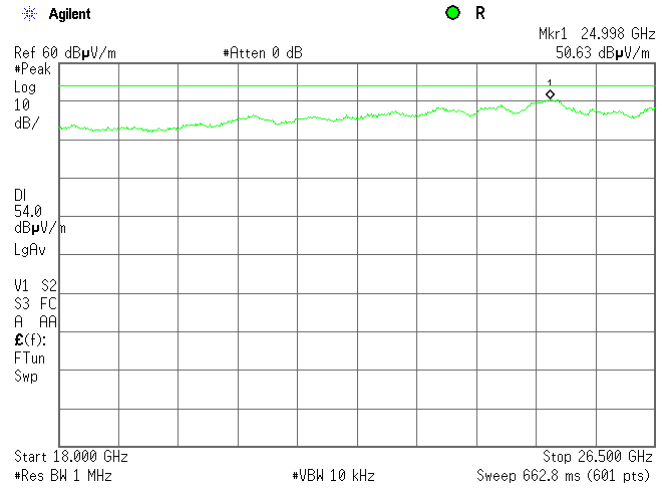

Mid frequency:

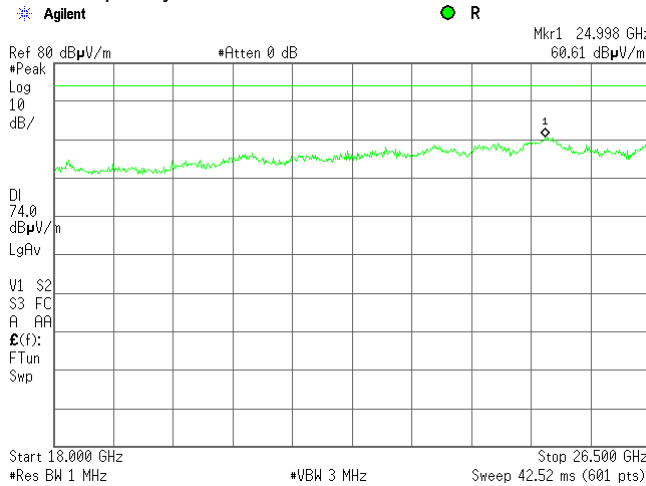

60375 MHz

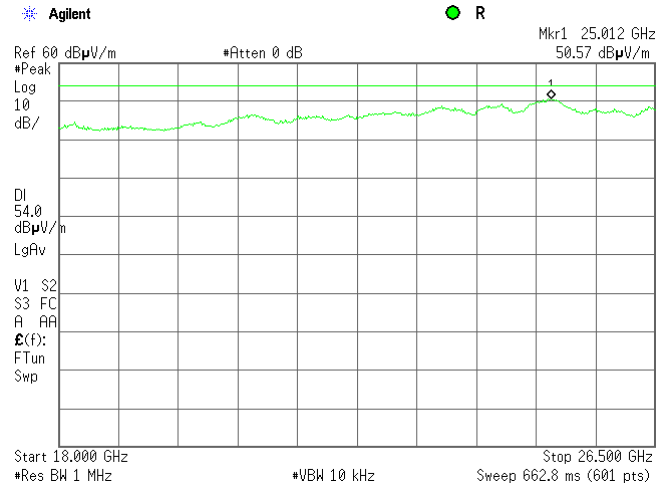



HERMON LABORATORIES

Test specification:		Section 15.255(c)(2), RSS-210 section A13.2.2, Out of band radiated emissions below 40 GHz	
Test procedure:		47 CFR, Section 2.1053; ANSI C63.4, Sections 8.3.2, 13.2, 13.4	
Test mode:		Verdict: PASS	
Date:		8/19/2015-8/30/2015	
Temperature: 24.8°C	Air Pressure: 1012 hPa	Relative Humidity: 51%	Power Supply: 48 VDC
Remarks:			

Plot 7.4.14 Radiated emission measurements from 18000 to 26500 MHz

TEST SITE:
TEST DISTANCE:
ANTENNA POLARIZATION:
DETECTOR:

Semi Anechoic Chamber
3 m
Vertical and Horizontal
Peak

High frequency:

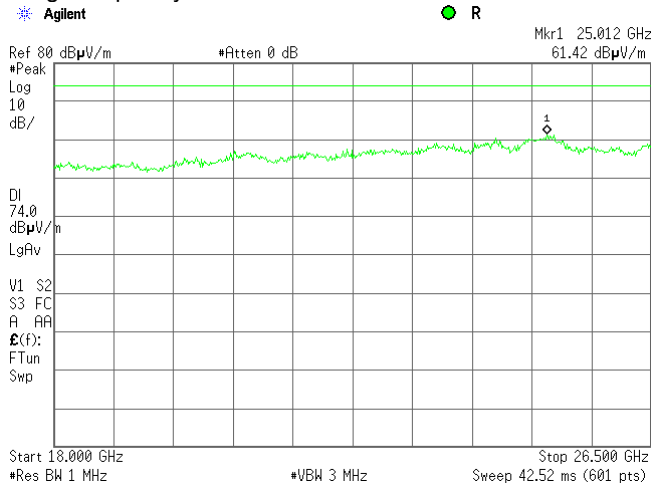

63375 MHz

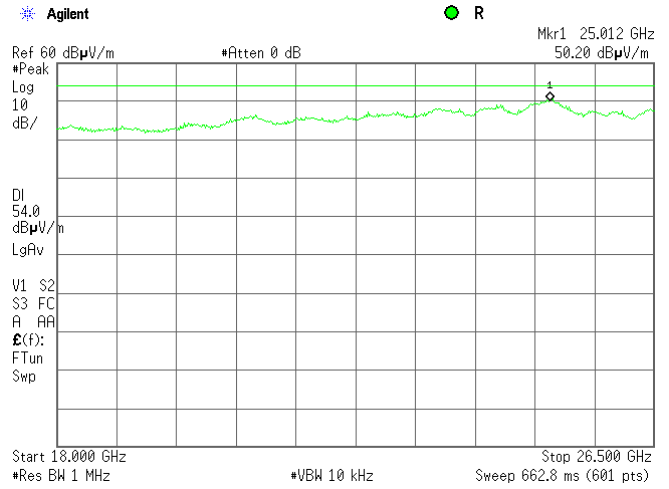

Plot 7.4.15 Radiated emission measurements from 26500 to 40000 MHz

TEST SITE:
TEST DISTANCE:
ANTENNA POLARIZATION:
DETECTOR:
LOW FREQUENCY:

Semi Anechoic Chamber
3 m
Vertical and Horizontal
Peak
57375 MHz

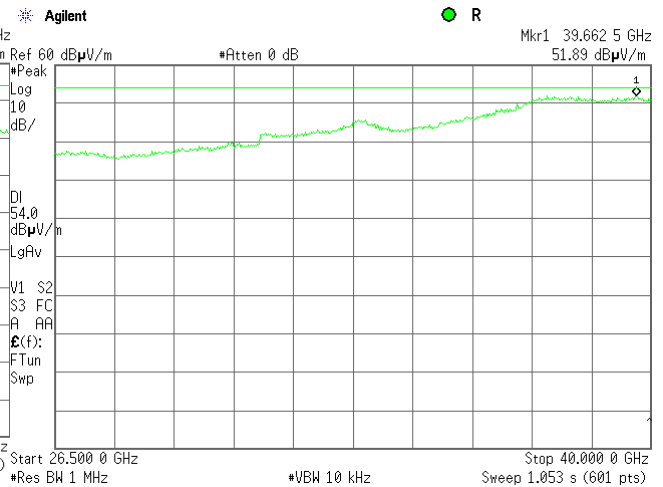
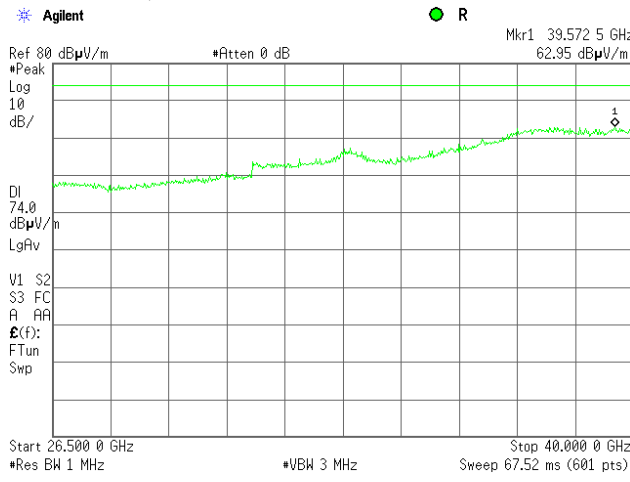



HERMON LABORATORIES

Test specification:		Section 15.255(c)(2), RSS-210 section A13.2.2, Out of band radiated emissions below 40 GHz	
Test procedure:		47 CFR, Section 2.1053; ANSI C63.4, Sections 8.3.2, 13.2, 13.4	
Test mode:		Verdict: PASS	
Date:		8/19/2015-8/30/2015	
Temperature: 24.8°C	Air Pressure: 1012 hPa	Relative Humidity: 51%	Power Supply: 48 VDC
Remarks:			

Plot 7.4.16 Radiated emission measurements from 26500 to 40000 MHz

TEST SITE: Semi Anechoic Chamber
 TEST DISTANCE: 3 m
 ANTENNA POLARIZATION: Vertical and Horizontal
 DETECTOR: Peak
 MID FREQUENCY: 60375 MHz

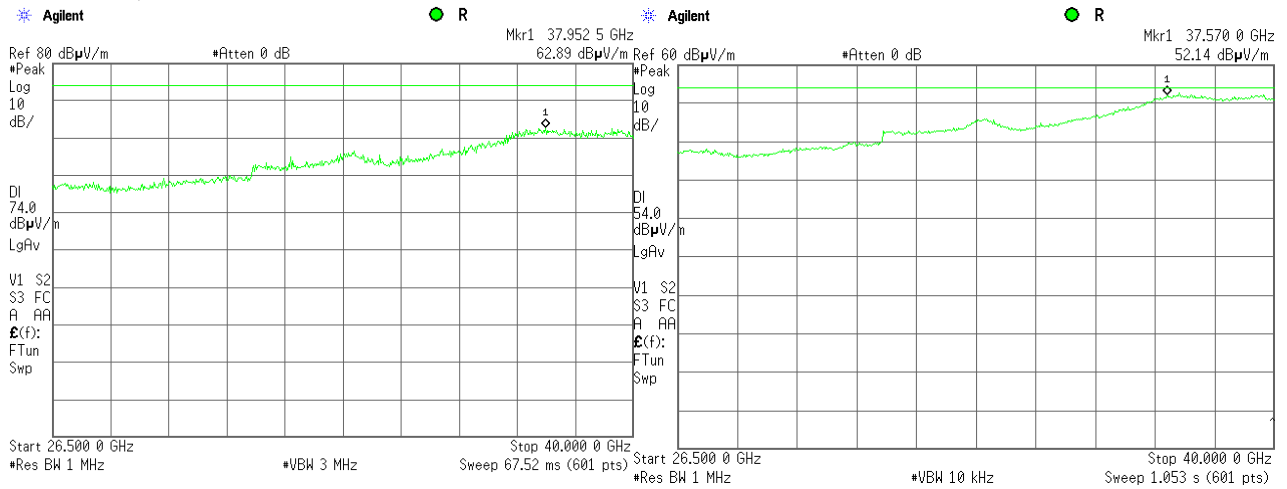

Plot 7.4.17 Radiated emission measurements from 26500 to 40000 MHz

TEST SITE: OATS
 TEST DISTANCE: 3 m
 ANTENNA POLARIZATION: Vertical and Horizontal
 DETECTOR: Peak
 HIGH FREQUENCY: 63375 MHz

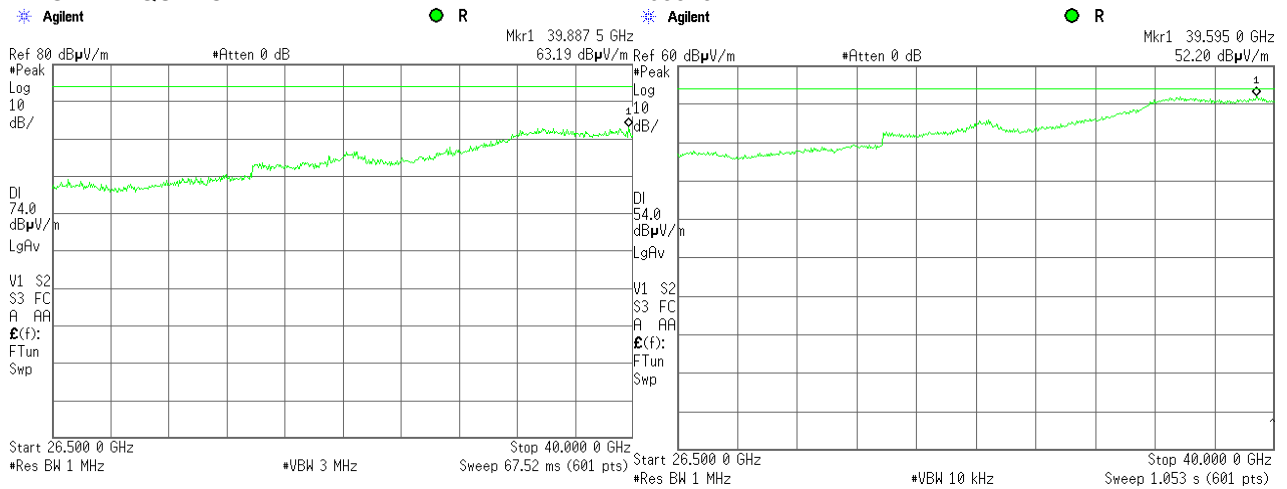



Test specification:	Section 15.255(f), RSS-210 section A13.2.5, Frequency tolerance		
Test procedure:	47 CFR, Section 2.1055; KDB 200433 D02		
Test mode:	Compliance	Verdict:	PASS
Date:	8/30/2015		
Temperature: 24.3°C	Air Pressure: 1012 hPa	Relative Humidity: 42%	Power Supply: 48 VDC
Remarks:			

7.5 Frequency stability test

7.5.1 General

This test was performed to measure frequency stability of transmitter RF carrier. Specification test limits are given in Table 7.5.1.

Table 7.5.1 Frequency stability limits

Assigned frequency, MHz	Maximum allowed frequency displacement
57375	NA
60375	
63375	

7.5.2 Test procedure

- 7.5.2.1 The EUT was set up as shown in Figure 7.5.1, energized and its proper operation was checked.
- 7.5.2.2 The EUT power was turned off. Temperature within test chamber was set to +30°C and a period of time sufficient to stabilize all of the oscillator circuit components was allowed.
- 7.5.2.3 The EUT was powered on and carrier frequency was measured at start up moment and then every minute until frequency had been stabilized or 10 minutes elapsed whichever reached the last. The EUT was powered off.
- 7.5.2.4 The above procedure was repeated at 0°C and at the lowest test temperature.
- 7.5.2.5 The EUT was powered on and carrier frequency was measured at start up moment and at the end of stabilization period at the rest of test temperatures and voltages. The EUT was powered off.
- 7.5.2.6 Frequency displacement was calculated and compared with the limit as provided in Table 7.5.2.

Figure 7.5.1 Frequency stability test setup

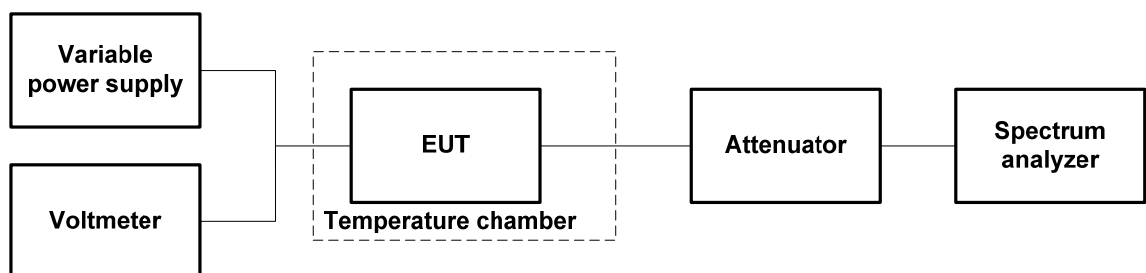



Test specification:		Section 15.255(f), RSS-210 section A13.2.5, Frequency tolerance			
Test procedure:		47 CFR, Section 2.1055; KDB 200433 D02			
Test mode:		Compliance		Verdict: PASS	
Date:		8/30/2015			
Temperature: 24.3°C		Air Pressure: 1012 hPa		Relative Humidity: 42%	
				Power Supply: 48 VDC	
Remarks:					

Table 7.5.2 Frequency stability test results

OPERATING FREQUENCY: 57000 – 64000 MHz
 NOMINAL POWER VOLTAGE: 48 V
 TEMPERATURE STABILIZATION PERIOD: 20 min
 POWER DURING TEMPERATURE TRANSITION: Off
 SPECTRUM ANALYZER MODE: Counter
 RESOLUTION BANDWIDTH: 3 kHz
 VIDEO BANDWIDTH: 10 kHz
 MODULATION: Unmodulated

T, °C	Voltage, V	Frequency, MHz							Max frequency drift, kHz	
		Start up	1 st min	2 nd min	3 rd min	4 th min	5 th min	10 th min	Positive	Negative
Low frequency 57375 MHz										
-20	nominal	57375.5958	57375.5951	57375.5943	57375.5937	57375.5929	57375.5920	57375.5909	741.9	NA
-10	nominal	57375.4887	NA	NA	NA	NA	NA	57375.4887	639.7	NA
0	nominal	57375.3368	57375.3348	57375.3302	57375.3276	57375.3258	57375.3118	57375.3108	461.8	NA
10	nominal	57375.0942	NA	NA	NA	NA	NA	57375.0830	234.0	NA
20	+15%	57374.9085	NA	NA	NA	NA	NA	57374.8550	6.0	NA
20	nominal	57374.9073	NA	NA	NA	NA	NA	57374.8490	0.0	NA
20	-15%	57374.9071	NA	NA	NA	NA	NA	57374.8500	1.0	NA
30	nominal	57374.6038	57374.6024	57374.6004	57374.5967	57374.5913	57374.5894	57374.5866	NA	262.4
40	nominal	57374.4496	NA	NA	NA	NA	NA	57374.4110	NA	438.0
50	nominal	57374.3350	NA	NA	NA	NA	NA	57374.3172	NA	531.8
Mid frequency 60375 MHz										
-20	nominal	60375.6176	60375.6162	60375.6150	60375.6144	60375.6139	60375.6133	60375.6130	801.0	NA
-10	nominal	60375.5310	NA	NA	NA	NA	NA	60375.4820	670.0	NA
0	nominal	60375.3260	60375.3251	60375.3242	60375.3172	60375.3155	60375.3162	60375.3164	504.4	NA
10	nominal	60375.1271	NA	NA	NA	NA	NA	60375.1025	290.5	NA
20	+15%	60374.8410	NA	NA	NA	NA	NA	60374.8135	1.5	NA
20	nominal	60374.8395	NA	NA	NA	NA	NA	60374.8120	0.0	NA
20	-15%	60374.8387	NA	NA	NA	NA	NA	60374.8109	NA	1.1
30	nominal	60374.5614	60374.5620	60374.5598	60374.5587	60374.5576	60374.5576	60374.5581	NA	253.9
40	nominal	60374.3773	NA	NA	NA	NA	NA	60374.3696	NA	442.4
50	nominal	60374.2931	NA	NA	NA	NA	NA	60374.2718	NA	540.2
High frequency 63375 MHz										
-20	nominal	63375.6421	63375.6424	63375.6431	63375.6438	63375.6442	63375.6447	63375.6450	848.0	NA
-10	nominal	63375.5874	NA	NA	NA	NA	NA	63375.5616	764.6	NA
0	nominal	63375.3300	63375.3306	63375.3304	63375.3266	63375.3260	63375.3257	63375.3259	528.9	NA
10	nominal	63375.2154	NA	NA	NA	NA	NA	63375.1538	356.8	NA
20	+15%	63374.7985	NA	NA	NA	NA	NA	63374.7990	2.0	NA
20	nominal	63374.7971	NA	NA	NA	NA	NA	63374.7970	0.0	NA
20	-15%	63374.7963	NA	NA	NA	NA	NA	63374.7951	NA	1.9
30	nominal	63374.5331	63374.5302	63374.5309	63374.5317	63374.5302	63374.5295	63374.5289	NA	268.1
40	nominal	63374.3360	NA	NA	NA	NA	NA	63374.3335	NA	463.5
50	nominal	63374.2360	NA	NA	NA	NA	NA	63374.2350	NA	562.0

* - Reference frequency

Reference numbers of test equipment used

HL 1303	HL 2358	HL 2909	HL 3291	HL 3295	HL 3305	HL 3433	HL 3434
---------	---------	---------	---------	---------	---------	---------	---------

Full description is given in Appendix A.

**8 APPENDIX A Test equipment and ancillaries used for tests**

HL No	Description	Manufacturer	Model	Ser. No.	Last Cal./ Check	Due Cal./ Check
0446	Antenna, Loop, Active, 10 kHz - 30 MHz	EMCO	6502	2857	13-Jan-15	13-Jan-16
0521	EMI Receiver (Spectrum Analyzer) with RF filter section 9 kHz-6.5 GHz	Hewlett Packard	8546A	3617A 00319, 3448A002 53	22-Oct-14	22-Oct-15
0604	Antenna BiconiLog Log-Periodic/T Bow-TIE, 26 - 2000 MHz	EMCO	3141	9611-1011	15-May-15	15-May-16
0747	Mixer, Millimeter Wave Harmonic 90 - 140 GHZ	Oleson Microwave Labs	M08HW	F80429-1	08-Nov-13	08-Nov-16
0748	Mixer Millimeter Wave Harmonic 60 - 90 GHz	Oleson Microwave Labs	M12 HW	E 804 29-1	08-Nov-13	08-Nov-16
0768	Antenna Standard Gain Horn, 18-26.5 GHz, WR-42, 25 dB gain	Quinstar Technology	QWH-4200-BA	110	25-Dec-14	25-Dec-15
0769	Antenna Standard Gain Horn, 26.5-40 GHz, WR28, 25 dB gain	Quinstar Technology	QWH-2800-BA	112	25-Dec-14	25-Dec-15
0770	Antenna Standard Gain Horn, 40-60 GHz WR-19, U-band Gain - 25 dB	Quinstar Technology	QWH-1900-AA	118	16-Jul-15	16-Jul-16
0771	Antenna Standard Gain Horn, 60-90 GHz, WR-12, Gain - 25 dB	Quinstar Technology	QWH-1200-AA	111	12-Jul-15	12-Jul-16
0772	Antenna Standard Gain Horn, 75-110 GHz, WR-10, Gain - 25 dB	Quinstar Technology	QWH-0800-AA	110	12-Jul-15	12-Jul-16
1295	Adapter 35WR28Kf, 26.5-40 GHz	Wiltron	35WR28K F	1295	03-Sep-13	03-Sep-16
1299	Transition waveguide ET28S -19R	Custom Microwave	ET28S - 19R	1299	30-Jul-15	30-Jul-18
1300	Transition waveguide ET28S -19R	Custom Microwave	ET28S - 19R	1300	30-Jul-15	30-Jul-18
1303	Transition waveguide ET28S -12R	Custom Microwave	ET28S - 12R	S0951	30-Jul-15	30-Jul-18
1304	Transition waveguide ET28S - 8R	Custom Microwave	ET28S - 8R	1304	30-Jul-15	30-Jul-18
1306	Transition waveguide ET28S - 5R	Custom Microwave	ET28S - 5R	1306	30-Jul-15	30-Jul-18
1312	Mixer Millimeter Wave Harmonic 140-220 GHz	Oleson Microwave Labs	M05HWD	G91112-1	08-Nov-13	08-Nov-16
1424	Spectrum Analyzer, 30 Hz- 40 GHz	Agilent Technologies	8564EC	3946A002 19	12-Apr-15	12-Apr-16
2358	Power Supply, 2 X 0-36VDC / 5A, 5VDC / 5A	Horizon Electronics	DHR3655 D	767469	02-Jun-15	02-Jun-16
2909	Spectrum analyzer, ESA-E, 100 Hz to 26.5 GHz	Agilent Technologies	E4407B	MY414447 62	22-Feb-15	22-Feb-16
3235	Harmonic mixer 40 to 60 GHz	Agilent Technologies	11970U	MY300301 82	23-Jul-13	23-Jul-16
3290	Attenuator, direct reading, 40 to 60 GHz, 0.4 W	Quinstar Technology	QAD-U00000	10381008	14-May-15	14-May-16
3291	Attenuator, direct reading, 60 to 90 GHz, 0.2 W	Quinstar Technology	QAD-E00000	10381009	14-May-15	14-May-16



HL No	Description	Manufacturer	Model	Ser. No.	Last Cal./ Check	Due Cal./ Check
3294	Tapered transition, WR-28, UG-599 to WR-15, UG-385 (26.5-40 GHz to 50-75 GHz)	Quinstar Technology	QWP-AV0000	10381004	30-Jul-15	30-Jul-18
3295	Tapered transition, WR-28, UG-599 to WR-15, UG-385 (26.5-40 GHz to 50-75 GHz)	Quinstar Technology	QWP-AV0000	10381005	30-Jul-15	30-Jul-18
3297	Tapered , WR-28, UG-599 to WR-10, UG-387 (26.5-40 GHz to 75-100 GHz)	Quinstar Technology	QWP-AW0000	10381007	30-Jul-15	30-Jul-18
3305	Harmonic mixer 50 to 75 GHz	Agilent Technologies	11970V	MY30030149	23-Jul-13	23-Jul-16
3329	Antenna Standard Gain Horn, 140-220 GHz, WR-5, Gain - 25 dB	Quinstar Technology	NA	NA	20-Jul-15	20-Jul-16
3433	Test Cable , DC-18 GHz, 1.5 m, SMA - SMA	Mini-Circuits	CBL-5FT-SMSM+	25679	11-Mar-15	11-Mar-16
3434	Test Cable , DC-18 GHz, 1.5 m, SMA - SMA	Mini-Circuits	CBL-5FT-SMSM+	25683	11-Mar-15	11-Mar-16
3455	Medium Power Fixed Coaxial Attenuator DC to 40 GHz, 20 dB, 5 W	Aeroflex / Weinschel	75A-20-12	1182	11-Mar-15	11-Mar-16
3535	Amplifier, low noise, 18 to 40 GHz	Quinstar Technology	QLJ-18404537-J0	11159003001	01-Jan-15	01-Jan-16
3536	Antenna Standard Gain Horn, 90-140 GHz, WR-8, Midband Gain - 24 dB	Quinstar Technology	QWH-FPRR00	11159004001	14-Jun-15	14-Jun-16
3901	Microwave Cable Assembly, 40.0 GHz, 3.5 m, SMA/SMA	Huber-Suhner	SUCOFLE X 102A	1225/2A	10-Feb-15	10-Feb-16
3903	Microwave Cable Assembly, 40.0 GHz, 1.5 m, SMA/SMA	Huber-Suhner	SUCOFLE X 102A	1226/2A	10-Feb-15	10-Feb-16
4023	Diplexer for use OML mixers with Agilent spectrum analyzer	Oleson Microwave Labs	DPL.26	NA	14-May-15	14-May-16
4114	Antenna, Double-Ridged Waveguide Horn, 1-18 GHz	ETS Lindgren	3117	00123515	19-Dec-14	19-Dec-15
4353	Low Loss Armored Test Cable, DC - 18 GHz, 6.2 m, N type-M/N type-M	MegaPhase	NC29-N1N1-244	12025101003	15-Mar-15	15-Mar-16
4722	Low Loss Armored Test Cable, DC - 18 GHz, 6.2 m, N type-M/N type-M	MegaPhase	NC29-N1N1-244	51228701001	31-Aug-15	31-Aug-16
4856	Amplifier, solid state, 18 GHz to 40 GHz, 20 dBm output power	Quinstar Technology	QGW-18402023-J0	16779001001	03-Apr-15	03-Apr-16
4932	Microwave preamplifier, 500 MHz to 18 GHz, 40 dB Gain	Com-Power Corporation	PAM-118A	551029	18-Nov-14	18-Nov-15



9 APPENDIX B Measurement uncertainties

Expanded uncertainty at 95% confidence in Hermon Labs EMC measurements

Test description	Expanded uncertainty
Frequency error	± 0.56 ppm
Carrier power conducted	± 1.7 dB
Spurious emissions conducted at RF antenna connector	30 MHz to 2.9 GHz: ± 2.6 dB 2.9 GHz to 6.46 GHz: ± 3.5 dB 6.46 GHz to 12.75 GHz: ± 4.3 dB 13.2 GHz to 22.0 GHz: ± 5.0 dB 22.0 GHz to 26.8 GHz: ± 5.5 dB 26.8 GHz to 40.0 GHz: ± 4.8 dB
Radiated emissions at 3 m measuring distance Horizontal polarization	Biconilog antenna: ± 5.3 dB Biconical antenna: ± 5.0 dB Log periodic antenna: ± 5.3 dB Double ridged horn antenna: ± 5.3 dB
Vertical polarization	Biconilog antenna: ± 6.0 dB Biconical antenna: ± 5.7 dB Log periodic antenna: ± 6.0 dB Double ridged horn antenna: ± 6.0 dB

Hermon Laboratories is accredited by A2LA for calibration according to present requirements of ISO/IEC 17025 and NCSL Z540-1. The accreditation is granted to perform calibration of parameters that are listed in the Scope of Hermon Laboratories Accreditation.

Hermon Laboratories calibrates its reference and transfer standards by calibration laboratories accredited to ISO/IEC 17025 by a mutually recognized Accreditation Body or by a recognized national metrology institute. All reference and transfer standards used in the calibration system are traceable to national or international standards.

In-house calibration of all test and measurement equipment is performed on a regular basis according to Hermon Laboratories calibration procedures, manufacturer calibration/verification procedures or procedures defined in the relevant standards. The Hermon Laboratories test and measurement equipment is calibrated within the tolerances specified by the manufacturers and/or by the relevant standards.

10 APPENDIX C Test laboratory description

Tests were performed at Hermon Laboratories Ltd., which is a fully independent, private, EMC, safety, environmental and telecommunication testing facility.

Hermon Laboratories is listed by the Federal Communications Commission (USA) for all parts of Code of Federal Regulations 47 (CFR 47), Registration Numbers 90624 for OATS and 90623 for the anechoic chamber; by Industry Canada for electromagnetic emissions (file numbers IC 2186A-1 for OATS), certified by VCCI, Japan (the registration numbers are R-808 for OATS, R-1082 for anechoic chamber, G-27 for full-anechoic chamber for RE measurements above 1 GHz, C-845 for conducted emissions site, T-1606 for conducted emissions at telecommunication ports), has a status of a Telefication - Listed Testing Laboratory, Certificate No. L138/00. The laboratory is accredited by American Association for Laboratory Accreditation (USA) according to ISO/IEC 17025 for electromagnetic compatibility, product safety, telecommunications testing and environmental simulation (for exact scope please refer to Certificate No. 839.01). The FCC Designation Number is US1003.

Address: P.O. Box 23, Binyamina 30500, Israel.
Telephone: +972 4628 8001
Fax: +972 4628 8277
e-mail: mail@hermonlabs.com
website: www.hermonlabs.com

Person for contact: Mr. Alex Usoskin, CEO.

11 APPENDIX D Specification references

47CFR part 15: 2014	Radio Frequency Devices.
FCC 47CFR part 2: 2014	Frequency allocations and radio treaty matters; general rules and regulations
ANSI C63.2: 1996	American National Standard for Instrumentation-Electromagnetic Noise and Field Strength, 10 kHz to 40 GHz-Specifications.
ANSI C63.4: 2003	American National Standard for Methods of Measurement of Radio-Noise Emissions from Low-Voltage Electrical and Electronic Equipment in the Range of 9 kHz to 40 GHz.
KDB200433 D02 RF Detector Method v01	Guidelines for compliance testing of millimeter wave devices subject to the RF detector measurement in sections 15.255 and 15.257
RSS-210 Issue 8: 2010	Low Power Licence- Exempt Radiocommunication Devices
RSS-Gen Issue 4: 2014	General Requirements for Compliance of Radio Apparatus



12 APPENDIX E Test equipment correction factors

Antenna Factor
Active Loop Antenna
EMC Test Systems, model 6502, S/N 2857, HL 0446

Frequency, MHz	Magnetic Antenna Factor, dB(S/m)	Electric Antenna Factor, dB(1/m)
0.009	-32.8	18.7
0.010	-33.8	17.7
0.020	-38.3	13.2
0.050	-41.1	10.4
0.075	-41.3	10.2
0.100	-41.6	9.9
0.150	-41.7	9.8
0.250	-41.6	9.9
0.500	-41.8	9.7
0.750	-41.9	9.6
1.000	-41.4	10.1
2.000	-41.5	10.0
3.000	-41.4	10.1
4.000	-41.4	10.1
5.000	-41.5	10.0
10.000	-41.9	9.6
15.000	-41.9	9.6
20.000	-42.2	9.3
25.000	-42.8	8.7
30.000	-44.0	7.5

Antenna factor in dB(S/m) is to be added to receiver meter reading in dB(μ V) to convert it into field intensity in dB(μ A/m).
Antenna factor in dB(1/m) is to be added to receiver meter reading in dB(μ V) to convert it into field intensity in dB(μ V/m).

Antenna factor
Standard gain horn antenna
Quinstar Technology
Model QWH
Ser.No.112, HL 0768, 0769, 0770, 0771, 0772

Frequency min, GHz	Frequency max, GHz	Antenna factor, dB(1/m)
18.000	26.500	32.01
26.500	40.000	35.48
40.000	60.000	39.03
60.000	90.000	42.55
90.000	140.000	46.23
140.000	220.000	50.11

Antenna factor in dB(1/m) is to be added to receiver meter reading in dB(μ V) to convert it into field intensity in dB(μ V/m).



Antenna factor
Biconilog antenna EMCO Model 3141
Ser.No.1011, HL 0604

Frequency, MHz	Antenna factor, dB(1/m)	Frequency, MHz	Antenna factor, dB(1/m)	Frequency, MHz	Antenna factor, dB(1/m)
26	7.8	580	20.6	1320	27.8
28	7.8	600	21.3	1340	28.3
30	7.8	620	21.5	1360	28.2
40	7.2	640	21.2	1380	27.9
60	7.1	660	21.4	1400	27.9
70	8.5	680	21.9	1420	27.9
80	9.4	700	22.2	1440	27.8
90	9.8	720	22.2	1460	27.8
100	9.7	740	22.1	1480	28.0
110	9.3	760	22.3	1500	28.5
120	8.8	780	22.6	1520	28.9
130	8.7	800	22.7	1540	29.6
140	9.2	820	22.9	1560	29.8
150	9.8	840	23.1	1580	29.6
160	10.2	860	23.4	1600	29.5
170	10.4	880	23.8	1620	29.3
180	10.4	900	24.1	1640	29.2
190	10.3	920	24.1	1660	29.4
200	10.6	940	24.0	1680	29.6
220	11.6	960	24.1	1700	29.8
240	12.4	980	24.5	1720	30.3
260	12.8	1000	24.9	1740	30.8
280	13.7	1020	25.0	1760	31.1
300	14.7	1040	25.2	1780	31.0
320	15.2	1060	25.4	1800	30.9
340	15.4	1080	25.6	1820	30.7
360	16.1	1100	25.7	1840	30.6
380	16.4	1120	26.0	1860	30.6
400	16.6	1140	26.4	1880	30.6
420	16.7	1160	27.0	1900	30.6
440	17.0	1180	27.0	1920	30.7
460	17.7	1200	26.7	1940	30.9
480	18.1	1220	26.5	1960	31.2
500	18.5	1240	26.5	1980	31.6
520	19.1	1260	26.5	2000	32.0
540	19.5	1280	26.6		
560	19.8	1300	27.0		

Antenna factor in dB(1/m) is to be added to receiver meter reading in dB(μV) to convert it into field intensity in dB(μV/m).



Antenna factor
Double-ridged waveguide horn antenna
ETS Lindgren, Model 3117, serial number: 00123515, HL 4114

Frequency, MHz	Antenna factor, dB/m		
	Measured	Manufacturer	Deviation
1000	28.0	28.4	-0.4
1500	28.0	27.4	0.6
2000	31.2	30.9	0.3
2500	32.5	33.4	-0.9
3000	32.9	32.6	0.3
3500	32.7	32.8	-0.1
4000	33.1	33.4	-0.3
4500	33.8	33.9	-0.1
5000	33.8	34.1	-0.3
5500	34.4	34.5	-0.1
6000	35.0	35.2	-0.2
6500	35.4	35.5	-0.1
7000	35.7	35.7	0.0
7500	35.9	35.7	0.2
8000	35.8	35.8	0.0
8500	35.9	35.8	0.1
9000	36.3	36.2	0.1
9500	36.6	36.6	0.0
10000	37.1	37.1	0.0
10500	37.6	37.5	0.1
11000	37.9	37.7	0.2
11500	38.5	38.1	0.4
12000	39.2	38.7	0.5
12500	39.0	38.9	0.1
13000	39.1	39.1	0.0
13500	38.9	38.8	0.1
14000	39.0	38.8	0.2
14500	39.6	39.9	-0.3
15000	39.9	39.7	0.2
15500	39.9	40.1	-0.2
16000	40.7	40.8	-0.1
16500	41.3	41.8	-0.5
17000	42.5	42.1	0.4
17500	41.3	41.2	0.1
18000	41.4	40.9	0.5

Antenna factor is to be added to receiver meter reading in dB(μ V) to convert to field strength in dB(μ V/meter)



Cable loss
Test Cable, Mini-Circuits, CBL-5FT-SMSM+, SMA-SMA, 18 GHz, 1.5 m
Mini-Circuits, HL 3433

Frequency, MHz	Cable loss, dB	Frequency, MHz	Cable loss, dB
10.0	0.06	9000	2.01
100	0.17	9500	2.06
500	0.41	10000	2.05
1000	0.58	10500	2.18
1500	0.72	11000	2.26
2000	0.86	11500	2.28
2500	0.96	12000	2.43
3000	1.04	12500	2.53
3500	1.13	13000	2.52
4000	1.23	13500	2.56
4500	1.31	14000	2.60
5000	1.41	14500	2.59
5500	1.49	15000	2.67
6000	1.55	15500	2.76
6500	1.63	16000	2.86
7000	1.71	16500	2.91
7500	1.78	17000	2.95
8000	1.86	17500	3.02
8500	1.92	18000	3.07



Cable loss
Test Cable, Mini-Circuits, CBL-5FT-SMSM+, SMA-SMA, 18 GHz, 1.5 m, S/N 25683
Mini-Circuits, HL 3434

Frequency, MHz	Cable loss, dB	Frequency, MHz	Cable loss, dB
10.0	0.06	9000	1.96
100	0.16	9500	2.01
500	0.40	10000	2.01
1000	0.57	10500	2.14
1500	0.72	11000	2.21
2000	0.85	11500	2.24
2500	0.95	12000	2.36
3000	1.03	12500	2.47
3500	1.11	13000	2.46
4000	1.21	13500	2.50
4500	1.29	14000	2.53
5000	1.39	14500	2.53
5500	1.46	15000	2.62
6000	1.52	15500	2.70
6500	1.60	16000	2.80
7000	1.68	16500	2.86
7500	1.75	17000	2.88
8000	1.83	17500	2.94
8500	1.88	18000	3.00



Cable loss
Microwave Cable Assembly, Huber-Suhner, 40 GHz, 3.5 m, SMA-SMA, S/N 1225/2A
HL 3901

Frequency, MHz	Cable loss, dB	Frequency, MHz	Cable loss, dB	Frequency, MHz	Cable loss, dB
10	0.09	9500	4.29	21000	6.67
100	0.41	10000	4.40	22000	6.92
500	0.93	10500	4.52	23000	7.00
1000	1.33	11000	4.64	24000	7.18
1500	1.63	11500	4.76	25000	7.29
2000	1.90	12000	4.87	26000	7.55
2500	2.12	12500	4.99	27000	7.70
3000	2.33	13000	5.11	28000	7.88
3500	2.50	13500	5.20	29000	8.02
4000	2.67	14000	5.31	30000	8.15
4500	2.82	14500	5.42	31000	8.35
5000	2.99	15000	5.51	32000	8.40
5500	3.16	15500	5.58	33000	8.62
6000	3.32	16000	5.68	34000	8.73
6500	3.51	16500	5.78	35000	8.78
7000	3.65	17000	5.91	36000	8.94
7500	3.79	17500	5.99	37000	9.21
8000	3.92	18000	6.07	38000	9.37
8500	4.04	19000	6.36	39000	9.45
9000	4.18	20000	6.49	40000	9.52



Cable loss
Microwave Cable Assembly, Huber-Suhner, 40 GHz, 1.5 m, SMA-SMA, S/N 1226/2A
HL 3903

Frequency, MHz	Cable loss, dB	Frequency, MHz	Cable loss, dB	Frequency, MHz	Cable loss, dB
10	-0.02	9500	1.84	21000	2.98
100	0.15	10000	1.86	22000	3.07
500	0.38	10500	1.93	23000	3.13
1000	0.56	11000	1.99	24000	3.21
1500	0.69	11500	2.04	25000	3.26
2000	0.82	12000	2.10	26000	3.48
2500	0.90	12500	2.15	27000	3.44
3000	0.98	13000	2.21	28000	3.53
3500	1.06	13500	2.25	29000	3.59
4000	1.11	14000	2.29	30000	3.66
4500	1.17	14500	2.34	31000	3.70
5000	1.24	15000	2.36	32000	3.79
5500	1.32	15500	2.40	33000	3.88
6000	1.40	16000	2.45	34000	3.94
6500	1.50	16500	2.48	35000	3.91
7000	1.56	17000	2.56	36000	4.05
7500	1.62	17500	2.58	37000	4.22
8000	1.68	18000	2.60	38000	4.25
8500	1.74	19000	2.84	39000	4.27
9000	1.78	20000	2.88	40000	4.33



Cable loss
Low Loss Armored Test Cable, MegaPhase, 18 GHz, 6.2 m, N type-M/N type-M,
NC29-N1N1-244S/N 12025101 003,
HL 4353

Frequency, MHz	Cable loss, dB	Frequency, MHz	Cable loss, dB
50	0.20	9000	2.71
100	0.27	9500	2.81
300	0.47	10000	2.90
500	0.61	10500	2.97
1000	0.87	11000	3.06
1500	1.07	11500	3.13
2000	1.24	12000	3.20
2500	1.39	12500	3.26
3000	1.53	13000	3.34
3500	1.65	13500	3.39
4000	1.77	14000	3.47
4500	1.89	14500	3.54
5000	1.99	15000	3.62
5500	2.07	15500	3.69
6000	2.20	16000	3.76
6500	2.30	16500	3.83
7000	2.39	17000	3.86
7500	2.51	17500	3.94
8000	2.58	18000	4.02
8500	2.65		



Cable loss
Low Loss Armored Test Cable, MegaPhase, 18 GHz, 6.2 m, N type-M/N type-M,
NC29-N1N1-244, S/N 51228701001
HL 4722

Frequency, MHz	Cable loss, dB	Frequency, MHz	Cable loss, dB
50	0.22	9000	2.93
100	0.30	9500	3.06
300	0.52	10000	3.16
500	0.66	10500	3.20
1000	0.93	11000	3.34
1500	1.15	11500	3.39
2000	1.33	12000	3.48
2500	1.49	12500	3.55
3000	1.64	13000	3.66
3500	1.77	13500	3.75
4000	1.90	14000	3.76
4500	2.03	14500	3.87
5000	2.17	15000	3.98
5500	2.30	15500	4.01
6000	2.39	16000	4.14
6500	2.51	16500	4.15
7000	2.59	17000	4.32
7500	2.67	17500	4.36
8000	2.76	18000	4.38
8500	2.84		



13 APPENDIX F Abbreviations and acronyms

A	ampere
AC	alternating current
A/m	ampere per meter
AM	amplitude modulation
AVRG	average (detector)
CBW	channel bandwidth
cm	centimeter
dB	decibel
dBm	decibel referred to one milliwatt
dB(μ V)	decibel referred to one microvolt
dB(μ V/m)	decibel referred to one microvolt per meter
dB(μ A)	decibel referred to one microampere
DC	direct current
EBW	emission bandwidth
EIRP	equivalent isotropically radiated power
ERP	effective radiated power
EUT	equipment under test
F	frequency
GHz	gigahertz
GND	ground
H	height
HL	Hermon laboratories
Hz	hertz
k	kilo
kHz	kilohertz
LO	local oscillator
m	meter
MHz	megahertz
min	minute
mm	millimeter
ms	millisecond
μ s	microsecond
NA	not applicable
NB	narrow band
OATS	open area test site
Ω	Ohm
QP	quasi-peak
PM	pulse modulation
PS	power supply
RE	radiated emission
RF	radio frequency
rms	root mean square
Rx	receive
s	second
T	temperature
Tx	transmit
V	volt
VA	volt-ampere

END OF DOCUMENT