



Prüfbericht-Nr.: <i>Test report no.:</i>	CN22BQH3 (P15C-RFID) 001	Auftrags-Nr.: <i>Order no.:</i>	238545426	Seite 1 von 25 Page 1 of 25
Kunden-Referenz-Nr.: <i>Client reference no.:</i>	N/A	Auftragsdatum: <i>Order date:</i>	2022-07-11	
Auftraggeber: <i>Client:</i>	Vecos Europe B.V. Esp 237, 5633 AD Eindhoven, The Netherlands			
Prüfgegenstand: <i>Test item:</i>	Locker Lock V3+Legic			
Bezeichnung / Typ-Nr.: <i>Identification / Type no.:</i>	V3+Legic			
Auftrags-Inhalt: <i>Order content:</i>	FCC Part 15C Test report (RFID)			
Prüfgrundlage: <i>Test specification:</i>	FCC 47CFR Part 15: Subpart C Section 15.225			
Wareneingangsdatum: <i>Date of sample receipt:</i>	2022-07-13			
Prüfmuster-Nr.: <i>Test sample no.:</i>	A003299983-010			
Prüfzeitraum: <i>Testing period:</i>	2022-08-20 - 2022-11-08			
Ort der Prüfung: <i>Place of testing:</i>	EMC/RF Taipei Testing Site			
Prüflaboratorium: <i>Testing laboratory:</i>	Taipei Testing Laboratories			
Prüfergebnis*: <i>Test result*:</i>	Pass			
zusammengestellt von: <i>compiled by:</i>	genehmigt von: <i>authorized by:</i>			
Datum: <i>Date:</i> 2022-11-11	 Jack Wang		 Brenda Chen	
Stellung / Position:	Project Manager		Senior Project Manager	
Sonstiges / Other:	The EUT supports Tx function only.			
Zustand des Prüfgegenstandes bei Anlieferung: <i>Condition of the test item at delivery:</i>	Prüfmuster vollständig und unbeschädigt <i>Test item complete and undamaged</i>			
* Legende:	1 = sehr gut P(ass) = entspricht o.g. Prüfgrundlage(n)	2 = gut F(ail) = entspricht nicht o.g. Prüfgrundlage(n)	3 = befriedigend N/A = nicht anwendbar	4 = ausreichend N/T = nicht getestet
* Legend:	1 = very good P(ass) = passed a.m. test specification(s)	2 = good F(ail) = failed a.m. test specification(s)	3 = satisfactory N/A = not applicable	4 = sufficient N/T = not tested
Dieser Prüfbericht bezieht sich nur auf das o.g. Prüfmuster und darf ohne Genehmigung der Prüfstelle nicht auszugsweise vervielfältigt werden. Dieser Bericht berechtigt nicht zur Verwendung eines Prüfzeichens. <i>This test report only relates to the a. m. test sample. Without permission of the test center this test report is not permitted to be duplicated in extracts. This test report does not entitle to carry any test mark.</i>				

V05

TEST SUMMARY

Report Section	FCC Clause	Test Item	Result
5.1.1	15.203	Antenna Requirement	Pass
5.1.2	15.225 (a)(b)(c)	Field Strength of Fundamental Emissions	Pass
5.1.3	15.225 (d)	Radiated Spurious Emissions	Pass
5.1.4	15.225 (e)	Frequency Stability	Pass
5.1.5	15.215 (c)	20 dB Bandwidth	Pass
5.1.5	2.1049	99% Occupied Bandwidth	Pass
5.2.1	15.207	Mains Conducted Emission	Pass

Note: Determining compliance based on the results of the compliance measurement, not taking into account measurement instrumentation uncertainty.

Contents

HISTORY OF THIS TEST REPORT	4
1. GENERAL REMARKS	5
1.1 COMPLEMENTARY MATERIALS.....	5
1.2 DECISION RULE OF CONFORMITY	5
2. TEST SITES	6
2.1 TEST LABORATORY	6
2.2 TEST FACILITY.....	6
2.3 TRACEABILITY	7
2.4 CALIBRATION	7
2.5 MEASUREMENT UNCERTAINTY	7
3. GENERAL PRODUCT INFORMATION.....	8
3.1 PRODUCT FUNCTION AND INTENDED USE	8
3.2 SYSTEM DETAILS AND RATINGS.....	8
3.3 NOISE GENERATING AND NOISE SUPPRESSING PARTS	9
3.4 SUBMITTED DOCUMENTS.....	9
4. TEST SET-UP AND OPERATION MODES.....	10
4.1 PRINCIPLE OF CONFIGURATION SELECTION	10
4.2 TEST OPERATION AND TEST SOFTWARE.....	10
4.3 SPECIAL ACCESSORIES AND AUXILIARY EQUIPMENT	11
4.4 TEST SETUP DIAGRAM	12
5. TEST RESULTS	13
5.1 TRANSMITTER REQUIREMENT & TEST SUITES	13
5.1.1 <i>Antenna Requirement</i>	<i>13</i>
5.1.2 <i>Field Strength of Fundamental Emissions</i>	<i>14</i>
5.1.3 <i>Radiated Spurious Emissions</i>	<i>17</i>
5.1.4 <i>Frequency Stability.....</i>	<i>20</i>
5.1.5 <i>20 dB Bandwidth and 99% Occupied Bandwidth.....</i>	<i>22</i>
5.2 MAINS EMISSIONS.....	24
5.2.1 <i>Mains Conducted Emissions.....</i>	<i>24</i>
 APPENDIX A - TEST RESULT OF RADIATED EMISSIONS & MAINS CONDUCTED EMISSION	
APPENDIX SP - PHOTOGRAPHS OF TEST SETUP	
APPENDIX EP - PHOTOGRAPHS OF EUT	

HISTORY OF THIS TEST REPORT

Report No.	Description	Date Issued
CN22BQH3 (P15C-RFID) 001	Original Release	2022-11-11

1. General Remarks

1.1 Complementary Materials

The following attachments are integral parts of this test report:

Appendix A - Test Result of Radiated Emissions & Mains Conducted Emission
Appendix SP - Photographs of Test Setup
Appendix EP - Photographs of EUT

Test Specifications

The following standards were applied.

Applied Standard and Test Levels

Radio
FCC 47CFR Part 15: Subpart C Section 15.225
FCC 47CFR Part 2: Subpart J Section 2.1049
ANSI C63.10:2013

1.2 Decision Rule of Conformity

The decision rule of conformity of this test report is following the requirements of the requested standard in the quotation, and agreed among testing laboratory and manufacturer (applicant) to exclude the consideration of Measurement Uncertainty, unless it is required by the specific standard.

2. Test Sites

2.1 Test Laboratory

Taipei Testing Laboratories

11F. No.758, Sec. 4, Bade Rd., Songshan Dist.
Taipei City 105
Taiwan (R.O.C.)

2.2 Test Facility

Taipei Testing Laboratories

No.458-18, Sec. 2, Fenliao Rd., Linkou Dist.,
New Taipei City 244
Taiwan (R.O.C.)
FCC Registration No.: 180491
ISED Registration No.: 25563

2.3 Traceability

All measurement equipment calibrations are traceable to NML(Taiwan)/NIST(USA) or where calibration is performed outside Taiwan, to equivalent nationally recognized standards organizations.

2.4 Calibration

Equipment requiring calibration is calibrated periodically in a suitably accredited Calibration Lab. Additionally all equipment is verified for proper performance on a regular basis using in house standards or comparisons.

2.5 Measurement Uncertainty

All measurement uncertainty values are shown with a coverage factor of $k=2$ to indicate a 95% level of confidence.

Emission Measurement Uncertainty

Parameter	Uncertainty
Radiated Emission (9 kHz ~ 30 MHz)	± 1.15 dB
Radiated Emission (30 MHz ~ 200 MHz)	± 1.30 dB
Radiated Emission (200 MHz ~ 1 GHz)	± 1.30 dB
Mains Conducted Emission	± 1.65 dB

3. General Product Information

3.1 Product Function and Intended Use

The EUT is a Locker Lock V3+Legic with RFID function.
For details refer to the User Guide, Data Sheet and Circuit Diagram.

3.2 System Details and Ratings

Basic Information of EUT

Item	EUT information
Kind of Equipment/Test Item	Locker Lock V3+Legic
Type Identification	V3+Legic
FCC ID	2ACYAV3LEGIC

Technical Specification of EUT

Item	EUT information
Operating Frequency	13.56 MHz
Operation Voltage	110Vac (27Vdc to EUT)
Modulation	ASK
Field Strength	70.24 (dBuV/m) @ 3m
Antenna Information	Refer to 5.1.1
Accessory Device	Refer to 4.3

3.3 Noise Generating and Noise Suppressing Parts

Refer to the Circuit Diagram.

3.4 Submitted Documents

- Circuit Diagram
- Instruction Manual
- Rating Label
- Technical Description

4. Test Set-up and Operation Modes

4.1 Principle of Configuration Selection

The equipment under test (EUT) was configured to measure its maximum emission level. The test modes were adapted accordingly in reference to the instructions for use.

4.2 Test Operation and Test Software

Setup for testing: The EUT's RFID reader is permanently opened. While the sensor card is approaching RFID reader, it continuously transmits.

Test Software	None.
---------------	-------

The samples were used as follows:

A003299983-010

Full test was applied on all test modes, but only worst case was shown.

EUT Configure Mode	Applicable To				Description
	Radiated Spurious Emissions	Frequency Stability	20 dB Bandwidth and 99% Occupied Bandwidth	Mains Conducted Emission	
-	√	√	√	√	-

Note:

1. The EUT had been pre-tested on the positioned of each 3 axis. The worst case was found when position on Y-plane.
2. "-" means no effect.
3. The tests are using by the worst case power supply (model no. HLG-480H-30TE11).

Radiated Spurious Emissions

- Pre-Scan full test was applied on all test modes, but only worst case was shown.
- Following channel(s) was (were) selected for the final test as listed below.

EUT Configure Mode	Available Frequency (MHz)	Tested Frequency (MHz)
	Tx / Rx	
-	13.56	13.56

Frequency Stability

- Pre-Scan full test was applied on all test modes, but only worst case was shown.
- Following channel(s) was (were) selected for the final test as listed below.

EUT Configure Mode	Available Frequency (MHz)	Tested Frequency (MHz)
-	13.56	13.56

20 dB Bandwidth and 99% Occupied Bandwidth

- Pre-Scan full test was applied on all test modes, but only worst case was shown.
- Following channel(s) was (were) selected for the final test as listed below.

EUT Configure Mode	Available Frequency (MHz)	Tested Frequency (MHz)
-	13.56	13.56

Mains Conducted Emission

- Pre-Scan full test was applied on all test modes, but only worst case was shown.
- Following channel(s) was (were) selected for the final test as listed below.

EUT Configure Mode	Available Frequency (MHz)	Tested Frequency (MHz)
-	13.56	13.56

Test Condition

Test Item	Ambient Temperature	Relative Humidity	Tested by
Radiated Spurious Emissions	21.1-21.9 °C	60-64 %	Ivan Chiang
Frequency Stability	24.2 °C	63.5 %	Andy Chen
20 dB Bandwidth and 99% Occupied Bandwidth	24.2 °C	63.5 %	Andy Chen
Mains Conducted Emission	21.9 °C	59 %	Ray Huang

4.3 Special Accessories and Auxiliary Equipment

The product has been tested together with the following additional accessories:

Accessory of EUT

No.	Product	Brand	Model	Description
-	Power Supply	Meanwell	HLG-185H-24TE11	-
-	Power Supply	Meanwell	HLG-480H-30TE11	-
-	Power Supply	Meanwell	HEP-185-24A	-
-	Power Supply	Meanwell	HEP-240-24A	-
-	Power Supply	Meanwell	HEP-320-24A	-
-	Power Supply	Meanwell	HEP-480-24A	-
-	Controller	VECOS	HUB V3-24	-
-	Touch Screen Terminal	VECOS	LBC 3.0	-

Support Unit

No.	Description	Brand	Model	S/N	Remark
Raidated Test					
A	Power Cable	VECOS	VECOS-001	-	150 cm shielded cable w/o core
B	Box	VECOS	VECOS-002	-	-
C	RFID Card	VECOS	VECOS-003	-	-
1	Power Extension Cord	TUV	TUV-01	-	150 cm non-shielded cable w/o core
Mains Conducted Test					
A	TYPE C Cable	TUV SH	TUV SH-01	-	200 cm shielded cable w/o core
1	Adapter	HP	PPP009D	-	179 cm shielded cable w/o core
2	Notebook	Lenovo	81BL	MP1DCD6Y	-
3	Uart	TUV	TUV-001	-	-

4.4 Test Setup Diagram

<Radiated Spurious Emissions mode>

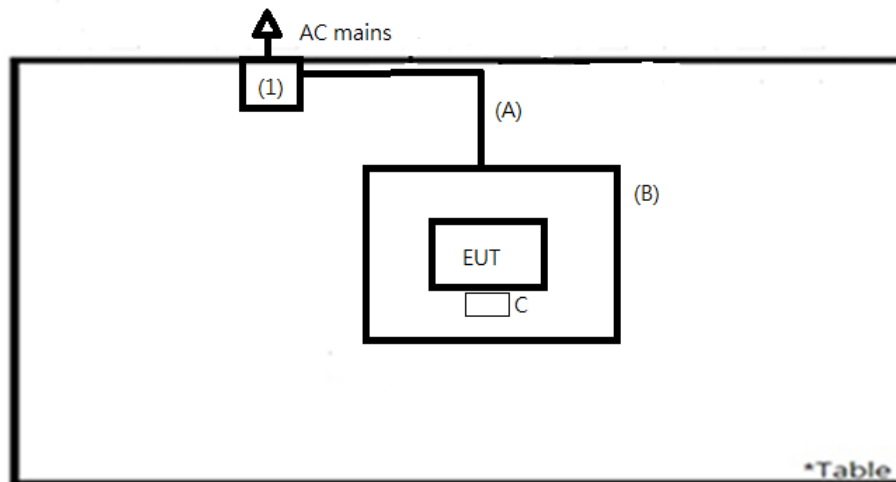

<Mains Conducted Emission mode>

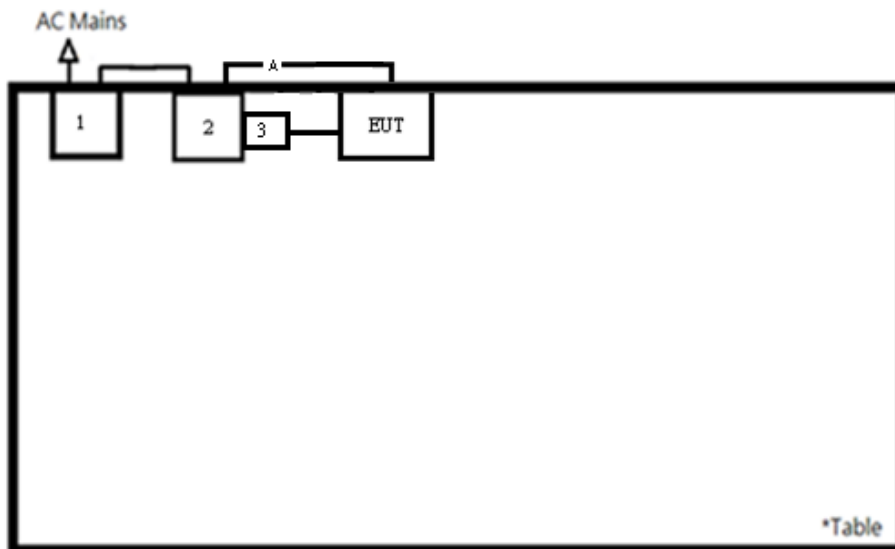

5. Test Results

5.1 Transmitter Requirement & Test Suites

5.1.1 Antenna Requirement

Requirement Use of approved antennas only

The antenna is a loop antenna with no possibility of replacement with a non-approved antenna by the end-user. Therefore, the EUT is considered to comply with this provision.
Refer to EUT photo for details.

5.1.2 Field Strength of Fundamental Emissions

Limit

- The field strength of any emissions within the band 13.553-13.567 MHz shall not exceed 15,848 microvolts/meter at 30 meters.
- Within the bands 13.410-13.553 MHz and 13.567-13.710 MHz, the field strength of any emissions shall not exceed 334 microvolts/meter at 30 meters.
- Within the bands 13.110-13.410 MHz and 13.710-14.010 MHz the field strength of any emissions shall not exceed 106 microvolts/meter at 30 meters.

Kind of Test Site 3m Semi-Anechoic Chamber

Test Setup

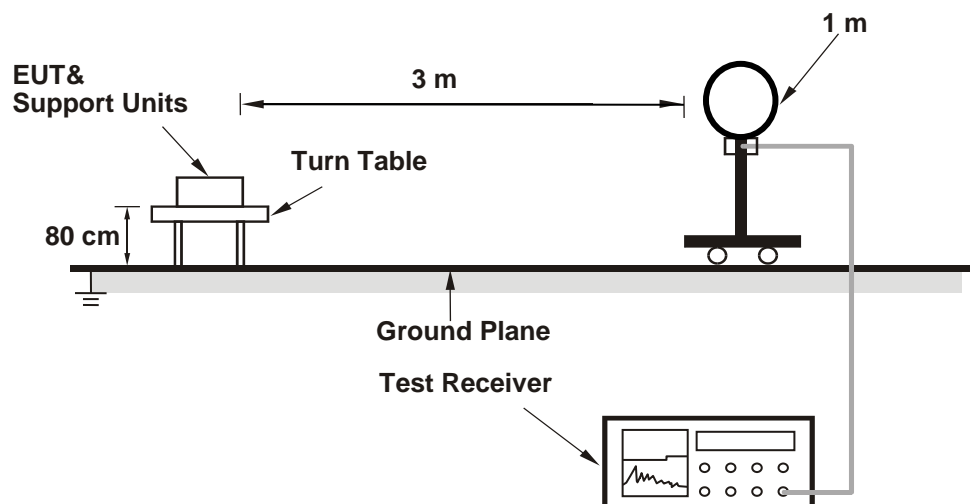

For the actual test configuration, please refer to the attached file (Test Setup Photo).

Test Instruments

Test Date: 2022/11/08

Kind of Equipment	Manufacturer	Type	S/N	Calibration Date	Calibration Due Date
Below 30MHz					
Receiver	R&S	ESR7	102108	2022/4/28	2023/4/27
Microwave Cable	SUCOFLEX 104EA	800056/4EA	804680/4	2022/3/22	2023/3/21
Loop Antenna	SCHWARZBECK	FMZB 1519B	00215	2021/12/8	2022/12/7
30MHz-1GHz					
Receiver	R&S	ESR7	102108	2022/4/28	2023/4/27
Bilog Antenna	SCHWARZBECK	VULB-9168	00951	2022/4/6	2023/4/5
LF-AMP	Agilent	8447D	2944A107722	2022/3/22	2023/3/21

Test Procedures

- a. The EUT was placed on the top of a rotating table 0.8 meters above the ground at a 3 meter chamber room. The table was rotated 360 degrees to determine the position of the highest radiation.
- b. The EUT was set 3 meters away from the interference-receiving antenna, which was mounted on the top of a variable-height antenna tower.
- c. Parallel (OPEN), perpendicular (CLOSE), and ground-parallel (GROUND) orientations of the antenna are set to make the measurement.
- d. For each suspected emission, the EUT was arranged to its worst case and the rotatable table was turned from 0 degrees to 360 degrees to find the maximum reading.
- e. The test-receiver system was set to Quasi-Peak Detect Function and Specified Bandwidth with Maximum Hold Mode.

Note: The resolution bandwidth and video bandwidth of test receiver/spectrum analyzer is 9 kHz at frequency below 30 MHz.

Test Results

Factor (dB/m) = Antenna Factor (dB/m) + Cable Loss (dB)

Level (dBuV/m) = Reading (dBuV) + Factor (dB/m)

Limit at 30m = 15848 (uV/m)

**Limit at 3m = $20 \cdot \log(15848) + 40 \log(30\text{m}/3\text{m})$ (dBuV/m)
= 84+40 (dBuV/m)
= 124 (dBuV/m)

Please refer to Appendix A.

5.1.3 Radiated Spurious Emissions

Limit

The field strength of any emissions appearing outside of the 13.110-14.010 MHz band shall not exceed the general radiated emission limits in §15.209 as below table:

Frequencies (MHz)	Field Strength (microvolts/meter)	Measurement Distance (meters)
0.009 ~ 0.490	2400/F (kHz)	300
0.490 ~ 1.705	24000/F (kHz)	30
1.705 ~ 30.0	30	30
30 ~ 88	100	3
88 ~ 216	150	3
216 ~ 960	200	3
Above 960	500	3

Kind of Test Site 3m Semi-Anechoic Chamber

Test Setup

<Radiated Emissions below 30 MHz>

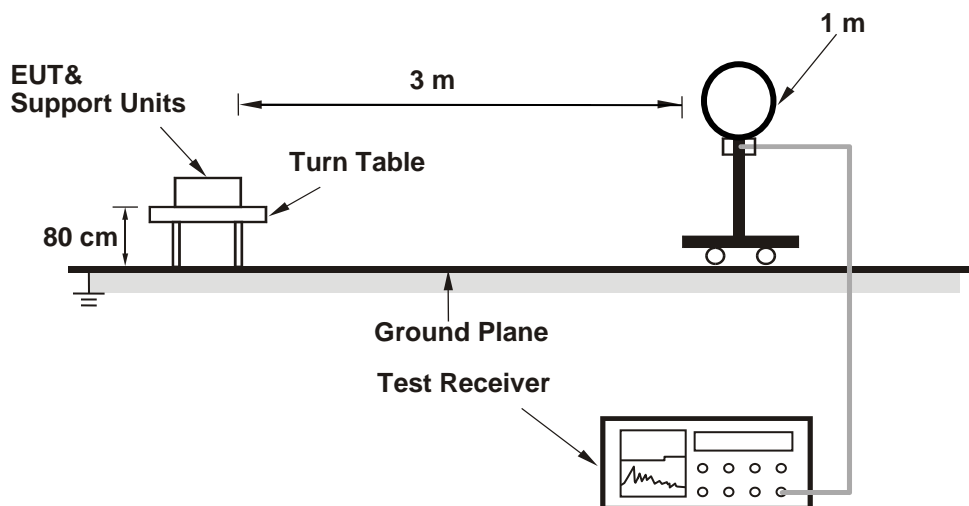

<Radiated Emissions 30 MHz to 1 GHz>

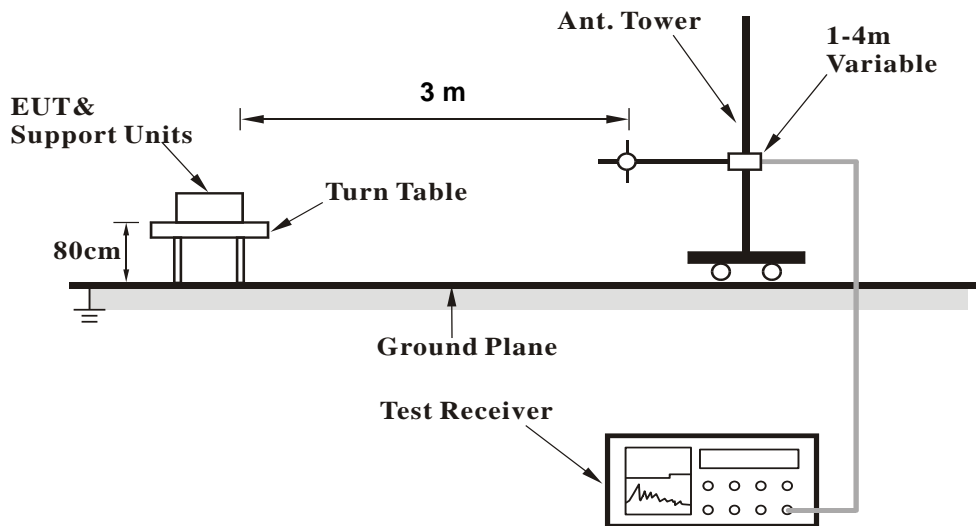

For the actual test configuration, please refer to the attached file (Test Setup Photo).

Test Instruments

Please refer to 5.1.2 Instruments

Test Procedures**For Radiated Emissions below 30 MHz**

- a. The EUT was placed on the top of a rotating table 0.8 meters above the ground at a 3 meter chamber room. The table was rotated 360 degrees to determine the position of the highest radiation.
- b. The EUT was set 3 meters away from the interference-receiving antenna, which was mounted on the top of a variable-height antenna tower.
- c. Parallel (OPEN), perpendicular (CLOSE), and ground-parallel (GROUND) orientations of the antenna are set to make the measurement.
- d. For each suspected emission, the EUT was arranged to its worst case and the rotatable table was turned from 0 degrees to 360 degrees to find the maximum reading.
- e. The test-receiver system was set to Quasi-Peak Detect Function and Specified Bandwidth with Maximum Hold Mode.

Note:

1. The resolution bandwidth and video bandwidth of test receiver/spectrum analyzer is 9 kHz at frequency below 30 MHz.
2. All modes of operation were investigated and the worst-case emissions are reported.

For Radiated Emissions above 30 MHz

- a. The EUT was placed on the top of a rotating table 0.8 meters (for 30 MHz ~ 1 GHz) / 1.5 meters (for above 1 GHz) above the ground at 3 meter chamber room for test. The table was rotated 360 degrees to determine the position of the highest radiation.
- b. The EUT was set 3 meters away from the interference-receiving antenna, which was mounted on the top of a variable-height antenna tower.
- c. The height of antenna is varied from one meter to four meters above the ground to determine the maximum value of the field strength. Both horizontal and vertical polarizations of the antenna are set to make the measurement.
- d. For each suspected emission, the EUT was arranged to its worst case and then the antenna was tuned to heights from 1 meter to 4 meters and the rotatable table was turned from 0 degrees to 360 degrees to find the maximum reading.
- e. The test-receiver system was set to quasi-peak detect function and specified bandwidth with maximum hold mode when the test frequency is below 1 GHz.
- f. The test-receiver system was set to peak and average detected function and specified bandwidth with maximum hold mode when the test frequency is above 1 GHz. If the peak reading value also meets average limit, measurement with the average detector is unnecessary.

Note:

1. The resolution bandwidth and video bandwidth of test receiver/spectrum analyzer is 120 kHz for Quasi-peak detection (QP) or Peak detection (PK) at frequency below 1 GHz.
2. All modes of operation were investigated and the worst-case emissions are reported.
3. The Radiated Emissions testing was performed in the X(E1), Y(H) and Z(E2) axis orientation. The worst-case Axis orientation is recorded in this test report.
4. The calculation formula is explained as follows:

$$\text{Factor (dB/m)} = \text{Antenna Factor (dB/m)} + \text{Cable Loss (dB)}$$

$$\text{Level (dBuV/m)} = \text{Reading (dBuV)} + \text{Factor (dB/m)}$$

Test Results

Please refer to Appendix A.

5.1.4 Frequency Stability

Limit

The frequency tolerance of the carrier signal shall be maintained within +/- 0.01 % of the operating frequency over a temperature variation of -20 degrees to 50 degrees C at normal supply voltage, and for a variation in the primary supply voltage from 85 % to 115 % of the rated supply voltage at a temperature of 20 degrees C.

Kind of Test Site Shielded room

Test Setup

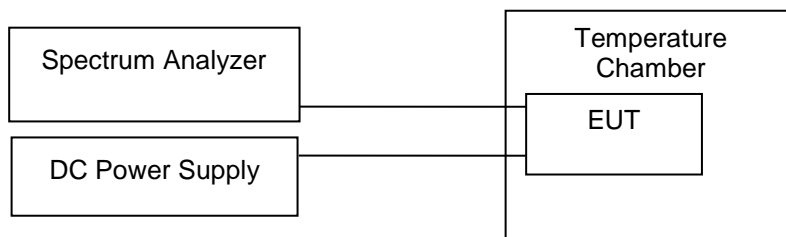

Test Instruments

Kind of Equipment	Manufacturer	Type	S/N	Calibration Date	Calibration Due Date	Test Date	
						From	Until
Spectrum Analyzer	R&S	FSV40	101512	2022/2/24	2023/2/23	2022/8/31	2022/8/31
Thermal Chamber	Giant Force	GHT-150-40-CP-SD	MAA1902-010	2022/3/2	2023/3/1	2022/8/31	2022/8/31

Test Procedures

- a. The EUT was placed inside the environmental test chamber and powered by nominal DC voltage.
- b. Turned the EUT on and coupled its output to a spectrum analyzer.
- c. Turned the EUT off and set the chamber to the highest temperature specified.
- d. Allowed sufficient time (approximately 30 min) for the temperature of the chamber to stabilize then turned the EUT on and measured the operating frequency after 2, 5, and 10 minutes.
- e. Repeated step b and c with the temperature chamber set to the lowest temperature.
- f. The test chamber was allowed to stabilize at +20 degree C for a minimum of 30 minutes. The supply voltage was then adjusted on the EUT from 85 % to 115 % and the frequency record.

Test Result

Frequency (MHz)		13.56							
Condition		Test Time				Frequency Error (ppm)			
Extreme	Modulation Mode	0 min	2 min	5 min	10 min	0 min	2 min	5 min	10 min
T _{20°C} V _{max}	CW	13.55981	13.55981	13.55981	13.55981	-13.86	-13.86	-13.86	-13.86
T _{20°C} V _{min}	CW	13.55983	13.55981	13.55981	13.55981	-12.83	-13.86	-13.86	-13.86
T _{50°C} V _{nom}	CW	13.55980	13.55980	13.55978	13.55978	-14.97	-14.97	-16.00	-16.00
T _{40°C} V _{nom}	CW	13.55982	13.55982	13.55982	13.55982	-13.32	-13.32	-13.32	-13.32
T _{30°C} V _{nom}	CW	13.55983	13.55983	13.55983	13.55983	-12.34	-12.34	-12.34	-12.34
T _{20°C} V _{nom}	CW	13.55984	13.55984	13.55983	13.55983	-11.73	-11.73	-12.83	-12.83
T _{10°C} V _{nom}	CW	13.55985	13.55985	13.55985	13.55985	-10.84	-10.84	-10.84	-10.84
T _{0°C} V _{nom}	CW	13.55989	13.55989	13.55989	13.55989	-7.97	-7.97	-7.97	-7.97
T _{-10°C} V _{nom}	CW	13.56001	13.56001	13.56001	13.56001	0.64	0.64	0.64	0.64
T _{-20°C} V _{nom}	CW	13.56003	13.56004	13.56004	13.56004	2.14	3.17	3.17	3.17
Limit (ppm)		-				100			
Result		Pass							

5.1.5 20 dB Bandwidth and 99% Occupied Bandwidth

Limit

The 20 dB bandwidth shall be specified in operating frequency band.

Kind of Test Site Shielded room

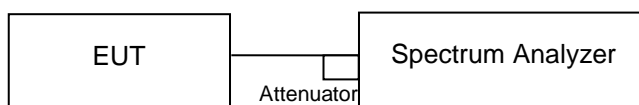
Test Setup

Test Instruments

Kind of Equipment	Manufacturer	Type	S/N	Calibration Date	Calibration Due Date	Test Date	
						From	Until
Spectrum Analyzer	R&S	FSV40	101512	2022/2/24	2023/2/23	2022/8/31	2022/8/31
Thermal Chamber	Giant Force	GHT-150-40-CP-SD	MAA1902-010	2022/3/2	2023/3/1	2022/8/31	2022/8/31

Test Procedure
<20 dB Bandwidth>

The bandwidth of the fundamental frequency was measured by spectrum analyzer with 1 kHz RBW and 3 kHz VBW. The 20 dB bandwidth is defined as the total spectrum the power of which is higher than peak power minus 20 dB.

<99% Occupied Bandwidth>

The transmitter output was connected to the spectrum analyzer through an attenuator. The bandwidth of the fundamental frequency was measured by spectrum analyzer with resolution bandwidth in the range of 1 % to 5 % of the anticipated emission bandwidth, and a video bandwidth at least 3x the resolution bandwidth and set the detector to Sampling. The width of a frequency band such that, below the lower and above the upper frequency limits, the mean powers emitted are each equal to a specified percentage 0.5 % of the total mean power of a given emission.

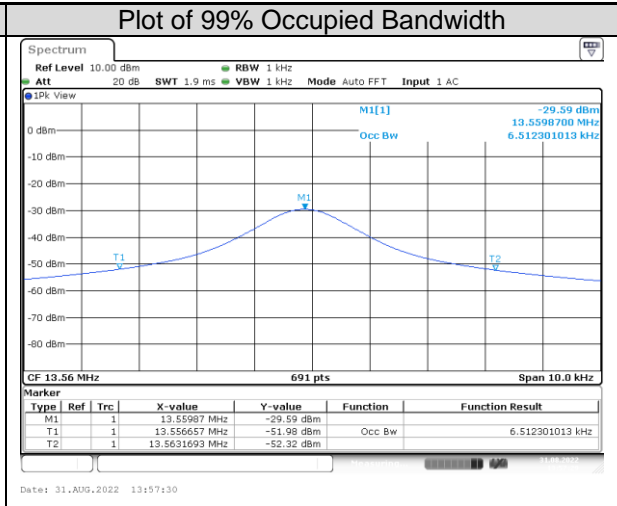
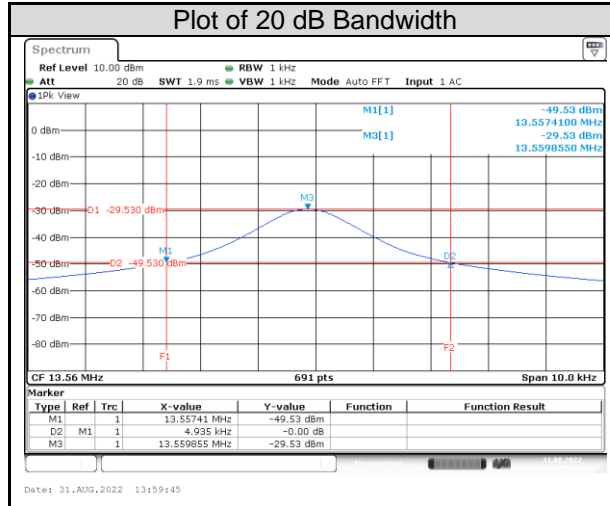
Test Results

5.2 Mains Emissions

5.2.1 Mains Conducted Emissions

Limit

Mains Conducted emissions as defined in §15.207 must comply with the mains conducted emission limits.

Kind of Test Site Shielded room

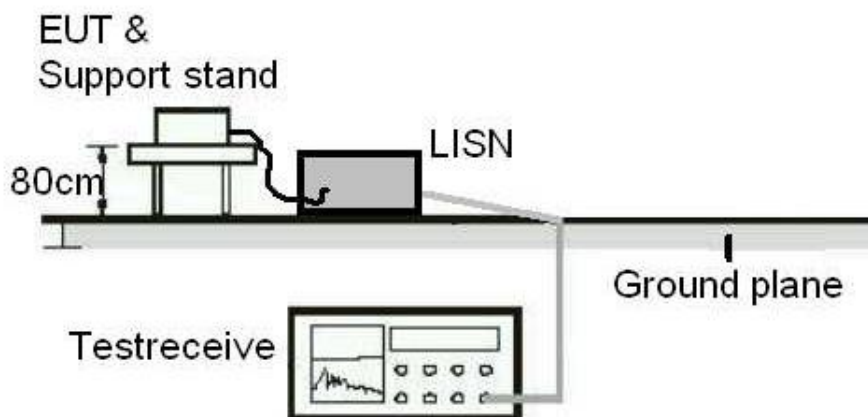
Test Setup

Test Instruments

Test Date: 2022/9/7

Kind of Equipment	Manufacturer	Type	S/N	Calibration Date	Calibration Due Date
Two-Line V-Network	Rohde & Schwarz	ENV216	101938	2021/9/23	2022/9/22
EMI Test Receiver	R&S	ESCI	1816063	2021/11/15	2022/11/14

Test Procedures

- a. The EUT was placed 0.4 meters from the conducting wall of the shielded room with EUT being connected to the power mains through a line impedance stabilization network (LISN). Other support units were connected to the power mains through another LISN. The two LISNs provide 50 ohm/50 uH of coupling impedance for the measuring instrument.
- b. Both lines of the power mains connected to the EUT were checked for maximum conducted interference.
- c. The frequency range from 150 kHz to 30 MHz was searched. Emission levels under (Limit – 20 dB) was not recorded.

Note: The resolution bandwidth and video bandwidth of test receiver is 9 kHz for quasi-peak detection (QP) and average detection (AV) at frequency 0.15 MHz – 30 MHz.

Test Results

Please refer to Appendix A.

Appendix A: Test Results of Radiated Spurious Emissions & Mains

Conducted Emission Test

Fundamental Emissions, 13.56MHz

Open		Close																																																																			
<p>TUV Rheinland Taiwan Ltd. No. 438-18, Sec. 2, Fenliiao, Linkou Dist., New Taipei City 244, Taiwan(R.O.C.) Tel:+886-2172-1000 Fax:+886-2172-1322</p>		<p>TUV Rheinland Taiwan Ltd. No. 438-18, Sec. 2, Fenliiao, Linkou Dist., New Taipei City 244, Taiwan(R.O.C.) Tel:+886-2172-1000 Fax:+886-2172-1322</p>																																																																			
<table border="1"> <thead> <tr> <th>Freq</th> <th>Level</th> <th>Read Level</th> <th>Factor</th> <th>Limit Line</th> <th>Over Limit</th> <th>APos</th> <th>TPos</th> <th>Remark</th> <th>Pol/Phase</th> <th>Note</th> </tr> <tr> <th>MHz</th> <th>dBuV/m</th> <th>dBuV</th> <th>dB/m</th> <th>dBuV/m</th> <th>dB</th> <th>cm</th> <th>deg</th> <th></th> <th></th> <th></th> </tr> </thead> <tbody> <tr> <td>1</td> <td>13.56</td> <td>70.24</td> <td>69.70</td> <td>0.54</td> <td>124.00</td> <td>-53.76</td> <td>100</td> <td>52 QP</td> <td>Open</td> <td></td> </tr> </tbody> </table>		Freq	Level	Read Level	Factor	Limit Line	Over Limit	APos	TPos	Remark	Pol/Phase	Note	MHz	dBuV/m	dBuV	dB/m	dBuV/m	dB	cm	deg				1	13.56	70.24	69.70	0.54	124.00	-53.76	100	52 QP	Open		<table border="1"> <thead> <tr> <th>Freq</th> <th>Level</th> <th>Read Level</th> <th>Factor</th> <th>Limit Line</th> <th>Over Limit</th> <th>APos</th> <th>TPos</th> <th>Remark</th> <th>Pol/Phase</th> <th>Note</th> </tr> <tr> <th>MHz</th> <th>dBuV/m</th> <th>dBuV</th> <th>dB/m</th> <th>dBuV/m</th> <th>dB</th> <th>cm</th> <th>deg</th> <th></th> <th></th> <th></th> </tr> </thead> <tbody> <tr> <td>1</td> <td>13.56</td> <td>70.02</td> <td>69.48</td> <td>0.54</td> <td>124.00</td> <td>-53.98</td> <td>100</td> <td>33 QP</td> <td>Close</td> <td></td> </tr> </tbody> </table>		Freq	Level	Read Level	Factor	Limit Line	Over Limit	APos	TPos	Remark	Pol/Phase	Note	MHz	dBuV/m	dBuV	dB/m	dBuV/m	dB	cm	deg				1	13.56	70.02	69.48	0.54	124.00	-53.98	100	33 QP	Close	
Freq	Level	Read Level	Factor	Limit Line	Over Limit	APos	TPos	Remark	Pol/Phase	Note																																																											
MHz	dBuV/m	dBuV	dB/m	dBuV/m	dB	cm	deg																																																														
1	13.56	70.24	69.70	0.54	124.00	-53.76	100	52 QP	Open																																																												
Freq	Level	Read Level	Factor	Limit Line	Over Limit	APos	TPos	Remark	Pol/Phase	Note																																																											
MHz	dBuV/m	dBuV	dB/m	dBuV/m	dB	cm	deg																																																														
1	13.56	70.02	69.48	0.54	124.00	-53.98	100	33 QP	Close																																																												

Ground



TUV Rheinland Taiwan Ltd.
No. 458-18, Sec 2, Fenlian, Linkou Dist., New Taipei City 244, Taiwan(R.O.C.)
Tel: +886-2172-1000 Fax: +886-2172-1322

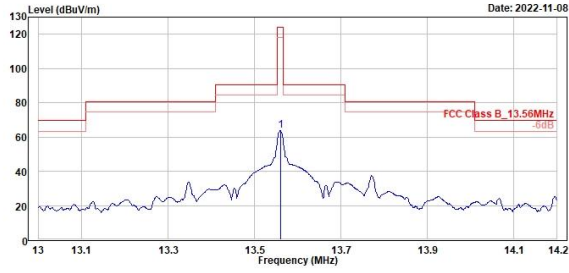

Item	Freq	Level	Read Level	Factor	Limit Line	Over Limit	APos	TPos	Remark	Pol/Phase	Note
	MHz	dBuV/m	dBuV	dB/m	dBuV/m	dB	cm	deg			
1	13.56	63.82	63.28	0.54	124.00	-60.18	100	20	QP	Ground	

Spurious Emissions, Tx Mode, 9kHz ~ 30MHz
9kHz~150kHz(Open)
150kHz~30MHz(Open)

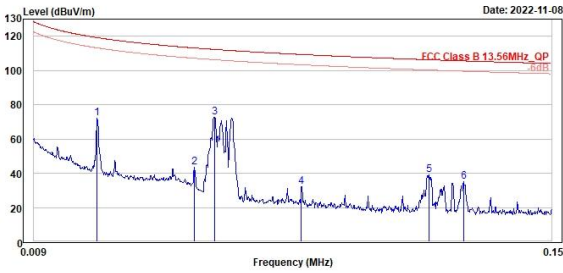

TUV Rheinland Taiwan Ltd.
 No. 458-18, Sec. 2, Fenliao, Linkou Dist., New Taipei City 244, Taiwan(R.O.C.)
 Tel:+886-2172-1000 Fax:+886-2172-1322



Freq	Level	Read Level	Factor	Limit Line	Over Limit	APos	TPos	Remark	Pol/Phase	Note
MHz	dBuV/m	dBuV	dB/m	dBuV/m	dB	cm	deg			
1	0.03	72.02	39.37	32.65	119.18	-47.16	100	140 QP	Open	
2	0.05	43.72	17.67	26.05	113.13	-69.41	100	360 QP	Open	
3	0.06	72.81	47.47	25.34	112.27	-39.46	100	284 QP	Open	
4	0.08	31.99	9.90	22.09	109.33	-77.34	100	292 QP	Open	
5	0.12	39.06	20.11	18.95	106.25	-67.19	100	284 QP	Open	
6	0.13	35.29	16.73	18.56	105.59	-70.30	100	276 QP	Open	

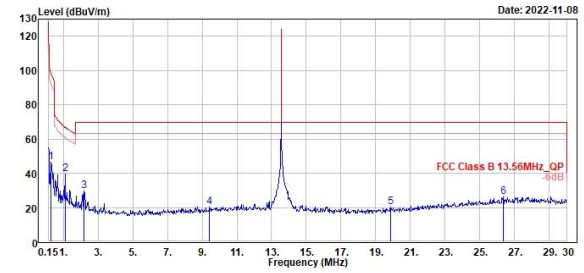

TUV Rheinland Taiwan Ltd.
 No. 458-18, Sec. 2, Fenliao, Linkou Dist., New Taipei City 244, Taiwan(R.O.C.)
 Tel:+886-2172-1000 Fax:+886-2172-1322



Freq	Level	Read Level	Factor	Limit Line	Over Limit	APos	TPos	Remark	Pol/Phase	Note
MHz	dBuV/m	dBuV	dB/m	dBuV/m	dB	cm	deg			
1	0.27	46.44	33.89	12.55	98.99	-52.55	100	62 QP	Open	
2	1.11	39.58	36.31	3.27	66.74	-27.16	100	327 QP	Open	
3	2.21	29.81	28.71	1.10	69.50	-39.69	100	335 QP	Open	
4	9.43	20.27	19.60	0.67	69.50	-49.23	100	86 QP	Open	
5	19.85	20.02	20.19	-0.17	69.50	-49.48	100	359 QP	Open	
6	26.33	25.99	23.13	2.86	69.50	-43.51	100	155 QP	Open	

Spurious Emissions, Tx Mode, 30MHz ~ 1GHz
Horizontal
Vertical

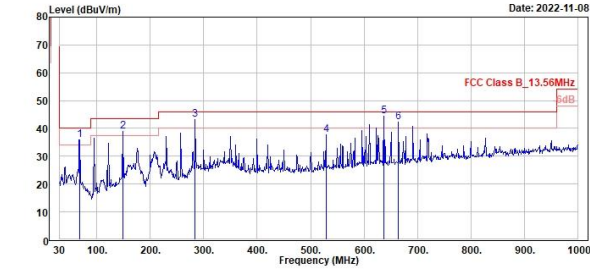

TUV Rheinland Taiwan Ltd.
 No. 458-18, Sec. 2, Fenhiao, Linkou Dist., New Taipei City 244, Taiwan(R.O.C.)
 Tel:+886-2172-1000 Fax:+886-2172-1322



	Freq	Level	Read	Limit	Over	APos	TPos	Remark	Pol/Phase	Note
	MHz	dBuV/m	dBuV	dB/m	dBuV/m	dB	cm	deg		
1	67.83	36.03	44.41	-8.38	40.00	-3.97	300	205	QP	Horizontal
2	148.34	38.85	45.01	-6.16	43.50	-4.65	200	192	QP	Horizontal
3	284.14	43.13	48.35	-5.22	46.00	-2.87	100	336	QP	Horizontal
4	528.58	37.81	38.95	-1.14	46.00	-8.19	100	351	QP	Horizontal
5	637.22	44.39	43.85	0.54	46.00	-1.61	100	75	QP	Horizontal
6	664.38	42.28	41.17	1.11	46.00	-3.72	100	75	QP	Horizontal

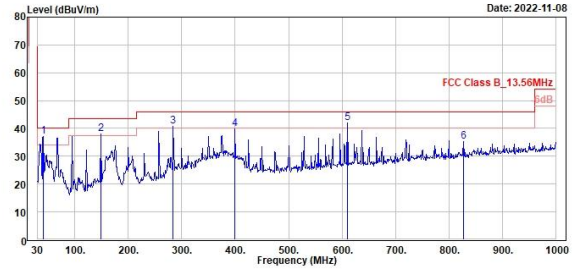

TUV Rheinland Taiwan Ltd.
 No. 458-18, Sec. 2, Fenhiao, Linkou Dist., New Taipei City 244, Taiwan(R.O.C.)
 Tel:+886-2172-1000 Fax:+886-2172-1322



	Freq	Level	Read	Limit	Over	APos	TPos	Remark	Pol/Phase	Note
	MHz	dBuV/m	dBuV	dB/m	dBuV/m	dB	cm	deg		
1	40.67	37.16	43.41	-6.25	40.00	-2.84	100	85	QP	Vertical
2	148.34	37.91	44.07	-6.16	43.50	-5.59	100	23	QP	Vertical
3	284.14	40.88	46.10	-5.22	46.00	-5.12	200	228	QP	Vertical
4	399.57	39.99	42.97	-2.98	46.00	-6.01	100	353	QP	Vertical
5	618.06	41.96	41.64	0.32	46.00	-4.04	200	146	QP	Vertical
6	627.34	35.36	31.74	3.62	46.00	-10.64	100	6	QP	Vertical

Mains Conducted Emission, Tx Mode, 150kHz ~ 30MHz

Worst Band

(Line)

(Neutral)



TÜV Rheinland Taiwan Ltd.
No. 458-18, Sec. 2, Fenhiao, Linkou Dist., New Taipei City 244, Taiwan(R.O.C.)
Tel: +886-2112-1000 Fax: +886-2112-1322



TÜV Rheinland Taiwan Ltd.
No. 458-18, Sec. 2, Fenhiao, Linkou Dist., New Taipei City 244, Taiwan(R.O.C.)
Tel: +886-2112-1000 Fax: +886-2112-1322

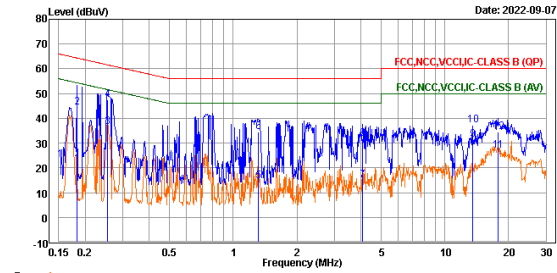
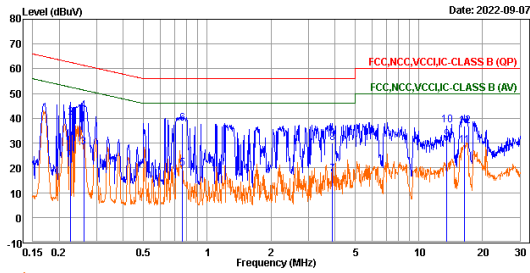

Trace: 1

Line	Freq	Level	Read Level	Factor	Limit Line	Over Limit	Remark	Pol/Phase	Note
	MHz	dBuV	dBuV	dB	dBuV	dB			
1	0.23	23.34	13.73	9.61	52.56	-29.22	Average	line1	
2	0.23	40.16	30.55	9.61	62.56	-22.40	QP	line1	
3	0.26	28.24	18.63	9.61	51.40	-23.16	Average	line1	
4	0.26	42.95	33.34	9.61	61.40	-18.45	QP	line1	
5	0.77	19.85	10.22	9.63	46.00	-26.15	Average	line1	
6	0.77	37.86	28.23	9.63	56.00	-18.14	QP	line1	
7	3.91	17.51	7.84	9.67	46.00	-28.45	Average	line1	
8	3.91	30.08	20.41	9.67	56.00	-25.92	QP	line1	
9	13.56	31.49	21.76	9.73	50.00	-18.51	Average	line1	
10	13.56	37.33	27.60	9.73	60.00	-22.67	QP	line1	
11	16.41	29.09	19.37	9.72	50.00	-20.91	Average	line1	
12	16.41	36.93	27.21	9.72	60.00	-23.07	QP	line1	

Trace: 1

Line	Freq	Level	Read Level	Factor	Limit Line	Over Limit	Remark	Pol/Phase	Note
	MHz	dBuV	dBuV	dB	dBuV	dB			
1	0.18	21.51	11.92	9.59	54.39	-32.88	Average	neutral	
2	0.18	44.32	34.73	9.59	64.39	-20.07	QP	neutral	
3	0.25	36.66	27.07	9.59	51.61	-14.95	Average	neutral	
4	0.25	47.51	37.92	9.59	61.61	-14.10	QP	neutral	
5	1.31	14.72	5.11	9.61	46.00	-31.28	Average	neutral	
6	1.31	34.58	24.97	9.61	56.00	-21.42	QP	neutral	
7	4.09	15.10	5.44	9.66	46.00	-30.90	Average	neutral	
8	4.09	31.70	22.04	9.66	56.00	-24.30	QP	neutral	
9	13.56	31.32	21.55	9.77	50.00	-18.68	Average	neutral	
10	13.56	37.31	27.54	9.77	60.00	-22.69	QP	neutral	
11	17.78	26.99	17.19	9.80	50.00	-23.01	Average	neutral	
12	17.78	34.48	24.68	9.80	60.00	-25.52	QP	neutral	