

**ELECTROMAGNETIC EMISSIONS COMPLIANCE REPORT
INTENTIONAL RADIATOR CERTIFICATION TO
FCC PART 15 SUBPART C REQUIREMENT**

OF

LED TV

**Model No.: WE55UJ4018, WXXXXXXXX, EXXXXXXXXXX (where X
would be any Arabian number or English letter or blank)**

FCC ID: 2ACWIWE55UJ401

Trademark: Westinghouse, Element

Report No.: ES181008034E

Issue Date: October 12, 2018

Prepared for

**Shenyang Tongfang Multimedia Technology Co., Limited.
No.10 Nanping East Road HunNan New District Shenyang, LiaoNing
Province P.R .China.**

Prepared by

EMTEK(SHENZHEN) CO., LTD.

**Bldg 69, Majialong Industry Zone, Nanshan District, Shenzhen,
Guangdong, China.**

TEL: 86-755-26954280

FAX: 86-755-26954282

**This report shall not be reproduced, except in full, without the written approval of
EMTEK(SHENZHEN) CO., LTD.**

VERIFICATION OF COMPLIANCE

Applicant:	Shenyang Tongfang Multimedia Technology Co., Limited No.10 Nanping East Road Hunnan New District Shenyang, Liaoning Province P.R .China
Manufacturer:	Shenyang Tongfang Multimedia Technology Co., Limited No.10 Nanping East Road Hunnan New District Shenyang, Liaoning Province P.R .China
Product Description:	LED TV
Model Number:	WE55UJ4018, WXXXXXXXX, EXXXXXXXXXX (where X would be any Arabian number or English letter or blank) These models are identical except for decorative parts in front panels, color of enclosures and design of signal input/output terminals in secondary circuits. here WE43UB4530 was selected for full test.
Input Rating:	AC 100-240V, 50/60Hz, 130W

We hereby certify that:

The above equipment was tested by EMTEK(SHENZHEN) CO., LTD. The test data, data evaluation, test procedures, and equipment configurations shown in this report were made in accordance with the procedures given in ANSI C63.10-2013 and the energy emitted by the sample EUT tested as described in this report is in compliance with conducted and radiated emission limits of FCC Rules Part 15.247(2017).

Date of Test : October 8, 2018 to October 12, 2018

Yaping Shen

Prepared by : _____

Yaping Shen/Editor

Joe Xia

Reviewer : _____

Joe Xia/Supervisor

[Signature]

Approved & Authorized Signer : _____

Lisa Wang/Manager

Modified Information

Version	Summary	Revision Date	Report No.
Ver.1.0	Original Report	/	ES181008034E

Table of Contents

1. GENERAL INFORMATION.....	6
1.1 PRODUCT DESCRIPTION.....	6
2. SYSTEM TEST CONFIGURATION	7
2.1 EUT CONFIGURATION	7
2.2 EUT EXERCISE	7
2.3 TEST PROCEDURE	7
2.4 CONFIGURATION OF TESTED SYSTEM	7
3. DESCRIPTION OF TEST MODES	8
4. SUMMARY OF TEST RESULTS	9
5. TEST METHODOLOGY.....	9
6. TEST FACILITY.....	10
7. TEST SYSTEM UNCERTAINTY	11
8. CONDUCTED EMISSIONS TEST	12
8.1 MEASUREMENT PROCEDURE	12
8.2 TEST SET-UP (BLOCK DIAGRAM OF CONFIGURATION)	12
8.3 MEASUREMENT EQUIPMENT USED	12
8.4 CONDUCTED EMISSION LIMIT	12
8.5 MEASUREMENT RESULT	12
9. RADIATED EMISSION TEST.....	15
9.1 MEASUREMENT PROCEDURE	15
9.2 TEST SET-UP (BLOCK DIAGRAM OF CONFIGURATION)	16
9.3 MEASUREMENT EQUIPMENT USED	17
9.4 RADIATED EMISSION LIMIT	18
9.5 MEASUREMENT RESULT	19
10. 6DB BANDWIDTH TEST.....	26
10.1 MEASUREMENT PROCEDURE	26
10.2 TEST SET-UP (BLOCK DIAGRAM OF CONFIGURATION)	26
10.3 MEASUREMENT EQUIPMENT USED	26
10.4 MEASUREMENT RESULTS.....	26
11. MAXIMUM PEAK OUTPUT POWER TEST.....	43
11.1 MEASUREMENT PROCEDURE.....	43
11.2 TEST SET-UP (BLOCK DIAGRAM OF CONFIGURATION).....	43
11.3 MEASUREMENT EQUIPMENT USED	43
11.4 PEAK POWER OUTPUT LIMIT	43
11.5 MEASUREMENT RESULTS	44
12. BAND EDGE TEST.....	45
12.1 MEASUREMENT PROCEDURE	45
12.2 TEST SET-UP (BLOCK DIAGRAM OF CONFIGURATION)	46
12.3 MEASUREMENT EQUIPMENT USED	46
12.4 MEASUREMENT RESULTS.....	46
13. MAXIMUM POWER SPECTRAL DENSITY.....	55
13.1 TEST EQUIPMENT.....	55
13.2 MEASURING INSTRUMENTS AND SETTING.....	55
13.3 TEST PROCEDURES	55
13.4 BLOCK DIAGRAM OF TEST SETUP	55
13.5 LIMIT	55

13.6 TEST RESULT 56

14. ANTENNA PORT EMISSION..... 72

14.1 TEST EQUIPMENT 72

14.2 MEASURING INSTRUMENTS AND SETTING..... 72

14.3 TEST PROCEDURES 72

14.4 BLOCK DIAGRAM OF TEST SETUP 72

14.5 TEST RESULT 72

15. ANTENNA APPLICATION..... 83

15.1 ANTENNA REQUIREMENT 83

15.2 RESULT 83

APPENDIX I (PHOTOS OF EUT)(6 PAGES)

1. General Information

1.1 Product Description

Characteristics	Description
IEEE 802.11 WLAN Mode Supported	<input checked="" type="checkbox"/> 802.11b(20MHz channel bandwidth) <input checked="" type="checkbox"/> 802.11g(20MHz channel bandwidth) <input checked="" type="checkbox"/> 802.11n(20MHz channel bandwidth) <input checked="" type="checkbox"/> 802.11n(40MHz channel bandwidth)
Data Rate	802.11 b:1,2,5.5,11Mbps; 802.11 g:6,9,12,18,24,36,48,54Mbps; 802.11n(HT20):MCS0-MCS7; 802.11n(HT40):MCS0-MCS7; 802.11n(HT40):MCS8-MCS15;
MIMO Mode	802.11n(HT20), 802.11n(HT40)
Modulation	DSSS with DBPSK/DQPSK/CCK for 802.11b; OFDM with BPSK/QPSK/16QAM/64QAM for 802.11g/n;
Operating Frequency Range	2412-2462MHz for 802.11b/g; 2412-2462MHz for 802.11n(HT20); 2422-2452MHz for 802.11n(HT40);
Number of Channels	11 channels for 802.11b/g; 11 channels for 802.11n(HT20); 7 channels for 802.11n(HT40);
Transmit Power Max	16.49dBm for 802.11b; 14.57dBm for 802.11g; 13.84dBm for 802.11n(HT20); 12.09 dBm for 802.11n(HT40);
Antenna Type	2TX2RX
Antenna Port	<input checked="" type="checkbox"/> Ant1; <input checked="" type="checkbox"/> Ant2;
Smart system	<input checked="" type="checkbox"/> SISO for 802.11b/g <input checked="" type="checkbox"/> MIMO for 802.11n
Antenna Gain	1.21dBi (for per antenna port Max) 4.22dBi for MIMO(Ant1+Ant2 Directional Gain)

Note: for more details, please refer to the User's manual of the EUT.

2. System Test Configuration

2.1 EUT Configuration

The EUT configuration for testing is installed on RF field strength measurement to meet the Commissions requirement and operating in a manner which intends to maximize its emission characteristics in a continuous normal application.

2.2 EUT Exercise

The Transmitter was operated in the normal operating mode. The TX frequency was fixed which was for the purpose of the measurements.

2.3 Test Procedure

2.3.1 Conducted Emissions

The EUT is a placed on as turn table which is 0.8 m above ground plane. According to the requirements in Section 13.1.4.1 of ANSI C63.10-2013 Conducted emissions from the EUT measured in the frequency range between 0.15 MHz and 30 MHz using CISPR Quasi-Peak and average detector mode.

2.3.2 Radiated Emissions

The EUT is a placed on as turn table which is 0.8 m above ground plane. The turn table shall rotate 360 degrees to determine the position of maximum emission level. EUT is set 3m away from the receiving antenna which varied from 1m to 4m to find out the highest emission. And also, each emission was to be maximized by changing the polarization of receiving antenna both horizontal and vertical. In order to find out the max. Emission, the relative positions of this hand-held transmitter (EUT) was rotated through three orthogonal axes according to the requirements in Section 13.1.4.1 of ANSI C63.10-2013.

2.4 Configuration of Tested System

Fig. 2-1 Configuration of Tested System

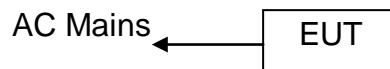

Table 2-1 Equipment Used in Tested System

Item	Equipment	Trademark	Model No.	FCC ID	Note
1.	LED TV	Westinghouse, Element	WE55UJ4018	2ACWIWE55UJ401	EUT

Note:

- (1) Unless otherwise denoted as EUT in 『Remark』 column, device(s) used in tested system is a support equipment.

3. Description of Test Modes

The EUT has been tested under its typical operating condition.

The EUT configuration for testing is installed on RF field strength measurement to meet the Commissions requirement and operating in a manner which intends to maximize its emission characteristics in a continuous normal application.

The Transmitter was operated in the normal operating mode. The TX frequency was fixed which was for the purpose of the measurements.

Test of channel included the lowest and middle and highest frequency to perform the test, then record on this report.

Those data rates (802.11b: 1 Mbps; 802.11g: 6 Mbps; 802.11n (HT20) : MCS0; 802.11n (HT40) : MCS0) were used for all test.

Pre-defined engineering program for regulatory testing used to control the EUT for staying in continuous transmitting and receiving mode is programmed.

Frequency and Channel list for 802.11 b/g/n (HT20):

Channel	Frequency (MHz)	Channel	Frequency (MHz)	Channel	Frequency (MHz)
1	2412	5	2432	9	2452
2	2417	6	2437	10	2457
3	2422	7	2442	11	2462
4	2427	8	2447		

Frequency and Channel list for 802.11 n (HT40):

Channel	Frequency (MHz)	Channel	Frequency (MHz)	Channel	Frequency (MHz)
3	2422	5	2432	8	2447
4	2427	6	2437	9	2452
		7	2442		

Test Frequency and Channel for 802.11 b/g/n (HT20):

Lowest Frequency		Middle Frequency		Highest Frequency	
Channel	Frequency (MHz)	Channel	Frequency (MHz)	Channel	Frequency (MHz)
1	2412	6	2437	11	2462

Test Frequency and channel for 802.11 n (HT40):

Lowest Frequency		Middle Frequency		Highest Frequency	
Channel	Frequency (MHz)	Channel	Frequency (MHz)	Channel	Frequency (MHz)
3	2422	6	2437	9	2452

4. Summary of Test Results

FCC Rules	Description Of Test	Result
§15.247(a)(2)	6dB bandwidth	Pass
§15.247(b)(3)	Max Peak output Power test	Pass
§15.247(e)	Power density	Pass
§15.247(d)	Band edge test	Pass
§15.207	AC Power Conducted Emission	Pass
§15.247(d), §15.209	Radiated Emission	Pass
§15.247(d)	Antenna Port Emission	Pass
§15.247(b)&§15.203	Antenna Application	Pass

RELATED SUBMITTAL(S) / GRANT(S):

This submittal(s) (test report) is intended for FCC ID: 2ACWIWE55UJ401 filing to comply with Section 15.247 of the FCC Part 15, Subpart C Rules.

The system is compliance with Subpart B is authorized under a DOC procedure

5. Test Methodology

According to its specifications, the EUT must comply with the requirements of the following standards:

FCC 47 CFR Part 2, Subpart J

FCC 47 CFR Part 15, Subpart C

FCC KDB 558074 D01 15.247 Meas Guidance v05

FCC KDB 662911 D01 Multiple Transmitter Output v01

FCC KDB 662911 D02 MIMO With Cross Polarized Antenna V01

6. Test Facility

Site Description

EMC Lab : Accredited by CNAS, 2016.10.24
The certificate is valid until 2022.10.28
The Laboratory has been assessed and proved to be in compliance with CNAS-CL01:2006 (identical to ISO/IEC 17025:2005)
The Certificate Registration Number is L2291.

Accredited by TUV Rheinland Shenzhen 2016.5.19
The Laboratory has been assessed according to the requirements ISO/IEC 17025.

Accredited by FCC, August 03, 2017
Designation Number: CN1204
Test Firm Registration Number: 882943

Accredited by Industry Canada, November 24, 2015
The Certificate Registration Number is 4480A.

Accredited by A2LA, July 31, 2017
The Certificate Number is 4321.01.

Name of Firm : EMTEK(SHENZHEN) CO., LTD.
Bldg 69, Majialong Industry Zone, Nanshan District, Shenzhen, Guangdong, China.

7. TEST SYSTEM UNCERTAINTY

The following measurement uncertainty levels have been estimated for tests performed on the apparatus:

Parameter	Uncertainty
Radio Frequency	$\pm 1 \times 10^{-5}$
Maximum Peak Output Power Test	$\pm 1.0\text{dB}$
Conducted Emissions Test	$\pm 2.0\text{dB}$
Radiated Emission Test	$\pm 2.0\text{dB}$
Power Density	$\pm 2.0\text{dB}$
Occupied Bandwidth Test	$\pm 1.0\text{dB}$
Band Edge Test	$\pm 3\text{dB}$
All emission, radiated	$\pm 3\text{dB}$
Antenna Port Emission	$\pm 3\text{dB}$
Temperature	$\pm 0.5^\circ\text{C}$
Humidity	$\pm 3\%$

Measurement Uncertainty for a level of Confidence of 95%

8. Conducted Emissions Test

8.1 Measurement Procedure

1. The EUT was placed on a table which is 0.8m above ground plane.
2. Maximum procedure was performed on the six highest emissions to ensure EUT compliance.
3. Repeat above procedures until all frequency measured were complete.

8.2 Test SET-UP (Block Diagram of Configuration)

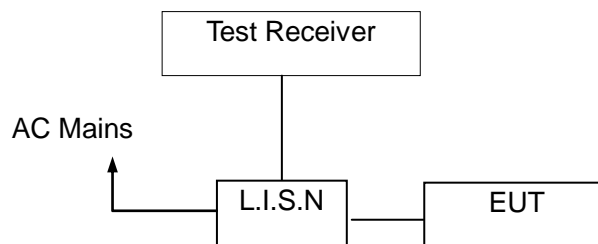

8.3 Measurement Equipment Used

Conducted Emission Test Site					
EQUIPMENT TYPE	MFR	MODEL NUMBER	SERIAL NUMBER	Last Cal.	Due date
Test Receiver	Rohde & Schwarz	ESCS30	100018	05/16/2018	05/15/2019
L.I.S.N	Rohde & Schwarz	ENV216	100017	05/16/2018	05/15/2019
RF Switching Unit	CDS	RSU-M2	38401	05/16/2018	05/15/2019
Coaxial Cable	CDS	79254	46107086	05/16/2018	05/15/2019

8.4 Conducted Emission Limit

Conducted Emission Frequency(MHz)	Quasi-peak	Average
0.15-0.5	66-56	56-46
0.5-5.0	56	46
5.0-30.0	60	50

- Note:**
1. The lower limit shall apply at the transition frequencies
 2. The limit decreases in line with the logarithm of the frequency in the range of 0.15 to 0.50MHz.

8.5 Measurement Result

Conducted emission at both 120V & 240V is assessed, and emission at 120V represents the worst case. All the modulation modes were tested the data of the worst mode (TX 802.11b 2412MHz) are recorded in the following pages and the others modulation

methods do not exceed the limits. Please refer to following pages.



Site site #1 Phase: **L1** Temperature: 25
 Limit: (CE)FCC PART 15 C_QP Power: AC 120V/60Hz Humidity: 55 %
 Mode: TX2412
 Note:

No.	Mk.	Freq.	Reading Level	Correct Factor	Measurement	Limit	Over	Detector	Comment
		MHz	dBuV	dB	dBuV	dBuV	dB		
1		0.2060	42.35	9.79	52.14	63.37	-11.23	QP	
2		0.2060	26.57	9.79	36.36	53.37	-17.01	AVG	
3		0.5020	27.75	9.84	37.59	56.00	-18.41	QP	
4		0.5020	19.44	9.84	29.28	46.00	-16.72	AVG	
5		3.4340	27.67	9.85	37.52	56.00	-18.48	QP	
6		3.4340	15.98	9.85	25.83	46.00	-20.17	AVG	
7		10.0620	28.00	9.98	37.98	60.00	-22.02	QP	
8		10.0620	23.68	9.98	33.66	50.00	-16.34	AVG	
9		14.3380	28.15	10.09	38.24	60.00	-21.76	QP	
10		14.3380	25.14	10.09	35.23	50.00	-14.77	AVG	
11		19.7100	33.05	10.23	43.28	60.00	-16.72	QP	
12	*	19.7100	29.05	10.23	39.28	50.00	-10.72	AVG	

*:Maximum data x:Over limit !:over margin Comment: Factor build in receiver. Operator: wu

File :WE55UJ4018

Data :#17

Date: 18/10/10/

Time: 9/59/18

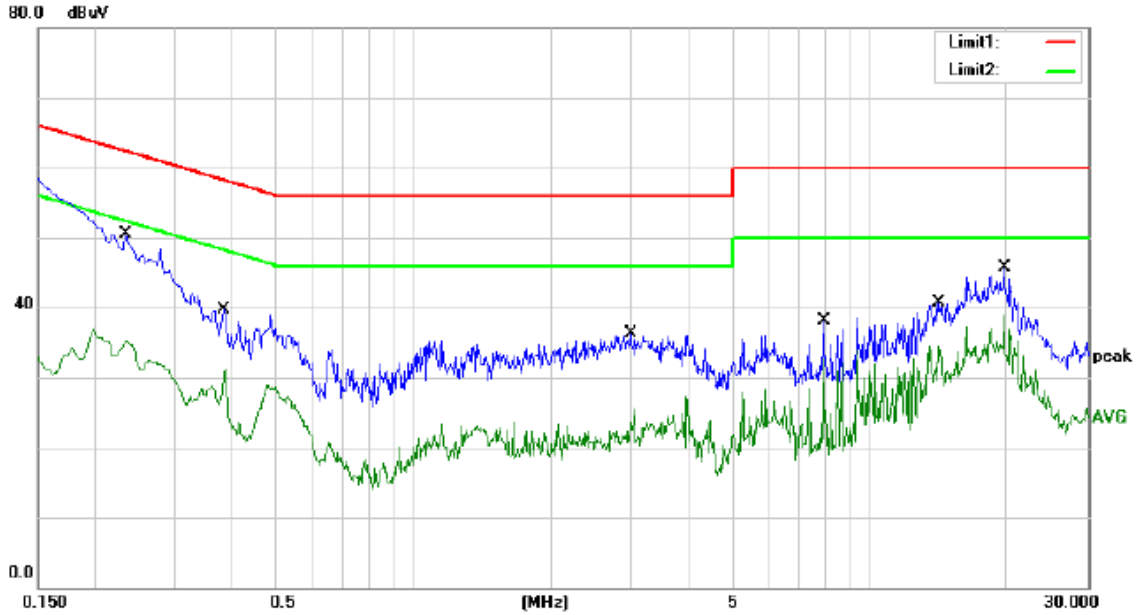

Site site #1

Phase: **N**

Temperature: 25

Limit: (CE)FCC PART 15 C_QP

Power: AC 120V/60Hz

Humidity: 55 %

Mode: TX2412

Note:

No.	Mk.	Freq. MHz	Reading Level dBuV	Correct Factor dB	Measure- ment dBuV	Limit dBuV	Over dB	Detector	Comment
1		0.2340	38.48	9.79	48.27	62.31	-14.04	QP	
2		0.2340	25.56	9.79	35.35	52.31	-16.96	AVG	
3		0.3860	28.30	9.82	38.12	58.15	-20.03	QP	
4		0.3860	21.44	9.82	31.26	48.15	-16.89	AVG	
5		2.9820	25.77	9.85	35.62	56.00	-20.38	QP	
6		2.9820	15.72	9.85	25.57	46.00	-20.43	AVG	
7		7.9260	26.64	9.93	36.57	60.00	-23.43	QP	
8		7.9260	22.75	9.93	32.68	50.00	-17.32	AVG	
9		14.1540	28.40	10.09	38.49	60.00	-21.51	QP	
10		14.1540	24.50	10.09	34.59	50.00	-15.41	AVG	
11		19.7100	33.06	10.23	43.29	60.00	-16.71	QP	
12	*	19.7100	28.77	10.23	39.00	50.00	-11.00	AVG	

*:Maximum data x:Over limit !:over margin Comment: Factor build in receiver. Operator: wu

9. Radiated Emission Test

9.1 Measurement Procedure

1. Below 1000MHz, The EUT was placed on a turn table which is 0.8m above ground plane, And above 1000MHz, The EUT was placed on a styrofoam table which is 1.5m above ground plane.
2. Maximum procedure was performed on the six highest emissions to ensure EUT compliance.
3. And also, each emission was to be maximized by changing the polarization of receiving antenna both horizontal and vertical.
4. Repeat above procedures until all frequency measured was complete.

When spectrum scanned from 30MHz to 1GHz setting resolution bandwidth 120KHz and video bandwidth 300KHz:

EMI Test Receiver	Setting
Attenuation	Auto
RBW	120KHz
VBW	300KHz
Detector	QP
Trace	Max hold

When spectrum scanned above 1GHz setting resolution bandwidth 1MHz, video bandwidth 3MHz:

EMI Test Receiver	Setting
Attenuation	Auto
RBW	1MHz
VBW	3MHz
Detector	Peak
Trace	Max hold

When spectrum scanned above 1GHz setting resolution bandwidth 1MHz, video bandwidth 10Hz:

EMI Test Receiver	Setting
Attenuation	Auto
RBW	1MHz
VBW	10Hz
Detector	Peak
Trace	Max hold

9.2 Test SET-UP (Block Diagram of Configuration)

(A) Radiated Emission Test Set-Up, Frequency Below 30MHz

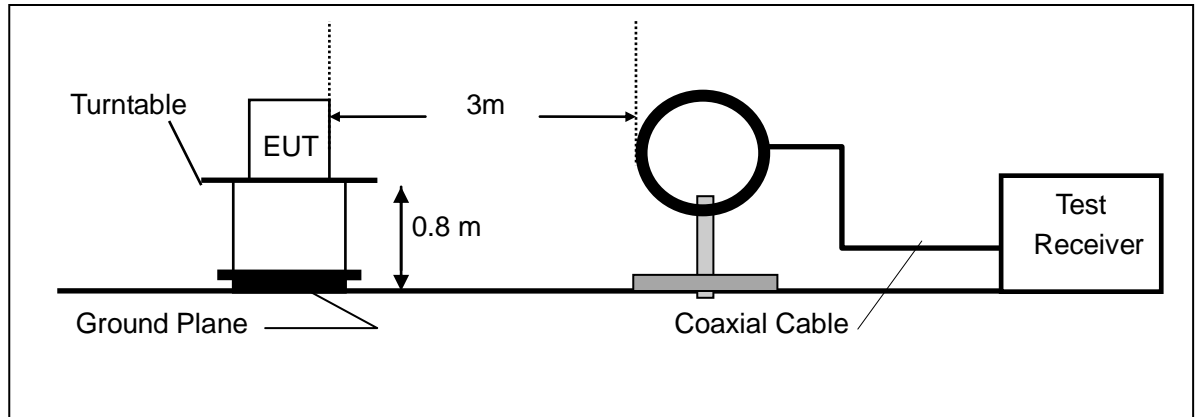

(B) Radiated Emission Test Set-Up, Frequency Below 1000MHz

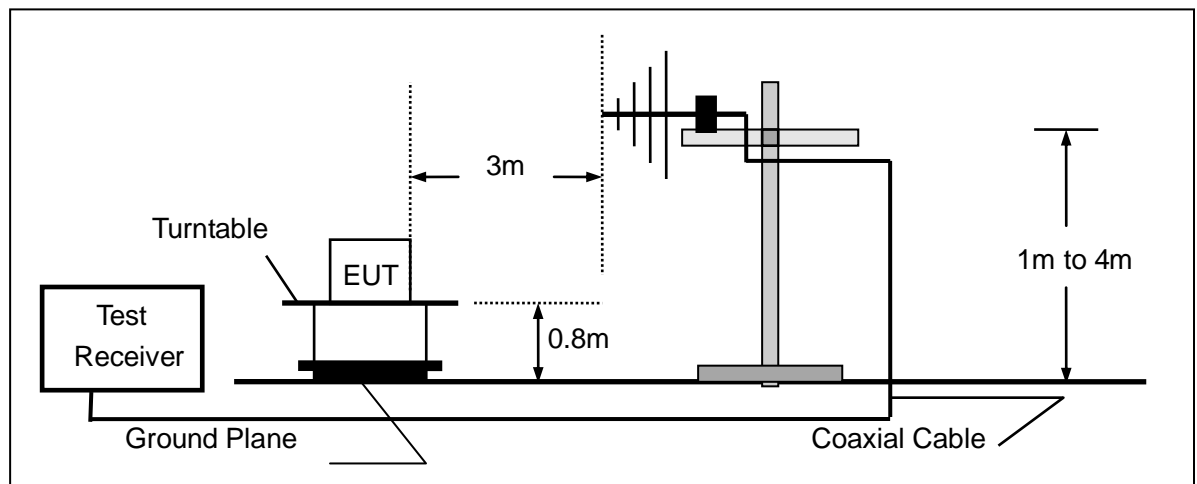

(C) Radiated Emission Test Set-Up, Frequency above 1000MHz

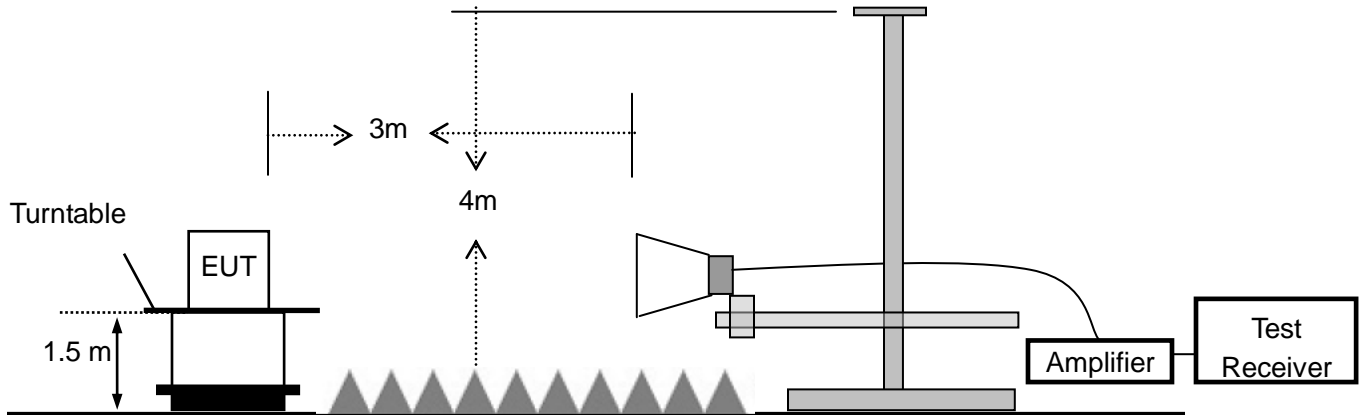

9.3 Measurement Equipment Used

Item	Equipment	Manufacturer	Model No.	Serial No.	Last Cal.	Cal. Interval
1.	Test Receiver	Rohde & Schwarz	ESCI	1166.5950.03	05/16/2018	1 Year
2.	Bilog Antenna	Schwarzbeck	VULB9163	000141	05/16/2018	1 Year
3.	Power Amplifier	CDS	RSU-M352	818	05/16/2018	1 Year
4.	Power Amplifier	HP	8447F	OPT H64	05/16/2018	1 Year
5.	Color Monitor	SUNSP0	SP-140A	N/A	05/16/2018	1 Year
6.	Single Line Filter	JIANLI	XL-3	N/A	05/16/2018	1 Year
7.	Single Phase Power Line Filter	JIANLI	DL-2X100B	N/A	05/16/2018	1 Year
8.	3 Phase Power Line Filter	JIANLI	DL-4X100B	N/A	05/16/2018	1 Year
9.	DC Power Filter	JIANLI	DL-2X50B	N/A	05/16/2018	1 Year
10.	Cable	Schwarzbeck	PLF-100	549489	05/16/2018	1 Year
11.	Cable	Rosenberger	CIL02	A0783566	05/16/2018	1 Year
12.	Cable	Rosenberger	RG 233/U	525178	05/16/2018	1 Year
13.	Signal Analyzer	Rohde & Schwarz	FSV30	103040	05/16/2018	1 Year
14.	Horn Antenna	Schwarzbeck	BBHA9120D	9120D-1272	05/16/2018	1 Year
15.	Power Amplifier	LUNAR EM	LNA1G18-40	J10100000081	05/16/2018	1 Year
16.	Cable	H+S	CBL-26	N/A	05/16/2018	1 Year
17.	Cable	H+S	CBL-26	N/A	05/16/2018	1 Year
18.	Cable	H+S	CBL-26	N/A	05/16/2018	1 Year

9.4 Radiated Emission Limit

The emissions from an intentional radiator shall not exceed the field strength levels specified in the following table 15.209(a):

Frequencies (MHz)	Field Strength (microrvolts/meter)	Measurement Distance (meters)
0.009~0.490	2400/F(KHz)	300
0.490~1.705	24000/F(KHz)	30
1.705~30.0	30	30
30~88	100	3
88~216	150	3
216~960	200	3
Above 960	500	3

Restricted bands of operation

MHz	MHz	MHz	GHz
0.090 - 0.110	16.42 - 16.423	399.9 - 410	4.5 - 5.15
¹ 0.495 - 0.505	16.69475 - 16.69525	608 - 614	5.35 - 5.46
2.1735 - 2.1905	16.80425 - 16.80475	960 - 1240	7.25 - 7.75
4.125 - 4.128	25.5 - 25.67	1300 - 1427	8.025 - 8.5
4.17725 - 4.17775	37.5 - 38.25	1435 - 1626.5	9.0 - 9.2
4.20725 - 4.20775	73 - 74.6	1645.5 - 1646.5	9.3 - 9.5
6.215 - 6.218	74.8 - 75.2	1660 - 1710	10.6 - 12.7
6.26775 - 6.26825	108 - 121.94	1718.8 - 1722.2	13.25 - 13.4
6.31175 - 6.31225	123 - 138	2200 - 2300	14.47 - 14.5
8.291 - 8.294	149.9 - 150.05	2310 - 2390	15.35 - 16.2
8.362 - 8.366	156.52475 - 156.52525	2483.5 - 2500	17.7 - 21.4
8.37625 - 8.38675	156.7 - 156.9	2690 - 2900	22.01 - 23.12
8.41425 - 8.41475	162.0125 - 167.17	3260 - 3267	23.6 - 24.0
12.29 - 12.293	167.72 - 173.2	3332 - 3339	31.2 - 31.8
12.51975 - 12.52025	240 - 285	3345.8 - 3358	36.43 - 36.5
12.57675 - 12.57725	322 - 335.4	3600 - 4400	(²)

Remark 1. Emission level in dBuV/m=20 log (uV/m)

: 2. Measurement was performed at an antenna to the closed point of EUT distance of meters.

3. Only spurious frequency is permitted to locate within the Restricted Bands specified in provision of § 15.205, and the emissions located in restricted bands also comply with 15.209 limit.

9.5 Measurement Result

Below 30MHz:

All the modulation modes were tested the data of the test mode are recorded in the following pages.

Operation Mode:	TX Mode	Test Date :	October 10, 2018
Frequency Range:	9KHz~30MHz	Temperature :	26°C
Test Result:	PASS	Humidity :	58 %
Measured Distance:	3m	Test By:	Andy

Freq. (MHz)	Ant.Pol. H/V	Emission Level (dBuV/m)	Limit 3m (dBuV/m)	Over (dB)
--	--	--	--	--

Note: the amplitude of spurious emission that is attenuated by more than 20dB below the permissible limit has no need to be reported.

Distance extrapolation factor = $40 \log(\text{Specific distance} / \text{test distance})$ (dB);

Limit line = Specific limits(dBuV) + distance extrapolation factor.

Below 1000MHz:

Radiated emission at both 120V & 240V is assessed, and emission at 120V represents the worst case. All the modulation modes were tested the data of the worst mode (ANT 1: TX 802.11b 2462MHz) are recorded in the following pages and the others modulation methods do not exceed the limits.

Please refer to the following test plots:

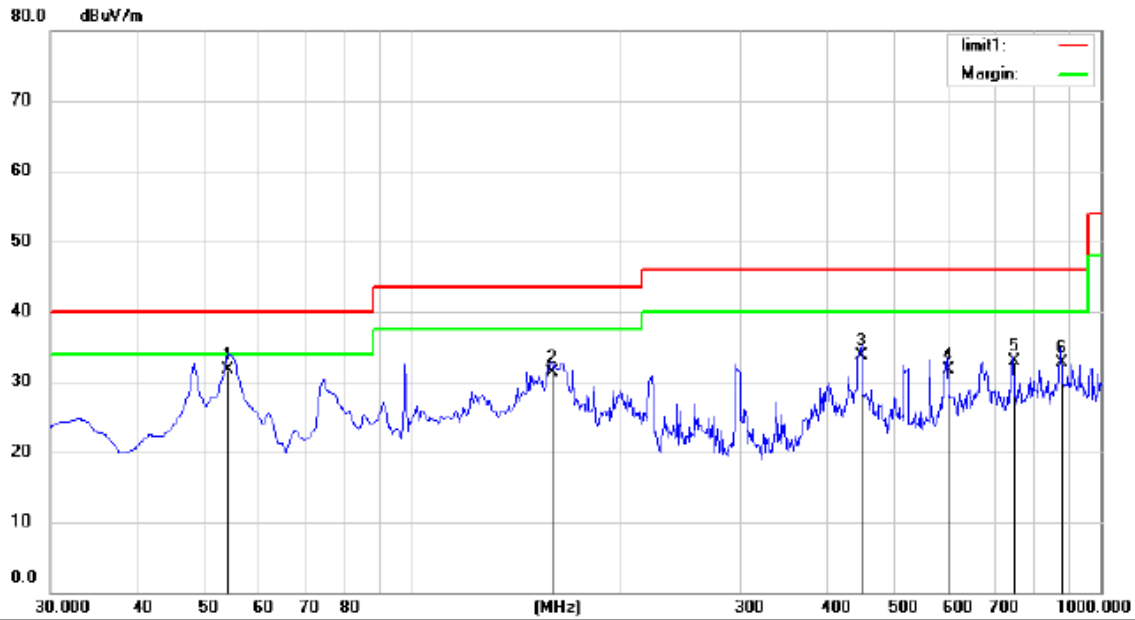

Site Chamber #1 Polarization: *Horizontal* Temperature: 26
 Limit: (RE)FCC PART 15 C 3m Power: AC 120V/60Hz Humidity: 55 %
 Mode: TX2462
 Note:

No.	Mk.	Freq. MHz	Reading Level dBuV	Correct Factor dB	Measure- ment dBuV/m	Limit dBuV/m	Over dB	Antenna Height cm	Table Degree degree	Detector	Comment
1	*	54.2500	47.60	-15.86	31.74	40.00	-8.26			QP	
2		159.9800	51.96	-20.71	31.25	43.50	-12.25			QP	
3		450.0100	43.69	-9.95	33.74	46.00	-12.26			QP	
4		599.3900	37.65	-5.87	31.78	46.00	-14.22			QP	
5		747.8000	36.58	-3.59	32.99	46.00	-13.01			QP	
6		875.8400	36.50	-3.73	32.77	46.00	-13.23			QP	

*:Maximum data x:Over limit !:over margin

Operator: Lin

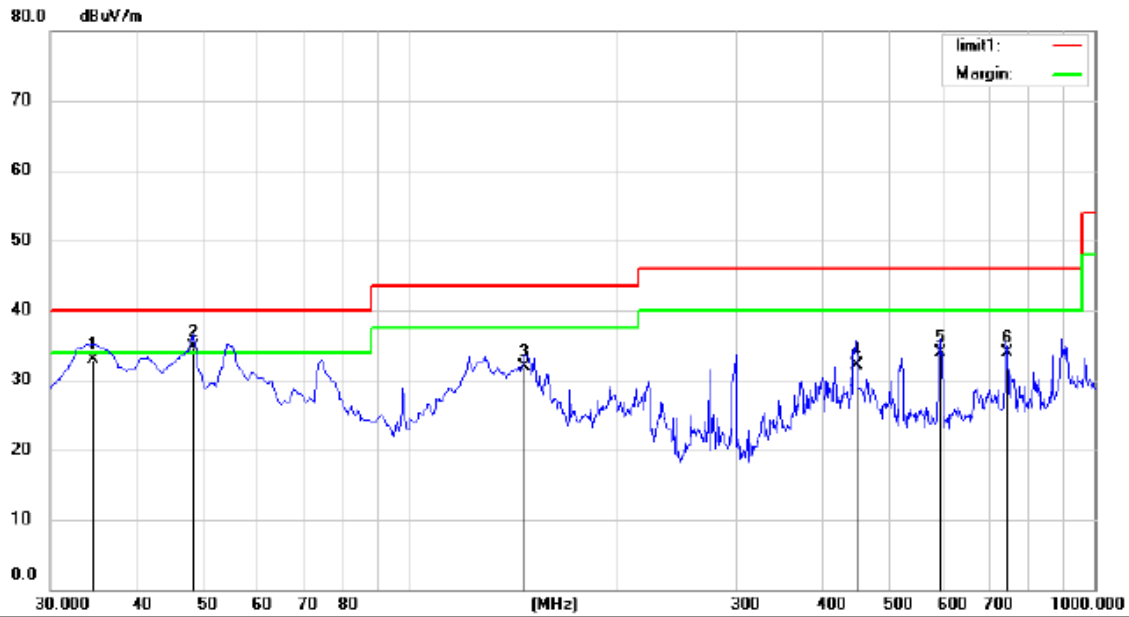

Site Chamber #1 Polarization: **Vertical** Temperature: 26
 Limit: (RE)FCC PART 15 C 3m Power: AC 120V/60Hz Humidity: 55 %
 Mode: TX2462
 Note:

No.	Mk.	Freq.	Reading Level	Correct Factor	Measurement	Limit	Over	Antenna Height	Table Degree	
		MHz	dBuV	dB	dBuV/m	dBuV/m	dB	cm	degree	Comment
1		34.6385	51.60	-18.71	32.89	40.00	-7.11			QP
2	*	48.4300	50.47	-15.67	34.80	40.00	-5.20			QP
3		147.4036	53.47	-21.63	31.84	43.50	-11.66			QP
4		449.0400	43.05	-10.87	32.18	46.00	-13.82			QP
5		595.5100	41.23	-7.41	33.82	46.00	-12.18			QP
6		742.9500	38.69	-4.88	33.81	46.00	-12.19			QP

*:Maximum data x:Over limit !:over margin

Operator: Lin

Above 1000MHz:ANT1

Operation Mode: 802.11b Lowest Test Date : October 10, 2018
 Test Voltage: AC 120V/60Hz Test by: Andy

Freq. (MHz)	Ant. Pol. H/V	Reading Level(dBuV/m)		Correct Factor dB	Emission Level(dBuV/m)		Limit 3m(dBuV/m)		Margin(dB)	
		PK	AV		PK	AV	PK	AV	PK	AV
4824	V	94.88	77.05	-32.3	62.58	44.75	74	54	-11.42	-9.25
7236	V	100.69	81.34	-37.2	63.49	44.14	74	54	-10.51	-9.86
9648	V	103.35	83.85	-39.8	63.55	44.05	74	54	-10.45	-9.95
12060	V	103.66	84.11	-40.5	63.16	43.61	74	54	-10.84	-10.39
14472	V	105.73	84.81	-41.7	64.03	43.11	74	54	-9.97	-10.89
16884	V	102.51	83.89	-40	62.51	43.89	74	54	-11.49	-10.11
4824	H	92.73	74.58	-31.6	61.13	42.98	74	54	-12.87	-11.02
7236	H	99.17	78.13	-35.5	63.67	42.63	74	54	-10.33	-11.37
9648	H	99.75	80.72	-38.3	61.45	42.42	74	54	-12.55	-11.58
12060	H	100.84	80.57	-39	61.84	41.57	74	54	-12.16	-12.43
14472	H	102.82	83.69	-42	60.82	41.69	74	54	-13.18	-12.31
16884	H	100.21	79.63	-39.3	60.91	40.33	74	54	-13.09	-13.67

Operation Mode: 802.11b Middle Test Date : October 10, 2018
 Test Voltage: AC 120V/60Hz Test by: Andy

Freq. (MHz)	Ant. Pol. H/V	Reading Level(dBuV/m)		Correct Factor dB	Emission Level(dBuV/m)		Limit 3m(dBuV/m)		Margin(dB)	
		PK	AV		PK	AV	PK	AV	PK	AV
4874	V	96.35	75.86	-32.3	64.05	43.56	74	54	-9.95	-10.44
7311	V	101.29	80.87	-37.2	64.09	43.67	74	54	-9.91	-10.33
9688	V	103.29	83.02	-39.8	63.49	43.22	74	54	-10.51	-10.78
12185	V	103.93	82.67	-40.5	63.43	42.17	74	54	-10.57	-11.83
14622	V	103.66	83.26	-41	62.66	42.26	74	54	-11.34	-11.74
17059	V	104.61	83.15	-41.1	63.51	42.05	74	54	-10.49	-11.95
4874	H	93.84	72.07	-31.6	62.24	40.47	74	54	-11.76	-13.53
7311	H	96.69	75.71	-35.5	61.19	40.21	74	54	-12.81	-13.79
9688	H	101.52	77.79	-38.3	63.22	39.49	74	54	-10.78	-14.51
12185	H	99.24	78.97	-39	60.24	39.97	74	54	-13.76	-14.03
14622	H	102.39	81.13	-42	60.39	39.13	74	54	-13.61	-14.87
17059	H	101.47	79.67	-41.5	59.97	38.17	74	54	-14.03	-15.83

Operation Mode: 802.11b Highest

Test Date : October 10, 2018

Test Voltage: AC 120V/60Hz

Test by: Andy

Freq. (MHz)	Ant. Pol.	Reading Level(dBuV/m)		Correct Factor dB	Emission Level(dBuV/m)		Limit 3m(dBuV/m)		Over(dB)	
		PK	AV		PK	AV	PK	AV	PK	AV
4924	V	95.86	76.46	-32.3	63.56	44.16	74	54	-10.44	-9.84
7386	V	100.45	80.84	-37.2	63.25	43.64	74	54	-10.75	-10.36
9848	V	103.86	82.95	-39.8	64.06	43.15	74	54	-9.94	-10.85
12310	V	104.61	83.76	-40.5	64.11	43.26	74	54	-9.89	-10.74
14772	V	104.95	83.55	-41	63.95	42.55	74	54	-10.05	-11.45
17234	V	104.12	83.26	-41.1	63.02	42.16	74	54	-10.98	-11.84
4924	H	91.72	73.77	-31.6	60.12	42.17	74	54	-13.88	-11.83
7386	H	97.48	77.19	-35.5	61.98	41.69	74	54	-12.02	-12.31
9848	H	99.33	78.64	-38.3	61.03	40.34	74	54	-12.97	-13.66
12310	H	99.42	79.22	-39	60.42	40.22	74	54	-13.58	-13.78
14772	H	101.59	83.19	-42	59.59	41.19	74	54	-14.41	-12.81
17234	H	100.28	82.39	-41.5	58.78	40.89	74	54	-15.22	-13.11

All emissions not reported were more than 20dB below the specified limit or in the noise floor.

- Note:**
- (1) All Readings are Peak Value and AV.
 - (2) Emission Level= Reading Level+Probe Factor +Cable Loss.
 - (3) Data of measurement within this frequency range shown “ – ” in the table above means the reading of emissions are attenuated more than 20dB below the permissible limits or the field strength is too small to be measured.

Above 1000MHz:ANT2

Operation Mode: 802.11b Lowest Test Date : October 10, 2018
 Test Voltage: AC 120V/60Hz Test by: Andy

Freq. (MHz)	Ant. Pol. H/V	Reading Level(dBuV/m)		Correct Factor dB	Emission Level(dBuV/m)		Limit 3m		Margin(dB)	
		PK	AV		PK	AV	PK	AV	PK	AV
4824	V	94.43	76.86	-32.3	62.13	44.56	74	54	-11.87	-9.44
7236	V	99.89	80.89	-37.2	62.69	43.69	74	54	-11.31	-10.31
9648	V	102.14	82.85	-39.8	62.34	43.05	74	54	-11.66	-10.95
12060	V	102.64	84.82	-40.5	62.14	44.32	74	54	-11.86	-9.68
14472	V	103.72	84.81	-41.7	62.02	43.11	74	54	-11.98	-10.89
16884	V	102.32	82.56	-40	62.32	42.56	74	54	-11.68	-11.44
4824	H	93.62	75.07	-31.6	62.02	43.47	74	54	-11.98	-10.53
7236	H	97.82	78.52	-35.5	62.32	43.02	74	54	-11.68	-10.98
9648	H	98.88	80.72	-38.3	60.58	42.42	74	54	-13.42	-11.58
12060	H	100.65	81.05	-39	61.65	42.05	74	54	-12.35	-11.95
14472	H	102.65	83.3	-42	60.65	41.3	74	54	-13.35	-12.7
16884	H	99.8	79.52	-39.3	60.5	40.22	74	54	-13.5	-13.78

Operation Mode: 802.11b Middle Test Date : October 10, 2018
 Test Voltage: AC 120V/60Hz Test by: Andy

Freq. (MHz)	Ant. Pol. H/V	Reading Level(dBuV/m)		Correct Factor dB	Emission Level(dBuV/m)		Limit 3m(dBuV/m)		Margin(dB)	
		PK	AV		PK	AV	PK	AV	PK	AV
4874	V	95.88	76.66	-32.3	63.58	44.36	74	54	-10.42	-9.64
7311	V	100.45	81	-37.2	63.25	43.8	74	54	-10.75	-10.2
9688	V	101.93	82.83	-39.8	62.13	43.03	74	54	-11.87	-10.97
12185	V	103.75	83.46	-40.5	63.25	42.96	74	54	-10.75	-11.04
14622	V	103.47	83.5	-41	62.47	42.5	74	54	-11.53	-11.5
17059	V	102.68	83.12	-41.1	61.58	42.02	74	54	-12.42	-11.98
4874	H	91.62	71.92	-31.6	60.02	40.32	74	54	-13.98	-13.68
7311	H	96.86	76.53	-35.5	61.36	41.03	74	54	-12.64	-12.97
9688	H	100.66	80.66	-38.3	62.36	42.36	74	54	-11.64	-11.64
12185	H	97.6	78.23	-39	58.6	39.23	74	54	-15.4	-14.77
14622	H	101.66	81.47	-42	59.66	39.47	74	54	-14.34	-14.53
17059	H	100.97	80.95	-41.5	59.47	39.45	74	54	-14.53	-14.55

Operation Mode: 802.11b Highest

Test Date : October 10, 2018

Test Voltage: AC 120V/60Hz

Test by: Andy

Freq. (MHz)	Ant. Pol.	Reading Level(dBuV/m)		Correct Factor dB	Emission Level(dBuV/m)		Limit 3m(dBuV/m)		Over(dB)	
		PK	AV		PK	AV	PK	AV	PK	AV
4924	V	95.84	76.62	-32.3	63.54	44.32	74	54	-10.5	-9.68
7386	V	98.52	79.78	-37.2	61.32	42.58	74	54	-12.7	-11.42
9848	V	103.27	83.66	-39.8	63.47	43.86	74	54	-10.5	-10.14
12310	V	103.78	83.7	-40.5	63.28	43.2	74	54	-10.7	-10.8
14772	V	104.47	84.01	-41	63.47	43.01	74	54	-10.5	-10.99
17234	V	104.06	83.26	-41.1	62.96	42.16	74	54	-11	-11.84
4924	H	91.28	72.22	-31.6	59.68	40.62	74	54	-14.3	-13.38
7386	H	97.18	77.19	-35.5	61.68	41.69	74	54	-12.3	-12.31
9848	H	99.32	78.32	-38.3	61.02	40.02	74	54	-13	-13.98
12310	H	98.6	78.69	-39	59.6	39.69	74	54	-14.4	-14.31
14772	H	101.23	82.55	-42	59.23	40.55	74	54	-14.8	-13.45
17234	H	99.96	81.18	-41.5	58.46	39.68	74	54	-15.5	-14.32

All emissions not reported were more than 20dB below the specified limit or in the noise floor.

- Note:**
- (1) All Readings are Peak Value and AV.
 - (2) Emission Level= Reading Level+Probe Factor +Cable Loss.
 - (3) Data of measurement within this frequency range shown “ – ” in the table above means the reading of emissions are attenuated more than 20dB below the permissible limits or the field strength is too small to be measured.

10. 6dB Bandwidth Test

10.1 Measurement Procedure

The EUT was operating in IEEE 802.11b, 802.11g, 802.11n(HT20), 802.11n(HT40) mode or could be controlled its channel. Printed out the test result from the spectrum by hard copy function.

1. Set resolution bandwidth (RBW) = 100 kHz.
2. Set the video bandwidth (VBW) $\geq 3 \times$ RBW.
3. Detector = Peak.
4. Trace mode = max hold.
5. Sweep = auto couple.
6. Allow the trace to stabilize.
7. Measure the maximum width of the emission that is constrained by the frequencies associated with the two outermost amplitude points (upper and lower frequency) that are attenuated by 6 dB relative to the maximum level measured in the fundamental emission.

10.2 Test SET-UP (Block Diagram of Configuration)

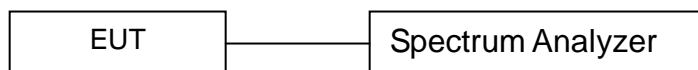

10.3 Measurement Equipment Used

EQUIPMENT TYPE	MFR	MODEL NUMBER	SERIAL NUMBER	LAST CAL.	CAL DUE.
Spectrum Analyzer	Agilent	FSV30	1321.3008K	05/16/2018	05/15/2019

10.4 Measurement Results

6 Bandwidth Test Data Chart:

Refer to attached data chart.

Spectrum Detector: PK
 Test By: Andy
 Humidity : 60%

Test Date : October 11,2018
 Temperature : 27°C

IEEE 802.11b SISO Ant1			
Channel frequency (MHz)	Measurement level (kHz)	Required Limit (kHz)	Result
2412	10050	>500	Pass
2437	10050	>500	
2462	10050	>500	

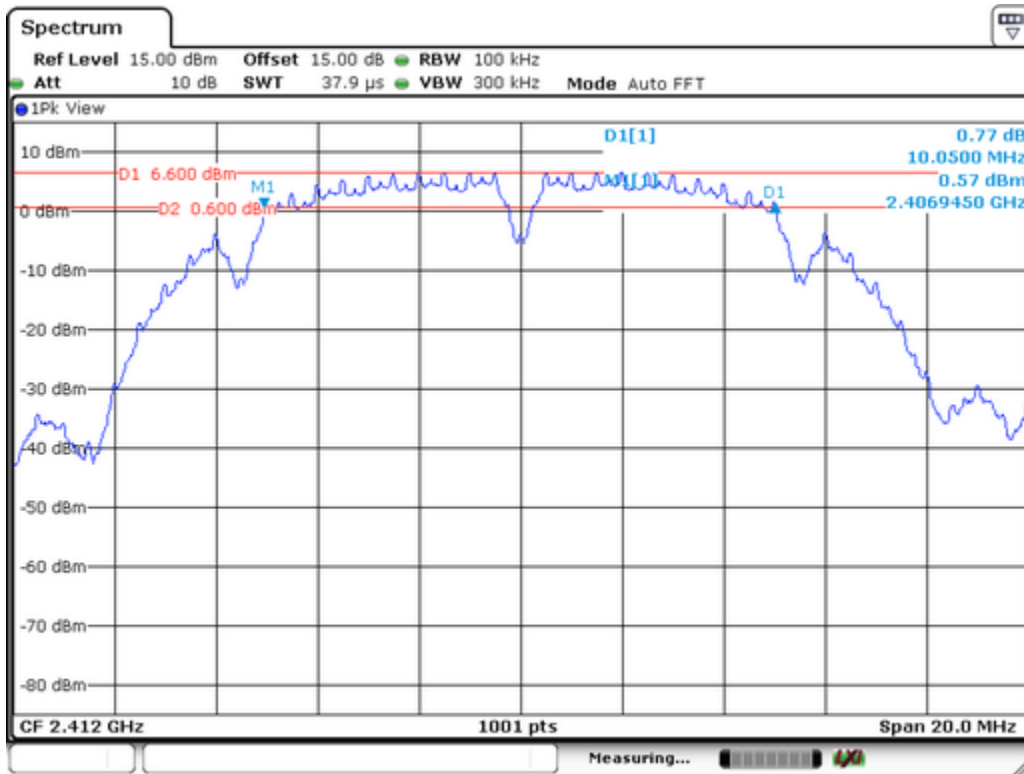

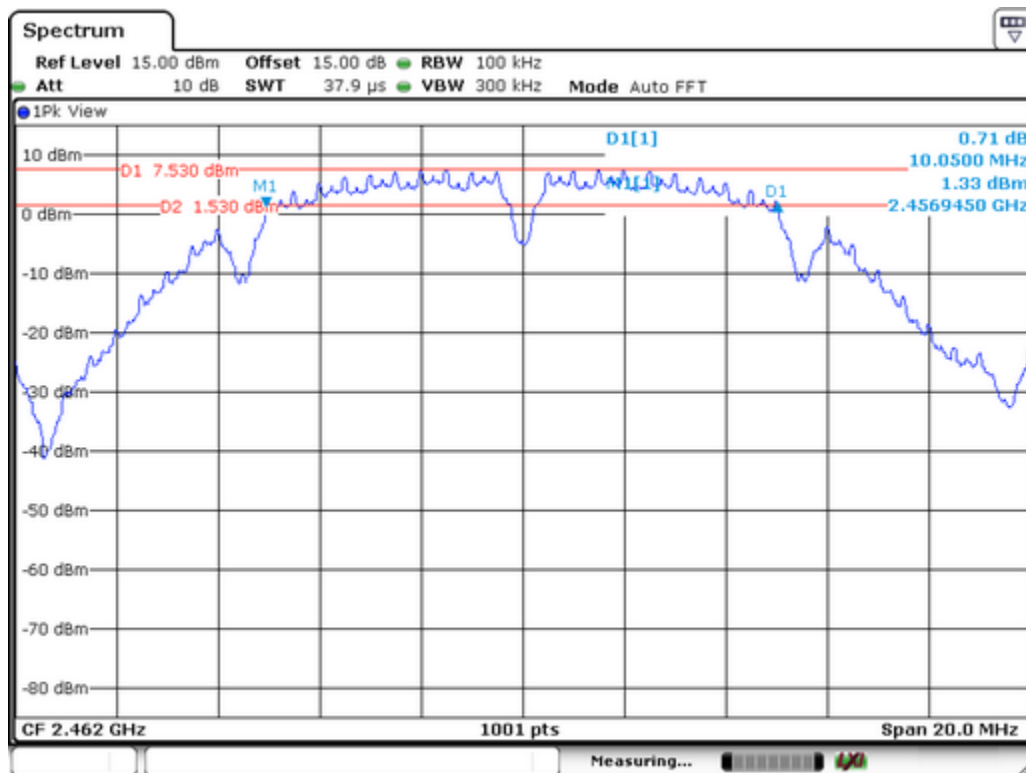
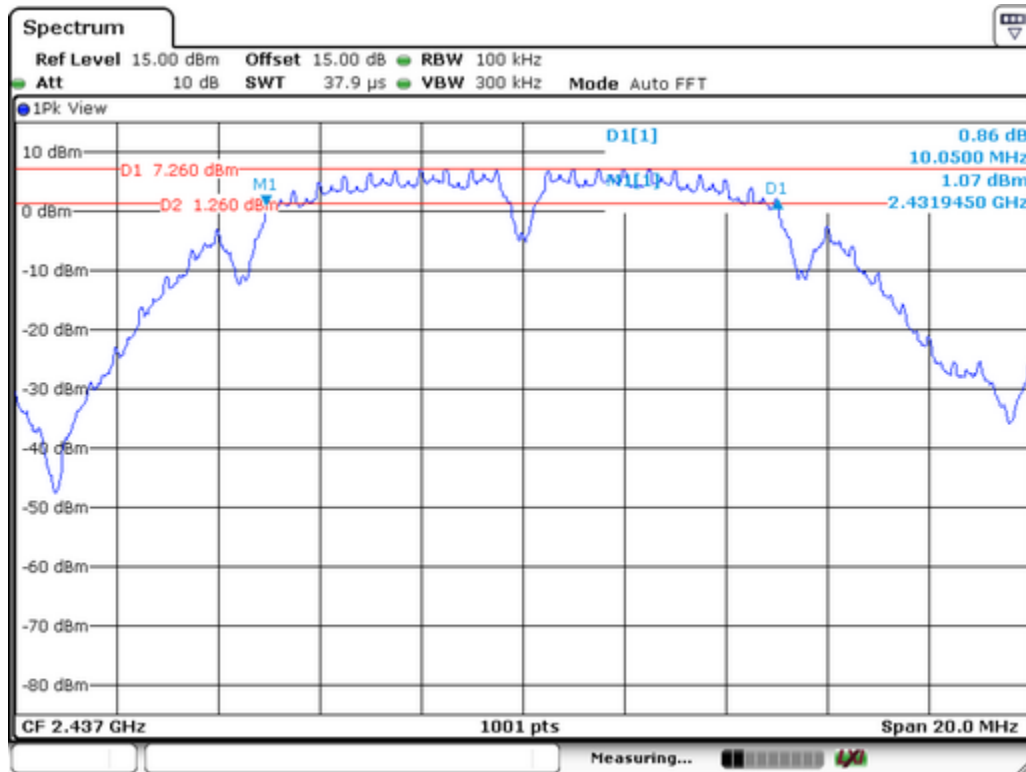

IEEE 802.11b SISO Ant2			
Channel frequency (MHz)	Measurement level (kHz)	Required Limit (kHz)	Result
2412	10050	>500	Pass
2437	10050	>500	
2462	10050	>500	

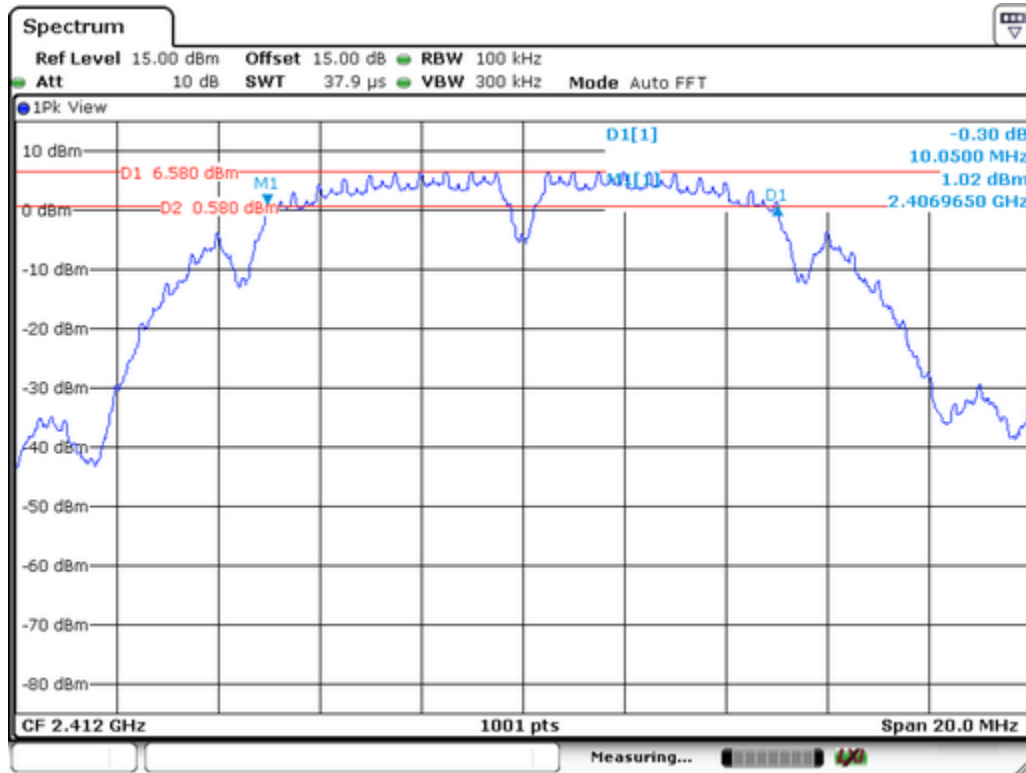

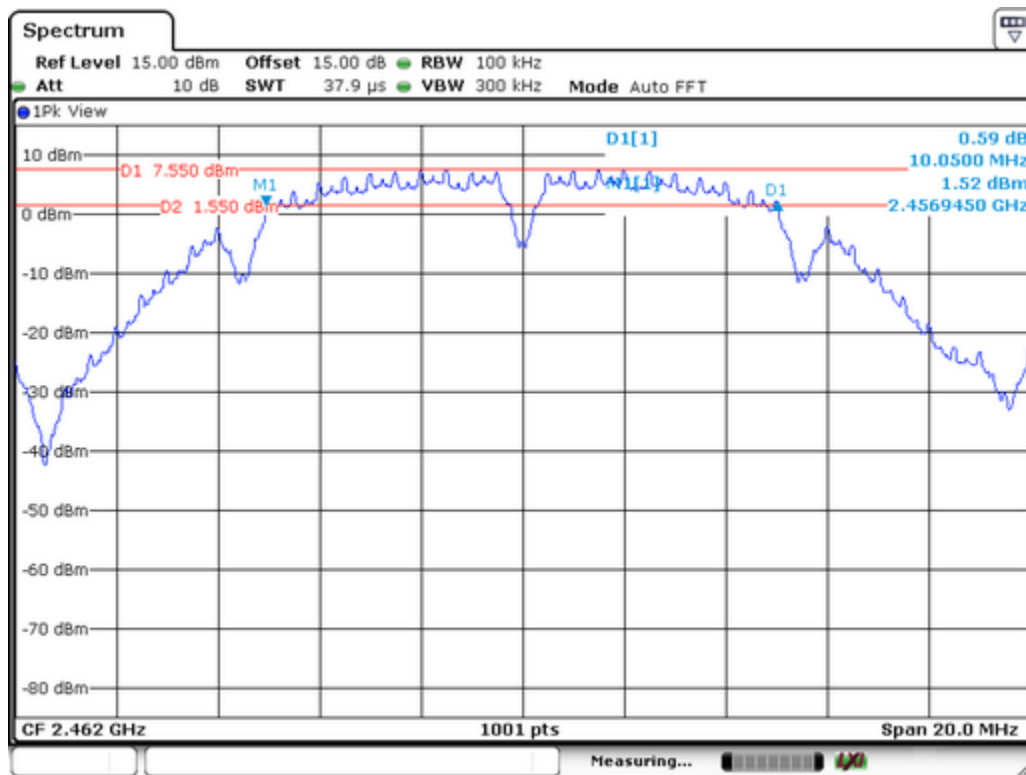
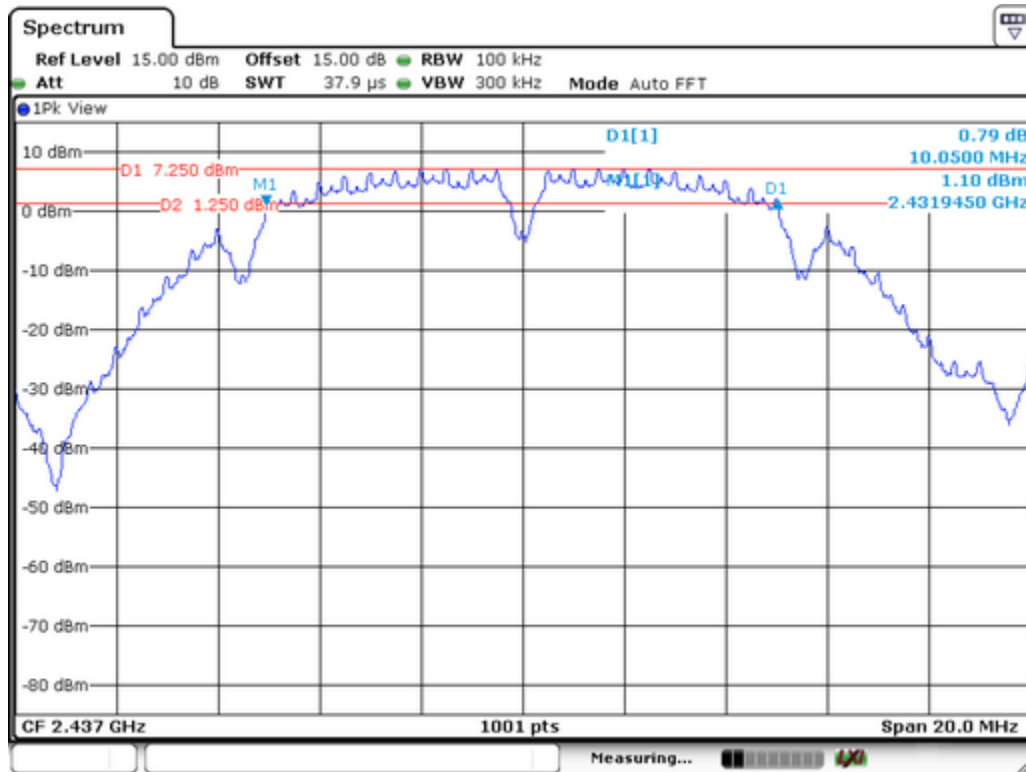

IEEE 802.11g SISO Ant1			
Channel frequency (MHz)	Measurement level (kHz)	Required Limit (kHz)	Result
2412	16344	>500	Pass
2437	16344	>500	
2462	16344	>500	

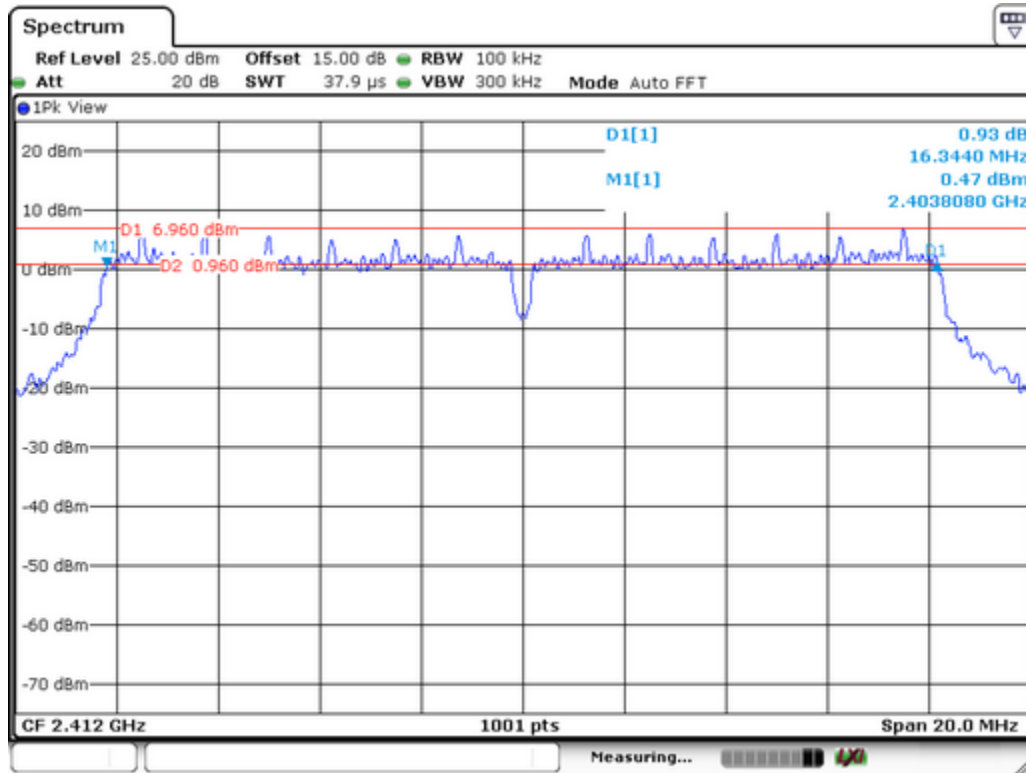

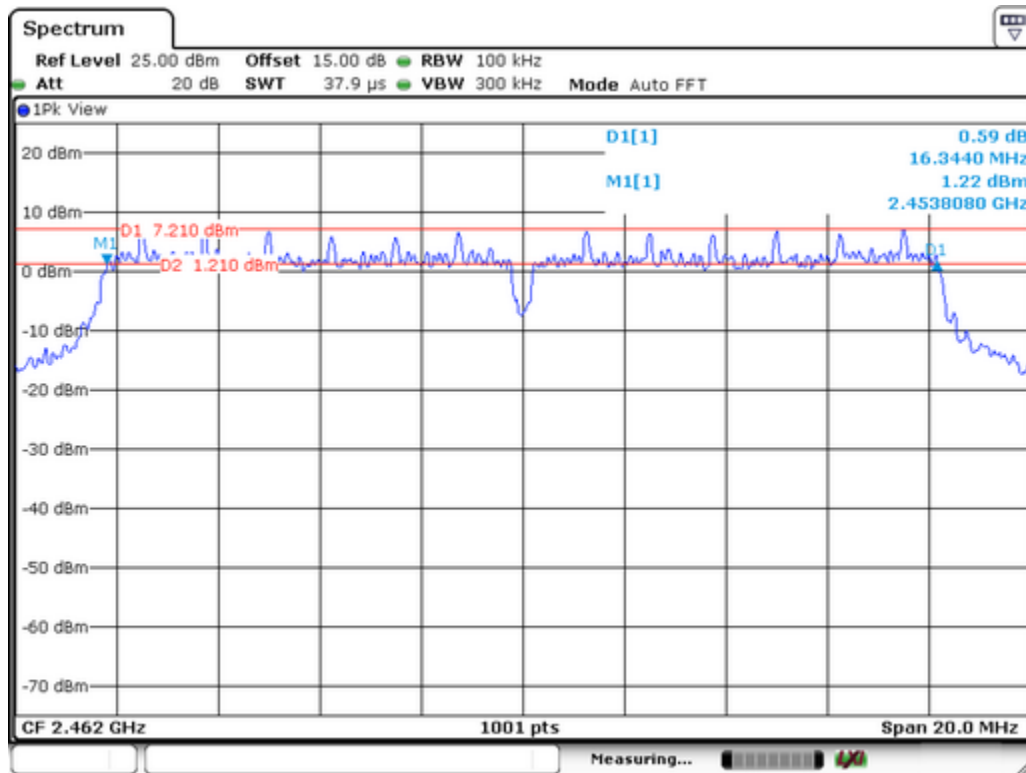
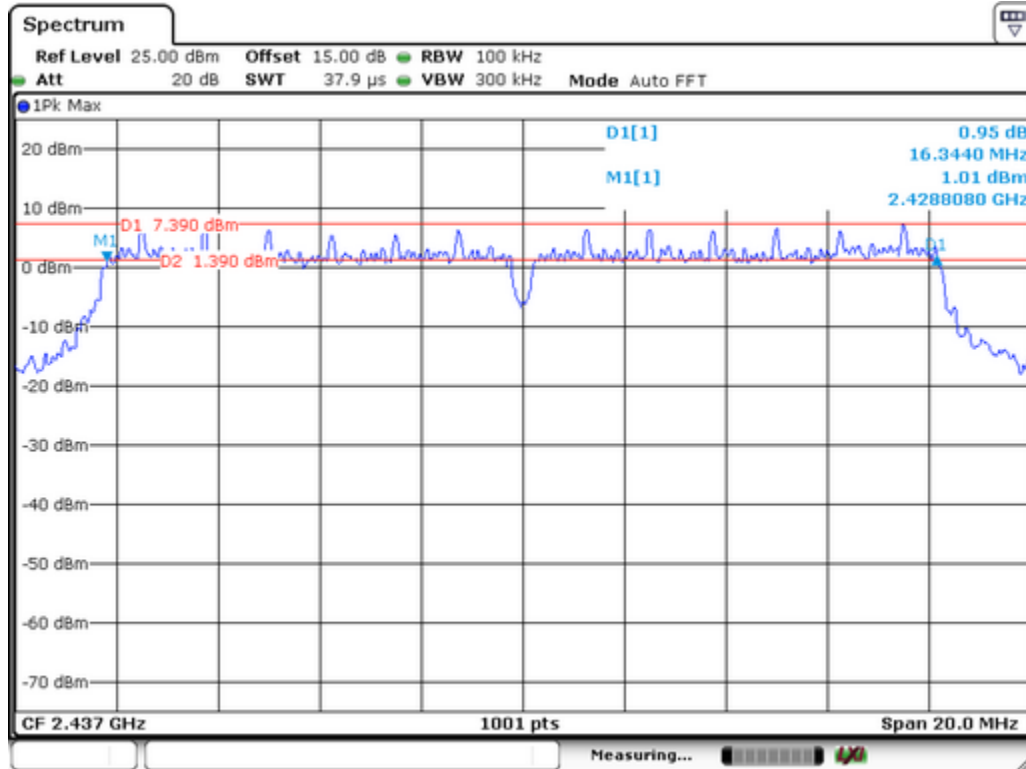

IEEE 802.11g SISO Ant2			
Channel frequency (MHz)	Measurement level (kHz)	Required Limit (kHz)	Result
2412	16344	>500	Pass
2437	16344	>500	
2462	16344	>500	

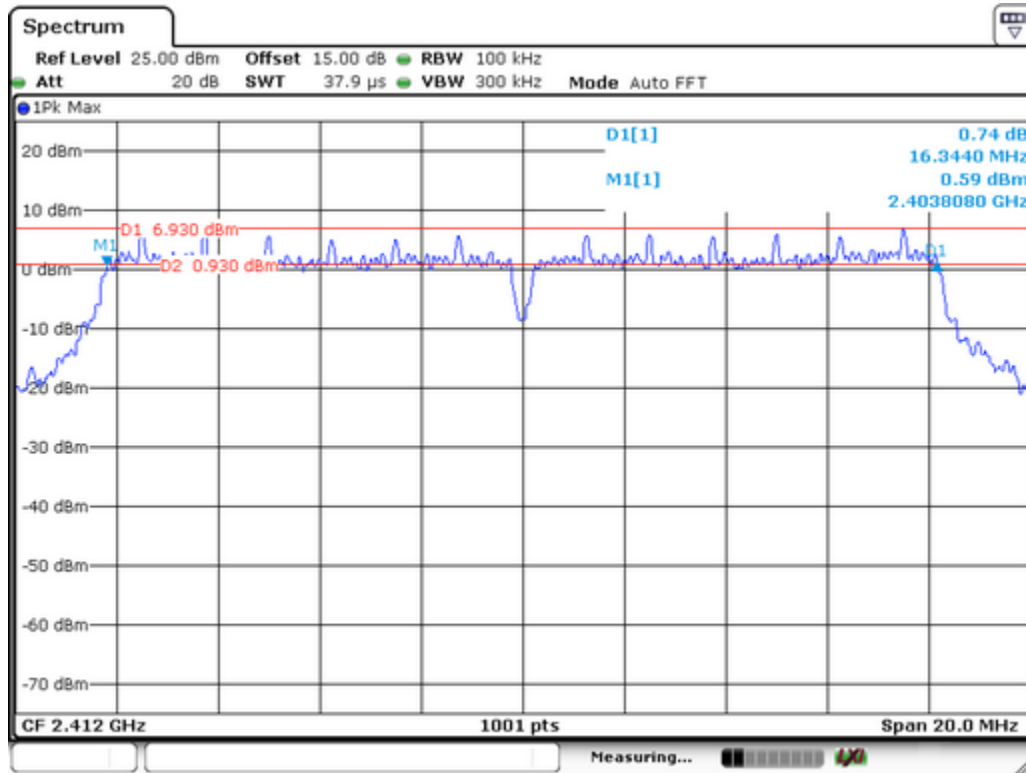

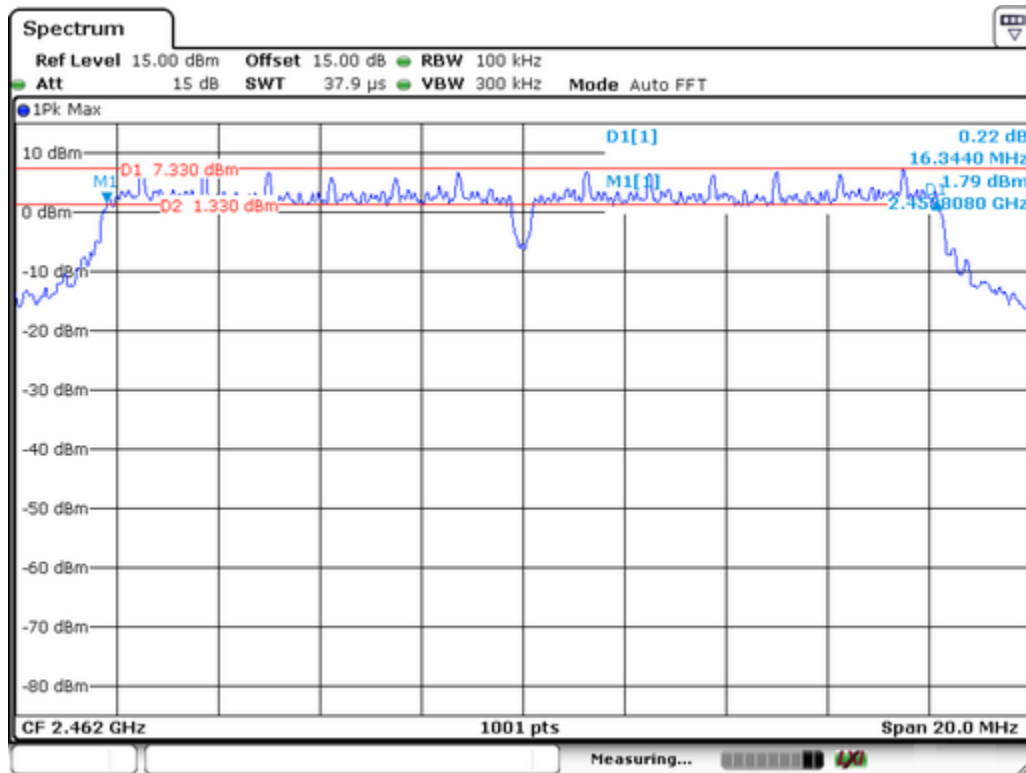
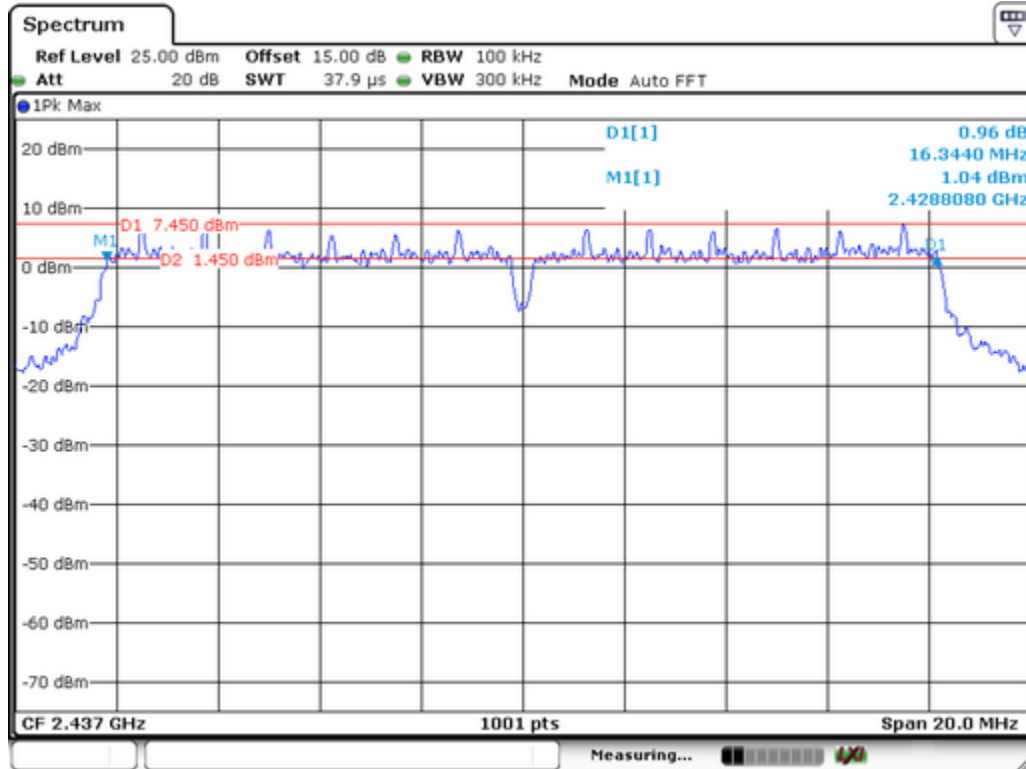

IEEE 802.11n(HT20) MIMO				
Channel frequency (MHz)	Measurement level (kHz)		Required Limit (kHz)	Result
	Ant1	Ant2		
2412	17303	17303	>500	Pass
2437	17303	17303	>500	
2462	17303	17303	>500	

Ant1

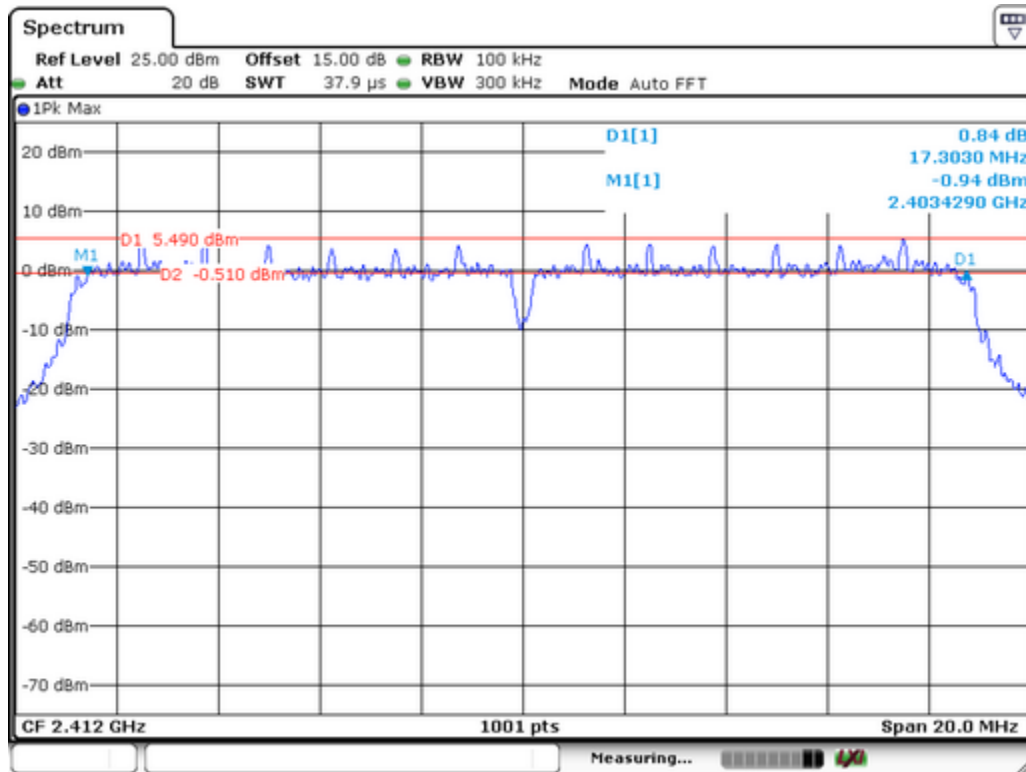

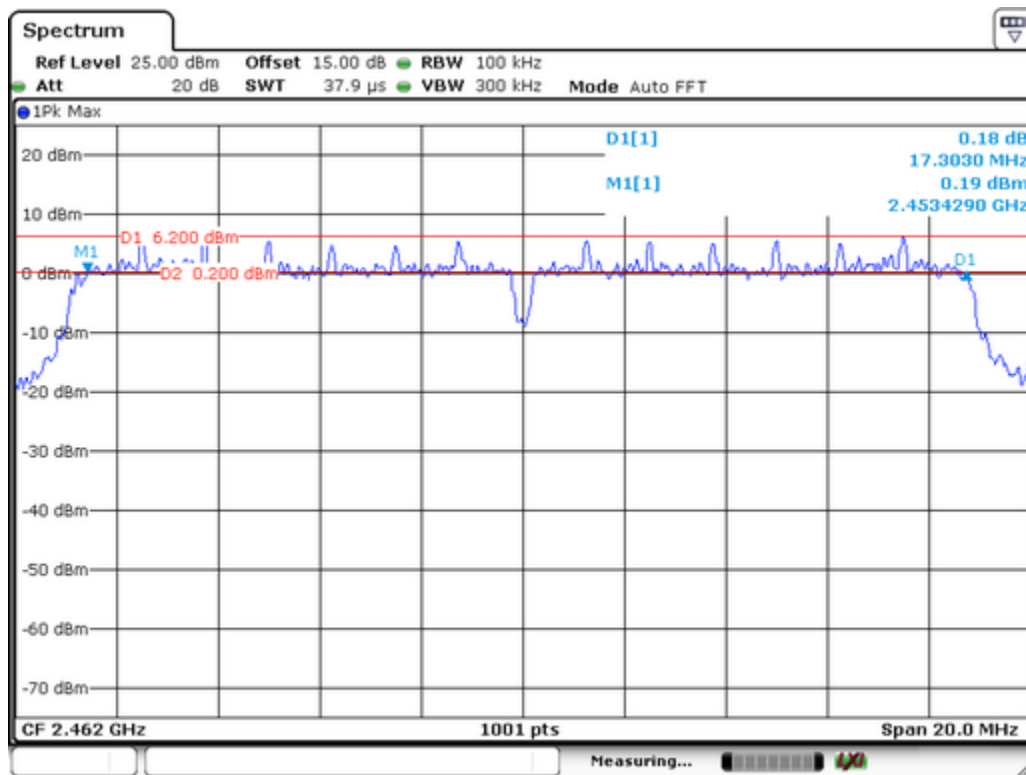
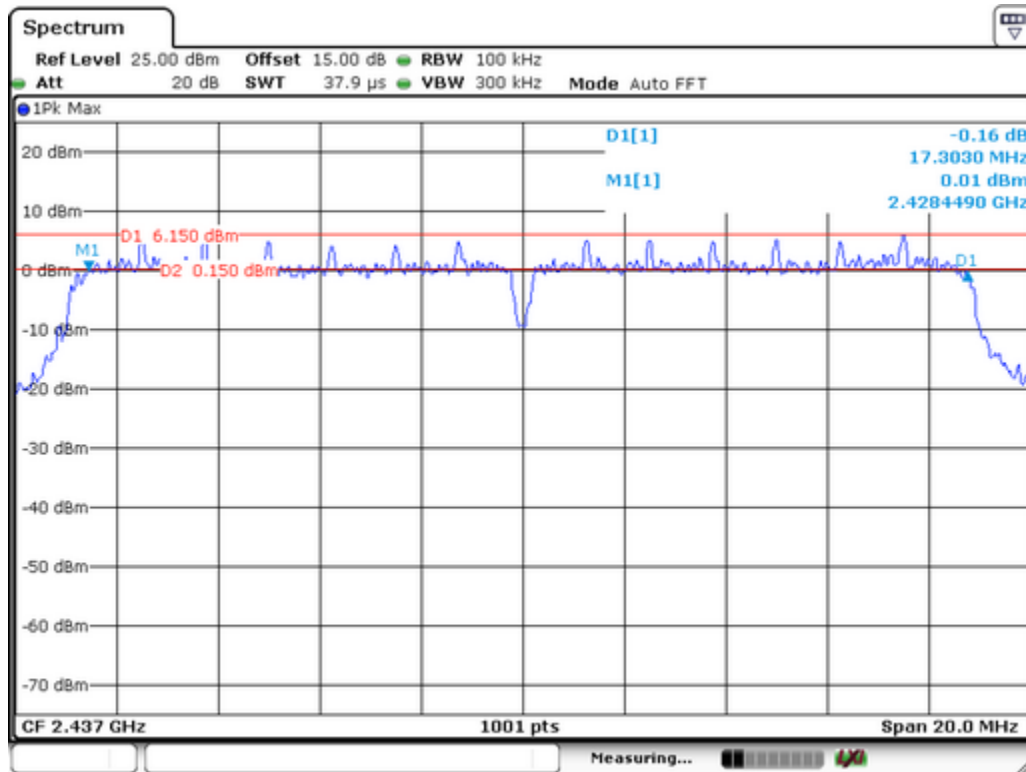

Ant2

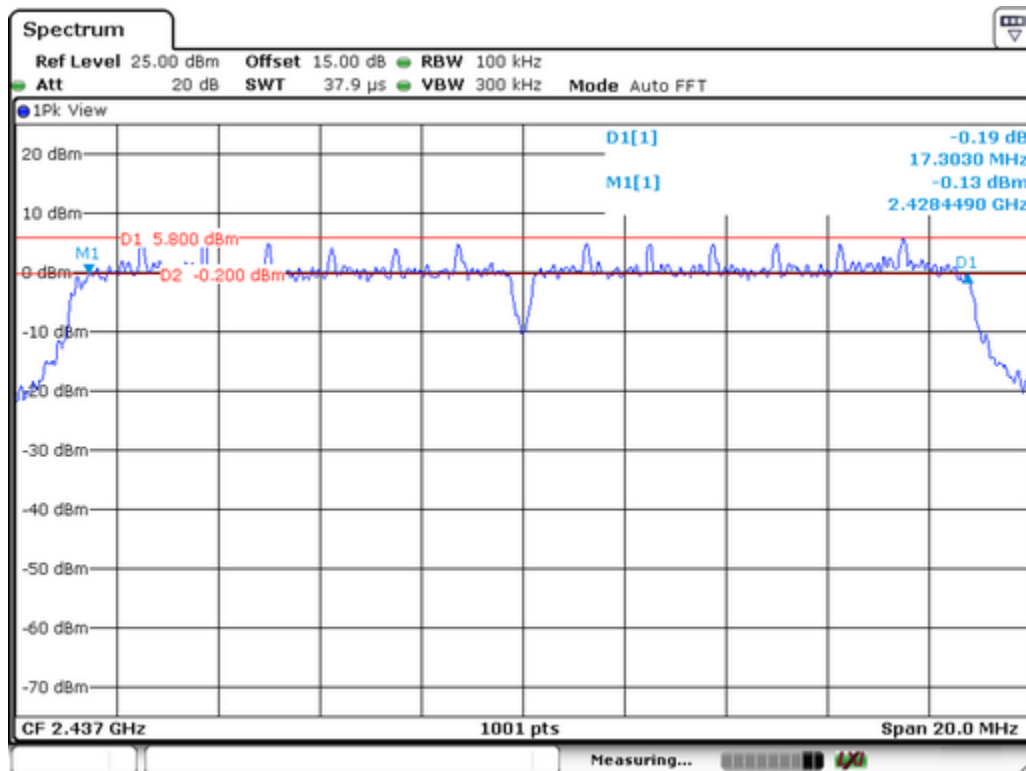
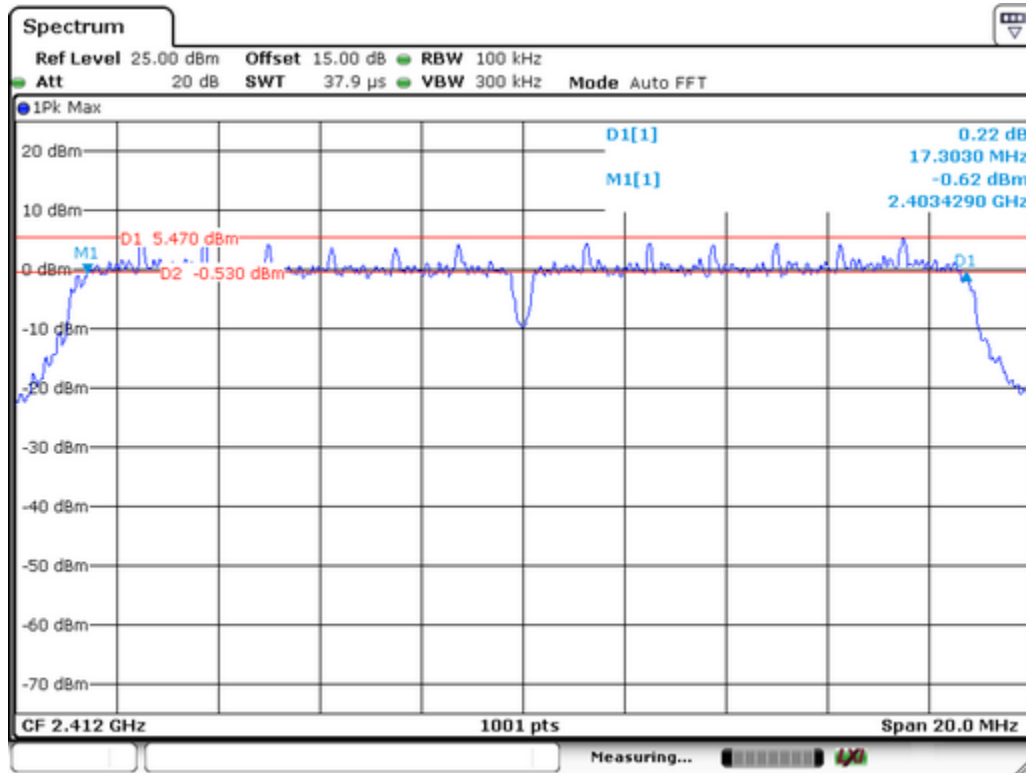

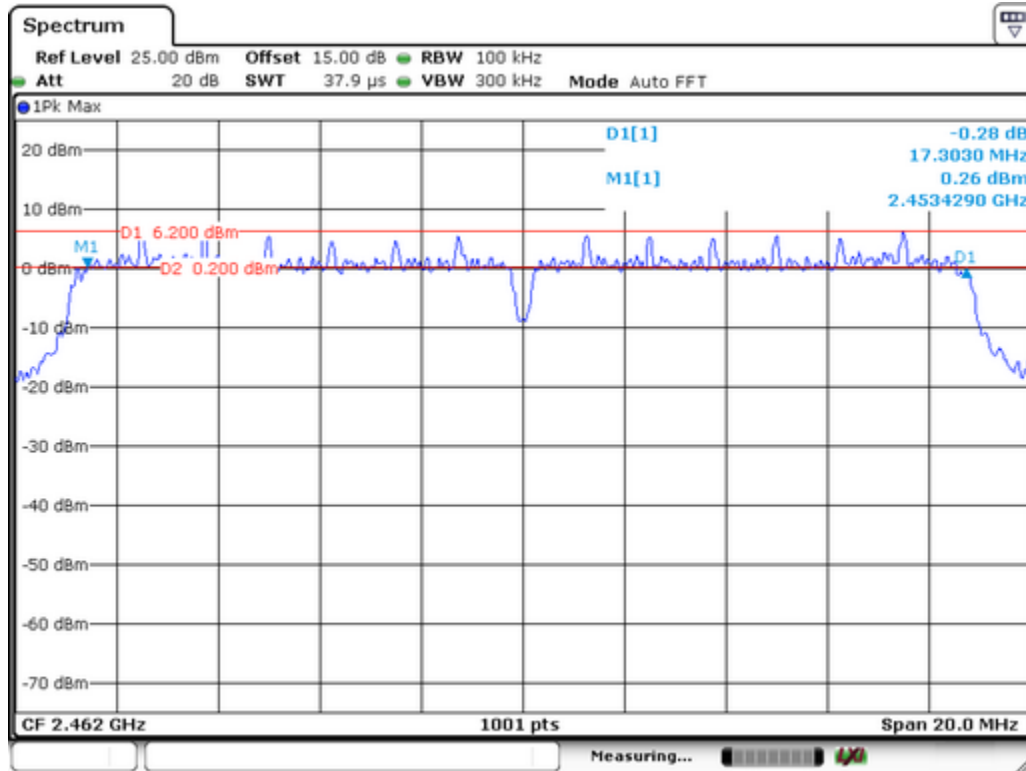

IEEE 802.11n (HT40) MIMO				
Channel frequency (MHz)	Measurement level (kHz)		Required Limit (kHz)	Result
	Ant1	Ant2		
2422	36284	36284	>500	Pass
2437	36284	36284	>500	
2452	36284	36284	>500	

Ant1

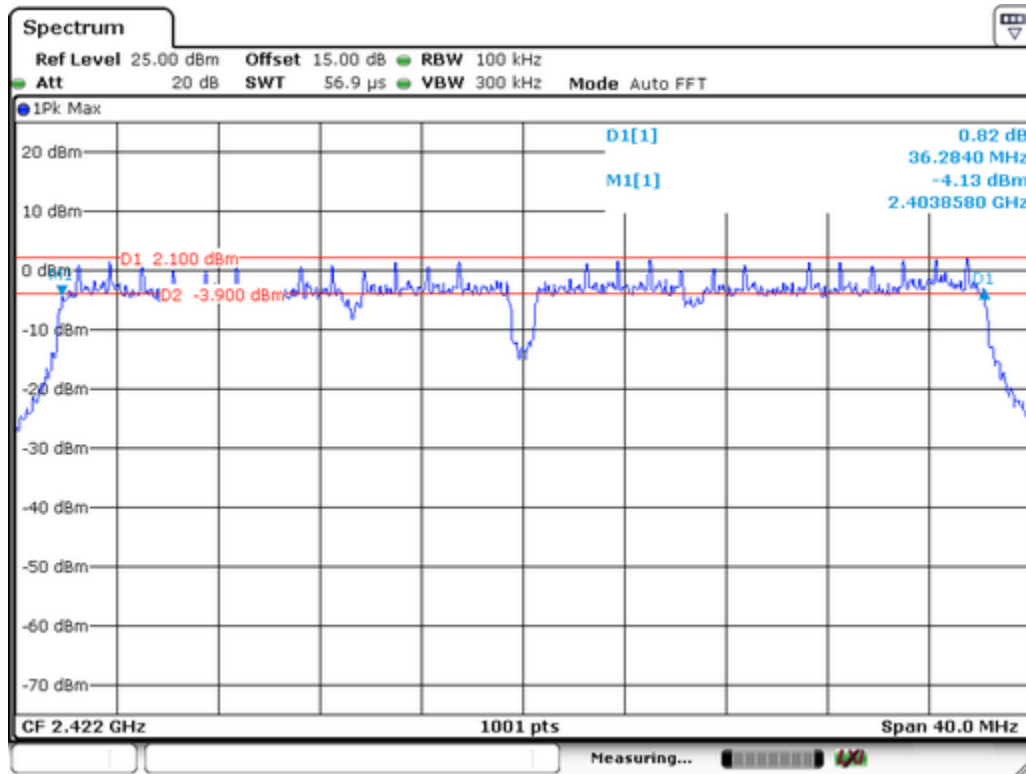

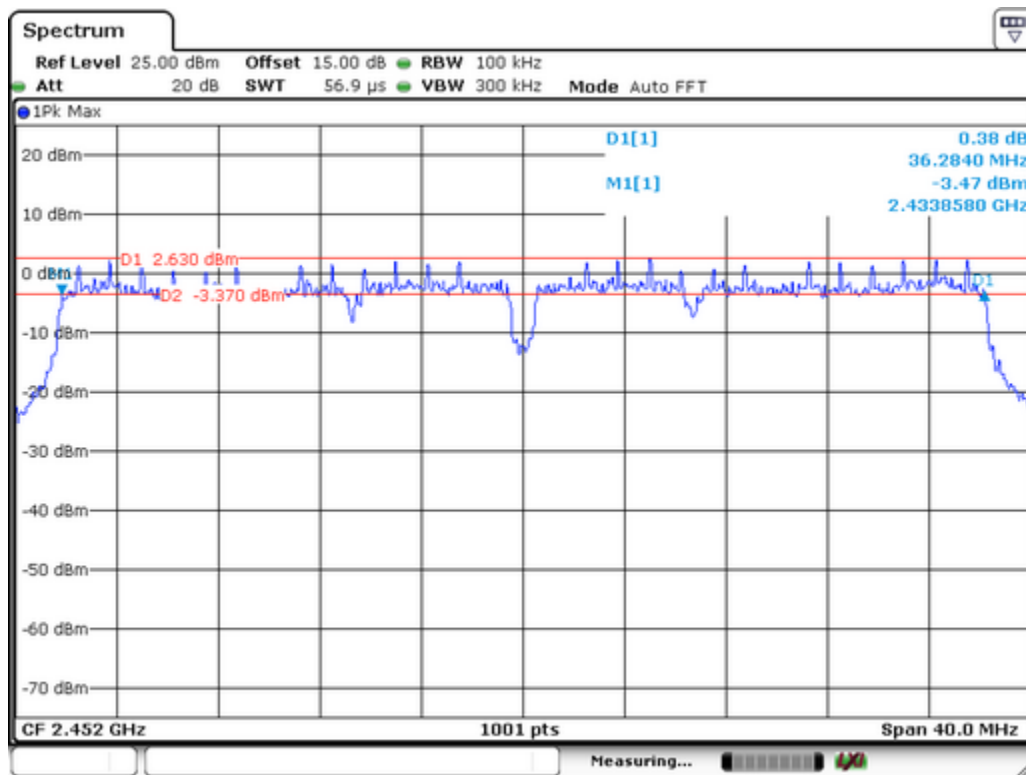
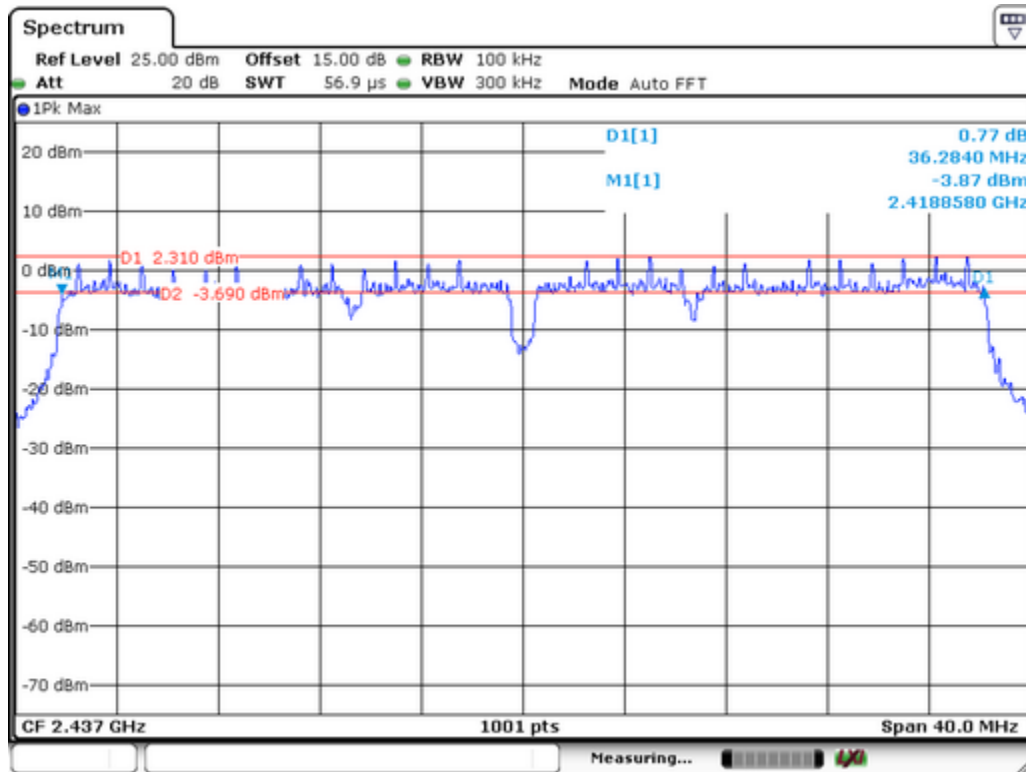

Ant2

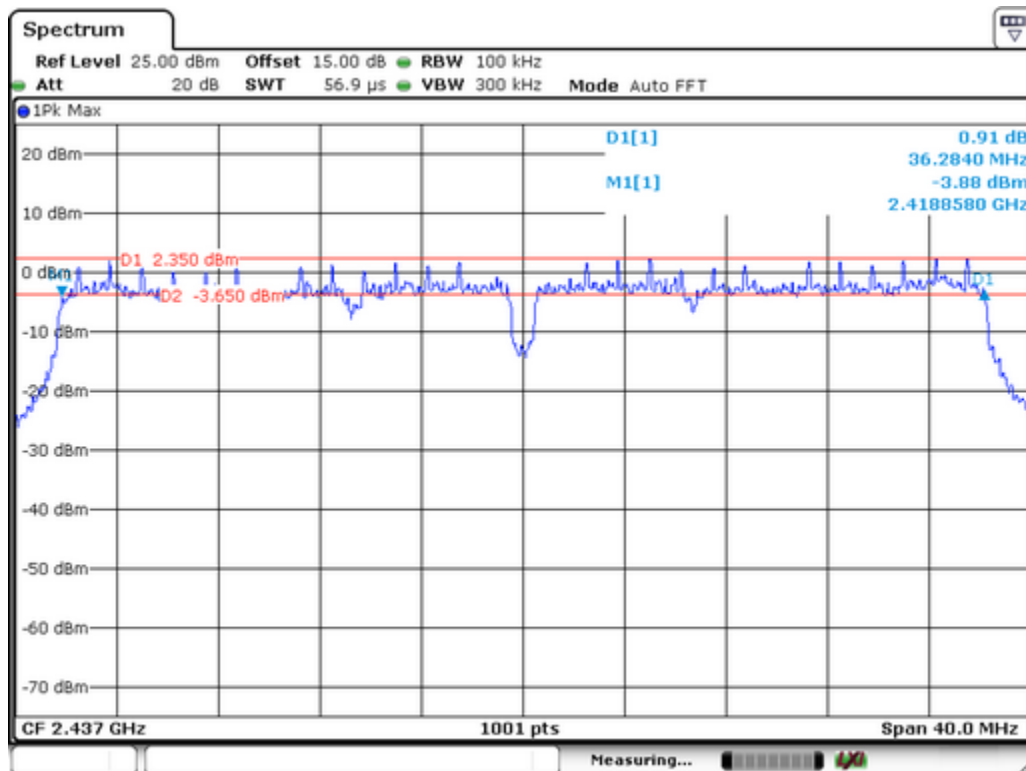
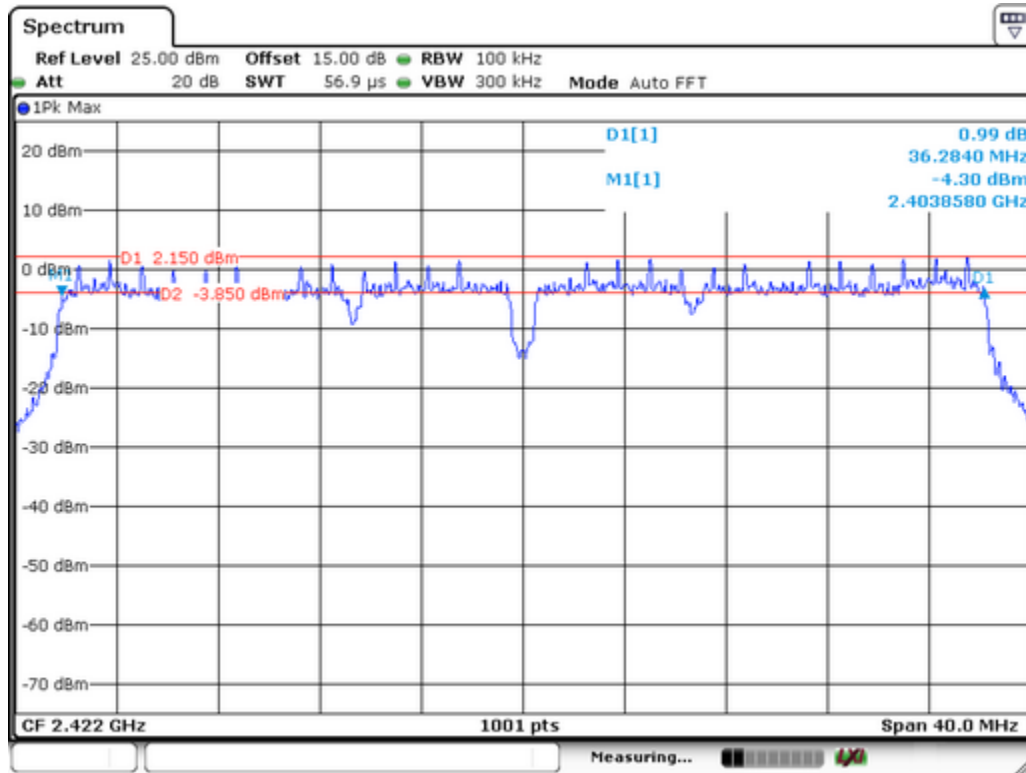

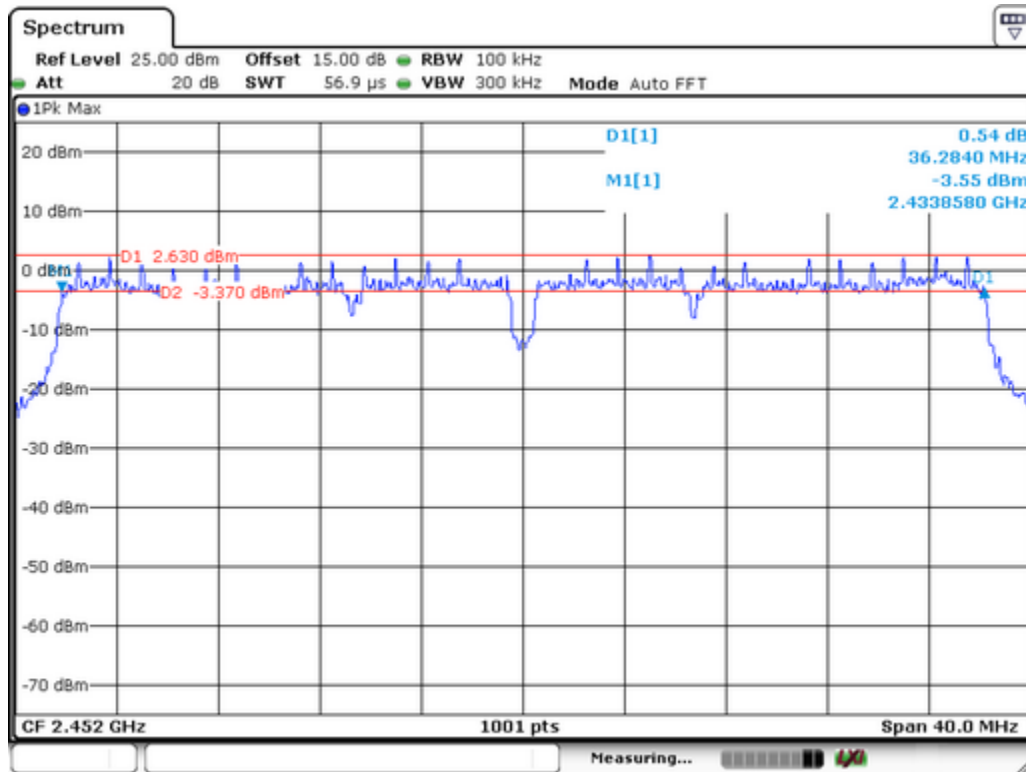

11. Maximum Peak Output Power Test

11.1 Measurement Procedure

(1) According to FCC Part 15.247(b)(3)

The maximum peak conducted output power may be measured using a broadband peak RF power meter. The power meter shall have a video bandwidth that is greater than or equal to the DTS bandwidth and shall utilize a fast-responding diode detector.

The testing follows FCC public Notice DA 00-705 Measurement Guidelines.

The RF output of EUT was connected to the power meter by RF cable and attenuator. The path loss was compensated to the results for each measurement.

Set to the maximum output power setting and enable the EUT transmit continuously.

Measure the conducted output power with cable loss and record the results in the test report.

Measure and record the results in the report.

(2) According to FCC Part 15.247(b)(4):

Conducted output power limit specified in paragraph (b) of this section is based on the use of antennas with directional gains that do not exceed 6 dBi. If transmitting antennas of directional gain greater than 6 dBi are used, the conducted output power from the intentional radiator shall be reduced below the stated values in paragraphs (b)(3) of this section, as appropriate, by the amount in dB that the directional gain of the antenna exceeds 6 dBi.

Note: If antenna Gain exceeds 6 dBi, then Output power Limit = $30 - (\text{Gain} - 6)$

11.2 Test SET-UP (Block Diagram of Configuration)



11.3 Measurement Equipment Used

EQUIPMENT TYPE	MODEL NUMBER	SERIAL NUMBER	LAST CAL.	CAL DUE.
Power meter	ML2495A	0824006	05/16/2018	05/15/2019
Power sensor	MA2411B	0738172	05/16/2018	05/15/2019

11.4 Peak Power output limit

The maximum peak conducted output power of the intentional radiator for systems using digital modulation in the 2400 - 2483.5 MHz bands shall not exceed: 1 Watt (30dBm).

11.5 Measurement Results

Spectrum Detector:	PK	Test Date :	October 11,2018
Test By:	Andy	Temperature :	27°C
Test Result:	PASS	Humidity :	60%

Operation Mode	Channel Number	Channel Frequency (MHz)	Measurement Level (dBm)			Limit (dBm)	Verdict
			Ant1	Ant2	Sum		
802.11b	1	2412	15.04	15.73	--	30	PASS
	6	2437	16.13	15.64	--	30	PASS
	11	2462	16.49	16.07	--	30	PASS
802.11g	1	2412	14.13	14.05	--	30	PASS
	6	2437	13.72	14.57	--	30	PASS
	11	2462	13.44	12.26	--	30	PASS
802.11n (HT20)	1	2412	10.27	11.33	13.84	30	PASS
	6	2437	9.38	10.49	12.98	30	PASS
	11	2462	9.57	8.75	12.19	30	PASS
802.11n (HT40)	3	2422	8.46	9.62	12.09	30	PASS
	6	2437	7.32	9.15	11.34	30	PASS
	9	2452	8.05	7.37	10.73	30	PASS

Note:

1. For MIMO System of 802.11n(HT20) and 802.11n(HT40), total power is calculated by combining the output power of each antenna according to KDB662911.
2. Antenna 1 Gain: 1.21dBi, Antenna 2 Gain: 1.21dBi. For antennas with gains of 6dBi or less, maximum allowed Transmitter output watt(+30dBm)
3. In MIMO, Ant1+Ant2 Directional
Gain= $G_{ANT}+10\text{Log}(N)\text{dBi}=1.21+10\log(2)=4.22\text{dBi}$.

12. Band Edge Test

12.1 Measurement Procedure

For Conducted Test

1. The testing follows FCC KDB Publication No. 558074 DTS D01 Meas. Guidance v04.
2. The RF output of EUT was connected to the spectrum analyzer by RF cable and attenuator. The path loss was compensated to the results for each measurement.
3. Set to the maximum power setting and enable the EUT transmit continuously.
4. Set RBW = 100 kHz, VBW=300 kHz, Peak Detector. Unwanted Emissions measured in any 100 kHz bandwidth outside of the authorized frequency band shall be attenuated by at least 20 dB relative to the maximum in-band peak PSD level in 100 kHz when maximum peak conducted output power procedure is used. Measure and record the results in the test report.
5. The RF fundamental frequency should be excluded against the limit line in the operating frequency band.

For Radiated emission Test

1. The testing follows FCC KDB Publication No. 558074 DTS D01 Meas. Guidance v04.
2. The EUT was arranged to its worst case and then tune the antenna tower (from 1 m to 4 m) and turntable (from 0 degree to 360 degrees) to find the maximum reading. A pre-amp and a high pass filter are used for the test in order to get better signal level.
3. The EUT was placed on a turntable with 0.8 meter above ground.
4. The EUT was set 3 meters from the interference receiving antenna, which was mounted on the top of a variable height antenna tower.
5. Corrected Reading: Antenna Factor + Cable Loss + Read Level - Preamp Factor = Level.
6. For measurement below 1GHz, If the emission level of the EUT measured by the peak detector is 3 dB lower than the applicable limit, the peak emission level will be reported. Otherwise, the emission measurement will be repeated using the quasi-peak detector and reported.
7. Repeat above procedures until all frequency measured were complete.

When spectrum scanned above 1GHz setting resolution bandwidth 1MHz, video bandwidth 3MHz.

EMI Test Receiver	Setting
Attenuation	Auto
RBW	1MHz
VBW	3MHz
Detector	Peak
Trace	Max hold

When spectrum scanned above 1GHz setting resolution bandwidth 1MHz, video bandwidth 10Hz.

EMI Test Receiver	Setting
Attenuation	Auto
RBW	1MHz
VBW	10Hz
Detector	Peak
Trace	Max hold

12.2 Test SET-UP (Block Diagram of Configuration)

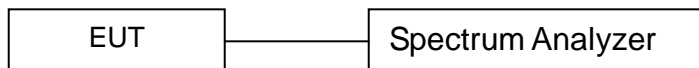

12.3 Measurement Equipment Used

EQUIPMENT TYPE	MFR	MODEL NUMBER	SERIAL NUMBER	LAST CAL.	CAL DUE.
Spectrum Analyzer	Agilent	FSV30	1321.3008K	05/16/2018	05/15/2019

12.4 Measurement Results

1. Conducted Test

Test Mode: IEEE 802.11b SISO Ant1

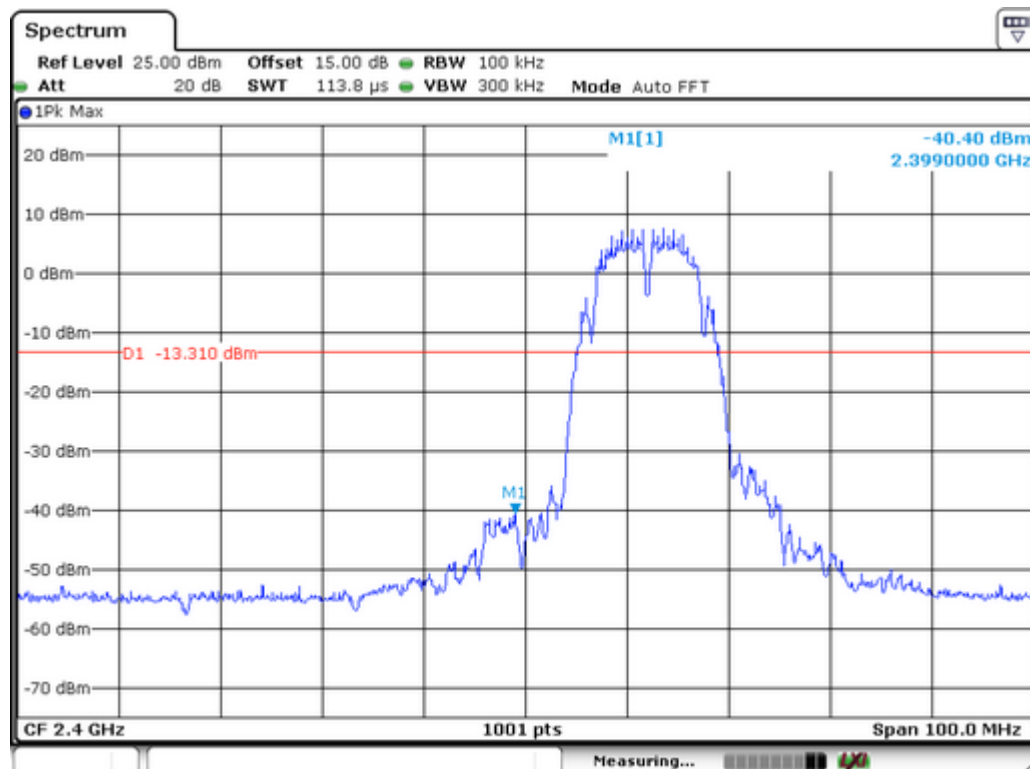



Test Mode: IEEE 802.11b SISO Ant2

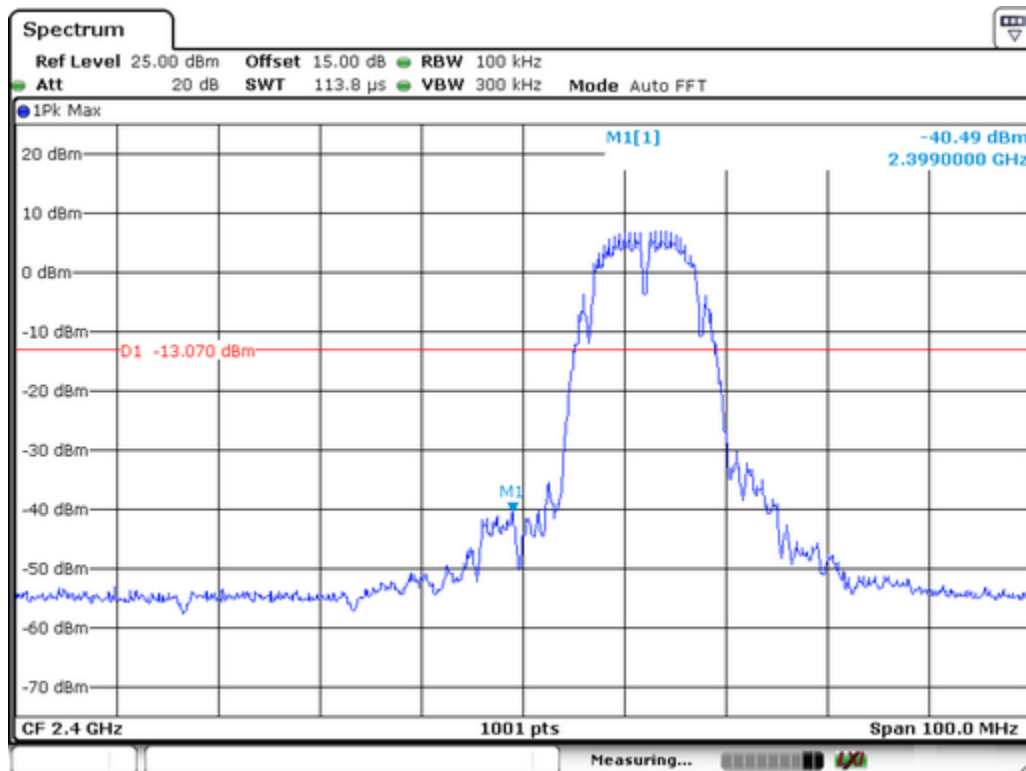

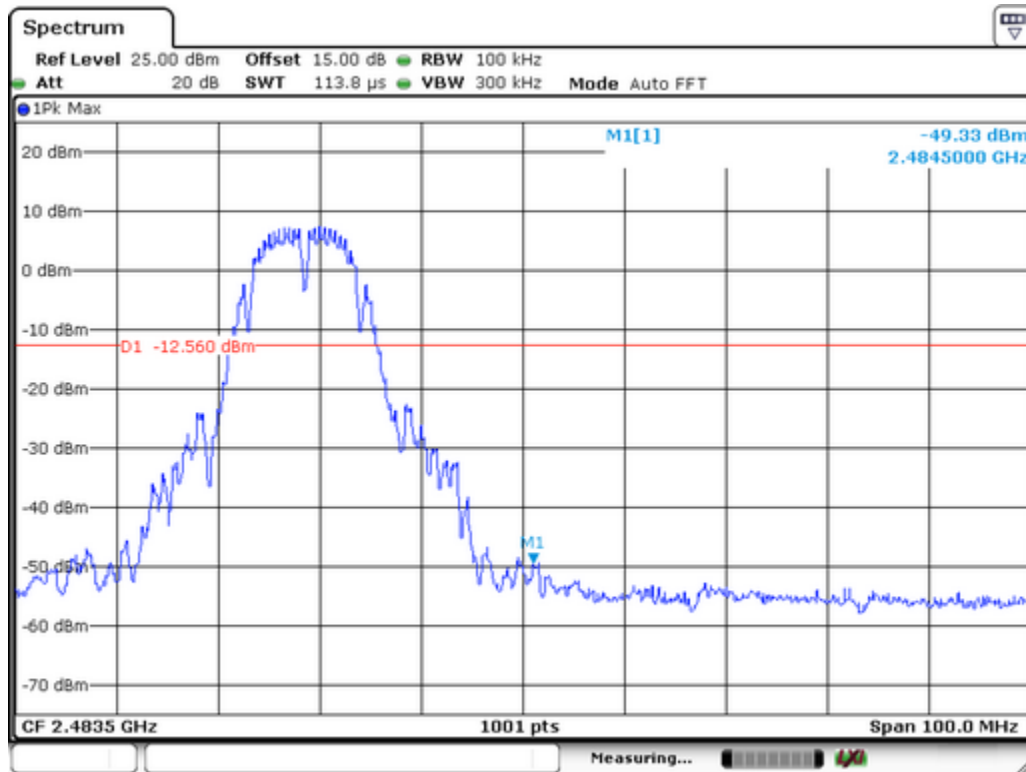

Test Mode: IEEE 802.11g SISO Ant1

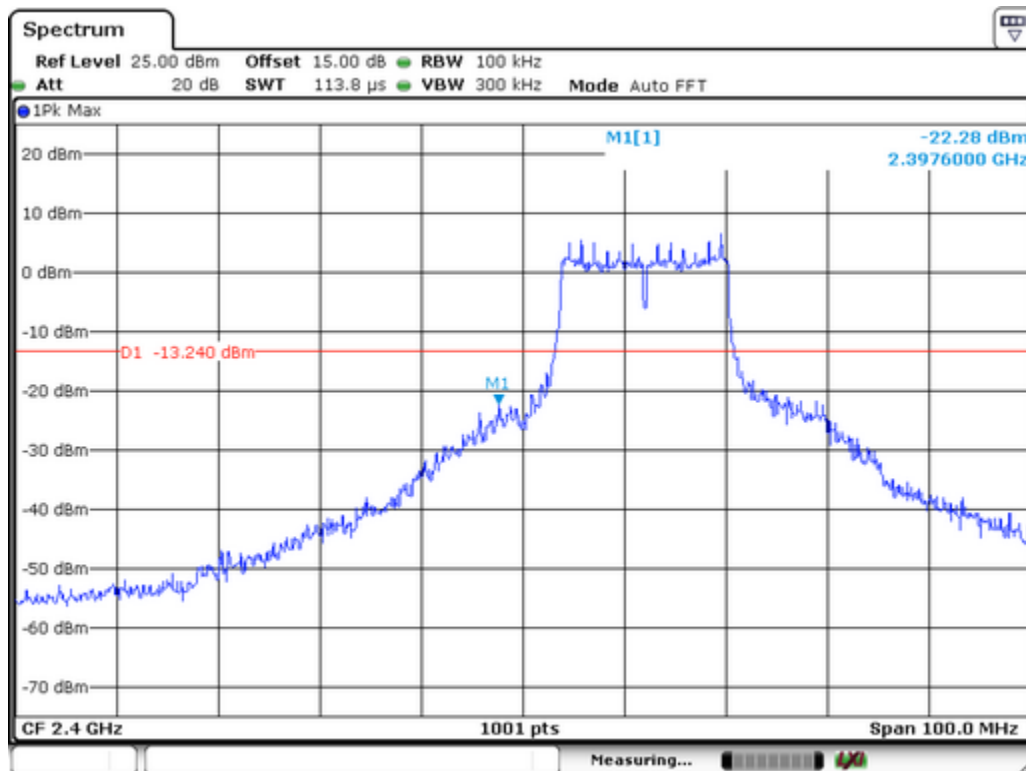

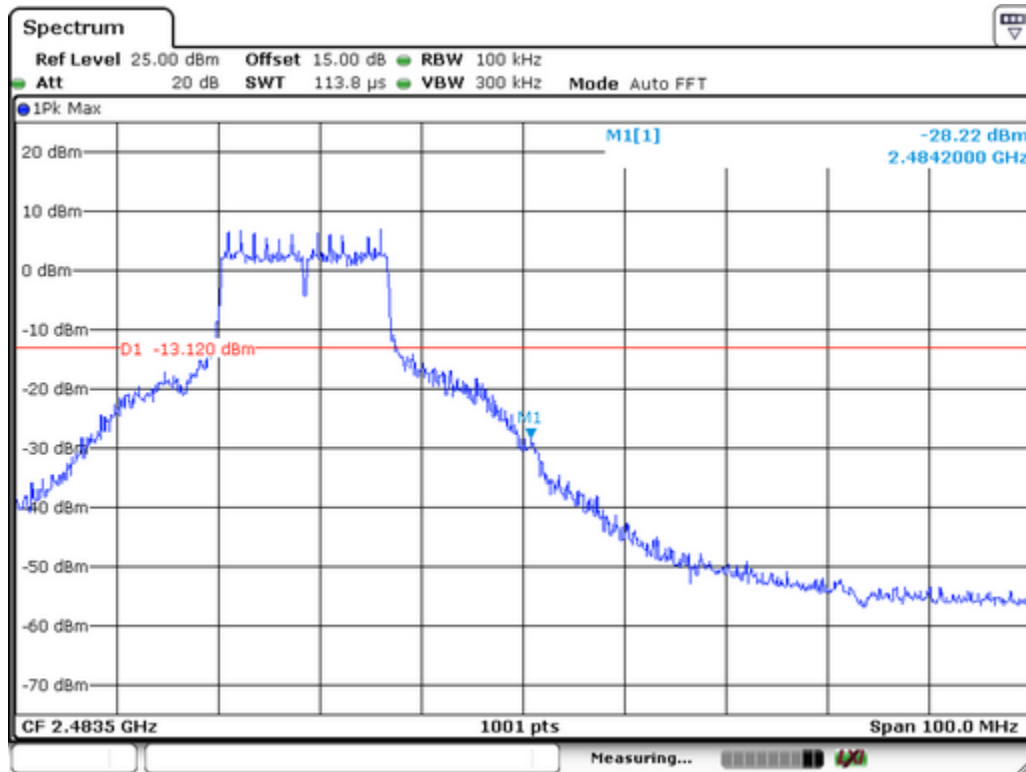

Test Mode: IEEE 802.11g SISO Ant2

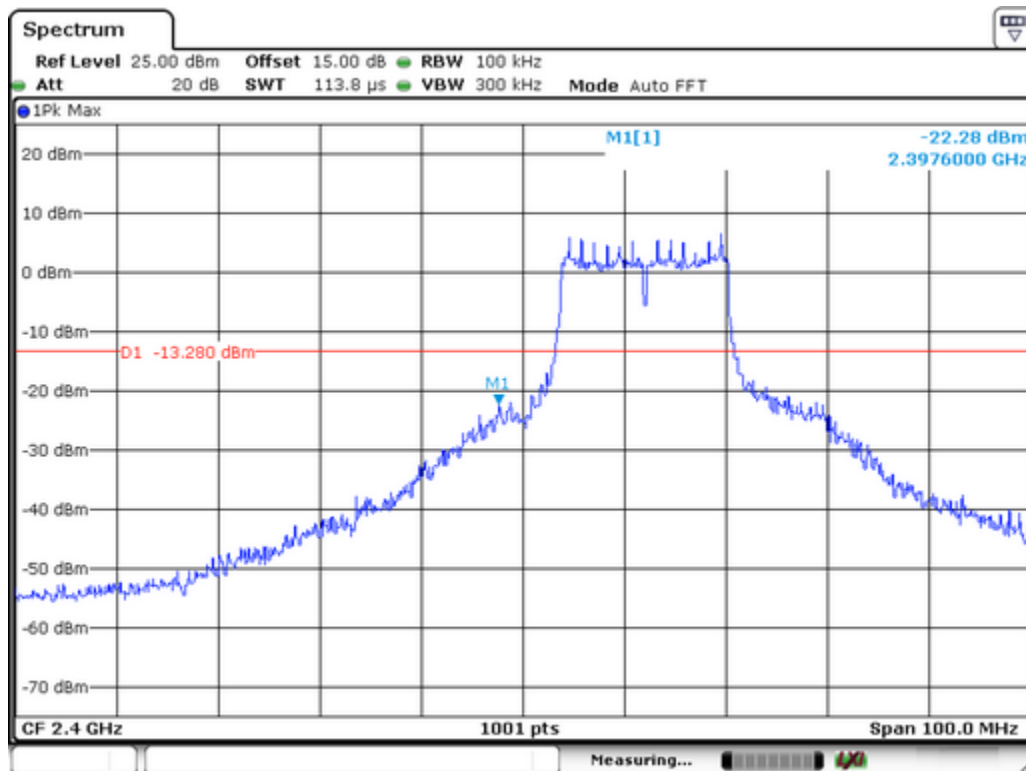

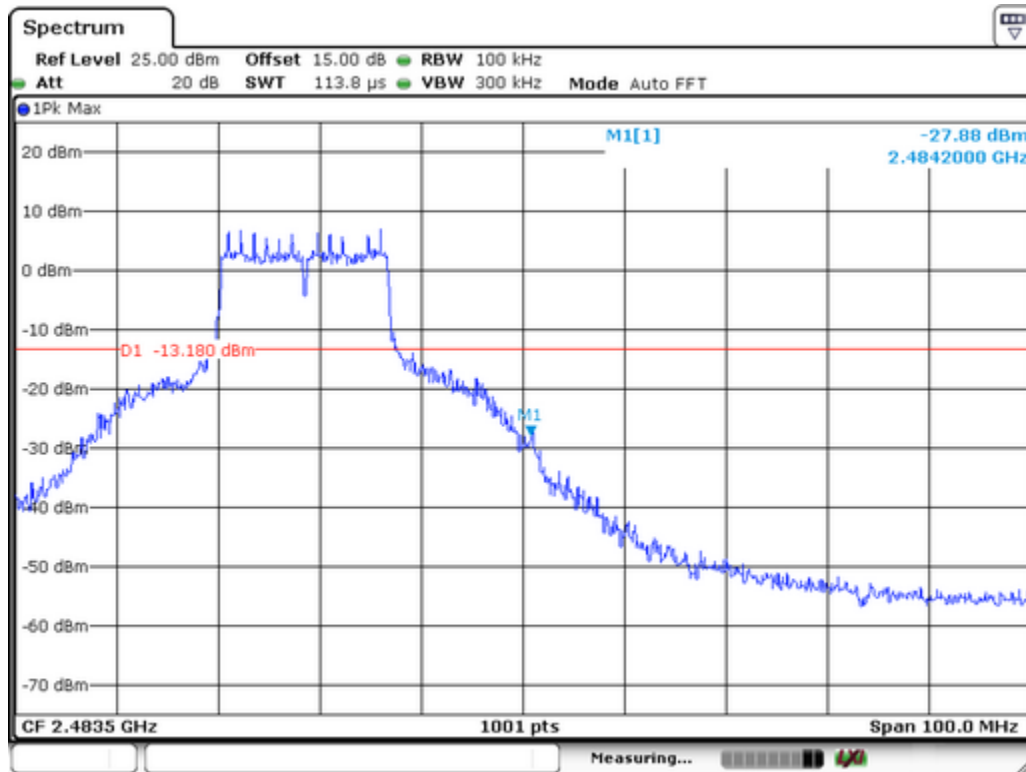

Test Mode: IEEE 802.11n(HT20) MIMO

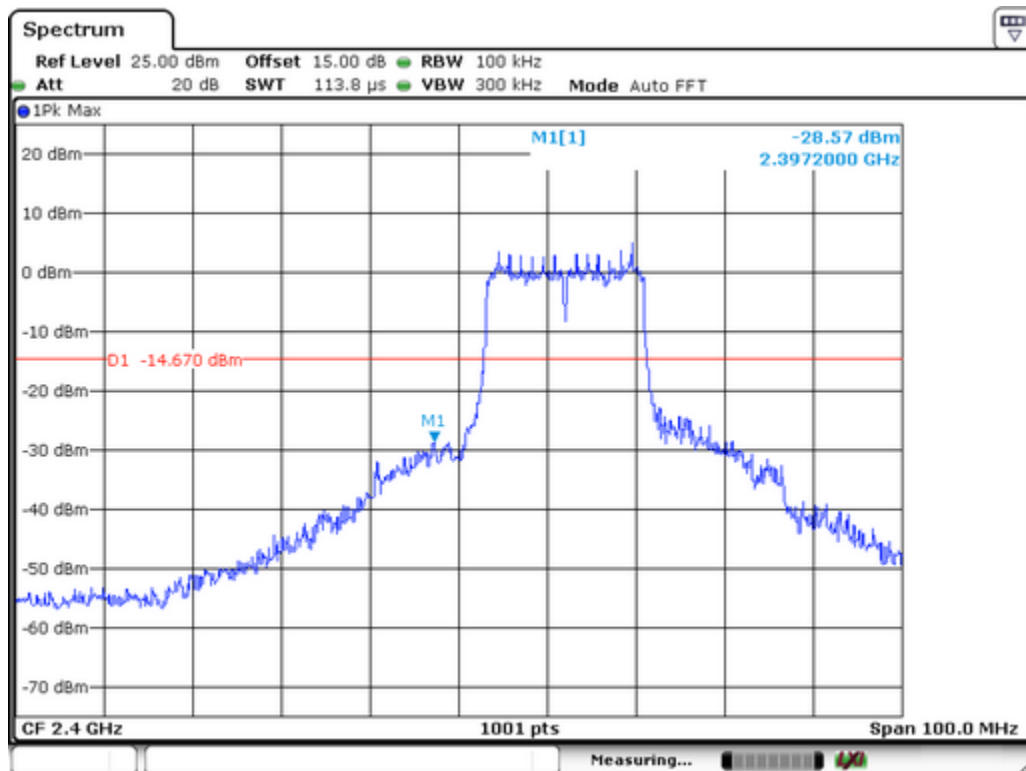

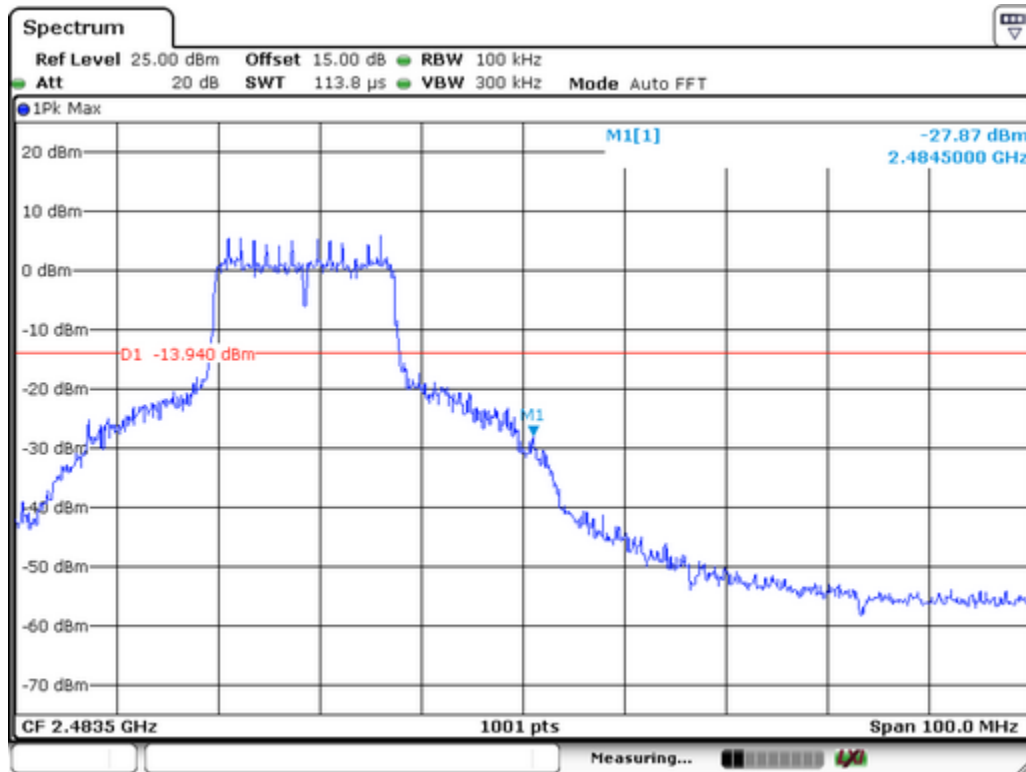

Test Mode: IEEE 802.11n(HT40) MIMO

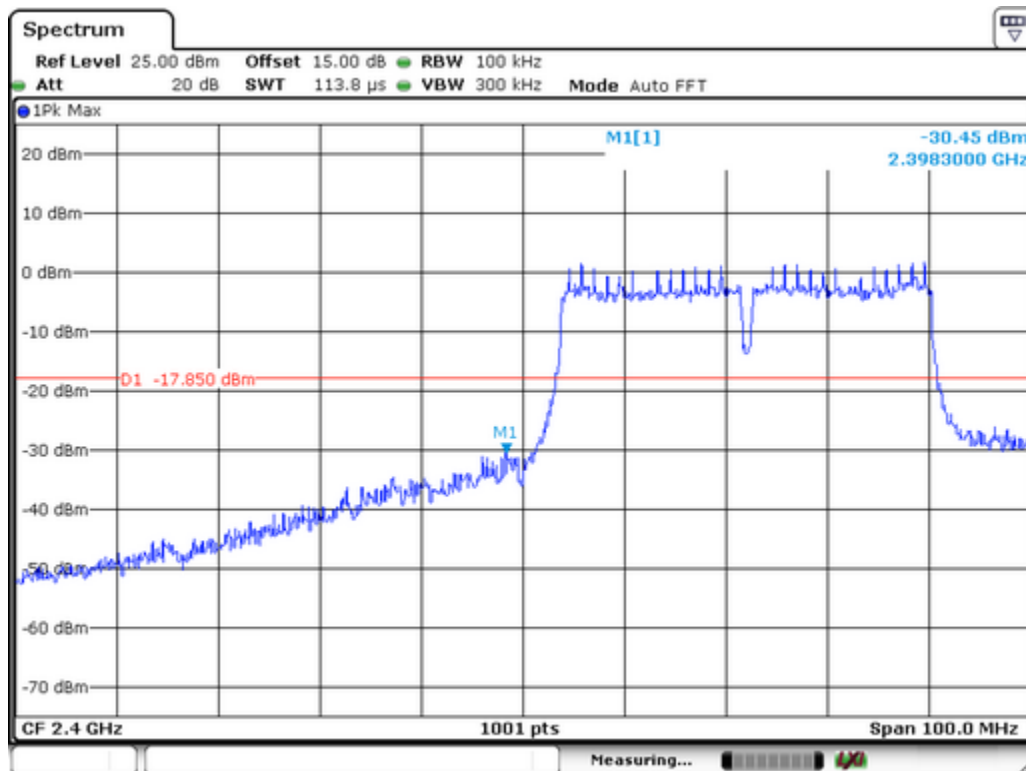

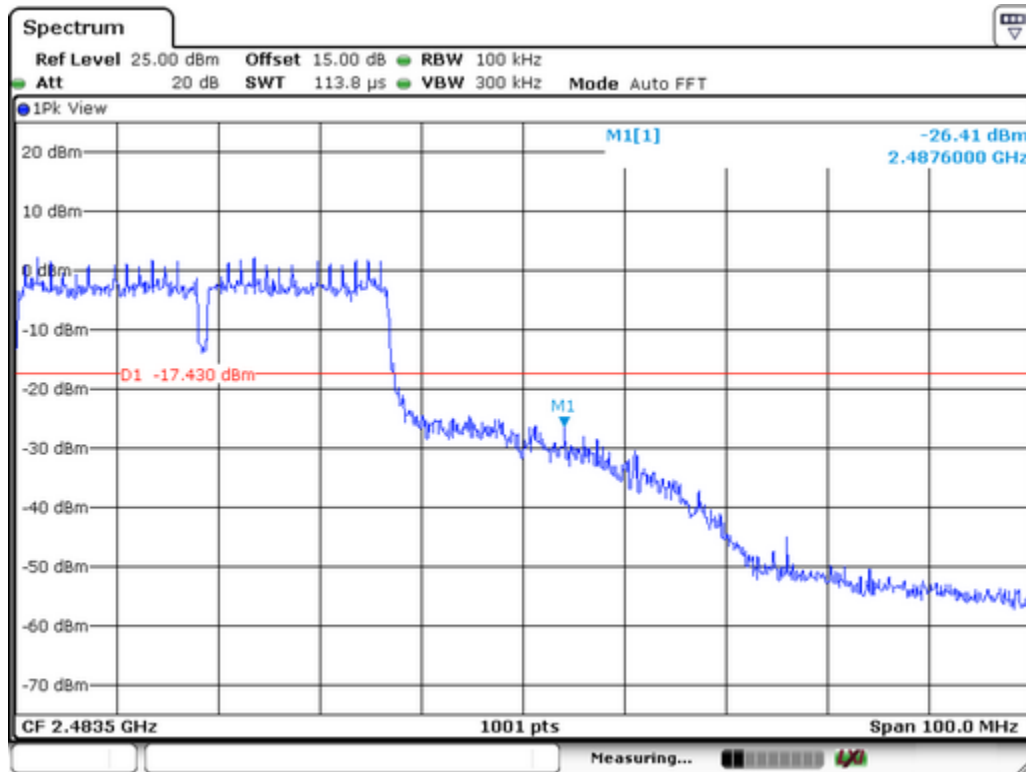

Radiated emission Test

Spectrum Detector: PK/AV
 Test By: Andy
 Humidity : 60 %

Test Date : October 11, 2018
 Temperature : 27 °C

Freq. (MHz)	Ant. Pol.	Reading Level(dBuV/m)		Correct Factor dB	Emission Level(dBuV/m)		Limit 3m(dBuV/m)		Margin(dB)	
		PK	AV		PK	AV	PK	AV	PK	AV
<2400	H	86.65	68.41	-26.3	60.35	42.11	74	54	-13.65	-11.89
<2400	V	85.65	65.59	-26.1	59.55	39.49	74	54	-14.45	-14.51
>2483.5	H	88.09	67.52	-26.3	61.79	41.22	74	54	-12.21	-12.78
>2483.5	V	86.46	65.18	-26.1	60.36	39.08	74	54	-13.64	-14.92

IEEE 802.11b SISO Ant2

Freq. (MHz)	Ant. Pol.	Reading Level(dBuV/m)		Correct Factor dB	Emission Level(dBuV/m)		Limit 3m(dBuV/m)		Margin(dB)	
		PK	AV		PK	AV	PK	AV	PK	AV
<2400	H	89.84	69.84	-26.3	63.54	43.54	74	54	-10.46	-10.46
<2400	V	88.21	68.29	-26.1	62.11	42.19	74	54	-11.89	-11.81
>2483.5	H	88.35	68.99	-26.3	62.05	42.69	74	54	-11.95	-11.31
>2483.5	V	86.79	65.99	-26.1	60.69	39.89	74	54	-13.31	-14.11

IEEE 802.11g SISO Ant1

Freq. (MHz)	Ant. Pol.	Reading Level(dBuV/m)		Correct Factor dB	Emission Level(dBuV/m)		Limit 3m(dBuV/m)		Margin(dB)	
		PK	AV		PK	AV	PK	AV	PK	AV
<2400	H	90.45	70.55	-26.3	64.15	44.25	74	54	-9.85	-9.75
<2400	V	86.79	66.79	-26.1	60.69	40.69	74	54	-13.31	-13.31
>2483.5	H	87.89	67.78	-26.3	61.59	41.48	74	54	-12.41	-12.52
>2483.5	V	86.43	68.89	-26.1	60.33	42.79	74	54	-13.67	-11.21

IEEE 802.11g SISO Ant2

Freq. (MHz)	Ant. Pol.	Reading Level(dBuV/m)		Correct Factor dB	Emission Level(dBuV/m)		Limit 3m(dBuV/m)		Margin(dB)	
		PK	AV		PK	AV	PK	AV	PK	AV
<2400	H	90.88	68.79	-26.3	64.58	42.49	74	54	-9.42	-11.51
<2400	V	88.21	65.97	-26.1	62.11	39.87	74	54	-11.89	-14.13
>2483.5	H	86.89	67.88	-26.3	60.59	41.58	74	54	-13.41	-12.42
>2483.5	V	85.97	66.74	-26.1	59.87	40.64	74	54	-14.13	-13.36

IEEE 802.11n (HT20) M M O										
Freq. (MHz)	Ant. Pol.	Reading Level(dBuV/m)		Correct Factor dB	Emission Level(dBuV/m)		Limit 3m(dBuV/m)		Margin(dB)	
		PK	AV		PK	AV	PK	AV	PK	AV
<2400	H	89.27	70.32	-26.3	62.97	44.02	74	54	-11.03	-9.98
<2400	V	86.21	68.25	-26.1	60.11	42.15	74	54	-13.89	-11.85
>2483.5	H	88.76	68.64	-26.3	62.46	42.34	74	54	-11.54	-11.66
>2483.5	V	87.46	67.74	-26.1	61.36	41.64	74	54	-12.64	-12.36

IEEE 802.11n (HT40) M M O										
Freq. (MHz)	Ant. Pol.	Reading Level(dBuV/m)		Correct Factor dB	Emission Level(dBuV/m)		Limit 3m(dBuV/m)		Margin(dB)	
		PK	AV		PK	AV	PK	AV	PK	AV
<2400	H	89.99	69.84	-26.3	63.69	43.54	74	54	-10.31	-10.46
<2400	V	86.26	68.21	-26.1	60.16	42.11	74	54	-13.84	-11.89
>2483.5	H	87.25	66.99	-26.3	60.95	40.69	74	54	-13.05	-13.31
>2483.5	V	85.98	66.35	-26.1	59.88	40.25	74	54	-14.12	-13.75

13. Maximum Power Spectral Density

13.1 Test Equipment

EQUIPMENT TYPE	MFR	MODEL NUMBER	SERIAL NUMBER	LAST CAL.	CAL DUE.
Spectrum Analyzer	Agilent	FSV30	1321.3008K	05/16/2018	05/15/2019

13.2 Measuring Instruments and Setting

The following table is the setting of spectrum analyzer.

Spectrum analyzer	Setting
Attenuation	Auto
Span Frequency	Set the span to 1.5 times the DTS bandwidth.
RBW	3KHz
VBW	10KHz
Detector	Peak
Trace	Max hold
Sweep Time	Automatic

13.3 Test Procedures

- a. The transmitter output (antenna port) was connected to the spectrum analyzer.
- b. Set analyzer center frequency to DTS channel center frequency.
- c. Set the analyzer span to a minimum of 1.5 times the DTS bandwidth.
- d. Set the RBW=3KHz. Set the VBW=10KHz
- e. Detector = peak.
- f. Sweep time = auto couple.
- g. Trace mode = max hold.
- h. Allow trace to fully stabilize.
- i. Use the peak marker function to determine the maximum amplitude level.

13.4 Block Diagram of Test Setup

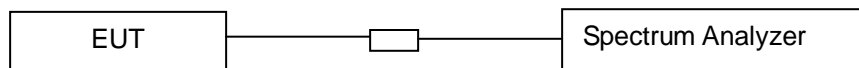

13.5 Limit

The transmitted power density averaged over any 1 second interval shall not be greater +8dBm in any 3 kHz bandwidth.

13.6 Test Result

Spectrum Detector: PK Test Date : October 11, 2018
 Test By: Andy Temperature : 27°C
 Humidity : 60%

IEEE 802.11b SISO Ant1			
Channel frequency (MHz)	Power Density (dBm/3kHz)	Power Density Limit (dBm/3kHz)	Result
2412	-7.86	8	Pass
2437	-8.23		
2462	-7.03		

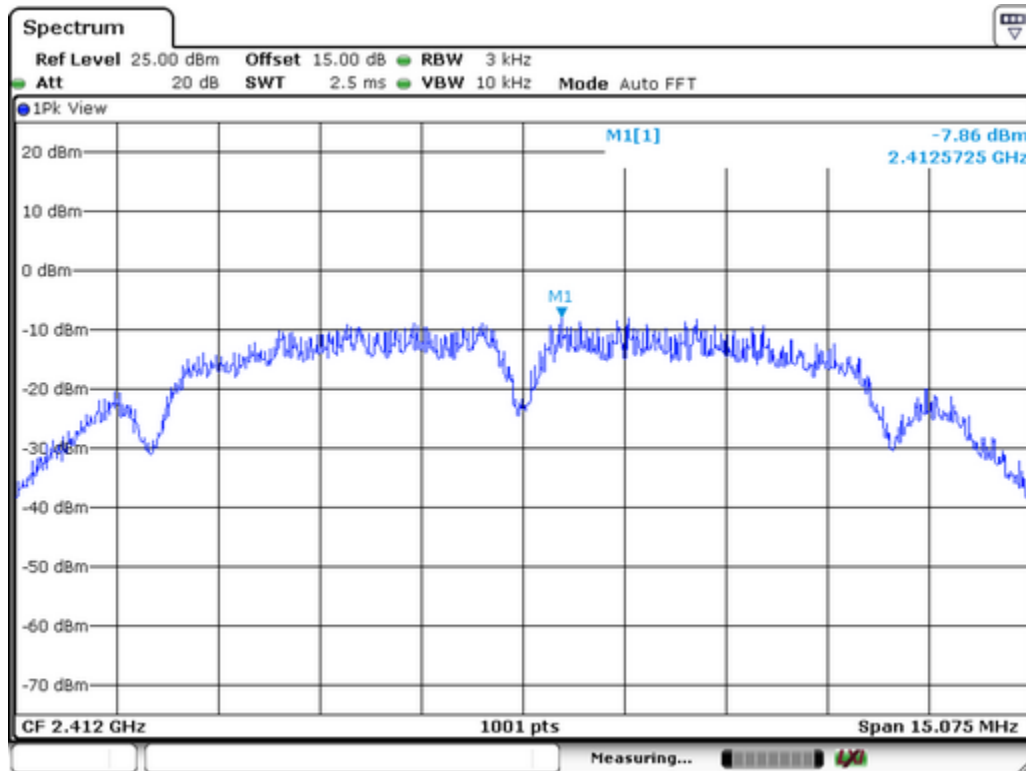

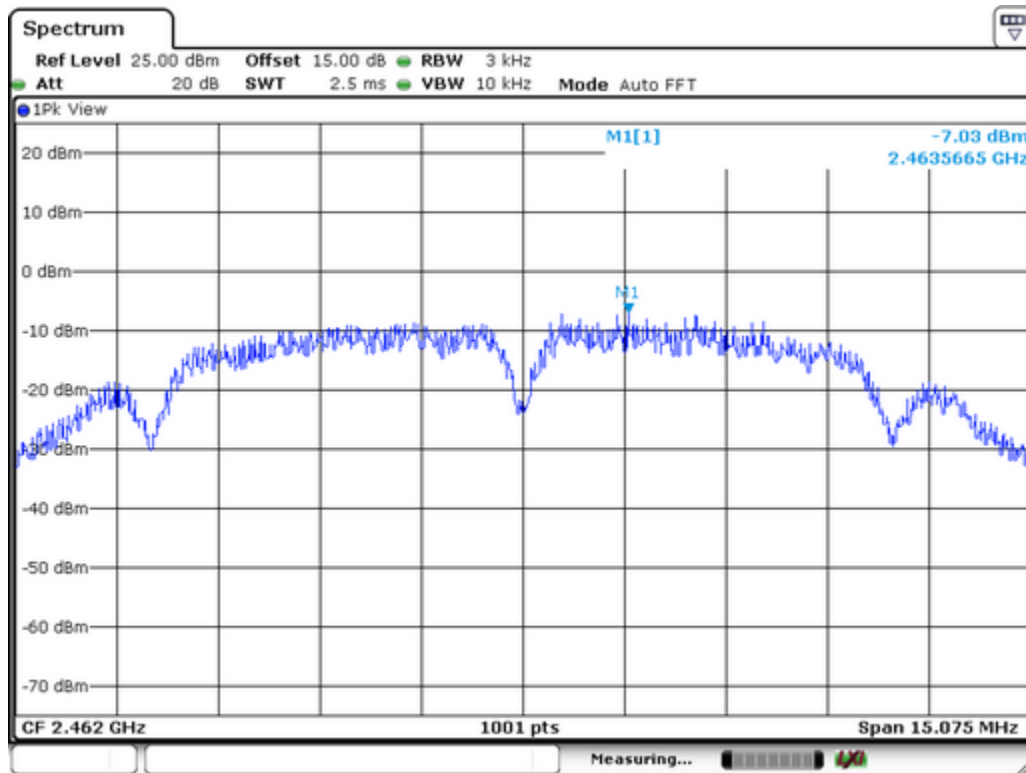
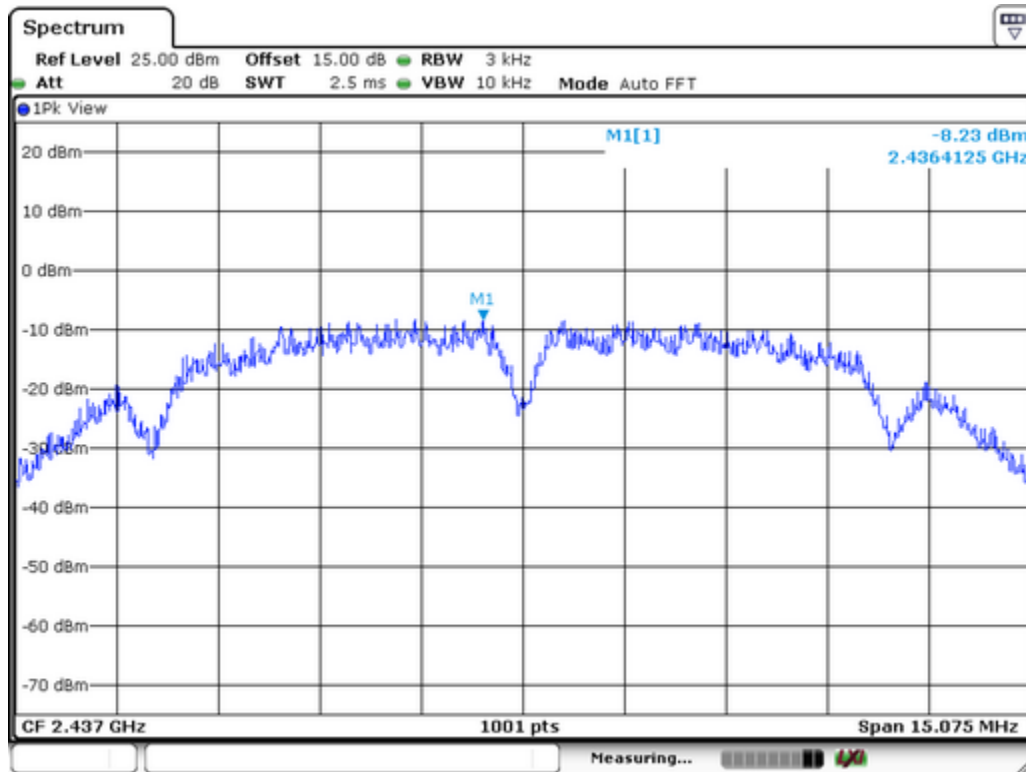

IEEE 802.11b SISO Ant2			
Channel frequency (MHz)	Power Density (dBm/3kHz)	Power Density Limit (dBm/3kHz)	Result
2412	-7.42	8	Pass
2437	-8.65		
2462	-7.42		

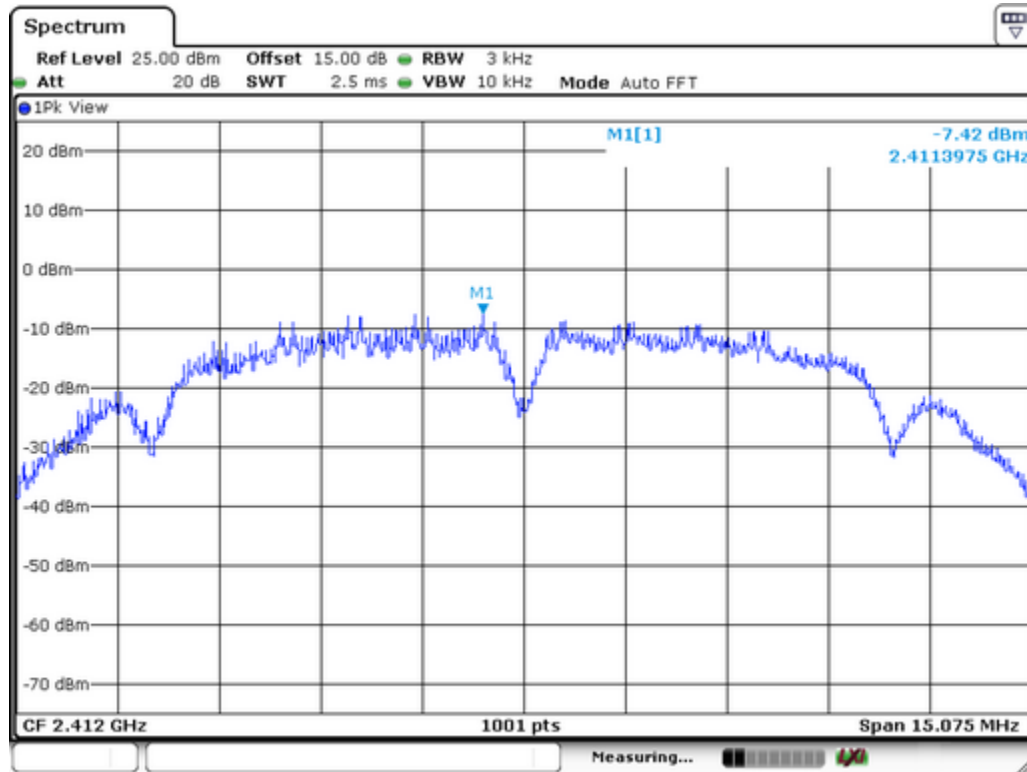

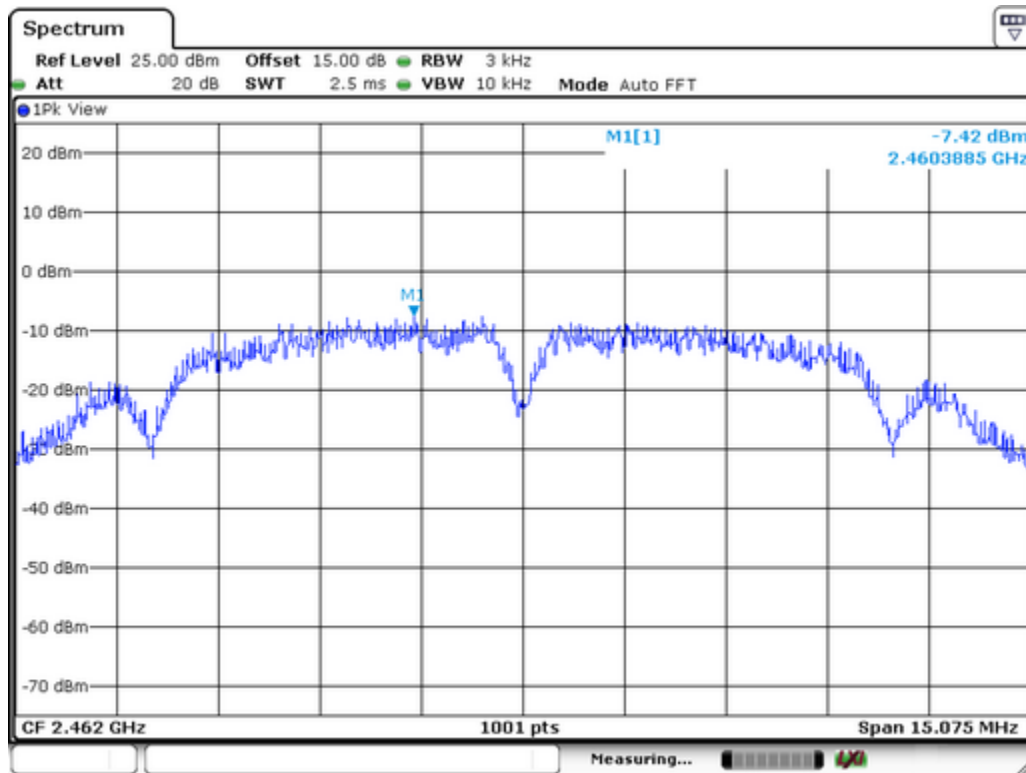
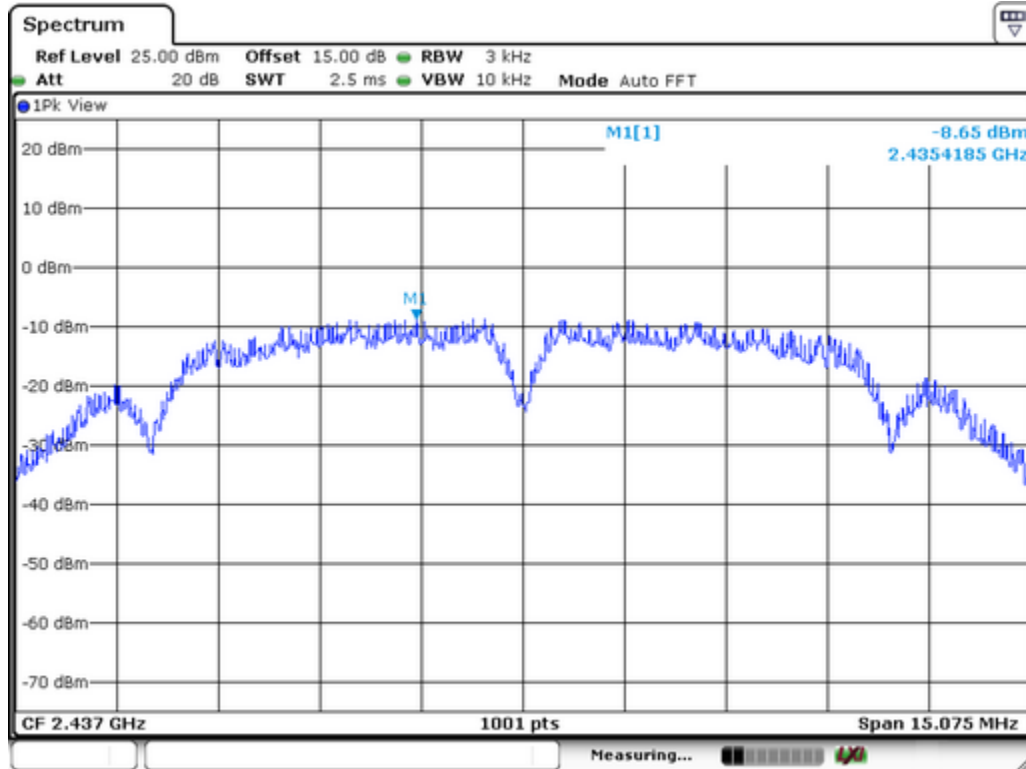

IEEE 802.11g(SISO) Ant 1			
Channel frequency (MHz)	Power Density (dBm/3kHz)	Power Density Limit (dBm/3kHz)	Result
2412	-8.11	8	Pass
2437	-9.00		
2462	-8.89		

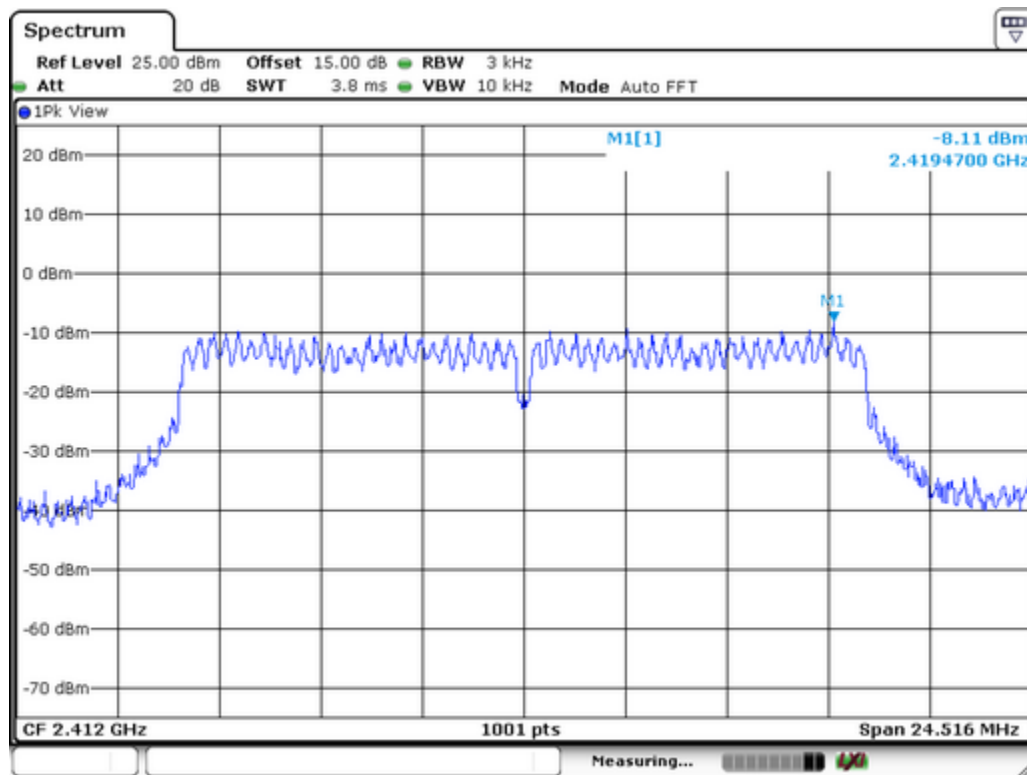

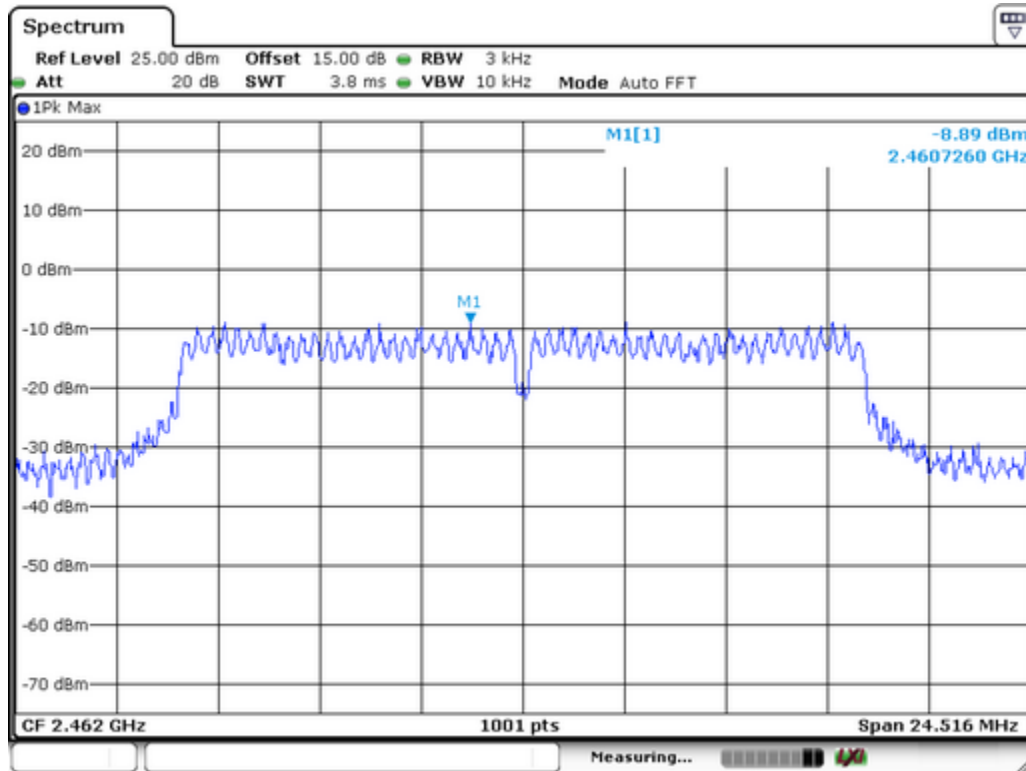
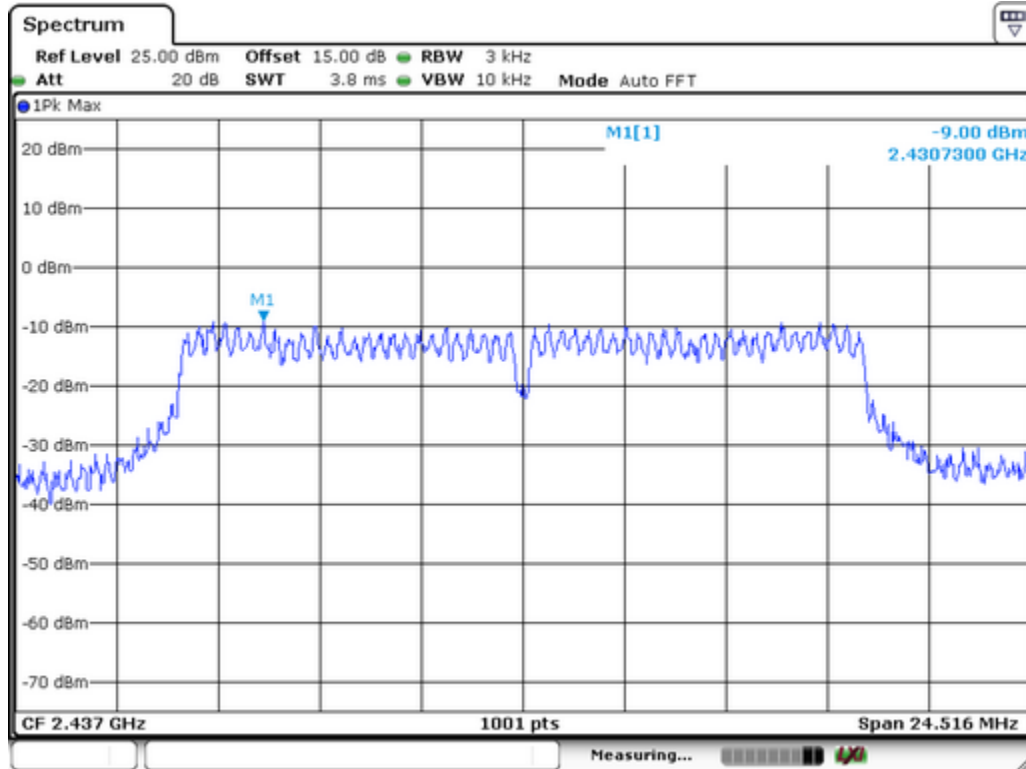

IEEE 802.11g(SISO) Ant2			
Channel frequency (MHz)	Power Density (dBm/3kHz)	Power Density Limit (dBm/3kHz)	Result
2412	-9.10	8	Pass
2437	-8.37		
2462	-8.14		

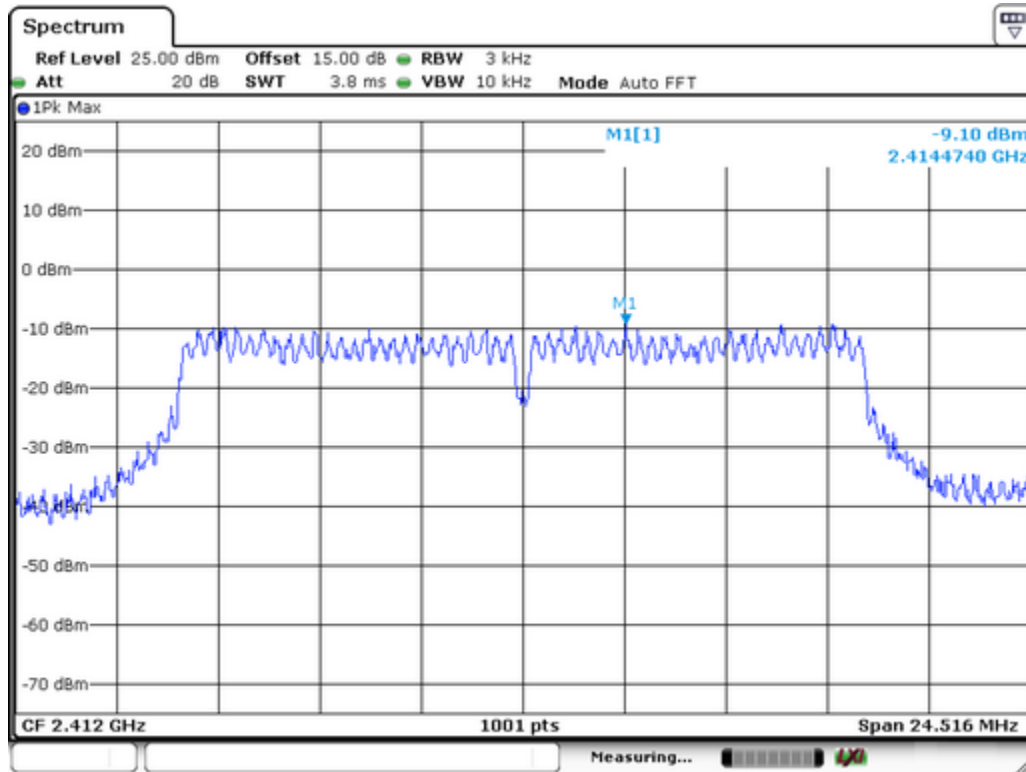

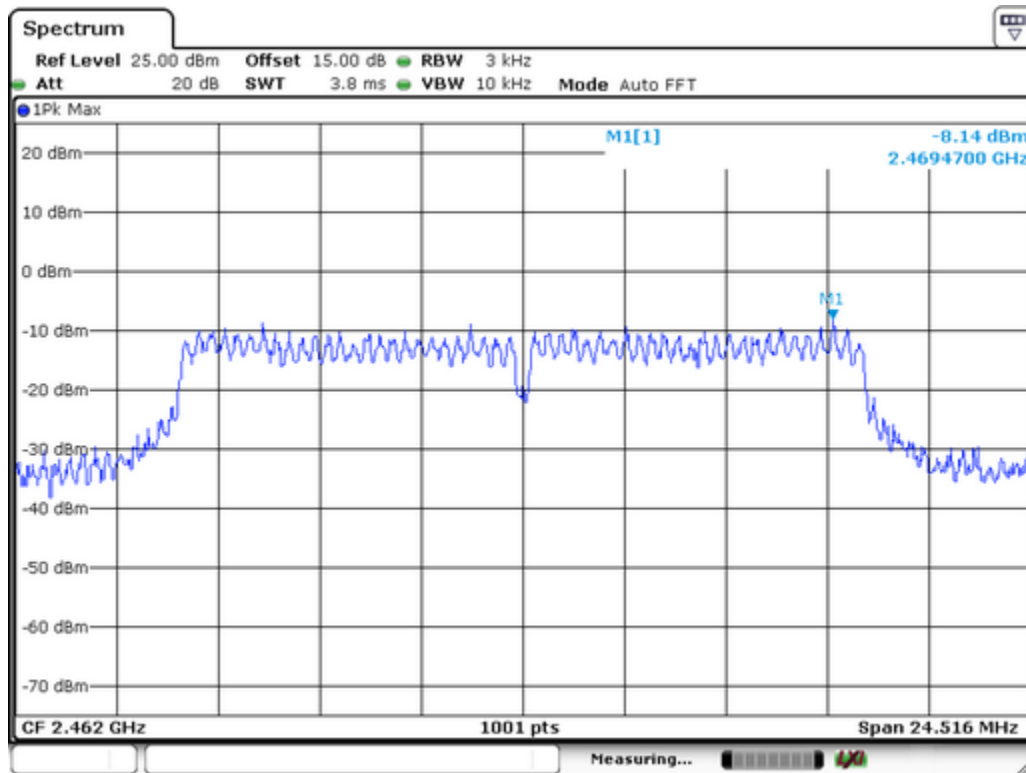
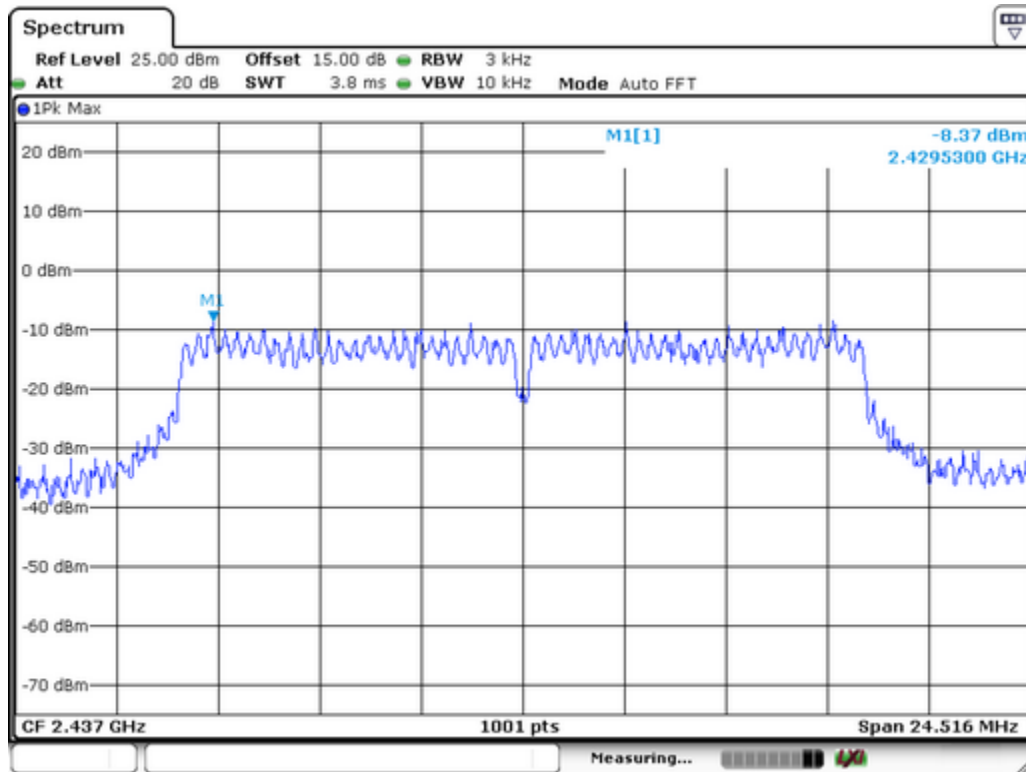

IEEE 802.11n(HT20) MIMO(Antenna Gain=4.22dBi)					
Channel frequency (MHz)	Power Density (dBm/3kHz)			Power Density Limit (dBm/3kHz)	Result
	Ant1	Ant2	Total		
2412	-9.92	-9.82	-6.86	8	Pass
2437	-9.03	-8.66	-5.83		
2462	-9.51	-9.70	-6.59		

Remark: In MIMO, Ant1+Ant2 Directional Gain= $G_{ant}+10\log(N)$ dBi=1.21+10Log(2)=4.22dBi.
Directional Gain was according to KDB662911.

Ant1

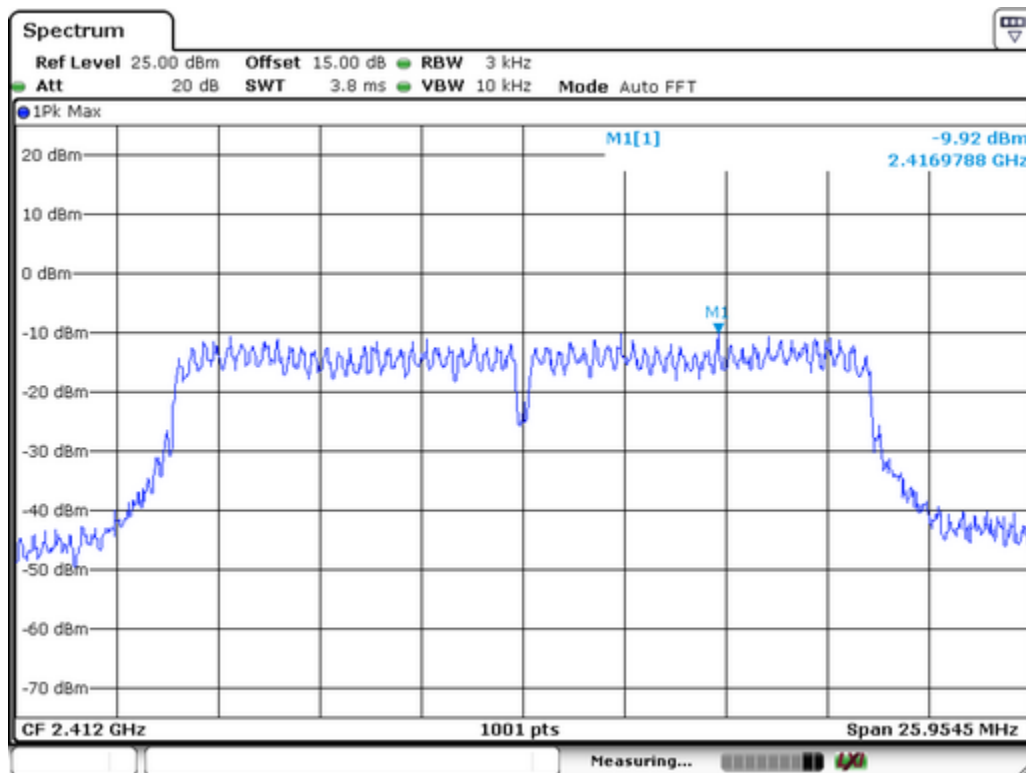

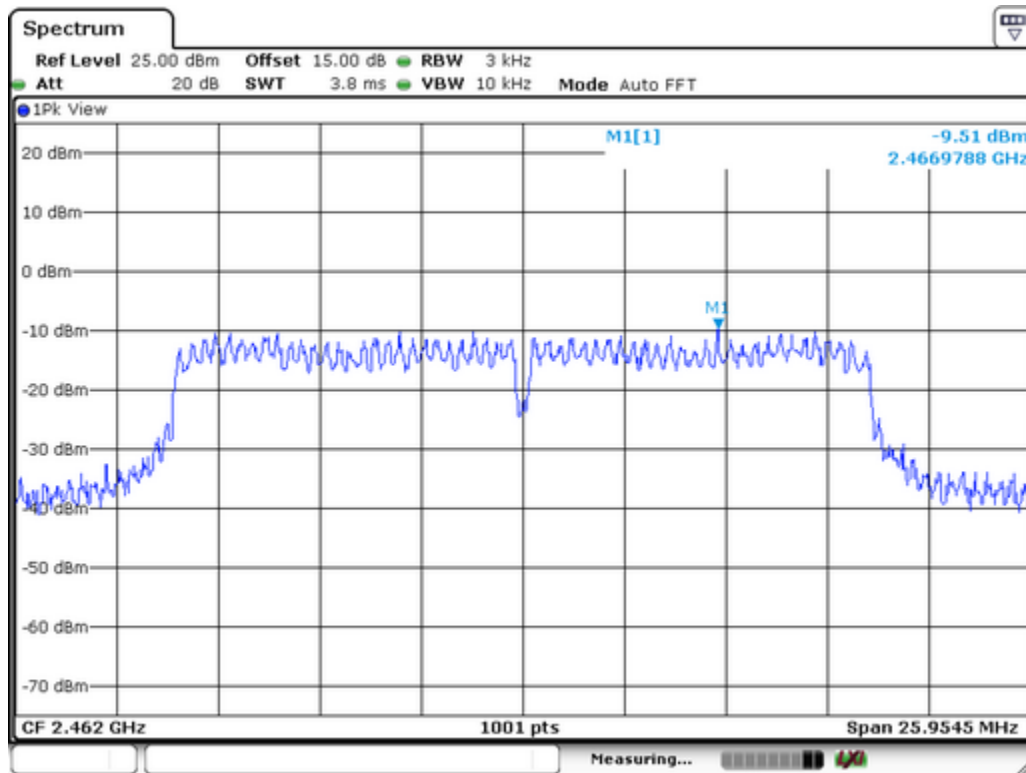
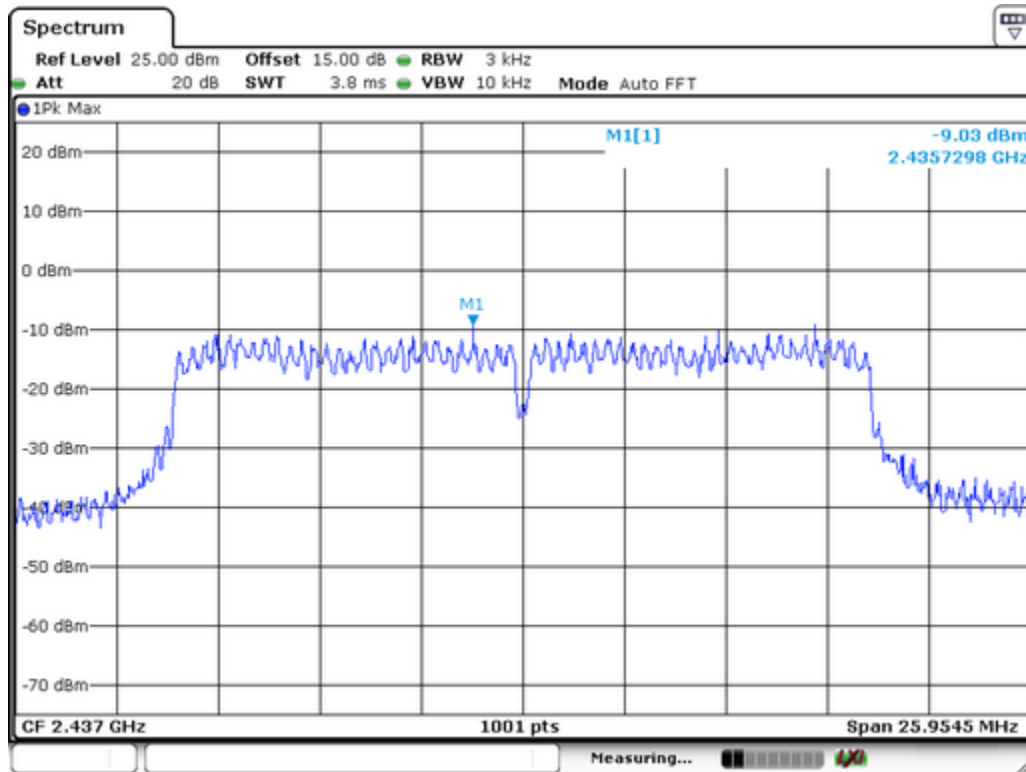

Ant2

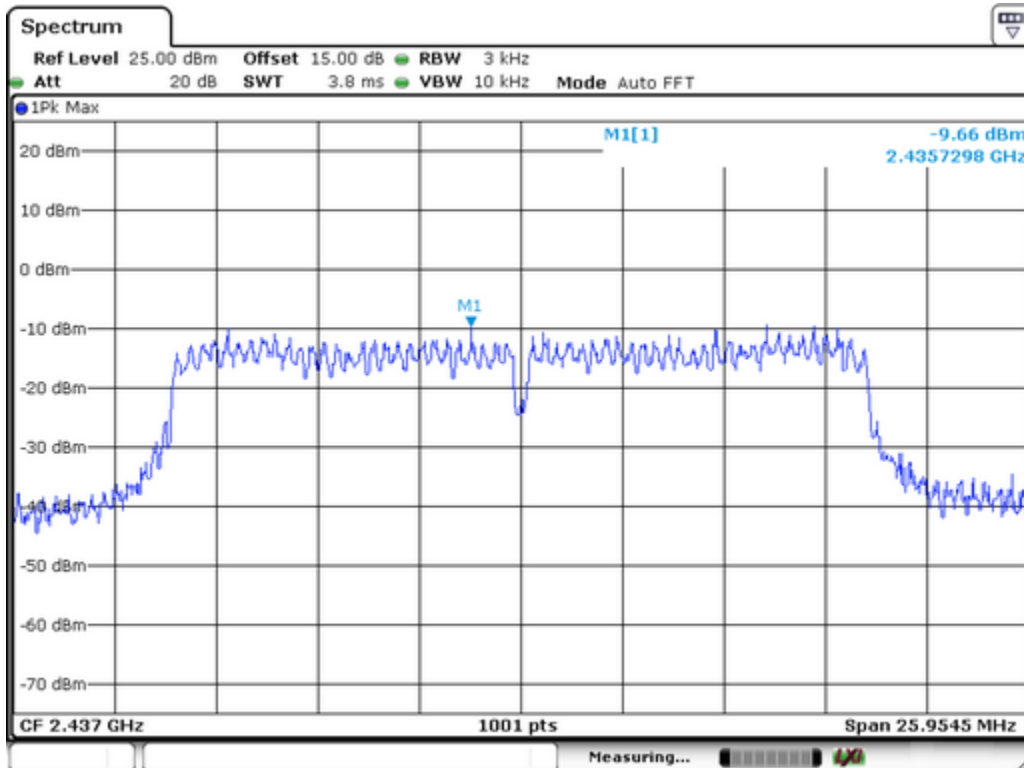
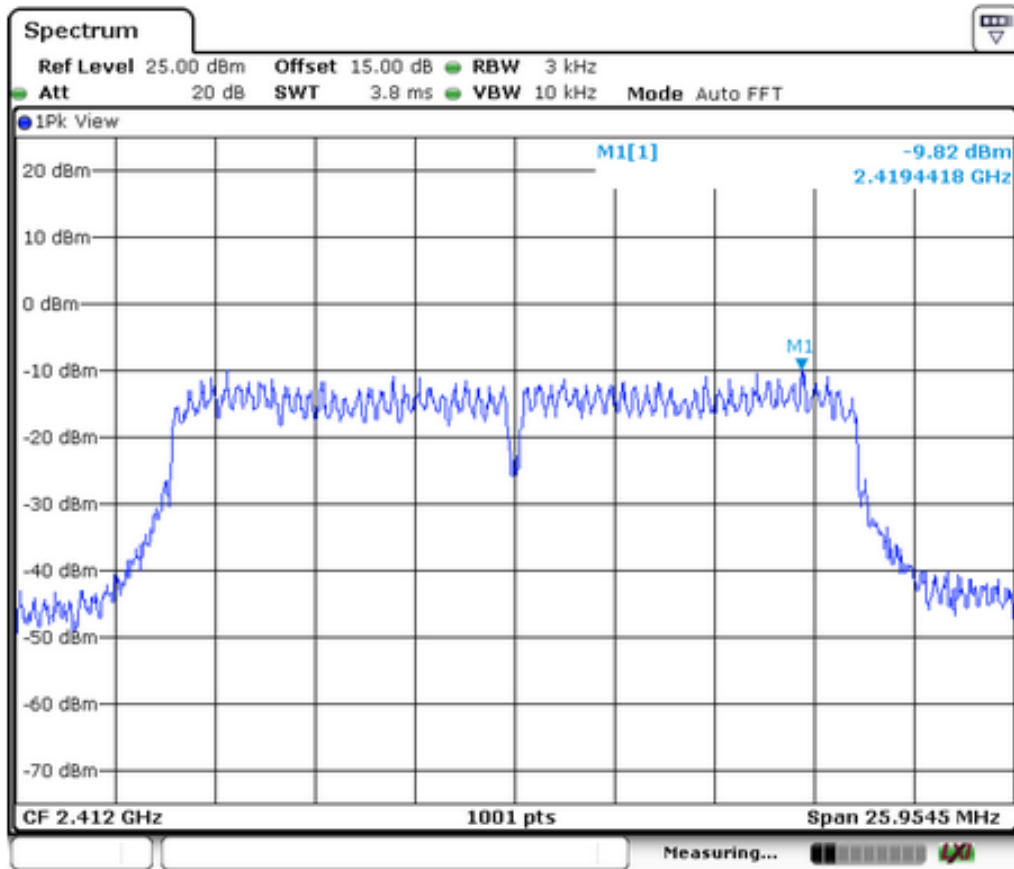

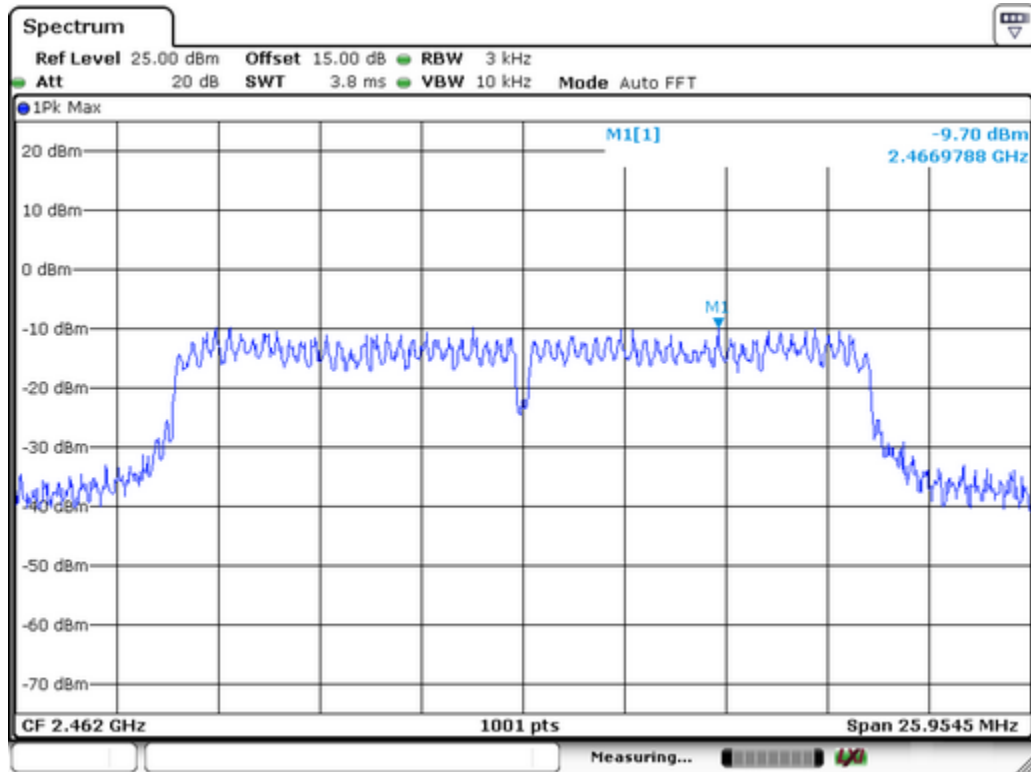

IEEE 802.11n(HT40) MIMO(Antenna Gain=4.22dBi)					
Channel frequency (MHz)	Power Density (dBm/3kHz)			Power Density Limit (dBm/3kHz)	Result
	Ant 1	Ant 2	Total		
2422	-13.41	-13.02	-10.20	8	Pass
2437	-13.37	-13.78	-10.56		
2452	-13.02	-12.86	-9.93		

Remark: In MIMO, Ant1+Ant2 Directional Gain= $G_{ant}+10\log(N)$ dBi=1.21+10Log(2)=4.22dBi.
Directional Gain was according to KDB662911.

Ant1

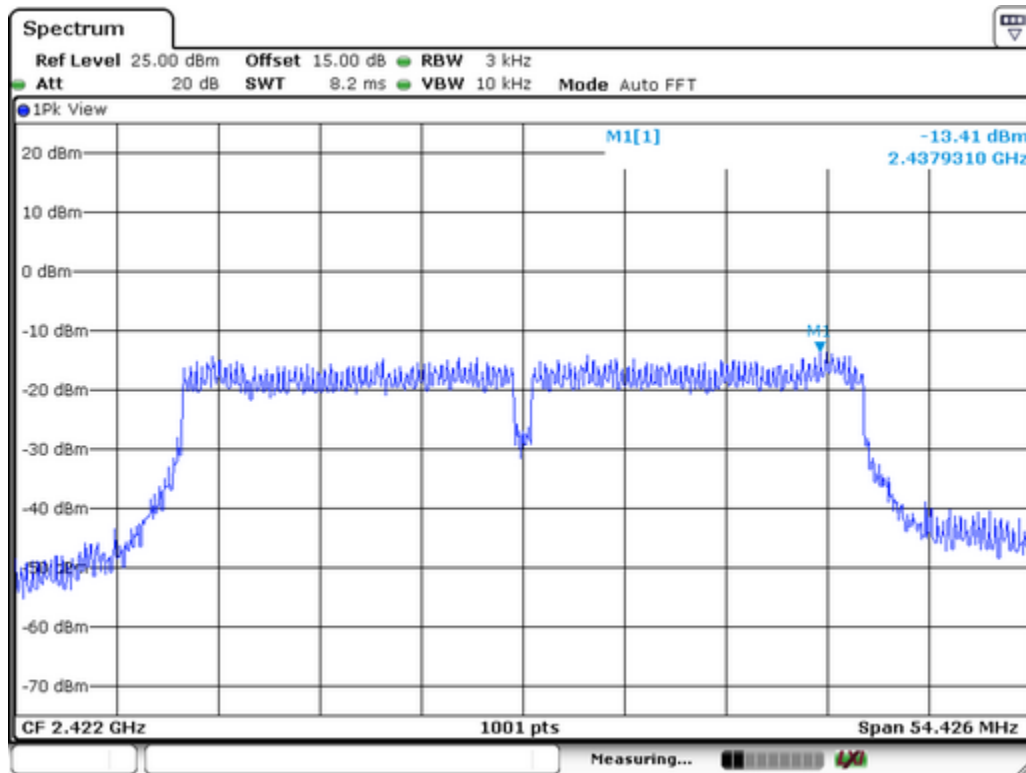

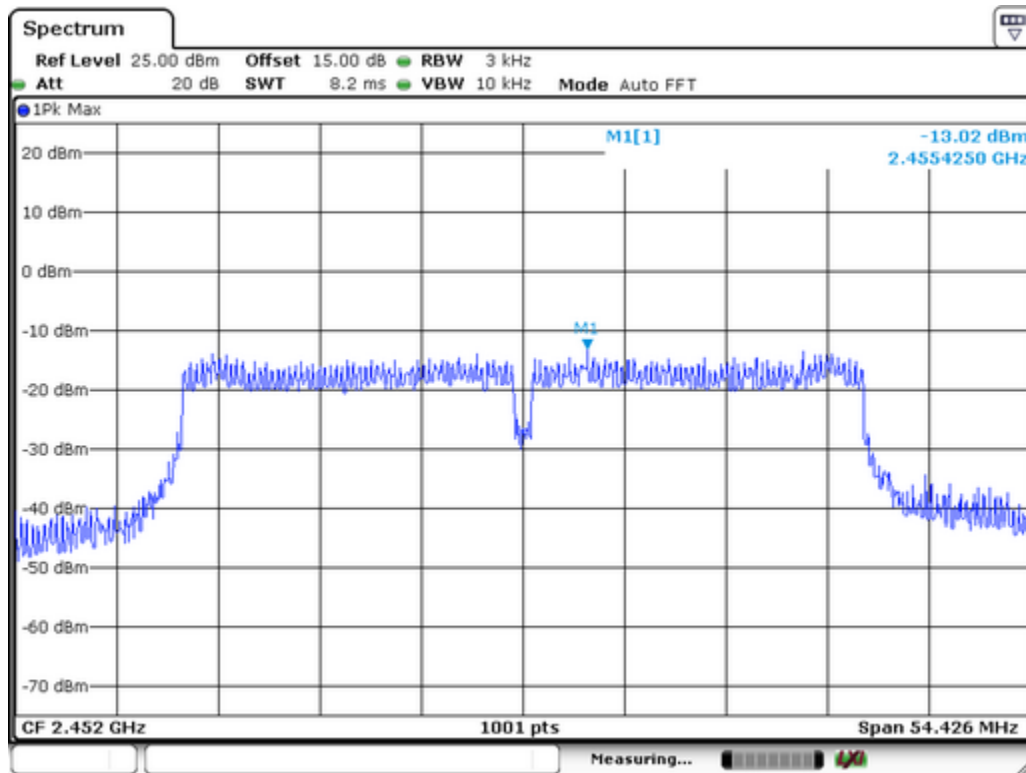
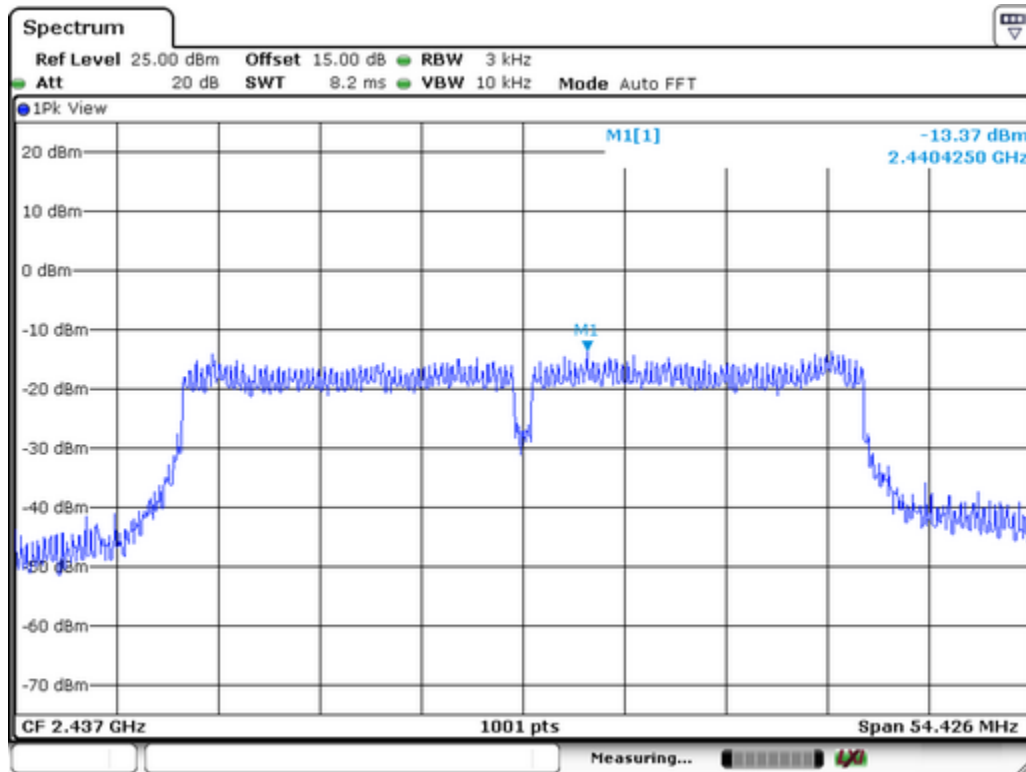

Ant2

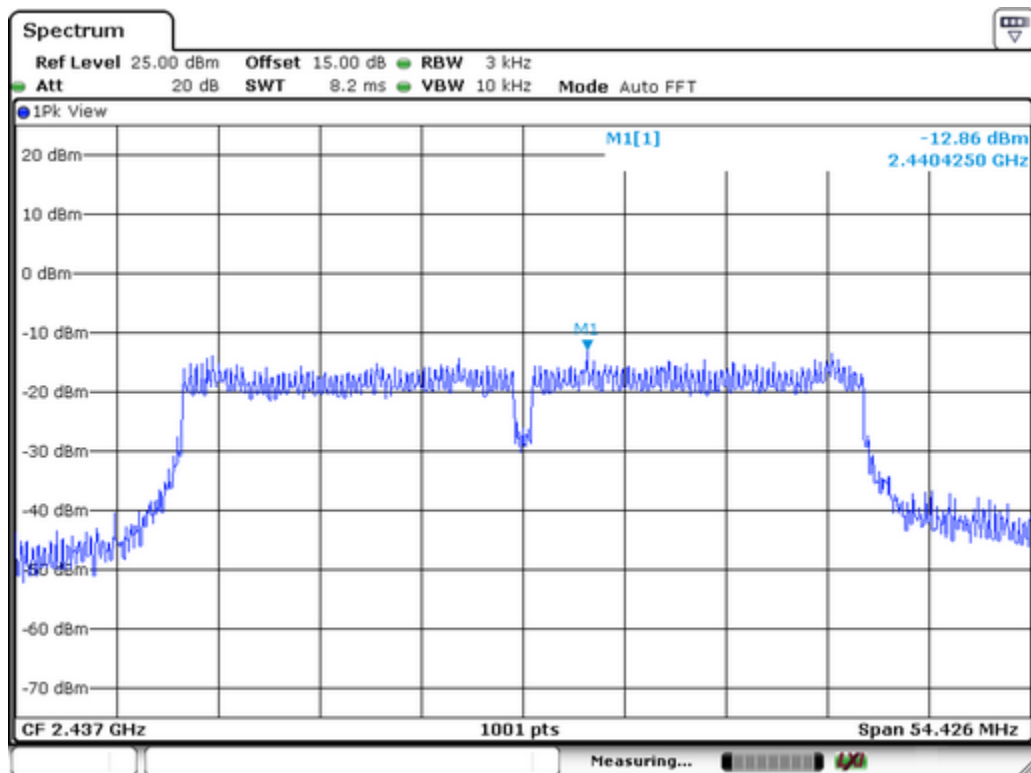
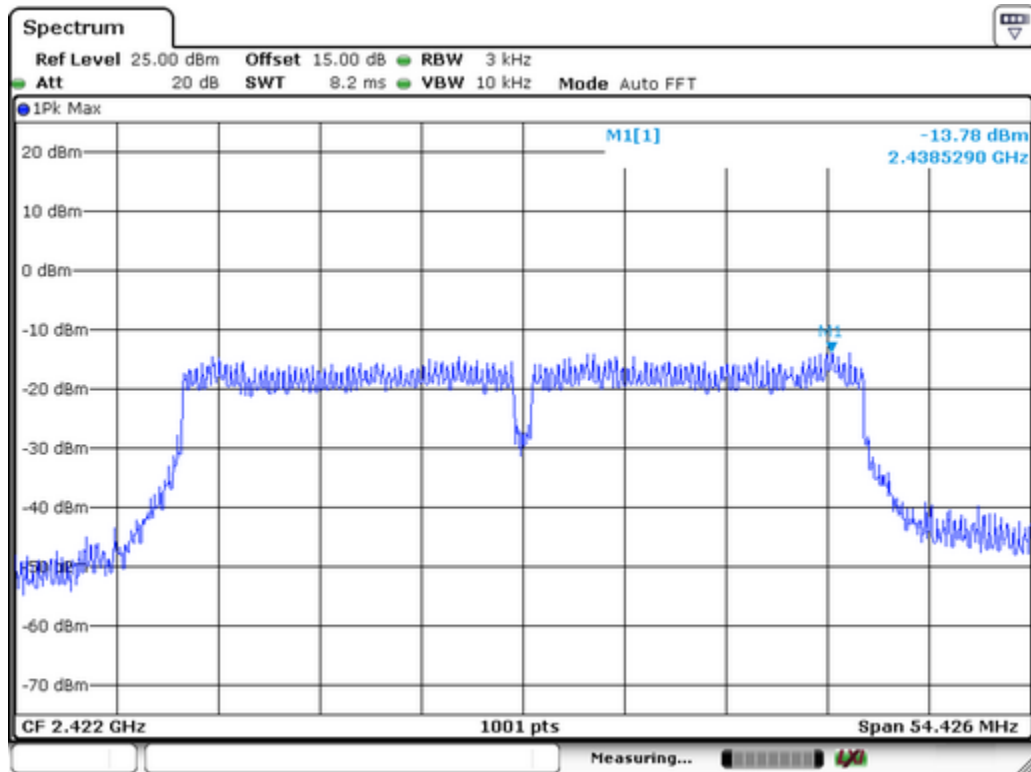

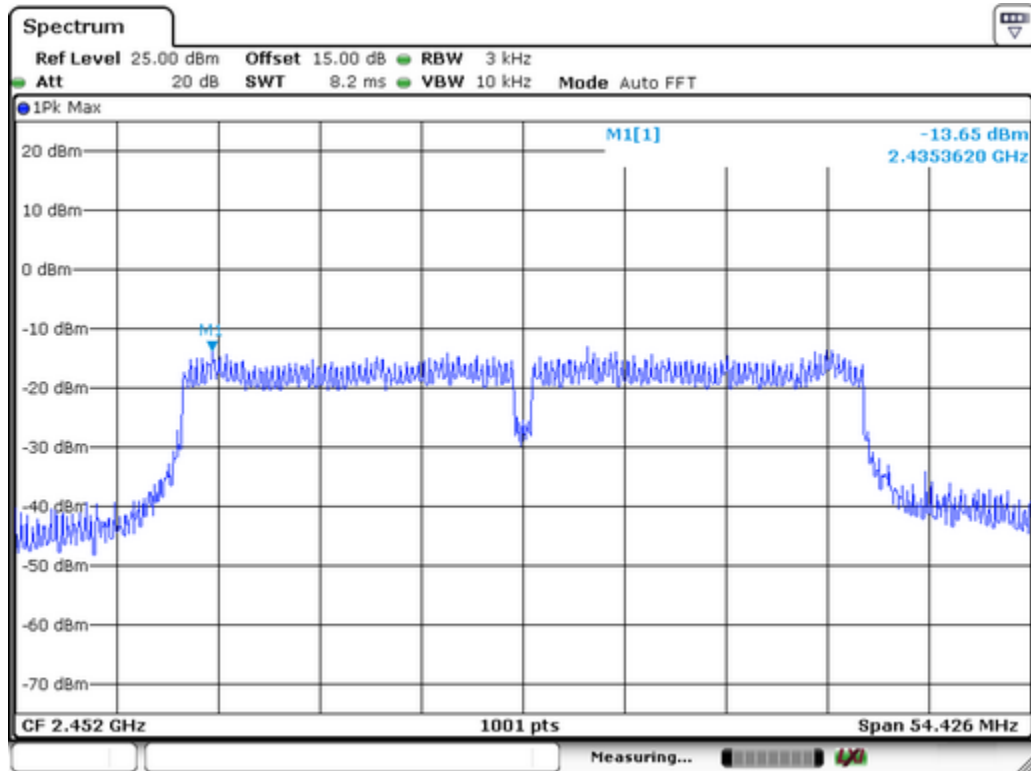

14. Antenna Port Emission

14.1 Test Equipment

EQUIPMENT TYPE	MFR	MODEL NUMBER	SERIAL NUMBER	LAST CAL.	CAL DUE.
Spectrum Analyzer	Agilent	FSV30	1321.3008K	05/16/2018	05/15/2019

14.2 Measuring Instruments and Setting

The following table is the setting of spectrum analyzer.

Spectrum analyzer	Setting
Attenuation	Auto
RBW	100kHz
VBW	300kHz
Detector	Peak
Trace	Max hold

14.3 Test Procedures

The conducted spurious emissions were measured conducted using a spectrum analyzer at low, Middle, and high channels, the limit was determined by attenuation 20dB of the RF peak power output.

14.4 Block Diagram of Test setup

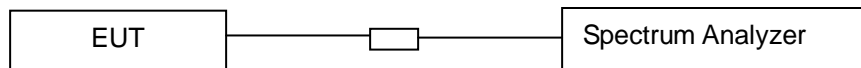

14.5 Test Result

PASS.

Please refer to the following pages.

Test Mode: IEEE 802.11b SISO Ant1

Lowest Channel

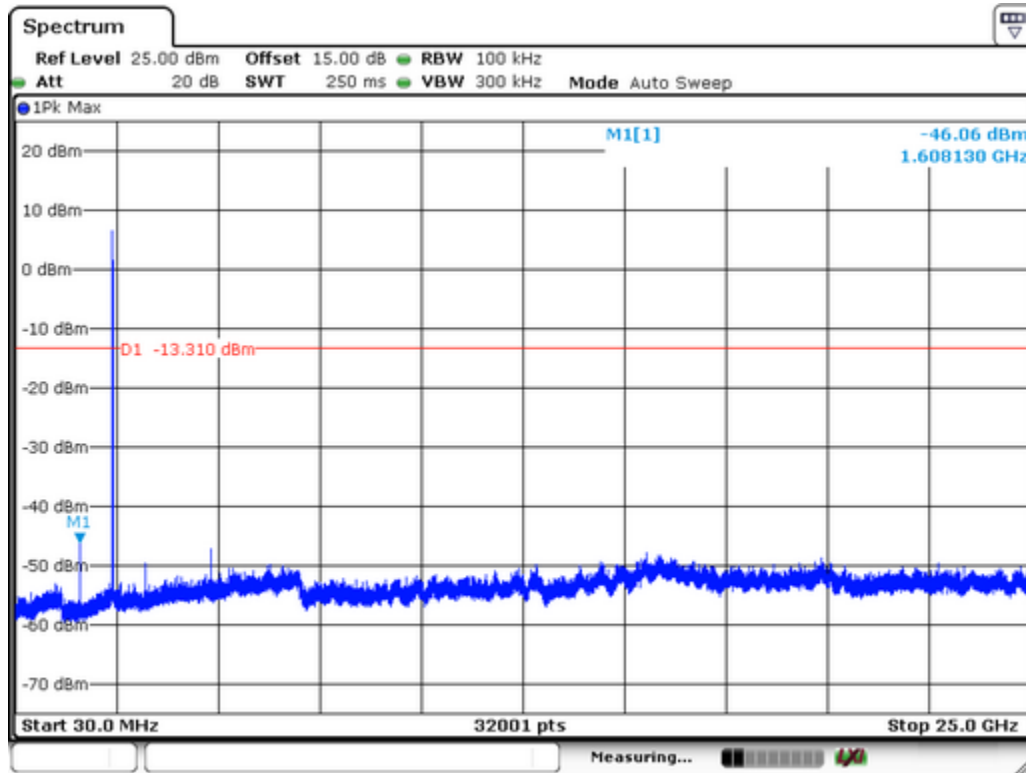

Middel Channel

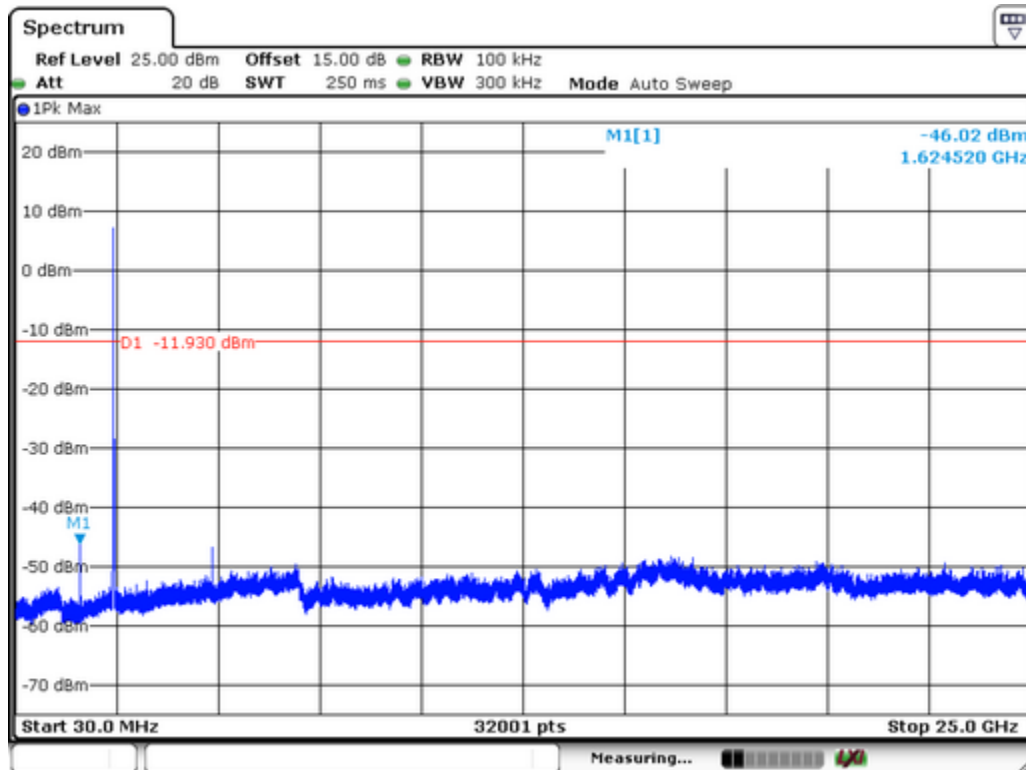

Highest Channel

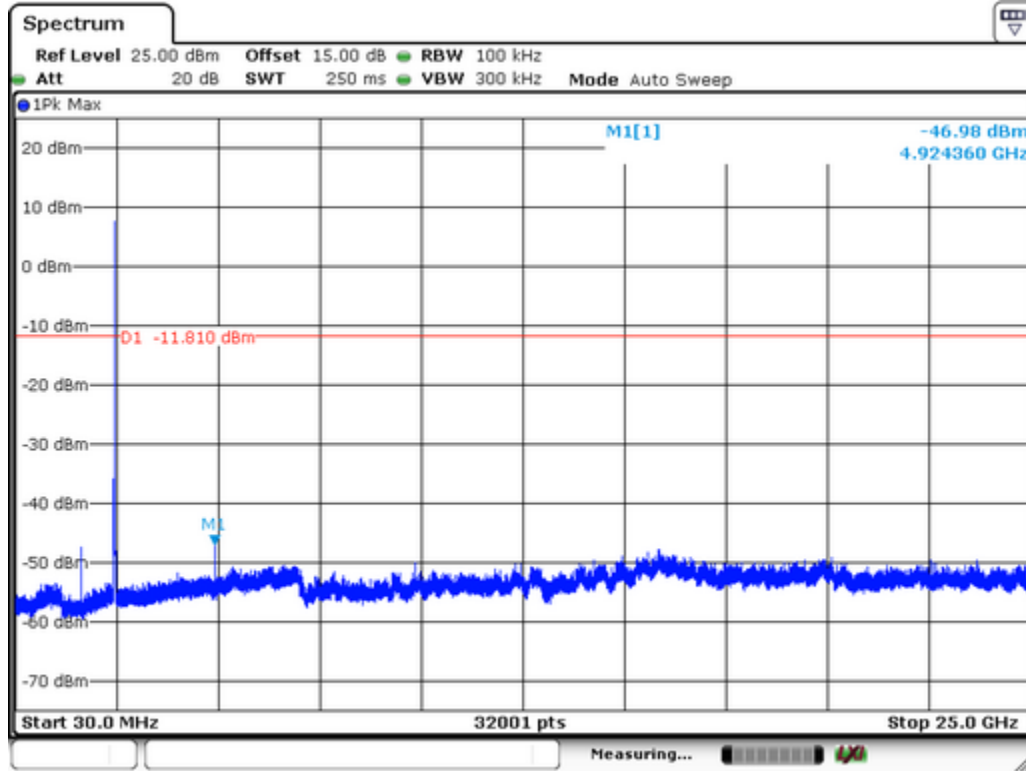

Test Mode: IEEE 802.11b SISO Ant2

Lowest Channel

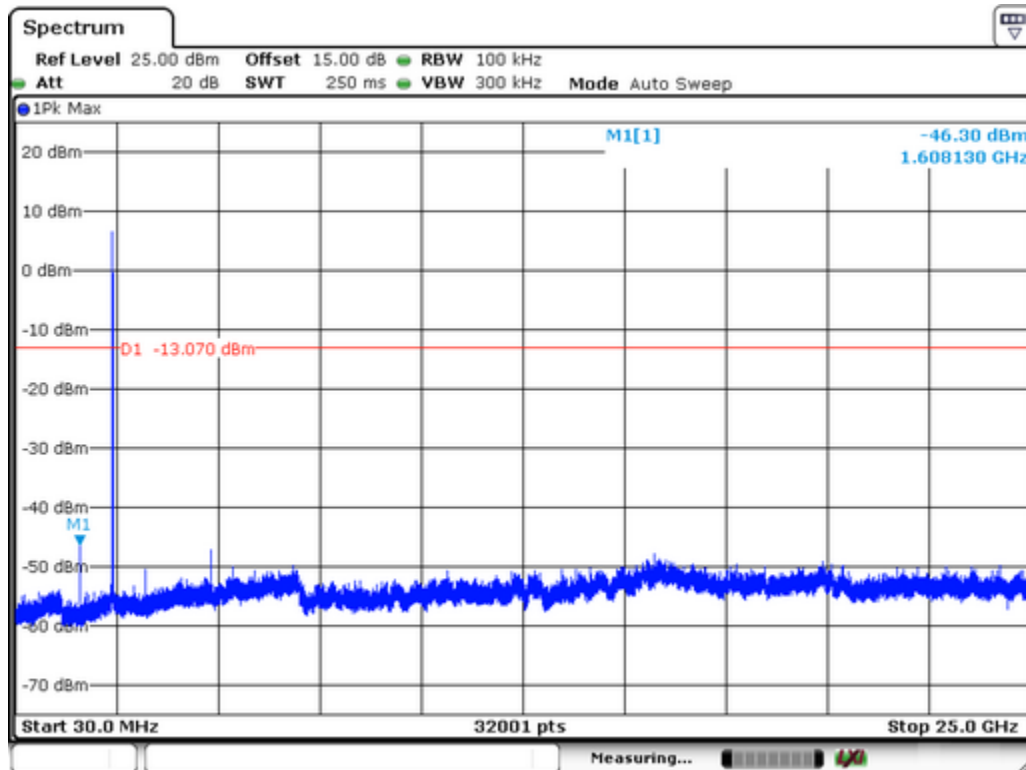

Middel Channel

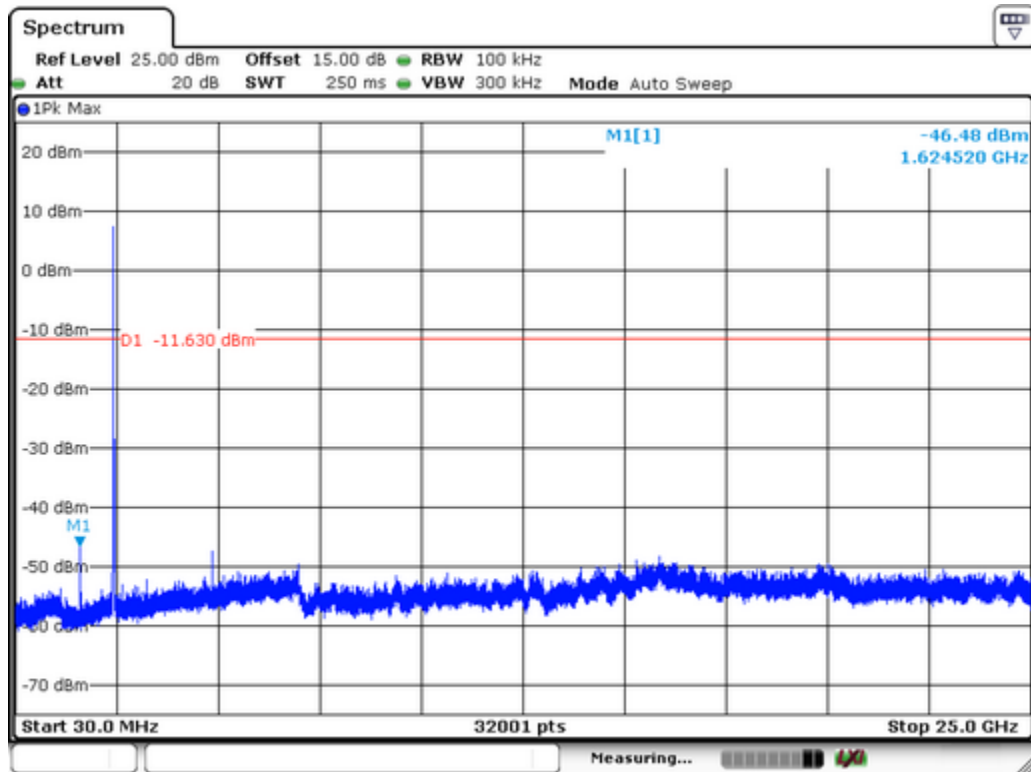

Highest Channel

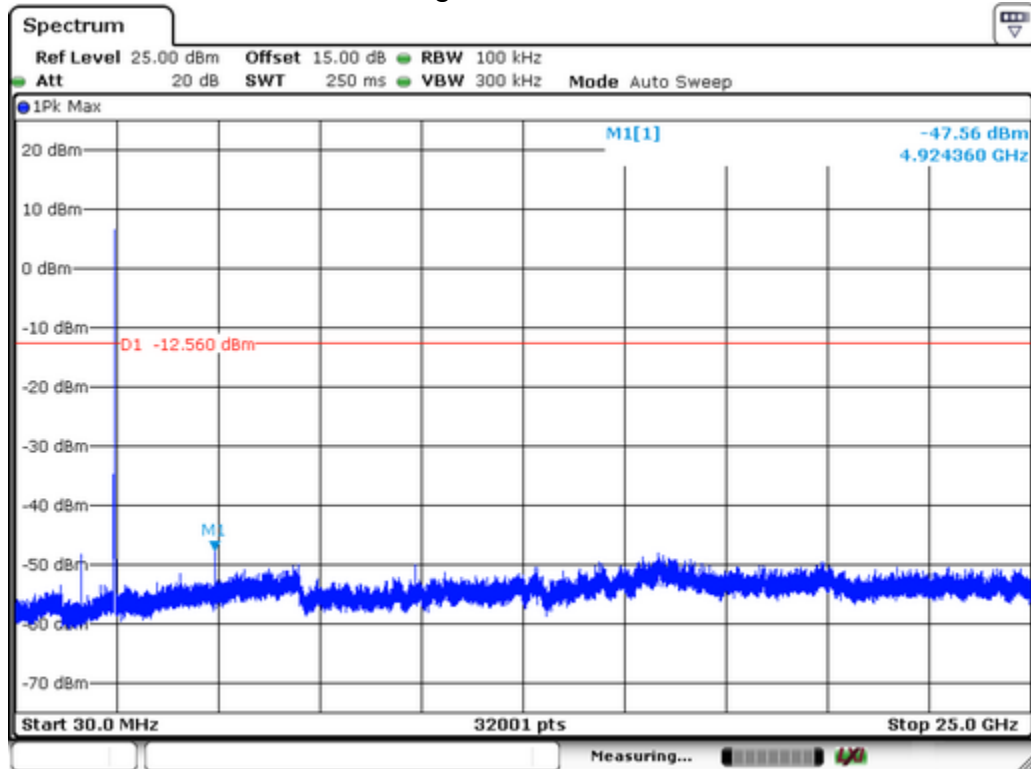

Test Mode: IEEE 802.11g SISO Ant1

Lowest Channel

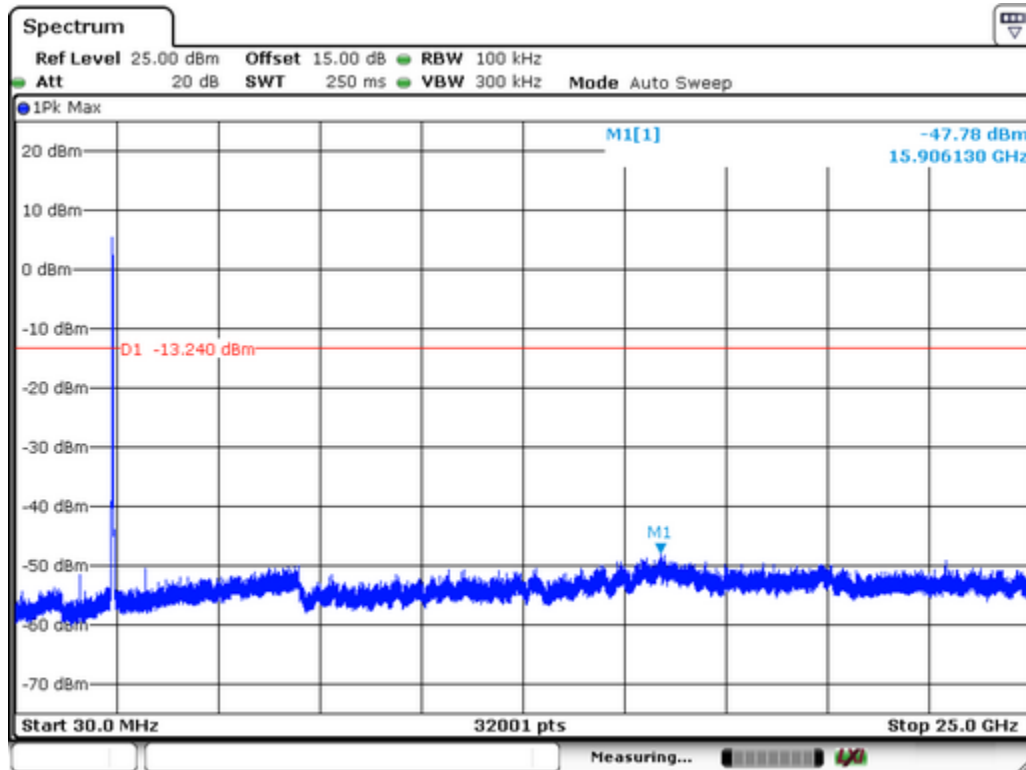

Middle Channel

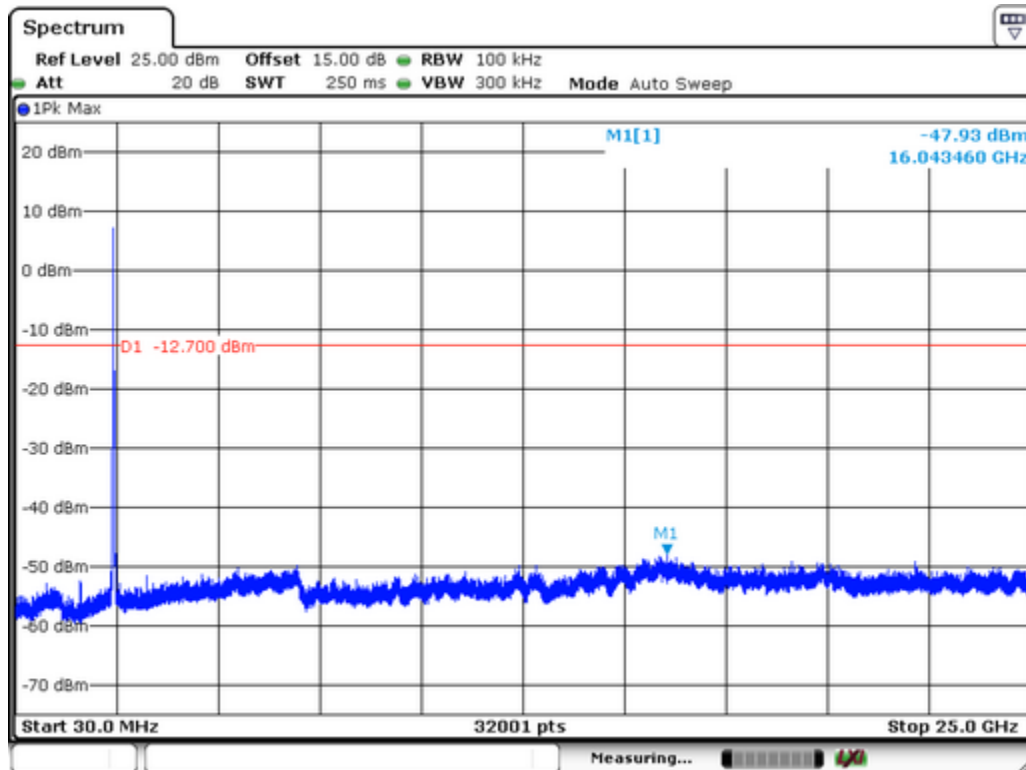

Highest Channel

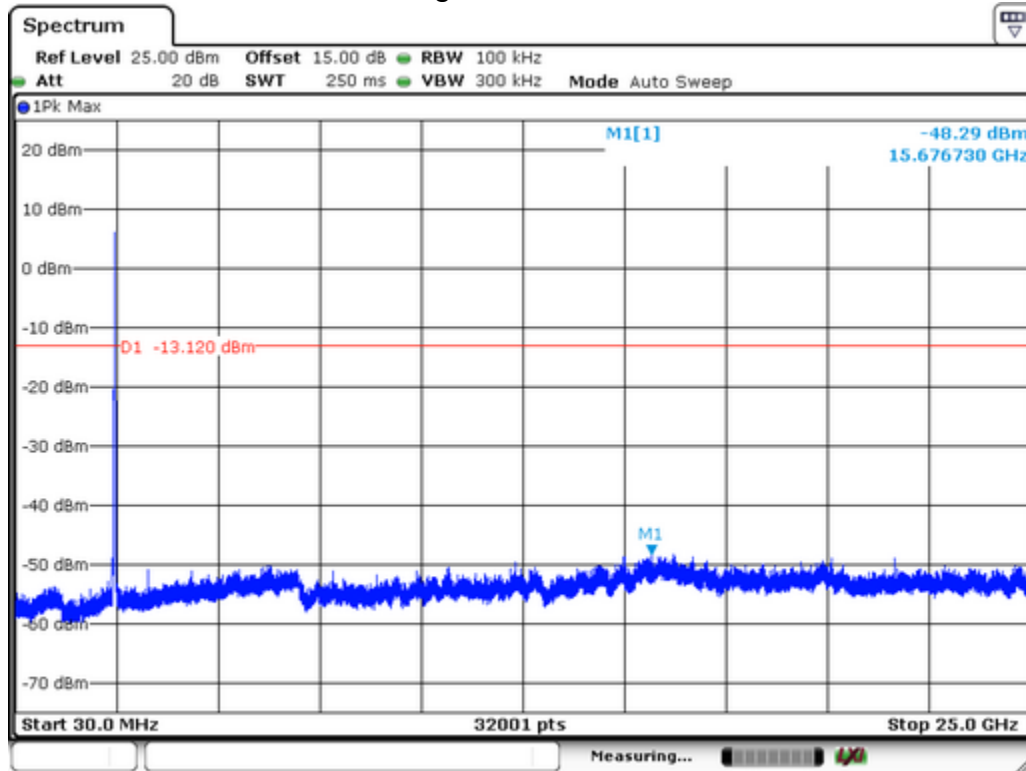

Test Mode: IEEE 802.11g SISO Ant2

Lowest Channel

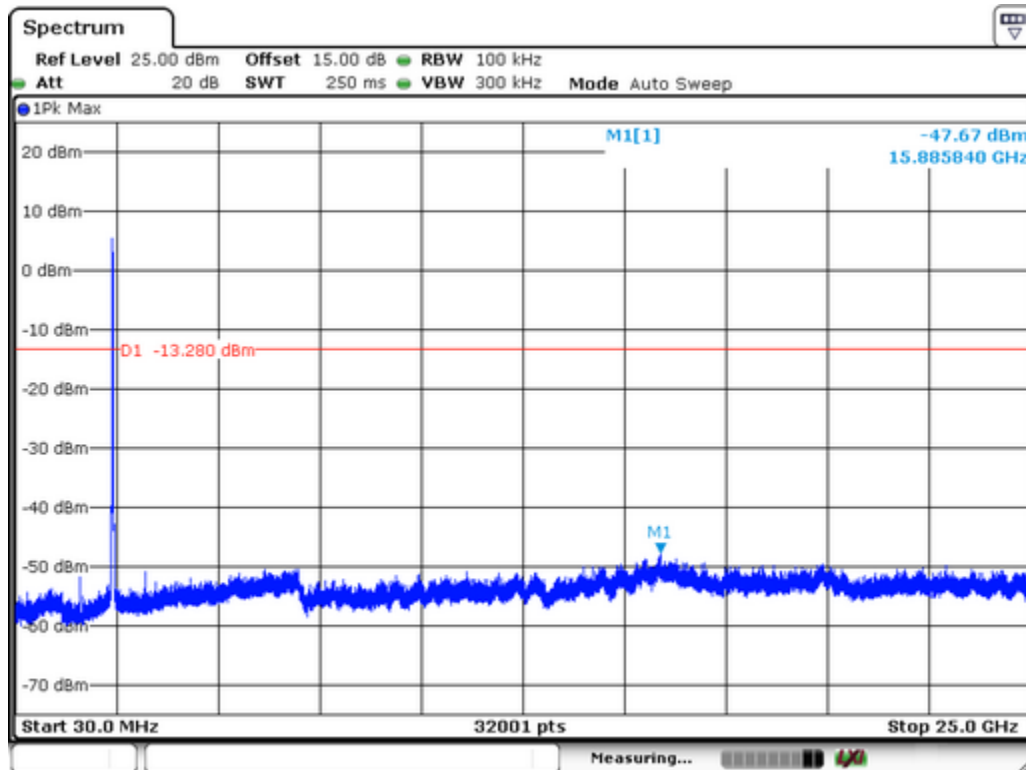

Middle Channel

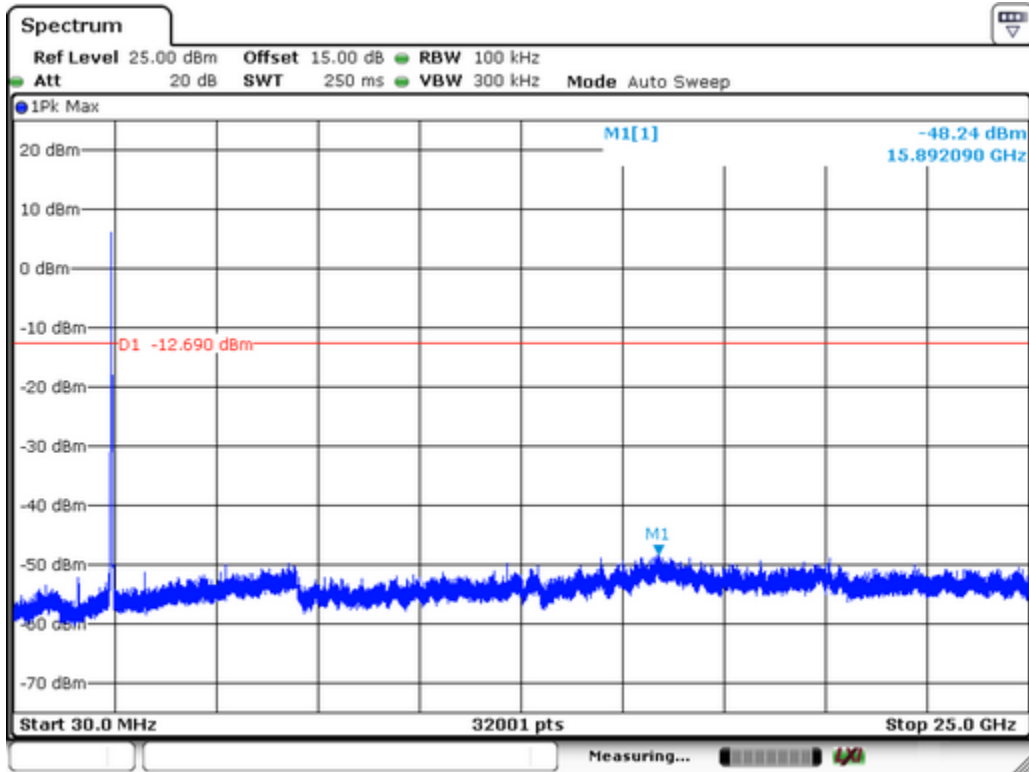

Highest Channel

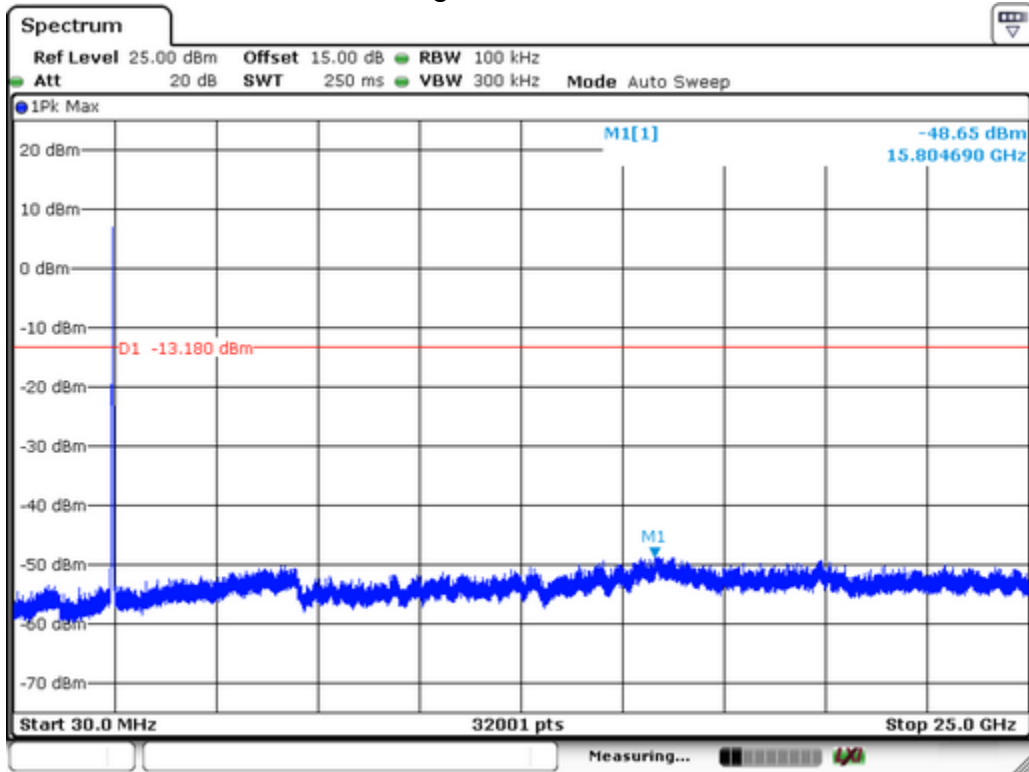

Test Mode: IEEE 802.11n(HT20) MIMO

Lowest Channel

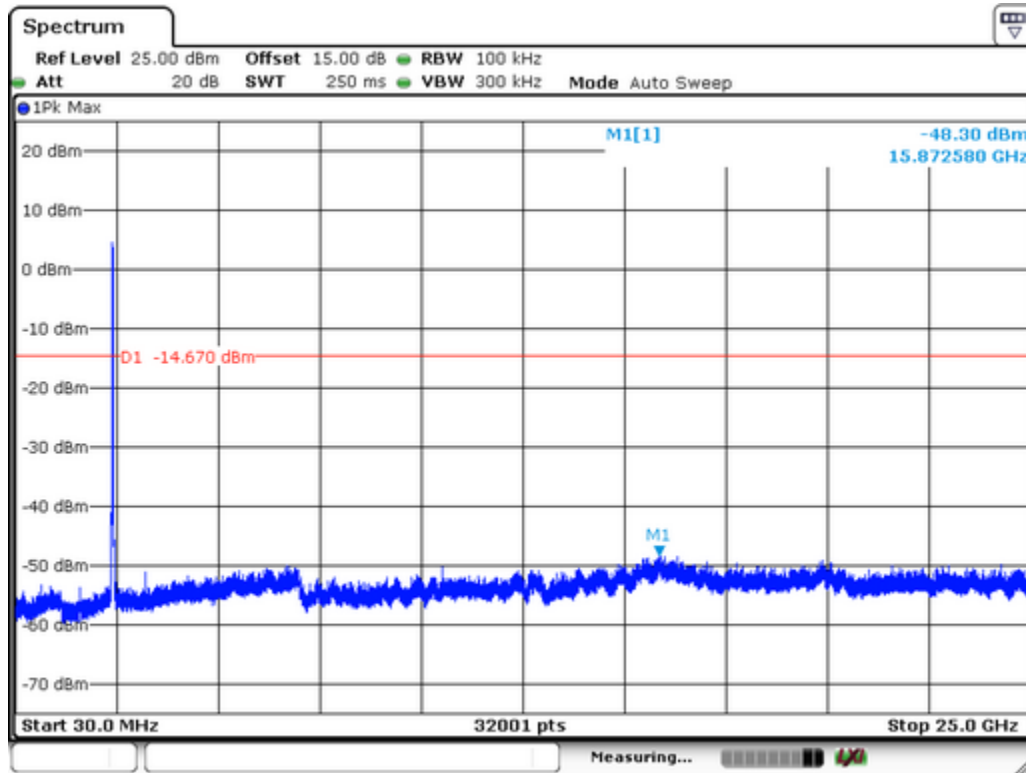

Middle Channel

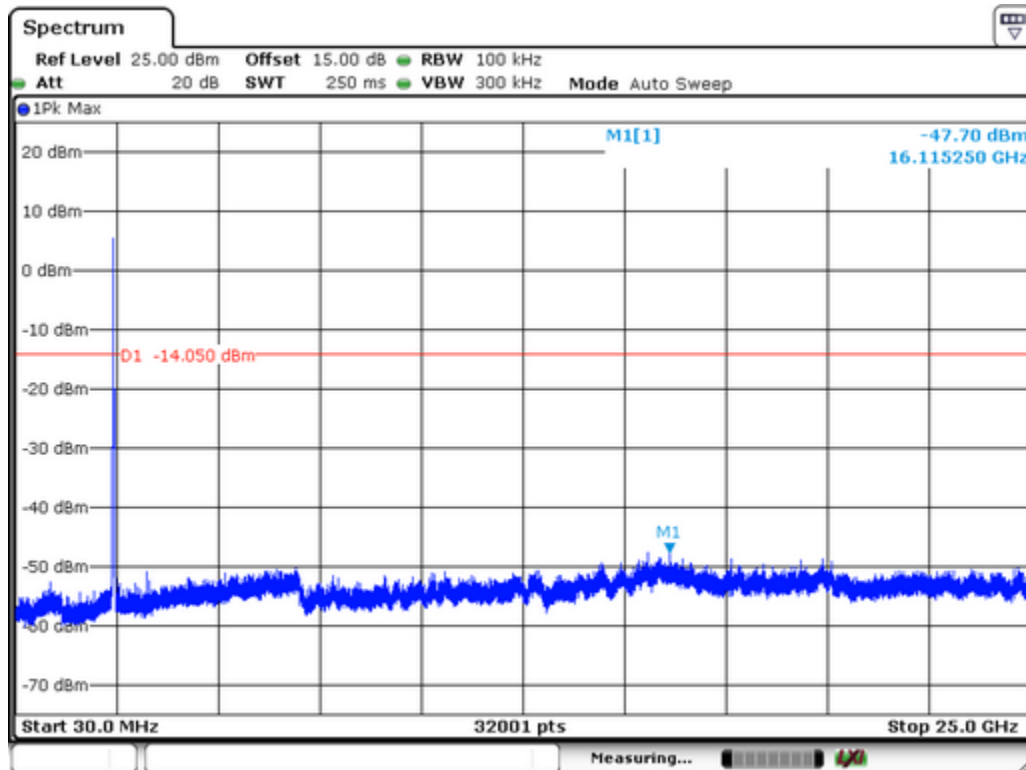

Highest Channel

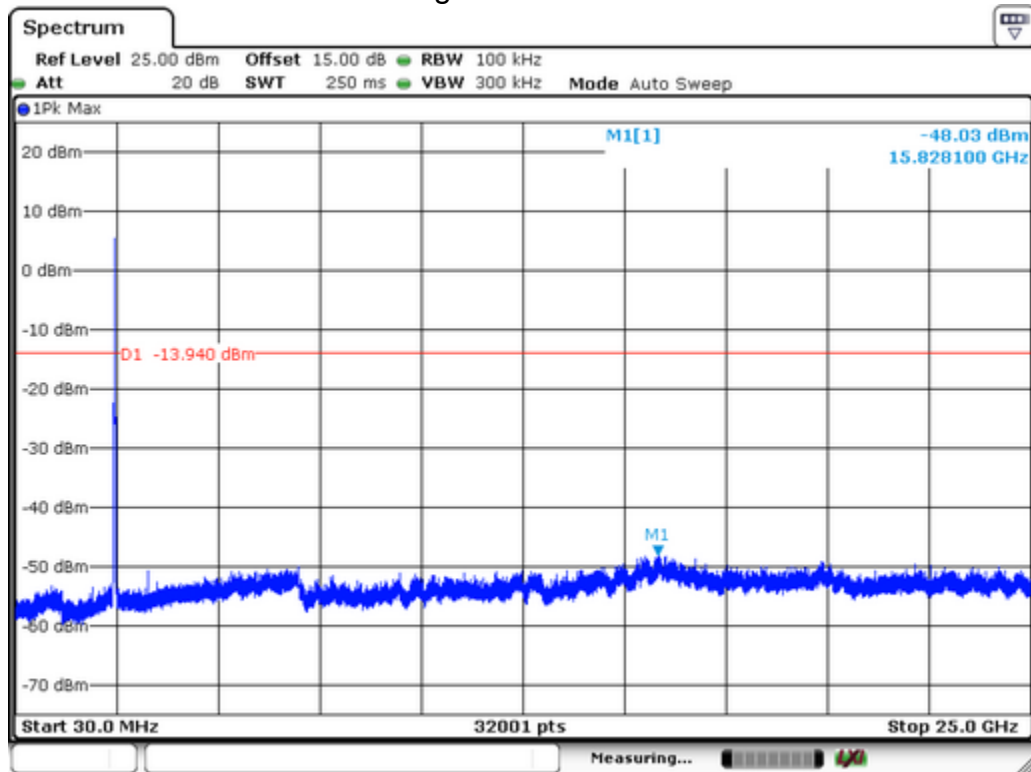

Test Mode: IEEE802.11n(HT40) MIMO

Lowest Channel

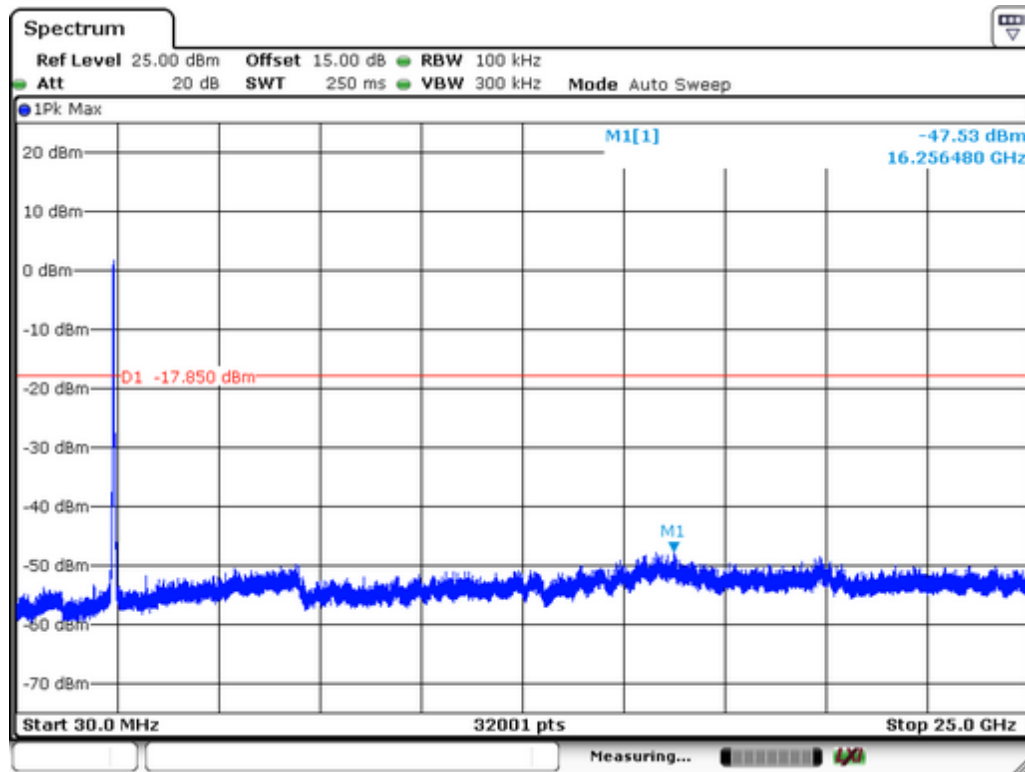

Middle Channel

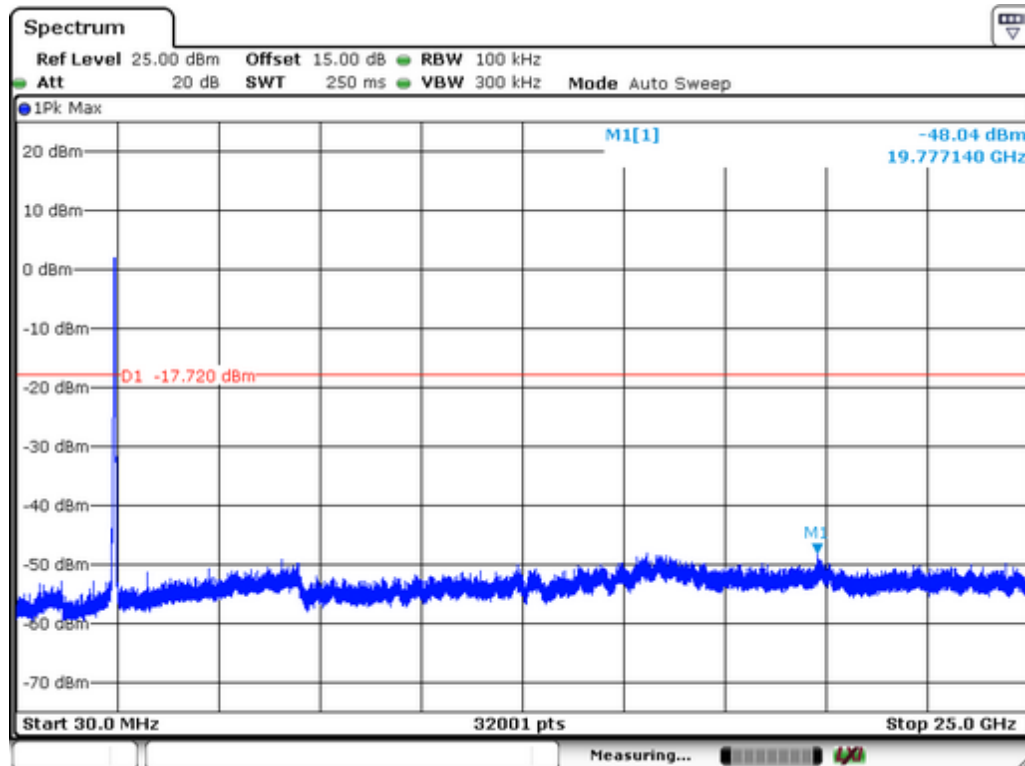

Highest Channel

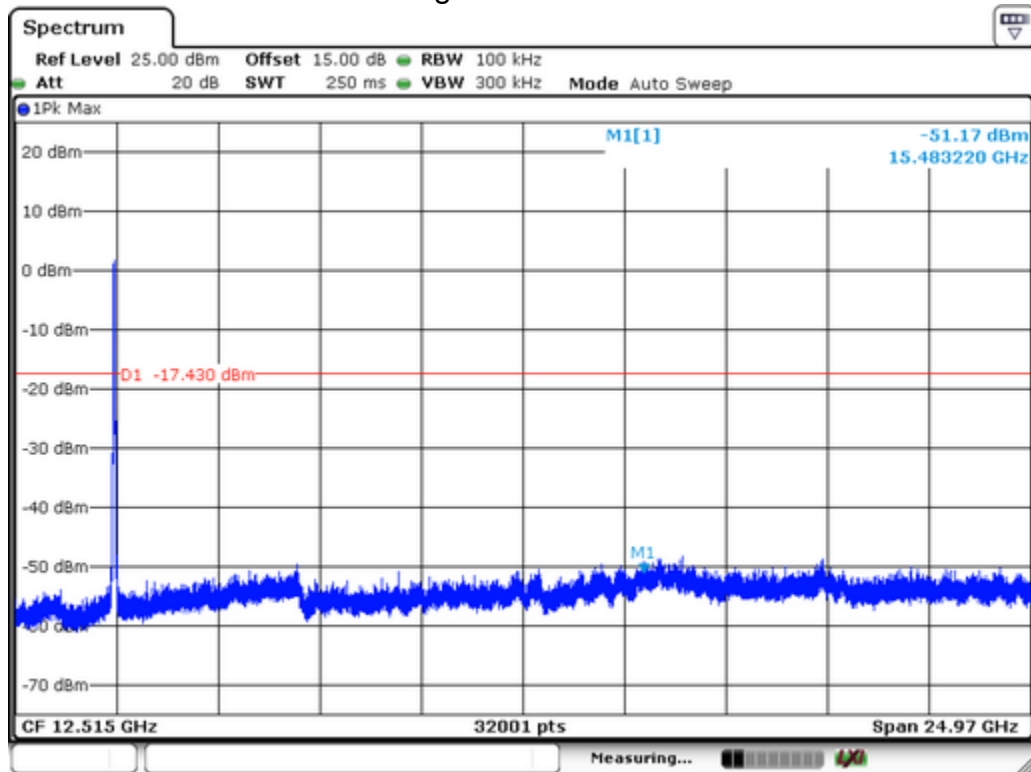

15. Antenna Application

15.1 Antenna Requirement

For intentional device, according to FCC 47 CFR Section 15.203, an intentional radiator shall be designed to ensure that no antenna other than that furnished by the responsible party shall be used with the device. And according to FCC 47 CFR Section 15.247 (b), if transmitting antennas of directional gain greater than 6dBi are used, the power shall be reduced by the amount in dB that the directional gain of the antenna exceeds 6dBi.

15.2 Result

The EUT'S antenna, permanent attached antenna, is internal antenna. The antenna's gain is 1.21dBi and meets the requirement.

APPENDIX I (PHOTOS OF EUT)





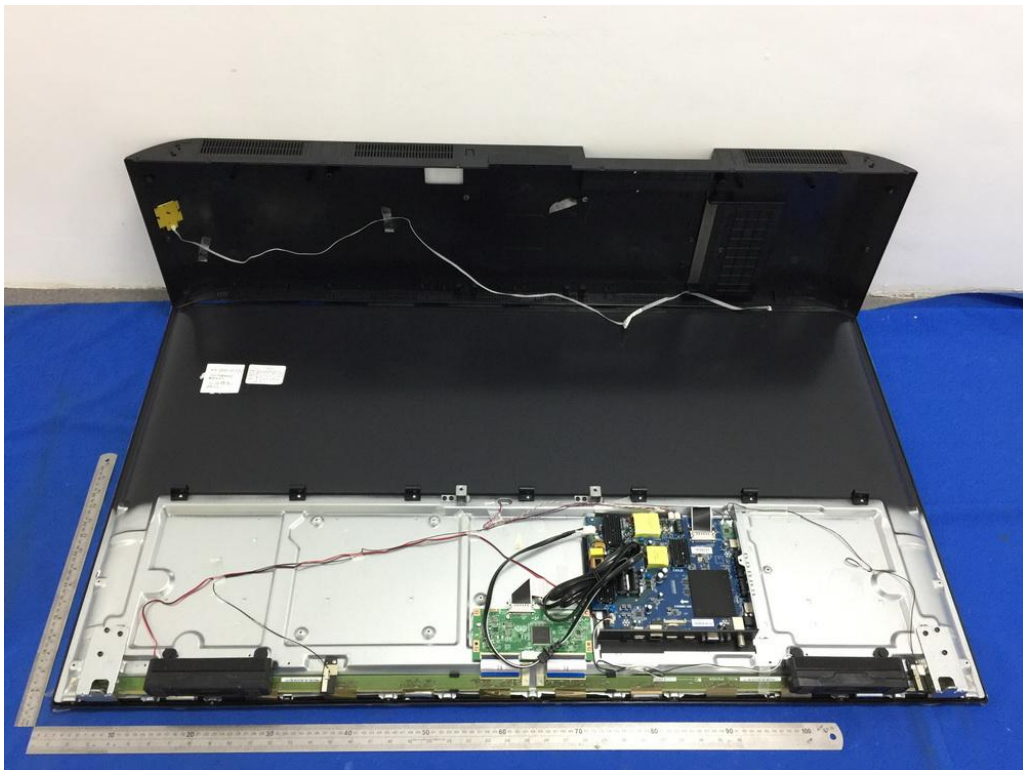

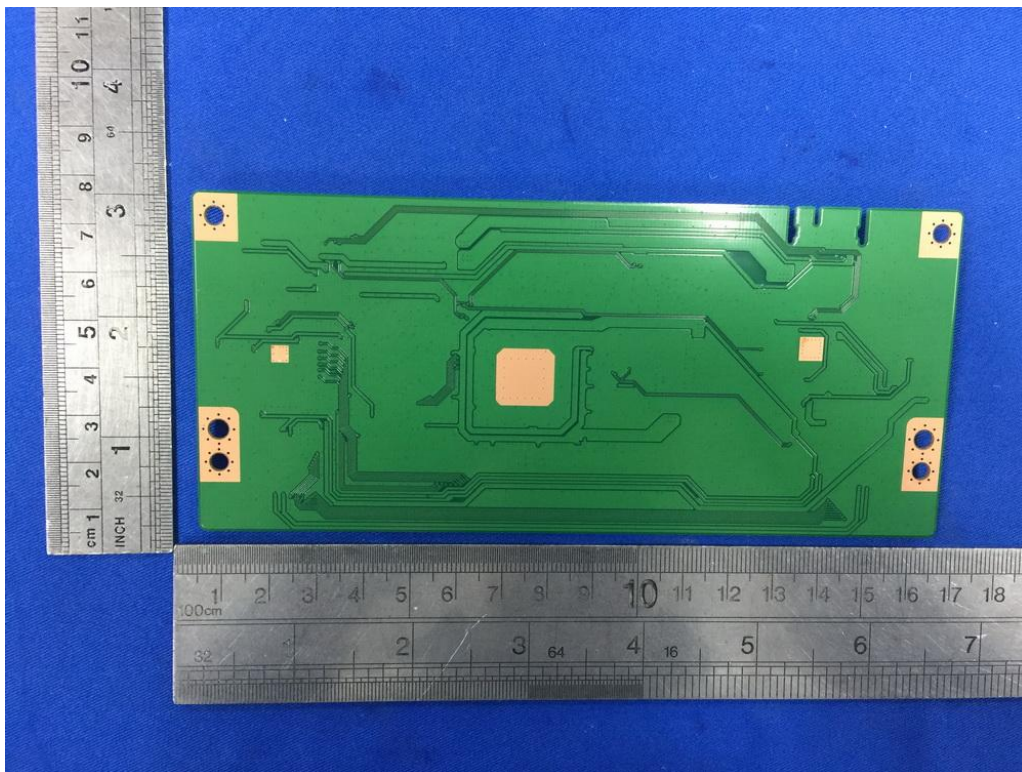
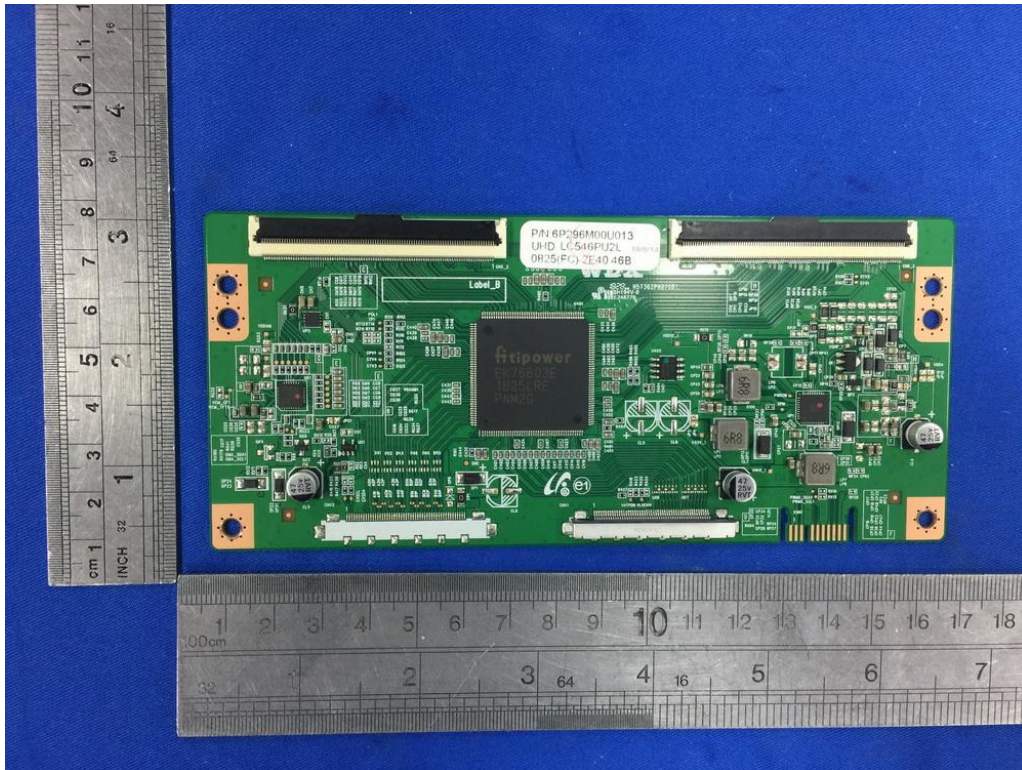

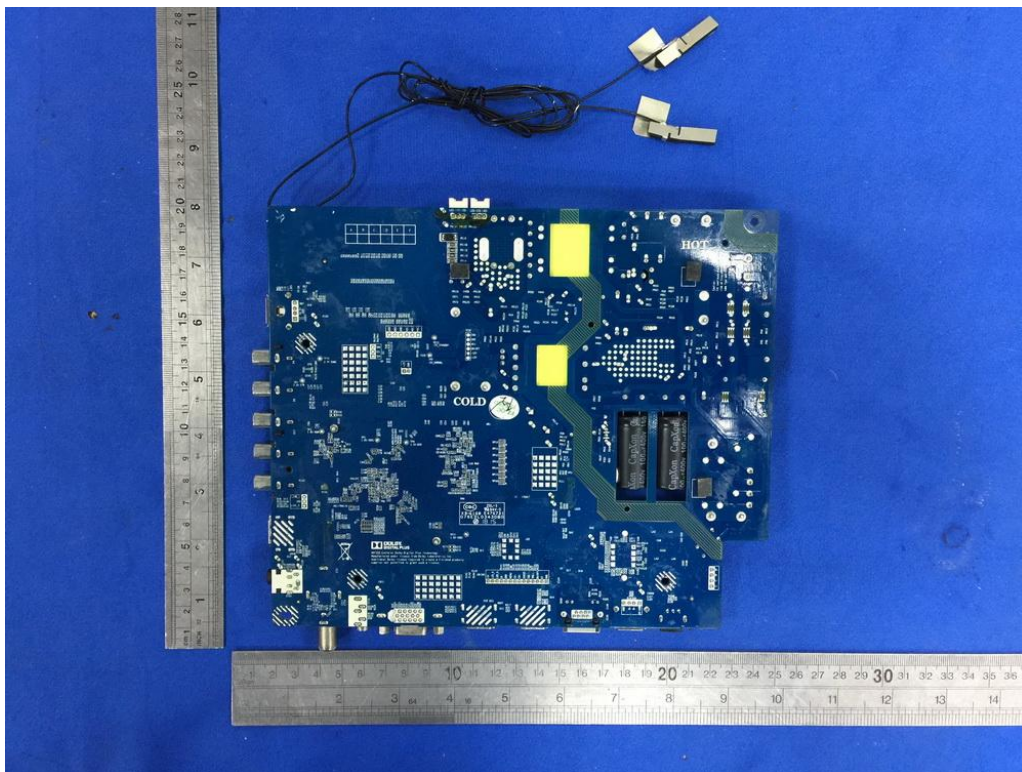
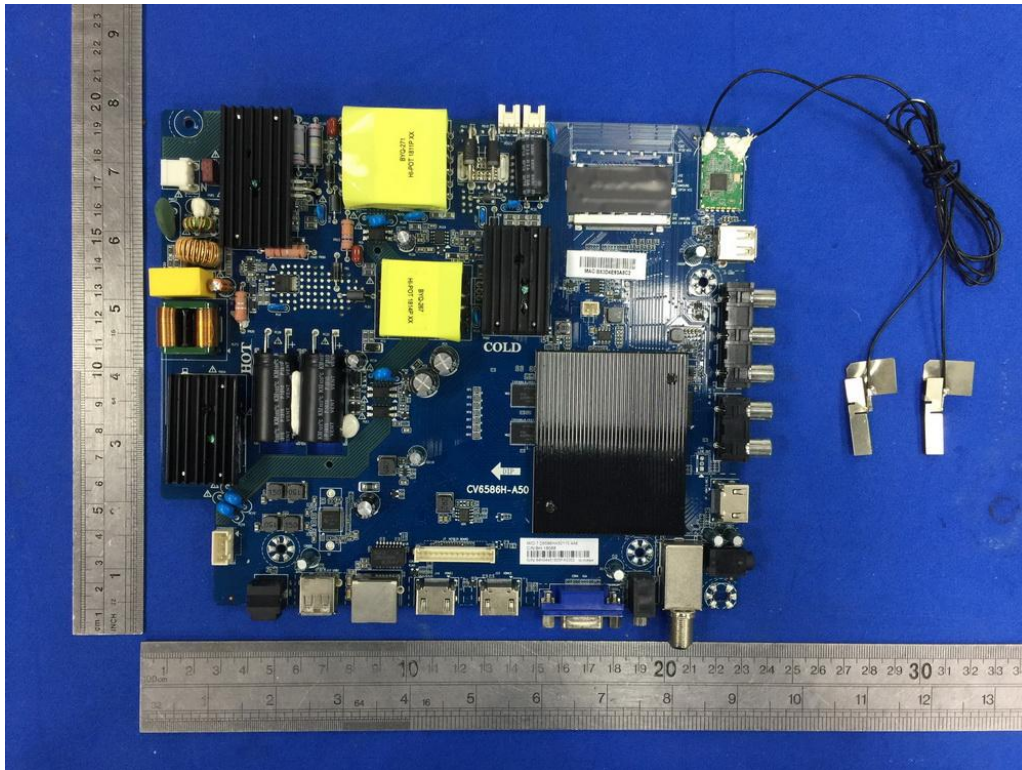

-----The end-----