

CONTENTS

Important Safety Instructions	2
Safety Information	3
Preparation	4
What's Included	
Front View	
Rear View	
Installing the Stand	
Removing the Stand for Wall-Mounting	
Wall-Mounting Screws	
Remote Control	
Connecting External Devices	9
Customizing TV Settings	10
Initial Setup	
Streaming	
My Media	
Viewing Photos	
Listening to Music	
Watching Videos	
TV Settings	
General	
Picture	
Audio	
Network	
Channel	
Time	
Lock	
APP settings	
Source	
Parental Control	21
Troubleshooting	23
Maintaining	24
Specification	25
OTT APP Service	26

IMPORTANT SAFETY INSTRUCTIONS

- **Read these instructions** – All the safety and operating instructions should be read before this product is operated.
- **Keep these instructions** – The safety and operating instructions should be retained for future reference.
- **Heed all warnings** – All warnings on the appliance and in the operating instructions should be adhered to.
- **Follow all instructions** – All operating and use instructions should be followed.
- **Do not use this apparatus near water** – The appliance should not be used near water or moisture – for example, in a wet basement or near a swimming pool, and the like.
- Clean only with dry cloth.
- **Do not block any ventilation openings.** Install in accordance with the manufacturer's instructions.
- **Do not install near any heat sources** such as radiators, heat registers, stoves, or other apparatus (including amplifiers) that produce heat.
- **Do not defeat the safety purpose of the polarized or grounding-type plug.** A polarized plug has two blades with one wider than the other. A grounding-type plug has two blades and a third grounding prong. The wide blade or the third prong are provided for your safety. If the provided plug does not fit into your outlet, consult an electrician for replacement of the obsolete outlet.
- Protect the power cord from being walked on or pinched particularly at plugs, convenience receptacles, and the point where they exit from the apparatus.
- Only use attachments/accessories specified by the manufacturer.
- Use only with the cart, stand, tripod, bracket, or table specified by the manufacturer, or sold with the apparatus. When a cart is used, use caution when moving the cart/apparatus combination to avoid injury from tip-over.



- Unplug this apparatus during lightning storms or when unused for long periods of time.
- Refer all servicing to qualified service personnel. Servicing is required when the apparatus has been damaged in any way, such as the power-supply cord or plug is damaged, liquid has been spilled or objects have fallen into the apparatus, the apparatus has been exposed to rain or moisture, does not operate normally, or has been dropped.
- Please keep the unit in a well-ventilated environment.

WARNING: To reduce the risk of fire or electric shock, do not expose this apparatus to rain or moisture. The apparatus should not be exposed to dripping or splashing. Objects filled with liquids, such as vases should not be placed on apparatus.

WARNING: The batteries shall not be exposed to excessive heat such as sunshine, fire or the like.

WARNING: The mains plug is used as disconnect device, the disconnect device shall remain readily operable.

WARNING: To reduce the risk of electric shock, do not remove cover (or back) as there are no user-serviceable parts inside. Refer servicing to qualified personnel.



 This lightning flash with arrowhead symbol within an equilateral triangle is intended to alert the user to the presence of non-insulated "dangerous voltage" within the product's enclosure that may be of sufficient magnitude to constitute a risk of electric shock.

 The exclamation point within an equilateral triangle is intended to alert the user to the presence of important operating and maintenance instructions in the literature accompanying the appliance.

 This equipment is a Class II or double insulated electrical appliance. It has been designed in such a way that it does not require a safety connection to electrical earth.

 This product contains electrical or electronic materials. The presence of these materials may, if not disposed of properly, have potential adverse effects on the environment and human health.

Presence of this label on the product means it should not be disposed of as unsorted waste and must be collected separately. As a consumer, you are responsible for ensuring that this product is disposed of properly.

HDMI® The terms HDMI and HDMI High-Definition Multimedia Interface, and the HDMI Logo are trademarks or registered trademarks of HDMI Licensing Administrator, Inc. in the United States and other countries.

SAFETY INFORMATION

To ensure reliable and safe operation of this equipment, please carefully read all the instructions in this user guide, especially the safety information below.

Electrical Safety

- The TV set should only be connected to a main power supply with voltage that matches the label at the rear of the product.
- To prevent overload, do not share the same power supply socket with too many other electronic components.
- Do not place any connecting wires where they may be stepped on or tripped over.
- Do not place heavy items on any connecting wire, which may damage the wire.
- Hold the main plug, not the wires, when removing from a socket.
- During a thunderstorm or when not in using the television for long periods, turn off the power switch on the back of the television.
- Do not allow water or moisture to enter the TV or power adapter. Do NOT use in wet, moist areas, such as bathrooms, steamy kitchens or near swimming pools.
- Pull the plug out immediately, and seek professional help if the main plug or cable is damaged, liquid is spilled onto the set, if the TV set accidentally exposed to water or moisture, if anything accidentally penetrates the ventilation slots or if the TV set does not work normally.
- Do not remove the safety covers. There are no user serviceable parts inside. Trying to service the unit yourself is dangerous and may invalidate the product's warranty. Qualified personnel must only service this apparatus.
- To avoid a battery leakage, remove batteries from the remote control, when the remote is not use for long period, or when the batteries are exhausted.
- Do not break open or throw exhausted batteries into a fire.
- For best results, use type AAA (example-alkaline, carbon-zinc, etc.) batteries.
- Install only new batteries of the same type in your product.
- Failure to insert batteries in the correct polarity, as indicated in the battery compartment, may shorten the life of the batteries or cause batteries to leak.
- Do not mix old and new batteries.
- Do not mix Alkaline, Standard (Carbon-Zinc) or Rechargeable (Nickel Cadmium) or (Nickel Metal Hydride) batteries.
- Batteries should be recycled or disposed of as per state and local guidelines.
- Do not attempt to recharge disposable batteries.
- Do not short circuit battery terminals.
- Keep away from children.

Physical Safety

- Do not block ventilation slots in the back cover. You may place the TV in a cabinet, but ensure at least 5cm (2") clearance all around.
- Do not tap or shake the TV screen, or you may damage the internal circuits. Take good care of the remote control.
- To clean the TV use a soft dry cloth. Do not use solvents or petroleum based fluids.
- Do not install near any heat sources such as radiators, heat registers, stoves or other apparatus (including amplifiers) that produce heat.
- Do not defeat the safety purpose of the polarized or grounding-type plug. A polarized plug has two blades with one wider than the other. A grounding plug has two blades and a third grounding prong, the wide blade, or the third prong is provided for your safety. If the provided plug does not fit into your outlet, consult an electrician for replacement of the obsolete outlet.
- Protect the power cord from being walked on or pinched particularly at plugs.
- Unplug the apparatus during lightning storms or when unused for long periods.
- Refer all servicing to a qualified service personnel. Servicing is required if the apparatus does not operate normally or if the apparatus, including the power supply cord or plug, has been damaged in any way.
- Servicing is also required if liquid has been spilled, or objects have fallen into the apparatus; when the apparatus has been exposed to rain or moisture; or if the apparatus has been dropped.
- Always connect your television to a power outlet with protective ground connection.
- Minimum 5cm distances around the apparatus for sufficient ventilation.
- The ventilation should not be impeded by covering the ventilation openings with items, such as newspapers, table-cloths, curtains, etc.
- No naked flame sources, such as lighted candles, should be placed on the apparatus.
- Attention should be drawn to the environmental aspects of battery disposal.

PREPARATION

What's Included

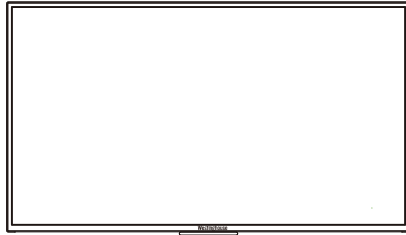

TV Set

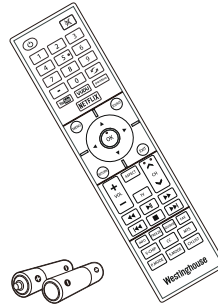

Remote Control with Batteries

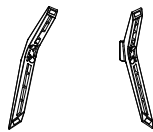

TV Stand



Four Screws

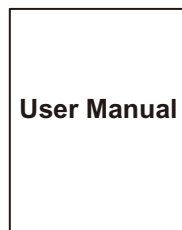

User Manual

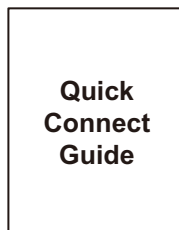

Quick Connect Guide

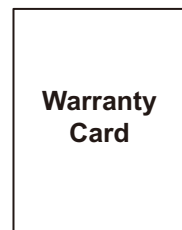

Warranty Card

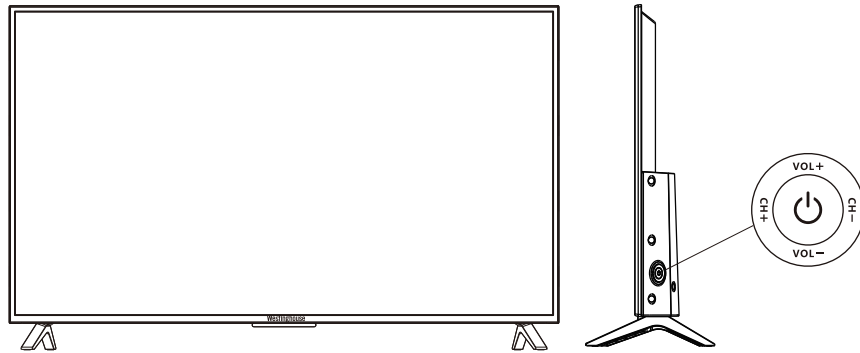
Front View

- **⏻**
Switch the TV between On / Standby mode.
- **CH +/-**
Press to select a channel.
- **VOL +/-**
Press to adjust the volume.
- **POWER Indicator**
Illuminate blue when the TV is turned on. Illuminate red when the TV is in standby mode.
- **IR (Infrared Receiver)**
Receive IR signals from the remote control.

PREPARATION

Rear View

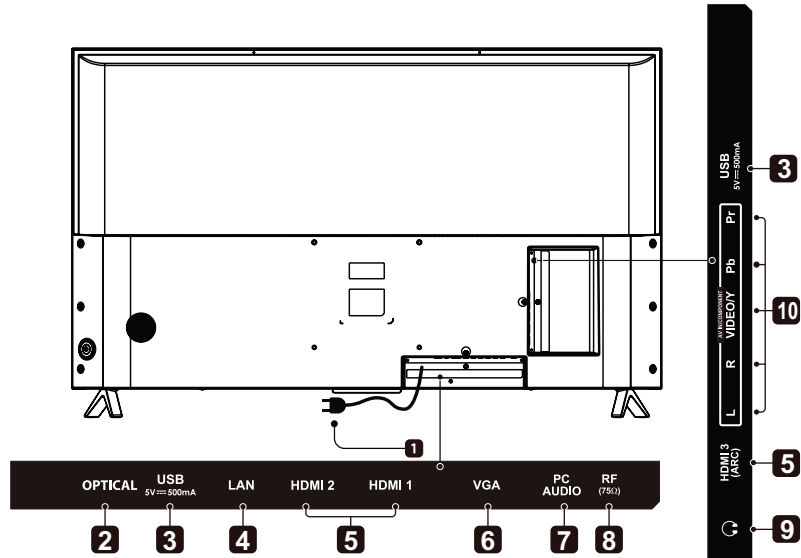

1. Power Cord

Connect to AC power outlet.

2. Optical Output

Connect a digital sound system to this jack.

3. USB Input

Connect to a USB storage device to play photo files. (USB mode)

4. LAN

Network connection port.

5. HDMI Inputs

Connect to a High-Definition (HD) signal input device.

6. VGA Input

Connect to a computer or other devices with a VGA interface.

7. PC Audio Input

Connect to a computer audio output.

8. Antenna Input (75Ω VHF/UHF)

Connect to the antenna (75Ω VHF/UHF) socket with the RF coaxial cable.

9. Headphone output

Connect to the Headphones.

10. COMPONENT/AV Input

Connect to AV devices with composite/ component (Y/Pb/Pr) video and audio output sockets. COMPONENT VIDEO and COMPONENT (Y/Pb/Pr) share with AUDIO IN (L/R).

Installing the Stand

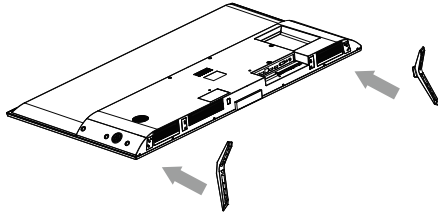

- 1. Lay the TV face down on a flat, cushioned surface to avoid damaging or scratching.
- 2. Fix the Left Base Stand to the main unit using 2 pcs provided screws.
- 3. Fix the Right Base Stand to the main unit using 2 pcs provided screws.

Removing the Stand for Wall-Mounting

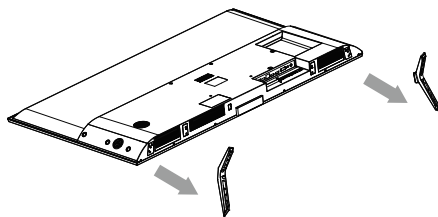

- 1. Lay the TV face down on a flat, cushioned surface to avoid damaging or scratching.
- 2. Untighten the 4 pcs screws holding the stand assembly and remove them.
- 3. Attach the wall-mount bracket to the TV using the mounting holes on the back of the TV. Mount this TV according to the instructions included in the wall-mount bracket.

Wall-Mounting Screws

- Mount the VESA bracket using 4*M6*10 isometric threaded screws (Not Supplied).
- **WARNING:** To prevent injury, this apparatus must be securely attached to the floor/wall in accordance with the installation instruction.

WARNING

Never place a television set in an unstable location. A television set may fall, causing serious personal injury or death. Many injuries, particularly to children, can be avoided by taking simple precautions such as:

- Using cabinets or stands recommended by the manufacturer of the television set.
- Only using furniture that can safely support the television set.
- Ensuring the television set is not overhanging the edge of the supporting furniture.
- Not placing the television set on tall furniture (for example, cupboards or bookcases) without anchoring both the furniture and the television set to a suitable support.
- Not placing the television set on cloth or other materials that may be located between the television set and supporting furniture.
- Attention should be drawn to the environmental aspects of battery disposal.
- Educating children about the dangers of climbing on furniture to reach the television set or its controls

If your existing television set is being retained and relocated, the same considerations as above should be applied.

PREPARATION

Remote Control

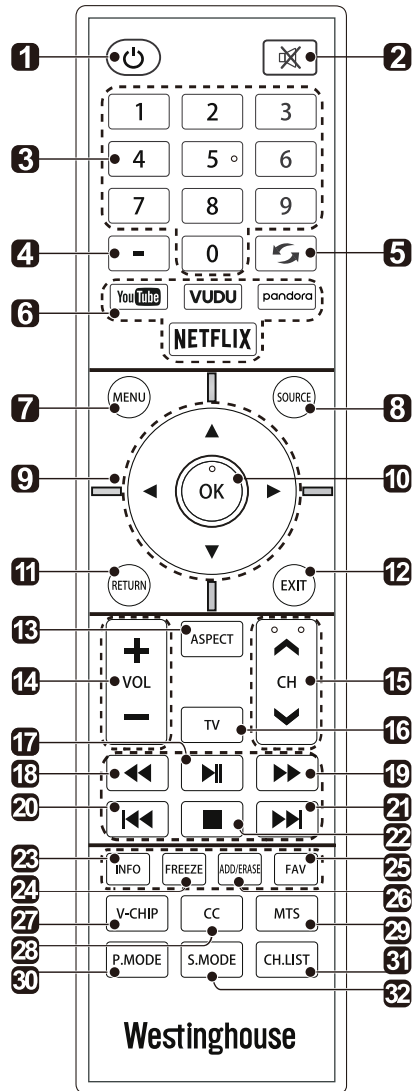

1. : Switch the TV between On and Standby mode.
2. : Mute and restore TV sound.
3. **0-9**: Select a program.(ATV/DTV mode)
4. : Enter multiple program channel number such as 2-1.
5. : Return to the previous viewing channel.
6. **APP**: Press to select the desired APP.
7. **MENU**: Display the main menu.
8. **SOURCE**: Select among the different input signal sources:TV/HDMI1/HDMI2/HDMI3/USB/VGA/AV/Component.
9. : Allows you to navigate the on screen display menus and adjust the system settings to your preference.
10. **OK**: Confirm the selection.
11. **RETURN**: Return to previous menu.
12. **EXIT**: Exit the on screen display menu.
13. **ASPECT**: Select the aspect ratio settings:standard/wide/wide zoom/zoom.
14. **VOL +/-**: Adjust the volume.
15. **CH +/-**: Select the channel.
16. **TV**: Press to turn to TV mode.
17. : Start playback or pause.
18. : Reverse playback rapidly.
19. : Advance playback rapidly.
20. : Skip to the beginning of the previous chapter/track/photo.
21. : Skip to the beginning of the next chapter/track/photo.
22. : Stop the playback.
23. **INFO**: Display the present screen information such as the current channel and input source.
24. **FREEZE**: Freeze the picture.
25. **FAV**: Display the favorite channel list.
26. **ADD/ERASE**: Add or delete Favorite channels.
27. **V-CHIP**: Set up parental control.
28. **CC**: Closed Caption selection: ON/OFF/CC On Mute.
29. **MTS**: Switch among different audio channels: STEREO/MONO/SAP.
30. **P.MODE**: Select picture mode: dynamic/movie/user/standard.
31. **CH.LIST**: Display program list.
32. **S.MODE**: Select sound mode: standard/music/movie/user.

CONNECTING EXTERNAL DEVICES

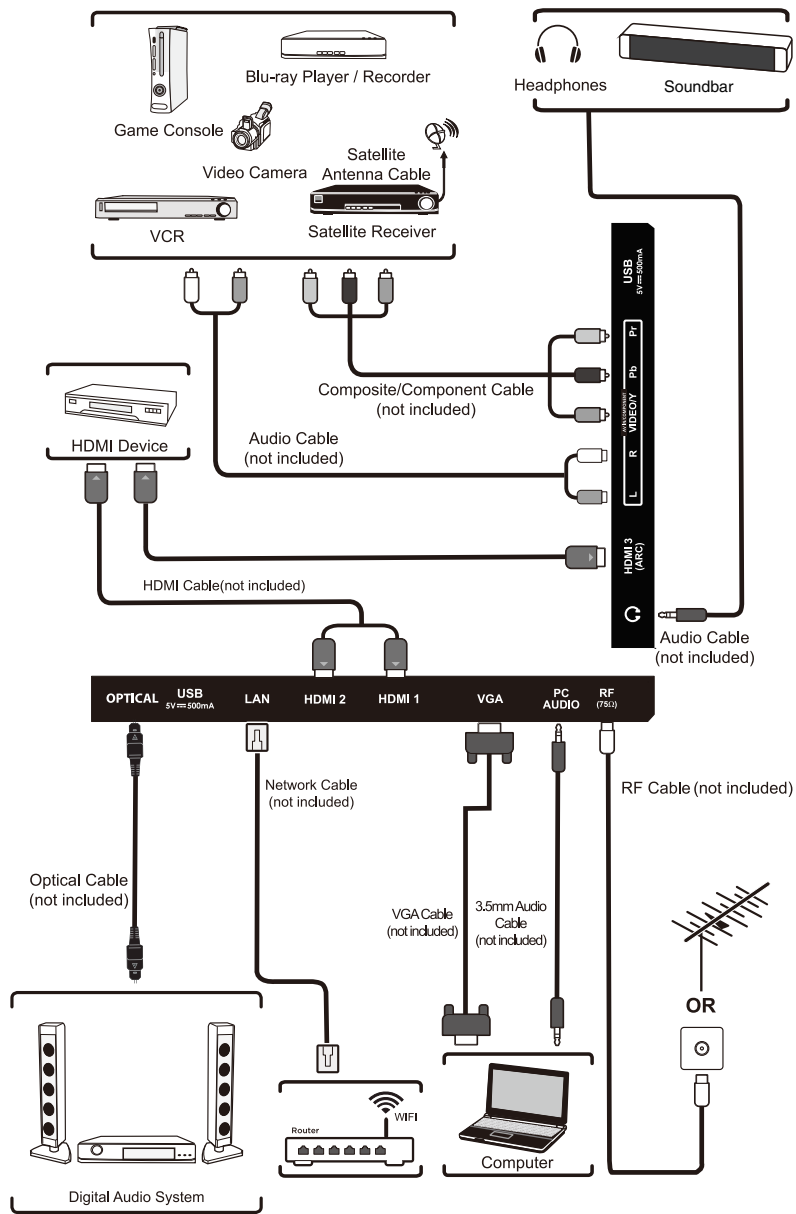

CUSTOMIZING TV SETTINGS

Initial Setup

Connect the power cord to the power socket after you have completed all the physical connections. At this stage, the TV will enter Standby Mode and the red LED indicator will illuminate.

In Standby Mode, press the **U** button on the main unit or on the remote control to turn the TV on. The red LED indicator will turn blue.

The first time you turn the TV on, it will go into the Setup Wizard. Press the **Arrow** buttons to highlight and select your desired mode and press **OK** to confirm.



- If channels cannot be found, this frame will be displayed automatically.
- The SLEEP-MODE Power should be less than 0.5 W.

STREAMING

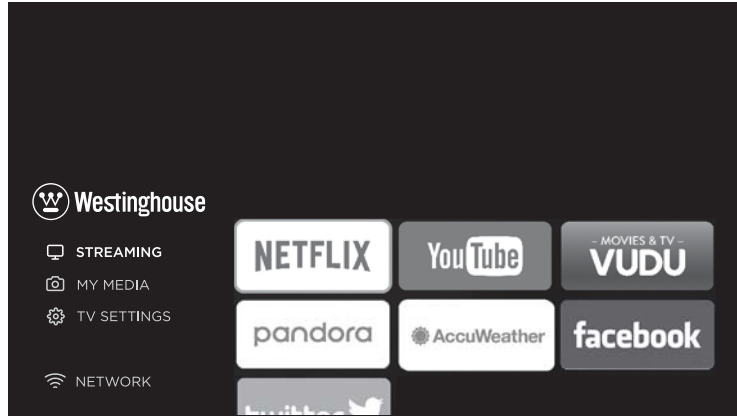

Press **MENU** to display the main interface, then use the Arrow buttons to highlight **STREAMING** and press **OK** to confirm. Use the Arrow buttons to cycle among different options and select desired apps to enter.

NETFLIX	Enjoys TV shows & movies streamed instantly over the Internet.
YouTube	YouTube your way on the best screen in your house.
VUDU	Discover, watch and collect the latest movies and TV shows in high quality 1080p. Free to sign up. No subscriptions, late fees or commitments.
Pandora	Free personalized radio that offers effortless and endless music enjoyment and discovery. Just start with the name of one of your favorite artists, songs, genres or composers and Pandora will do the rest. It's easy to create personalized stations that play only music you'll love
AccuWeather	Displays the current weather conditions and the temperature anywhere in the world in centigrade or Fahrenheit.

To obtain the best result to watching the 4k video on your 4K TV:

1. you need a high-speed internet connection and make sure your network bandwidth meets the 4k content provider's requirement.
2. access to the real 4K media; only 4K media can show the best image on 4K TV, FHD/1080p media not as detailed as 4K media.

CUSTOMIZING TV SETTINGS

MY MEDIA

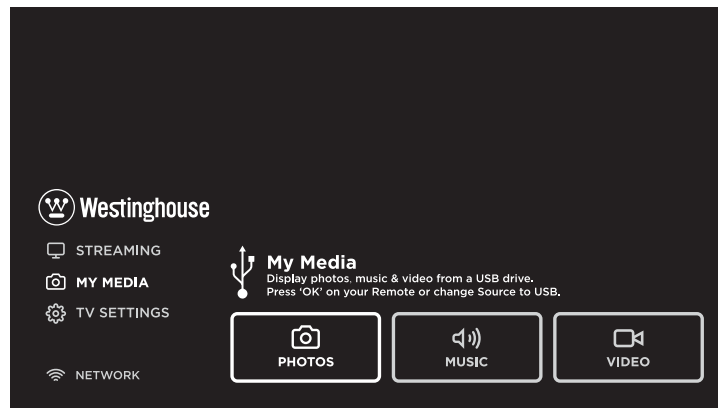

Press **MENU** button to display the main interface, then use the Arrow buttons to highlight **MY MEDIA** and press **OK** to confirm. Select among Photos, Music and Video to view what you like.

Note: Portable drives should be inserted before entering MY MEDIA menu.

□ VIEWING PHOTOS

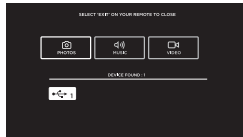

- Use the Arrow buttons to highlight the **PHOTO** option and press **OK**, then it will jump to confirm the inserted drive, press **OK** to enter.



- After entering **PHOTO**, use the Arrow buttons to select the picture file and press **OK** to enter.



- After entering the picture file, use the Arrow buttons to select the desired picture, then press the playing button to display.



- When the picture is playing, the picture Function Bar will be displayed. Use the Arrow buttons to select the desired function available on the bar.

□ LISTENING TO MUSIC

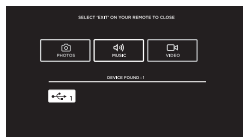

- Use the Arrow buttons to highlight the **MUSIC** option and press **OK**, then it will jump to confirm the inserted drive, press **OK** to enter.

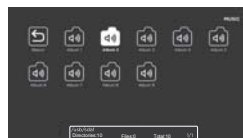

- After entering **MUSIC**, use the Arrow buttons to select the music file and press **OK** to enter.



- After entering the music file, use the Arrow buttons to select the desired music, then press the playing button to display.

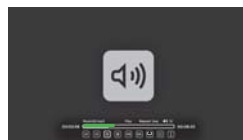

- When the music is playing, the music Function Bar will be displayed. Use the Arrow buttons to select the desired function available on the bar.

CUSTOMIZING TV SETTINGS

□ WATCHING VIDEOS



- Use the Arrow buttons to highlight the **VIDEO** option and press **OK**, then it will jump to confirm the inserted drive, press **OK** to enter.
- After entering **VIDEO**, use the Arrow buttons to select the video file and press **OK** to enter.
- After entering the video file, use the Arrow buttons to select the desired video, then press the playing button to display.
- When the video is playing, the video Function Bar will be displayed. Use the Arrow buttons to select the desired function available on the bar.

■ TV SETTINGS

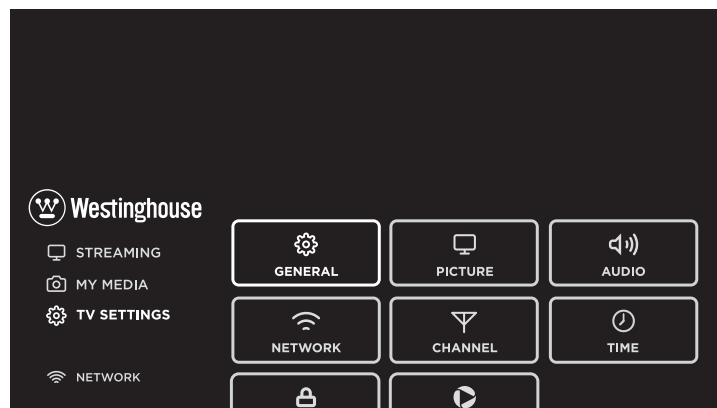

Press the **MENU** button on the main unit or on the remote control to display the main interface. Then use the **Arrow** buttons to highlight **TV Settings** and press **OK** to enter. Then use the **Arrow** buttons to cycle among the following options and select the desired one to enter.

□ GENERAL

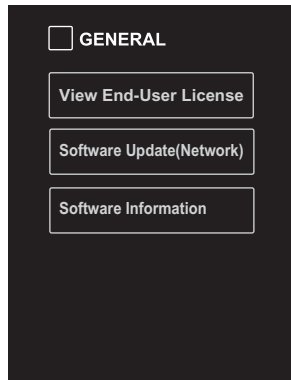
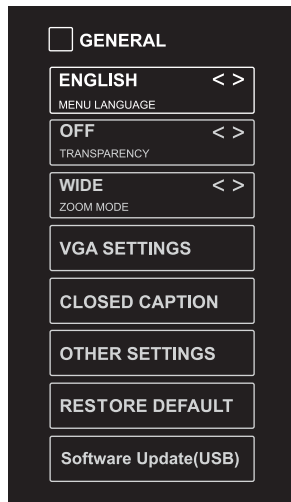

- Press **MENU** to display the main interface, use the Arrow buttons to highlight **TV SETTINGS** and press **OK** to confirm. Then use the Arrow buttons to select **GENERAL** to enter and adjust each option setting.

MENU LANGUAGE	Select the menu language among English, Français or Español. The default on-screen menu language is English.	
TRANSPARENCY	Select to turn On/Off transparency function.	
ZOOM MODE	Select zoom mode: Wide/Wide Zoom/Zoom/Standard/Just Scan(at HDMI mode)/Dot by Dot(at VGA mode). Note: With a different input source, the zoom mode options may differ.	
VGA SETTINGS	<i>Adjust advanced option's setting: H-POS, V-POS, Clock, Phase or Auto. (only available in VGA mode)</i>	
CLOSED CAPTION	CC mode	On/Off/CC on Mute.
	Basic Selection	CC1, CC2, CC3, CC4, TEXT1, TEXT2, TEXT3, TEXT4, OFF.
	Advanced Selection	Service1/Service2.../Service6/OFF.
	Option	Mode, Font Style, Font Size, Font Edge Style, Font Edge Color, FG_Color, BG_Color, FG_Opacity, BG_Opacity.

CUSTOMIZING TV SETTINGS

PICTURE

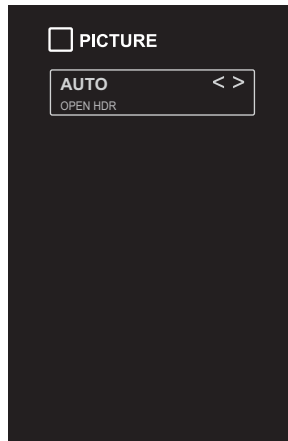
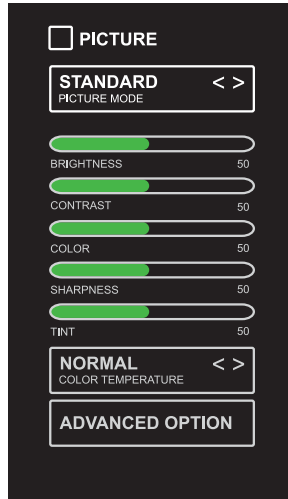

- Press **MENU** to display the main interface, use the Arrow buttons to highlight **TV SETTINGS** and press **OK** to confirm. Then use the Arrow buttons to select **PICTURE** to enter and adjust each option setting.

PICTURE MODE	Cycle among picture modes: Dynamic/Standard/Movie/User.
BRIGHTNESS	Increase or decrease the amount of white in the picture.
CONTRAST	Adjust the difference between light and dark levels in the pictures.
COLOR	Control the color intensity.
SHARPNESS	Adjust crispness level in edges between light and dark areas of the picture.
TINT	Adjust the balance between red and green levels.
COLOR TEMPERATURE	Cycle among color temperatures: Normal/Warm/Cool.
ADVANCED OPTION	Set the following options: Noise Reduction: Reduce the noise level of the connected device: Off/Weak/Middle/Strong. White Balance: Set the different options of white balance. Backlight: Set the value of backlight.
OPEN HDR	Cycle among picture modes: OFF/AUTO/LOW/MIDDLE/HIGH.

AUDIO

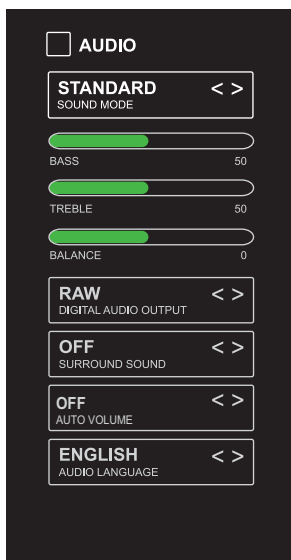

- Press **MENU** to display the main interface, use the Arrow buttons to highlight **TV SETTINGS** and press **OK** to confirm. Then use the Arrow buttons to select **AUDIO** to enter and adjust each option setting.

SOUND MODE	Allow the selection of an audio-enhancement technique: Standard/Music/Movie/User.
BASS	Control the relative intensity of lower-pitched sounds.
TREBLE	Control the relative intensity of higher-pitched sounds.
BALANCE	Adjust the relative volume of the speaker in a multiple speaker system.
DIGITAL AUDIO OUTPUT	Select the digital audio output mode between PCM/RAW.
SURROUND SOUND	Turn On/Off to provide an enhanced listening experience.
AUTO VOLUME	Turn On/Off to automatically control volume levels.
AUDIO LANGUAGE	Select audio language among: English, French, Spanish.

NETWORK

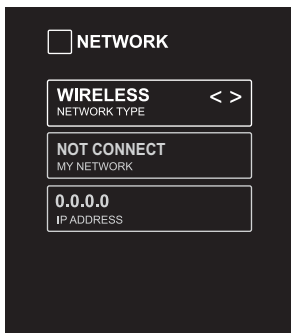

- Press **MENU** to display the main interface, use the Arrow buttons to highlight **TV SETTINGS** and press **OK** to confirm. Then Use the Arrow buttons to select **NETWORK** to enter and adjust each option setting.

NETWORK TYPE	Select Wired and Wireless network, then connect the TV to the wired network or search the wireless network through searching available Wifi.
MY NETWORK	Display the current network which you connect to.
IP ADDRESS	Display the current IP address information.

CUSTOMIZING TV SETTINGS

□ CHANNEL

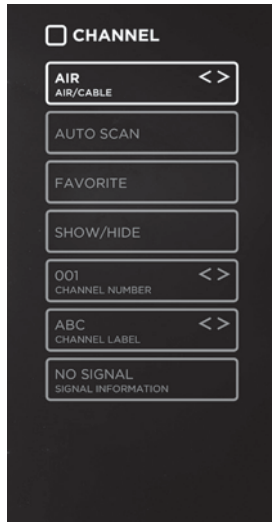

- Press **MENU** to display the main interface, use the Arrow buttons to highlight **TV SETTINGS** and press **OK** to confirm. Then use the Arrow buttons to select **CHANNEL** to enter and adjust each option setting.

AIR/CABLE	Select antenna between Air and Cable.
AUTO SCAN	Select the Auto Scan feature to scan your available cable channels.
FAVORITE	Set the selected channel as a favorite channel.
SHOW/HIDE	Show/Hide the selected channel.
CHANNEL NUMBER	Display the current channel number.
CHANNEL LABEL	Display the current channel label.

□ TIME



- Press **MENU** to display the main interface, use the Arrow buttons to highlight **TV SETTINGS** and press **OK** to confirm. Then use the Arrow buttons to select **TIME** to enter and adjust each option setting.

SLEEP TIMER	Select a period of time after which the TV automatically switches to standby mode: Off/5/10/.../180/240 min. Alternative: You may press the SLEEP button repeatedly to select the number of minutes directly.
OSD TIMER	Set the OSD timer: Off/15s/30s/60s/120s/240s.
TIME ZONE	Select a Time Zone: Pacific/Alaska/Hawaii/Atlantic/Eastern/Central/Mountain/Newfoundland.
DAYLIGHT SAVING TIME	Select to turn daylight saving time On/Off.

□ LOCK

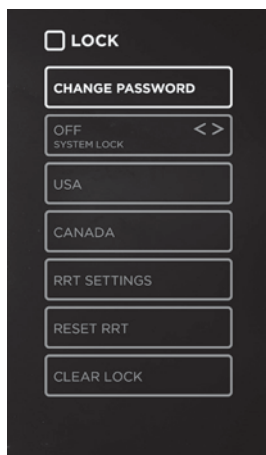

- Press **MENU** to display the main interface, use the Arrow buttons to highlight **TV SETTINGS** and press **OK** to confirm. Then use the Arrow buttons to select **LOCK** to enter and adjust each option setting.

Note: the default password is "0000".

CHANGE PASSWORD	Use 0-9 buttons to input the old password and then input the new 4-digit password. Re-enter new password for confirmation.	
SYSTEM LOCK	Select to turn system lock On/Off. The following options (USA, Canada, RRT Setting and Reset RRT) will only be accessible when you turn the system lock on.	
USA	TV	TV Rating: Press OK button to lock or unlock TV rating.
	MPAA	Set the MPAA: N/A, G, PG, PG-13,R, NC-17, X.
CANADA	Canada English	Select MPAA rating for English-speaking Canada : E, C, C8+, G, PG, 14+, 18+.
	Canada French	Select MPAA rating for Quebec Canada : E, G, 8 ans+, 13 ans+, 16 ans+, 18 ans+.
RRT SETTING	Set Rating Region Table.	
RESET RRT	Select to reset the RRT setting.	
CLEAR LOCK	Clear all lock settings.	

CUSTOMIZING TV SETTINGS

APP SETTINGS



- Press **MENU** to display the main interface, use the Arrow buttons to highlight **TV SETTINGS** and press **OK** to confirm. Then use the Arrow buttons to select **APP SETTINGS** to enter and adjust each option setting.

DEACTIVATE APP	Deactivate Netflix and clear the account information.
DEACTIVATE APP	Deactivate Vudu and clear the account information.
ESN	Electronic Serial Number.
NETFLIX VERSION	Show Netflix Version.

SOURCE

Press **SOURCE** on the remote control or on the main unit to display the source menu, then use the Arrow buttons to cycle among the different input sources: TV//AV//COMPONENT//HDMI1//HDMI2//HDMI3//VGA//USB, then use the Arrow buttons to highlight the desired source and press **OK** to confirm.



PARENTAL CONTROL

Press the **MENU** button on the main unit or on the remote control and then press buttons to select **LOCK** menu. Use the 0-9 buttons to input the 4-digit password to enter the **LOCK** menu. If used, this option feature can "block" undesirable programming from appearing on the TV.

Parental Control offers users a wide variety of options and settings that restrict or "block" the programming that can appear on the TV. Parental Control allows users to define which program rating they consider acceptable for a younger more sensitive viewer. It can be preset and turned either on or off by the user who specifies the secret 4-number password code. The number of hours blocked can also be specified.

General audience and children block should both be programmed into the TV memory. Separate different viewer ratings are specified for both TV and the motion picture Industry; both rating systems should be used and based on the ages of children.

Overview

To ensure complete coverage for all TV programs (movies and regular TV show) using the Age Block option, choose a rating from both the MPA and TV Parental Guideline tables on the next page. In addition, you may wish to add other restrictions selected from the content block menu and submenus.

Things to Consider before Setting up Parental Control

Determine which ratings you consider are acceptable for different viewers. For example, if you choose TV-PG, more restrictive ratings will be automatically blocked; some viewers will not be able to see: TV-PG, TV-14, or TV-MA rated programs. You may block the auxiliary video source entirely.

Use the Content Blk option to block program Content based on individual parameters such as: Strong Dialog, Bad Language, Sex Scenes, Violence Scenes or Fantasy.

Go into the Set Password option and use the numeric keys on the remote control to set a secret password, then save the password, it is the only way to access the Parental Control menu and change ratings setting, or turn off Parental Control.

- You can set different Parental Control viewing restrictions for general audiences and for children; both can be active at the same time;
- Simply specifying one content block such as Sex Scenes, will not automatically restrict the programming that appears from the video sources;
- Even If you choose to leave the AUX Inputs unblocked, the ratings you specify will automatically restrict the programming that appears from the video sources;
- You cannot disable Parental Control by disconnecting the TV from power. Block hours will be automatically reset to the original block time setting specified if power is disconnected.

PARENTAL CONTROL

• Motion Picture Association of America (MPAA) Rating System

	Grade	Meaning
G	General Audiences	Content not offensive to most viewers.
PG	Parental Guidance Suggested	Content is such that parents may not want their children to view the program.
PG-13	Parents Strongly Cautioned	Program is inappropriate for preteens, with a greater degree of offensive material suggested than a PG rated program.
R	Restricted	Not for children under 17-contains strong element of sex and/or violence.
NC-17	No children under age 17	Not for children under 17-under any circumstances. Contains strong sexual content.
X	Hard Core Films	Same as NC-17 rating.
No Rating	No Rating	MPAA did not rate.

• TV Parental Guideline Rating System

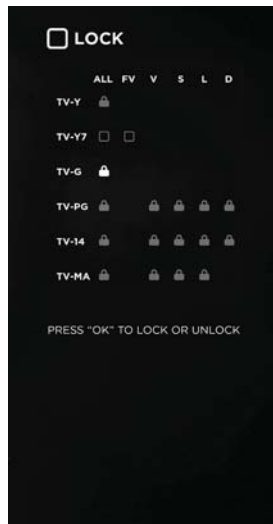

- Select **LOCK** option in the TV Settings, then use the Arrow buttons to highlight USA and press **OK** button to enter. Select TV to enter set TV parental guideline rating system.

	Grade	Meaning
TV-Y	All Children	Content not offensive to most viewers.
TV-Y7	Directed to Older Children	Considered suitable for children over 7- may contain fantasy violence scenes.
TV-G	General Audience	Considered suitable for all audience; children may watch unattended.
TV-PG	Parental Guidance Suggested	Suggested unsuitable for younger children- may contain suggestive language, bad language, sex and violence scenes.
TV-14	Parents Strongly Cautioned	unsuitable for children under 14 - may contain strong language, bad language, sex, and violence scenes.
TV-MA	Mature Audience Only	Adults only- may contain strong language, bad language, sex, and violence scenes.

- Canadian English is used throughout all English-speaking Canada (E, C, C8+, G, PG, 14+, 18+).
- Canadian French is used in Quebec (E, G, 8 ans+, 13 ans+, 16 ans+, 18 ans+)
- The V-Chip will automatically block certain categories that are "more restrictive". If you block TV-Y category, then TV-Y7 will be automatically blocked. Similarly, if you block TV-G category, then all the categories in the "young adult" will be blocked (TV-G, TV-PG, TV-14 and TV-MA).
- TV-NO: The channel is not locked.

TROUBLESHOOTING

If your TV does not operate normally or cannot be turned on, please check the following troubleshooting questions. Remember also to check any other connected electronic device, such as a DVD or Blu-ray player to pinpoint the problem. If the TV still fails to operate normally, please contact technical support.

The TV does not operate properly	
The TV does not respond when pressing any buttons	<ul style="list-style-type: none"> The TV may freeze up during use. Disconnect the power cord from the power socket for a few minutes. Reconnect the power cord and try to operate it again as usual.
TV cannot be switched on	<ul style="list-style-type: none"> Check that the TV is connected to the power supply. Make sure all connected AV devices are switched off before switching on your TV.
The remote control does not work	<ul style="list-style-type: none"> Check to see if there are any objects between the TV and the remote control causing an obstruction. Ensure that you are pointing the remote control directly at the TV. Ensure that the batteries are installed with the correct polarity (+ to +, - to -). Install new batteries.
Power is suddenly turned off	<ul style="list-style-type: none"> Check the power of the TV. The power supply maybe interrupted. Check if the sleep timer is set. Check whether the Auto Standby is activated.
The video function does not work	
No picture & no sound	<ul style="list-style-type: none"> Check whether the TV is switched on. Try another channel. The problem may be caused by the broadcaster.
Picture appears slowly after switching on	<ul style="list-style-type: none"> This is normal; the image is muted during the TV startup process. Please contact your service centre if the picture has not appeared after 5 minutes.
No or poor color or poor picture	<ul style="list-style-type: none"> Adjust the settings in the Picture menu. Try another channel. The problem may be caused by the broadcaster. Check if video cables are connected properly.
Horizontal/Vertical bar or picture shaking	<ul style="list-style-type: none"> Check for local interference such as an electrical appliance or power tool.
Poor reception on some channels	<ul style="list-style-type: none"> The station or cable channel may be experiencing problems; tune to another station. Station signal may be weak, reposition the antenna for better reception. Check for sources of possible interference.
Lines or streaks in pictures	<ul style="list-style-type: none"> Check antenna (change the position of the antenna.)
No pictures when connecting HDMI	<ul style="list-style-type: none"> Check if the input source is HDMI1/HDMI2/HDMI3.
Pictures appear in wrong ratio	<ul style="list-style-type: none"> Adjust the Aspect Ratio settings in the SETUP menu or press the ASPECT button on the remote control.
The audio function does not work	
Picture OK but no sound	<ul style="list-style-type: none"> Press the VOL +/- buttons. Sound muted? Press the MUTE button. Try another channel. The problem may be caused by the broadcaster.
No output from one of the speakers	<ul style="list-style-type: none"> Adjust the Balance settings in the AUDIO menu.
Unusual sound from inside the TV	<ul style="list-style-type: none"> A change in ambient humidity or temperature may result in an unusual noise when the TV is switched on or off and does not indicate a fault with the TV.
No sound when connecting HDMI	<ul style="list-style-type: none"> Check if the input source is HDMI1/HDMI2/HDMI3.
Audio noise	<ul style="list-style-type: none"> Keep the RF coaxial cable away from the other connected cables.

TROUBLESHOOTING

Password	
Lost password	<ul style="list-style-type: none"> Select the SET PASSWORD setting in the LOCK menu, then enter the following master password "8899". The master password clears your previous password and allows you to enter a new password.
There is a problem in PC mode	
The signal is out of range (invalid format)	<ul style="list-style-type: none"> Adjust the resolution, horizontal frequency, or vertical frequency.
Vertical bar or stripe on background & Horizontal Noise & Incorrect position	<ul style="list-style-type: none"> Use Auto configures or adjust clock, phase, or H/V position.
Screen color is unstable or show a single color	<ul style="list-style-type: none"> Check the signal cable. Reinstall the PC video card.
If the WIFI connection fails or APP has connection issue, please check the following troubleshooting questions.	
WIFI connection fails	<ul style="list-style-type: none"> Check signal strength for WIFI connection, the TV may be too far away from WIFI router. Check "authentication" setting. Make sure password is entered with correct upper or lower case letters. Check if TV is connected correctly. Try powering off and unplugging TV to reset TV. Try resetting the WIFI router, and also check for interference or WIFI channel problems.
Problems with video streaming	<ul style="list-style-type: none"> Check if internet connection is fast enough for streaming HD or 4K videos.
Netflix has connection issue	<ul style="list-style-type: none"> Try deactivating Netflix.
Can't use Vudu and Pandora	<ul style="list-style-type: none"> Vudu is only available in US and Pandora only available in limited countries.

Maintaining

- Do not use your TV in areas that are too hot or too cold, because the cabinet may warp or the screen may malfunction. Your TV works best in temperatures that are comfortable to you.
- Storage temperatures are 32° to 122°F(0° to 50°C).
- Working temperatures are 32° to 95°F(0° to 35°C).
- Do not place your TV in direct sunlight or near a heat source.
- minimum 5cm distances around the apparatus for sufficient ventilation;
- the ventilation should not be impeded by covering the ventilation openings with apparatus; items, such as newspapers, table-cloths, curtains, etc.;
- no naked flame sources,such as lighted candles,should be placed on the apparatus;
- attention should be drawn to the environmental aspects of battery disposal.

SPECIFICATION

Panel Size	49.5 inch diagonally
Display Type	LED
Panel Technology	TFT
Panel 60 Hz Vs. 120 Hz	60 Hz
Display Resolution	3840 x 2160
HDMI Support	3840 x 2160 60Hz
Panel Resolution	3840 x 2160
Aspect Ratio	16:9
Dynamic Contrast Ratio-Panel	3500~5000:1
Response Time (G To G)	9.5 ms
Lamp Life (Typ. Hours)	30,000 hours
Horizontal Viewing Angle (At CR>10)	178
Vertical Viewing Angle (At CR>10)	178
Wall-mount(LxW-mm)	200*200 VESA(mm)

The FCC Wants You to Know



FCC STATEMENT

This device complies with Part 15 of the FCC Rules. Operation is subject to the following two conditions:

1. This device may not cause harmful interference, and
2. This device must accept any interference received, including interference that may cause undesired operation. Changes or modifications not expressly approved by the party responsible for compliance could void the user's authority to operate the equipment.

NOTE: This equipment has been tested and found to comply with the limits for a Class B digital device, pursuant to Part 15 of the FCC Rules. These limits are designed to provide reasonable protection against harmful interference in a residential installation. This equipment generates uses and can radiate radio frequency energy and, if not installed and used in accordance with the instructions, may cause harmful interference to radio communications. However, there is no guarantee that interference will not occur in a particular installation. If this equipment does cause harmful interference to radio or television reception, which can be determined by turning the equipment off and on, the user is encouraged to try to correct the interference by one or more of the following measures:

1. Reorient or relocate the receiving antenna.
2. Increase the separation between the equipment and receiver.
3. Connect the equipment into an outlet on a circuit different from that to which the receiver is connected.
4. Consult the dealer or an experienced radio/TV technician for help.

FCC Radiation Exposure Statement

This equipment complies with FCC radiation exposure limits set forth for an uncontrolled environment. This equipment should be installed and operated with minimum distance 20cm between the radiator & your body.

OTT APP SERVICE

If you want to know about these APP information or get more service. Please refer to following content.

- Netflix



You can call the following telephone for more help: [866-579-7172](tel:866-579-7172)

If your matter is regarding customer service, please refer to <https://contactus.netflix.com/help> for alternative contact information.

- YouTube



You can browse the following website for more help:

<https://productforums.google.com/forum/#!categories/youtube/smart-tvs>

- VUDU



You can call the following telephone for more help: [888-554-8838](tel:888-554-8838)

- Pandora



You can send E-mail to Pandora for more help: pandora-support@pandora.com

- AccuWeather



You can send E-mail to AccuWeather for more help: CustomerService@AccuWeather.com

OBTAINING WARRANTY SERVICE

Please call Westinghouse Electronics at (800) 701-0680 or the locations of the nearest Westinghouse Electronics service center or to obtain in-home services.