



USER'S MANUAL

WE50UE4008

CONTENTS

Important Safety Instructions	2
Safety Information	3
Preparation	4
What's Included	
Front View	
Rear View	
Installing the Stand	
Removing the Stand for Wall-Mounting	
Wall-Mounting Screws	
Remote Control	
Connecting External Devices	9
Customizing TV Settings	10
Initial Setup	
Streaming	
My Media	
Viewing Photos	
Listening to Music	
Watching Videos	
TV Settings	
General	
Picture	
Audio	
Network	
Channel	
Time	
Lock	
APP settings	
Source	
Parental Control	21
Troubleshooting	23
Maintaining	24
Specification	25
OTT APP Service	26

IMPORTANT SAFETY INSTRUCTIONS

- **Read these instructions** – All the safety and operating instructions should be read before this product is operated.
- **Keep these instructions** – The safety and operating instructions should be retained for future reference.
- **Heed all warnings** – All warnings on the appliance and in the operating instructions should be adhered to.
- **Follow all instructions** – All operating and use instructions should be followed.
- **Do not use this apparatus near water** – The appliance should not be used near water or moisture – for example, in a wet basement or near a swimming pool, and the like.
- Clean only with dry cloth.
- **Do not** block any ventilation openings. Install in accordance with the manufacturer's instructions.
- **Do not** install near any heat sources such as radiators, heat registers, stoves, or other apparatus (including amplifiers) that produce heat.
- **Do not** defeat the safety purpose of the polarized or grounding-type plug. A polarized plug has two blades with one wider than the other. A grounding-type plug has two blades and a third grounding prong. The wide blade or the third prong are provided for your safety. If the provided plug does not fit into your outlet, consult an electrician for replacement of the obsolete outlet.
- Protect the power cord from being walked on or pinched particularly at plugs, convenience receptacles, and the point where they exit from the apparatus.
- Only use attachments/accessories specified by the manufacturer.
- Use only with the cart, stand, tripod, bracket, or table specified by the manufacturer, or sold with the apparatus. When a cart is used, use caution when moving the cart/apparatus combination to avoid injury from tip-over.



- Unplug this apparatus during lightning storms or when unused for long periods of time.
- Refer all servicing to qualified service personnel. Servicing is required when the apparatus has been damaged in any way, such as the power-supply cord or plug is damaged, liquid has been spilled or objects have fallen into the apparatus, the apparatus has been exposed to rain or moisture, does not operate normally, or has been dropped.
- Please keep the unit in a well-ventilated environment.

WARNING: To reduce the risk of fire or electric shock, do not expose this apparatus to rain or moisture. The apparatus should not be exposed to dripping or splashing. Objects filled with liquids, such as vases should not be placed on apparatus.

WARNING: The batteries shall not be exposed to excessive heat such as sunshine, fire or the like.

WARNING: The mains plug is used as disconnect device, the disconnect device shall remain readily operable.

WARNING: To reduce the risk of electric shock, do not remove cover (or back) as there are no user-serviceable parts inside. Refer servicing to qualified personnel.



This lightning flash with arrowhead symbol within an equilateral triangle is intended to alert the user to the presence of non-insulated "dangerous voltage" within the product's enclosure that may be of sufficient magnitude to constitute a risk of electric shock.



The exclamation point within an equilateral triangle is intended to alert the user to the presence of important operating and maintenance instructions in the literature accompanying the appliance.



This equipment is a Class II or double insulated electrical appliance. It has been designed in such a way that it does not require a safety connection to electrical earth.



This product contains electrical or electronic materials. The presence of these materials may, if not disposed of properly, have potential adverse effects on the environment and human health.

Presence of this label on the product means it should not be disposed of as unsorted waste and must be collected separately. As a consumer, you are responsible for ensuring that this product is disposed of properly.

HDMI® This TV incorporates High-Definition Multimedia Interface (HDMI)® technology. HDMI, the HDMI logo and High-Definition Multimedia Interface are trademarks or registered trademarks of HDMI Licensing LLC.

Licensing and Patent Information

This WESTINGHOUSE product may be covered by one or more U.S. and foreign patents and patent applications.

SAFETY INFORMATION

To ensure reliable and safe operation of this equipment, please carefully read all the instructions in this user guide, especially the safety information below.

Electrical Safety

- The TV set should only be connected to a main power supply with voltage that matches the label at the rear of the product.
- To prevent overload, do not share the same power supply socket with too many other electronic components.
- Do not place any connecting wires where they may be stepped on or tripped over.
- Do not place heavy items on any connecting wire, which may damage the wire.
- Hold the main plug, not the wires, when removing from a socket.
- During a thunderstorm or when not in using the television for long periods, turn off the power switch on the back of the television.
- Do not allow water or moisture to enter the TV or power adapter. Do NOT use in wet, moist areas, such as bathrooms, steamy kitchens or near swimming pools.
- Pull the plug out immediately, and seek professional help if the main plug or cable is damaged, liquid is spilled onto the set, if the TV set accidentally exposed to water or moisture, if anything accidentally penetrates the ventilation slots or if the TV set does not work normally.
- Do not remove the safety covers. There are no user serviceable parts inside. Trying to service the unit yourself is dangerous and may invalidate the product's warranty. Qualified personnel must only service this apparatus.
- To avoid a battery leakage, remove batteries from the remote control, when the remote is not use for long period, or when the batteries are exhausted.
- Do not break open or throw exhausted batteries into a fire.
- For best results, use type AAA (example-alkaline, carbon-zinc, etc.) batteries.
- Install only new batteries of the same type in your product.
- Failure to insert batteries in the correct polarity, as indicated in the battery compartment, may shorten the life of the batteries or cause batteries to leak.
- Do not mix old and new batteries.
- Do not mix Alkaline, Standard (Carbon-Zinc) or Rechargeable (Nickel Cadmium) or (Nickel Metal Hydride) batteries.
- Batteries should be recycled or disposed of as per state and local guidelines.
- Do not attempt to recharge disposable batteries.
- Do not short circuit battery terminals.
- Keep away from children.

Physical Safety

- Do not block ventilation slots in the back cover. You may place the TV in a cabinet, but ensure at least 5cm (2") clearance all around.
- Do not tap or shake the TV screen, or you may damage the internal circuits. Take good care of the remote control.
- To clean the TV use a soft dry cloth. Do not use solvents or petroleum based fluids.
- Do not install near any heat sources such as radiators, heat registers, stoves or other apparatus (including amplifiers) that produce heat.
- Do not defeat the safety purpose of the polarized or grounding-type plug. A polarized plug has two blades with one wider than the other. A grounding plug has two blades and a third grounding prong, the wide blade, or the third prong is provided for your safety. If the provided plug does not fit into your outlet, consult an electrician for replacement of the obsolete outlet.
- Protect the power cord from being walked on or pinched particularly at plugs.
- Unplug the apparatus during lightning storms or when unused for long periods.
- Refer all servicing to a qualified service personnel. Servicing is required if the apparatus does not operate normally or if the apparatus, including the power supply cord or plug, has been damaged in any way.
- Servicing is also required if liquid has been spilled, or objects have fallen into the apparatus; when the apparatus has been exposed to rain or moisture; or if the apparatus has been dropped.

PREPARATION

What's Included

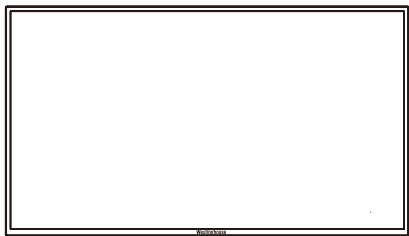

TV Set

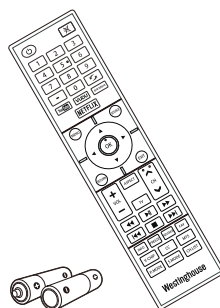

Remote Control with Batteries

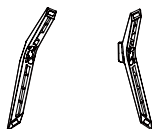

TV Stand



Four Screws

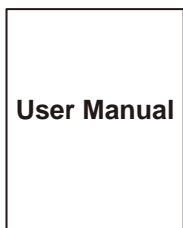

User Manual

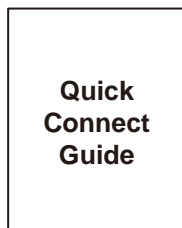

Quick Connect Guide

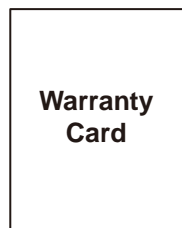

Warranty Card
Only for USA

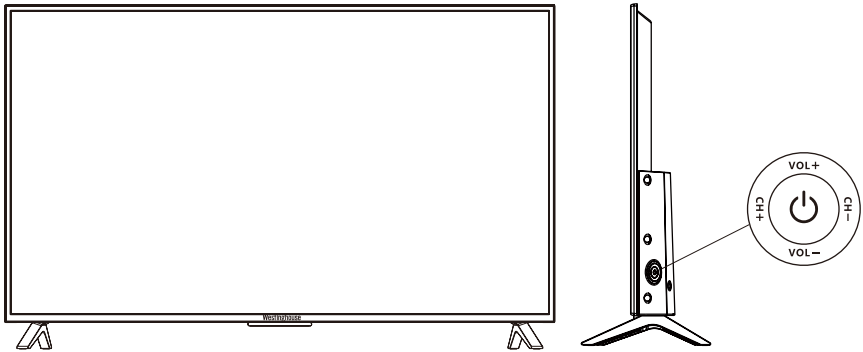
Front View

-  Switch the TV between On / Standby mode.
- **CH +/-**
Press to select a channel.
- **VOL +/-**
Press to adjust the volume.
- **POWER Indicator**
The LED indicator is white when the TV is in standby mode.
The LED indicator will turn off when the TV is turned on.
- **IR (Infrared Receiver)**
Receive IR signals from the remote control.

Rear View

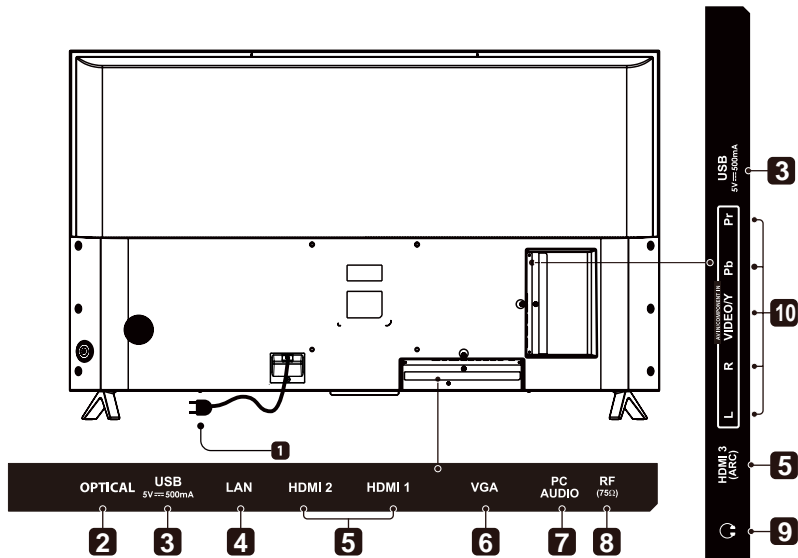

1. Power Cord

Connect to AC power outlet.

2. Optical Output

Connect a digital sound system to this jack.

3. USB Port

Connect to a USB storage device to play compatible audio, video and photo files.

4. LAN

Network connection port.

5. HDMI Inputs

Connect to a High-Definition (HD) signal output device.

6. VGA Input

Connect to a computer or other devices with a VGA interface.

7. PC Audio Input

Connect to a computer audio output.

8. Antenna Input (75Ω VHF/UHF)

Connect to the antenna (75Ω VHF/UHF) socket with the RF coaxial cable.

9. Headphone Socket

Connect to the Headphones.

10. COMPONENT/AV Input

Connect to AV devices with Component/AV output sockets.

Component Y input is sharing with composite video input (AV).

Component/AV shares with Audio in (L/R).

Installing the Stand

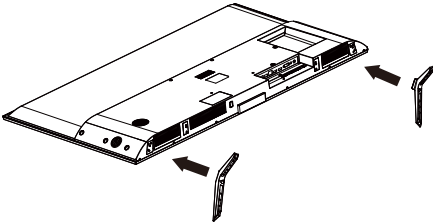

1. Lay the TV face-down on a flat, cushioned surface to avoid damages and scratches.
2. Fix the one Stand to TV using 2 pcs provided screws.
3. Fix the other Stand to the TV using 2 pcs provided screws.

Removing the Stand for Wall-Mounting

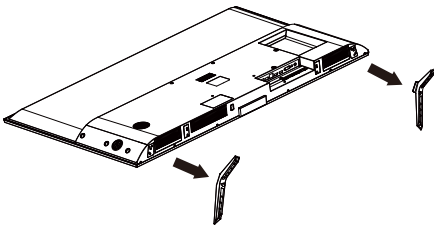

1. Lay the TV face down on a flat, cushioned surface to avoid damages and scratches.
2. Untighten the 4 pcs screws holding the stand assembly and remove them.
3. Attach the wall-mount bracket to the TV using the mounting holes on the back of the TV. Mount this TV according to the instructions included in the wall-mount bracket.

WARNING: To prevent injury, this apparatus must be securely attached to the floor/wall in accordance with the installation instruction.

Wall-Mounting Screws

- Mount the VESA bracket using 4*M6 isometric threaded screws (sold separately).
- Screws (4pcs) for attaching the TV to the wall-hanging bracket (sold separately)

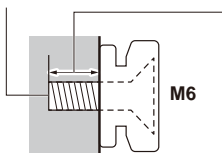

Depth of screw:
(for 50")
Minimum: 0.28" (7.0 mm)
Maximum: 0.35" (9.0 mm)

(View from the side)

WARNING

Never place a television set in an unstable location. A television set may fall, causing serious personal injury or death. Many injuries, particularly to children, can be avoided by taking simple precautions such as:

- Using cabinets or stands recommended by the manufacturer of the television set.
- Only using furniture that can safely support the television set.
- Ensuring the television set is not overhanging the edge of the supporting furniture.
- Not placing the television set on tall furniture (for example, cupboards or bookcases) without anchoring both the furniture and the television set to a suitable support.
- Not placing the television set on cloth or other materials that may be located between the television set and supporting furniture.
- Educating children about the dangers of climbing on furniture to reach the television set or its controls.

If your existing television set is being retained and relocated, the same considerations as above should be applied.

Remote Control

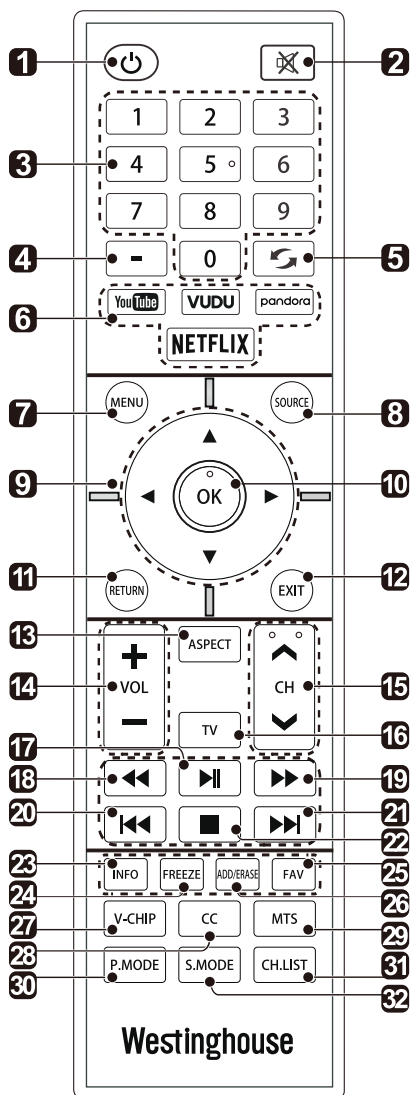

1. : Switch the TV between On and Standby mode.
2. : Mute and restore TV sound.
3. **0-9**: Select a program.(ATV/DTV mode)
4. : Enter multiple program channel number such as 2-1.
5. : Return to the previous viewing channel.
6. **APP**: Press to select the desired APP.
7. **MENU**: Display the main menu.
8. **SOURCE**: Select among the different input signal sources :TV/AV/COMPONENT/HDMI1/ HDMI2/HDMI3/VGA/USB.
9. : Allows you to navigate the on screen display menus and adjust the system settings to your preference.
10. **OK**: Confirm the selection.
11. **RETURN**: Return to previous menu.
12. **EXIT**: Exit the on screen display menu.
13. **ASPECT**: Select the aspect ratio settings:standard/wide/wide zoom/zoom/Just scan (HDMI)/Dot by dot(VGA).
14. **VOL +/-**: Adjust the volume.
15. **CH +/-**: Select the channel.
16. **TV**: Press to turn to TV mode.
17. : Start playback or pause.
18. : Reverse playback rapidly.
19. : Advance playback rapidly.
20. : Skip to the beginning of the previous chapter/track/photo.
21. : Skip to the beginning of the next chapter/ track/photo.
22. : Stop the playback.
23. **INFO**: Display the present screen information such as the current channel and input source.
24. **FREEZE**: Freeze the picture.
25. **FAV**: Display the favorite channel list.
26. **ADD/ERASE**: Add or delete Favorite channels.
27. **V-CHIP**: Set up parental control.
28. **CC**: Closed Caption selection: ON/OFF/CC On Mute.
29. **MTS**: Switch among different audio channels: STEREO/MONO/SAP.
30. **P.MODE**: Select picture mode: dynamic/movie/ user/standard.
31. **CH.LIST**: Display program list.
32. **S.MODE**: Select sound mode: standard/music/ movie/user.

CONNECTING EXTERNAL DEVICES

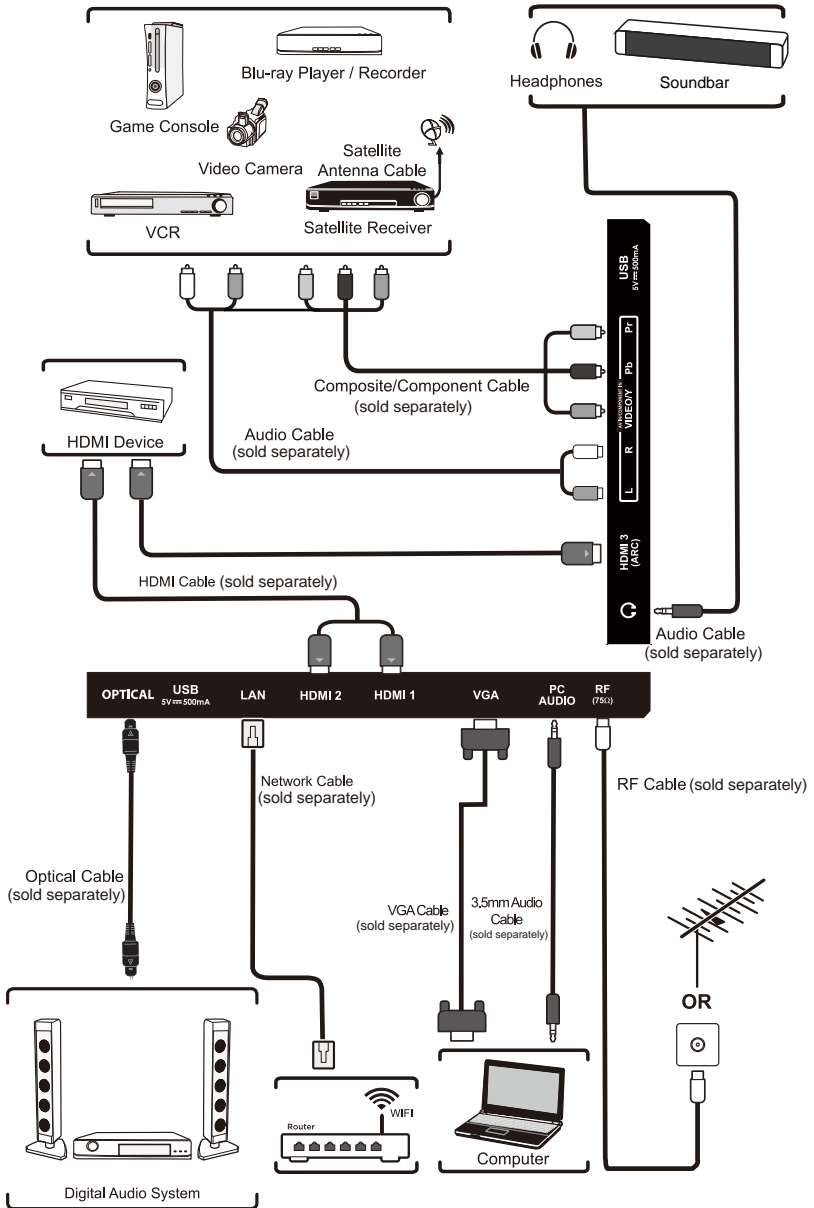

CUSTOMIZING TV SETTINGS

Initial Setup

Connect the power cord to the power socket after you have completed all the physical connections. At this stage, the TV will enter Standby Mode and the LED indicator is white.

In Standby Mode, press the **⏻** button on the main unit or on the remote control to turn the TV on. The LED indicator will turn off.

The first time you turn the TV on, it will go into the Setup Wizard. Press the **Arrow** buttons to highlight and select your desired mode and press **OK** to confirm.



- *The SLEEP-MODE Power should be less than 0.5 W.*
- *For particular models without confirmation keys on TV unit, please select the option by remote control included.*

STREAMING

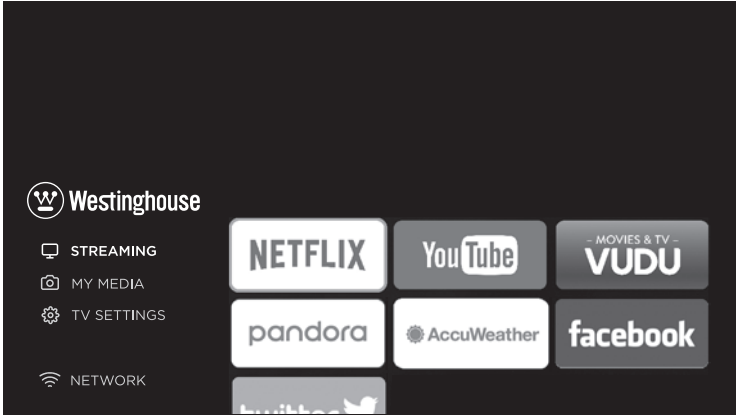

Press **MENU** to display the main interface, then use the Arrow buttons to highlight **STREAMING** and press **OK** to confirm. Use the Arrow buttons to cycle among different options and select desired apps to enter.

NETFLIX	Enjoys TV shows & movies streamed instantly over the Internet.
YouTube	YouTube your way on the best screen in your house.
VUDU	Discover, watch and collect the latest movies and TV shows in high quality 1080p. Free to sign up. No subscriptions, late fees or commitments.
Pandora	Free personalized radio that offers effortless and endless music enjoyment and discovery. Just start with the name of one of your favorite artists, songs, genres or composers and Pandora will do the rest. It's easy to create personalized stations that play only music you'll love
AccuWeather	A subscription video on-demand platform that offers animated, fun and educational cartoons, engaging games and songs from all over
Facebook	Facebook customer care service phone number is (650) 543-4800. If you're from outside of the united states, make sure to add international calling code for U.S.
Twitter	You can browse the following website for more help: https://help.twitter.com/en

To obtain the best result to watching the 4k video on your 4K TV:

1. You need a high-speed internet connection and make sure your network bandwidth meets the 4k content provider's requirement.
2. Access to the real 4K media; only 4K media can show the best image on 4K TV, FHD/1080p media not as detailed as 4K media.

Note: Before accessing APP, please ensure your TV unit has connected to the network and correctly set up to the network setting. Please refer to 'NETWORK' section and 'TROUBLE SHOOTING' section for details.

MY MEDIA

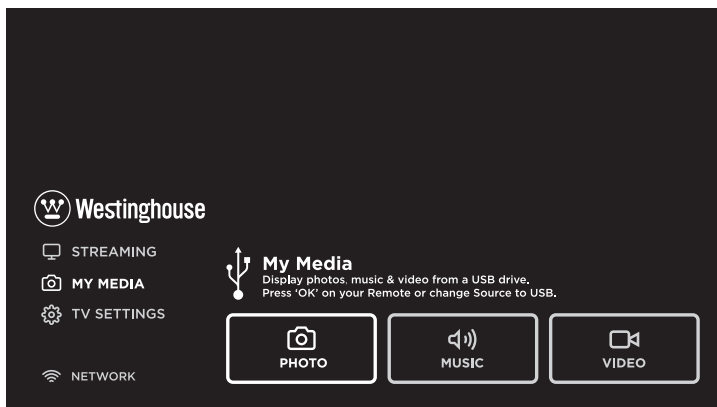

Press **MENU** button to display the main interface, then use the Arrow buttons to highlight **MY MEDIA** and press **OK** to confirm. Select among Photos, Music and Video to view what you like.

Note: Portable drives should be inserted before entering MY MEDIA menu.
Media playback is subject to compatible file format.