

**ELECTROMAGNETIC EMISSIONS COMPLIANCE REPORT  
INTENTIONAL RADIATOR CERTIFICATION TO  
FCC PART 15 SUBPART C REQUIREMENT**

*OF*

**LED TV**

**Model No.: LE-60GCL-B, ELEFW605, ELEFW606, WD60MB2240,  
WD60XXXXXXXXXX, EW60XXXXXXXXXX, SEXXXXXXXXXXX, ELXXXXXXXXXX,  
LE60GXXXXXXXXXX, LE-60GXXXXXXXXXX (where X would be any Arabic  
number or English letter or blank)**

**FCC ID: 2ACWIWD60MB224**

**Trademark: THTF, Fluid, Westinghouse, Seiki, Element, SANYO, SHARP**

**Report No.: KAD150420096E**

**Issue Date: May 26, 2015**

*Prepared for*

**Shenyang Tongfang Multimedia Technology Co., Limited  
No.10 Nanping East Road HunNan New District Shenyang, LiaoNing  
Province P.R .China**

*Prepared by*

**DONGGUAN EMTEK CO., LTD.  
No.281, Guantai Road, Nancheng District,  
Dongguan, Guangdong, China  
TEL: 86-769-22807078  
FAX: 86-769-22807079**

**This report shall not be reproduced, except in full, without the written approval of  
DONGGUAN EMTEK CO., LTD.**

**VERIFICATION OF COMPLIANCE**

Applicant:	Shenyang Tongfang Multimedia Technology Co., Limited No.10 Nanping East Road Hunnan New District Shenyang, Liaoning Province P.R .China
Manufacturer:	Shenyang Tongfang Multimedia Technology Co., Limited No.10 Nanping East Road Hunnan New District Shenyang, Liaoning Province P.R .China
Product Description:	LED TV
Model Number:	LE-60GCL-B, ELEFW605, ELEFW606, WD60MB2240, WD60XXXXXXXXXX, EW60XXXXXXXXXX, SEXXXXXXXXXX, ELXXXXXXXXXX, LE60GXXXXXXXXXX, LE-60GXXXXXXXXXX (where X would be any Arabic number or English letter or blank)

**We hereby certify that:**

The above equipment was tested by DONGGUAN EMTEK CO., LTD. The test data, data evaluation, test procedures, and equipment configurations shown in this report were made in accordance with the procedures given in ANSI C63.10-2013 and the energy emitted by the sample EUT tested as described in this report is in compliance with conducted and radiated emission limits of FCC Rules Part 15.247(2014).

Date of Test : April 20, 2015 to May 12, 2015

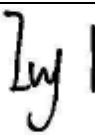
Prepared by :   
Ivy Huang/Editor

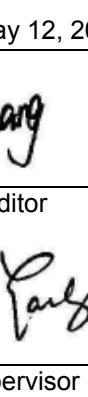
Reviewer :   
Hong Yang/Supervisor

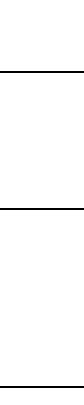
Approved & Authorized Signer :   
Sam Lv/Manager

### Modified Information

Version	Summary	Revision Date	Report No.
Ver.1.0	Original Report	/	KAD150420096E

## Table of Contents

<b>1. GENERAL INFORMATION .....</b>	<b>6</b>
1.1 PRODUCT DESCRIPTION .....	6
<b>2. SYSTEM TEST CONFIGURATION .....</b>	<b>7</b>
2.1 EUT CONFIGURATION .....	7
2.2 EUT EXERCISE .....	7
2.3 TEST PROCEDURE .....	7
2.4 CONFIGURATION OF TESTED SYSTEM .....	7
<b>3. DESCRIPTION OF TEST MODES.....</b>	<b>8</b>
<b>4. SUMMARY OF TEST RESULTS.....</b>	<b>9</b>
<b>5. TEST FACILITY.....</b>	<b>10</b>
<b>6. CONDUCTED EMISSIONS TEST .....</b>	<b>11</b>
6.1 MEASUREMENT PROCEDURE .....	11
6.2 TEST SET-UP (BLOCK DIAGRAM OF CONFIGURATION) .....	11
6.3 MEASUREMENT EQUIPMENT USED .....	11
6.4 CONDUCTED EMISSION LIMIT .....	11
6.5 MEASUREMENT RESULT .....	11
<b>7. RADIATED EMISSION TEST.....</b>	<b>14</b>
7.1 MEASUREMENT PROCEDURE .....	14
7.2 TEST SET-UP (BLOCK DIAGRAM OF CONFIGURATION) .....	15
7.3 MEASUREMENT EQUIPMENT USED .....	16
7.4 RADIATED EMISSION LIMIT .....	17
7.5 MEASUREMENT RESULT .....	18
<b>8. 6DB BANDWIDTH TEST .....</b>	<b>27</b>
8.1 MEASUREMENT PROCEDURE .....	27
8.2 TEST SET-UP (BLOCK DIAGRAM OF CONFIGURATION) .....	27
8.3 MEASUREMENT EQUIPMENT USED .....	27
8.4 MEASUREMENT RESULTS .....	27
<b>9. MAXIMUM PEAK OUTPUT POWER TEST .....</b>	<b>36</b>
9.1 MEASUREMENT PROCEDURE .....	36
9.2 TEST SET-UP (BLOCK DIAGRAM OF CONFIGURATION) .....	36
9.3 MEASUREMENT EQUIPMENT USED .....	36
9.4 PEAK POWER OUTPUT LIMIT .....	36
9.5 MEASUREMENT RESULTS .....	36
<b>10. BAND EDGE TEST .....</b>	<b>37</b>
10.1 MEASUREMENT PROCEDURE .....	37
10.2 TEST SET-UP (BLOCK DIAGRAM OF CONFIGURATION) .....	38
10.3 MEASUREMENT EQUIPMENT USED .....	38
10.4 MEASUREMENT RESULTS .....	38
<b>11. POWER DENSITY .....</b>	<b>50</b>
11.1 TEST EQUIPMENT .....	50
11.2 MEASURING INSTRUMENTS AND SETTING .....	50
11.3 TEST PROCEDURES .....	50
11.4 BLOCK DIAGRAM OF TEST SETUP .....	50
11.5 LIMIT .....	50
11.6 TEST RESULT .....	51

**12. ANTENNA PORT EMISSION.....59**

- 12.1 TEST EQUIPMENT ..... 59
- 12.2 MEASURING INSTRUMENTS AND SETTING..... 59
- 12.3 TEST PROCEDURES..... 59
- 12.4 BLOCK DIAGRAM OF TEST SETUP ..... 59
- 12.5 TEST RESULT ..... 59

**13. ANTENNA APPLICATION ..... 66**

- 13.1 ANTENNA REQUIREMENT ..... 66
- 13.2 RESULT..... 66

APPENDIX I (PHOTOS OF EUT)(8 PAGES)

## 1. General Information

### 1.1 Product Description

Characteristics	Description
Product Name	LED TV
Model number	WD60MB2240
Power Supply	AC 100V-240V, 50/60Hz, 105W OR160W
Modulation	802.11b: DSSS(DBPSK/DQPSK/CCK) 802.11g/n: OFDM(BPSK/QPSK/16QAM/64QAM)
Operating Frequency Range	2412-2462MHz for 802.11b/g/n(HT20) 2422-2452MHz for 802.11n(HT40)
Number of Channels	11 for 20MHz bandwidth; 7 for 40MHz bandwidth
Transmit Power Max	802.11b: 17.49dBm(0.056105W) 802.11g: 16.48dBm (0.044463W) 802.11n(HT20): 15.47dBm(0.035237W) 802.11n(HT40): 14.05dBm (0.025410W)
Antenna Type	Internal antenna
Antenna Gain	2.0dBi

**Note:** for more details, please refer to the User's manual of the EUT.

## 2. System Test Configuration

### 2.1 EUT Configuration

The EUT configuration for testing is installed on RF field strength measurement to meet the Commissions requirement and operating in a manner which intends to maximize its emission characteristics in a continuous normal application.

### 2.2 EUT Exercise

The Transmitter was operated in the normal operating mode. The TX frequency was fixed which was for the purpose of the measurements.

### 2.3 Test Procedure

#### 2.3.1 Conducted Emissions

The EUT is a placed on as turn table which is 0.8 m above ground plane. According to the requirements in Section 13.1.4.1 of ANSI C63.10-2013 Conducted emissions from the EUT measured in the frequency range between 0.15 MHz and 30 MHz using CISPR Quasi-Peak and average detector mode.

#### 2.3.2 Radiated Emissions

The EUT is a placed on as turn table which is 0.8 m above ground plane. The turn table shall rotate 360 degrees to determine the position of maximum emission level. EUT is set 3m away from the receiving antenna which varied from 1m to 4m to find out the highest emission. And also, each emission was to be maximized by changing the polarization of receiving antenna both horizontal and vertical. In order to find out the max. Emission, the relative positions of this hand-held transmitter (EUT) was rotated through three orthogonal axes according to the requirements in Section 13.1.4.1 of ANSI C63.10-2013.

### 2.4 Configuration of Tested System

**Fig. 2-1 Configuration of Tested System**

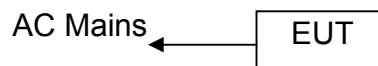

**Table 2-1 Equipment Used in Tested System**

Item	Equipment	Brand	Model No.	FCC ID	Note
1.	LED TV	Westinghouse	WD60MB2240	2ACWIWD60MB224	EUT

**Note:**

- (1) Unless otherwise denoted as EUT in 「Remark」 column, device(s) used in tested system is a support equipment.

### 3. Description of Test Modes

The EUT has been tested under its typical operating condition.

The EUT configuration for testing is installed on RF field strength measurement to meet the Commissions requirement and operating in a manner which intends to maximize its emission characteristics in a continuous normal application.

The Transmitter was operated in the normal operating mode. The TX frequency was fixed which was for the purpose of the measurements.

Test of channel included the lowest and middle and highest frequency to perform the test, then record on this report.

Those data rates (802.11b: 1 Mbps; 802.11g: 6 Mbps; 802.11n (HT20) : MCS0; 802.11n (HT40) : MCS8) were used for all test.

Pre-defined engineering program for regulatory testing used to control the EUT for staying in continuous transmitting and receiving mode is programmed.

Frequency and Channel list for 802.11 b/g/n (HT20):

Channel	Frequency (MHz)	Channel	Frequency (MHz)	Channel	Frequency (MHz)
1	2412	5	2432	9	2452
2	2417	6	2437	10	2457
3	2422	7	2442	11	2462
4	2427	8	2447		

Frequency and Channel list for 802.11 n (HT40):

Channel	Frequency (MHz)	Channel	Frequency (MHz)	Channel	Frequency (MHz)
3	2422	5	2432	8	2447
4	2427	6	2437	9	2452
		7	2442		

Test Frequency and Channel for 802.11 b/g/n (HT20):

Lowest Frequency		Middle Frequency		Highest Frequency	
Channel	Frequency (MHz)	Channel	Frequency (MHz)	Channel	Frequency (MHz)
1	2412	6	2437	11	2462

Test Frequency and channel for 802.11 n (HT40):

Lowest Frequency		Middle Frequency		Highest Frequency	
Channel	Frequency (MHz)	Channel	Frequency (MHz)	Channel	Frequency (MHz)
3	2422	6	2437	9	2452



#### 4. Summary of Test Results

<b>FCC Rules</b>	<b>Description Of Test</b>	<b>Result</b>
§15.247(a)(2)	6dB bandwidth	Pass
§15.247(b)(3)	Max Peak output Power test	Pass
§15.247(e)	Power density	Pass
§15.247(d)	Band edge test	Pass
§15.207	AC Power Conducted Emission	Pass
§15.247(d), §15.209	Radiated Emission	Pass
§15.247(d)	Antenna Port Emission	Pass
§15.247(b)&§15.203	Antenna Application	Pass

## 5. Test Facility

### Site Description

EMC Lab : Accredited by FCC, June 18, 2014  
The Certificate Number is 247565

Accredited by Industry Canada, February 19, 2014  
The Certificate Number is 9444A

Name of Firm : DONGGUAN EMTEK CO., LTD.  
Site Location : No.281, Guantai Road, Nancheng District,  
Dongguan, Guangdong, China

## 6. Conducted Emissions Test

### 6.1 Measurement Procedure

1. The EUT was placed on a table which is 0.8m above ground plane.
2. Maximum procedure was performed on the six highest emissions to ensure EUT compliance.
3. Repeat above procedures until all frequency measured were complete.

### 6.2 Test SET-UP (Block Diagram of Configuration)

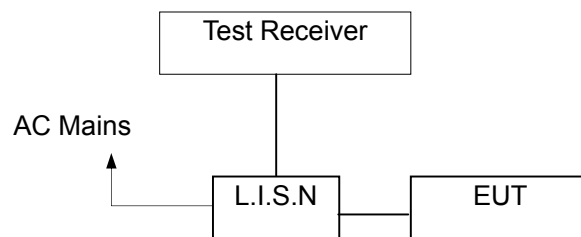

### 6.3 Measurement Equipment Used

Item	Equipment	Manufacturer	Model No.	Serial No.	Last Cal.	Cal. Interval
1.	Test Receiver	Rohde&Schwarz	ESCS30	100018	May 16, 2014	1 Year
2.	L.I.S.N.	Rohde&Schwarz	ENV216	100017	May 16, 2014	1Year
3.	RF Switching Unit	CDS	RSU-M2	38401	May 16, 2014	1Year

### 6.4 Conducted Emission Limit

Conducted Emission Frequency(MHz)	Quasi-peak	Average
0.15-0.5	66-56	56-46
0.5-5.0	56	46
5.0-30.0	60	50

- Note:** 1. The lower limit shall apply at the transition frequencies  
 2. The limit decreases in line with the logarithm of the frequency in the range of 0.15 to 0.50MHz.

### 6.5 Measurement Result

Please refer to the following pages.

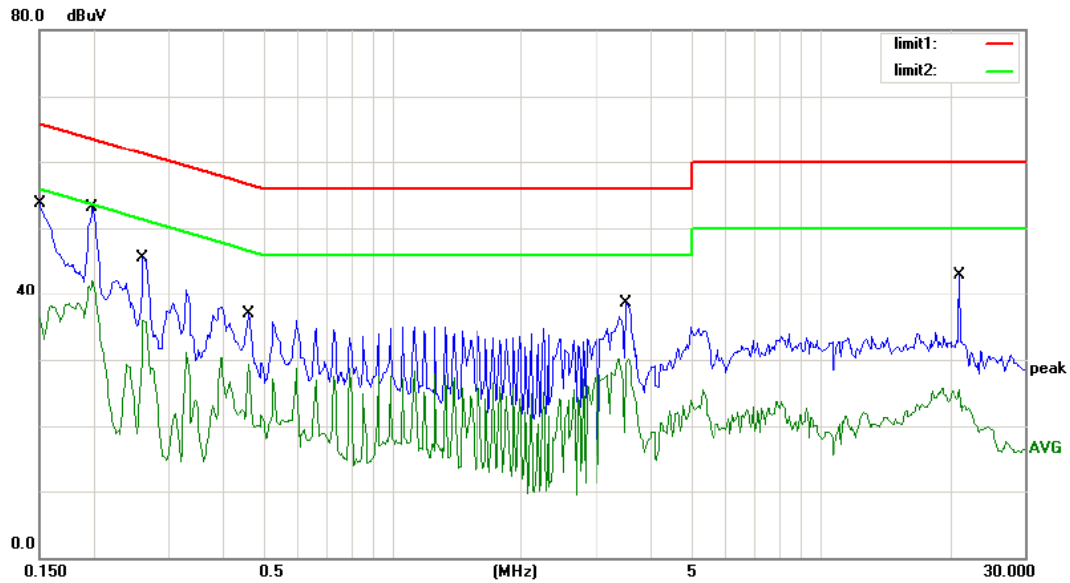

Site site #1  
 Limit: (CE)FCC PART 15 class B\_QP  
 Mode: TX  
 Note:

Phase: **L1**      Temperature: 24  
 Power: AC 120V/60Hz      Humidity: 55 %

No.	Mk.	Freq.	Reading Level	Correct Factor	Measurement	Limit	Over	Detector	Comment
		MHz	dBuV	dB	dBuV	dBuV	dB		
1		0.1500	53.61	0.00	53.61	66.00	-12.39	QP	
2		0.1500	36.22	0.00	36.22	56.00	-19.78	AVG	
3	*	0.1995	53.19	0.00	53.19	63.63	-10.44	QP	
4		0.1995	42.17	0.00	42.17	53.63	-11.46	AVG	
5		0.2625	45.46	0.00	45.46	61.35	-15.89	QP	
6		0.2625	35.88	0.00	35.88	51.35	-15.47	AVG	
7		0.4650	36.97	0.00	36.97	56.60	-19.63	QP	
8		0.4650	29.29	0.00	29.29	46.60	-17.31	AVG	
9		3.5100	38.47	0.00	38.47	56.00	-17.53	QP	
10		3.5100	30.16	0.00	30.16	46.00	-15.84	AVG	
11		21.2500	42.89	0.00	42.89	60.00	-17.11	QP	
12		21.2500	25.22	0.00	25.22	50.00	-24.78	AVG	

\*:Maximum data    x:Over limit    !:over margin    Comment: Factor build in receiver.



## 7. Radiated Emission Test

### 7.1 Measurement Procedure

1. The EUT was placed on a turn table which is 0.8m above ground plane.
2. Maximum procedure was performed on the six highest emissions to ensure EUT compliance.
3. And also, each emission was to be maximized by changing the polarization of receiving antenna both horizontal and vertical.
4. Repeat above procedures until all frequency measured was complete.

When spectrum scanned from 30MHz to 1GHz setting resolution bandwidth 120KHz and video bandwidth 300KHz:

EMI Test Receiver	Setting
Attenuation	Auto
RB	120KHz
VB	300KHz
Detector	QP
Trace	Max hold

When spectrum scanned above 1GHz setting resolution bandwidth 1MHz, video bandwidth 3MHz:

EMI Test Receiver	Setting
Attenuation	Auto
RB	1MHz
VB	3MHz
Detector	Peak
Trace	Max hold

When spectrum scanned above 1GHz setting resolution bandwidth 1MHz, video bandwidth 10Hz:

EMI Test Receiver	Setting
Attenuation	Auto
RB	1MHz
VB	10Hz
Detector	AVG
Trace	Max hold

## 7.2 Test SET-UP (Block Diagram of Configuration)

(A) Radiated Emission Test Set-Up, Frequency Below 30MHz

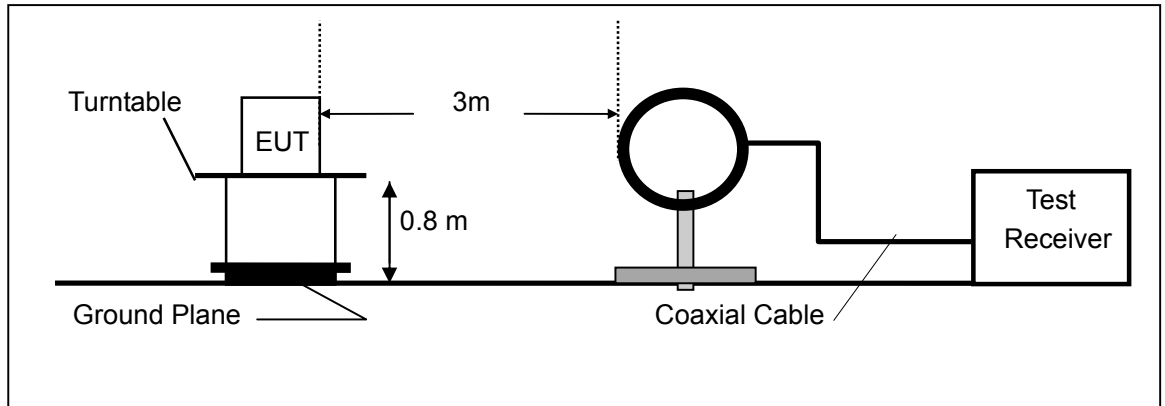

(B) Radiated Emission Test Set-Up, Frequency Below 1000MHz

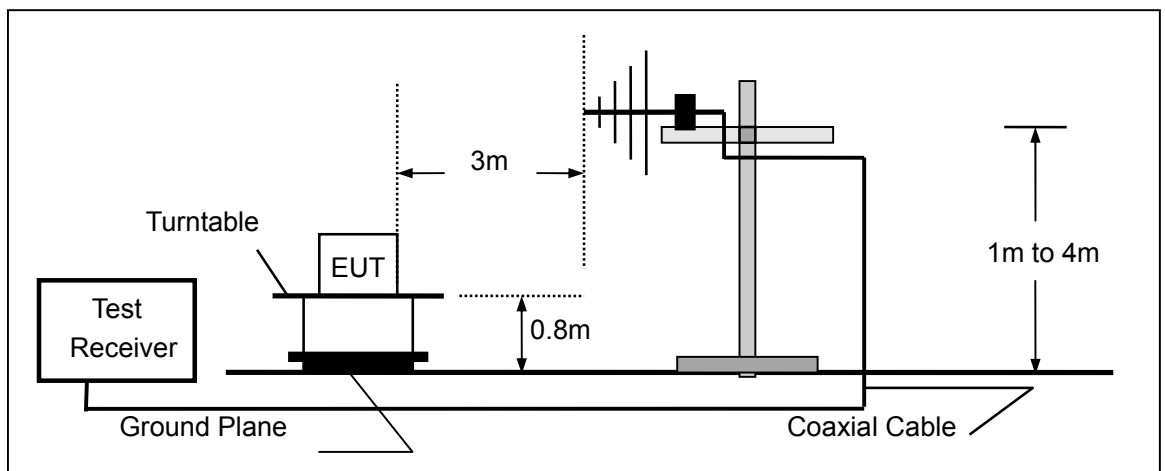

(C) Radiated Emission Test Set-Up, Frequency above 1000MHz

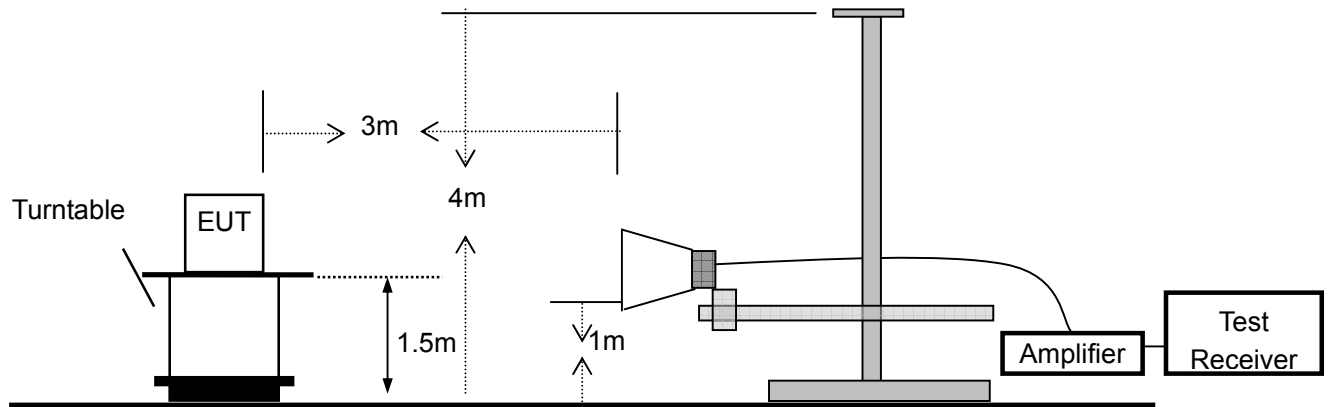

**7.3 Measurement Equipment Used**

Item	Equipment	Manufacturer	Model No.	Serial No.	Last Cal.	Cal. Interval
1.	Test Receiver	Rohde & Schwarz	ESCI	1166.5950.03	May 16, 2014	1 Year
2.	Bilog Antenna	Schwarzbeck	VULB9163	000141	May 16, 2014	1 Year
3.	Power Amplifier	CDS	RSU-M352	818	May 16, 2014	1 Year
4.	Power Amplifier	HP	8447F	OPT H64	May 16, 2014	1 Year
5.	Color Monitor	SUNSP0	SP-140A	N/A	May 16, 2014	1 Year
6.	Single Line Filter	JIANLI	XL-3	N/A	May 16, 2014	1 Year
7.	Single Phase Power Line Filter	JIANLI	DL-2X100B	N/A	May 16, 2014	1 Year
8.	3 Phase Power Line Filter	JIANLI	DL-4X100B	N/A	May 16, 2014	1 Year
9.	DC Power Filter	JIANLI	DL-2X50B	N/A	May 16, 2014	1 Year
10.	Cable	Schwarzbeck	PLF-100	549489	May 19, 2014	1 Year
11.	Cable	Rosenberger	CIL02	A0783566	May 19, 2014	1 Year
12.	Cable	Rosenberger	RG 233/U	525178	May 19, 2014	1 Year
13.	Signal Analyzer	Rohde & Schwarz	FSV30	103040	Dec 29, 2014	1 Year
14.	Horn Antenna	Schwarzbeck	BBHA9120D	9120D-1272	Dec 27, 2014	1 Year
15.	Power Amplifier	LUNAR EM	LNA1G18-40	J10100000081	Dec 29, 2014	1 Year
16.	Cable	H+S	CBL-26	N/A	Dec 29, 2014	1 Year
17.	Cable	H+S	CBL-26	N/A	Dec 29, 2014	1 Year
18.	Cable	H+S	CBL-26	N/A	Dec 29, 2014	1 Year



**7.4 Radiated Emission Limit**

The emissions from an intentional radiator shall not exceed the field strength levels specified in the following table 15.209(a):

Frequencies (MHz)	Field Strength (micorvolts/meter)	Measurement Distance (meters)
0.009~0.490	2400/F(KHz)	300
0.490~1.705	24000/F(KHz)	30
1.705~30.0	30	30
30~88	100	3
88~216	150	3
216~960	200	3
Above 960	500	3

**15.205 Restricted bands of operation**

MHz	MHz	MHz	GHz
0.090 - 0.110	16.42 - 16.423	399.9 - 410	4.5 - 5.15
<sup>1</sup> 0.495 - 0.505	16.69475 - 16.69525	608 - 614	5.35 - 5.46
2.1735 - 2.1905	16.80425 - 16.80475	960 - 1240	7.25 - 7.75
4.125 - 4.128	25.5 - 25.67	1300 - 1427	8.025 - 8.5
4.17725 - 4.17775	37.5 - 38.25	1435 - 1626.5	9.0 - 9.2
4.20725 - 4.20775	73 - 74.6	1645.5 - 1646.5	9.3 - 9.5
6.215 - 6.218	74.8 - 75.2	1660 - 1710	10.6 - 12.7
6.26775 - 6.26825	108 - 121.94	1718.8 - 1722.2	13.25 - 13.4
6.31175 - 6.31225	123 - 138	2200 - 2300	14.47 - 14.5
8.291 - 8.294	149.9 - 150.05	2310 - 2390	15.35 - 16.2
8.362 - 8.366	156.52475 - 156.52525	2483.5 - 2500	17.7 - 21.4
8.37625 - 8.38675	156.7 - 156.9	2690 - 2900	22.01 - 23.12
8.41425 - 8.41475	162.0125 - 167.17	3260 - 3267	23.6 - 24.0
12.29 - 12.293	167.72 - 173.2	3332 - 3339	31.2 - 31.8
12.51975 - 12.52025	240 - 285	3345.8 - 3358	36.43 - 36.5
12.57675 - 12.57725	322 - 335.4	3600 - 4400	( <sup>2</sup> )

- Remark 1. Emission level in dBuV/m=20 log (uV/m)  
 : 2. Measurement was performed at an antenna to the closed point of EUT distance of meters.  
 3. Only spurious frequency is permitted to locate within the Restricted Bands specified in provision of § 15.205, and the emissions located in restricted bands also comply with 15.209 limit.

## 7.5 Measurement Result

### Below 30MHz:

All the modulation modes were tested the data of the test mode are recorded in the following pages.

Operation Mode:	TX Mode	Test Date :	May 05, 2015
Frequency Range:	9KHz~30MHz	Temperature :	28
Test Result:	PASS	Humidity :	60 %
Measured Distance:	3m	Test By:	WOLF

Freq. (MHz)	Ant.Pol. H/V	Emission Level (dBuV/m)	Limit 3m (dBuV/m)	Over (dB)
--	--	--	--	--

Note: the amplitude of spurious emission that is attenuated by more than 20dB below the permissible limit has no need to be reported.

Distance extrapolation factor =  $40 \log(\text{Specific distance} / \text{test distance})$  (dB);

Limit line = Specific limits(dBuV) + distance extrapolation factor.

### Below 1000MHz:

All the modulation modes were tested the data of the worst mode (TX 802.11b) are recorded in the following pages and the others modulation methods do not exceed the limits.

Please refer to the following test plots:

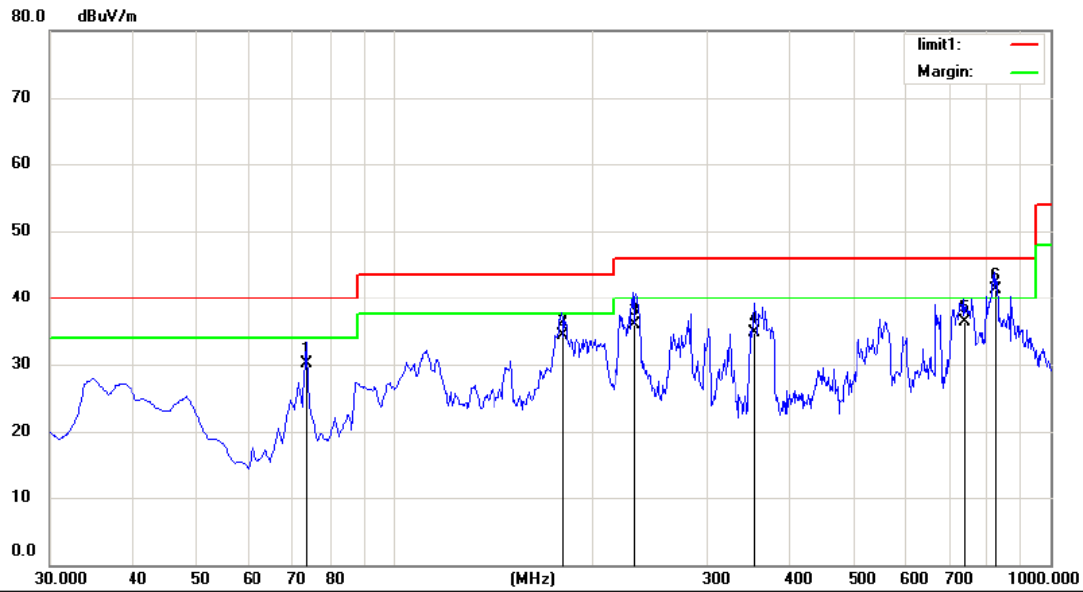

Site: Chamber #1      Polarization: **Horizontal**      Temperature: 24  
 Limit: (RE)FCC PART 15 class B 3m      Power: AC 120V/60Hz      Humidity: 55 %  
 Mode: TX2412  
 Note:

No.	Mk.	Freq. MHz	Reading Level dBuV	Correct Factor dB	Measure- ment dBuV/m	Limit dBuV/m	Over dB	Antenna Height cm	Table Degree	Detector	Comment
1		73.6500	52.60	-22.57	30.03	40.00	-9.97			QP	
2		180.3500	53.10	-18.81	34.29	43.50	-9.21			QP	
3		231.7600	51.90	-15.93	35.97	46.00	-10.03			QP	
4		354.9500	47.60	-12.83	34.77	46.00	-11.23			QP	
5		739.0700	42.30	-6.07	36.23	46.00	-9.77			QP	
6	*	827.3400	45.80	-4.47	41.33	46.00	-4.67			QP	

\*:Maximum data    x:Over limit    !:over margin

Operator: Snake

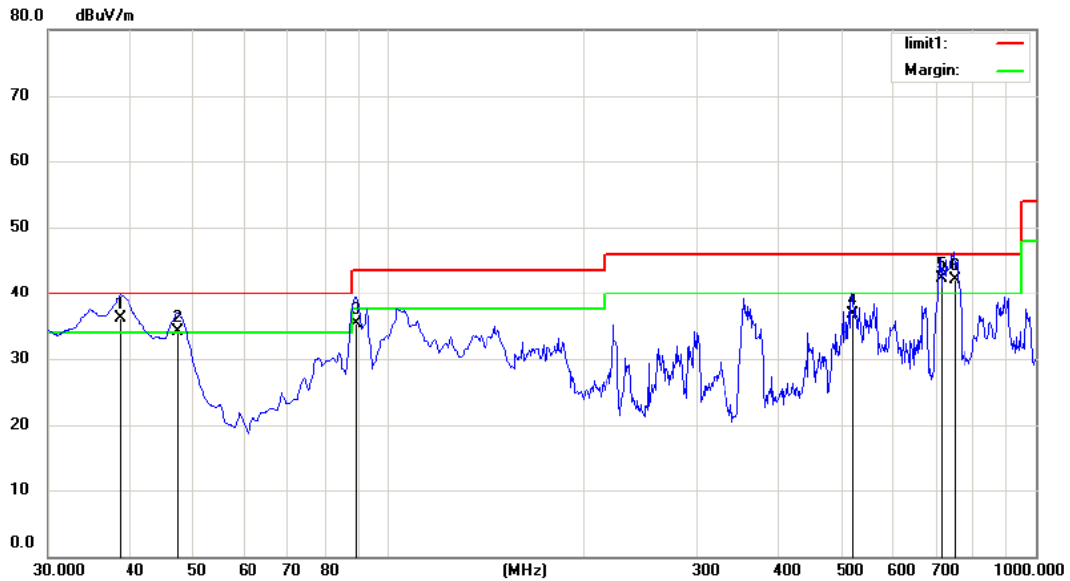

Site Chamber #1 Polarization: **Vertical** Temperature: 24  
 Limit: (RE)FCC PART 15 class B 3m Power: AC 120V/60Hz Humidity: 55 %  
 Mode: TX2412  
 Note:

No.	Mk.	Freq. MHz	Reading Level dBuV	Correct Factor dB	Measure- ment dBuV/m	Limit dBuV/m	Over dB	Antenna Height cm	Table Degree	Comment
1	!	38.7300	49.80	-13.77	36.03	40.00	-3.97	QP		
2	!	47.4600	48.50	-14.38	34.12	40.00	-5.88	QP		
3		89.1700	56.30	-21.04	35.26	43.50	-8.24	QP		
4		521.7900	46.70	-9.95	36.75	46.00	-9.25	QP		
5	*	713.8500	49.20	-6.83	42.37	46.00	-3.63	QP		
6	!	747.8000	48.10	-6.01	42.09	46.00	-3.91	QP		

\*:Maximum data x:Over limit !:over margin

Operator: Snake

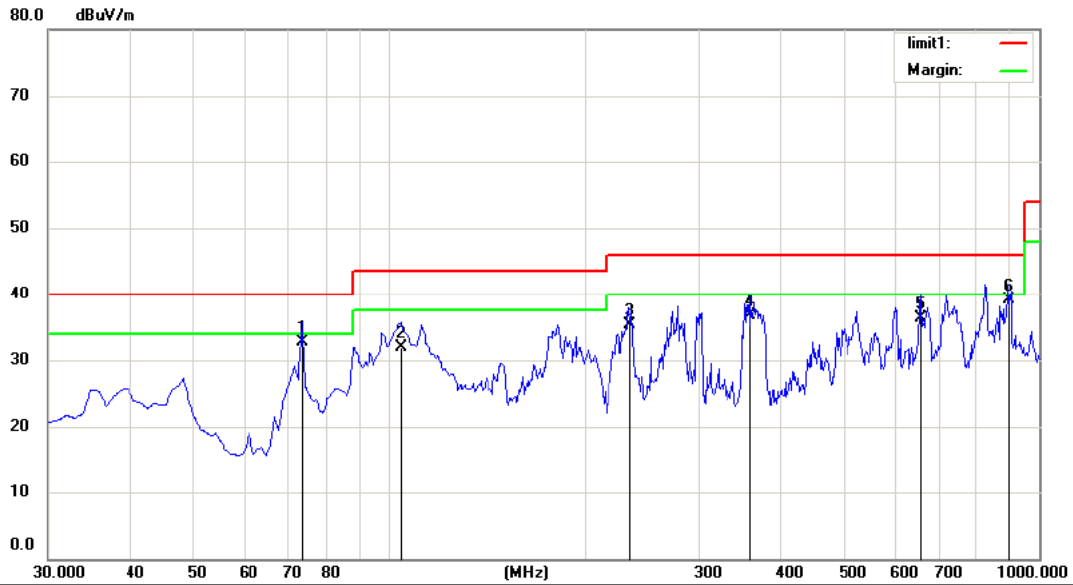

Site Chamber #1 Polarization: **Horizontal** Temperature: 24  
 Limit: (RE)FCC PART 15 class B 3m Power: AC 120V/60Hz Humidity: 55 %  
 Mode: TX2437  
 Note:

No.	Mk.	Freq. MHz	Reading Level dBuV	Correct Factor dB	Measure- ment dBuV/m	Limit dBuV/m	Over dB	Antenna Height cm	Table Degree	Comment
1		73.6500	55.20	-22.57	32.63	40.00	-7.37	QP		
2		104.6900	50.14	-18.26	31.88	43.50	-11.62	QP		
3		234.6700	51.30	-15.91	35.39	46.00	-10.61	QP		
4		359.8000	49.50	-12.71	36.79	46.00	-9.21	QP		
5		657.5900	44.20	-7.83	36.37	46.00	-9.63	QP		
6	*	898.1500	42.70	-3.68	39.02	46.00	-6.98	QP		

\*:Maximum data x:Over limit !:over margin

Operator: Snake



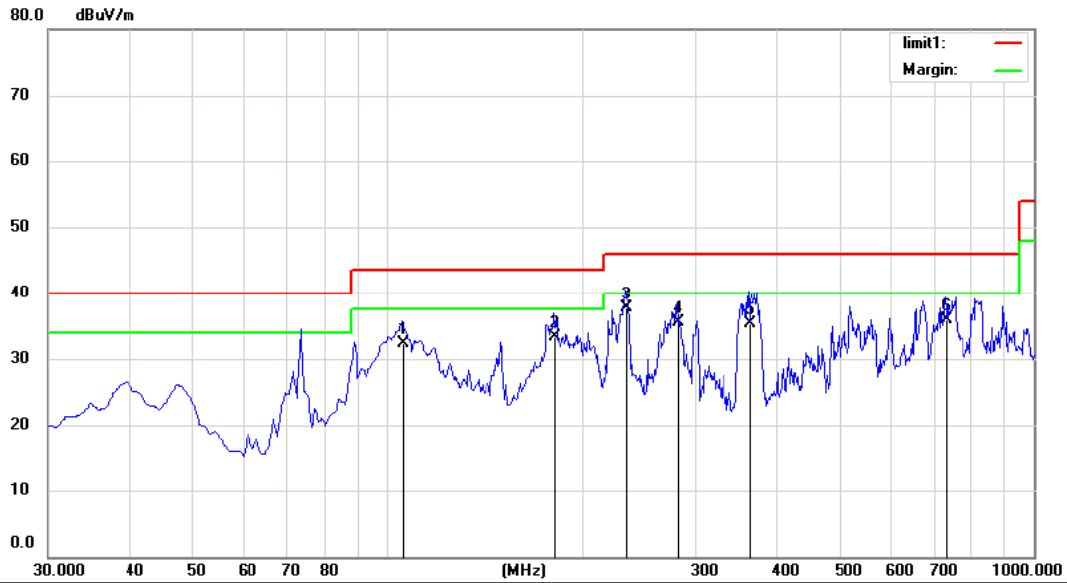

Site Chamber #1 Polarization: **Horizontal** Temperature: 24  
 Limit: (RE)FCC PART 15 class B 3m Power: AC 120V/60Hz Humidity: 55 %  
 Mode: TX2462  
 Note:

No.	Mk.	Freq.	Reading Level	Correct Factor	Measurement	Limit	Over	Antenna Height	Table Degree	
		MHz	dBuV	dB	dBuV/m	dBuV/m	dB	cm	degree	Comment
1		105.6600	50.50	-18.12	32.38	43.50	-11.12	QP		
2		181.3200	52.10	-18.73	33.37	43.50	-10.13	QP		
3	*	234.6700	53.60	-15.91	37.69	46.00	-8.31	QP		
4		281.2300	50.40	-14.89	35.51	46.00	-10.49	QP		
5		363.6800	48.00	-12.60	35.40	46.00	-10.60	QP		
6		729.3700	42.30	-6.36	35.94	46.00	-10.06	QP		

\*:Maximum data x:Over limit !:over margin

Operator: Snake





**Above 1GHz:**

Operation Mode: 802.11b Lowest Test Date : May 05, 2015

Freq. (MHz)	Ant. Pol. H/V	Emission Level(dBuV/m)		Limit 3m(dBuV/m)		Over(dB)	
		PK	AV	PK	AV	PK	AV
4824	V	65.15	45.02	74	54	-8.85	-8.98
7236	V	64.03	44.35	74	54	-9.97	-9.65
9648	V	63.82	43.92	74	54	-10.18	-10.08
12060	V	62.74	42.15	74	54	-11.26	-11.85
14472	V	61.14	41.05	74	54	-12.86	-12.95
16884	V	60.85	40.28	74	54	-13.15	-13.72
4824	H	66.35	46.35	74	54	-7.65	-7.65
7236	H	65.45	45.71	74	54	-8.55	-8.29
9648	H	64.18	44.22	74	54	-9.82	-9.78
12060	H	63.25	43.92	74	54	-10.75	-10.08
14472	H	62.95	42.82	74	54	-11.05	-11.18
16884	H	61.05	41.03	74	54	-12.95	-12.97

Operation Mode: 802.11b Middle Test Date : May 05, 2015

Freq. (MHz)	Ant. Pol. H/V	Emission Level(dBuV/m)		Limit 3m(dBuV/m)		Over(dB)	
		PK	AV	PK	AV	PK	AV
4824	V	65.33	45.02	74	54	-8.67	-8.98
7236	V	64.05	44.15	74	54	-9.95	-9.85
9648	V	63.15	43.35	74	54	-10.85	-10.65
12060	V	62.82	42.92	74	54	-11.18	-11.08
14472	V	61.72	41.08	74	54	-12.28	-12.92
16884	V	60.36	40.37	74	54	-13.64	-13.63
4824	H	66.35	45.39	74	54	-7.65	-8.61
7236	H	65.74	44.72	74	54	-8.26	-9.28
9648	H	64.05	43.15	74	54	-9.95	-10.85
12060	H	63.18	42.82	74	54	-10.82	-11.18
14472	H	62.92	41.05	74	54	-11.08	-12.95
16884	H	61.04	40.38	74	54	-12.96	-13.62

Operation Mode: 802.11b Highest

Test Date : May 05, 2015

Freq. (MHz)	Ant. Pol. H/V	Emission Level(dBuV/m)		Limit 3m(dBuV/m)		Over(dB)	
		PK	AV	PK	AV	PK	AV
4824	V	65.33	45.36	74	54	-8.67	-8.64
7236	V	64.18	44.15	74	54	-9.82	-9.85
9648	V	63.05	43.03	74	54	-10.95	-10.97
12060	V	62.74	42.15	74	54	-11.26	-11.85
14472	V	61.42	40.3	74	54	-12.58	-13.7
16884	V	60.38	39.25	74	54	-13.62	-14.75
4824	H	66.25	46.15	74	54	-7.75	-7.85
7236	H	65	45.18	74	54	-9	-8.82
9648	H	64.32	44.05	74	54	-9.68	-9.95
12060	H	63.48	43.62	74	54	-10.52	-10.38
14472	H	62.92	42.18	74	54	-11.08	-11.82
16884	H	61.72	40.58	74	54	-12.28	-13.42

**All emissions not reported were more than 20dB below the specified limit or in the noise floor.**

**No others harmonics emissions are higher than 20 dB below the limits of 47 CFR Part 15.247.**

- Note:**
- (1) All Readings are Peak Value and AV.
  - (2) Emission Level= Reading Level+Probe Factor +Cable Loss.
  - (3) Data of measurement within this frequency range shown “ – ” in the table above means the reading of emissions are attenuated more than 20dB below the permissible limits or the field strength is too small to be measured.

## 8. 6dB Bandwidth Test

### 8.1 Measurement Procedure

The EUT was operating in IEEE 802.11b, 802.11g, 802.11n(HT20), 802.11n(HT40) mode or could be controlled its channel. Printed out the test result from the spectrum by hard copy function.

1. Set resolution bandwidth (RBW) = 100 kHz.
2. Set the video bandwidth (VBW)  $\geq 3 \times$  RBW.
3. Detector = Peak.
4. Trace mode = max hold.
5. Sweep = auto couple.
6. Allow the trace to stabilize.
7. Measure the maximum width of the emission that is constrained by the frequencies associated with the two outermost amplitude points (upper and lower frequency) that are attenuated by 6 dB relative to the maximum level measured in the fundamental emission.

### 8.2 Test SET-UP (Block Diagram of Configuration)

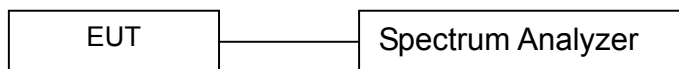

### 8.3 Measurement Equipment Used

EQUIPMENT TYPE	MFR	MODEL NUMBER	SERIAL NUMBER	LAST CAL.	CAL DUE.
Spectrum Analyzer	Rohde & Schwarz	FSV30	1321.3008K	05/16/2014	05/15/2015
Coaxial Cable	CDS	79254	46107086	05/16/2014	05/15/2015

### 8.4 Measurement Results

6 Bandwidth Test Data Chart:

Refer to attached data chart.

Spectrum Detector: PK	Test Date : May 05, 2015
Test By: Andy	Temperature : 28
Test Result: PASS	Humidity : 60%

IEEE 802.11b			
Channel frequency (MHz)	Measurement level (KHz)	Required Limit (KHz)	Result
2412	9111	>500	Pass
2437	9111	>500	
2462	9111	>500	

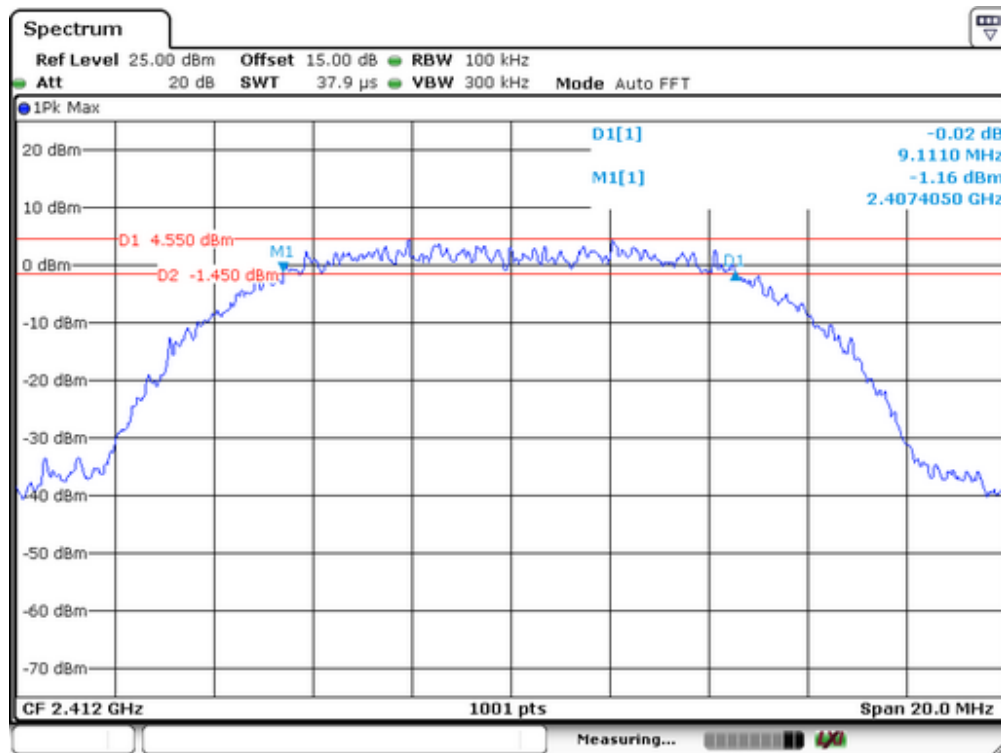

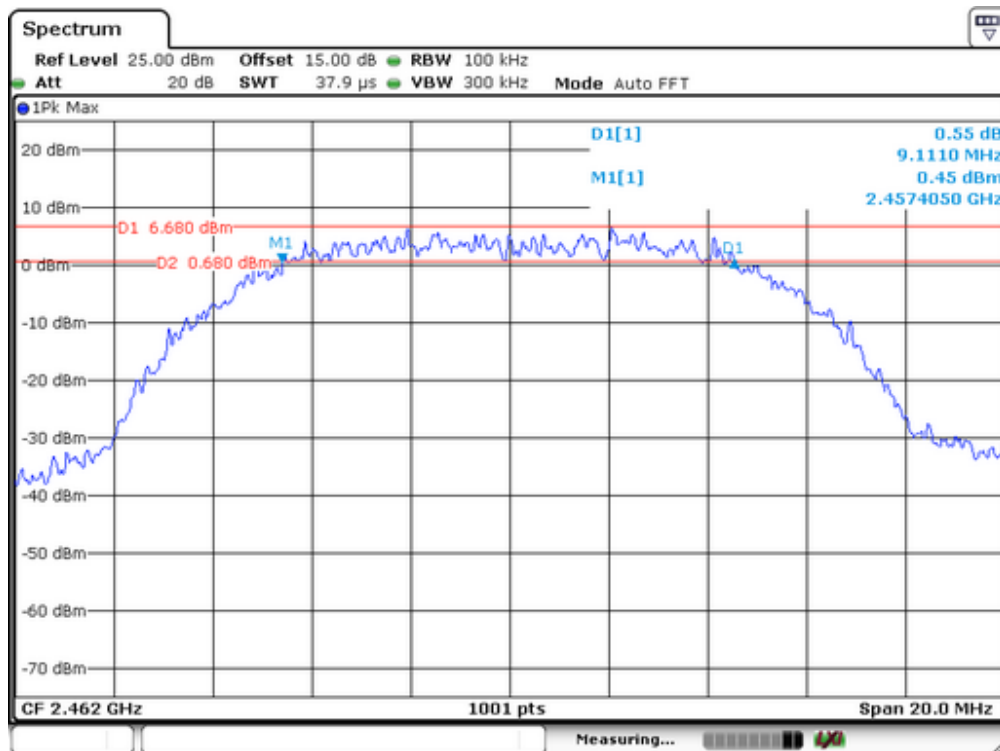
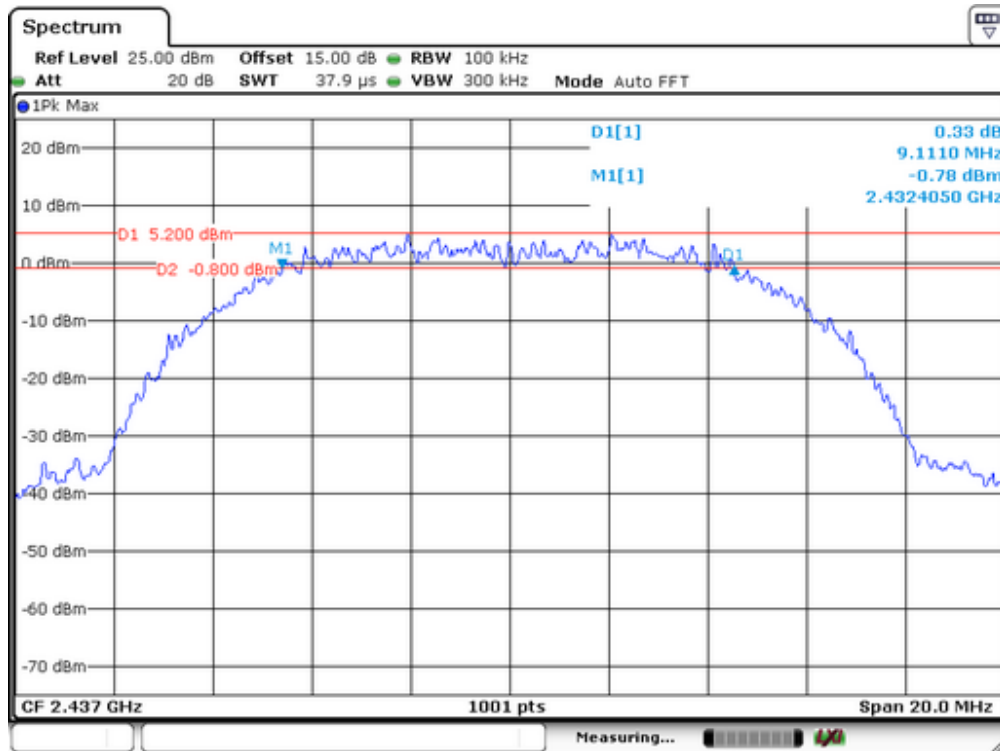

IEEE 802.11g			
Channel frequency (MHz)	Measurement level (KHz)	Required Limit (KHz)	Result
2412	16484	>500	Pass
2437	16484	>500	
2462	16484	>500	

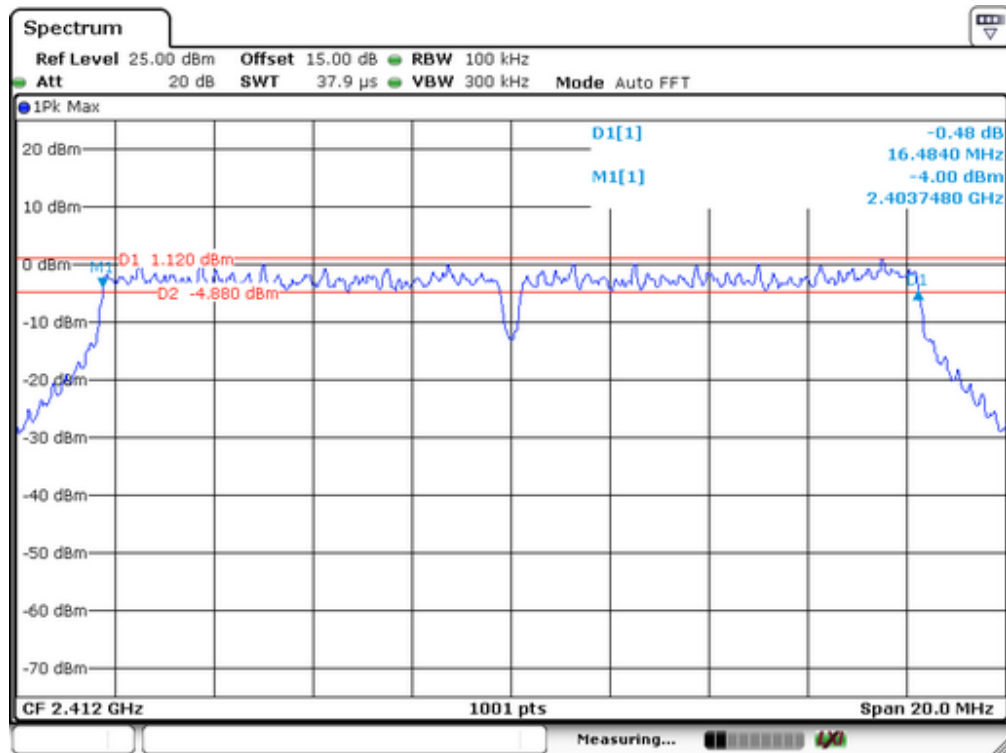

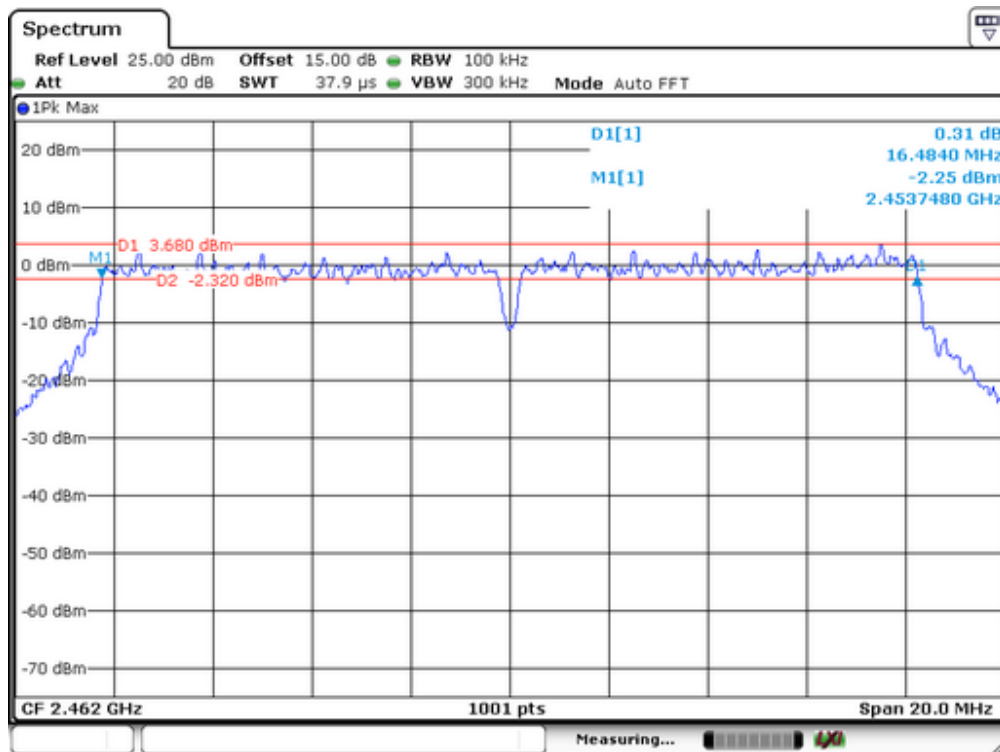
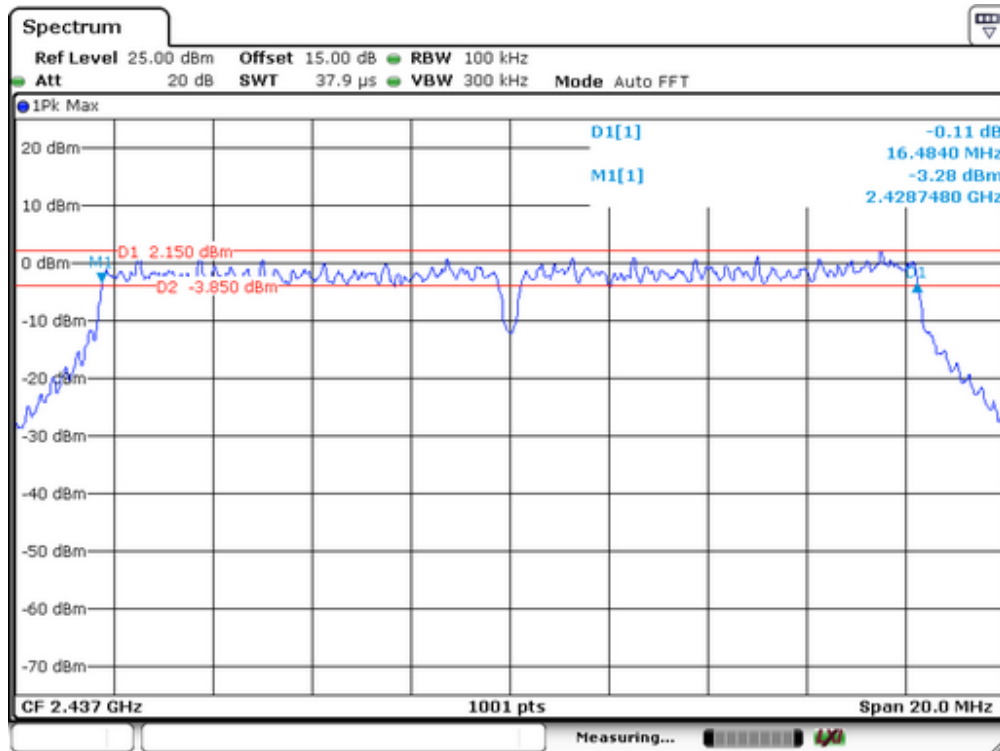

IEEE 802.11n(HT20)			
Channel frequency (MHz)	Measurement level (KHz)	Required Limit (KHz)	Result
2412	17522	>500	Pass
2437	17263	>500	
2462	17303	>500	

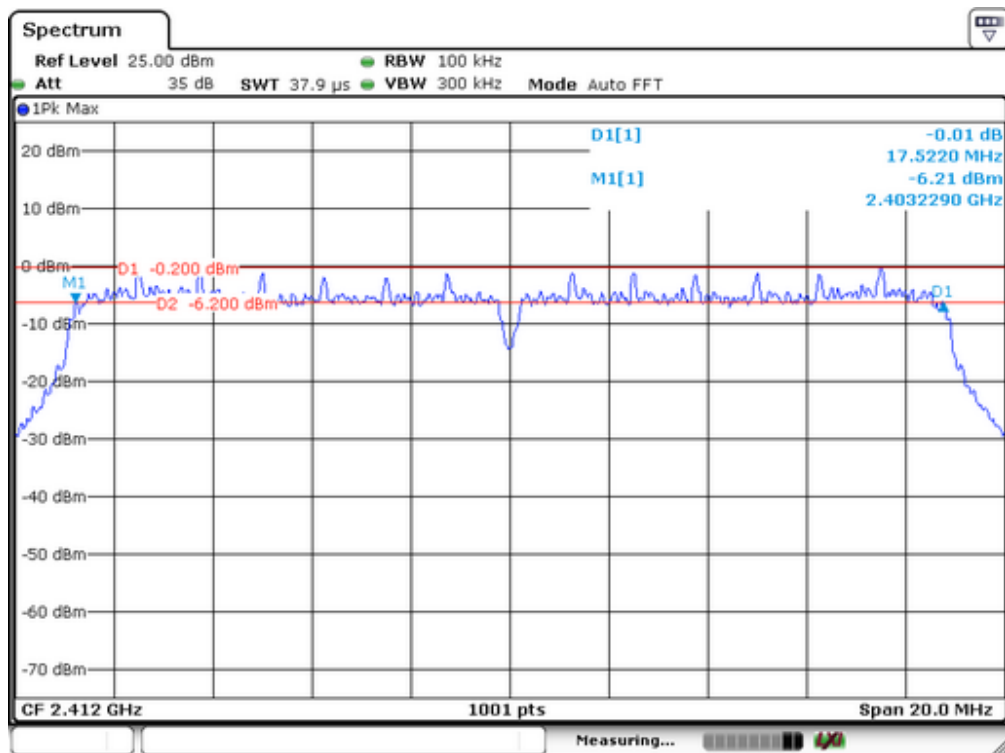



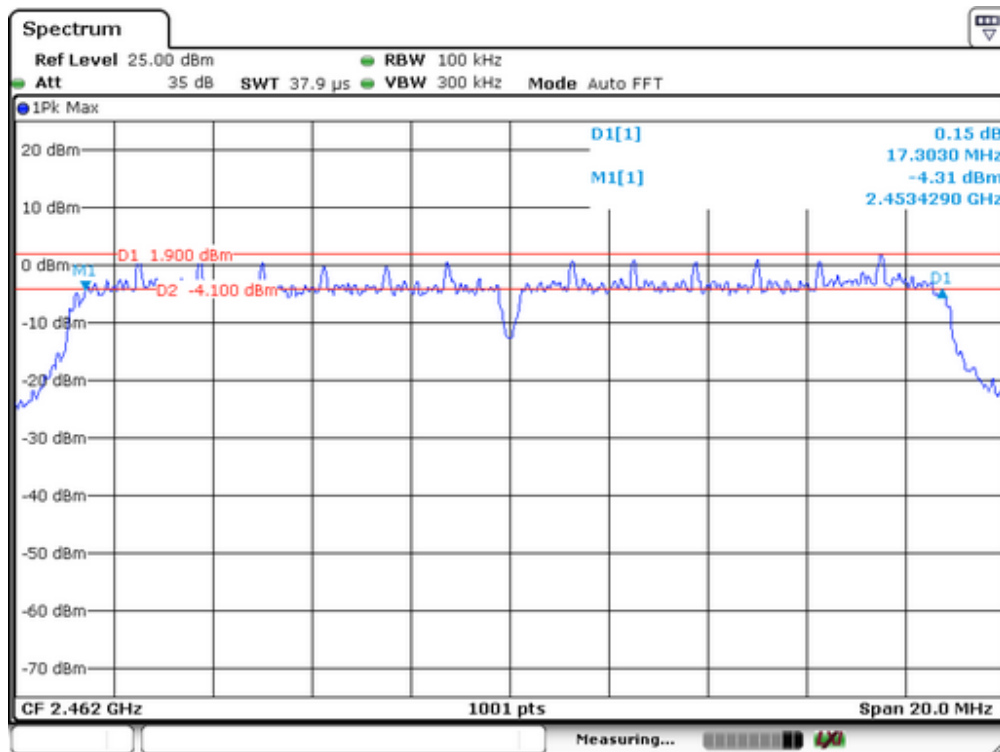
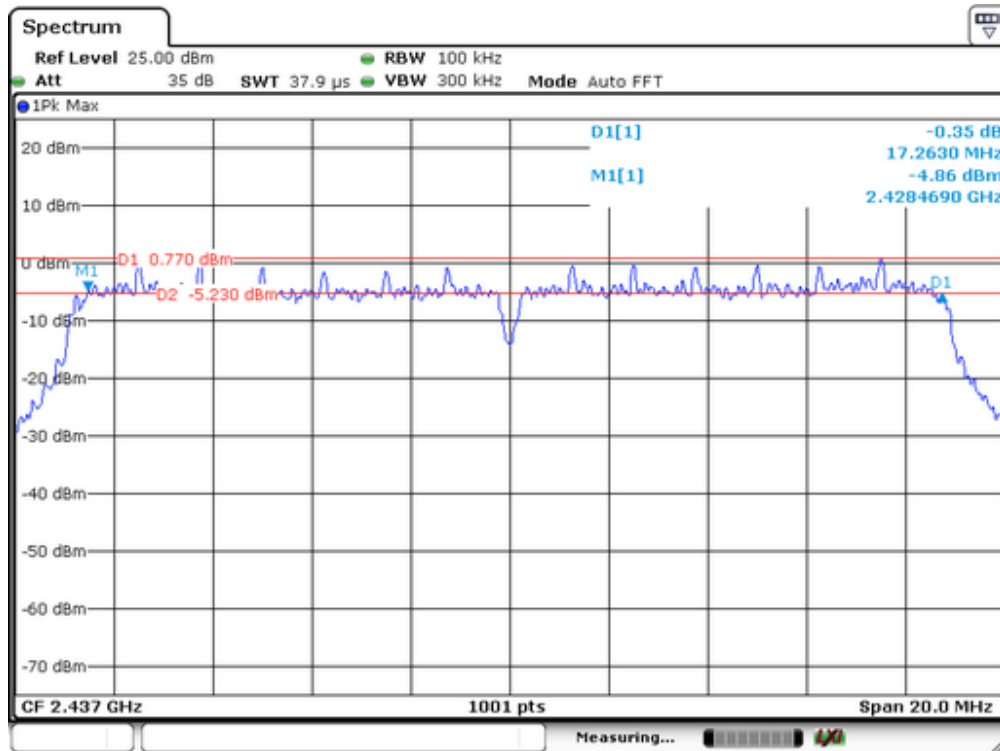

IEEE 802.11n(HT40)			
Channel frequency (MHz)	Measurement level (KHz)	Required Limit (KHz)	Result
2422	35085	>500	Pass
2437	35125	>500	
2452	35125	>500	

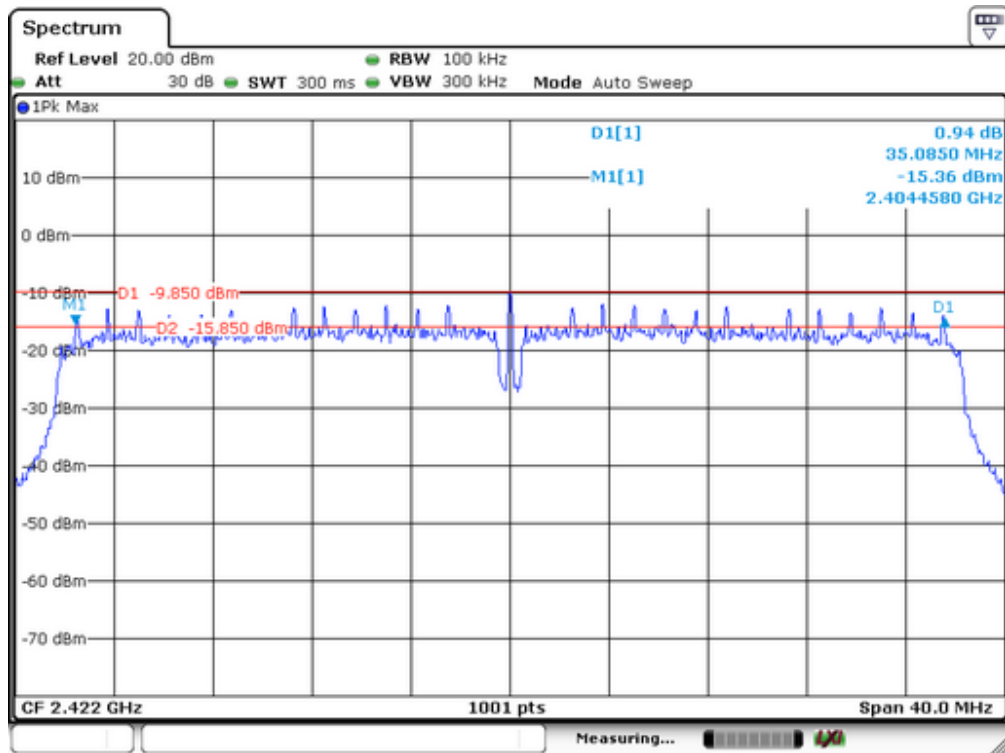

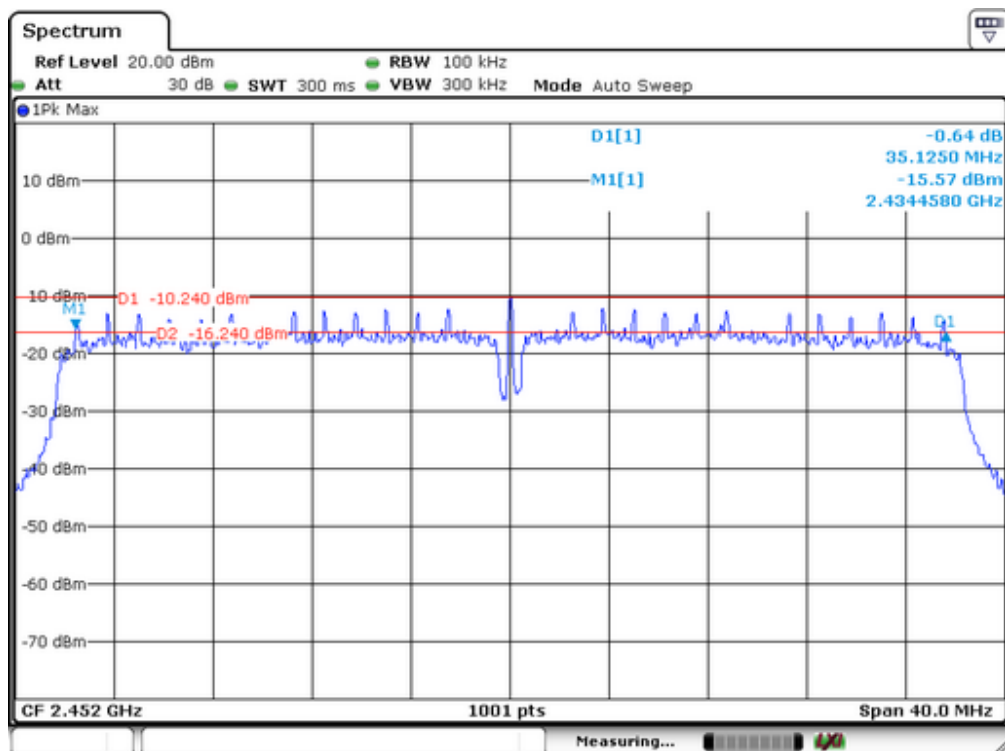
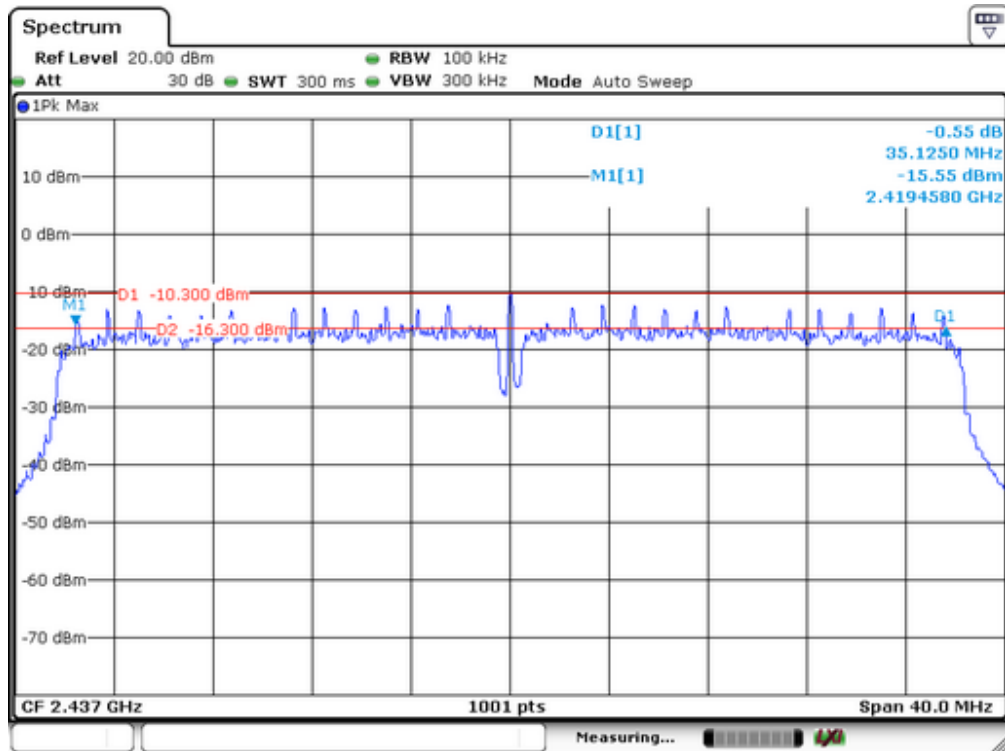

## 9. Maximum Peak Output Power Test

### 9.1 Measurement Procedure

1. The testing follows the Measurement Procedure of FCC KDB No. 558074 DTS D01 Meas. Guidance v03r02.
2. The RF output of EUT was connected to the power meter by RF cable and attenuator. The path loss was compensated to the results for each measurement.
3. Set to the maximum power setting and enable the EUT transmit continuously.
4. Measure the conducted output power and record the results in the test report.

### 9.2 Test SET-UP (Block Diagram of Configuration)



### 9.3 Measurement Equipment Used

EQUIPMENT TYPE	MODEL NUMBER	SERIAL NUMBER	LAST CAL.	CAL DUE.
Power meter	ML2495A	0824006	05/16/2014	05/15/2015
Power sensor	MA2411B	0738172	05/16/2014	05/15/2015

### 9.4 Peak Power output limit

The maximum peak power shall be less 1Watt.

### 9.5 Measurement Results

Spectrum Detector:	PK	Test Date :	May 05, 2015
Test By:	Andy	Temperature :	28
Test Result:	PASS	Humidity :	60%

Test Channel	Average Output Power (dBm)				Limit(dBm)	Result
	802.11b	802.11g	802.11n(HT20)	802.11n(HT40)		
Lowest	15.36	14.05	13.42	12.55	30	Pass
Middle	16.25	15.36	14.22	13.34		
Highest	17.49	16.48	15.47	14.05		

## 10. Band Edge Test

### 10.1 Measurement Procedure

#### For Conducted Test

1. The testing follows FCC KDB Publication No. 558074 D01 DTS Meas. Guidance v03r02.
2. The RF output of EUT was connected to the spectrum analyzer by RF cable and attenuator. The path loss was compensated to the results for each measurement.
3. Set to the maximum power setting and enable the EUT transmit continuously.
4. Set RBW = 100 kHz, VBW=300 kHz, Peak Detector. Unwanted Emissions measured in any 100 kHz bandwidth outside of the authorized frequency band shall be attenuated by at least 20 dB relative to the maximum in-band peak PSD level in 100 kHz when maximum peak conducted output power procedure is used. Measure and record the results in the test report.
5. The RF fundamental frequency should be excluded against the limit line in the operating frequency band.

#### For Radiated emission Test

1. The testing follows FCC KDB Publication No. 558074 D01 DTS Meas. Guidance v03r02.
2. The EUT was arranged to its worst case and then tune the antenna tower (from 1 m to 4 m) and turntable (from 0 degree to 360 degrees) to find the maximum reading. A pre-amp and a high pass filter are used for the test in order to get better signal level.
3. The EUT was placed on a turntable with 0.8 meter above ground.
4. The EUT was set 3 meters from the interference receiving antenna, which was mounted on the top of a variable height antenna tower.
5. Corrected Reading: Antenna Factor + Cable Loss + Read Level - Preamp Factor = Level.
6. For measurement below 1GHz, If the emission level of the EUT measured by the peak detector is 3 dB lower than the applicable limit, the peak emission level will be reported. Otherwise, the emission measurement will be repeated using the quasi-peak detector and reported.
7. Repeat above procedures until all frequency measured were complete.

When spectrum scanned above 1GHz setting resolution bandwidth 1MHz, video bandwidth 3MHz.

EMI Test Receiver	Setting
Attenuation	Auto
RB	1MHz
VB	3MHz
Detector	Peak
Trace	Max hold

When spectrum scanned above 1GHz setting resolution bandwidth 1MHz, video bandwidth 10Hz.

EMI Test Receiver	Setting
Attenuation	Auto
RB	1MHz
VB	10Hz
Detector	AVG
Trace	Max hold

### 10.2 Test SET-UP (Block Diagram of Configuration)

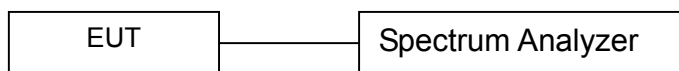

### 10.3 Measurement Equipment Used

EQUIPMENT TYPE	MFR	MODEL NUMBER	SERIAL NUMBER	LAST CAL.	CAL DUE.
Spectrum Analyzer	Rohde & Schwarz	FSV30	1321.3008K	05/16/2014	05/15/2015
Coaxial Cable	CDS	79254	46107086	05/16/2014	05/15/2015

### 10.4 Measurement Results

#### 1. Conducted Test

Please refer to the following pages.

Test mode: 802.11b

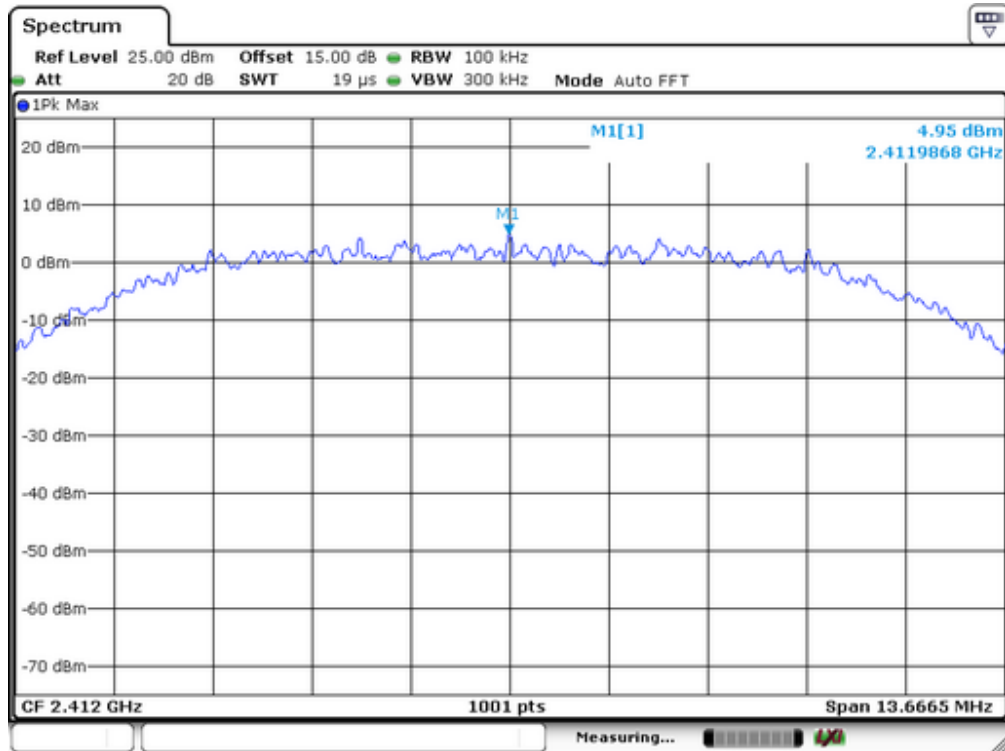

Lowest Channel

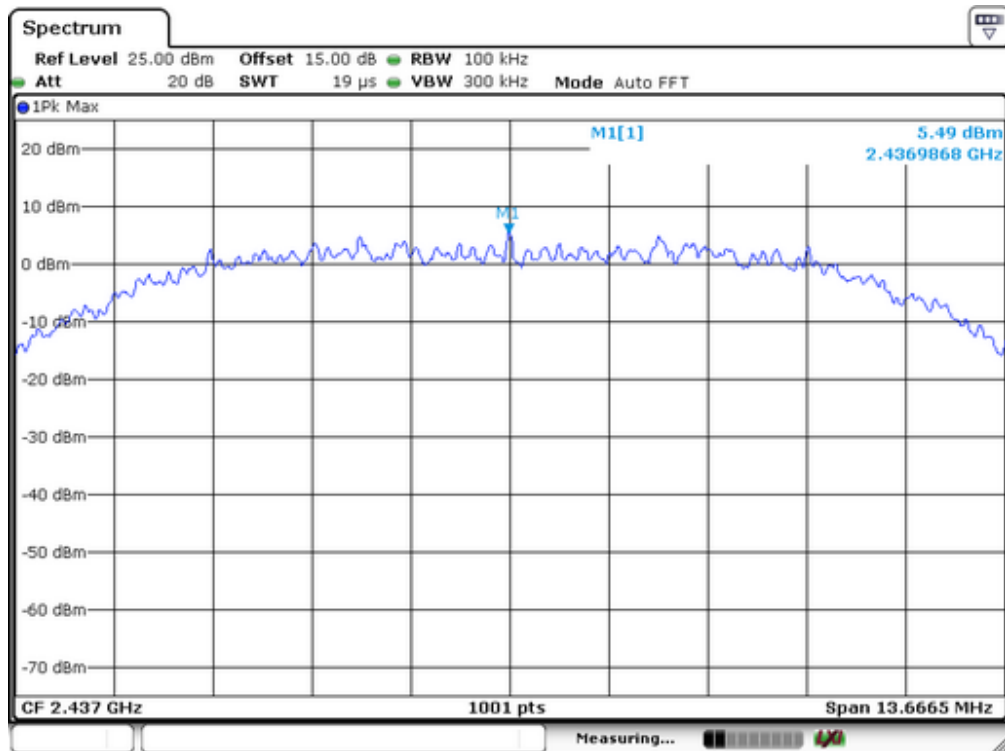

Middle Channel

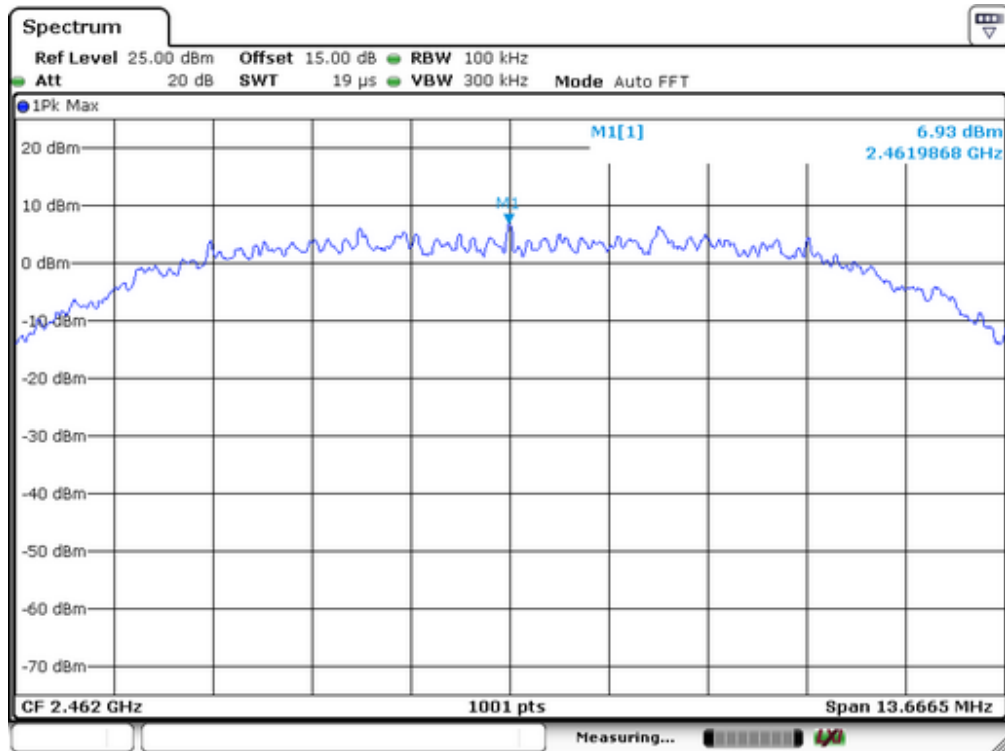

Highest Channel

Test mode: 802.11g

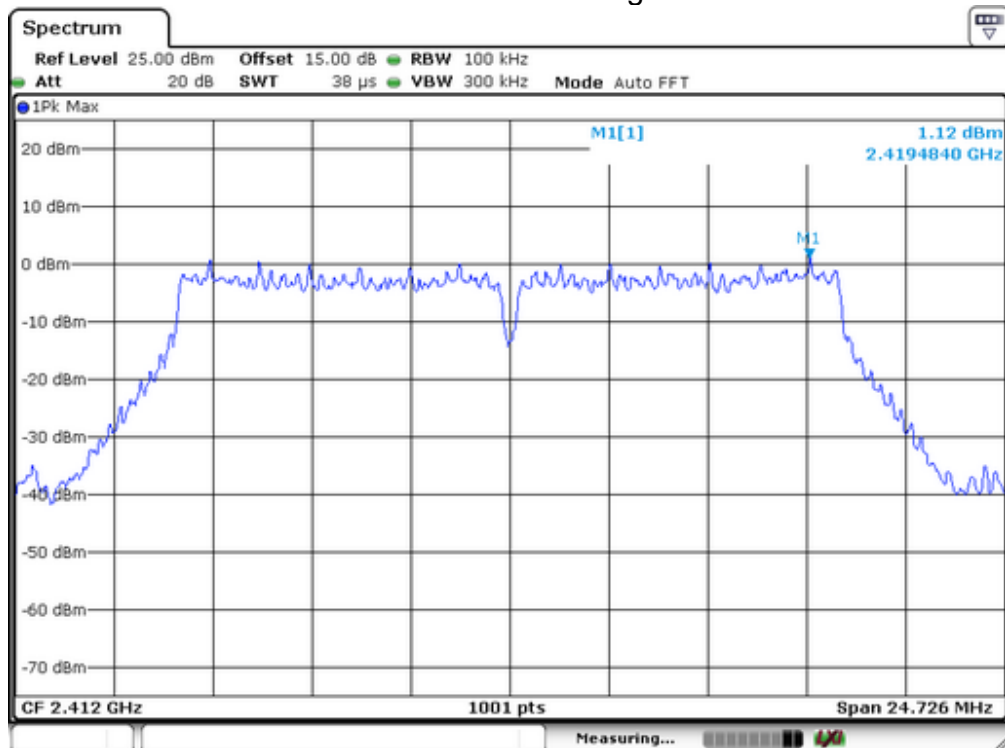

Lowest Channel



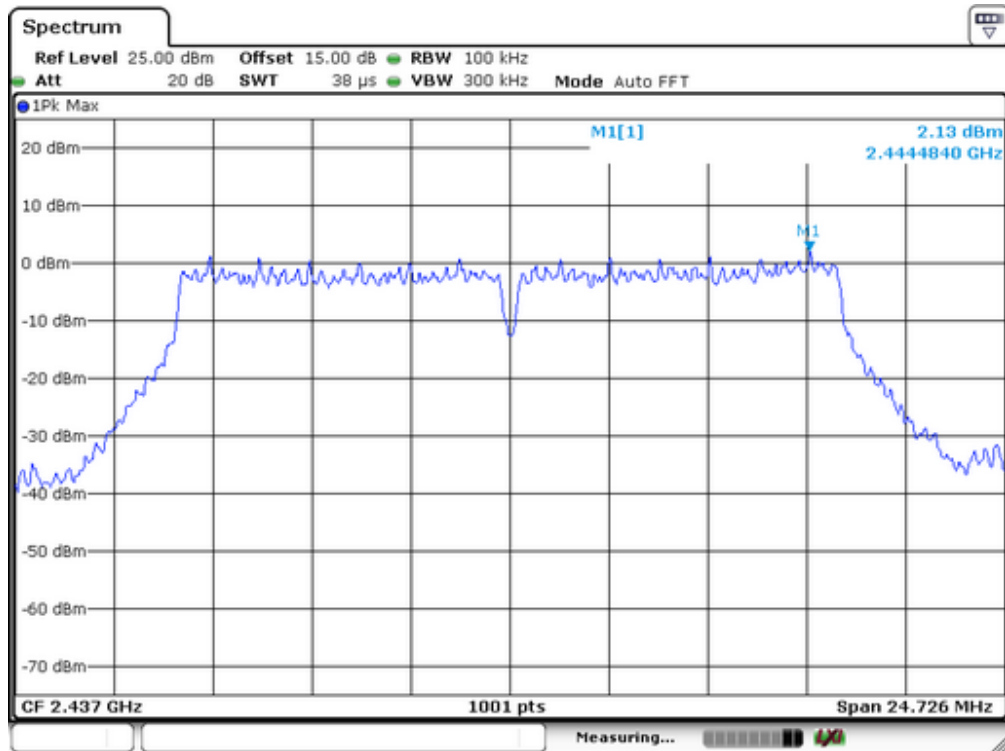

Middle Channel

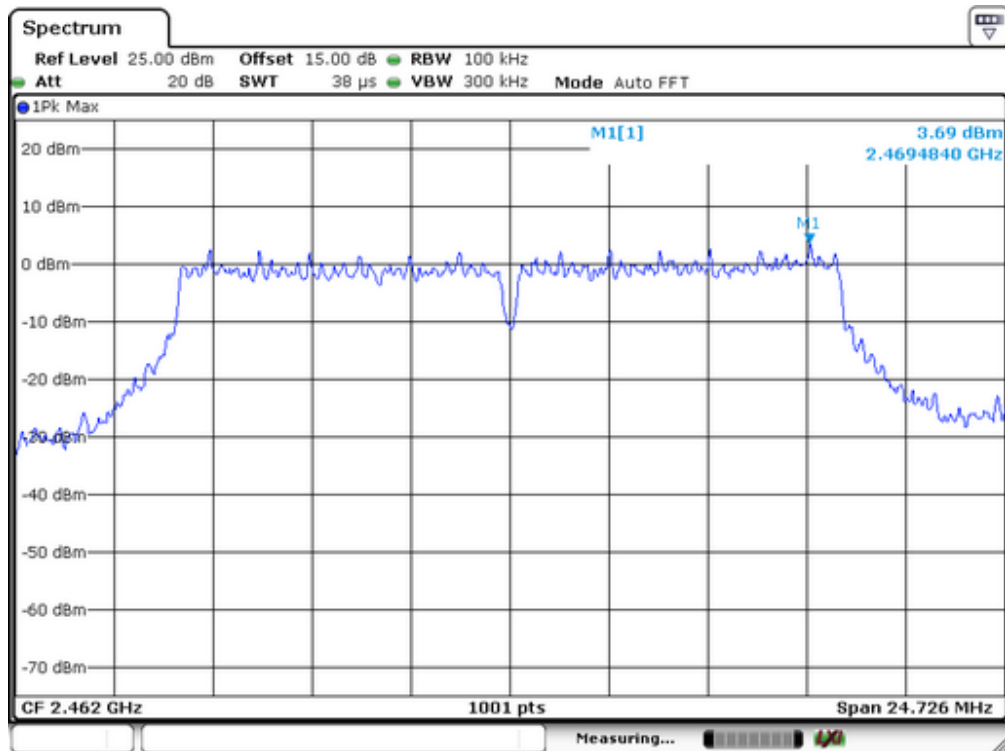

Highest Channel

Test mode: 802.11n(HT20)

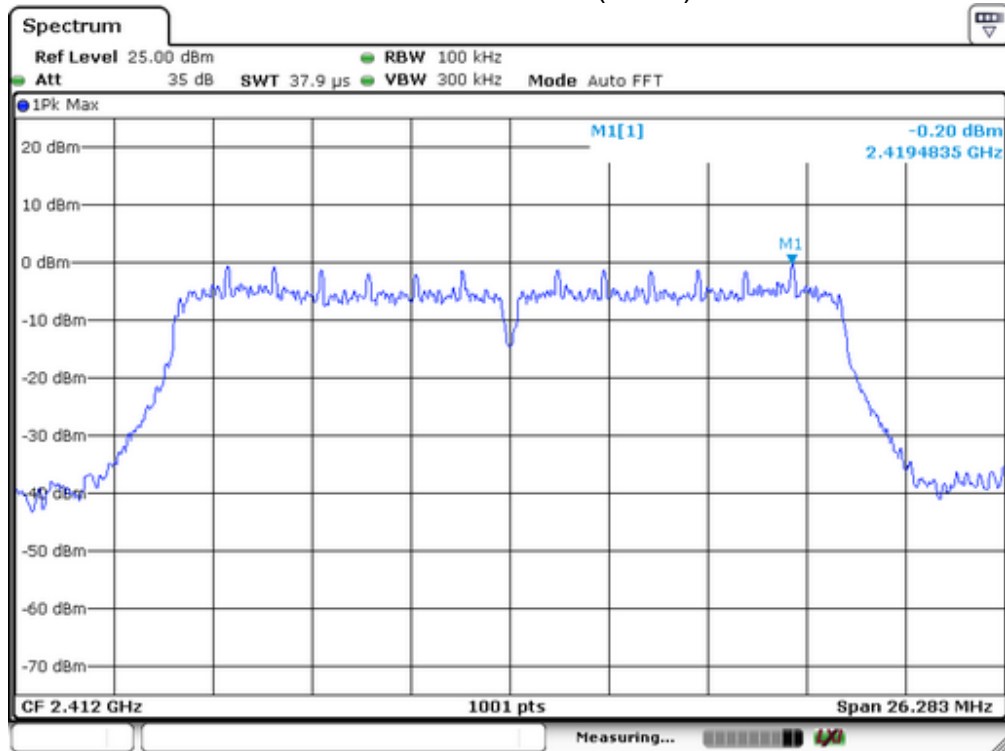

Lowest Channel

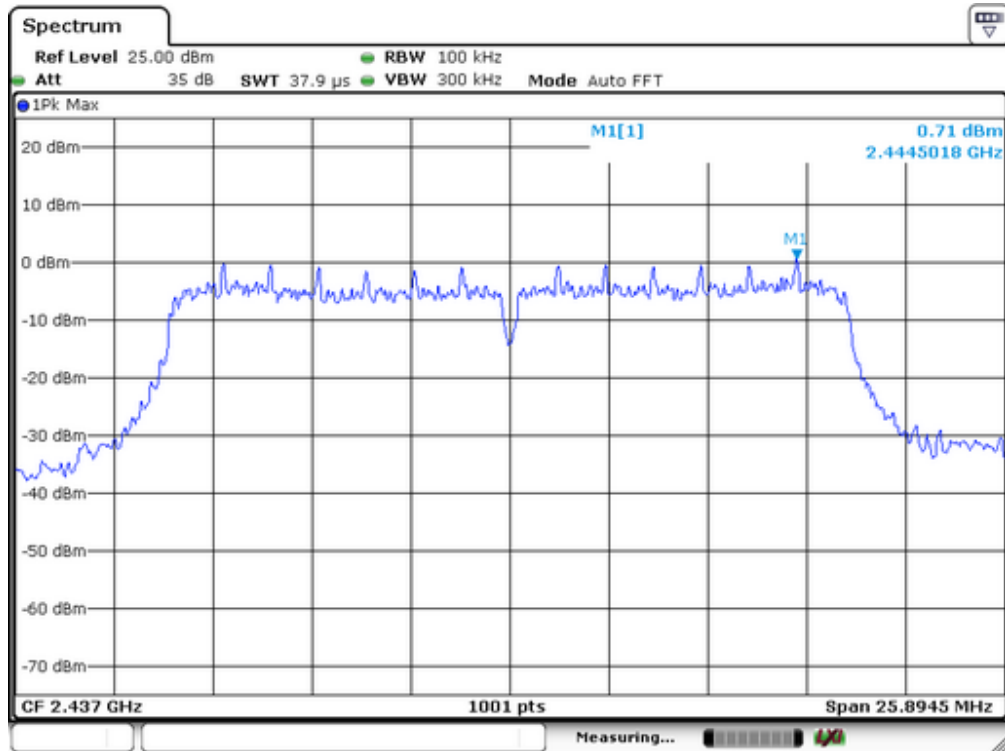

Middle Channel

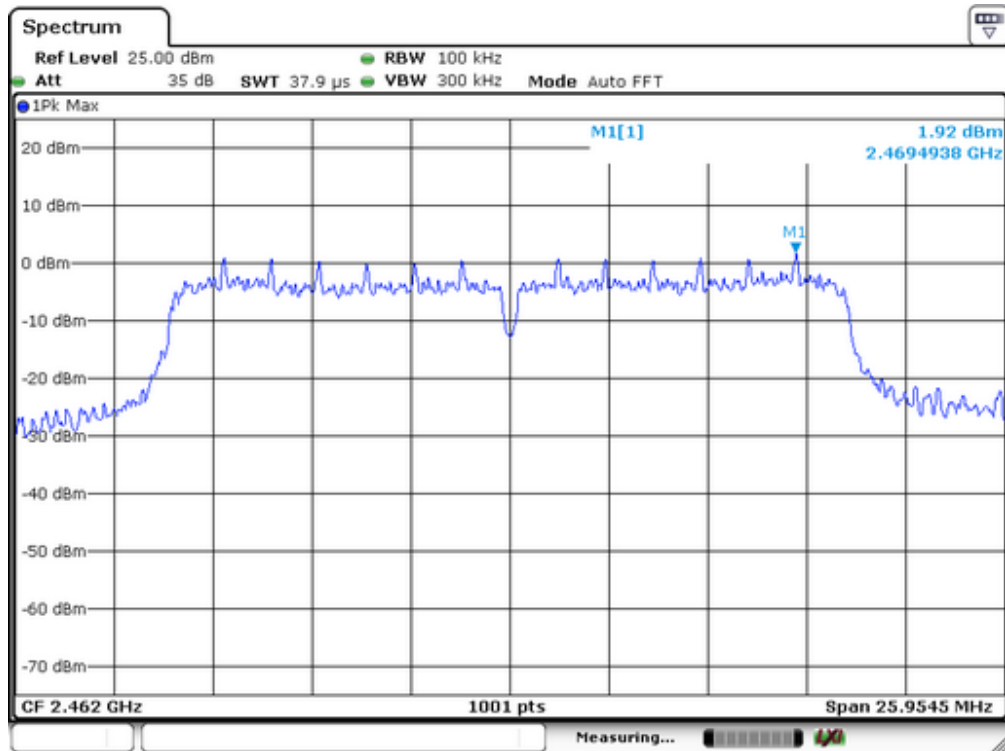

Highest Channel

Test mode: 802.11n(HT40)

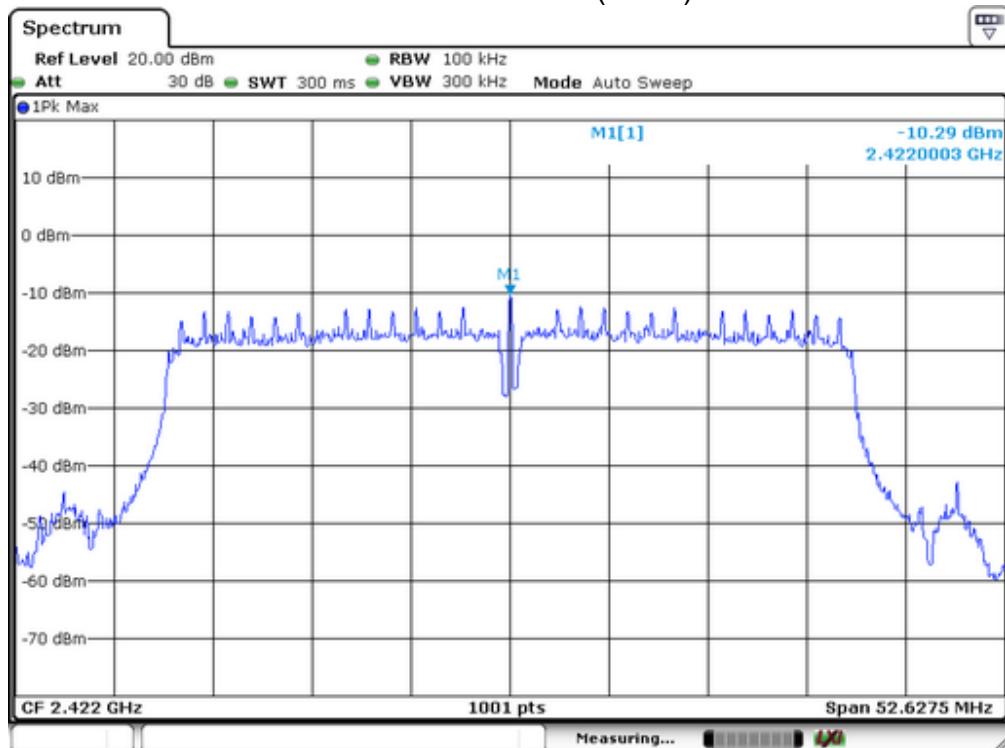

Lowest Channel

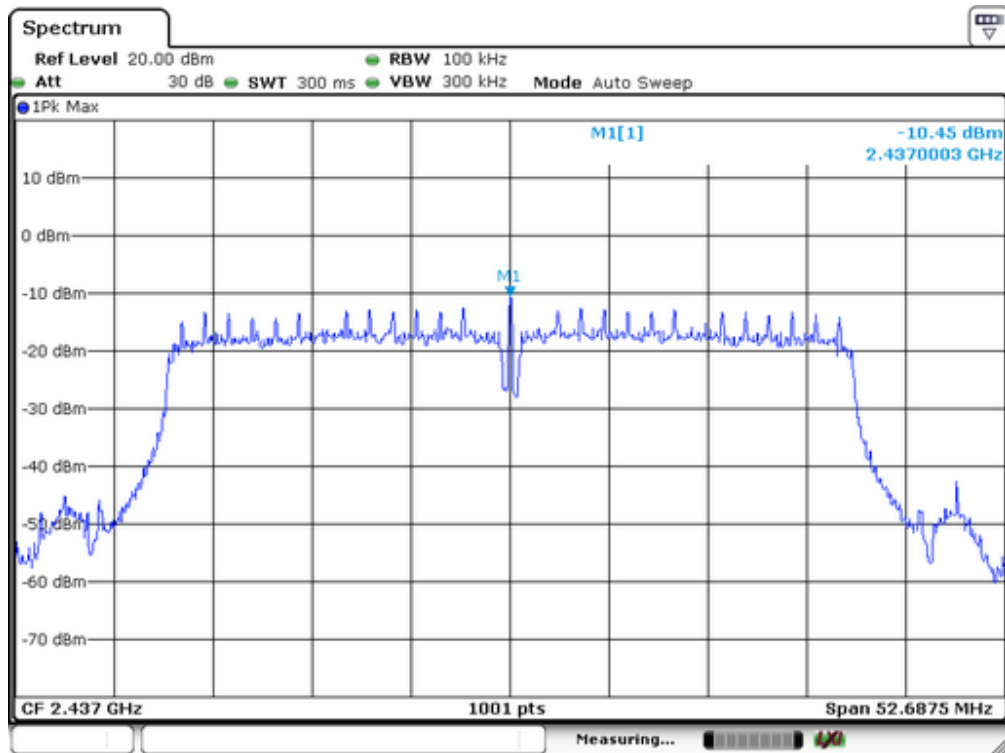

Middle Channel

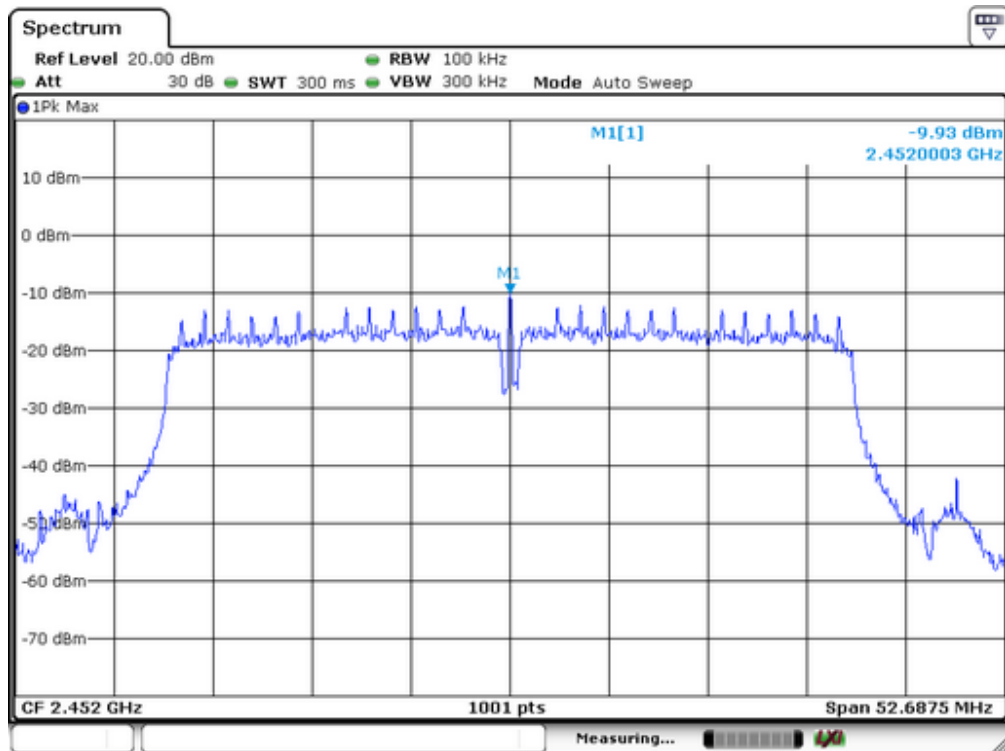

Highest Channel

Test mode: 802.11b

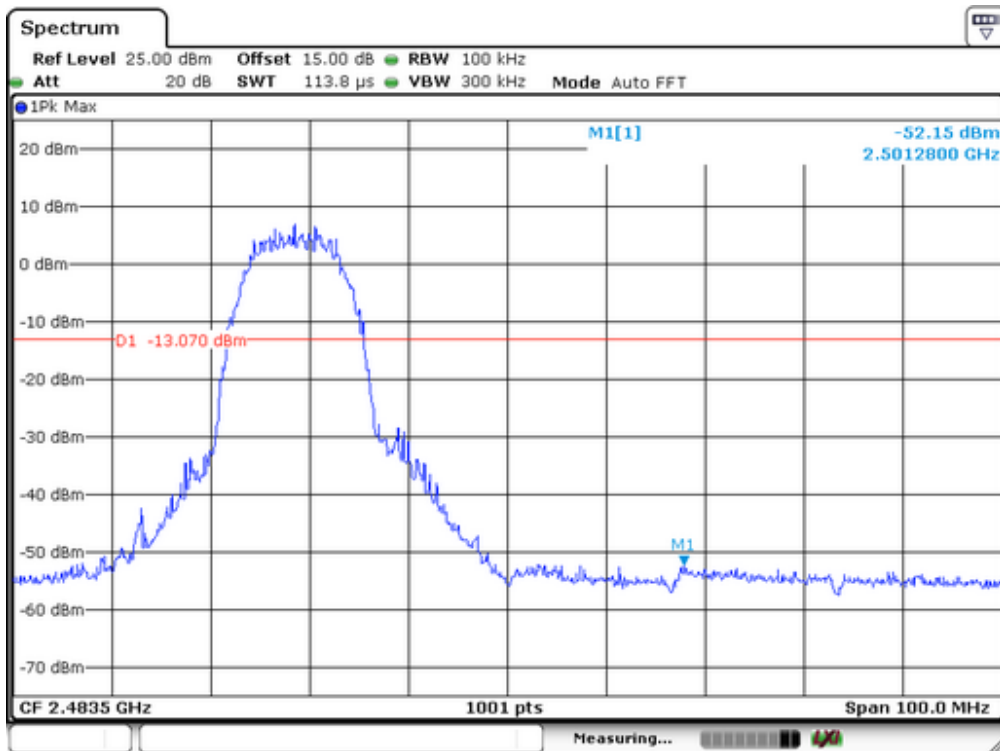
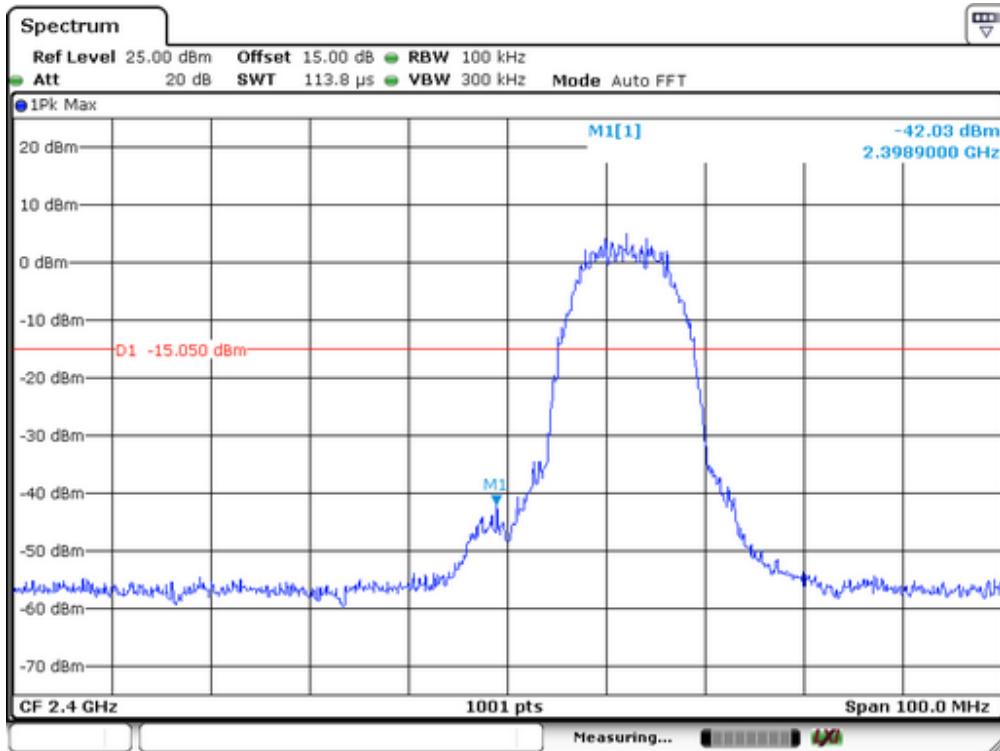

Test mode: 802.11g

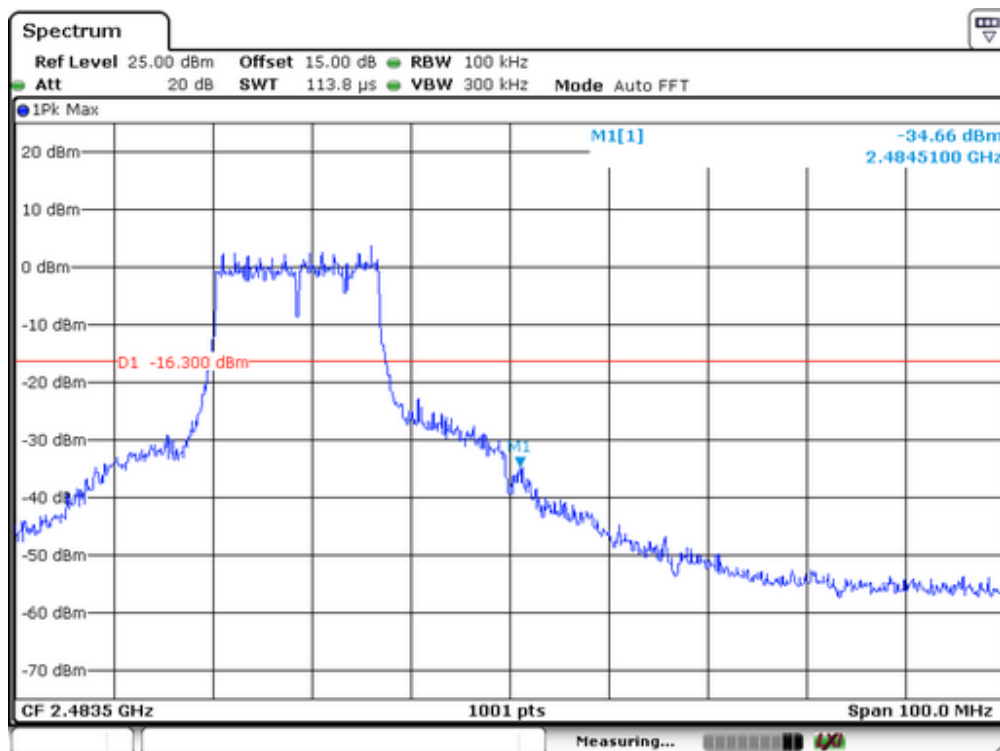
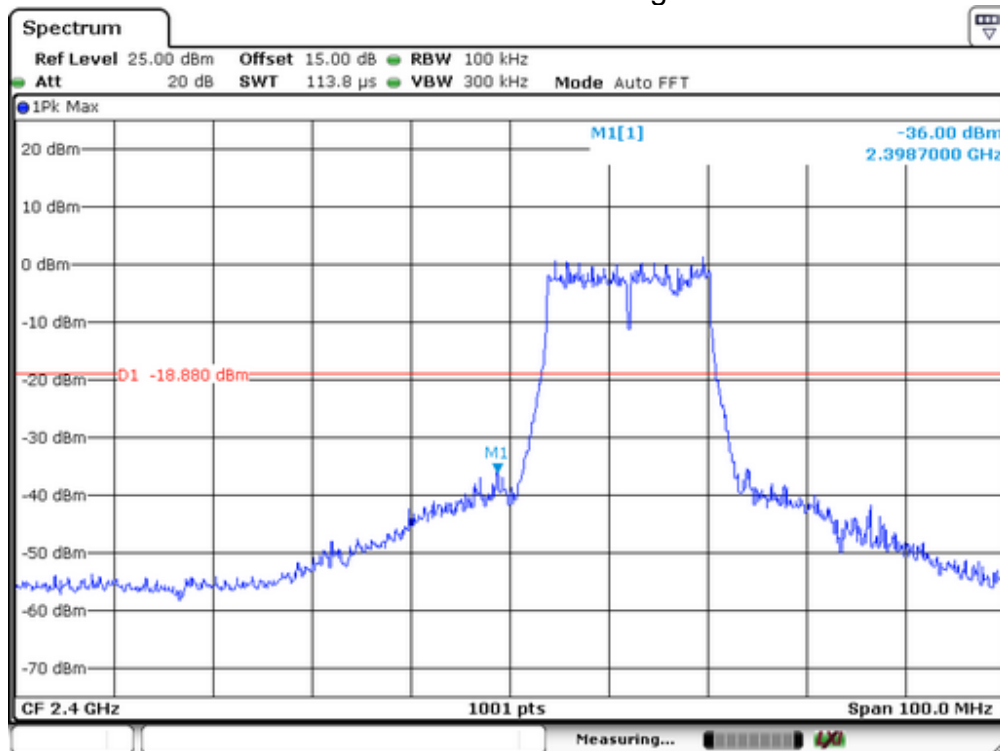

Test mode: 802.11n(HT20)

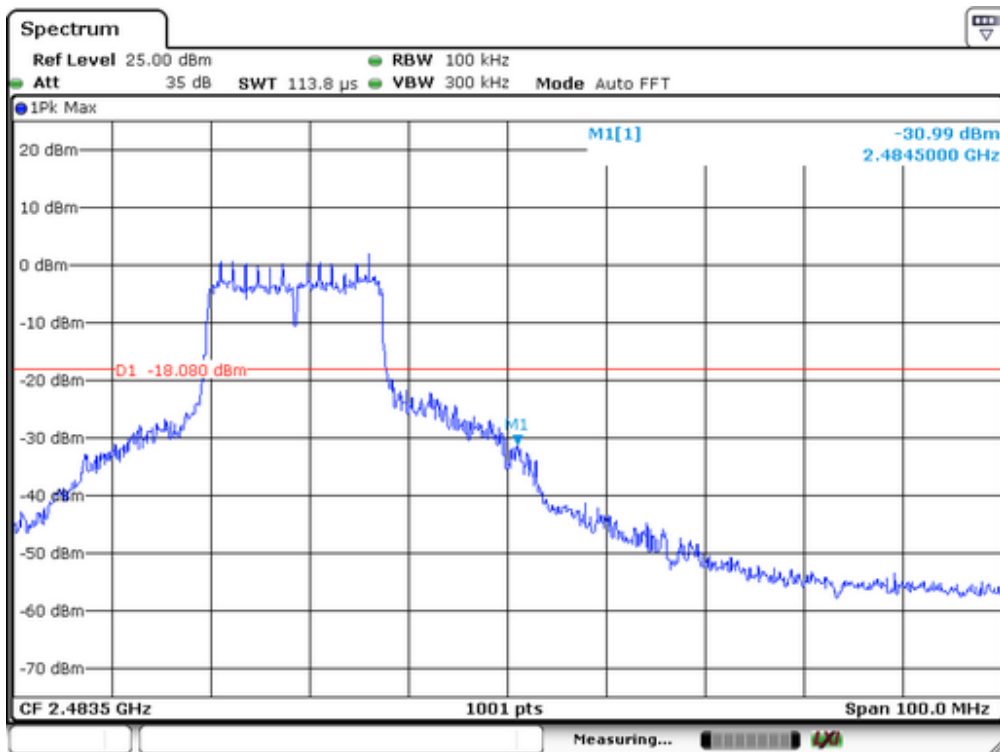
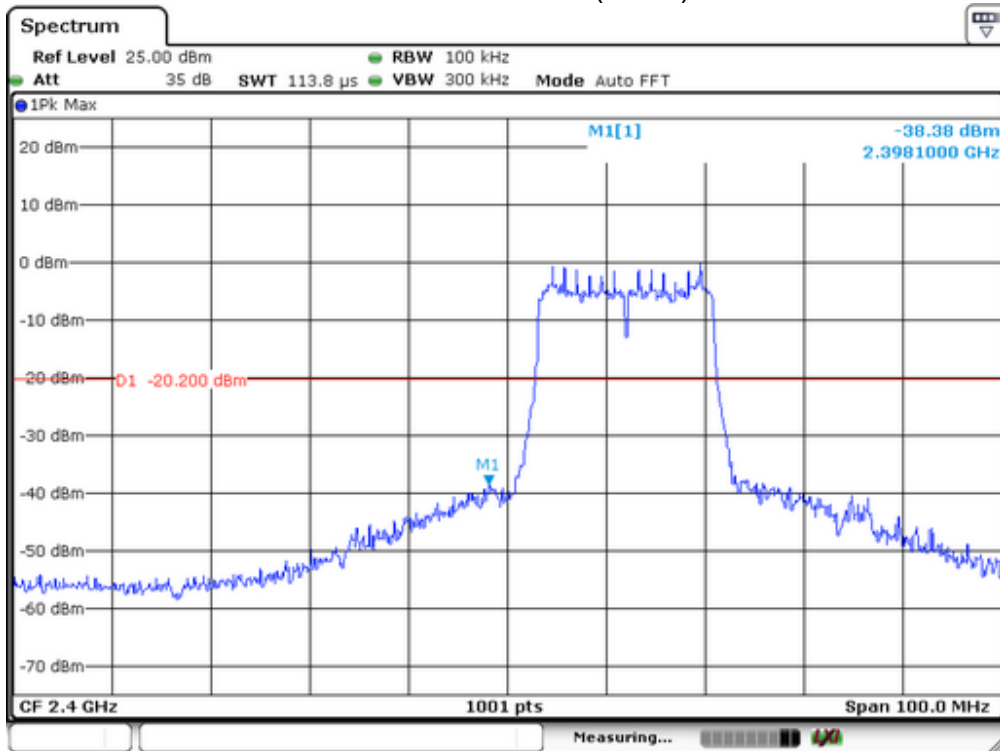

Test mode: 802.11n(HT40)

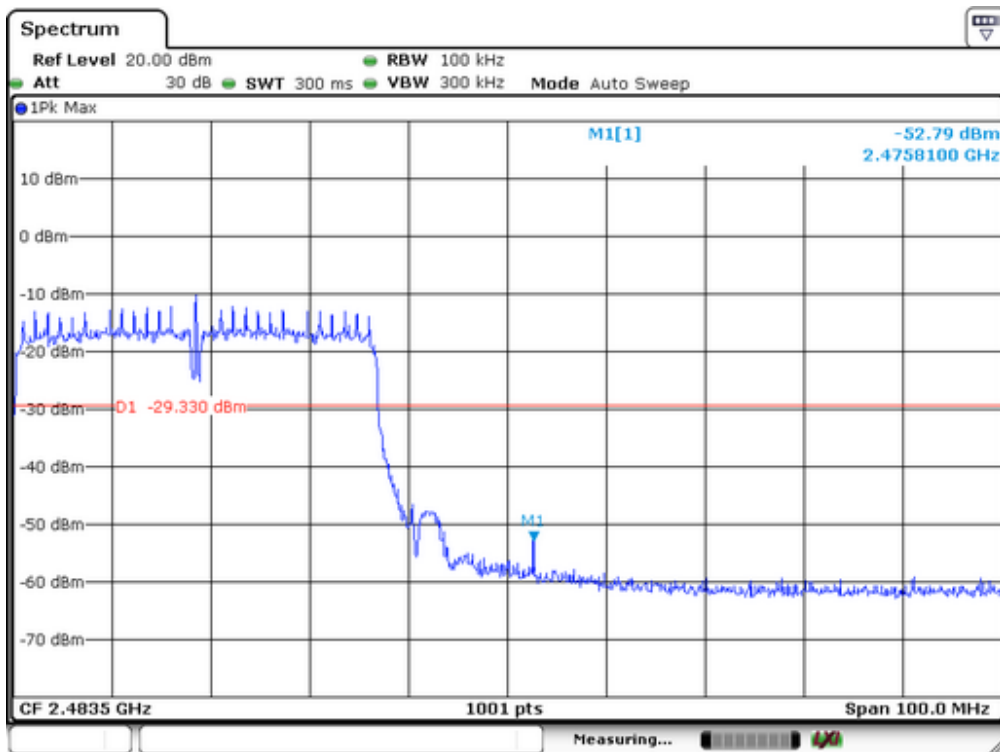
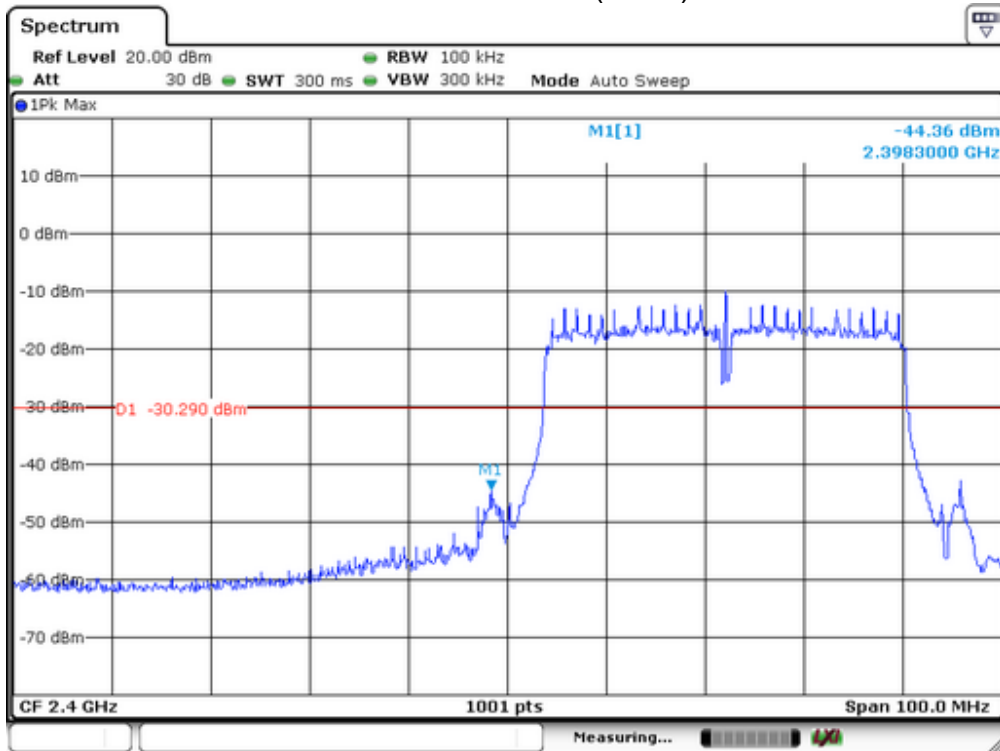



2. Radiated emission Test

Spectrum Detector: PK/AV      Test Date : May 05, 2015  
 Test By: Andy      Temperature : 28  
 Humidity : 65 %

IEEE 802.11b							
Frequency (MHz)	Antenna polarization	Emission (dBuV/m)		Band edge Limit (dBuV/m)		Margin (dB)	
	(H/V)	PK	AV	PK	AV	PK	AV
<2400	H	65.03	44.13	74	54	-8.97	-9.87
<2400	V	60.42	39.42	74	54	-13.58	-14.58
>2483.5	H	64.82	42.71	74	54	-9.18	-11.29
>2483.5	V	59.72	37.04	74	54	-14.28	-16.96

IEEE 802.11g							
Frequency (MHz)	Antenna polarization	Emission (dBuV/m)		Band edge Limit (dBuV/m)		Margin (dB)	
	(H/V)	PK	AV	PK	AV	PK	AV
<2400	H	66.02	44.42	74	54	-7.98	-9.58
<2400	V	60.32	40.36	74	54	-13.68	-13.64
>2483.5	H	65.75	46.82	74	54	-8.25	-7.18
>2483.5	V	61.74	39.15	74	54	-12.26	-14.85

IEEE 802.11n(HT20)							
Frequency (MHz)	Antenna polarization	Emission (dBuV/m)		Band edge Limit (dBuV/m)		Margin (dB)	
	(H/V)	PK	AV	PK	AV	PK	AV
<2400	H	64.13	45.18	74	54	-9.87	-8.82
<2400	V	60.25	40.34	74	54	-13.75	-13.66
>2483.5	H	65.71	44.15	74	54	-8.29	-9.85
>2483.5	V	59.36	39.28	74	54	-14.64	-14.72

IEEE 802.11n(HT40)							
Frequency (MHz)	Antenna polarization	Emission (dBuV/m)		Band edge Limit (dBuV/m)		Margin (dB)	
	(H/V)	PK	AV	PK	AV	PK	AV
<2400	H	63.13	45.05	74	54	-10.87	-8.95
<2400	V	57.45	40.32	74	54	-16.55	-13.68
>2483.5	H	64.18	46.18	74	54	-9.82	-7.82
>2483.5	V	60.35	39.42	74	54	-13.65	-14.58

## 11. Power Density

### 11.1 Test Equipment

EQUIPMENT TYPE	MFR	MODEL NUMBER	SERIAL NUMBER	LAST CAL.	CAL DUE.
Spectrum Analyzer	Rohde & Schwarz	FSV30	1321.3008K	05/16/2014	05/15/2015
Coaxial Cable	CDS	79254	46107086	05/16/2014	05/15/2015

### 11.2 Measuring Instruments and Setting

The following table is the setting of spectrum analyzer.

Spectrum analyzer	Setting
Attenuation	Auto
Span Frequency	Set the span to 1.5 times the DTS bandwidth.
RB	3kHz
VB	10KHz
Detector	Peak
Trace	Max hold
Sweep Time	Automatic

### 11.3 Test Procedures

- The transmitter output (antenna port) was connected to the spectrum analyzer.
- Set analyzer center frequency to DTS channel center frequency.
- Set the analyzer span to a minimum of 1.5 times the DTS bandwidth.
- Set the RBW  $\geq 3$  kHz. Set the VBW  $\geq 3 \times$  RBW.
- Detector = peak.
- Sweep time = auto couple.
- Trace mode = max hold.
- Allow trace to fully stabilize.
- Use the peak marker function to determine the maximum amplitude level.

### 11.4 Block Diagram of Test Setup

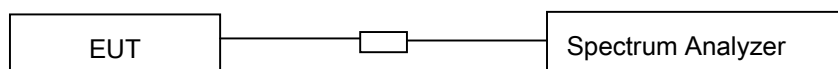

### 11.5 Limit

The transmitted power density averaged over any 1 second interval shall not be greater +8dBm in any 3 kHz bandwidth.

**11.6 Test Result**

Spectrum Detector:	PK	Test Date :	May 05, 2015
Test By:	Andy	Temperature :	28
Test Result:	PASS	Humidity :	60%

IEEE 802.11b			
Channel frequency (MHz)	Measurement level (dBm)	Limit(dBm)	Result
2412	-10.06	8	Pass
2437	-9.43		
2462	-7.95		

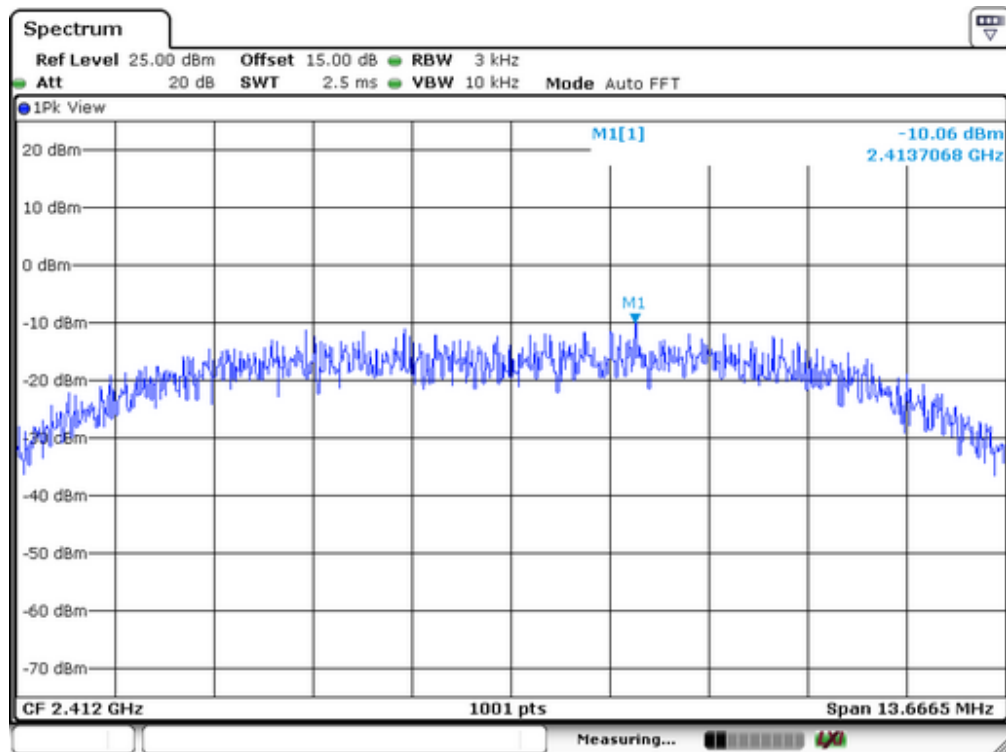

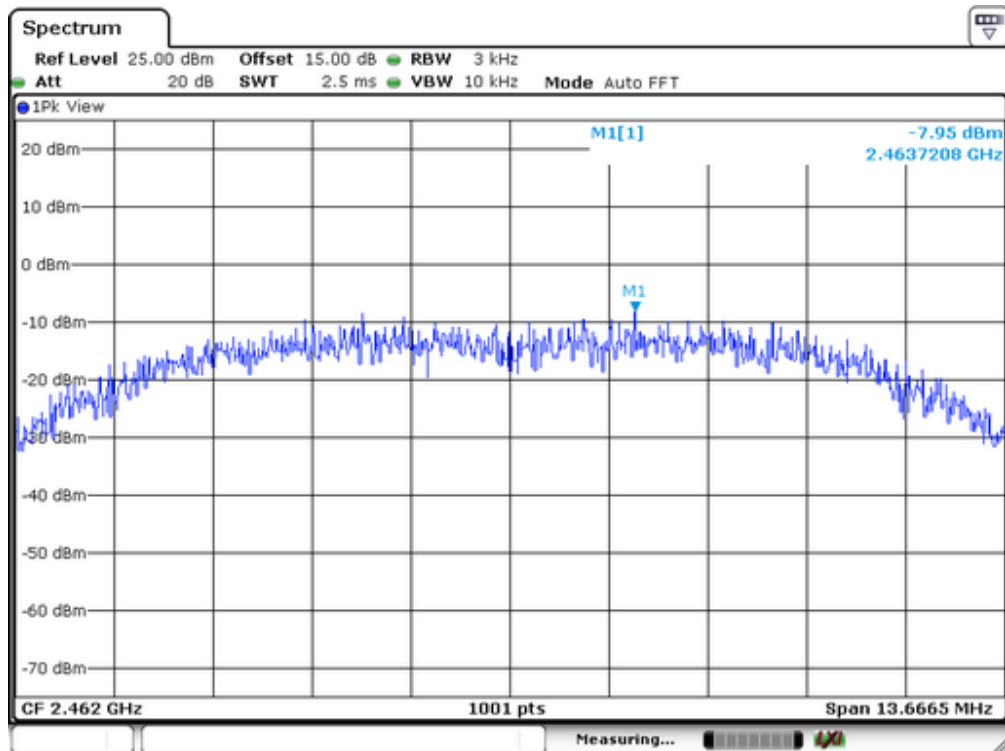
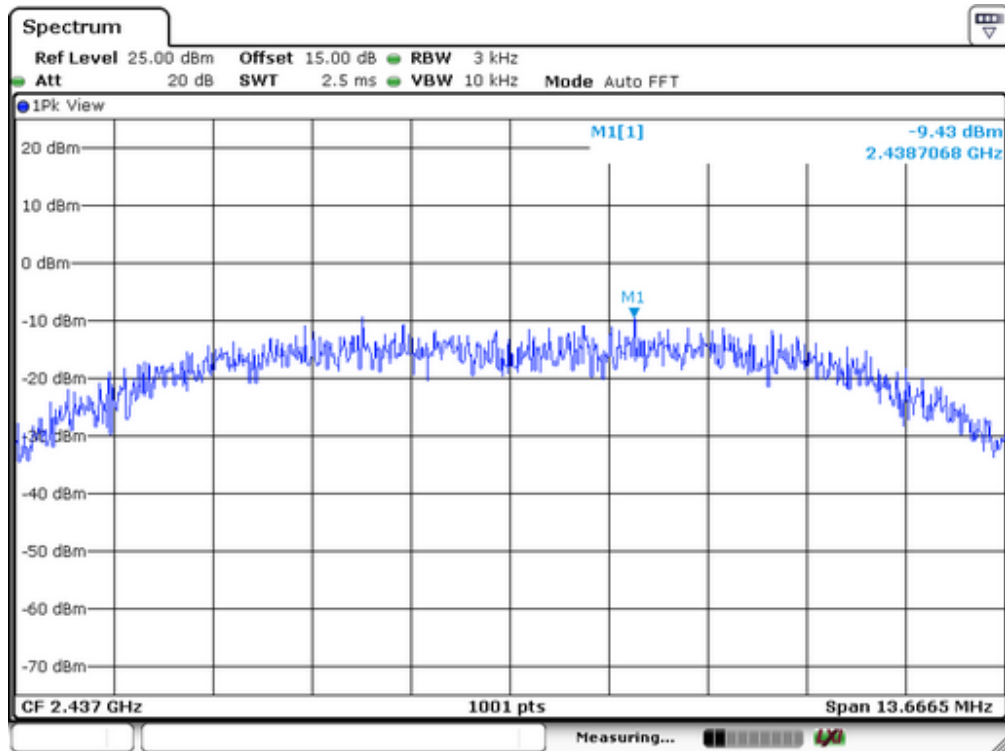

IEEE 802.11g			
Channel frequency (MHz)	Measurement level (dBm)	Limit(dBm)	Result
2412	-13.81	8	Pass
2437	-12.84		
2462	-11.35		

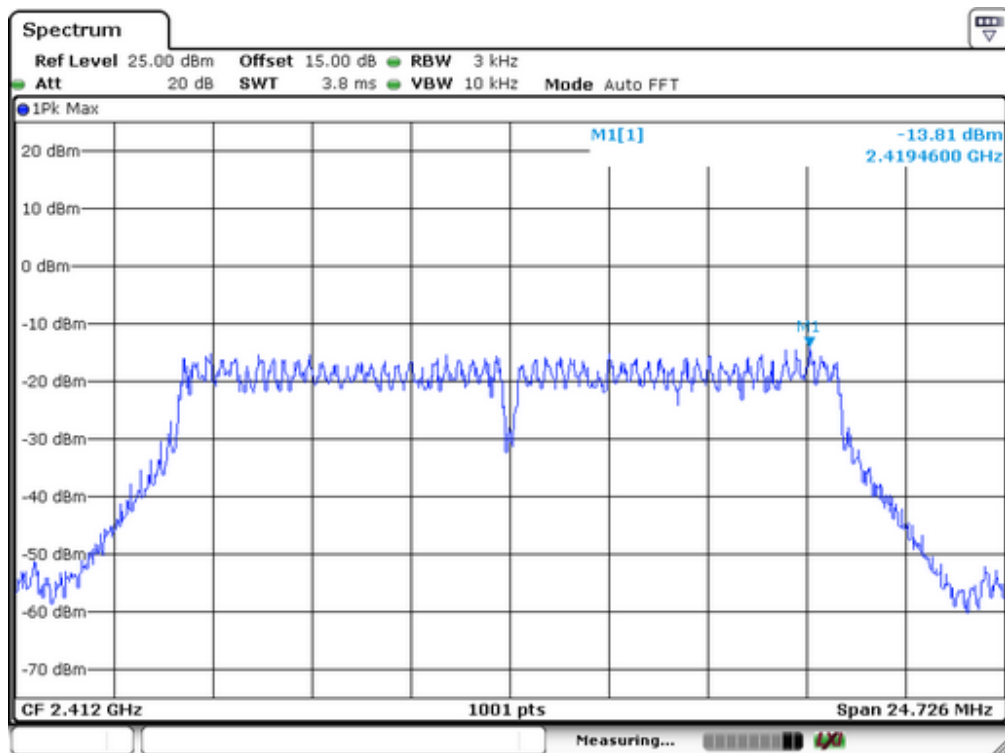

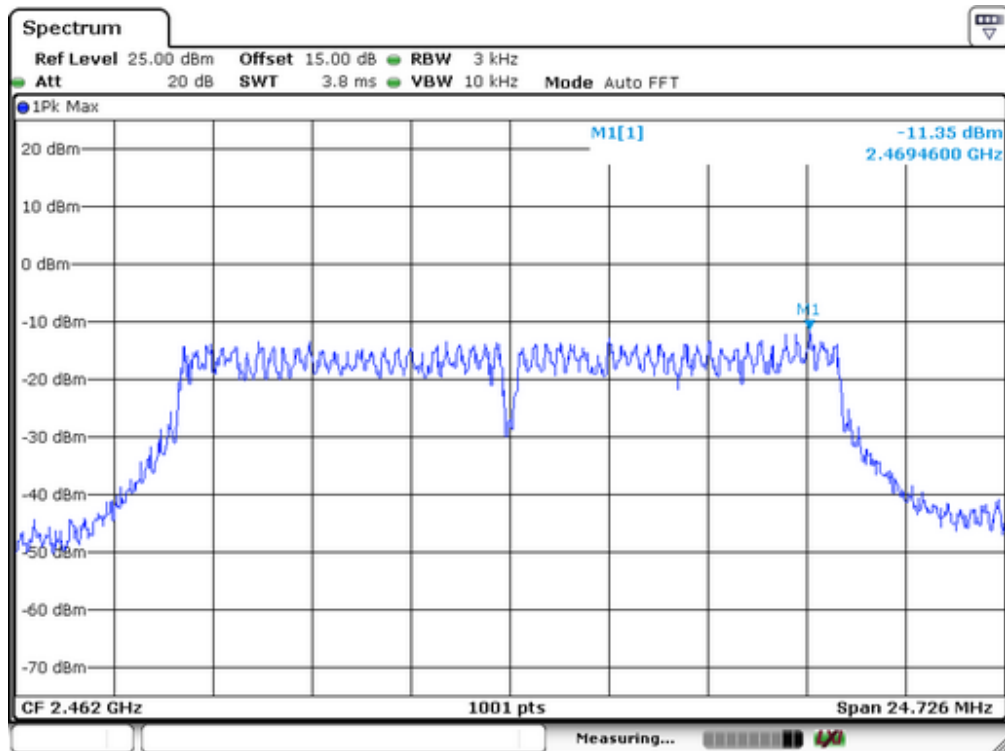
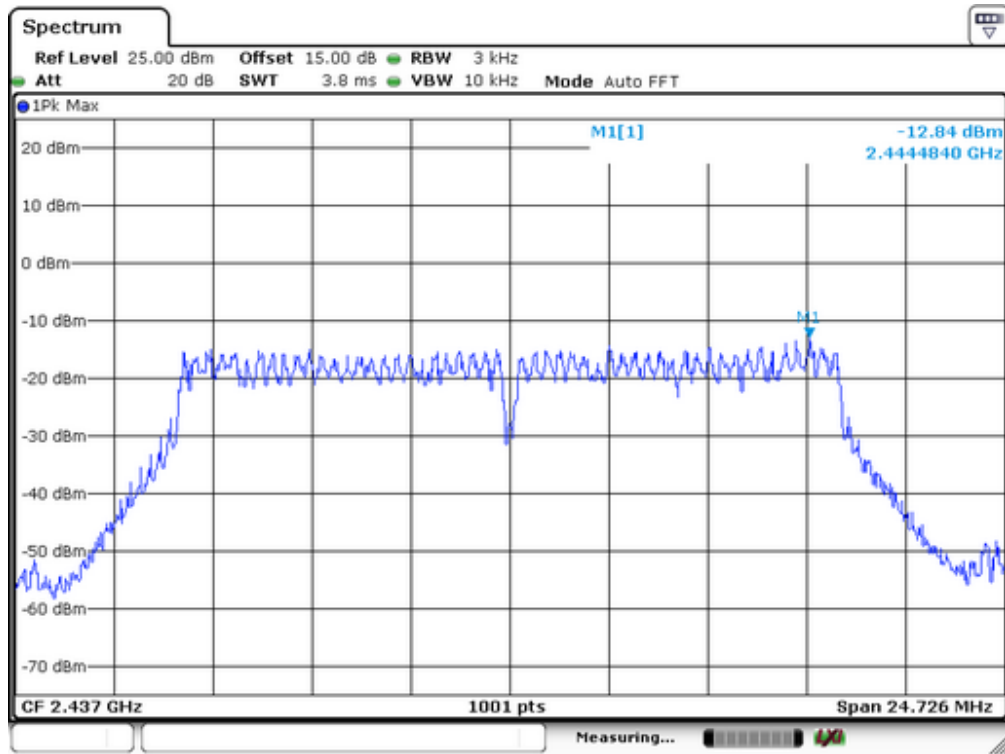

IEEE 802.11n(HT20)			
Channel frequency (MHz)	Measurement level (dBm)	Limit(dBm)	Result
2412	-15.33	8	Pass
2437	-14.29		
2462	-13.65		

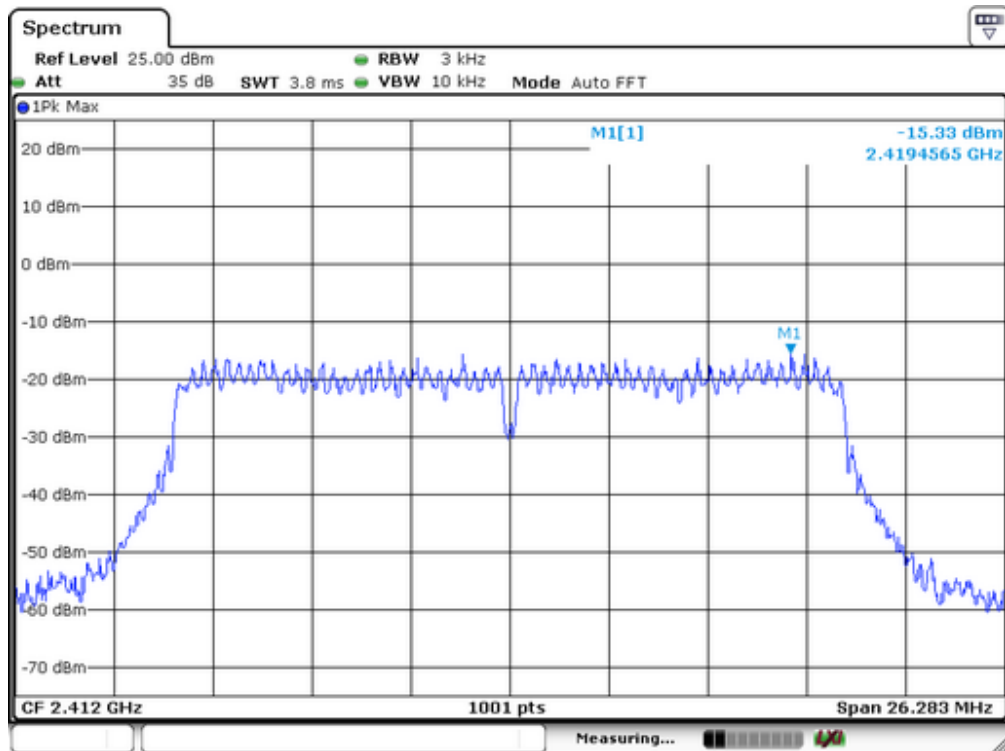

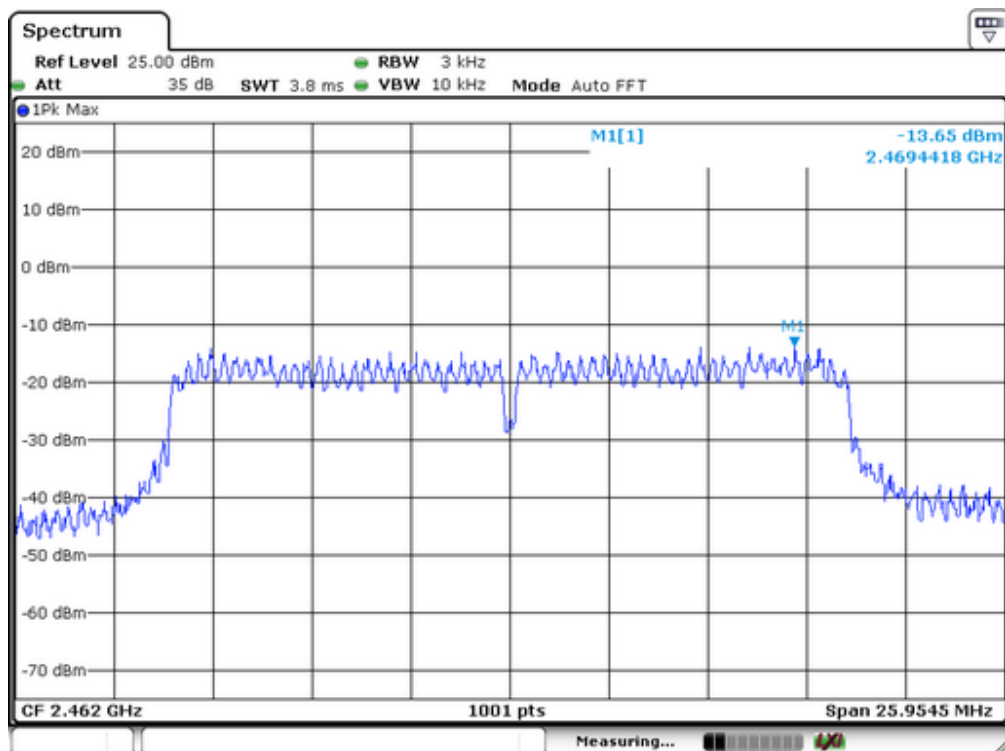
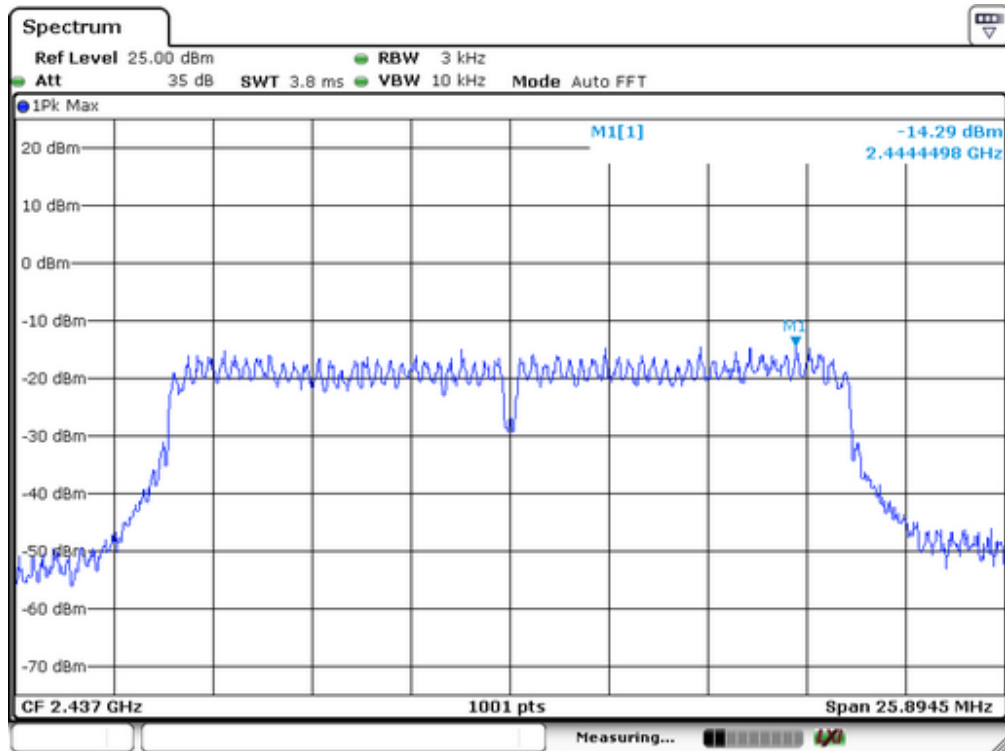



IEEE 802.11n(HT40)			
Channel frequency (MHz)	Measurement level (dBm)	Limit(dBm)	Result
2422	-11.43	8	Pass
2437	-11.31		
2452	-11.23		

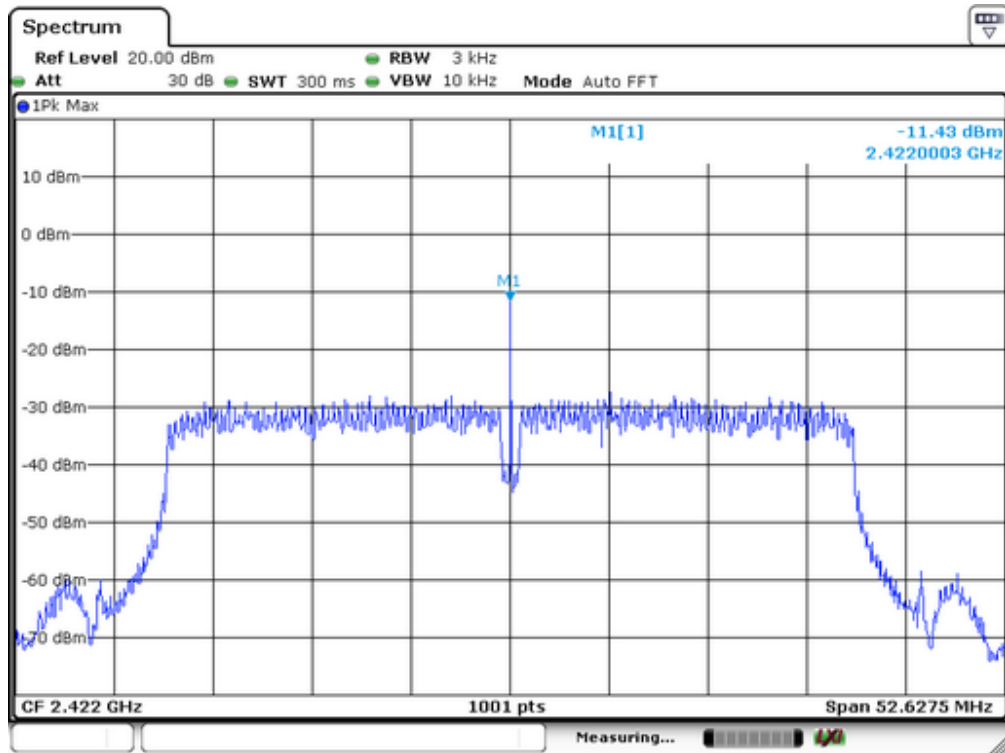

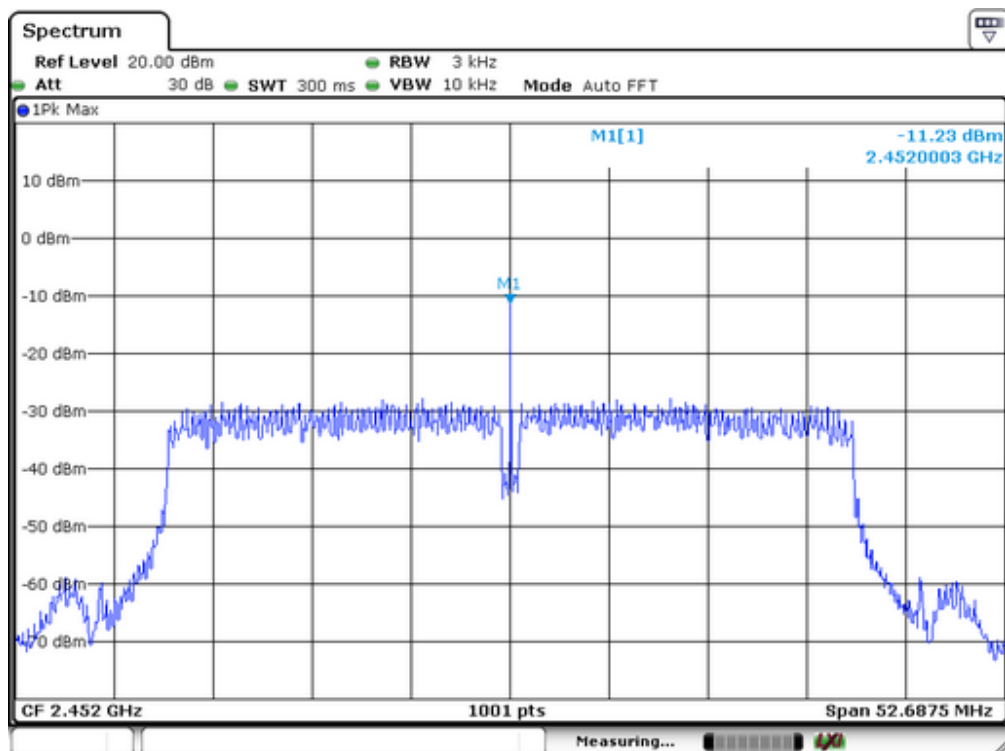
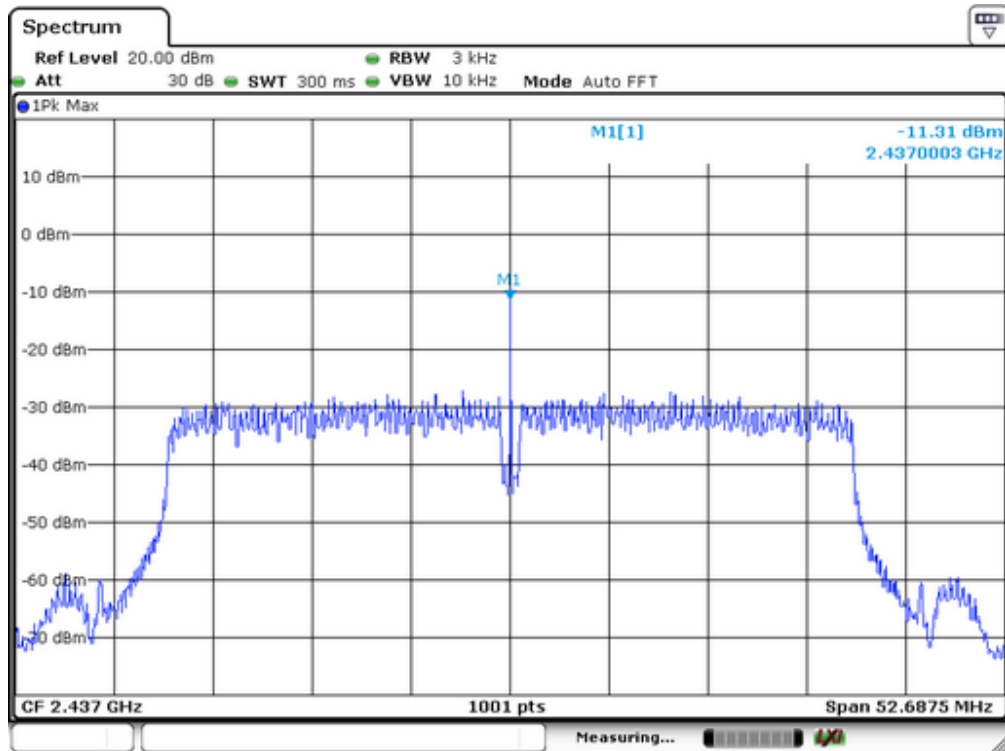

## 12. Antenna Port Emission

### 12.1 Test Equipment

EQUIPMENT TYPE	MFR	MODEL NUMBER	SERIAL NUMBER	LAST CAL.	CAL DUE.
Spectrum Analyzer	Rohde & Schwarz	FSV30	1321.3008K	05/16/2014	05/15/2015
Coaxial Cable	CDS	79254	46107086	05/16/2014	05/15/2015

### 12.2 Measuring Instruments and Setting

The following table is the setting of spectrum analyzer.

Spectrum analyzer	Setting
Attenuation	Auto
RB	100kHz
VB	300kHz
Detector	Peak
Trace	Max hold

### 12.3 Test Procedures

The conducted spurious emissions were measured conducted using a spectrum analyzer at low, Middle, and high channels, the limit was determined by attenuation 20dB of the RF peak power output.

### 12.4 Block Diagram of Test setup

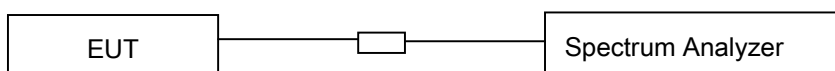

### 12.5 Test Result

**PASS.**

Test Mode: 802.11b

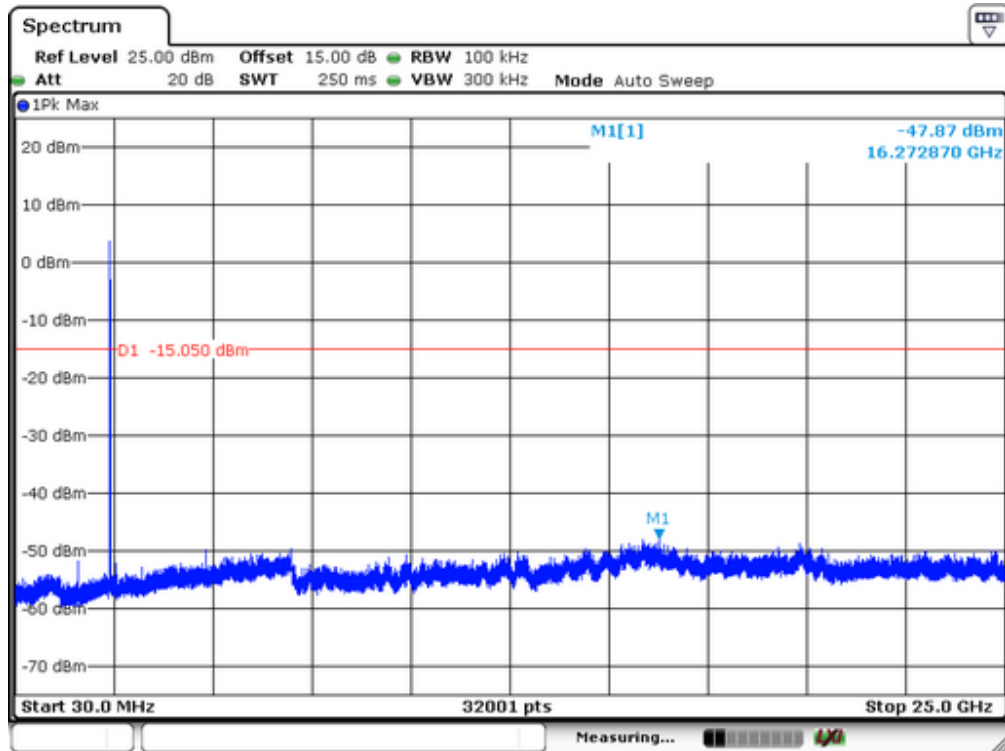

Lowest Channel

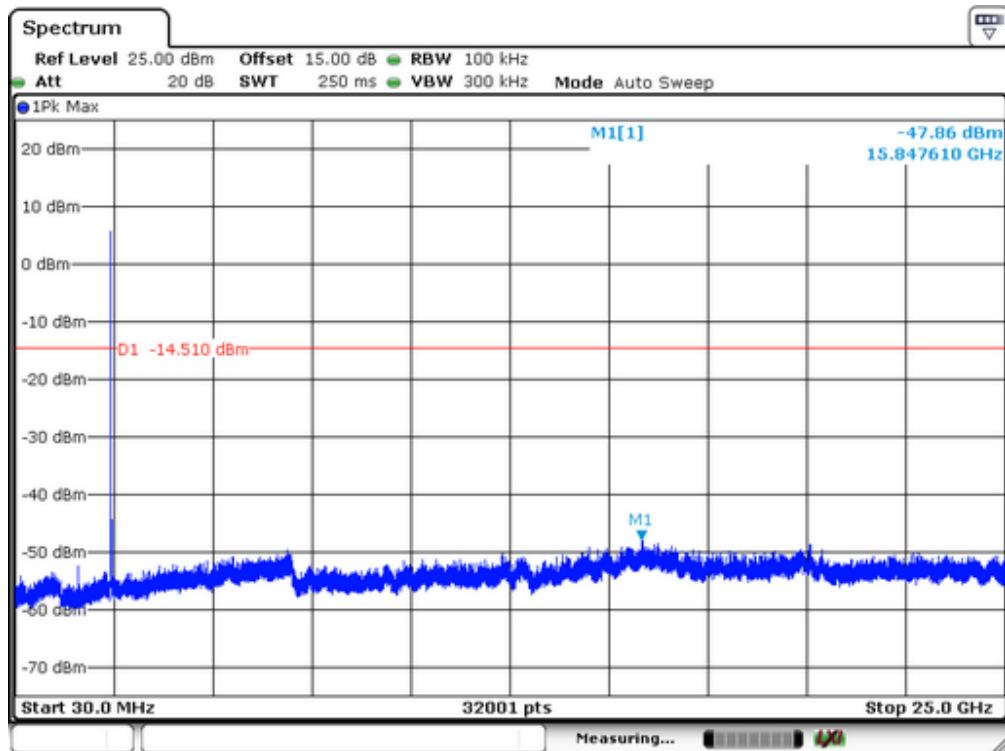

Middel Channel

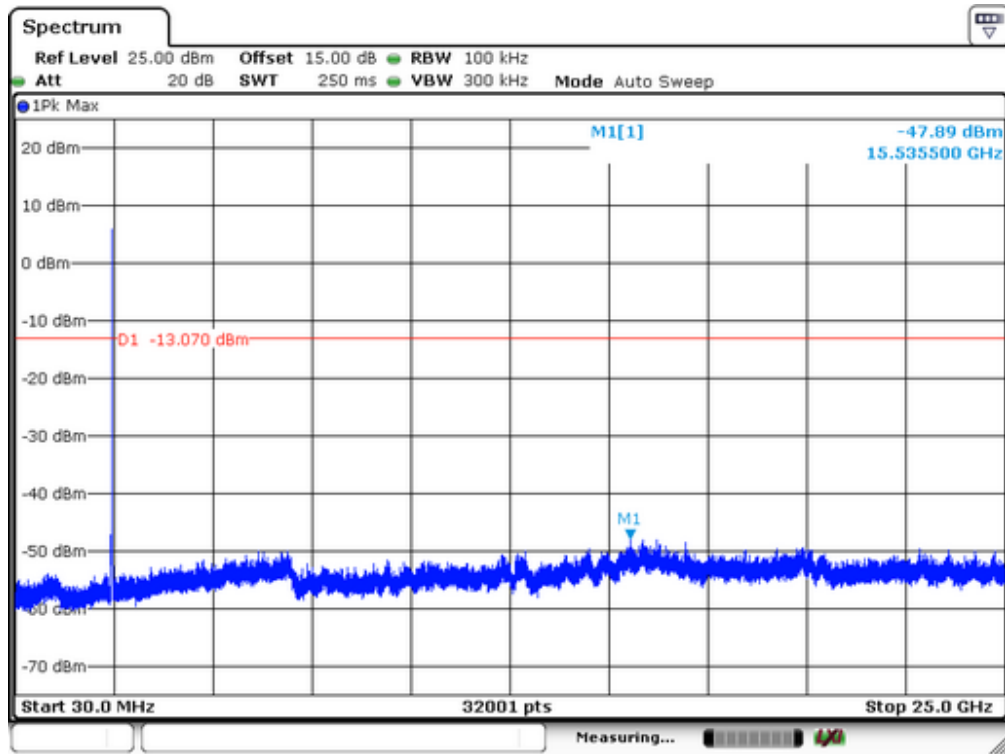

Highest Channel

Test Mode: 802.11g

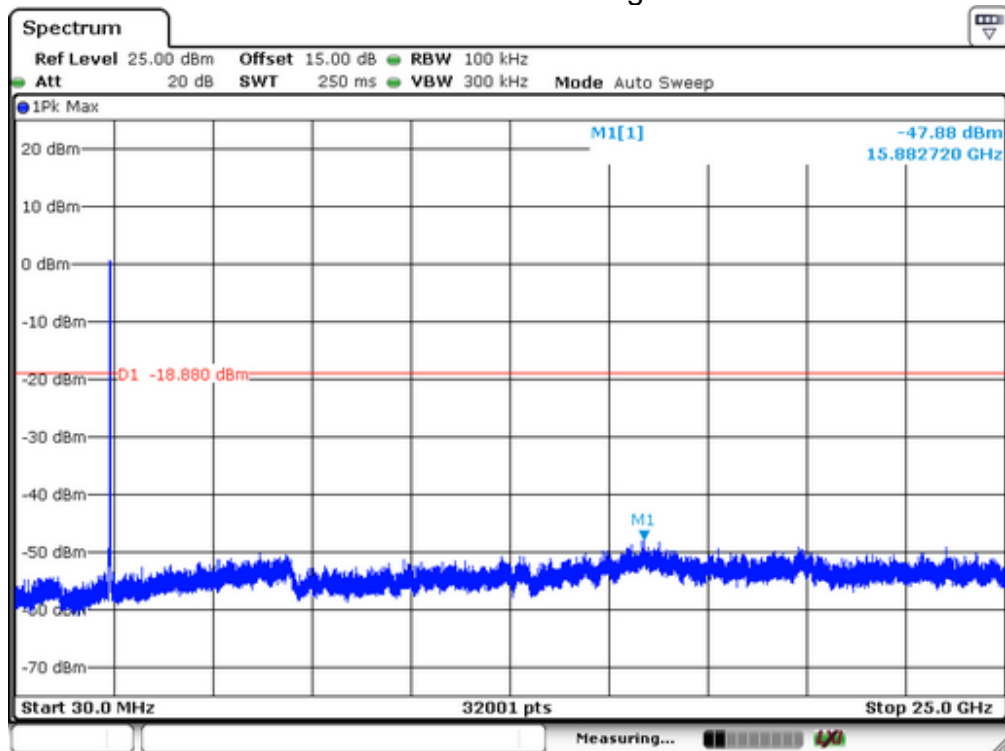

Lowest Channel

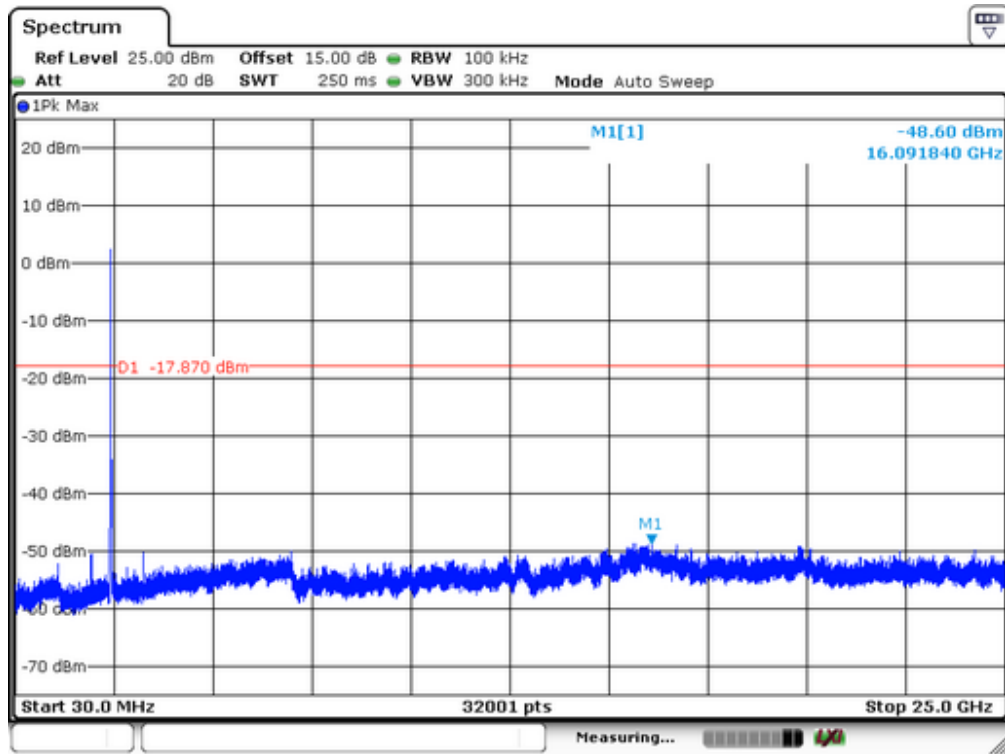

Middle Channel

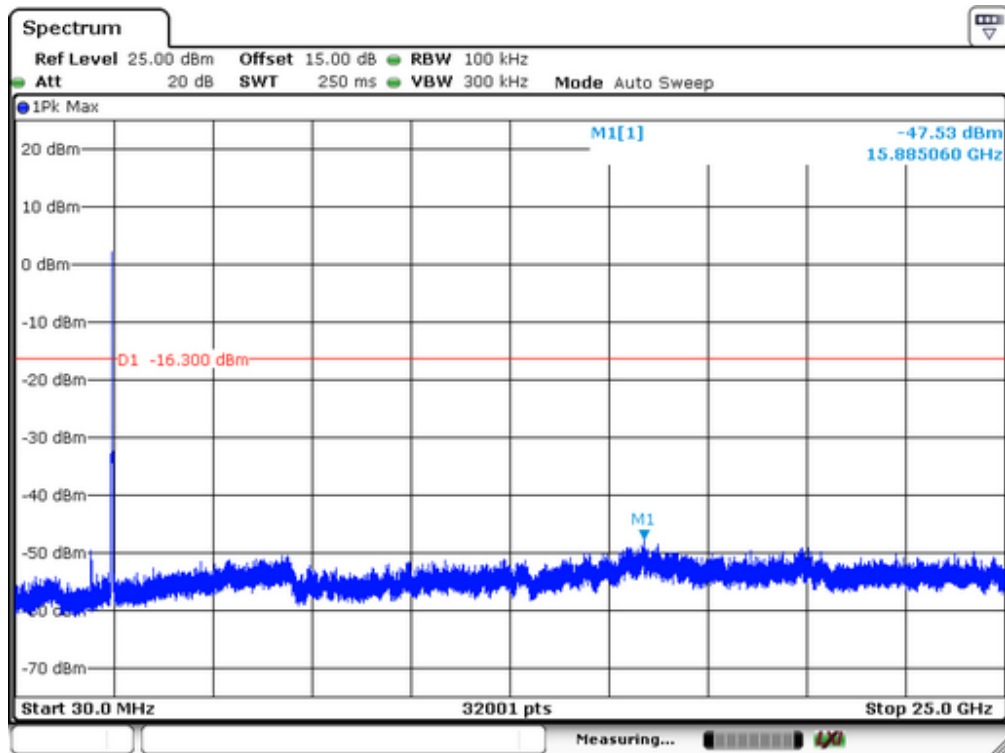

Highest Channel

Test Mode: 802.11n(HT20)

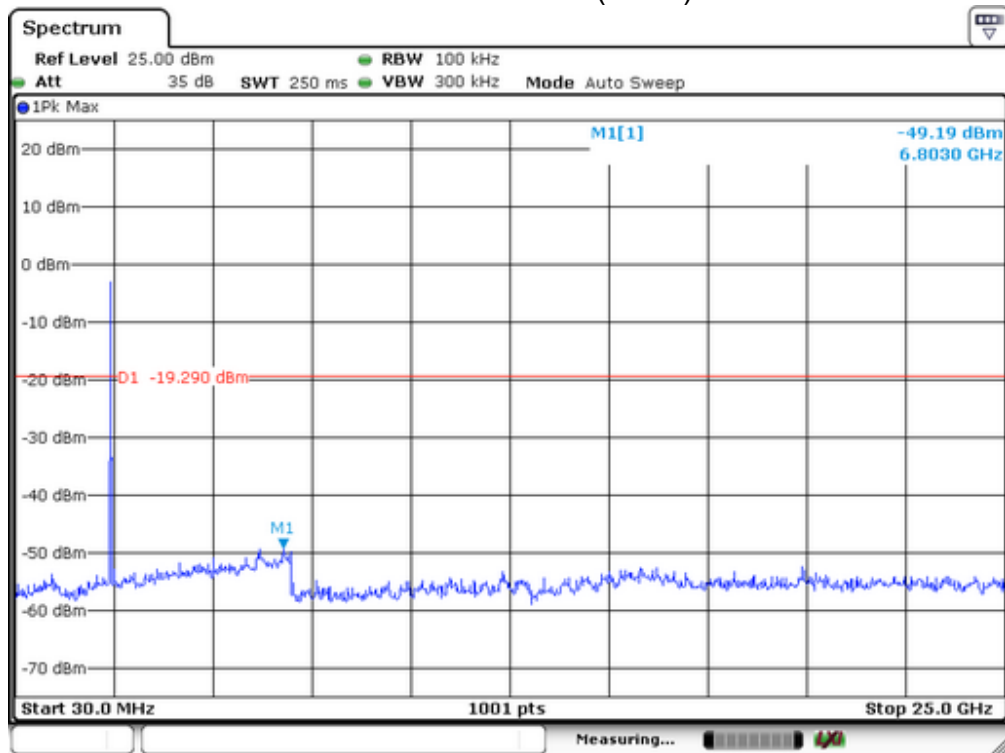

Lowest Channel

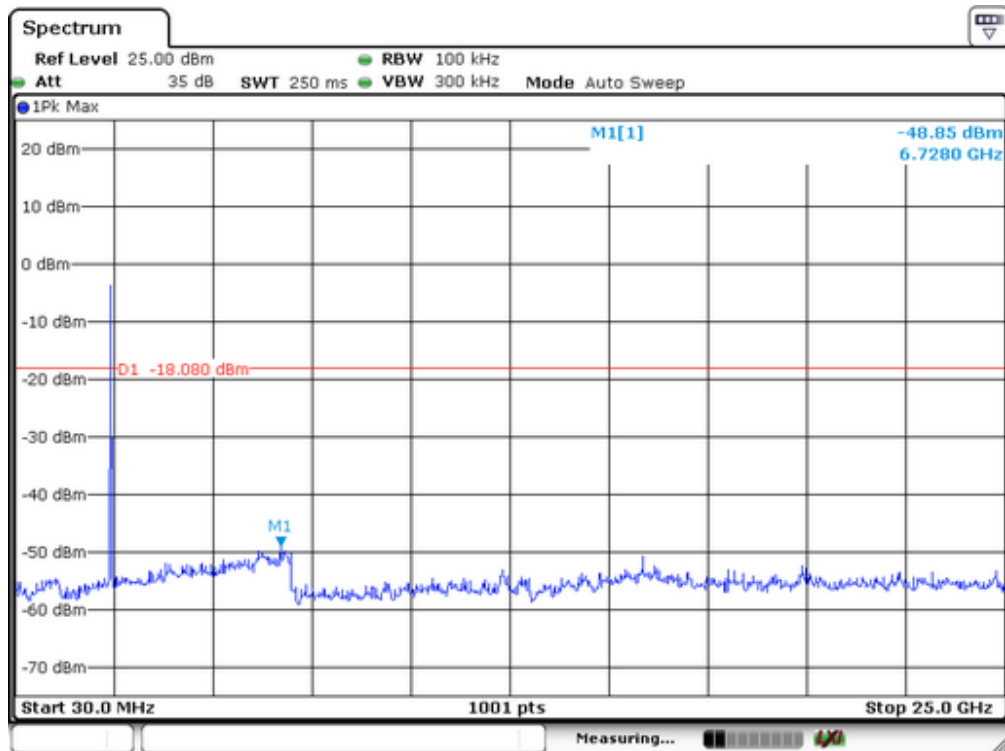

Middle Channel

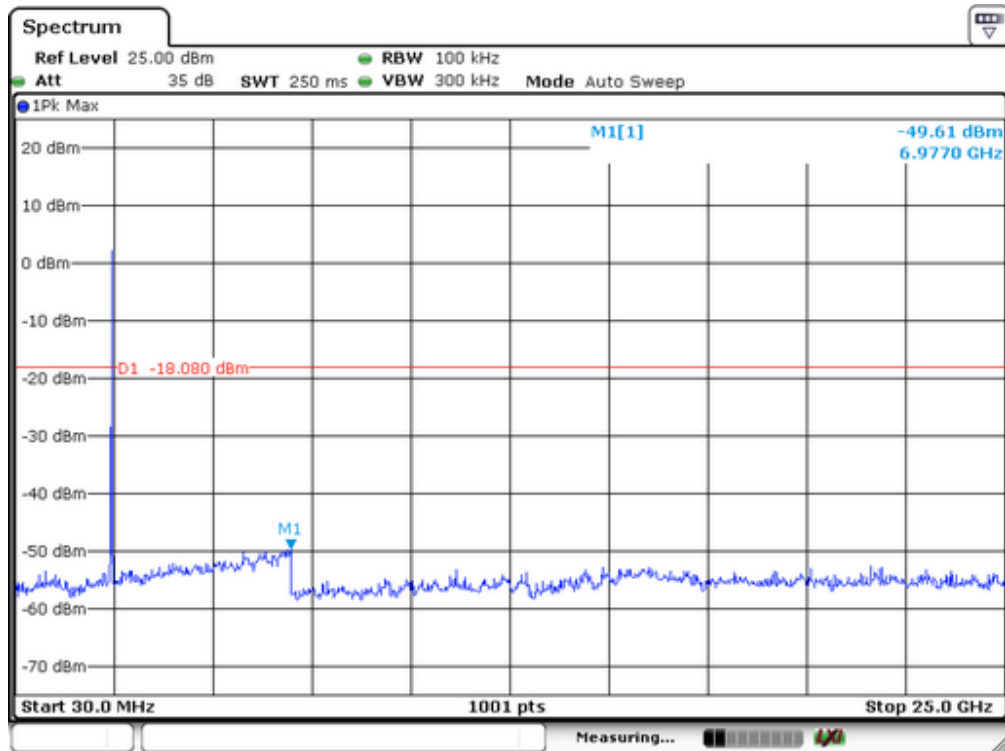

Highest Channel

Test Mode: 802.11n(HT40)

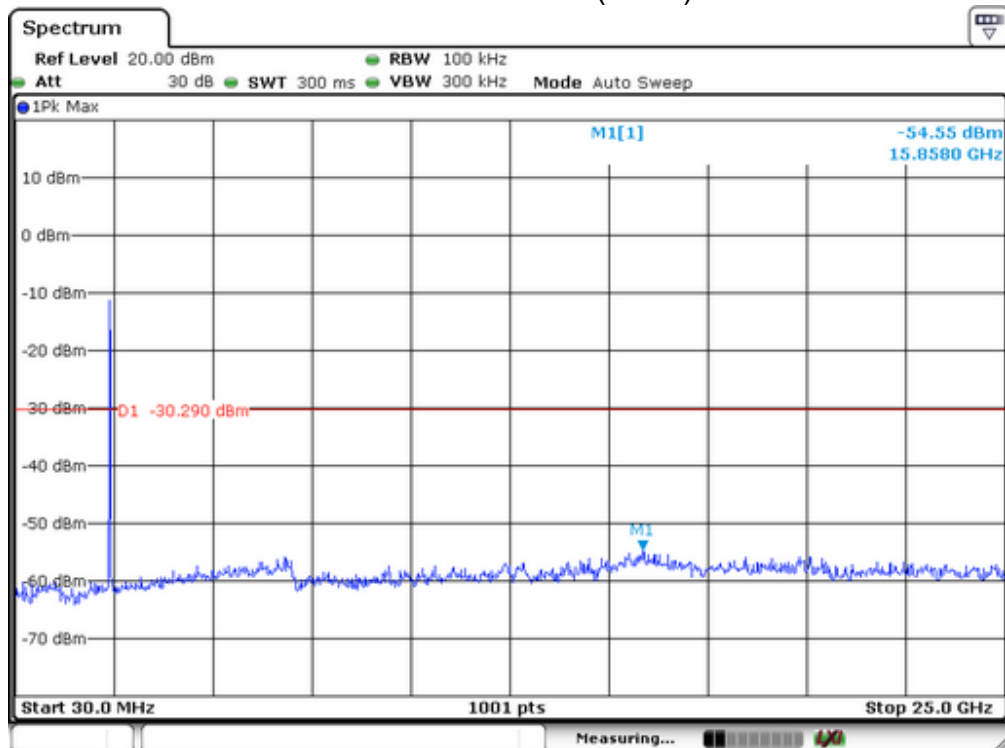

Lowest Channel



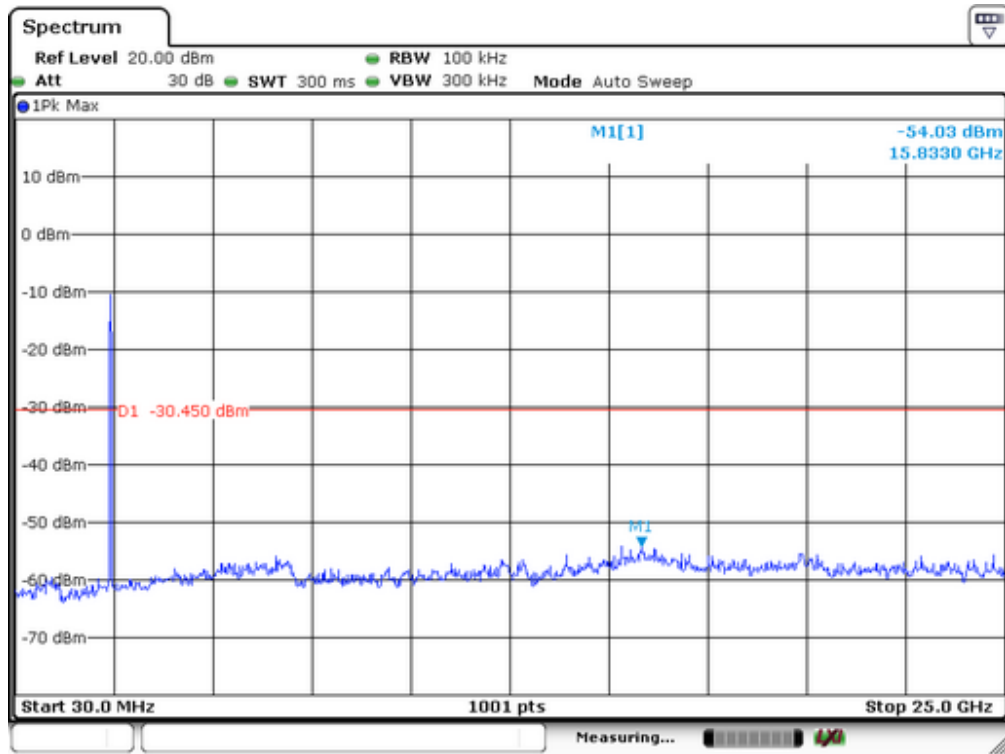

Middle Channel

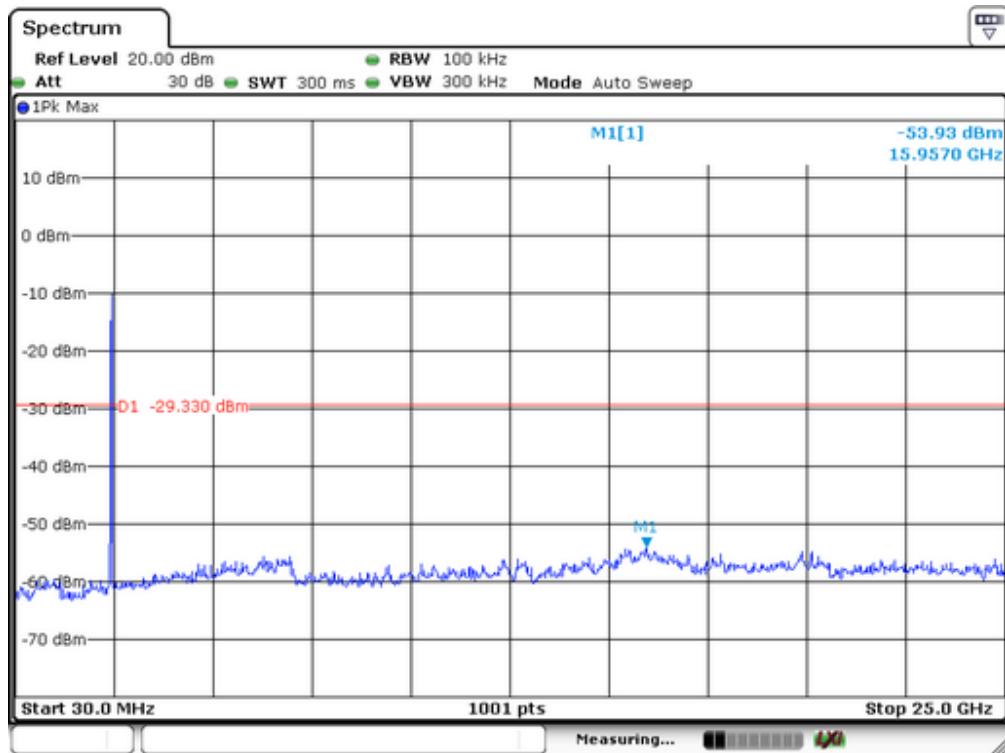

Highest Channel

## **13. Antenna Application**

### **13.1 Antenna Requirement**

For intentional device, according to FCC 47 CFR Section 15.203, an intentional radiator shall be designed to ensure that no antenna other than that furnished by the responsible party shall be used with the device. And according to FCC 47 CFR Section 15.247 (b), if transmitting antennas of directional gain greater than 6dBi are used, the power shall be reduced by the amount in dB that the directional gain of the antenna exceeds 6dBi.

### **13.2 Result**

The EUT'S antenna is an internal PCB antenna. The antenna's gain is 2 dBi and meets the requirement.

# APPENDIX I (PHOTOS OF EUT)







