

FCC 47 CFR PART 15 SUBPART E

CERTIFICATION TEST REPORT

For

LED TV

MODEL No.: T500TGA4BUA,E4STA5017,TU50GTG, WG50UX4100,
WG50XXXXXXXXXX, T50XXXXXXXXXXXX, EXXXXXXXXXXXX
(where X would be any Arabian number or English letter or blank)

FCC ID: 2ACWIT500TAA4B

Trade Mark: Westinghouse, Element

REPORT NO.: ES180306022E

ISSUE DATE: April 19, 2018

Prepared for

Shenyang Tongfang Multimedia Technology Co., Limited.
No.10 Nanping East Road HunNan New District Shenyang,
LiaoNing Province P.R .China

Prepared by

EMTEK(SHENZHEN) CO., LTD.

Bldg 69, Majialong Industry Zone, Nanshan District,
Shenzhen, Guangdong, China

TEL: 86-755-26954280

FAX: 86-755-26954282

1 TEST RESULT CERTIFICATION

Applicant:	Shenyang Tongfang Multimedia Technology Co., Limited. No.10 Nanping East Road HunNan New District Shenyang, LiaoNing Province P.R .China
Manufacturer:	Shenyang Tongfang Multimedia Technology Co., Limited. No.10 Nanping East Road HunNan New District Shenyang, LiaoNing Province P.R .China
Product Description:	LED TV
Model Number:	T500TGA4BUA,E4STA5017,TU50GTG,WG50UX4100,WG50XX XXXXXXX, T50XXXXXXXXXX, EXXXXXXXXXX (where X would be any Arabian number or English letter or blank) (Note: These models are identical except for decorative parts in front panels, color of enclosures and design of signal input/output terminals in secondary circuits. Here T500TGA4BUA was selected for full test.)
File Number:	ES180306022E
Date of Test:	March 06, 2018 to April 08, 2018

Measurement Procedure Used:

APPLICABLE STANDARDS	
STANDARD	TEST RESULT
FCC 47 CFR Part 2, Subpart J FCC 47 CFR Part 15, Subpart E	PASS

The above equipment was tested by EMTEK(SHENZHEN) CO., LTD.. The test data, data evaluation, test procedures, and equipment configurations shown in this report were made in accordance with the procedures given in ANSI C63.10 (2013) and the energy emitted by the sample EUT tested as described in this report is in compliance with the requirements of FCC Rules Part 2 and Part 15.407

The test results of this report relate only to the tested sample identified in this report.

Date of Test : March 06, 2018 to April 08, 2018

Prepared by : 
Yaping Shen/Editor

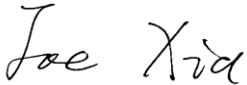
Reviewer : 
Joe Xia/Supervisor

Approve & Authorized Signer : 
Lisa Wang/Manager

TABLE OF CONTENTS

1	TEST RESULT CERTIFICATION	2
2	EUT TECHNICAL DESCRIPTION	4
3	SUMMARY OF TEST RESULT	6
4	TEST METHODOLOGY	7
4.1	GENERAL DESCRIPTION OF APPLIED STANDARDS	7
4.2	MEASUREMENT EQUIPMENT USED	7
4.3	DESCRIPTION OF TEST MODES.....	8
5	FACILITIES AND ACCREDITATIONS	11
5.1	FACILITIES	11
5.2	LABORATORY ACCREDITATIONS AND LISTINGS	11
6	TEST SYSTEM UNCERTAINTY	12
7	SETUP OF EQUIPMENT UNDER TEST	13
7.1	RADIO FREQUENCY TEST SETUP.....	13
7.2	RADIO FREQUENCY TEST SETUP.....	13
7.3	CONDUCTED EMISSION TEST SETUP	15
7.4	BLOCK DIAGRAM CONFIGURATION OF TEST SYSTEM	16
7.5	SUPPORT EQUIPMENT.....	16
8	TEST REQUIREMENTS	17
8.1	BANDWIDTH MEASUREMENT	17
8.2	MAXIMUM CONDUCTED OUTPUT POWER.....	42
8.3	MAXIMUM PEAK POWER DENSITY	46
8.4	FREQUENCY STABILITY	79
8.5	UNDESIRABLE RADIATED SPURIOUS EMISSION.....	91
8.6	POWER LINE CONDUCTED EMISSIONS	114
8.7	ANTENNA APPLICATION.....	117

2 EUT TECHNICAL DESCRIPTION

Characteristics	Description			
IEEE 802.11 WLAN Mode Supported	<input checked="" type="checkbox"/> 802.11a(20MHz channel bandwidth) <input checked="" type="checkbox"/> 802.11b(20MHz channel bandwidth) <input checked="" type="checkbox"/> 802.11g(20MHz channel bandwidth) <input checked="" type="checkbox"/> 802.11n(20MHz channel bandwidth) <input checked="" type="checkbox"/> 802.11n(40MHz channel bandwidth) <input checked="" type="checkbox"/> 802.11ac(20MHz channel bandwidth) <input checked="" type="checkbox"/> 802.11ac(40MHz channel bandwidth) <input checked="" type="checkbox"/> 802.11ac(80MHz channel bandwidth)			
Data Rate	WIFI: 802.11 b:1,2,5.5,11Mbps; 802.11 g/a:6,9,12,18,24,36,48,54Mbps; 802.11n(HT20)/ac(HT20): MCS0-MCS15; 802.11n(HT40): MCS0-MCS15; 802.11ac(HT40):MCS0-MCS19; 802.11ac(VHT80):MCS0-MCS19; Bluetooth DSS: 1Mbps for GFSK modulation 2Mbps for pi/4-DQPSK modulation 3Mbps for 8DPSK modulation Bluetooth DTS: 1Mbps for GFSK modulation			
Modulation	WIFI: OFDM with BPSK/QPSK/16QAM/64QAM for 802.11a/g/n; DSSS with DBPSK/DQPSK/CCK for 802.11b; BT DSS: GFSK modulation (1Mbps) pi/4-DQPSK modulation (2Mbps) 8DPSK modulation (3Mbps) BT DTS: GFSK modulation (1Mbps)			
Operating Frequency Range	WIFI 5G Band	Mode	Frequency Range(MHz)	Number of channels
	UNII Band I	802.11a/n(HT20)/ac(VHT20)	5180-5240	4
		802.11n(HT40)/ac(VHT40)	5190-5230	2
		802.11 ac(VHT80)	5210	1
	UNII Band III	802.11a/n(HT20)/ac(VHT20)	5745-5825	5
		802.11n(HT40)/ac(VHT40)	5755-5795	2
		802.11 ac(VHT80)	5775	1
2.4G WIFI: 2412-2462MHz for 802.11b/g; 2412-2462MHz for 802.11n(HT20); 2422-2452MHz for 802.11n(HT40); Bluetooth: 2402-2480MHz				
Transmit Power Max	16.94 dBm for WIFI 2.4G Band; 4.74 dBm for BT DSS; -0.03 dBm for BT DTS; 17.40 dBm for UNII Band I; 15.55 dBm for UNII Band III			

Antenna Type	Metel Antenna Two antenna for WIFI One antenna for BT
Max Antenna Gain	4.0 dBi for BT 4.0 dBi for BLE 4.0 dBi for WIFI 2.4 Band 5.0 dBi for WIFI 5G Band I 5.0 dBi for WIFI 5G Band III
Directional Gain	7.01 dBi for WIFI 2.4G Band 8.01 dBi for WIFI 5G Band I 8.01 dBi for WIFI 5G Band III
Power supply	AC 120V,60Hz

Note: for more details, please refer to the User's manual of the EUT.

3 SUMMARY OF TEST RESULT

FCC Part Clause	Test Parameter	Verdict	Remark
15.407 (a) 15.407 (e)	99% , 6dB and 26dB Bandwidth	PASS	
15.407 (a)	Maximum Conducted Output Power	PASS	
15.407 (a)	Peak Power Spectral Density	PASS	
15.407 (b)	Radiated Spurious Emission	PASS	
15.407(g)	Frequency Stability	PASS	
15.407 (b)(6) 15.207	Power Line Conducted Emission	PASS	
15.407(a) 15.203	Antenna Application	PASS	
NOTE1: N/A (Not Applicable) NOTE2: According to FCC OET KDB 789033 D2 General UNII Test Procedures New Rules v01r03, In addition, the radiated test is also performed to ensure the emissions emanating from the device cabinet also comply with the applicable limits.			

RELATED SUBMITTAL(S) / GRANT(S):

This submittal(s) (test report) is intended for FCC ID: 2ACWIT500TAA4B filing to comply with Section 15.247 of the FCC Part 15, Subpart E Rules.

4 TEST METHODOLOGY

4.1 GENERAL DESCRIPTION OF APPLIED STANDARDS

According to its specifications, the EUT must comply with the requirements of the following standards:

FCC 47 CFR Part 2, Subpart J

FCC 47 CFR Part 15, Subpart E

FCC KDB 789003 D2 General UNII Test Procedures New Rules v01r03

FCC KDB 662911 D01 Multiple Transmitter Output v02r01

FCC KDB 662911 D02 MIMO With Cross Polarized Antenna V01

4.2 MEASUREMENT EQUIPMENT USED

4.2.1 Conducted Emission Test Equipment

EQUIPMENT TYPE	MFR	MODEL NUMBER	SERIAL NUMBER	LAST CAL.	DUE CAL.
Test Receiver	Rohde & Schwarz	ESCS30	828985/018	05/28/2017	05/28/2018
L.I.S.N.	Schwarzbeck	NNLK8129	8129203	05/28/2017	05/28/2018
50Ω Coaxial Switch	Anritsu	MP59B	M20531	N/A	05/28/2018
Pulse Limiter	Rohde & Schwarz	ESH3-Z2	100006	05/28/2017	05/28/2018
Voltage Probe	Rohde & Schwarz	TK9416	N/A	05/28/2017	05/28/2018
I.S.N	Rohde & Schwarz	ENY22	1109.9508.02	05/28/2017	05/28/2018

4.2.2 Radiated Emission Test Equipment

EQUIPMENT TYPE	MFR	MODEL NUMBER	SERIAL NUMBER	LAST CAL.	DUE CAL.
EMI Test Receiver	Rohde & Schwarz	ESU	1302.6005.26	05/28/2017	05/28/2018
Pre-Amplifier	HP	8447D	2944A07999	05/28/2017	05/28/2018
Bilog Antenna	Schwarzbeck	VULB9163	142	05/28/2017	05/28/2018
Loop Antenna	ARA	PLA-1030/B	1029	05/28/2017	05/28/2018
Horn Antenna	Schwarzbeck	BBHA 9170	BBHA9170399	05/28/2017	05/28/2018
Horn Antenna	Schwarzbeck	BBHA 9120	D143	05/28/2017	05/28/2018
Cable	Schwarzbeck	AK9513	ACRX1	05/28/2017	05/28/2018
Cable	Rosenberger	N/A	FP2RX2	05/28/2017	05/28/2018
Cable	Schwarzbeck	AK9513	CRPX1	05/28/2017	05/28/2018
Cable	Schwarzbeck	AK9513	CRRX2	05/28/2017	05/28/2018

4.2.3 Radio Frequency Test Equipment

EQUIPMENT TYPE	MFR	MODEL NUMBER	SERIAL NUMBER	LAST CAL.	DUE CAL.
Spectrum Analyzer	Agilent	E4407B	88156318	05/28/2017	05/28/2018
peak power analyzer	Agilent	8990B	4657524	05/28/2017	05/28/2018
Spectrum Analyzer	Agilent	N9010A	My53470879	05/28/2017	05/28/2018
Spectrum Analyzer	Rohde & Schwarz	FSV40	100967	05/28/2017	05/28/2018

Remark: Each piece of equipment is scheduled for calibration once a year.

4.3 DESCRIPTION OF TEST MODES

The EUT has been tested under its typical operating condition.

The EUT configuration for testing is installed on RF field strength measurement to meet the Commissions requirement and operating in a manner which intends to maximize its emission characteristics in a continuous normal application.

The Transmitter was operated in the normal operating mode. The TX frequency was fixed which was for the purpose of the measurements.

Test of channel included the lowest and middle and highest frequency to perform the test, then record on this report.

Those data rates (802.11a: 6 Mbps; 802.11n (HT20): MCS0; 802.11n (HT20): MCS15; 802.11n (HT40): MCS0; 802.11n (HT40): MCS15; 802.11ac (HT20): MCS0; 802.11ac (HT20): MCS15; 802.11ac (HT40): MCS0; 802.11ac (HT40): MCS19; 802.11ac (HT80): MCS0; 802.11ac (HT80): MCS19;) were used for all test.

Pre-defined engineering program for regulatory testing used to control the EUT for staying in continuous transmitting and receiving mode is programmed.

Wifi 5G with UNII Band I

Frequency and Channel list for 802.11a/n(HT20)/ac(VHT20):

Channel	Frequency (MHz)	Channel	Frequency (MHz)	Channel	Frequency (MHz)
36	5180	44	5220		
40	5200	48	5240		

Frequency and Channel list for 802.11n(HT40)/ac(VHT40):

Channel	Frequency (MHz)	Channel	Frequency (MHz)	Channel	Frequency (MHz)
38	5190				
46	5230				

Frequency and Channel list for 802.11ac(VHT80):

Channel	Frequency (MHz)	Channel	Frequency (MHz)	Channel	Frequency (MHz)
42	5210				

Test Frequency and Channel for 802.11a/n(HT20)/ac(VHT20):

Lowest Frequency		Middle Frequency		Highest Frequency	
Channel	Frequency (MHz)	Channel	Frequency (MHz)	Channel	Frequency (MHz)
36	5180	40	5200	48	5240

Test Frequency and channel for 802.11n(VHT40)/ac(VHT40):

Lowest Frequency		Middle Frequency		Highest Frequency	
Channel	Frequency (MHz)	Channel	Frequency (MHz)	Channel	Frequency (MHz)
38	5190	N/A	N/A	46	5230

Test Frequency and channel for 802.11ac(HT80):

Lowest Frequency		Middle Frequency		Highest Frequency	
Channel	Frequency (MHz)	Channel	Frequency (MHz)	Channel	Frequency (MHz)
42	5210	N/A	N/A	N/A	N/A

Wifi 5G with UNII Band III

Frequency and Channel list for 802.11a/n(HT20)/ac(VHT20):

Channel	Frequency (MHz)	Channel	Frequency (MHz)	Channel	Frequency (MHz)
149	5745	157	5785	165	5825
153	5765	161	5805		

Frequency and Channel list for 802.11n(HT40)/ac(VHT40):

Channel	Frequency (MHz)	Channel	Frequency (MHz)	Channel	Frequency (MHz)
151	5755				
159	5795				

Frequency and Channel list for 802.11ac(VHT80):

Channel	Frequency (MHz)	Channel	Frequency (MHz)	Channel	Frequency (MHz)
155	5775				

Test Frequency and Channel for 802.11a/n(HT20)/ac(VHT20):

Lowest Frequency		Middle Frequency		Highest Frequency	
Channel	Frequency (MHz)	Channel	Frequency (MHz)	Channel	Frequency (MHz)
149	5745	157	5785	165	5825

Test Frequency and channel for 802.11n(HT40)/ac(VHT40):

Lowest Frequency		Middle Frequency		Highest Frequency	
Channel	Frequency (MHz)	Channel	Frequency (MHz)	Channel	Frequency (MHz)
151	5755	N/A	N/A	159	5795

Test Frequency and channel for 802.11ac(VHT80):

Lowest Frequency		Middle Frequency		Highest Frequency	
Channel	Frequency (MHz)	Channel	Frequency (MHz)	Channel	Frequency (MHz)
155	5775				

5 FACILITIES AND ACCREDITATIONS

5.1 FACILITIES

All measurement facilities used to collect the measurement data are located at

Bldg 69, Majialong Industry Zone District, Nanshan District, Shenzhen, China

The sites are constructed in conformance with the requirements of ANSI C63.7, ANSI C63.10 and CISPR Publication 22.

5.2 LABORATORY ACCREDITATIONS AND LISTINGS

Site Description

EMC Lab.

: Accredited by CNAS,2016.10.24

The certificate is valid until 2022.10.28

The Laboratory has been assessed and proved to be in compliance with CNAS-CL01:2006 (identical to ISO/IEC 17025:2005)

The Certificate Registration Number is L2291.

Accredited by TUV Rheinland Shenzhen 2015.4

The Laboratory has been assessed according to the requirements ISO/IEC 17025.

Accredited by FCC, July 06, 2016

The Certificate Registration Number is 709623.

Accredited by FCC, July 06, 2016

The Certificate Registration Number is 406365.

Accredited by Industry Canada, November 29, 2012

The Certificate Registration Number is 4480A.

Name of Firm

: EMTEK(SHENZHEN) CO., LTD.

Site Location

: Bldg 69, Majialong Industry Zone,
Nanshan District, Shenzhen, Guangdong, China

6 TEST SYSTEM UNCERTAINTY

The following measurement uncertainty levels have been estimated for tests performed on the apparatus:

Parameter	Uncertainty
Radio Frequency	$\pm 1 \times 10^{-5}$
Maximum Peak Output Power Test	$\pm 1.0\text{dB}$
Conducted Emissions Test	$\pm 2.0\text{dB}$
Radiated Emission Test	$\pm 2.0\text{dB}$
Power Density	$\pm 2.0\text{dB}$
Occupied Bandwidth Test	$\pm 1.0\text{dB}$
Band Edge Test	$\pm 3\text{dB}$
All emission, radiated	$\pm 3\text{dB}$
Antenna Port Emission	$\pm 3\text{dB}$
Temperature	$\pm 0.5^{\circ}\text{C}$
Humidity	$\pm 3\%$

Measurement Uncertainty for a level of Confidence of 95%

7 SETUP OF EQUIPMENT UNDER TEST

7.1 RADIO FREQUENCY TEST SETUP

The WLAN component's antenna ports(s) of the EUT are connected to the measurement instrument per an appropriate attenuator. The EUT is controlled by PC/software to emit the specified signals for the purpose of measurements.

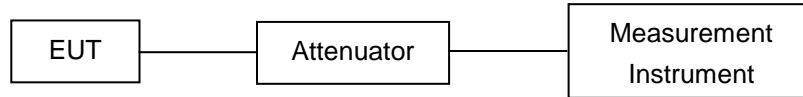

7.2 RADIO FREQUENCY TEST SETUP

The test site semi-anechoic chamber has met the requirement of NSA tolerance 4 dB according to the standards: ANSI C63.10. The test distance is 3m. The setup is according to the requirements in Section 13.1.4.1 of ANSI C63.10-2013 and CAN/CSA-CEI/IEC CISPR 22.

Below 30MHz:

The EUT is placed on a turntable 0.8 meters above the ground in the chamber, 3 meter away from the antenna (loop antenna). The Antenna should be positioned with its plane vertical at the specified distance from the EUT and rotated about its vertical axis for maximum response at each azimuth about the EUT. The center of the loop shall be 1 m above the ground. For certain applications, the loop antenna plane may also need to be positioned horizontally at the specified distance from the EUT.

Above 30MHz:

The EUT is placed on a turntable 0.8 meters above the ground in the chamber, 3 meter away from the antenna. The maximal emission value is acquired by adjusting the antenna height, polarisation and turntable azimuth. Normally, the height range of antenna is 1 m to 4 m, the azimuth range of turntable is 0° to 360°, and the receive antenna has two polarizations Vertical (V) and Horizontal (H).

Above 1GHz:

(Note: the FCC's permission to use 1.5m as an alternative per TCBC Conf call of Dec. 2, 2014.)

The EUT is placed on a turntable 1.5 meters above the ground in the chamber, 3 meter away from the antenna. The maximal emission value is acquired by adjusting the antenna height, polarisation and turntable azimuth. Normally, the height range of antenna is 1 m to 4 m, the azimuth range of turntable is 0° to 360°, and the receive antenna has two polarizations Vertical (V) and Horizontal (H).

(a) Radiated Emission Test Set-Up, Frequency Below 30MHz

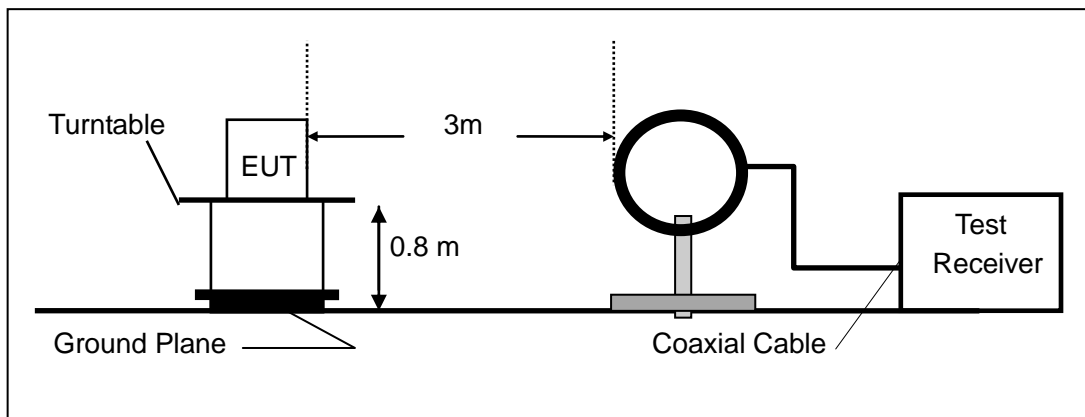

(b) Radiated Emission Test Set-Up, Frequency Below 1000MHz

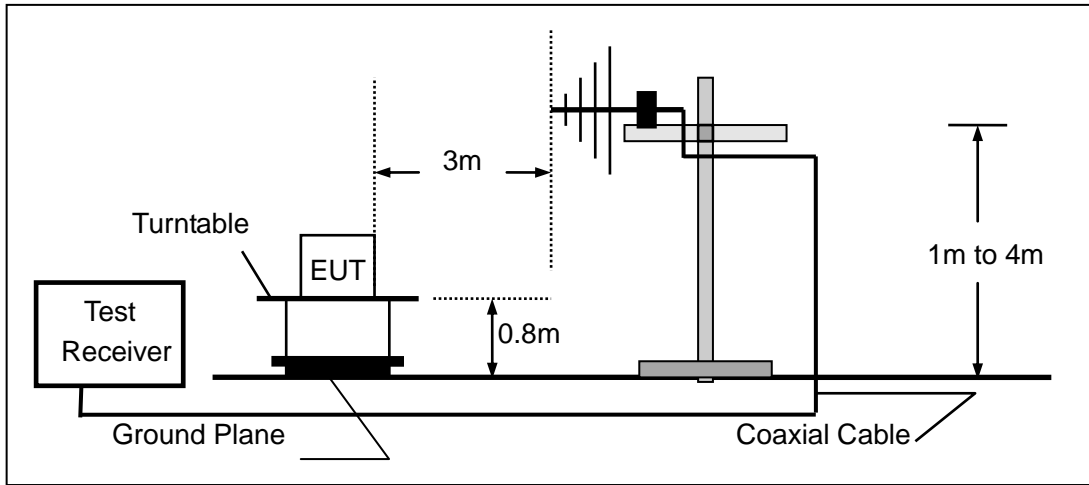

(c) Radiated Emission Test Set-Up, Frequency above 1000MHz

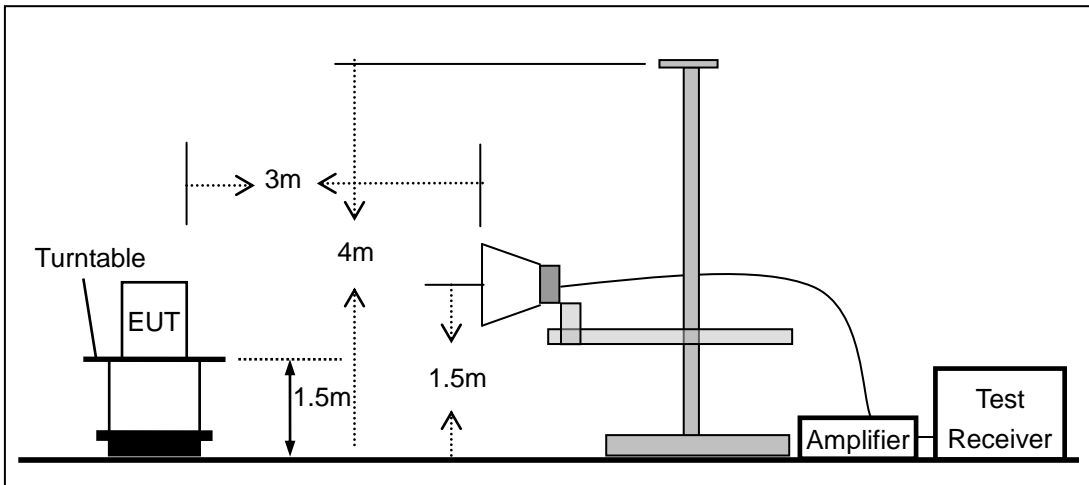

7.3 CONDUCTED EMISSION TEST SETUP

The mains cable of the EUT must be connected to LISN. The LISN shall be placed 0.8 m from the boundary of EUT and bonded to a ground reference plane for LISN mounted on top of the ground reference plane. This distance is between the closest points of the LISN and the EUT. All other units of the EUT and associated equipment shall be at least 0.8m from the LISN.

Ground connections, where required for safety purposes, shall be connected to the reference ground point of the LISN and, where not otherwise provided or specified by the manufacturer, shall be of same length as the mains cable and run parallel to the mains connection at a separation distance of not more than 0.1 m.

According to the requirements in Section 13.1.4.1 of ANSI C63.10-2013 Conducted emissions from the EUT measured in the frequency range between 0.15 MHz and 30 MHz using CISPR Quasi-Peak and average detector mode.

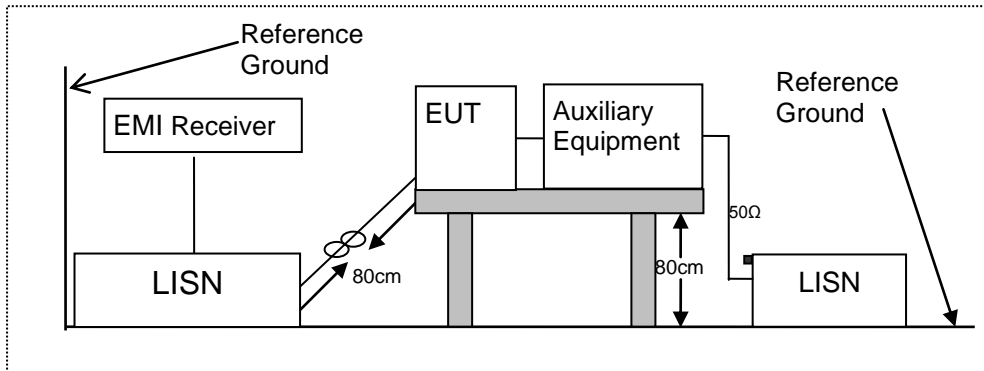

7.4 BLOCK DIAGRAM CONFIGURATION OF TEST SYSTEM

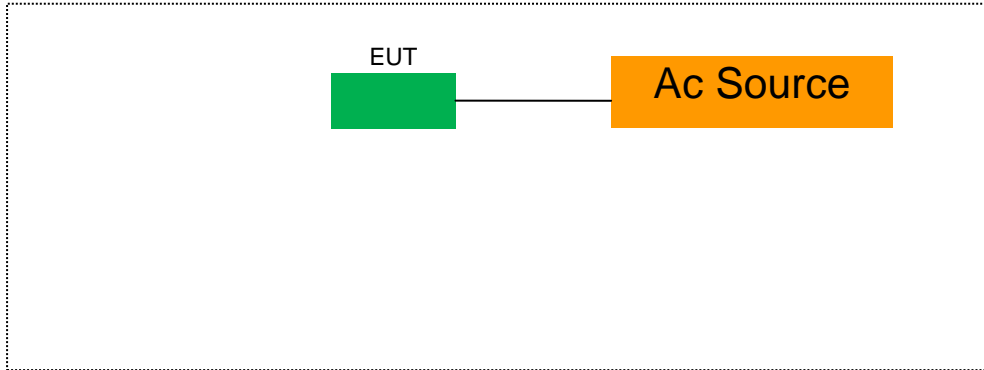

7.5 SUPPORT EQUIPMENT

Item	Equipment	Mfr/Brand	Model/Type No.	FCC ID	Series No.	Note
N/A	N/A	N/A	N/A	N/A	N/A	N/A

Notes:

1. All the equipment/cables were placed in the worst-case configuration to maximize the emission during the test.
2. Grounding was established in accordance with the manufacturer's requirements and conditions for the intended use.

8 TEST REQUIREMENTS

8.1 BANDWIDTH MEASUREMENT

8.1.1 Applicable Standard

According to FCC Part 15.407(a)(1) for UNII Band I

According to FCC Part 15.407(e) for UNII Band III

8.1.2 Conformance Limit

No limit requirement.

The minimum 6 dB emission bandwidth of at least 500 KHz for the UNII Band III.

8.1.3 Test Configuration

Test according to clause 6.1 radio frequency test setup

8.1.4 Test Procedure

Connect the antenna port(s) to the spectrum analyzer input. Using the spectrum analyzer Channel Bandwidth mode, configure the spectrum analyzer as shown below

■ The following procedure shall be used for measuring (26 dB) power bandwidth:

Center Frequency: test Frequency

Set RBW = approximately 1% of the emission bandwidth.

Set the VBW > RBW.

Detector = Peak.

Trace mode = max hold.

X dB Bandwidth: 26 dB

Measure the maximum width of the emission that is 26 dB down from the maximum of the emission.

Compare this with the RBW setting of the analyzer. Readjust RBW and repeat measurement as needed until the RBW/EBW ratio is approximately 1%.

■ Minimum Emission Bandwidth for the UNII Band III

Center Frequency: test Frequency

Set RBW = 100 kHz

Set VBW $\geq 3 \cdot$ RBW

Detector = Peak

Trace mode = max hold

Sweep = auto couple

X dB Bandwidth: 6 dB

Note: The automatic bandwidth measurement capability of a spectrum analyzer or EMI receiver may be employed if it implements the functionality described above.

■ The following procedure shall be used for measuring (99 %) power bandwidth:

Set center frequency to the nominal EUT channel center frequency.

Set span = 1.5 times to 5.0 times the OBW.

Set RBW = 1 % to 5 % of the OBW

Set VBW $\geq 3 \cdot$ RBW

Video averaging is not permitted. Where practical, a sample detection and single sweep mode shall be used.

Otherwise, peak detection and max hold mode (until the trace stabilizes) shall be used.

Use the 99 % power bandwidth function of the instrument (if available).

If the instrument does not have a 99 % power bandwidth function, the trace data points are recovered and directly summed in power units. The recovered amplitude data points, beginning at the lowest frequency, are placed in a running sum until 0.5 % of the total is reached; that frequency is recorded as the lower frequency. The process is repeated until 99.5 % of the total is reached; that frequency is recorded as the upper frequency. The 99% occupied bandwidth is the difference between these two frequencies.

8.1.5 Test Results

We tested antenna A and antenna B. The test results are similar, the worst test data for Antenna A:

<input checked="" type="checkbox"/> 802.11a mode						
Temperature :		28°C	Test Date :		April 08,2018	
Humidity :		65 %	Test By:		King Kong	
Band	Channel Number	Channel Freq. (MHz)	26dB EBW	99% OBW	Limit (MHz)	Verdict
UNII Band I	CH36	5180	19.90	16.63	N/A	N/A
	CH40	5200	20.17	16.55	N/A	N/A
	CH48	5240	20.82	16.57	N/A	N/A
UNII Band III	CH149	5745	19.55	16.58	N/A	N/A
	CH157	5785	19.61	16.54	N/A	N/A
	CH165	5825	19.86	16.55	N/A	N/A
Note: N/A (Not Applicable)						

<input checked="" type="checkbox"/> 802.11n(VHT20) mode						
Temperature :		28°C	Test Date :		April 08,2018	
Humidity :		65 %	Test By:		King Kong	
Band	Channel Number	Channel Freq. (MHz)	26dB EBW	99% OBW	Limit (MHz)	Verdict
UNII Band I	CH36	5180	20.12	17.60	N/A	N/A
	CH40	5200	19.52	17.58	N/A	N/A
	CH48	5240	19.79	17.58	N/A	N/A
UNII Band III	CH149	5745	19.24	17.62	N/A	N/A
	CH157	5785	19.72	17.61	N/A	N/A
	CH165	5825	19.71	17.59	N/A	N/A
Note: N/A (Not Applicable)						

802.11ac(VHT20) mode

Temperature : 28°C Test Date : April 08,2018
Humidity : 65 % Test By: King Kong

Band	Channel Number	Channel Freq. (MHz)	26dB EBW	99% OBW	Limit (MHz)	Verdict
UNII Band I	CH36	5180	19.69	17.61	N/A	N/A
	CH40	5200	19.80	17.62	N/A	N/A
	CH48	5240	19.83	17.62	N/A	N/A
UNII Band III	CH149	5745	19.90	17.62	N/A	N/A
	CH157	5785	19.97	17.57	N/A	N/A
	CH165	5825	19.71	17.57	N/A	N/A

Note:
N/A (Not Applicable)

802.11n(VHT40) mode

Temperature : 28°C Test Date : April 08,2018
Humidity : 65 % Test By: King Kong

Band	Channel Number	Channel Freq. (MHz)	26dB EBW	99% OBW	Limit (MHz)	Verdict
UNII Band I	CH38	5190	40.59	36.13	N/A	N/A
	CH46	5230	40.77	36.18	N/A	N/A
UNII Band III	CH151	5755	40.33	36.13	N/A	N/A
	CH159	5795	39.62	35.95	N/A	N/A

Note:
N/A (Not Applicable)

802.11ac(VHT40) mode

Temperature : 28°C Test Date : April 08,2018
Humidity : 65 % Test By: King Kong

Band	Channel Number	Channel Freq. (MHz)	26dB EBW	99% OBW	Limit (MHz)	Verdict
UNII Band I	CH38	5190	40.07	36.04	N/A	N/A
	CH46	5230	40.16	36.06	N/A	N/A
UNII Band III	CH151	5755	40.54	36.12	N/A	N/A
	CH159	5795	40.53	35.95	N/A	N/A

Note:
N/A (Not Applicable)

802.11ac(VHT80) mode

Temperature : 28°C Test Date : April 08,2018
Humidity : 65 % Test By: King Kong

Band	Channel Number	Channel Freq. (MHz)	26dB EBW	99% OBW	Limit (MHz)	Verdict
UNII Band I	CH42	5210	80.50	75.15	N/A	N/A
UNII Band III	CH155	5775	79.79	75.17	N/A	N/A

Note:
N/A (Not Applicable)

UNII Band III

Temperature : 28°C Test Date : April 08,2018
Humidity : 65 % Test By: King Kong

Operation Mode	Channel Number	Channel Freq. (MHz)	6dB EBW	Limit (MHz)	Verdict
802.11a	CH149	5745	16.34	500	PASS
	CH157	5785	16.29	500	PASS
	CH165	5825	16.07	500	PASS
802.11n (VHT20)	CH149	5745	17.03	500	PASS
	CH157	5785	17.32	500	PASS
	CH165	5825	17.32	500	PASS
802.11ac (VHT20)	CH149	5745	17.31	500	PASS
	CH157	5785	17.58	500	PASS
	CH165	5825	17.57	500	PASS
802.11n (VHT40)	CH151	5755	35.99	500	PASS
	CH159	5795	35.14	500	PASS
802.11ac (VHT40)	CH151	5755	35.20	500	PASS
	CH159	5795	35.13	500	PASS
802.11ac (VHT80)	CH155	5775	73.97	500	PASS

Note:
N/A (Not Applicable)

Emission Bandwidth&99% Occupied Bandwidth UNII Band I
 Test Model 802.11a Frequency(MHz) 5180

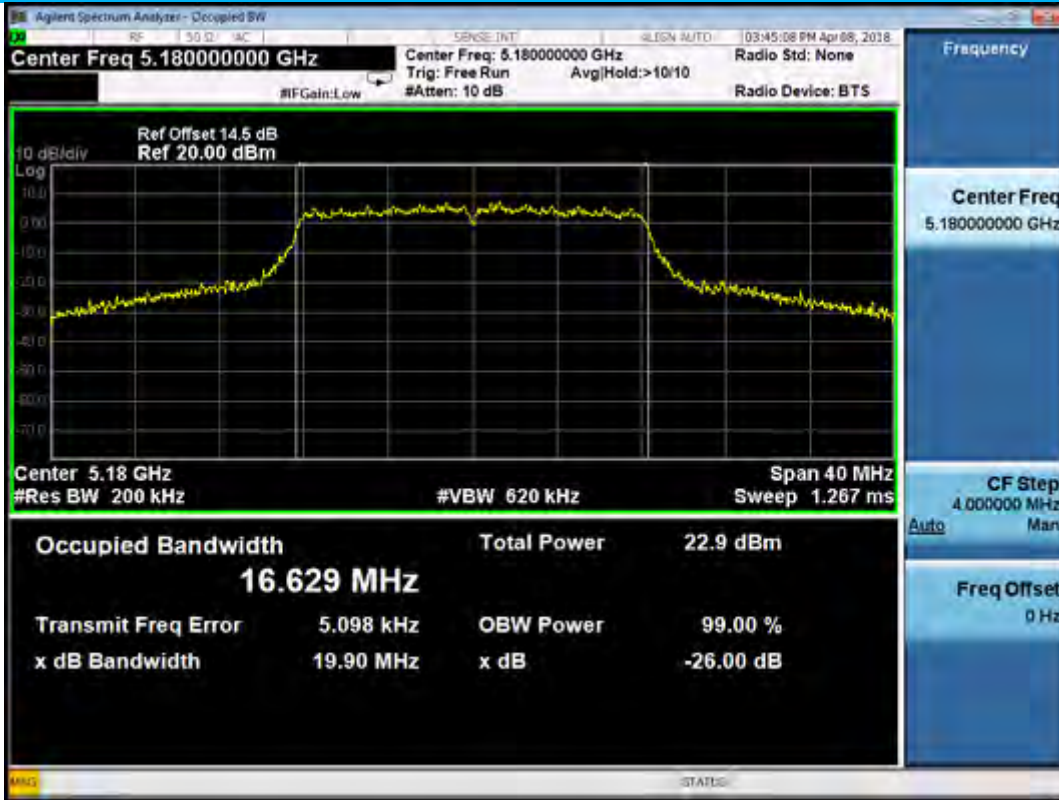

Emission Bandwidth&99% Occupied Bandwidth UNII Band I
 Test Model 802.11a Frequency(MHz) 5200

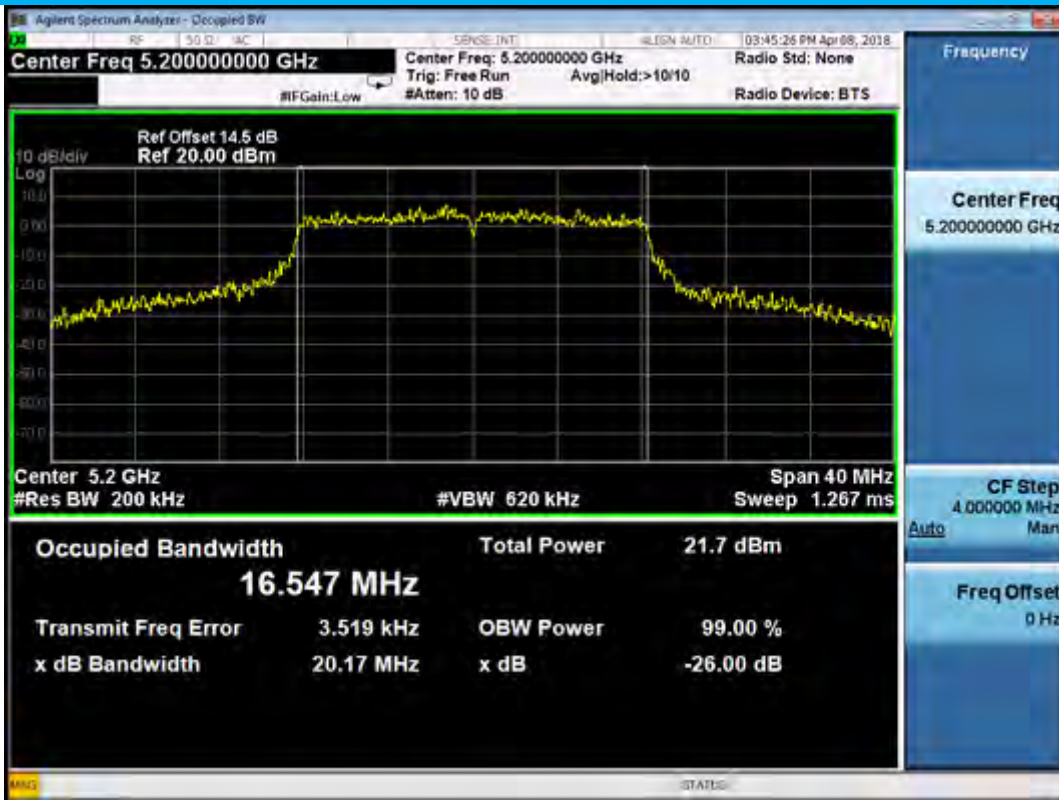

Emission Bandwidth&99% Occupied Bandwidth UNII Band I
 Test Model 802.11a Frequency(MHz) 5240

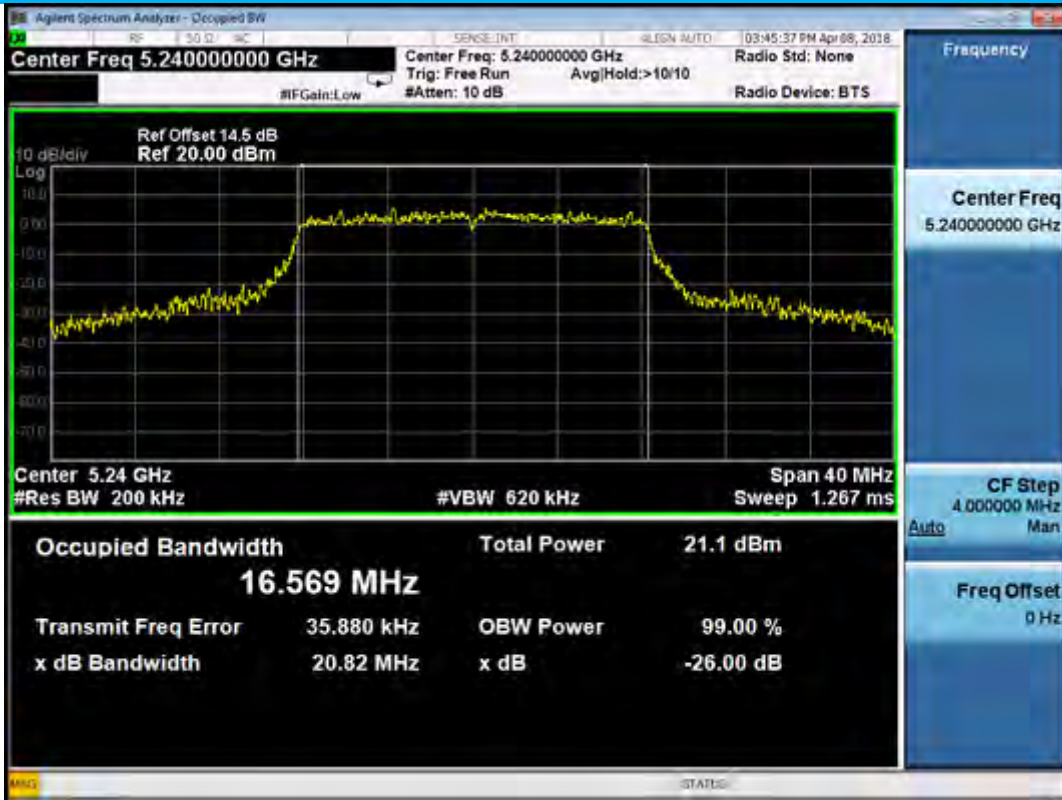

Emission Bandwidth&99% Occupied Bandwidth UNII Band III
 Test Model 802.11a Frequency(MHz) 5745

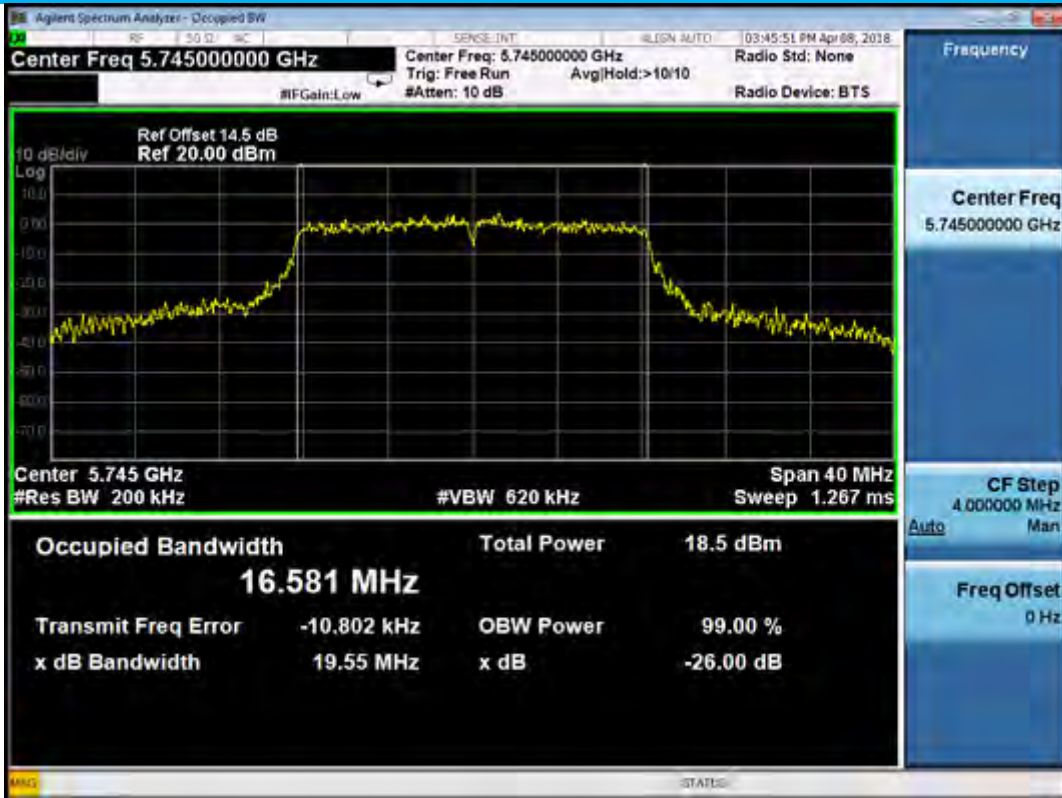

Emission Bandwidth&99% Occupied Bandwidth UNII Band III
 Test Model 802.11a Frequency(MHz) 5785

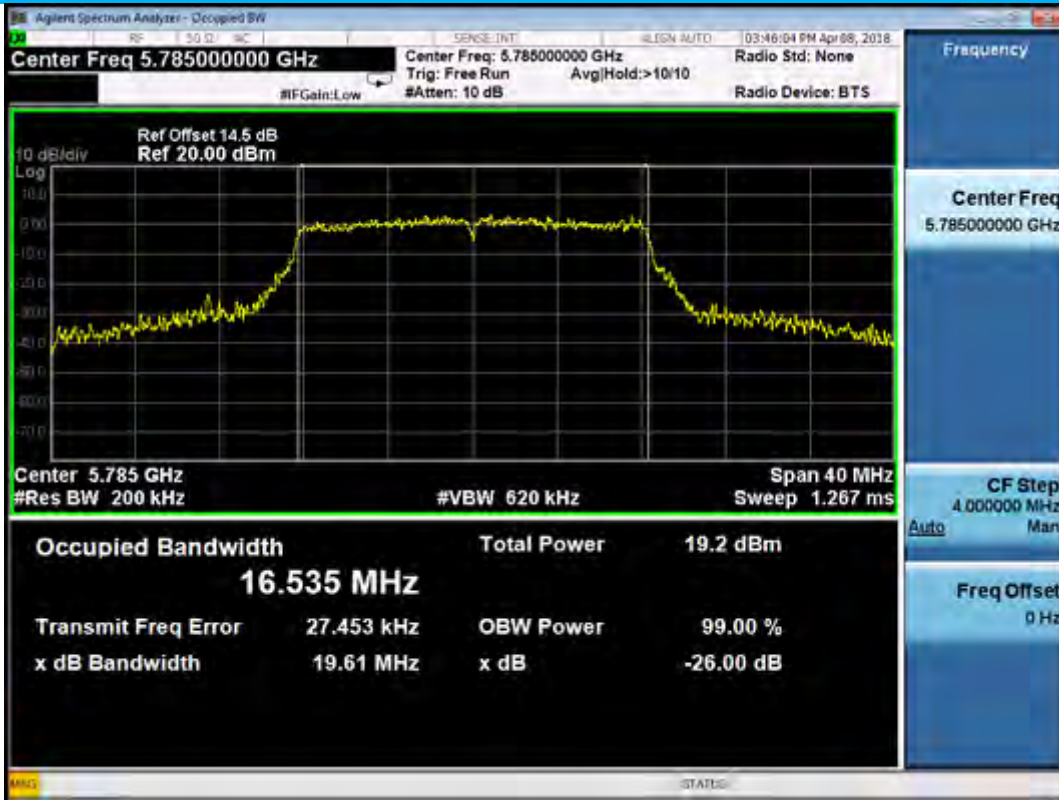

Emission Bandwidth&99% Occupied Bandwidth UNII Band III
 Test Model 802.11a Frequency(MHz) 5825



Emission Bandwidth&99% Occupied Bandwidth UNII Band I
 Test Model 802.11n(VHT20) mode Frequency(MHz) 5180

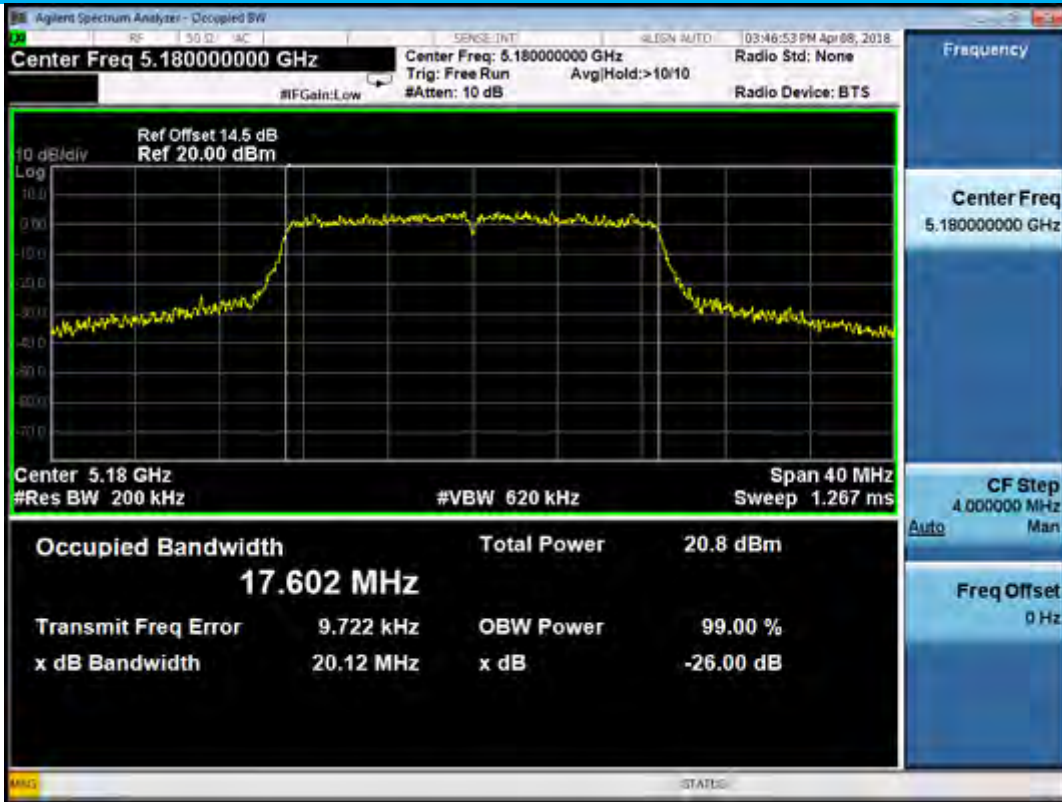

Emission Bandwidth&99% Occupied Bandwidth UNII Band I
 Test Model 802.11n(VHT20) mode Frequency(MHz) 5200



Emission Bandwidth&99% Occupied Bandwidth UNII Band I
 Test Model 802.11n(VHT20) mode Frequency(MHz) 5240

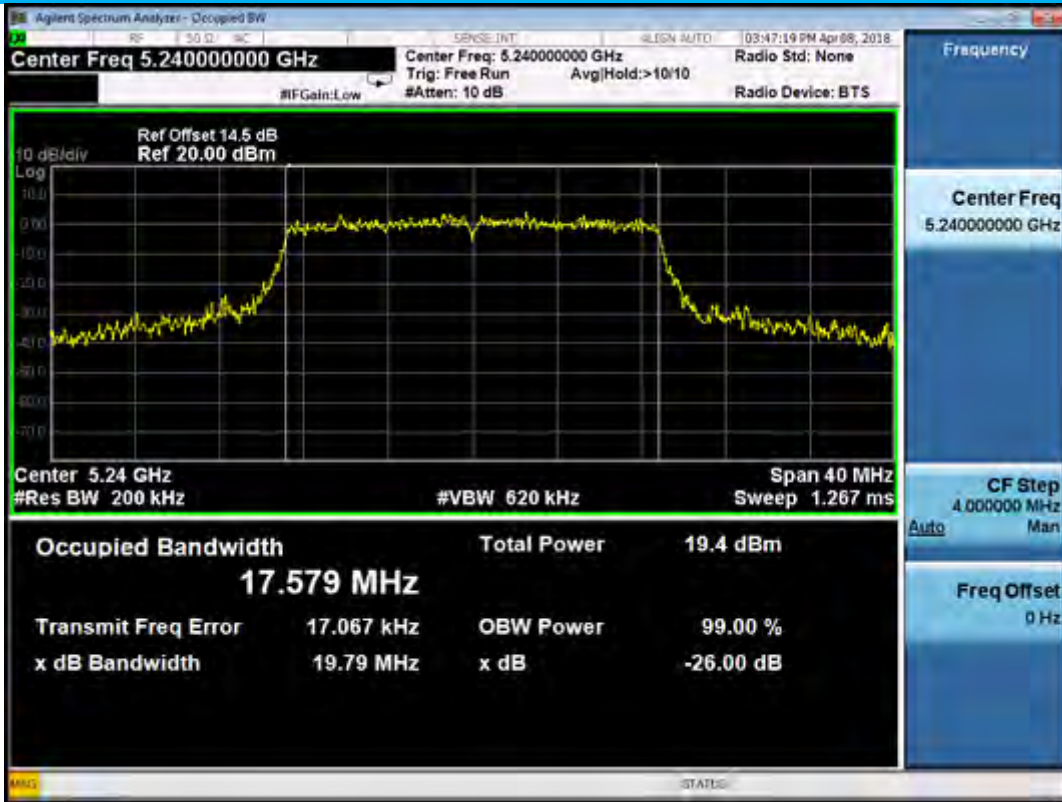

Emission Bandwidth&99% Occupied Bandwidth UNII Band III
 Test Model 802.11n(VHT20) mode Frequency(MHz) 5745



Emission Bandwidth&99% Occupied Bandwidth UNII Band III
 Test Model 802.11n(VHT20) mode Frequency(MHz) 5785

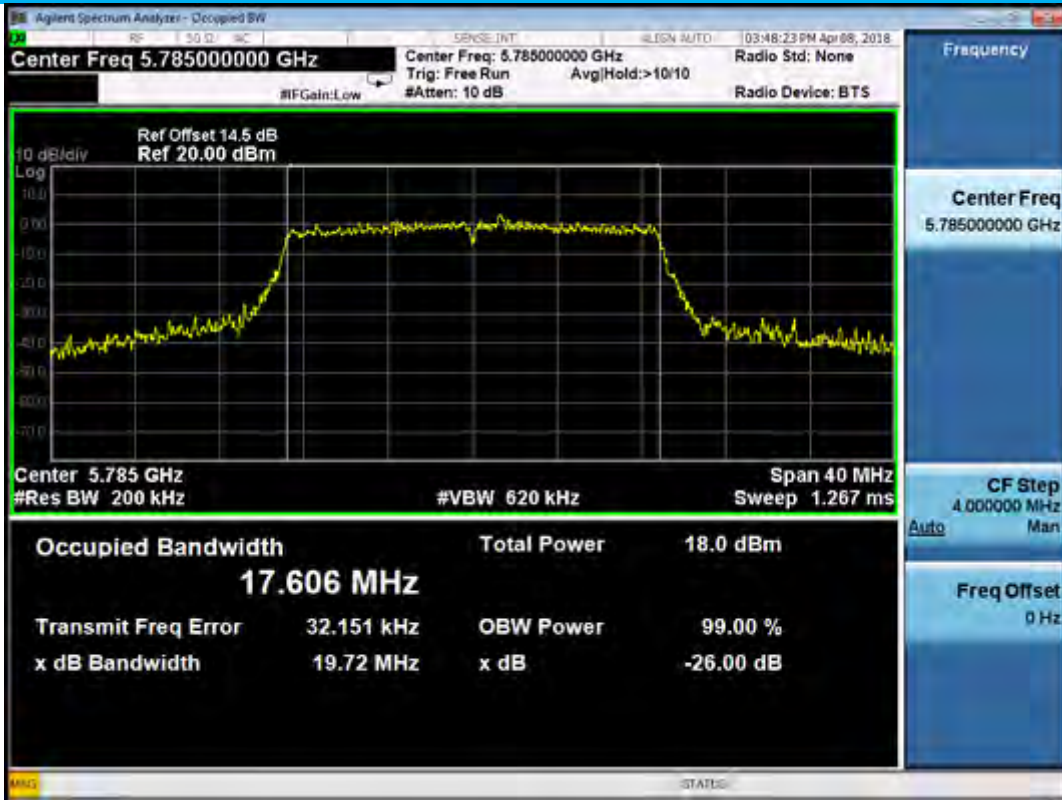

Emission Bandwidth&99% Occupied Bandwidth UNII Band III
 Test Model 802.11n(VHT20) mode Frequency(MHz) 5825



Emission Bandwidth&99% Occupied Bandwidth UNII Band I
 Test Model 802.11ac(VHT20) mode Frequency(MHz) 5180

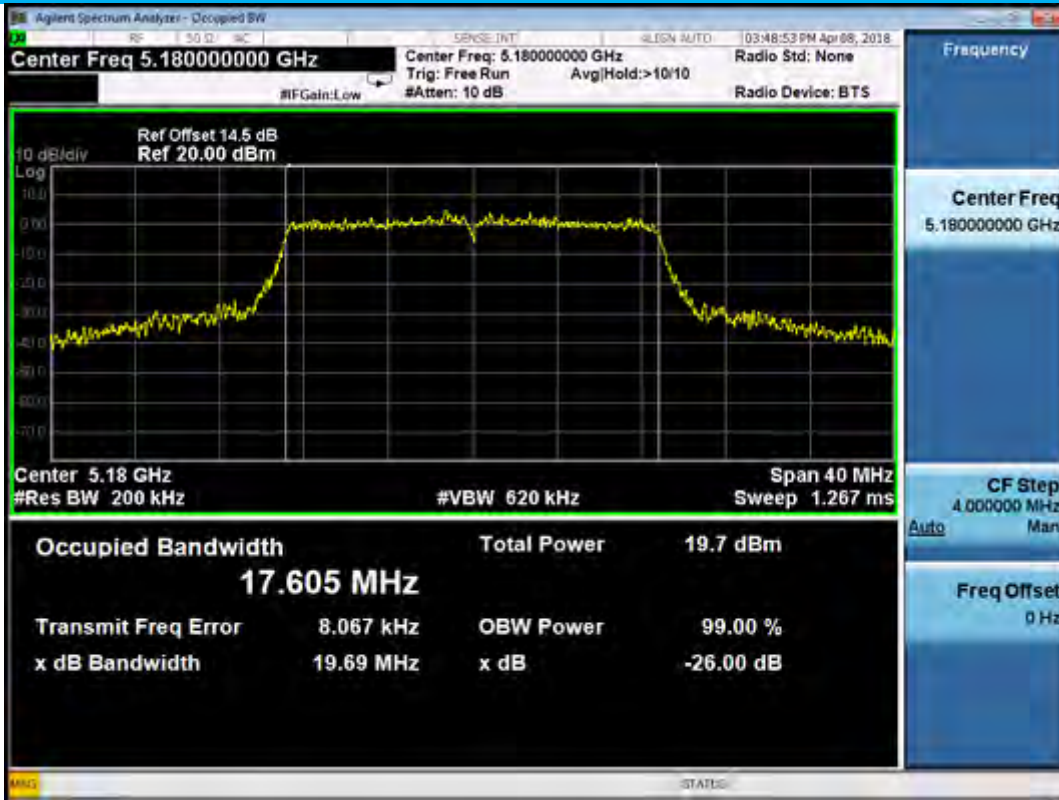

Emission Bandwidth&99% Occupied Bandwidth UNII Band I
 Test Model 802.11ac(VHT20) mode Frequency(MHz) 5200

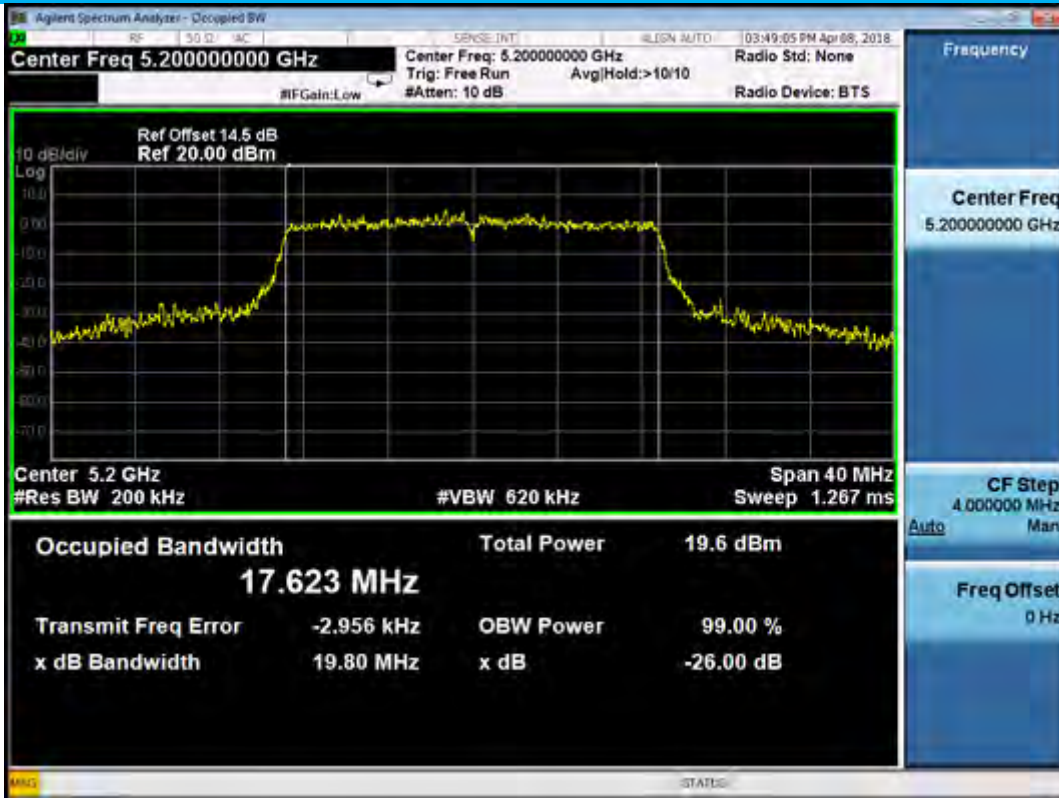

Emission Bandwidth&99% Occupied Bandwidth UNII Band I
 Test Model 802.11ac(VHT20) mode Frequency(MHz) 5240

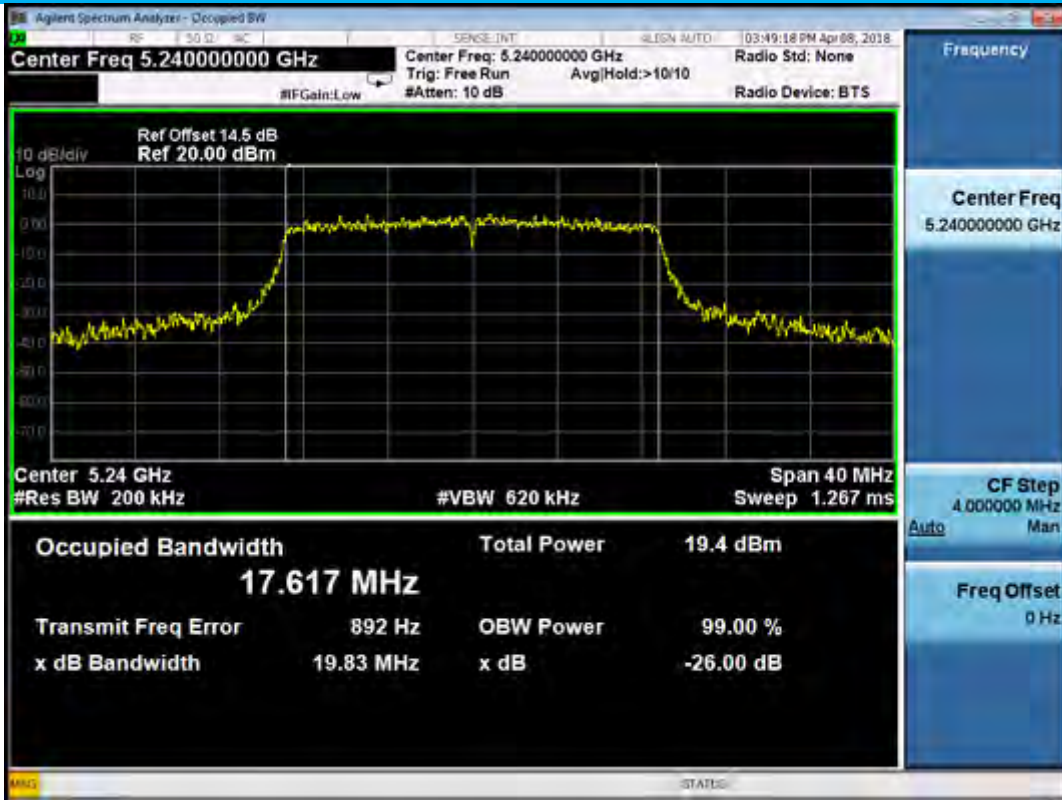

Emission Bandwidth&99% Occupied Bandwidth UNII Band III
 Test Model 802.11ac(VHT20) mode Frequency(MHz) 5745



Emission Bandwidth&99% Occupied Bandwidth UNII Band III
 Test Model 802.11ac(VHT20) mode Frequency(MHz) 5785

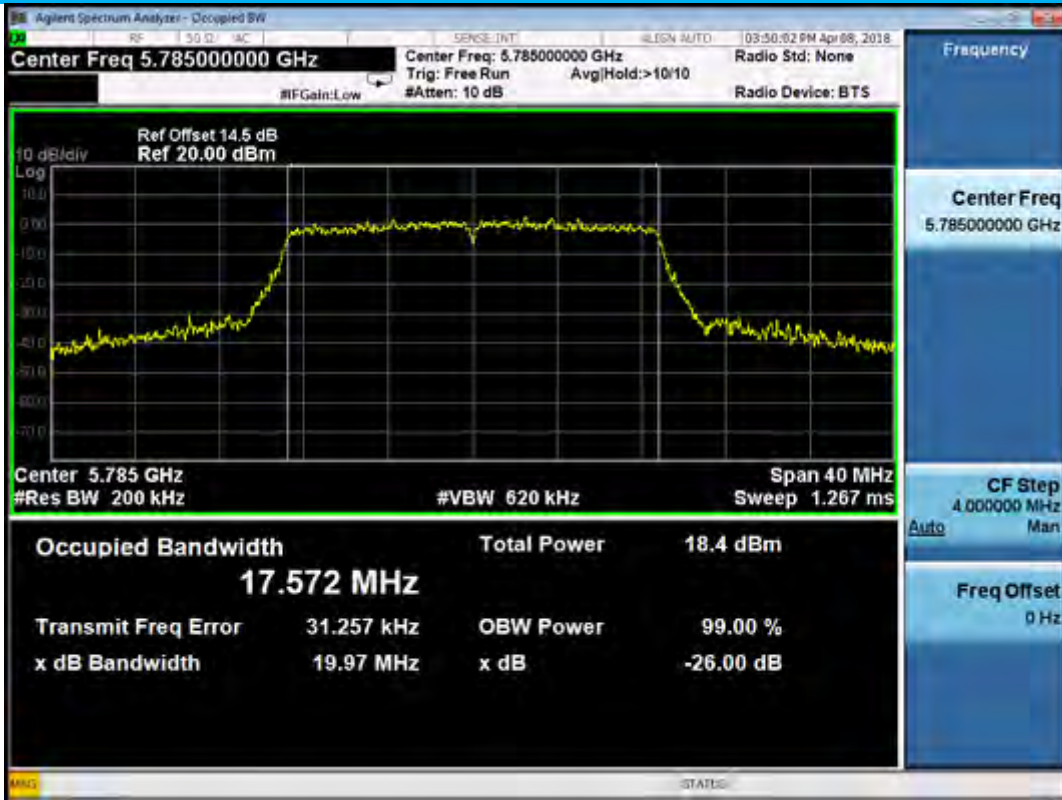

Emission Bandwidth&99% Occupied Bandwidth UNII Band III
 Test Model 802.11ac(VHT20) mode Frequency(MHz) 5825



Emission Bandwidth&99% Occupied Bandwidth UNII Band I
 Test Model 802.11n(VHT40) mode Frequency(MHz) 5190

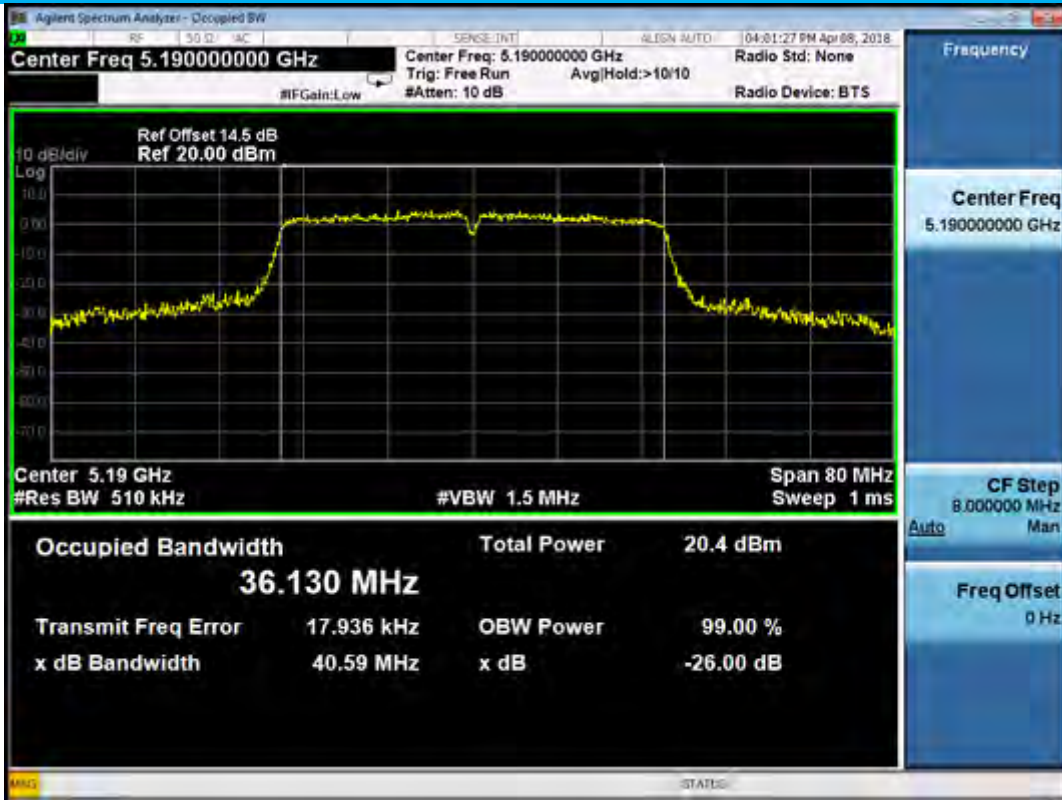

Emission Bandwidth&99% Occupied Bandwidth UNII Band I
 Test Model 802.11n(VHT40) mode Frequency(MHz) 5230



Emission Bandwidth&99% Occupied Bandwidth UNII Band III
 Test Model 802.11n(VHT40) mode Frequency(MHz) 5755

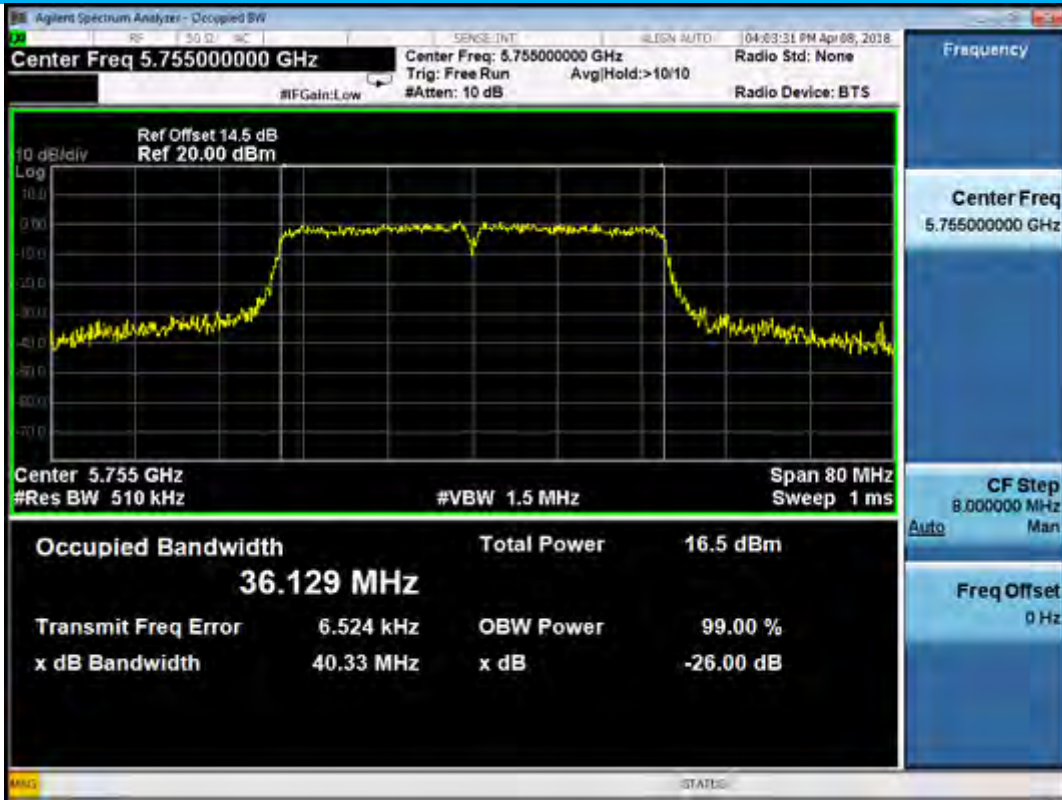

Emission Bandwidth&99% Occupied Bandwidth UNII Band III
 Test Model 802.11n(VHT40) mode Frequency(MHz) 5795

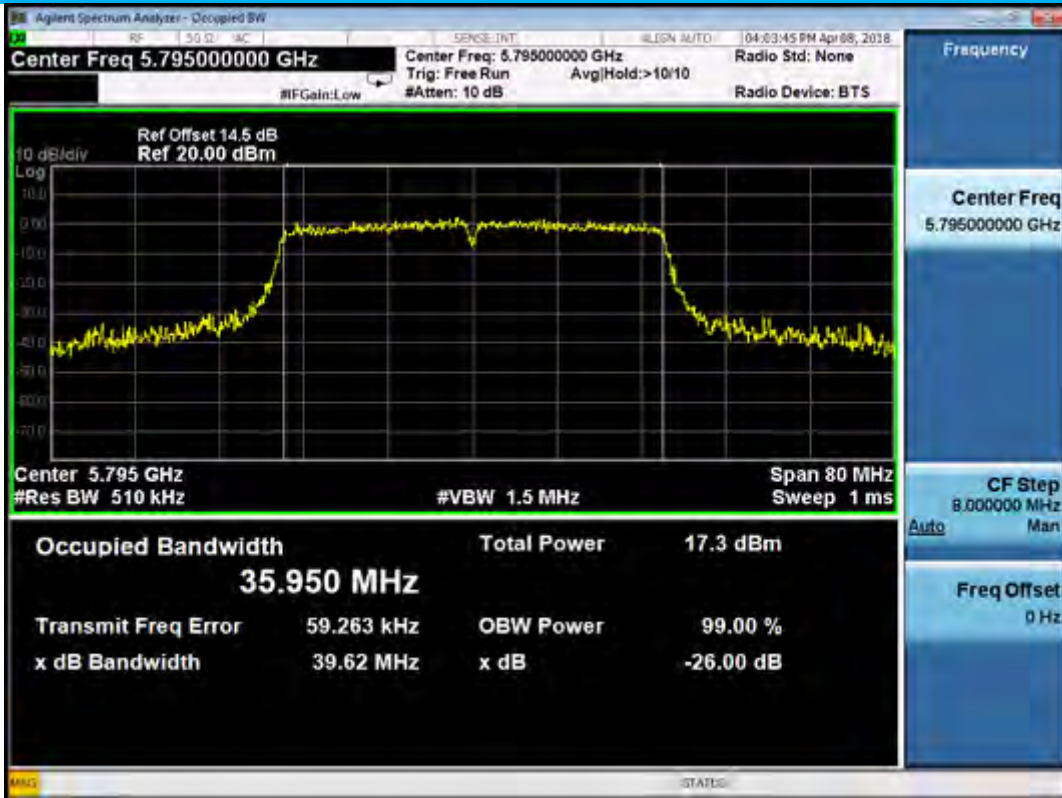

Emission Bandwidth&99% Occupied Bandwidth UNII Band I
 Test Model 802.11ac(VHT40) mode Frequency(MHz) 5190

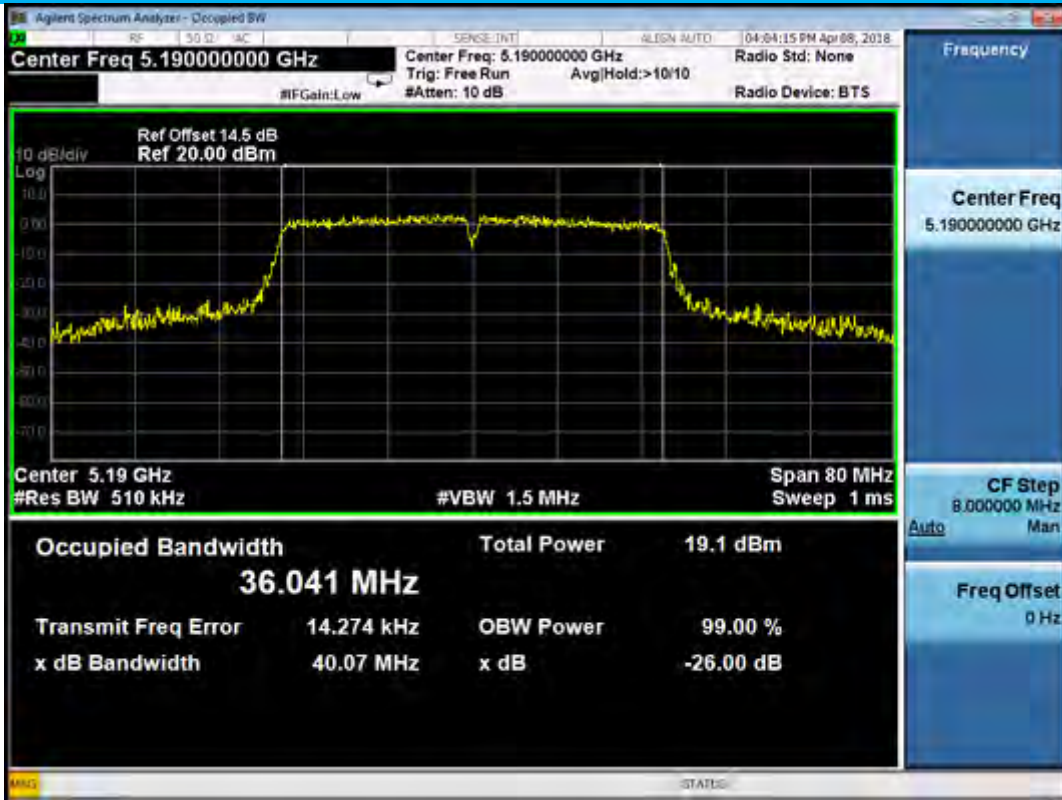

Emission Bandwidth&99% Occupied Bandwidth UNII Band I
 Test Model 802.11ac(VHT40) mode Frequency(MHz) 5230

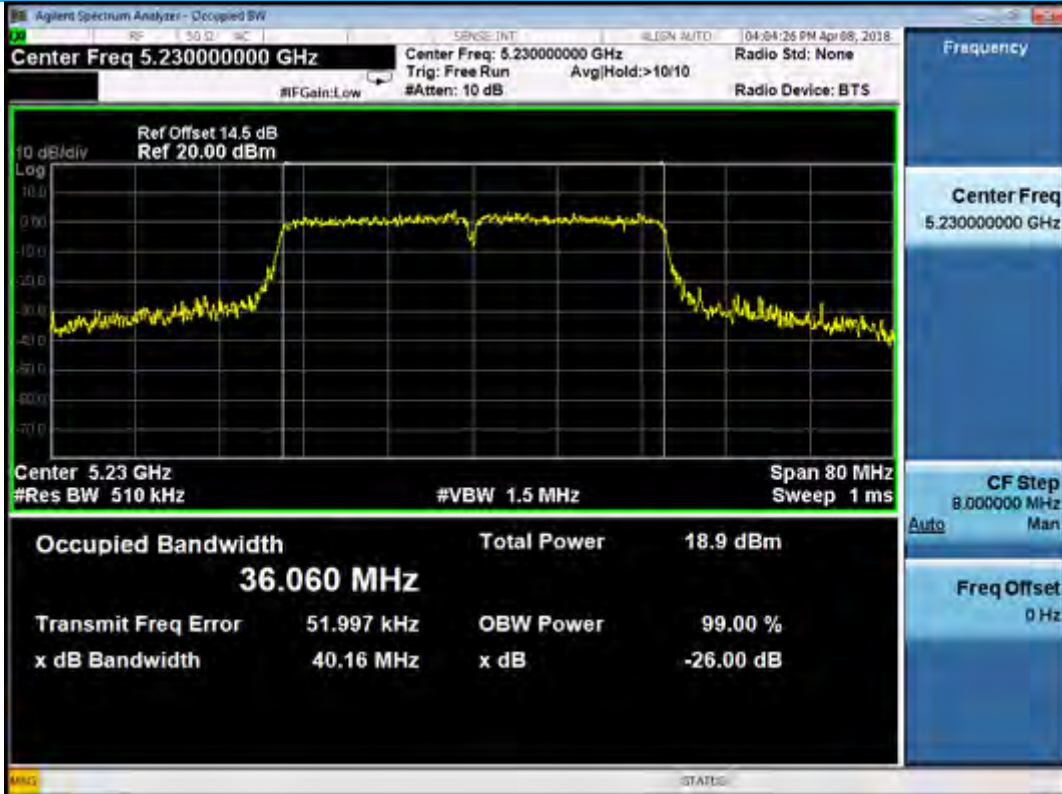

Emission Bandwidth&99% Occupied Bandwidth UNII Band III
 Test Model 802.11ac(VHT40) mode Frequency(MHz) 5755

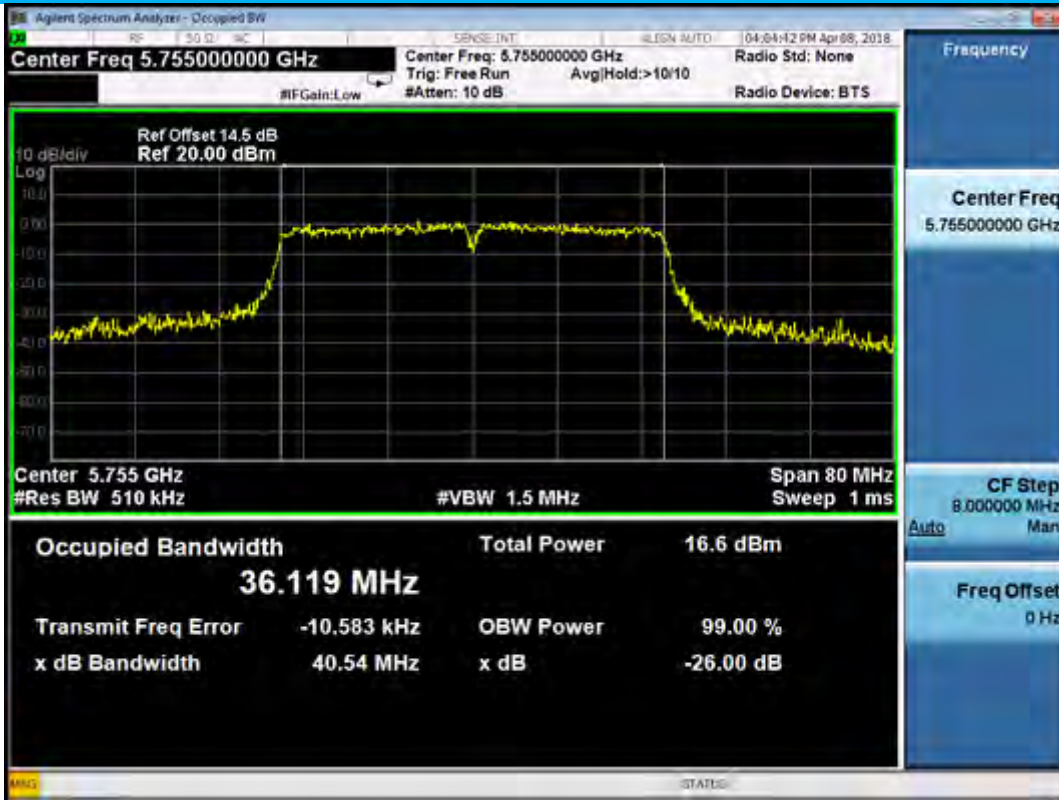

Emission Bandwidth&99% Occupied Bandwidth UNII Band III
 Test Model 802.11ac(VHT40) mode Frequency(MHz) 5795



Emission Bandwidth&99% Occupied Bandwidth UNII Band I
 Test Model 802.11ac(VHT80) mode Frequency(MHz) 5210

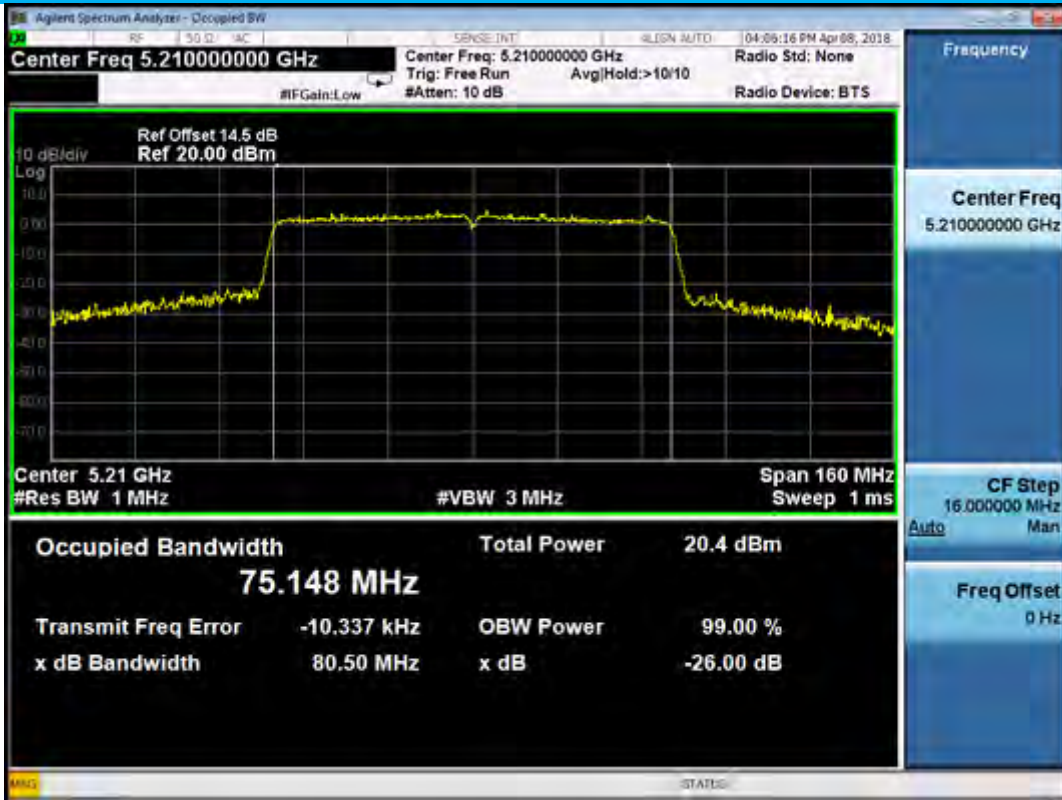

Emission Bandwidth&99% Occupied Bandwidth UNII Band III
 Test Model 802.11ac(VHT80) mode Frequency(MHz) 5775

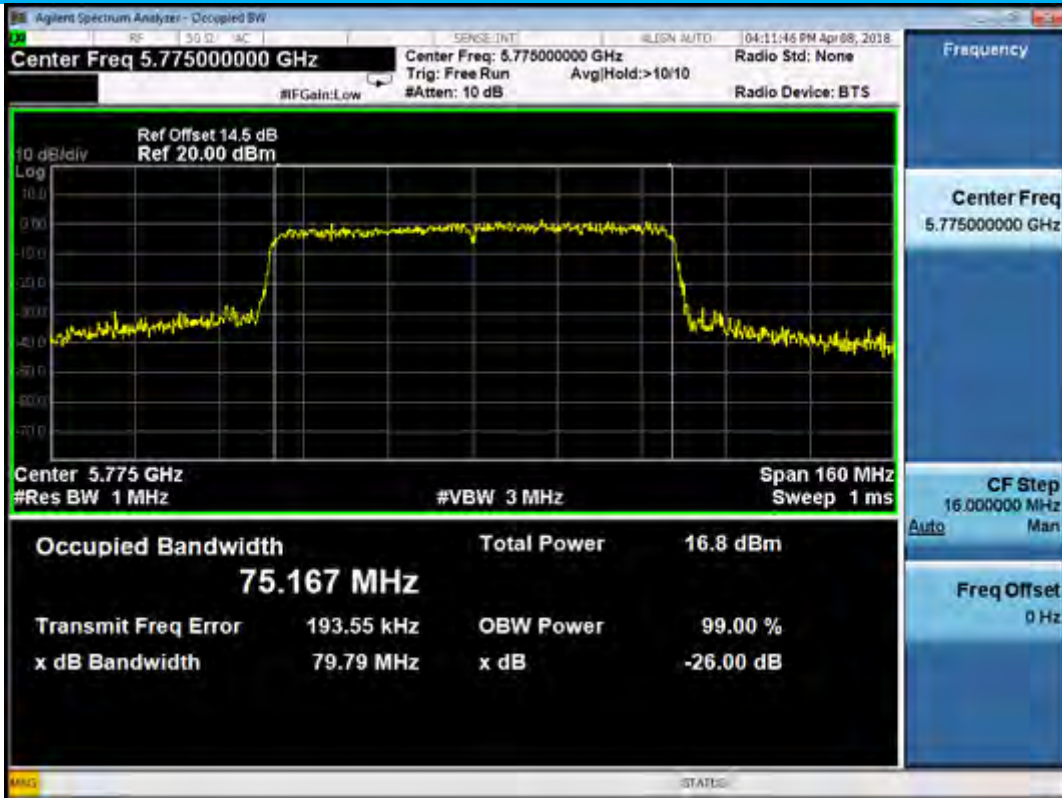

Minimum Emission Bandwidth
Test Model 802.11a mode

UNII Band III
Frequency(MHz) 5745

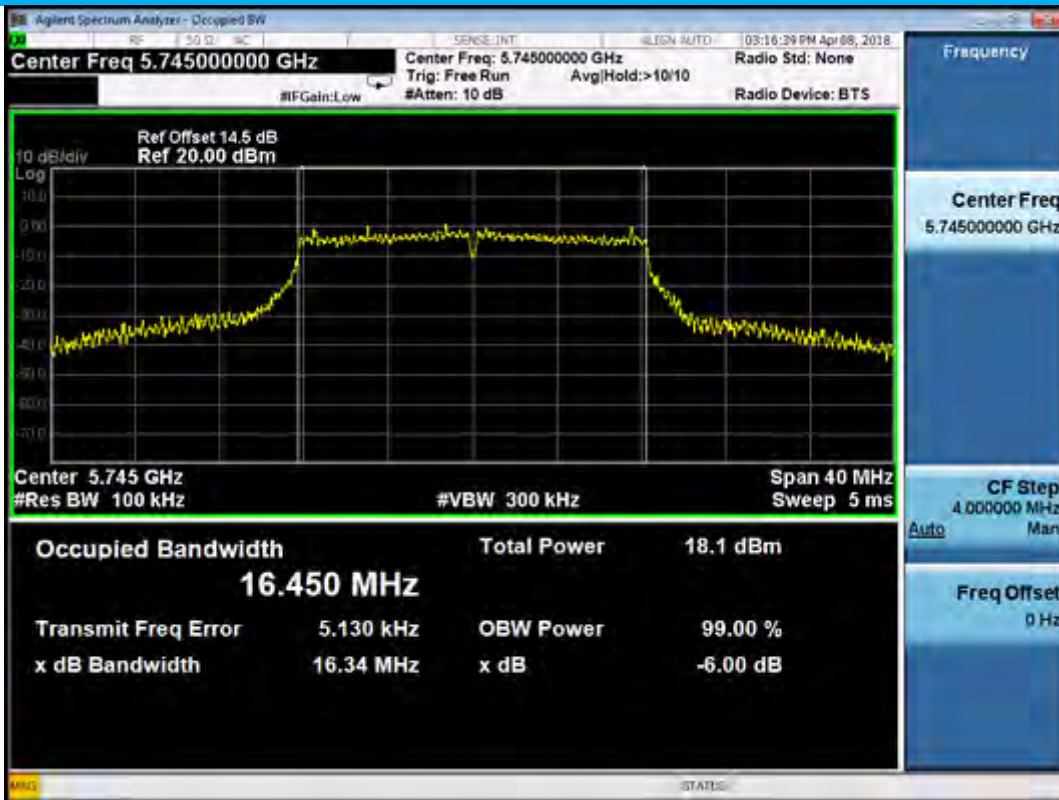

Minimum Emission Bandwidth
Test Model 802.11a mode

UNII Band III
Frequency(MHz) 5785

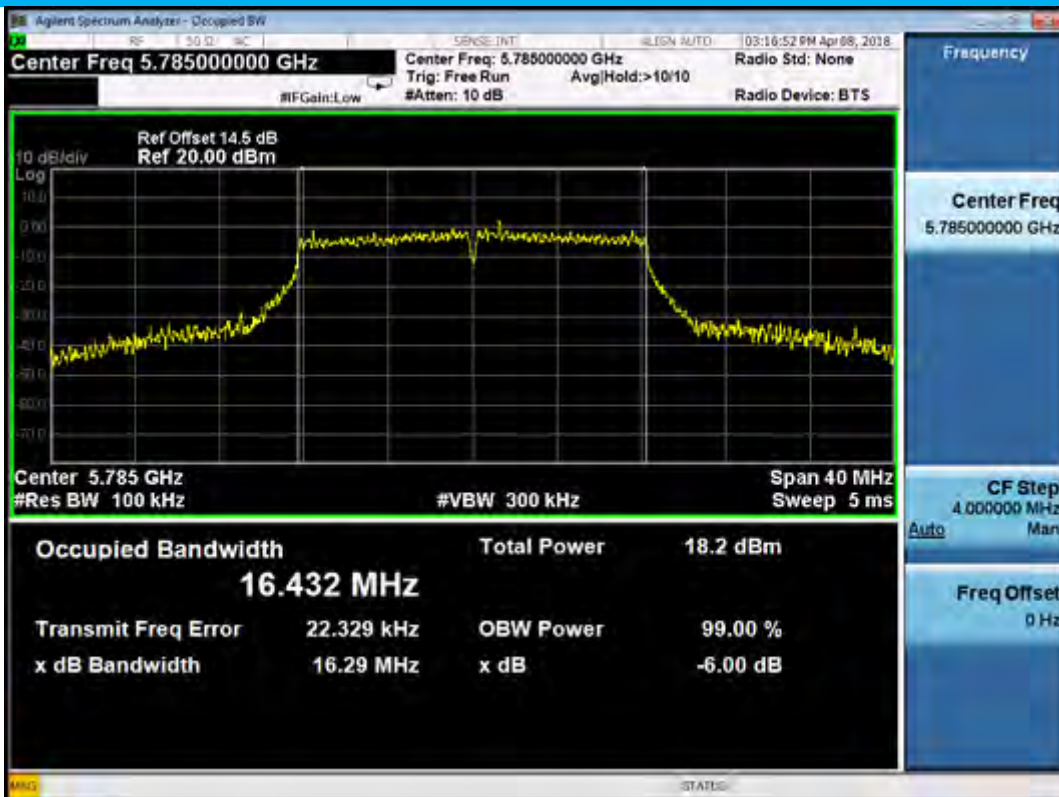

Minimum Emission Bandwidth
Test Model 802.11a mode

UNII Band III
Frequency(MHz) 5825

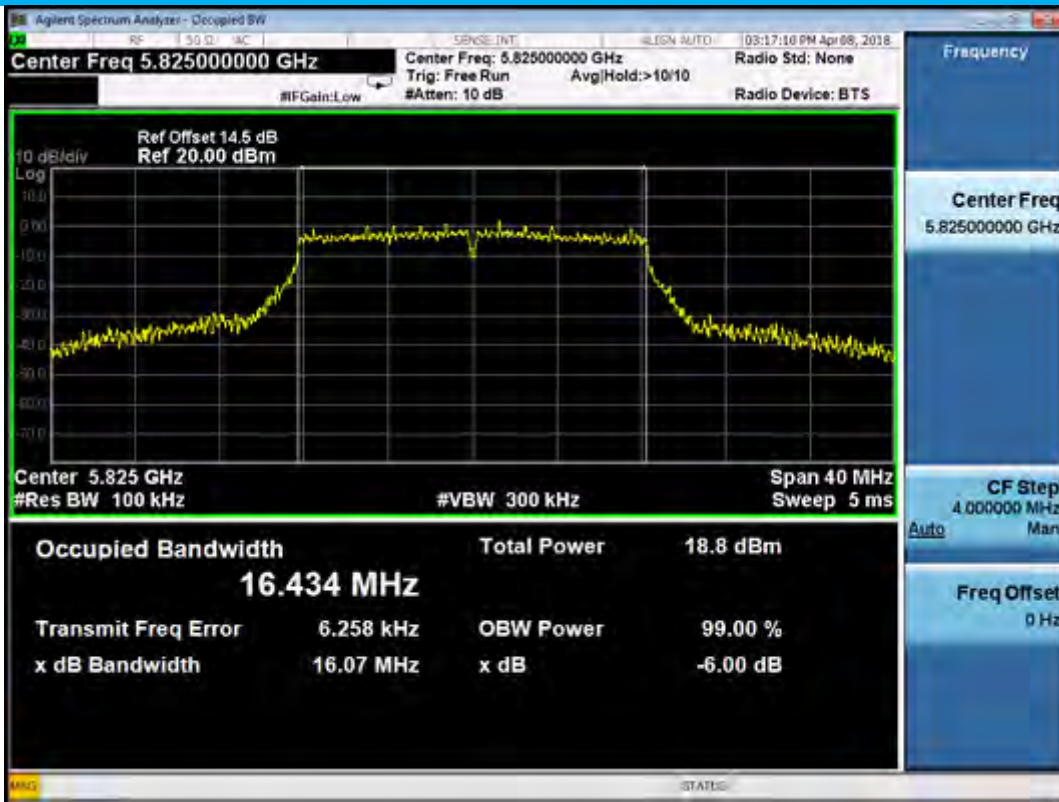

Minimum Emission Bandwidth
Test Model 802.11n(VHT20) mode

UNII Band III
Frequency(MHz) 5745

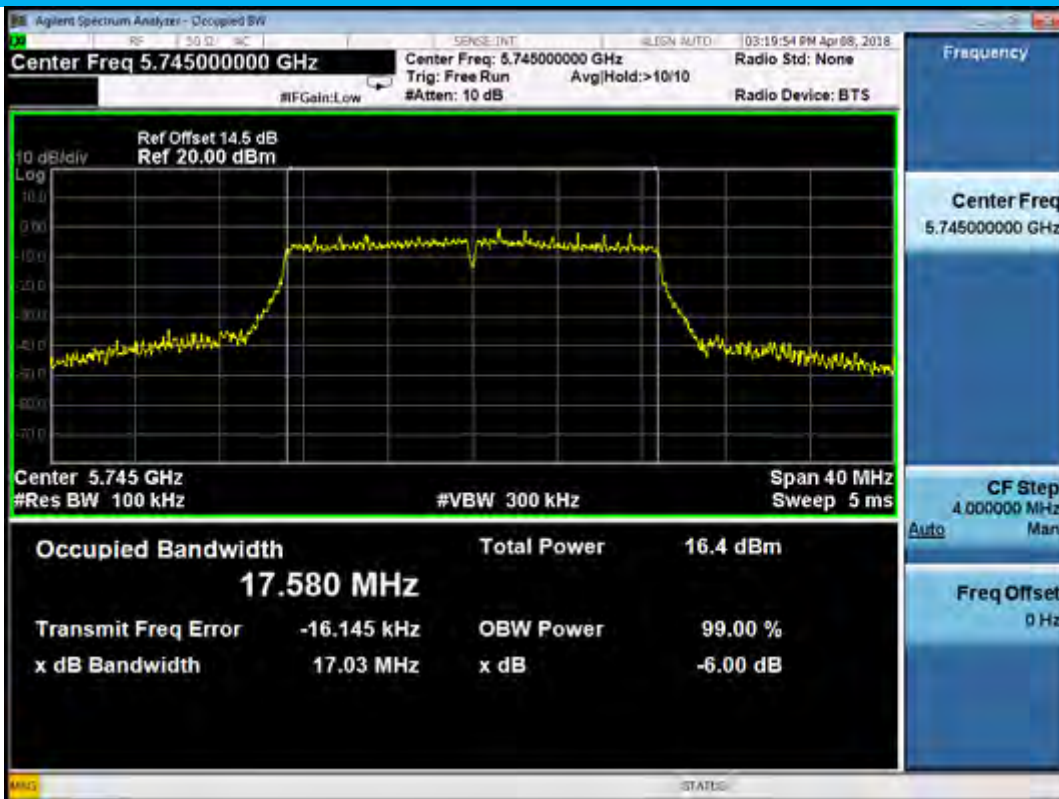

Minimum Emission Bandwidth UNII Band III
 Test Model 802.11n(VHT20) mode Frequency(MHz) 5785



Minimum Emission Bandwidth UNII Band III
 Test Model 802.11n(VHT20) mode Frequency(MHz) 5825



Minimum Emission Bandwidth UNII Band III
 Test Model 802.11ac(VHT20) mode Frequency(MHz) 5745



Minimum Emission Bandwidth UNII Band III
 Test Model 802.11ac(VHT20) mode Frequency(MHz) 5785



Minimum Emission Bandwidth UNII Band III
 Test Model 802.11ac(VHT20) mode Frequency(MHz) 5825

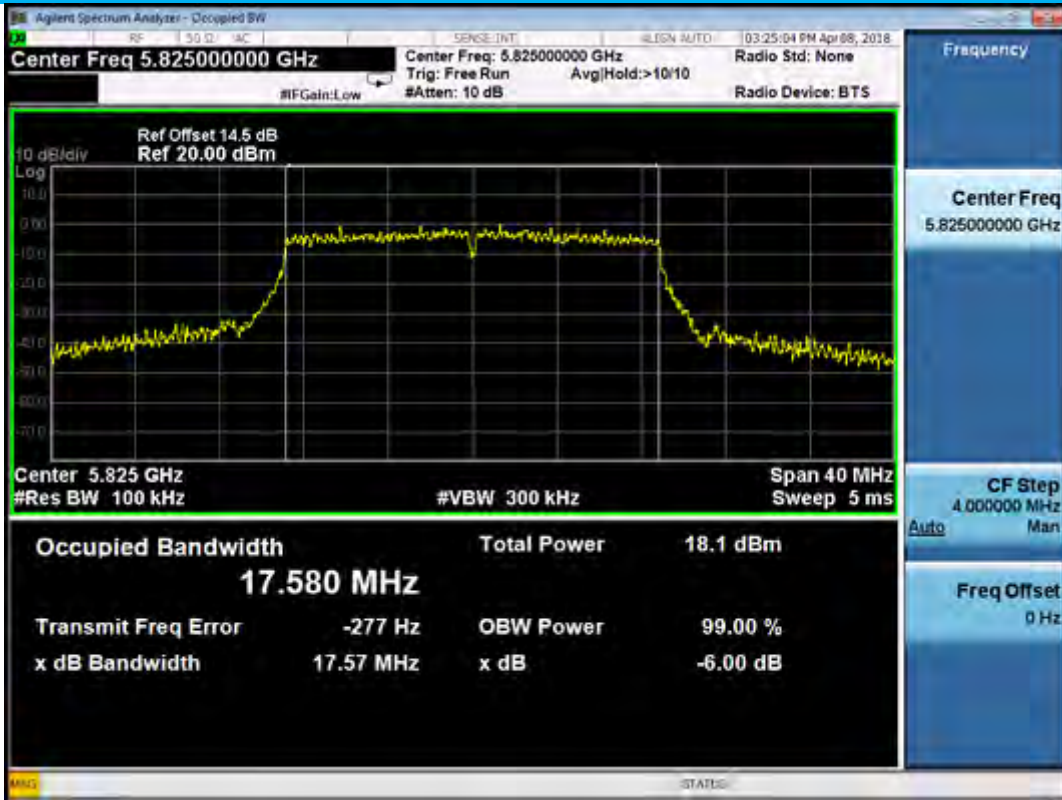

Minimum Emission Bandwidth UNII Band III
 Test Model 802.11n(VHT40) mode Frequency(MHz) 5755

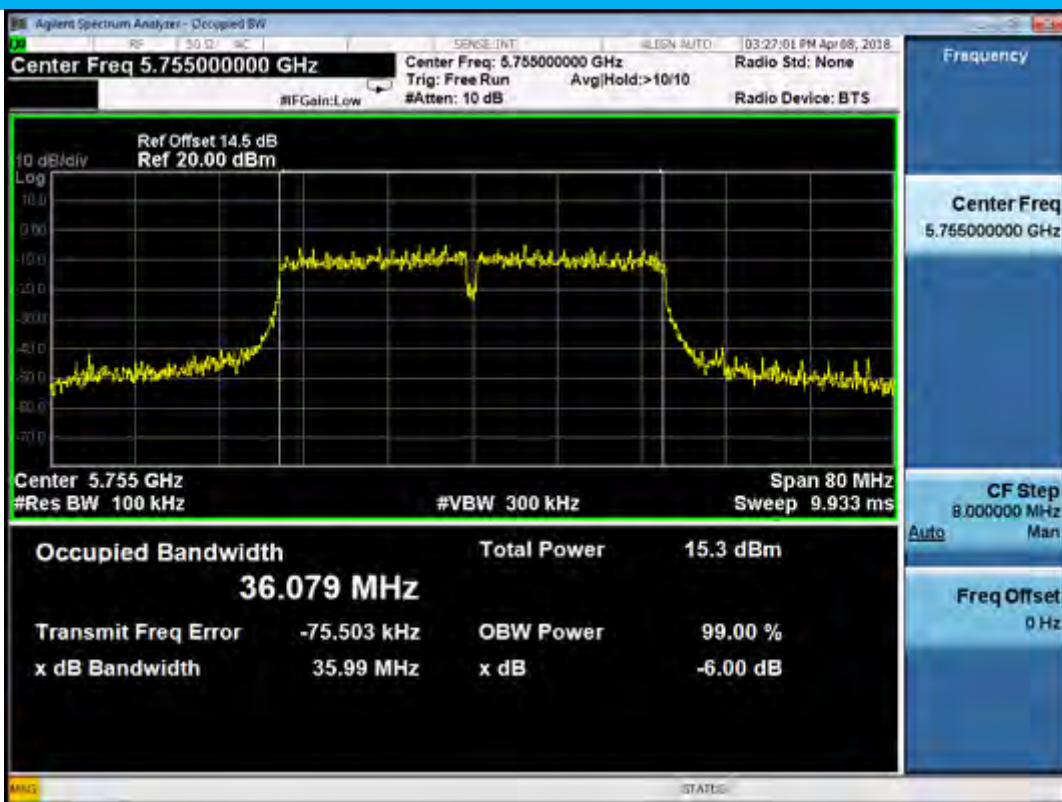

Minimum Emission Bandwidth UNII Band III
 Test Model 802.11n(VHT40) mode Frequency(MHz) 5795



Minimum Emission Bandwidth UNII Band III
 Test Model 802.11ac(VHT40) mode Frequency(MHz) 5755



Minimum Emission Bandwidth UNII Band III
 Test Model 802.11ac(VHT40) mode Frequency(MHz) 5795



Minimum Emission Bandwidth UNII Band III
 Test Model 802.11ac(VHT80) mode Frequency(MHz) 5775

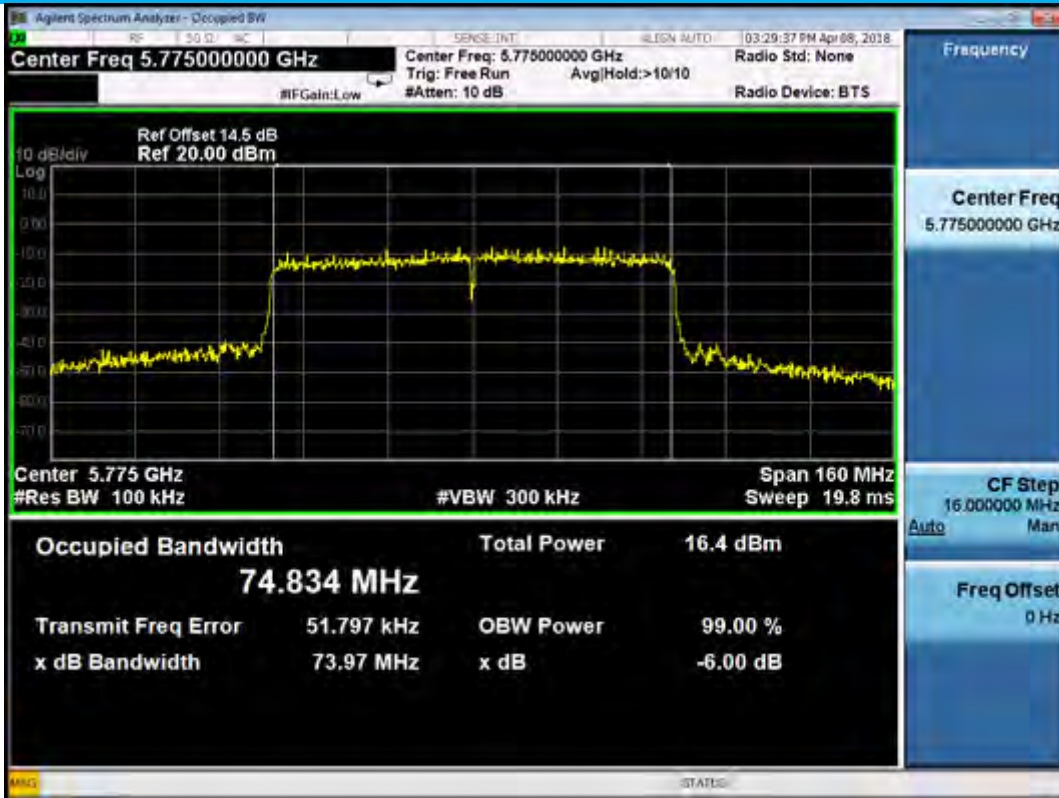

8.2 MAXIMUM CONDUCTED OUTPUT POWER

8.2.1 Applicable Standard

According to FCC Part 15.407(a)(1) for UNII Band I

According to FCC Part 15.407(a)(2) for UNII Band II-A and UNII Band II-C

According to FCC Part 15.407(a)(3) for UNII Band III

According to 789033 D02 Section II(E)

8.2.2 Conformance Limit

■ For the band 5.15-5.25 GHz,

(a) (1) (i) For an outdoor access point operating in the band 5.15-5.25 GHz, the maximum conducted output power over the frequency band of operation shall not exceed 1 W provided the maximum antenna gain does not exceed 6 dBi. If transmitting antennas of directional gain greater than 6 dBi are used, both the maximum conducted output power and the maximum power spectral density shall be reduced by the amount in dB that the directional gain of the antenna exceeds 6 dBi. The maximum e.i.r.p. at any elevation angle above 30 degrees as measured from the horizon must not exceed 125 mW (21 dBm).

(a) (1) (ii) For an indoor access point operating in the band 5.15-5.25 GHz, the maximum conducted output power over the frequency band of operation shall not exceed 1 W provided the maximum antenna gain does not exceed 6 dBi. If transmitting antennas of directional gain greater than 6 dBi are used, both the maximum conducted output power and the maximum power spectral density shall be reduced by the amount in dB that the directional gain of the antenna exceeds 6 dBi.

(a) (1) (iii) For fixed point-to-point access points operating in the band 5.15-5.25 GHz, the maximum conducted output power over the frequency band of operation shall not exceed 1 W. Fixed point-to-point U-NII devices may employ antennas with directional gain up to 23 dBi without any corresponding reduction in the maximum conducted output power or maximum power spectral density. For fixed point-to-point transmitters that employ a directional antenna gain greater than 23 dBi, a 1 dB reduction in maximum conducted output power and maximum power spectral density is required for each 1 dB of antenna gain in excess of 23 dBi. Fixed, point-to-point operations exclude the use of point-to-multipoint systems, omnidirectional applications, and multiple collocated transmitters transmitting the same information. The operator of the U-NII device, or if the equipment is professionally installed, the installer, is responsible for ensuring that systems employing high gain directional antennas are used exclusively for fixed, point-to-point operations.

(a) (1) (iv) For mobile and portable client devices in the 5.15-5.25 GHz band, the maximum conducted output power over the frequency band of operation shall not exceed 250 mW provided the maximum antenna gain does not exceed 6 dBi. If transmitting antennas of directional gain greater than 6 dBi are used, both the maximum conducted output power and the maximum power spectral density shall be reduced by the amount in dB that the directional gain of the antenna exceeds 6 dBi.

■ For the 5.25-5.35 GHz and 5.47-5.725 GHz bands

(a) (2) the maximum conducted output power over the frequency bands of operation shall not exceed the lesser of 250 mW or $11 \text{ dBm} + 10 \log B$, where B is the 26 dB emission bandwidth in megahertz. In addition, the maximum power spectral density shall not exceed 11 dBm in any 1 megahertz band. If transmitting antennas of directional gain greater than 6 dBi are used, both the maximum conducted output power and the maximum power spectral density shall be reduced by the amount in dB that the directional gain of the antenna exceeds 6 dBi.

■ For the band 5.725-5.85 GHz

(a) (3) For the band 5.725-5.85 GHz, the maximum conducted output power over the frequency band of operation shall not exceed 1 W. In addition, the maximum power spectral density shall not exceed 30 dBm in any 500-kHz band. If transmitting antennas of directional gain greater than 6 dBi are used, both the maximum conducted output power and the maximum power spectral density shall be reduced by the amount in dB that the directional gain of the antenna exceeds 6 dBi.

8.2.3 Test Configuration

Test according to clause 6.1 radio frequency test setup

8.2.4 Test Procedure

The maximum average conducted output power can be measured using Method PM-G (Measurement using a gated RF average power meter):

Measurements may be performed using a wideband gated RF power meter provided that the gate parameters are adjusted such that the power is measured only when the EUT is transmitting at its maximum power control level. Since the measurement is made only during the ON time of the transmitter, no duty cycle correction factor is required.

- a. The Transmitter output (antenna port) was connected to the power meter.
- b. Turn on the EUT and power meter and then record the power value.
- c. Repeat above procedures on all channels needed to be tested.

8.2.5 Test Results

<input checked="" type="checkbox"/> 802.11a mode						
Temperature :		28°C	Test Date :		April 08,2018	
Humidity :		65 %	Test By:		King Kong	
Band	Channel Number	Channel Freq. (MHz)	Conducted Output Power(dBm)		Limit (dBm)	Verdict
			Ant0	Ant1		
UNII Band I	CH36	5180	17.31	12.43	24	Pass
	CH40	5200	17.40	12.30	24	Pass
	CH48	5240	17.23	14.42	24	Pass
UNII Band III	CH149	5745	13.97	15.45	30	Pass
	CH157	5785	14.45	15.40	30	Pass
	CH165	5825	14.55	15.55	30	Pass
Note: N/A (Not Applicable)						

<input checked="" type="checkbox"/> 802.11n(VHT20) mode							
Temperature :		28°C	Test Date :		April 08,2018		
Humidity :		65 %	Test By:		King Kong		
Band	Channel Number	Channel Freq. (MHz)	Conducted Output Power(dBm)			Limit (dBm)	Verdict
			Ant0	Ant1	Ant0+1		
UNII Band I	CH36	5180	15.76	10.93	16.99	21.97	Pass
	CH40	5200	15.82	10.82	17.01	21.97	Pass
	CH48	5240	15.47	12.57	17.27	21.97	Pass
UNII Band III	CH149	5745	12.66	13.32	16.01	27.99	Pass
	CH157	5785	12.77	13.58	16.20	27.99	Pass
	CH165	5825	12.84	13.73	16.32	27.99	Pass
Note: N/A (Not Applicable)							

802.11ac(VHT20) mode

Temperature : 28°C Test Date : April 08,2018
Humidity : 65 % Test By: King Kong

Band	Channel Number	Channel Freq. (MHz)	Conducted Output Power(dBm)			Limit (dBm)	Verdict
			Ant0	Ant1	Ant0+1		
UNII Band I	CH36	5180	15.84	10.64	16.99	21.99	Pass
	CH40	5200	15.87	10.22	16.92	21.99	Pass
	CH48	5240	15.40	12.59	17.23	21.99	Pass
UNII Band III	CH149	5745	12.57	13.39	16.01	27.99	Pass
	CH157	5785	13.10	13.66	16.40	27.99	Pass
	CH165	5825	13.17	13.81	16.51	27.99	Pass

Note:
N/A (Not Applicable)

802.11n(VHT40) mode

Temperature : 28°C Test Date : April 08,2018
Humidity : 65 % Test By: King Kong

Band	Channel Number	Channel Freq. (MHz)	Conducted Output Power(dBm)			Limit (dBm)	Verdict
			Ant0	Ant1	Ant0+1		
UNII Band I	CH38	5190	15.25	10.14	16.41	21.99	Pass
	CH46	5230	15.22	11.96	16.90	21.99	Pass
UNII Band III	CH151	5755	11.98	12.97	15.51	27.99	Pass
	CH159	5795	12.59	13.28	15.96	27.99	Pass

Note:
N/A (Not Applicable)

802.11ac(VHT40) mode

Temperature : 28°C Test Date : April 08,2018
Humidity : 65 % Test By: King Kong

Band	Channel Number	Channel Freq. (MHz)	Conducted Output Power(dBm)			Limit (MHz)	Verdict
			Ant0	Ant1	Ant0+1		
UNII Band I	CH38	5190	15.16	10.10	16.34	21.99	Pass
	CH46	5230	15.07	11.94	16.80	21.99	Pass
UNII Band III	CH151	5755	11.83	12.90	15.41	27.99	Pass
	CH159	5795	12.54	13.26	15.93	27.99	Pass

Note:
N/A (Not Applicable)

802.11ac(VHT80) mode

Temperature : 28°C Test Date : April 08,2018
Humidity : 65 % Test By: King Kong

Band	Channel Number	Channel Freq. (MHz)	Conducted Output Power(dBm)			Limit (dBm)	Verdict
			Ant0	Ant1	Ant0+1		
UNII Band I	CH42	5210	13.89	9.54	15.25	21.99	Pass
UNII Band III	CH155	5775	11.34	12.18	14.79	27.99	Pass

Note:
N/A (Not Applicable)

8.3 MAXIMUM PEAK POWER DENSITY

8.3.1 Applicable Standard

According to FCC Part 15.407(a)(1) for UNII Band I
According to FCC Part 15.407(a)(2) for UNII Band II-A and UNII Band II-C
According to FCC Part 15.407(a)(3) for UNII Band III
According to 789033 D02 Section II(F)

8.3.2 Conformance Limit

■ For the band 5.15-5.25 GHz,

(a) (1) (i) For an outdoor access point operating in the band 5.15-5.25 GHz, the maximum conducted output power over the frequency band of operation shall not exceed 1 W provided the maximum antenna gain does not exceed 6 dBi. If transmitting antennas of directional gain greater than 6 dBi are used, both the maximum conducted output power and the maximum power spectral density shall be reduced by the amount in dB that the directional gain of the antenna exceeds 6 dBi. The maximum e.i.r.p. at any elevation angle above 30 degrees as measured from the horizon must not exceed 125 mW (21 dBm).

(a) (1) (ii) For an indoor access point operating in the band 5.15-5.25 GHz, the maximum conducted output power over the frequency band of operation shall not exceed 1 W provided the maximum antenna gain does not exceed 6 dBi. If transmitting antennas of directional gain greater than 6 dBi are used, both the maximum conducted output power and the maximum power spectral density shall be reduced by the amount in dB that the directional gain of the antenna exceeds 6 dBi.

(a) (1) (iii) For fixed point-to-point access points operating in the band 5.15-5.25 GHz, the maximum conducted output power over the frequency band of operation shall not exceed 1 W. Fixed point-to-point U-NII devices may employ antennas with directional gain up to 23 dBi without any corresponding reduction in the maximum conducted output power or maximum power spectral density. For fixed point-to-point transmitters that employ a directional antenna gain greater than 23 dBi, a 1 dB reduction in maximum conducted output power and maximum power spectral density is required for each 1 dB of antenna gain in excess of 23 dBi. Fixed, point-to-point operations exclude the use of point-to-multipoint systems, omnidirectional applications, and multiple collocated transmitters transmitting the same information. The operator of the U-NII device, or if the equipment is professionally installed, the installer, is responsible for ensuring that systems employing high gain directional antennas are used exclusively for fixed, point-to-point operations.

(a) (1) (iv) For mobile and portable client devices in the 5.15-5.25 GHz band, the maximum conducted output power over the frequency band of operation shall not exceed 250 mW provided the maximum antenna gain does not exceed 6 dBi. If transmitting antennas of directional gain greater than 6 dBi are used, both the maximum conducted output power and the maximum power spectral density shall be reduced by the amount in dB that the directional gain of the antenna exceeds 6 dBi.

■ For the 5.25-5.35 GHz and 5.47-5.725 GHz bands

(b) (2) the maximum conducted output power over the frequency bands of operation shall not exceed the lesser of 250 mW or $11 \text{ dBm} + 10 \log B$, where B is the 26 dB emission bandwidth in megahertz. In addition, the maximum power spectral density shall not exceed 11 dBm in any 1 megahertz band. If transmitting antennas of directional gain greater than 6 dBi are used, both the maximum conducted output power and the maximum power spectral density shall be reduced by the amount in dB that the directional gain of the antenna exceeds 6 dBi.

■ For the band 5.725-5.85 GHz

(a) (3) For the band 5.725-5.85 GHz, the maximum conducted output power over the frequency band of operation shall not exceed 1 W. In addition, the maximum power spectral density shall not exceed 30 dBm in any 500-kHz band. If transmitting antennas of directional gain greater than 6 dBi are used, both the maximum conducted output power and the maximum power spectral density shall be reduced by the amount in dB that the directional gain of the antenna exceeds 6 dBi.

8.3.3 Test Configuration

Test according to clause 6.1 radio frequency test setup

8.3.4 Test Procedure

Methods refer to FCC KDB 789033

- 1) Create an average power spectrum for the EUT operating mode being tested by following the instructions in section E)2) for measuring maximum conducted output power using a spectrum analyzer or EMI receiver: select the appropriate test method (SA-3, or alternatives to each) and apply it up to, but not including, the step labeled, "Compute power...".
- 2) Use the peak search function on the instrument to find the peak of the spectrum.
- 3) The result is the PPSD.
- 4) The above procedures make use of 500kHz resolution bandwidth to satisfy the 500kHz measurement bandwidth specified in the 15.407(a)(5). That rule section also permits use of resolution bandwidths less than 1 MHz "provided that the measured power is integrated to show the total power over the measurement bandwidth" (i.e., 1 MHz). If measurements are performed using a reduced resolution bandwidth and integrated over 500kHz bandwidth.

8.3.5 Test Results

802.11a mode

Temperature : 28°C Test Date : April 08,2018
 Humidity : 65 % Test By: King Kong

Band	Channel Number	Channel Freq. (MHz)	Power Spectral Density		Limit	Verdict
			Ant0	Ant1		
UNII Band I	CH36	5180	5.39	-0.07	≤11dBm/1MHz	Pass
	CH40	5200	4.57	0.59	≤11dBm/1MHz	Pass
	CH48	5240	5.12	2.05	≤11dBm/1MHz	Pass
UNII Band III	CH149	5745	0.30	0.10	≤30dBm/500KHz	Pass
	CH157	5785	0.41	0.39	≤30dBm/500KHz	Pass
	CH165	5825	0.55	1.09	≤30dBm/500KHz	Pass
Note: N/A (Not Applicable)						

802.11n(VHT20) mode

Temperature : 28°C Test Date : April 08,2018
 Humidity : 65 % Test By: King Kong

Band	Channel Number	Channel Freq. (MHz)	Power Spectral Density			Limit	Verdict
			Ant0	Ant1	Ant0+1		
UNII Band I	CH36	5180	3.51	-1.88	3.58	≤8.99dBm/1MHz	Pass
	CH40	5200	3.03	-2.22	3.07	≤8.99dBm/1MHz	Pass
	CH48	5240	3.56	0.01	3.56	≤8.99dBm/1MHz	Pass
UNII Band III	CH149	5745	-1.81	-1.99	-1.64	≤27.99dBm/500KHz	Pass
	CH157	5785	-1.62	-1.61	-1.01	≤27.99dBm/500KHz	Pass
	CH165	5825	-1.76	-1.79	-1.48	≤27.99dBm/500KHz	Pass
Note: N/A (Not Applicable)							

802.11ac(VHT20) mode

Temperature : 28°C Test Date : April 08,2018
Humidity : 65 % Test By: King Kong

Band	Channel Number	Channel Freq. (MHz)	Power Spectral Density			Limit	Verdict
			Ant0	Ant1	Ant0+1		
UNII Band I	CH36	5180	3.26	-1.46	3.77	≤8.99dBm/1MHz	Pass
	CH40	5200	3.09	-1.47	5.53	≤8.99dBm/1MHz	Pass
	CH48	5240	2.97	0.41	5.43	≤8.99dBm/1MHz	Pass
UNII Band III	CH149	5745	-2.21	-1.44	0.05	≤27.99dBm/500KHz	Pass
	CH157	5785	-1.52	-1.68	0.51	≤27.99dBm/500KHz	Pass
	CH165	5825	-1.43	-1.82	0.27	≤27.99dBm/500KHz	Pass

Note:
N/A (Not Applicable)

802.11n(VHT40) mode

Temperature : 28°C Test Date : April 08,2018
Humidity : 65 % Test By: King Kong

Band	Channel Number	Channel Freq. (MHz)	Power Spectral Density			Limit	Verdict
			Ant0	Ant1	Ant0+1		
UNII Band I	CH38	5190	-0.05	-4.74	-0.07	≤8.99dBm/1MHz	Pass
	CH46	5230	-0.62	-3.44	0.58	≤8.99dBm/1MHz	Pass
UNII Band III	CH151	5755	-5.99	-4.90	-5.34	≤27.99dBm/500KHz	Pass
	CH159	5795	-4.93	-4.39	-4.65	≤27.99dBm/500KHz	Pass

Note:
N/A (Not Applicable)

Power Spectral Density	UNII Band I
Test Model 802.11a	Frequency(MHz) 5180

Ant0

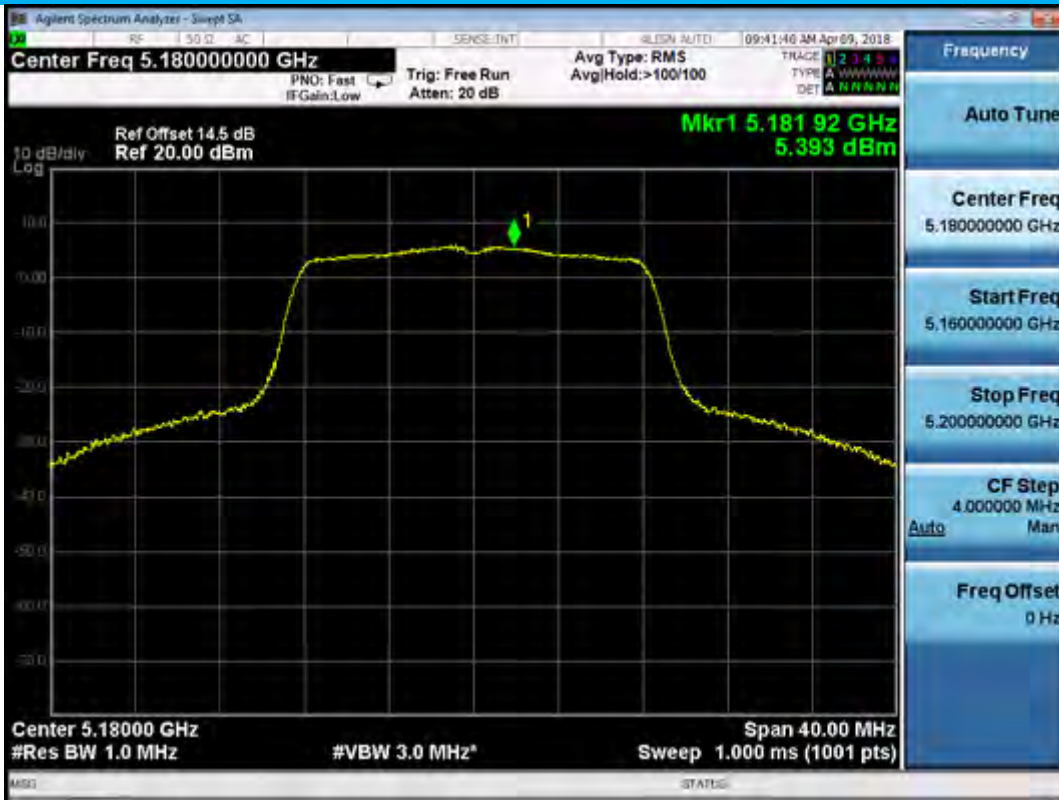

Ant1

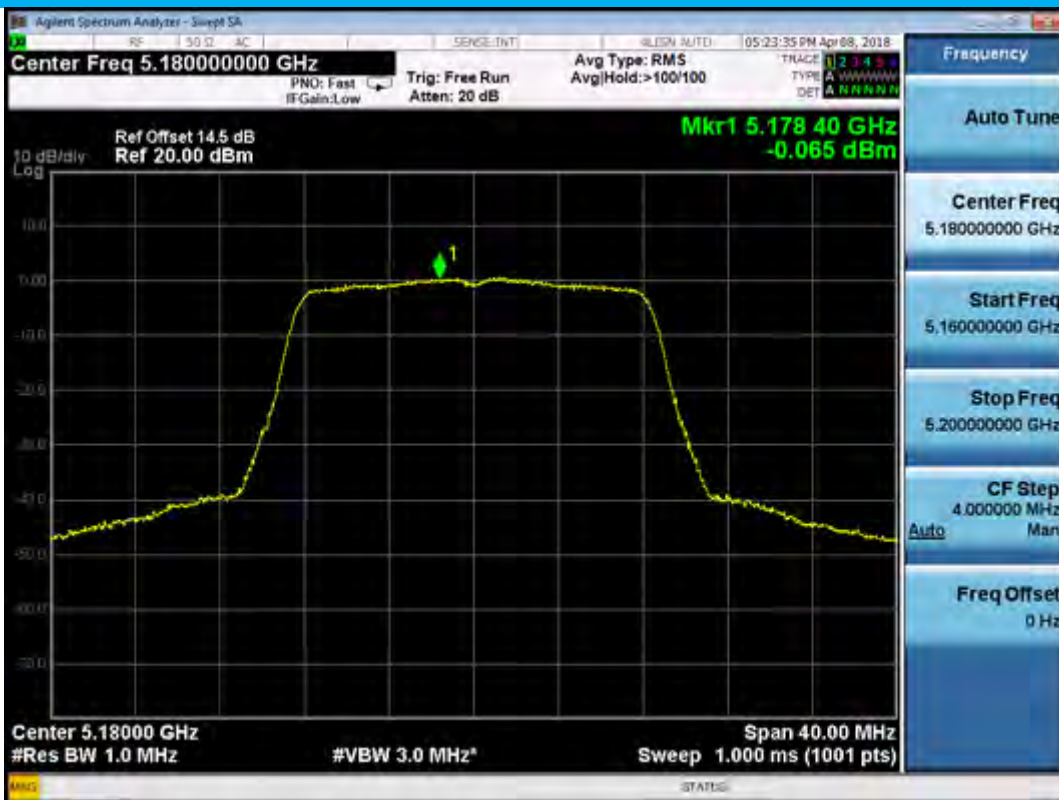

Power Spectral Density	UNII Band I
Test Model 802.11a	Frequency(MHz) 5200
Ant0	

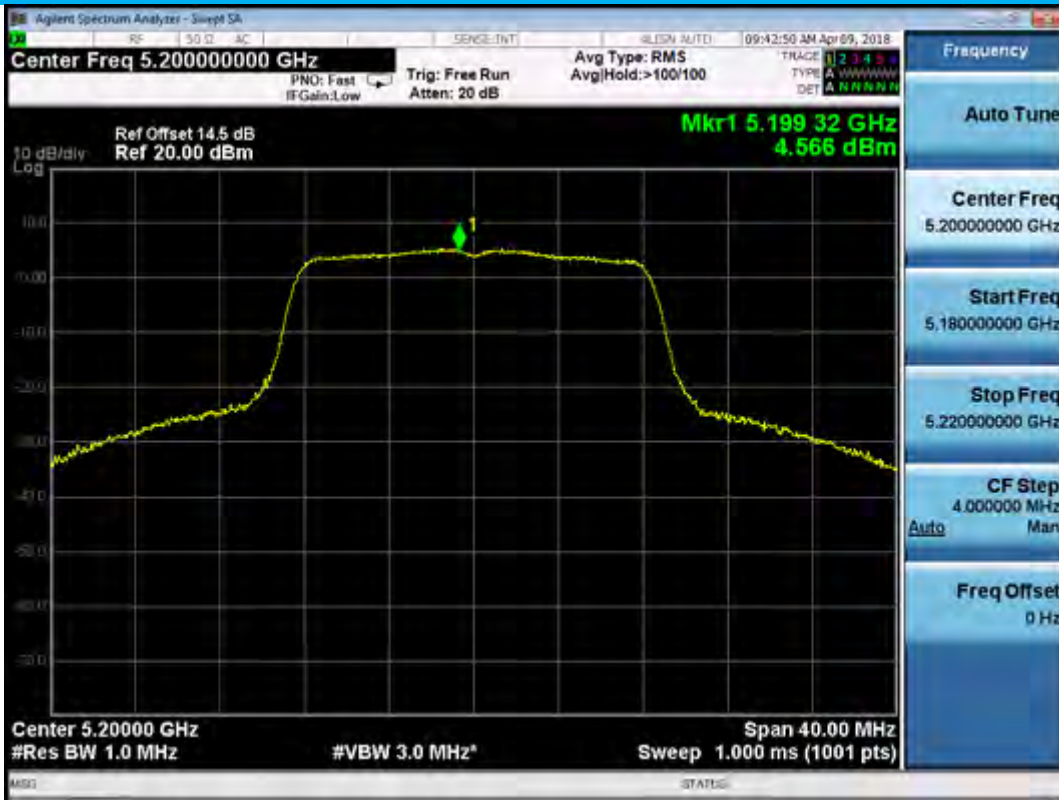

Ant1

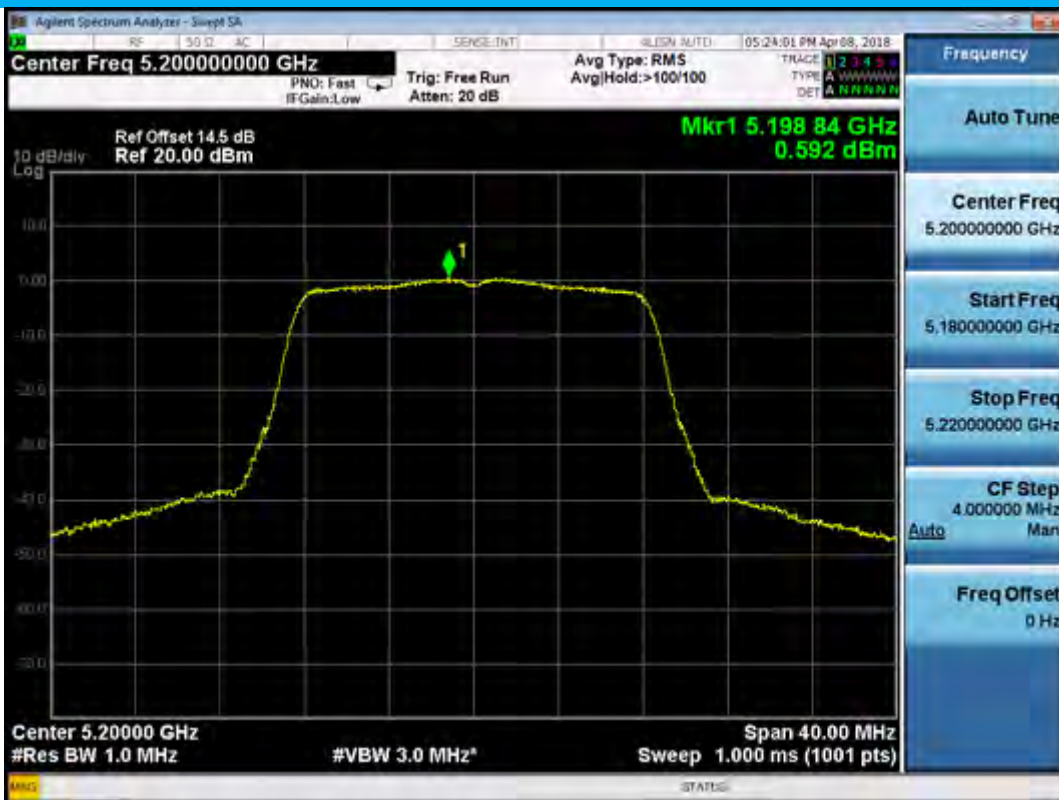

Power Spectral Density	UNII Band I
Test Model 802.11a	Frequency(MHz) 5240
Ant0	

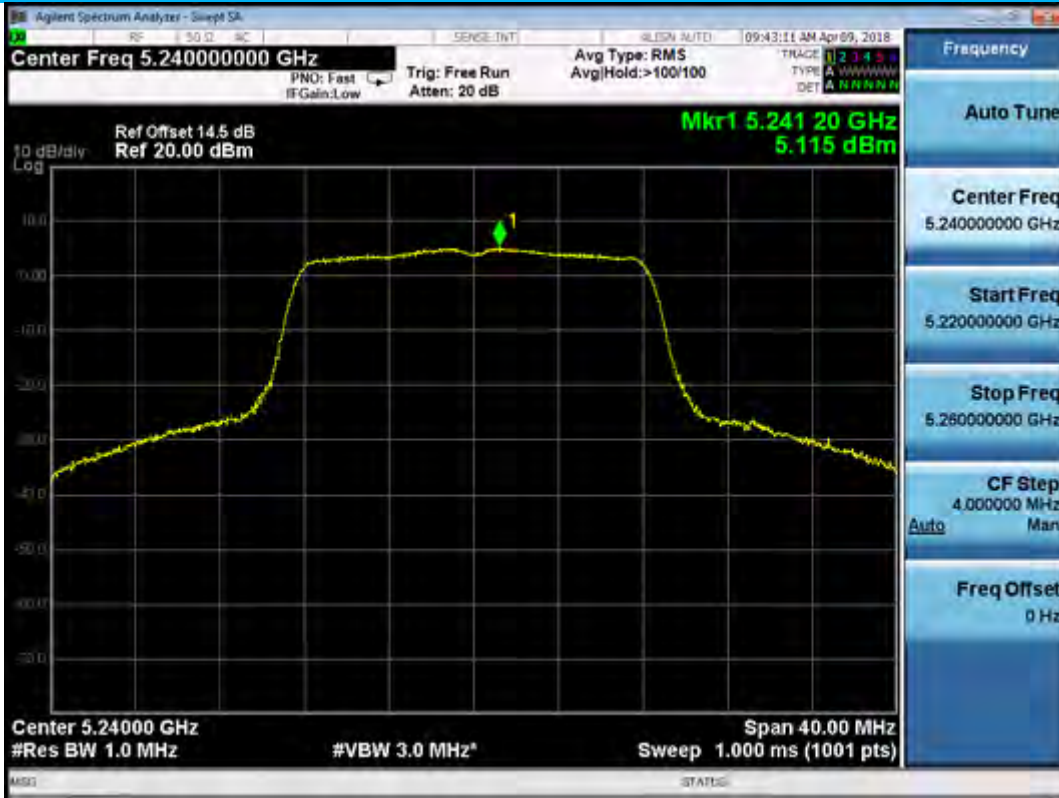

Ant1

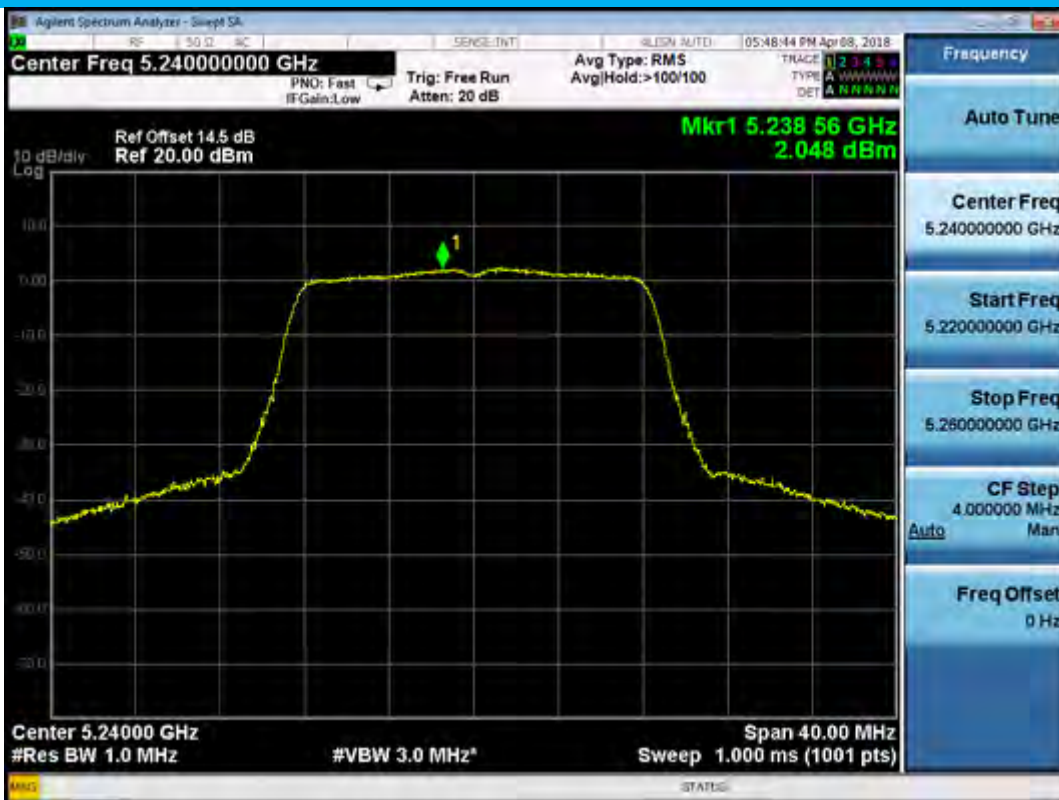

Power Spectral Density	UNII Band III
Test Model 802.11a	Frequency(MHz) 5745
Ant0	

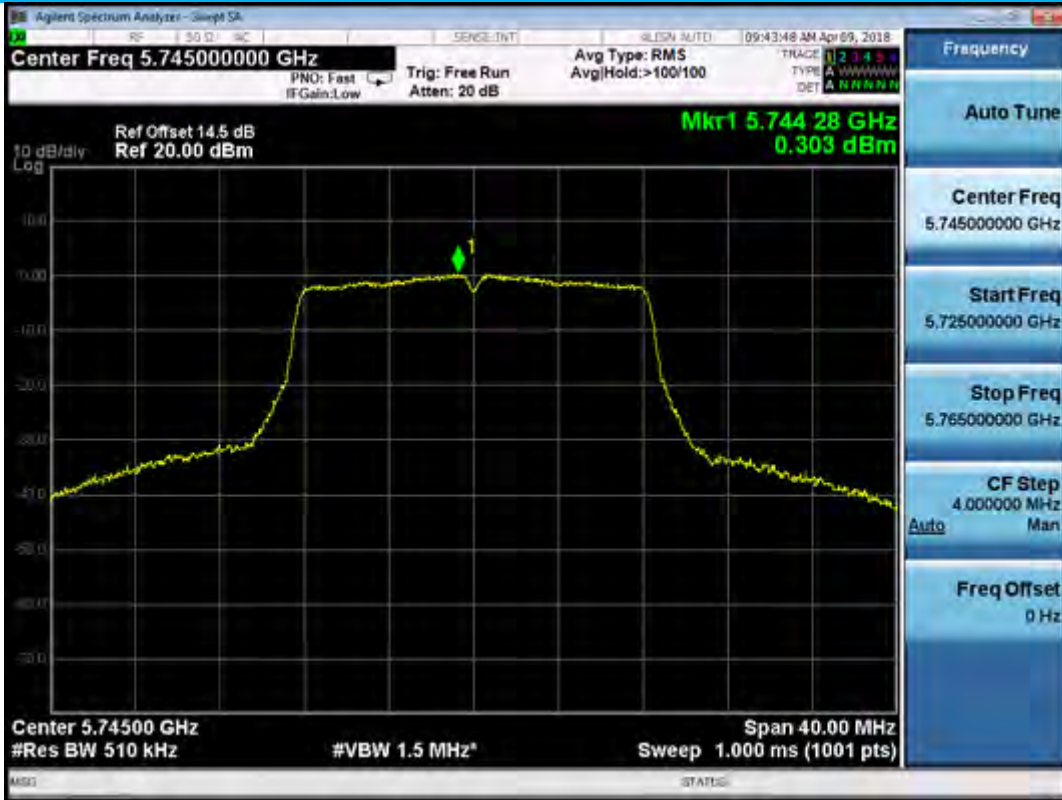

Ant1

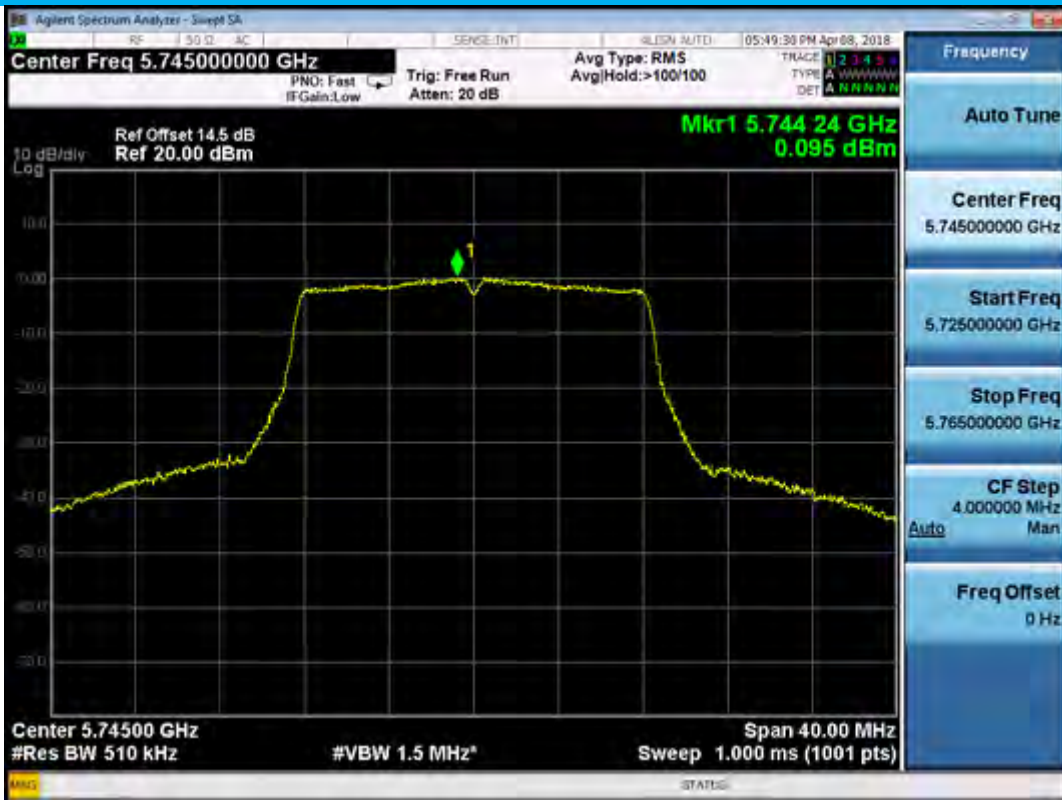

Power Spectral Density	UNII Band III
Test Model 802.11a	Frequency(MHz) 5785
Ant0	

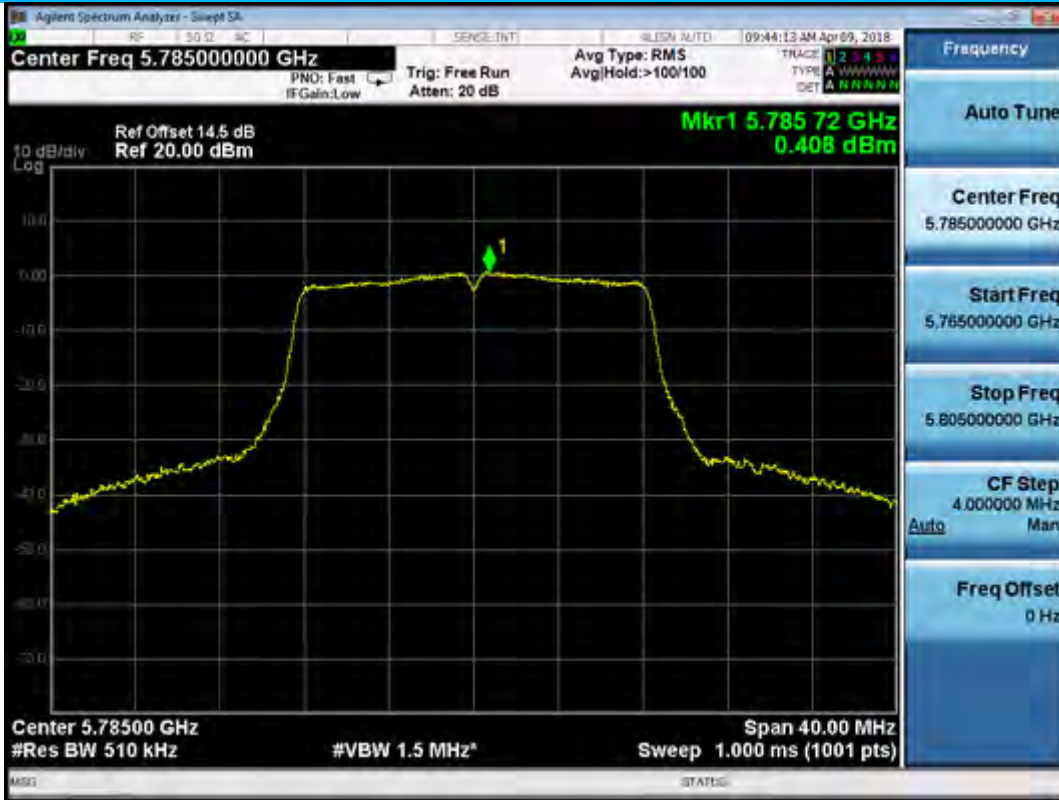

Ant1

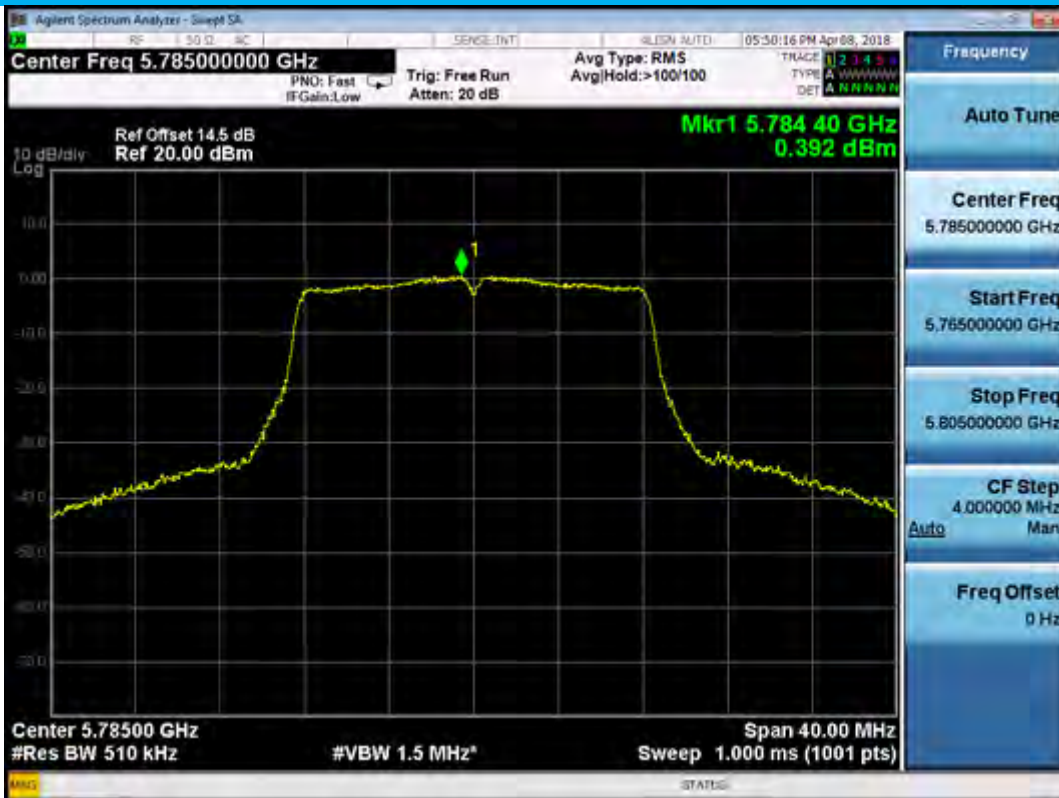

Power Spectral Density	UNII Band III
Test Model 802.11a	Frequency(MHz) 5825
Ant0	

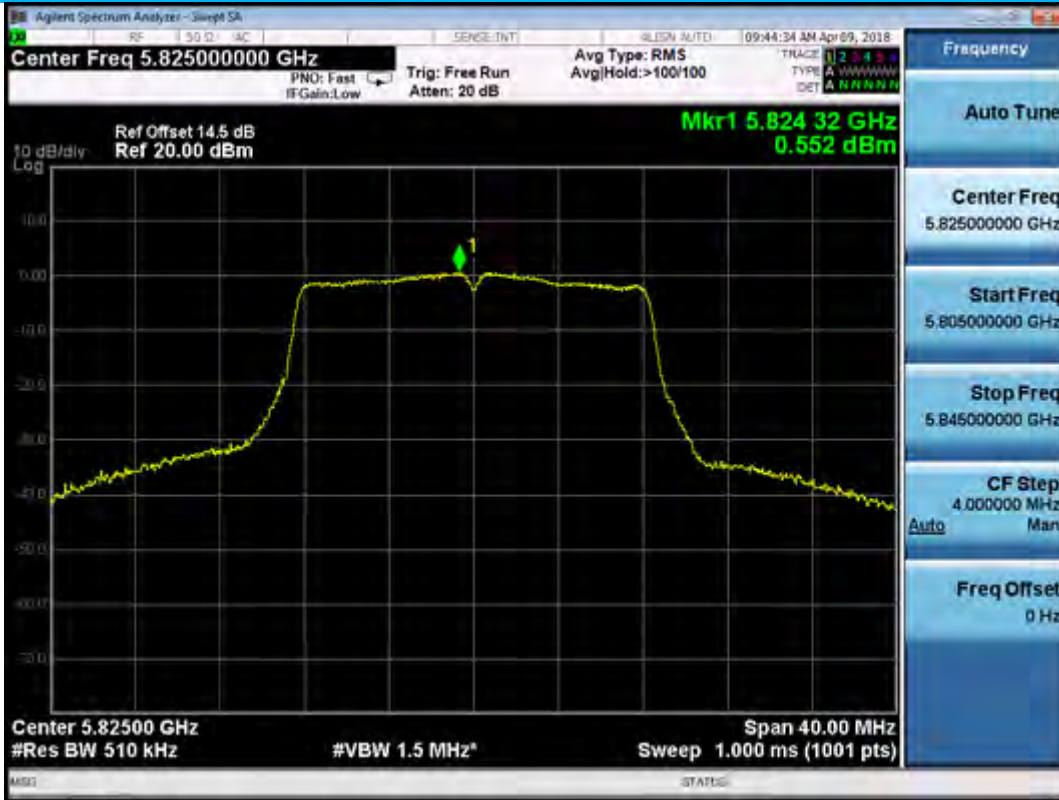

Ant1

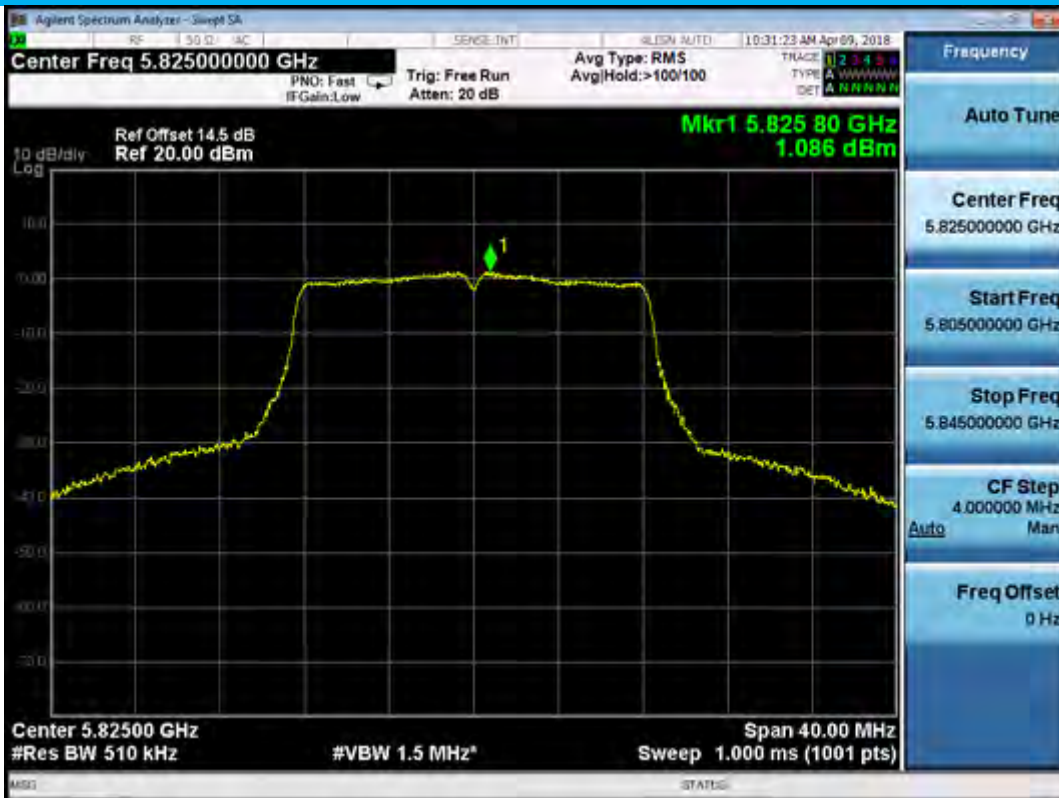

Power Spectral Density UNII Band I
 Test Model 802.11n(VHT20) mode Frequency(MHz) 5180
 Ant0

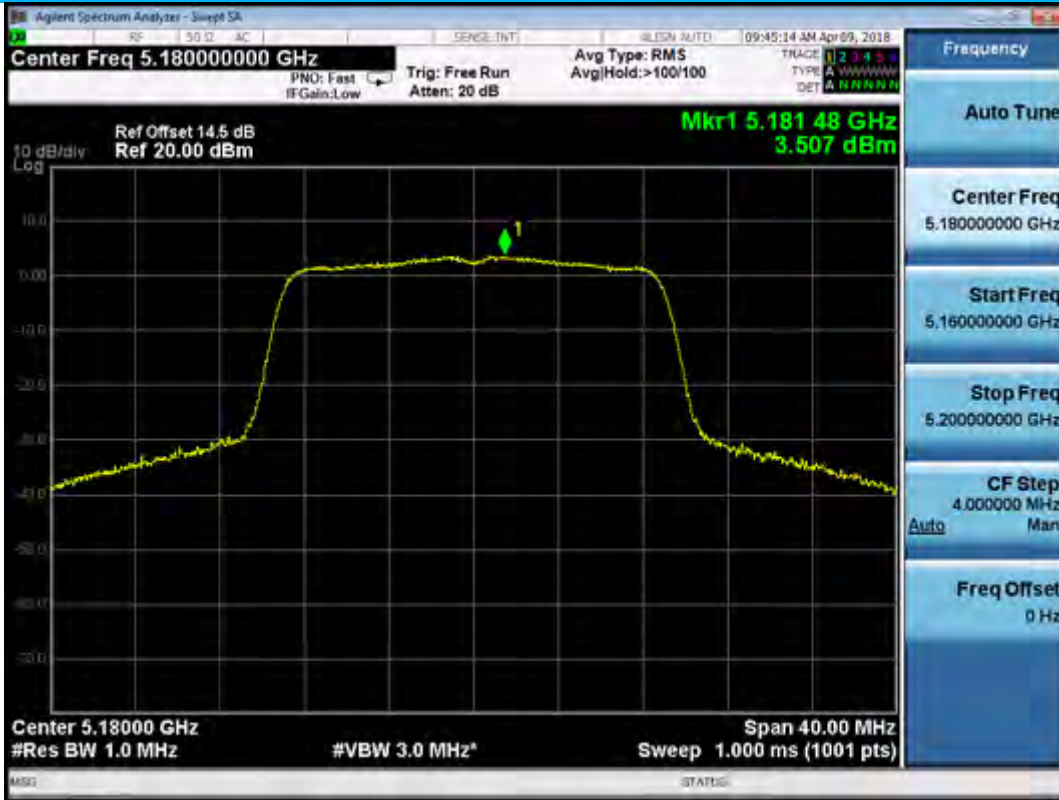

Ant1

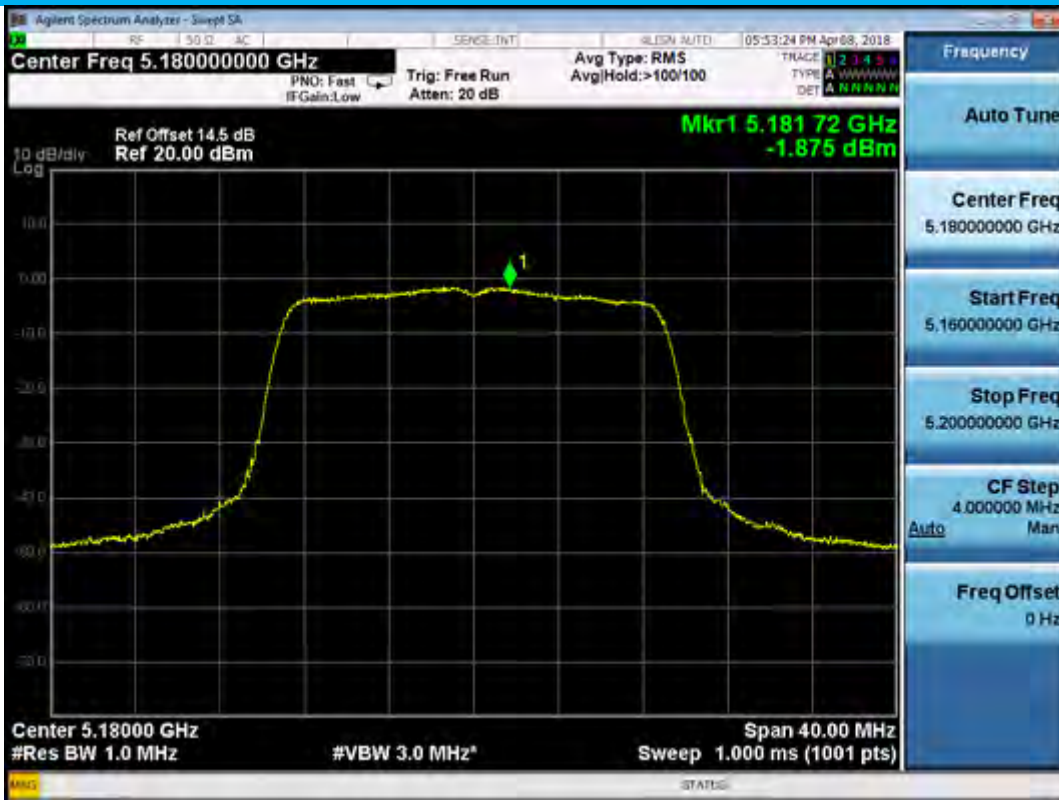

Power Spectral Density UNII Band I
 Test Model 802.11n(VHT20) mode Frequency(MHz) 5200
 Ant0



Ant1

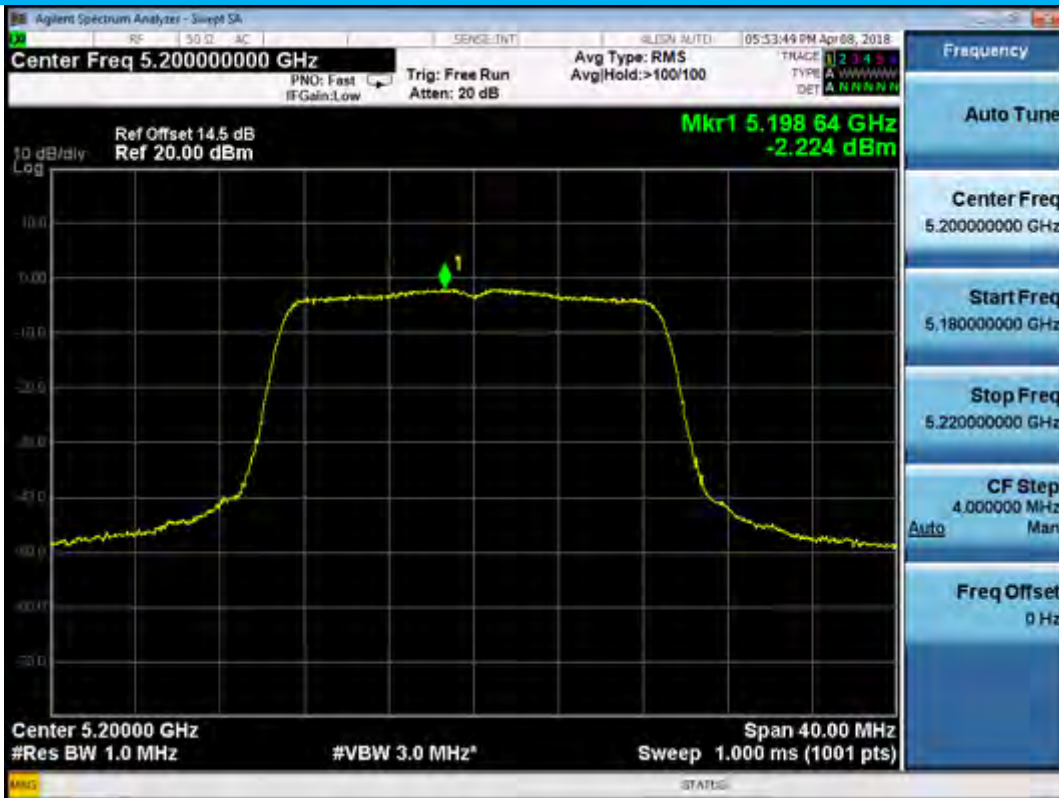

Power Spectral Density	UNII Band I
Test Model 802.11n(VHT20) mode	Frequency(MHz) 5240
Ant0	

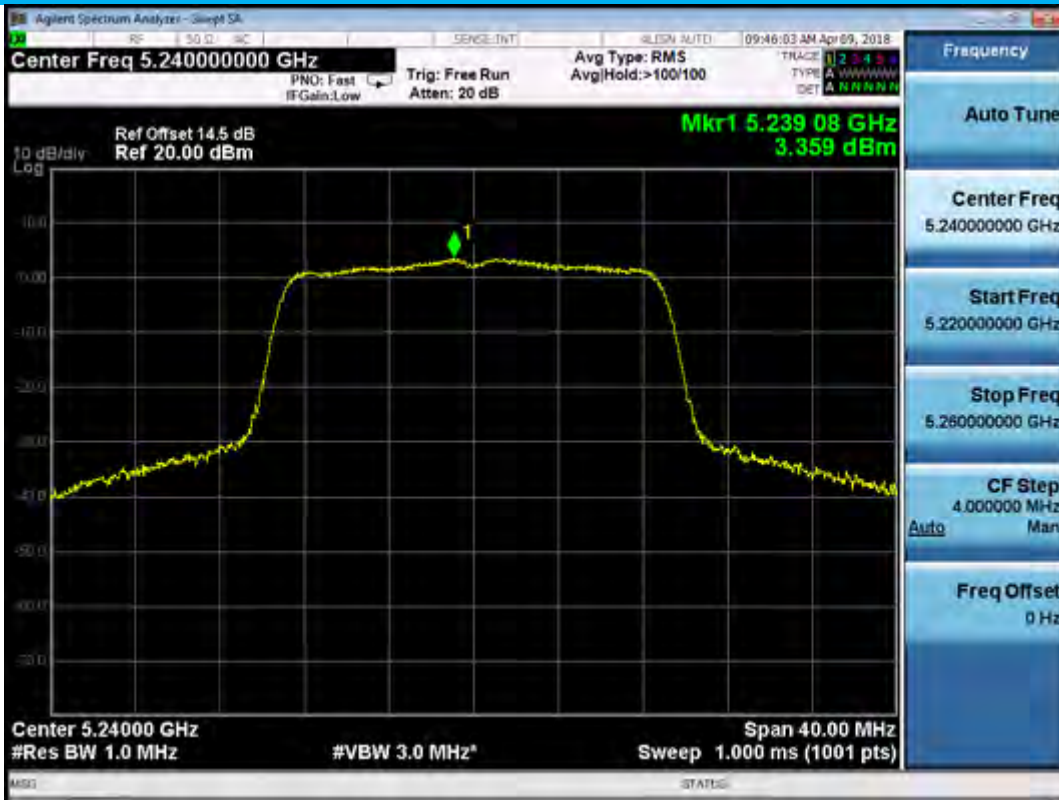

Ant1

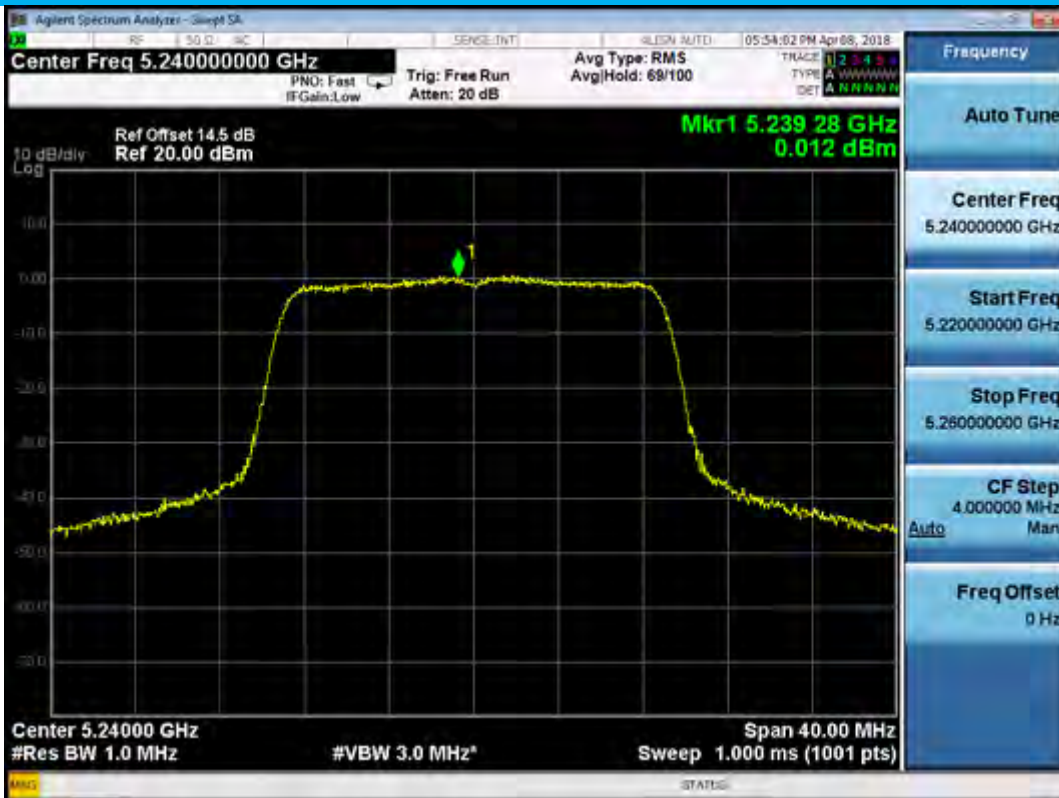

Power Spectral Density UNII Band I
 Test Model 802.11ac(VHT20) mode Frequency(MHz) 5180
 Ant0

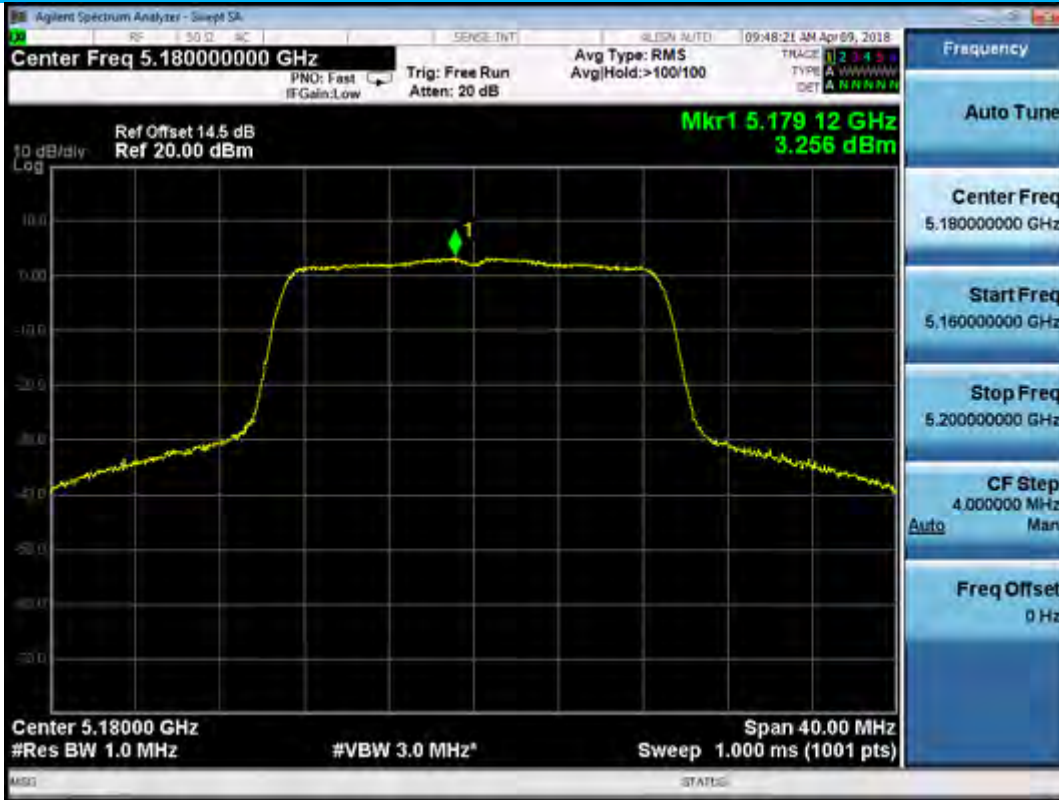

Ant1

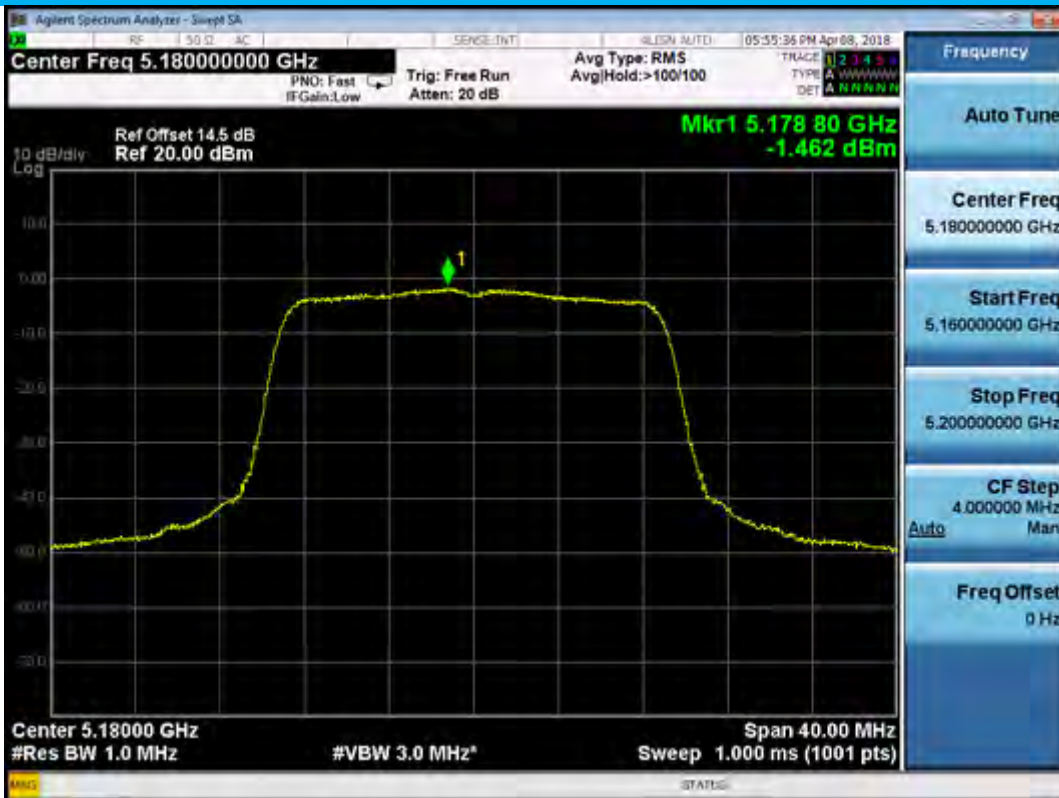

Power Spectral Density UNII Band I
 Test Model 802.11ac(VHT20) mode Frequency(MHz) 5200
 Ant0

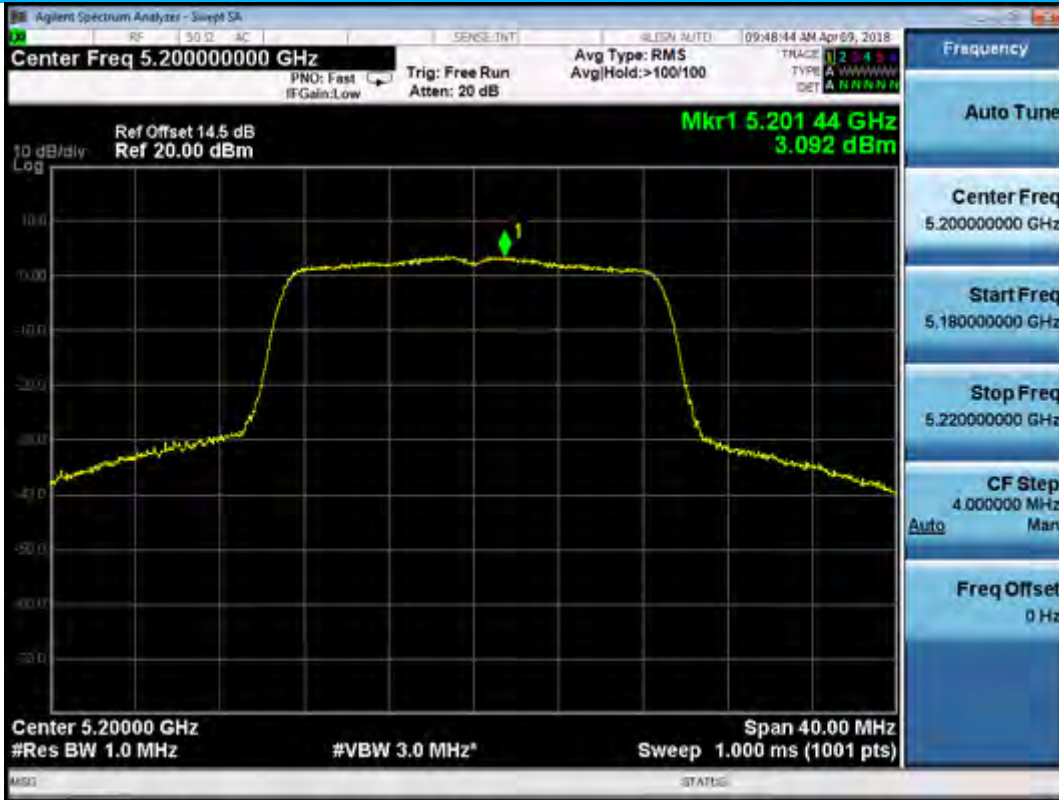

Ant1

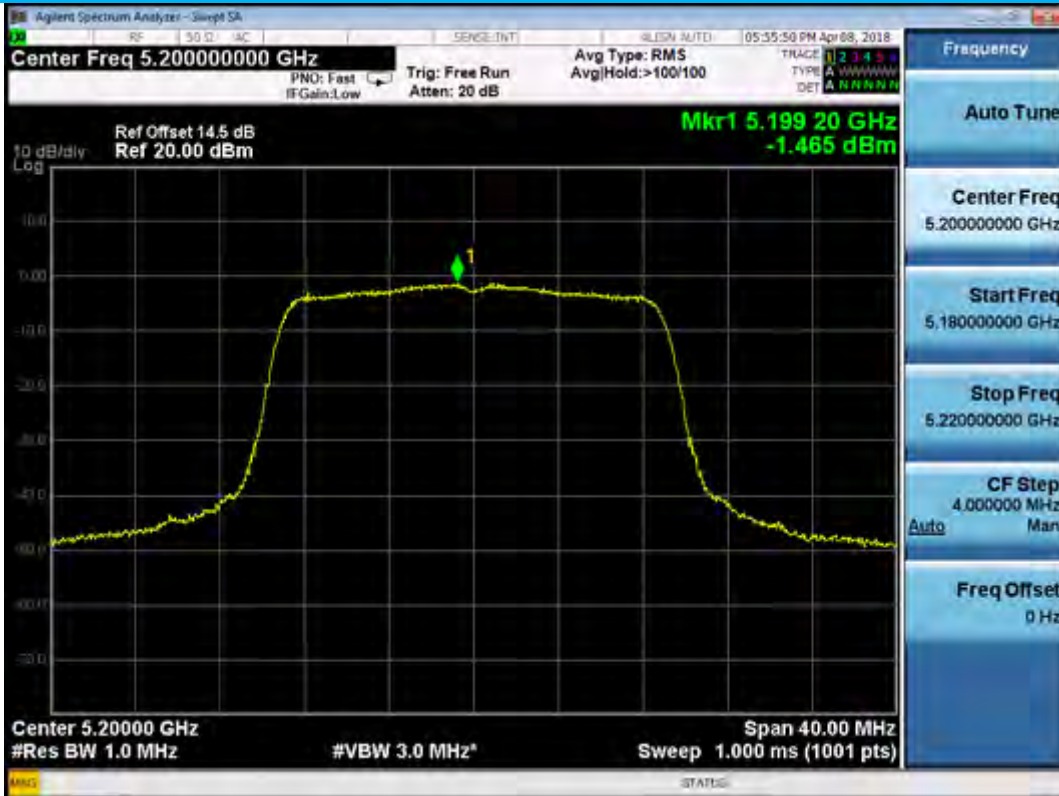

Power Spectral Density UNII Band I
 Test Model 802.11ac(VHT20) mode Frequency(MHz) 5240
 Ant0

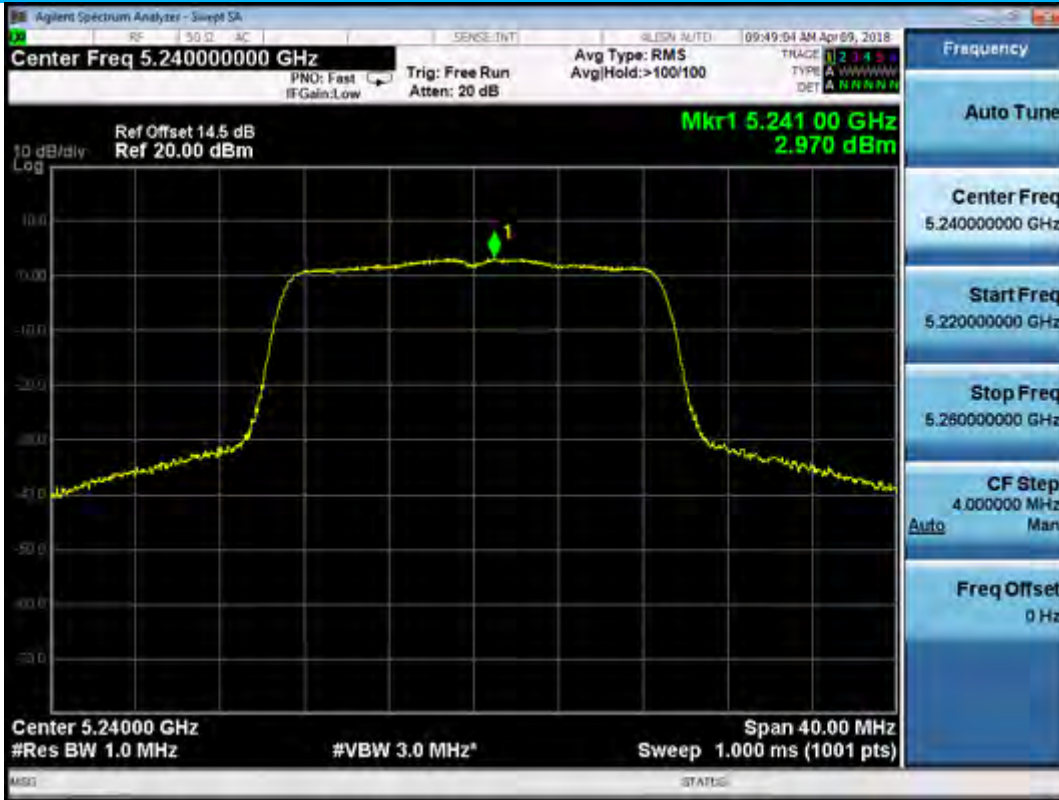

Ant1

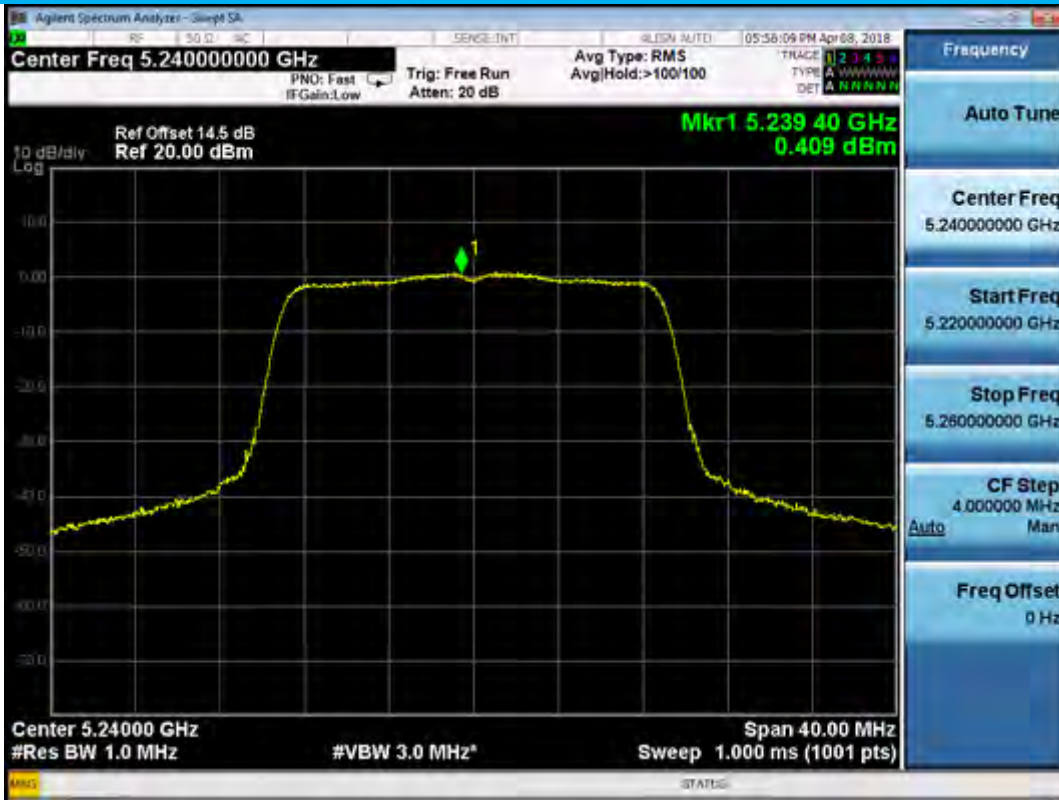

Power Spectral Density UNII Band III
 Test Model 802.11ac(VHT20) mode Frequency(MHz) 5745
 Ant0

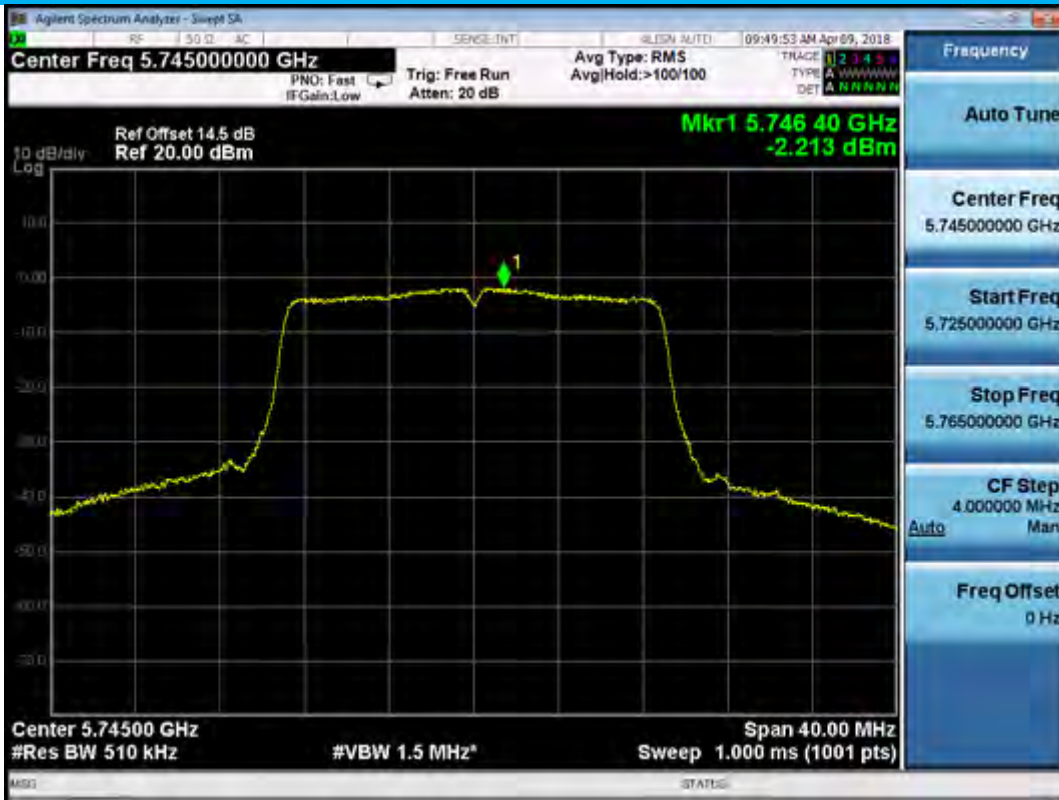

Ant1

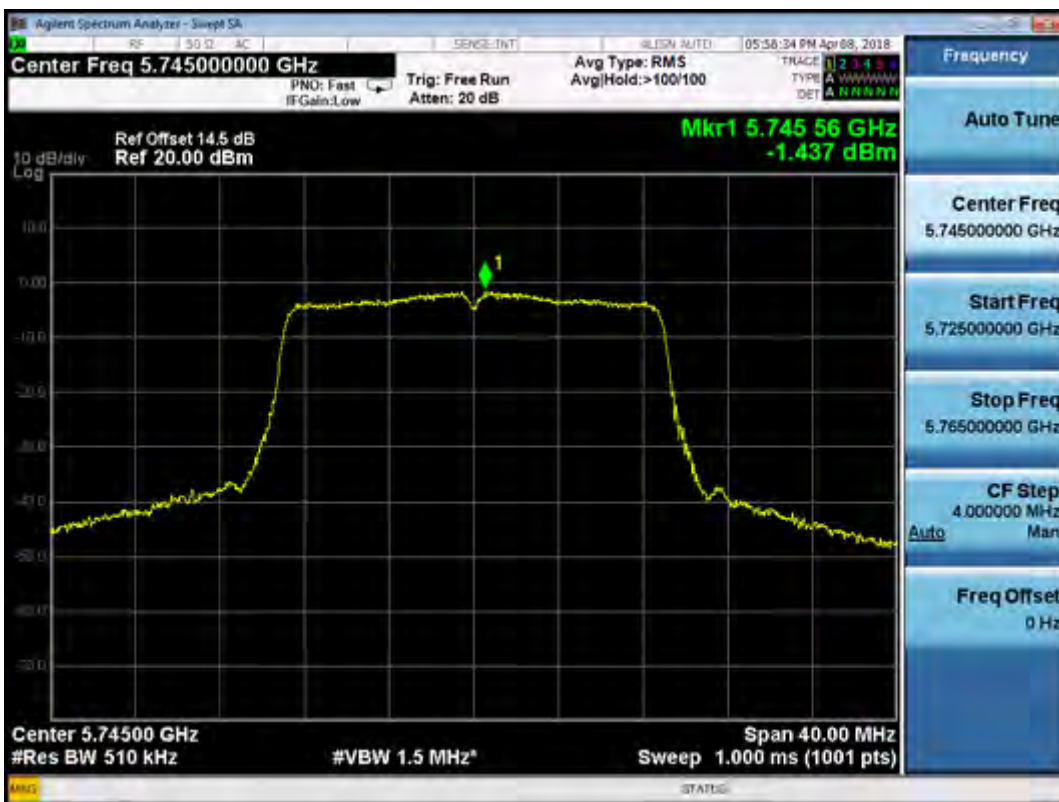

Power Spectral Density UNII Band I
 Test Model 802.11n(VHT40) mode Frequency(MHz) 5190
 Ant0

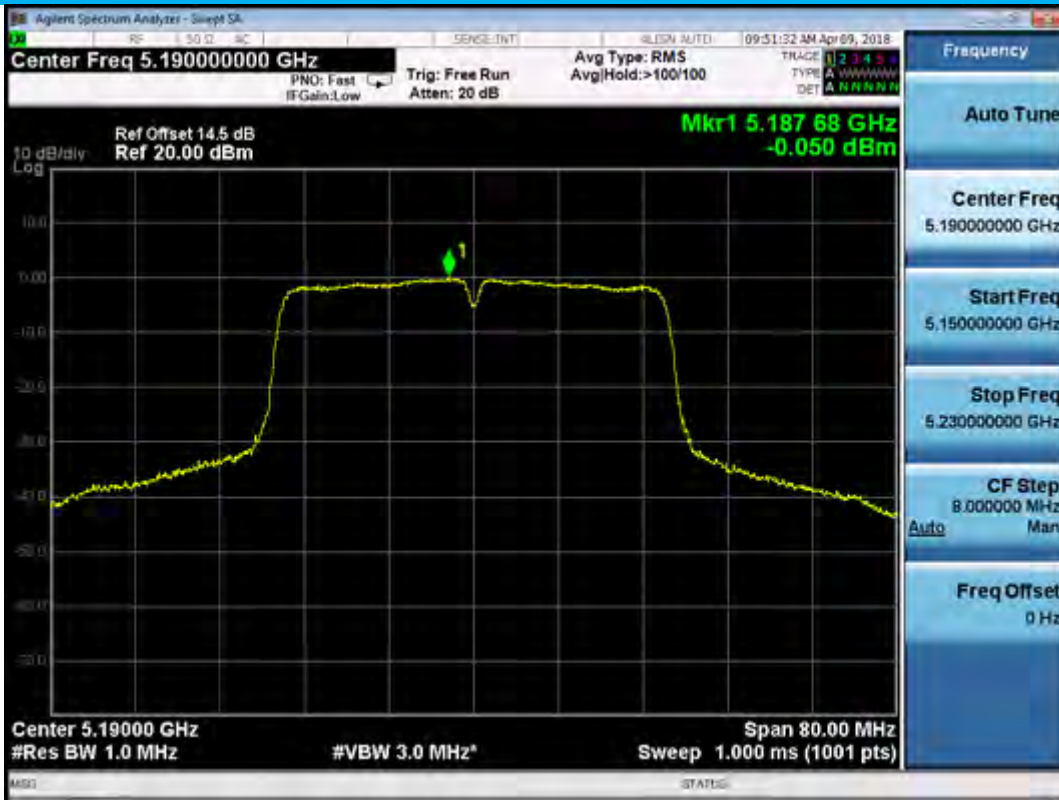

Ant1

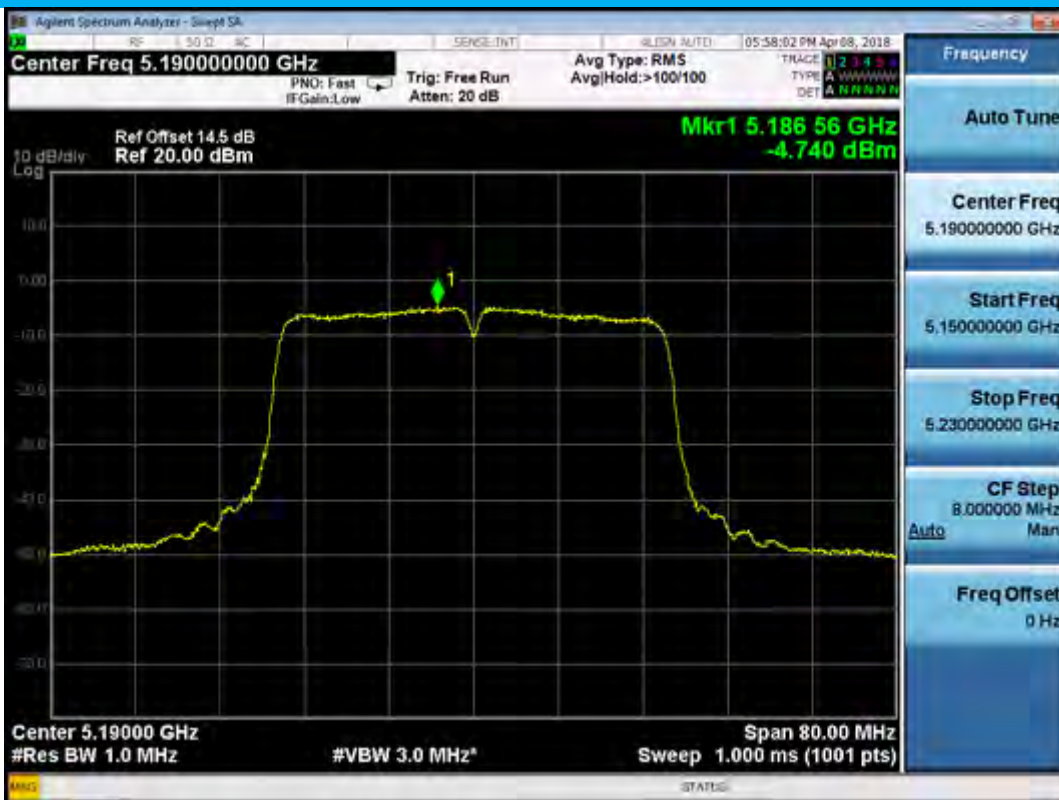

Power Spectral Density UNII Band I
 Test Model 802.11n(VHT40) mode Frequency(MHz) 5230
 Ant0

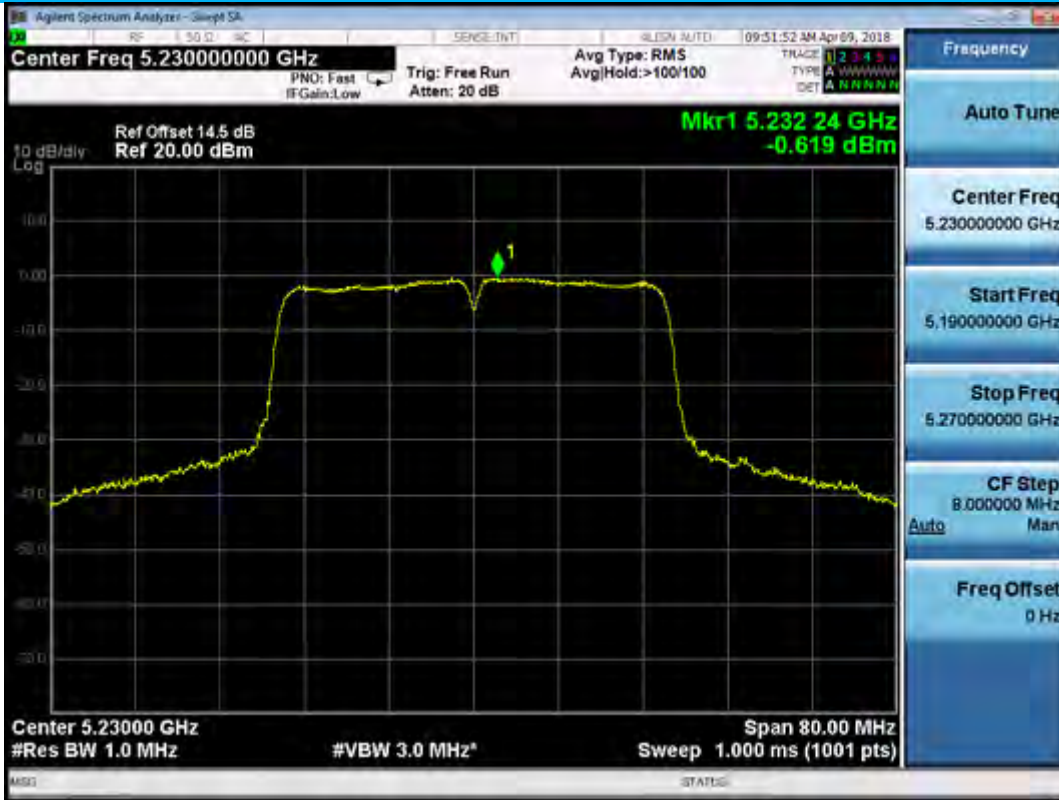

Ant1

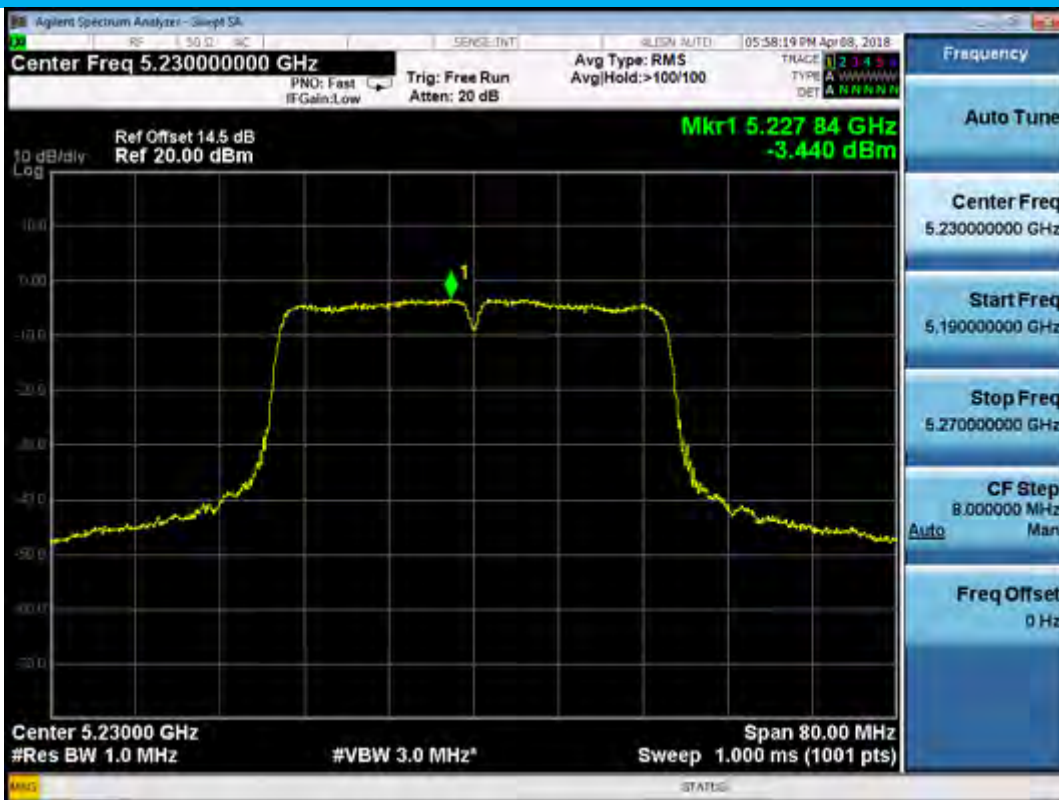

Power Spectral Density UNII Band I
 Test Model 802.11ac(VHT40) mode Frequency(MHz) 5190
 Ant0

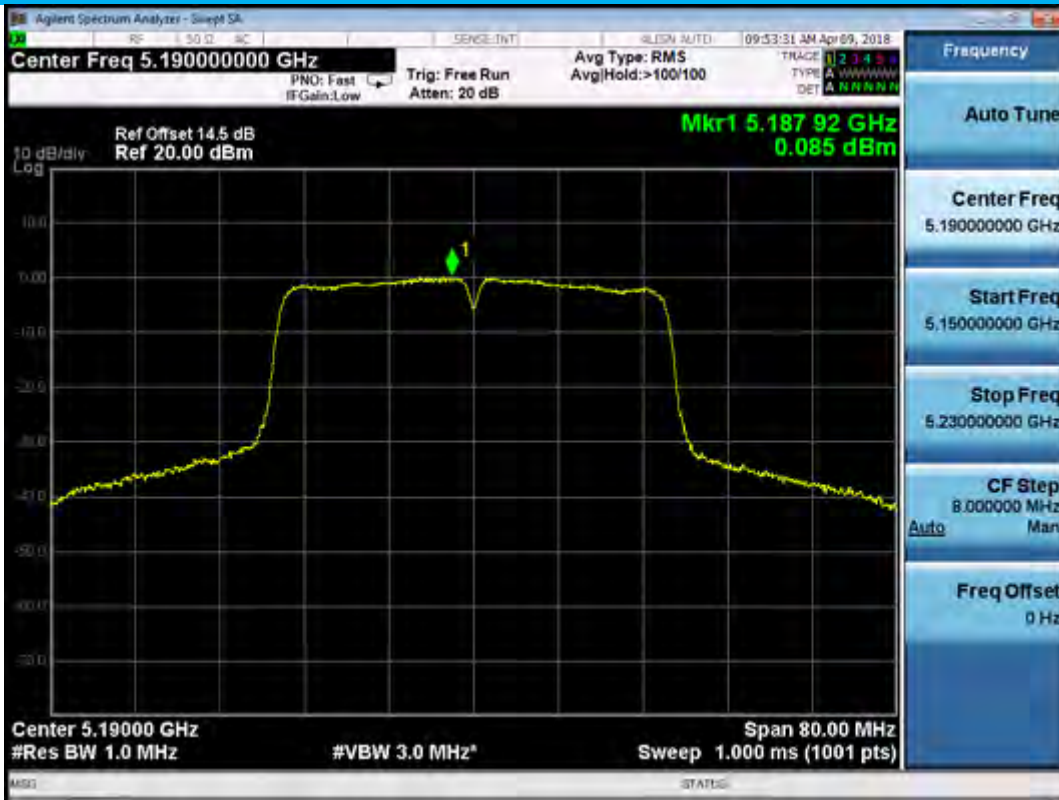

Ant1

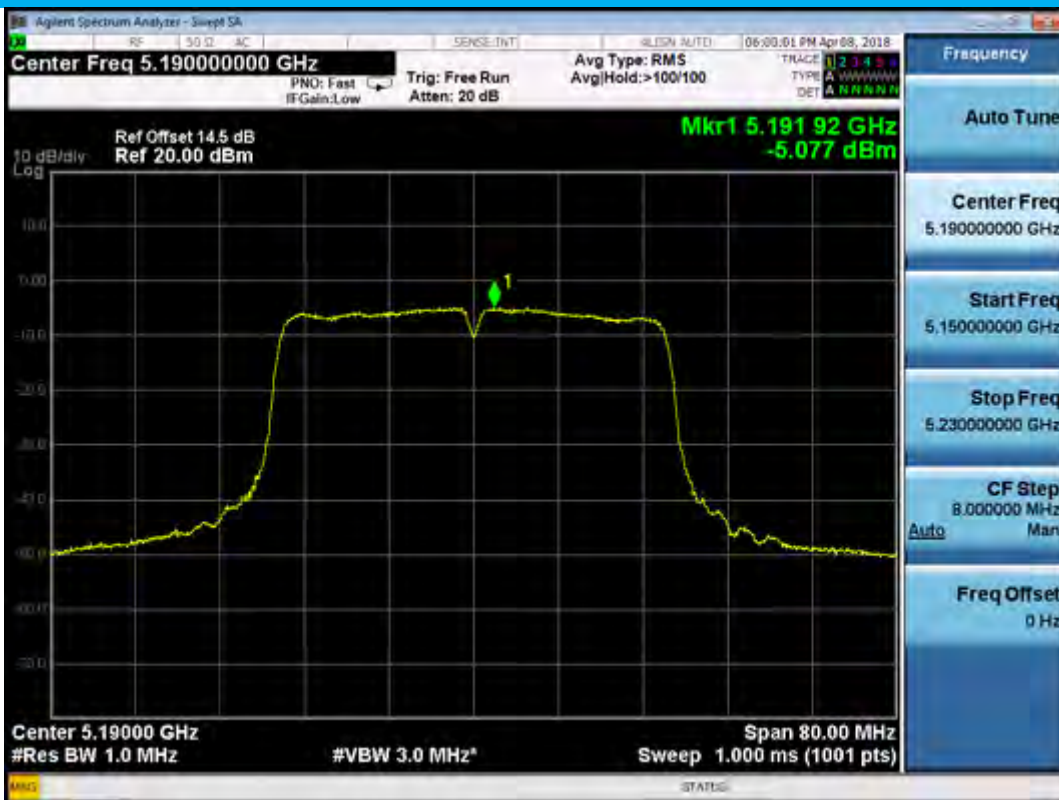

Power Spectral Density UNII Band III
 Test Model 802.11ac(VHT40) mode Frequency(MHz) 5795
 Ant0

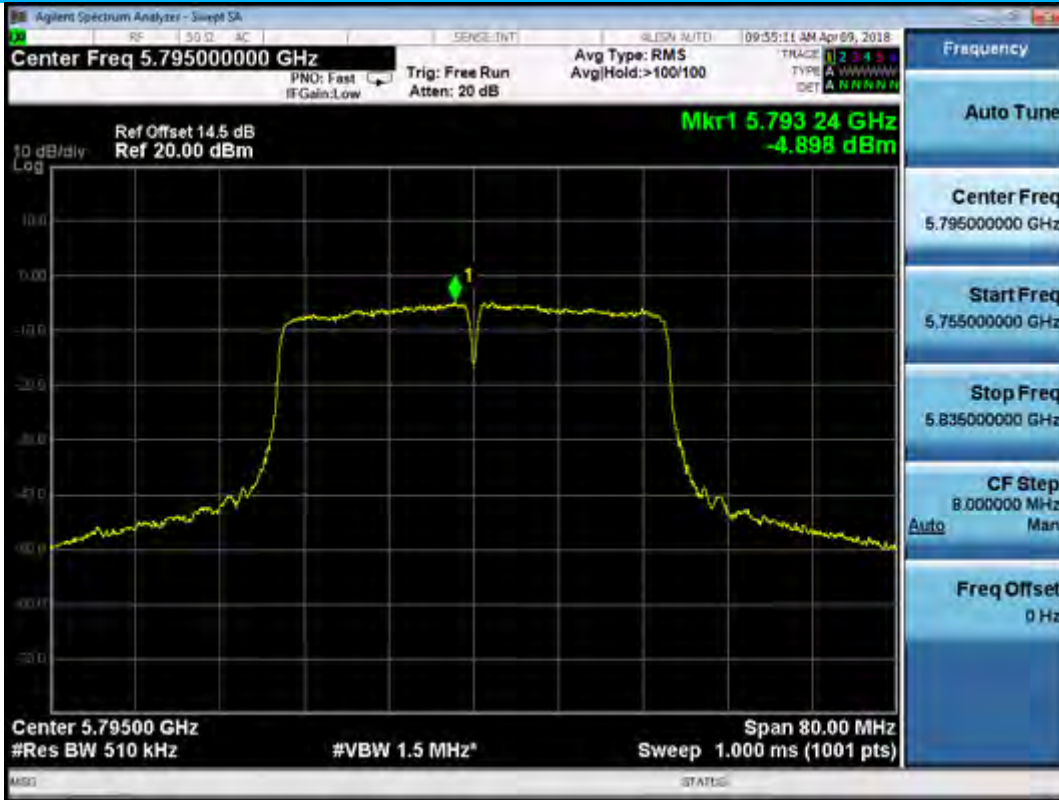

Ant1

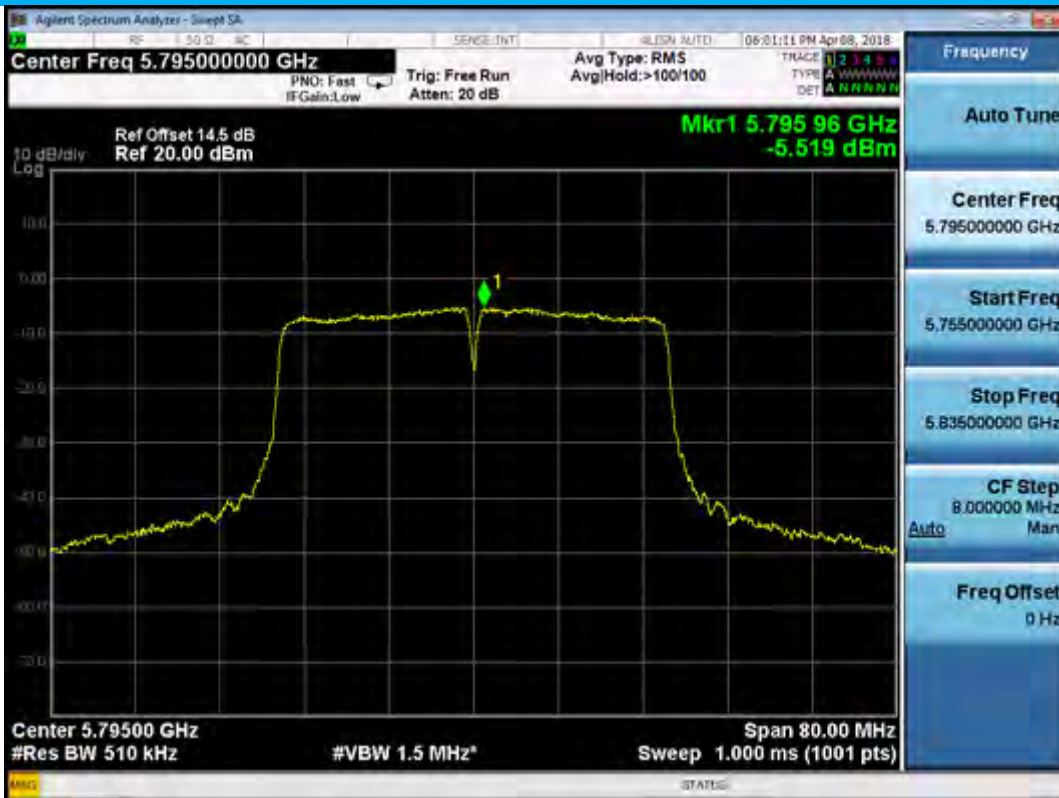

Power Spectral Density UNII Band I
 Test Model 802.11ac(VHT80) mode Frequency(MHz) 5210
 Ant0



Ant1

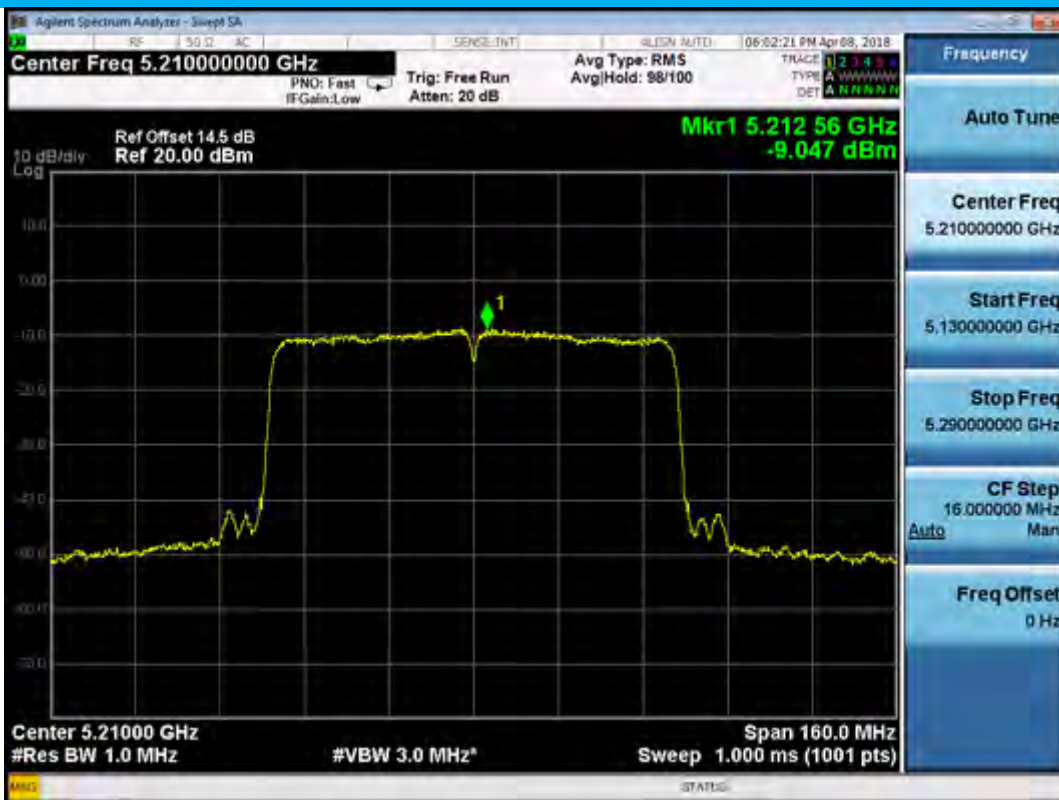

Power Spectral Density UNII Band III
 Test Model 802.11ac(VHT80) mode Frequency(MHz) 5775
 Ant0

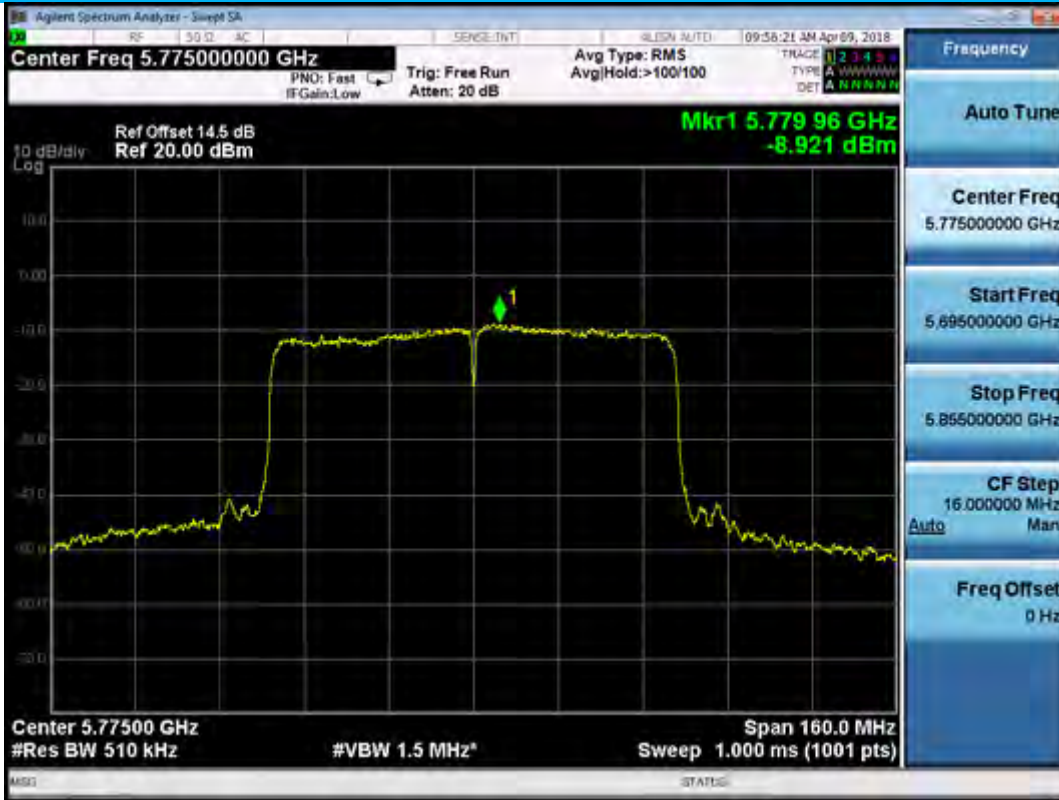

Ant1

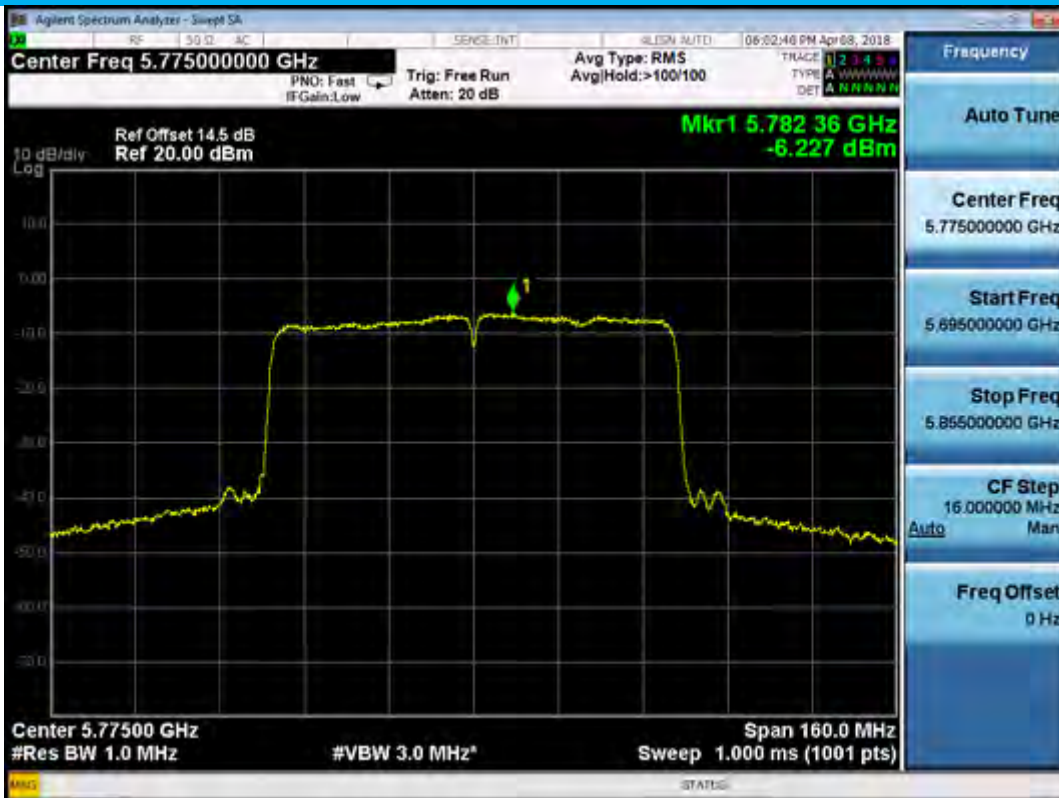

8.4 FREQUENCY STABILITY

8.4.1 Applicable Standard

According to FCC Part 15.407(g)
ANSI C63.10 Section 6.8

8.4.2 Conformance Limit

Manufacturers of U-NII devices are responsible for ensuring frequency stability such that an emission is maintained within the band of operation under all conditions of normal operation as specified in the users manual.

8.4.3 Test Configuration

Test according to clause 6.1 radio frequency test setup

8.4.4 Test Procedure

The RF output of EUT was connected to the spectrum analyzer by RF cable and attenuator. The path loss was compensated to the results for each measurement.

Set to the maximum power setting and enable the EUT transmit continuously

Set RBW = 10 kHz.

Set the video bandwidth (VBW) =30 kHz.

Set Span= Entire absence of modulation emissions bandwidth

Set Detector = Peak.

Set Trace mode = max hold.

Set Sweep = auto couple.

Allow the trace to stabilize.

The test extreme voltage is to change the primary supply voltage from 85 to 115 percent of the nominal value.

Beginning at each temperature level specified in user manual , the frequency shall be measured within one minute after application of primary power to the transmitter and at intervals of no more than one minute thereafter until ten minutes have elapsed or until sufficient measurements are obtained to indicate clearly that the frequency has stabilized within the applicable tolerance, whichever time period is greater. During each test, the ambient temperature shall not be allowed to rise more than 10° centigrade above the respective beginning ambient temperature level

Measure and record the results in the test report.

8.4.5 Test Results

The test data for Antenna A

802.11a mode	5180
Temperature : --	Test Date : April 08,2018
Humidity : 65 %	Test By: King Kong

Voltage(V)	Temp(°C)	Test Frequency (MHz)	Max. Deviation (KHz)	Verdict
Vnom	-20	5179.969431	-30.569	Pass
	-10	5179.969357	-30.643	Pass
	0	5179.969415	-30.585	Pass
	10	5179.969514	-30.486	Pass
	20	5179.969136	-30.864	Pass
	30	5179.969259	-30.741	Pass
	40	5179.970579	-29.421	Pass
50	5179.969364	-30.636	Pass	
85% Vnom	20	5179.969125	-30.875	Pass
115% Vnom	20	5179.969335	-30.665	Pass

802.11a mode	5200
Temperature : --	Test Date : April 08,2018
Humidity : 65 %	Test By: King Kong

Voltage(V)	Temp(°C)	Test Frequency (MHz)	Max. Deviation (KHz)	Verdict
Vnom	-20	5199.961236	-38.764	Pass
	-10	5199.961257	-38.743	Pass
	0	5199.961412	-38.588	Pass
	10	5199.961258	-38.742	Pass
	20	5200.038741	38.741	Pass
	30	5199.961245	-38.755	Pass
	40	5199.961211	-38.789	Pass
50	5199.961265	-38.735	Pass	
85% Vnom	20	5199.961235	-38.765	Pass
115% Vnom	20	5199.961395	-38.605	Pass

802.11a mode	5240
Temperature : --	Test Date : April 08,2018
Humidity : 65 %	Test By: King Kong

Voltage(V)	Temp(°C)	Test Frequency (MHz)	Max. Deviation (KHz)	Verdict
Vnom	-20	5239.977856	-22.144	Pass
	-10	5239.977475	-22.525	Pass
	0	5239.977486	-22.514	Pass
	10	5239.977364	-22.636	Pass
	20	5239.977124	-22.876	Pass
	30	5239.977258	-22.742	Pass
	40	5239.977369	-22.631	Pass
50	5239.978854	-21.146	Pass	
85% Vnom	20	5239.977196	-22.804	Pass
115% Vnom	20	5239.977753	-22.247	Pass

802.11a mode 5745
 Temperature : -- Test Date : April 08,2018
 Humidity : 65 % Test By: King Kong

Voltage(V)	Temp(°C)	Test Frequency (MHz)	Max. Deviation (KHz)	Verdict
Vnom	-20	5744.986351	-13.649	Pass
	-10	5744.986236	-13.764	Pass
	0	5744.986247	-13.753	Pass
	10	5744.986489	-13.511	Pass
	20	5744.986654	-13.346	Pass
	30	5744.986212	-13.788	Pass
	40	5744.986357	-13.643	Pass
	50	5744.986456	-13.544	Pass
85% Vnom	20	5744.986159	-13.841	Pass
115% Vnom	20	5744.986435	-13.565	Pass

802.11a mode 5785
 Temperature : -- Test Date : April 08,2018
 Humidity : 65 % Test By: King Kong

Voltage(V)	Temp(°C)	Test Frequency (MHz)	Max. Deviation (KHz)	Verdict
Vnom	-20	5784.991743	-8.257	Pass
	-10	5784.991359	-8.641	Pass
	0	5784.991126	-8.874	Pass
	10	5784.991248	-8.752	Pass
	20	5784.991435	-8.565	Pass
	30	5784.991945	-8.055	Pass
	40	5784.991345	-8.655	Pass
	50	5784.991123	-8.877	Pass
85% Vnom	20	5784.991933	-8.067	Pass
115% Vnom	20	5784.991558	-8.442	Pass

802.11a mode 5825
 Temperature : -- Test Date : April 08,2018
 Humidity : 65 % Test By: King Kong

Voltage(V)	Temp(°C)	Test Frequency (MHz)	Max. Deviation (KHz)	Verdict
Vnom	-20	5824.982886	-17.114	Pass
	-10	5824.982549	-17.451	Pass
	0	5824.982625	-17.375	Pass
	10	5824.982314	-17.686	Pass
	20	5824.982259	-17.741	Pass
	30	5824.982648	-17.352	Pass
	40	5824.982442	-17.558	Pass
	50	5824.982364	-17.636	Pass
85% Vnom	20	5824.983255	-16.745	Pass
115% Vnom	20	5824.983219	-16.781	Pass

802.11n(VHT20) mode 5180
 Temperature : -- Test Date : April 08,2018
 Humidity : 65 % Test By: King Kong

Voltage(V)	Temp(°C)	Test Frequency (MHz)	Max. Deviation (KHz)	Verdict
Vnom	-20	5180.001427	1.427	Pass
	-10	5180.001246	1.246	Pass
	0	5180.001236	1.236	Pass
	10	5180.001369	1.369	Pass
	20	5180.001357	1.357	Pass
	30	5180.001574	1.574	Pass
	40	5180.001685	1.685	Pass
	50	5180.001954	1.954	Pass
85% Vnom	20	5180.001264	1.264	Pass
115% Vnom	20	5180.001253	1.253	Pass

802.11n(VHT20) mode 5200
 Temperature : -- Test Date : April 08,2018
 Humidity : 65 % Test By: King Kong

Voltage(V)	Temp(°C)	Test Frequency (MHz)	Max. Deviation (KHz)	Verdict
Vnom	-20	5199.976124	-23.876	Pass
	-10	5199.975256	-24.744	Pass
	0	5199.975321	-24.679	Pass
	10	5199.975257	-24.743	Pass
	20	5199.975156	-24.844	Pass
	30	5199.975649	-24.351	Pass
	40	5199.975667	-24.333	Pass
	50	5199.975946	-24.054	Pass
85% Vnom	20	5199.975223	-24.777	Pass
115% Vnom	20	5199.976348	-23.652	Pass

802.11n(VHT20) mode 5240
 Temperature : -- Test Date : April 08,2018
 Humidity : 65 % Test By: King Kong

Voltage(V)	Temp(°C)	Test Frequency (MHz)	Max. Deviation (KHz)	Verdict
Vnom	-20	5239.982458	-17.542	Pass
	-10	5239.981426	-18.574	Pass
	0	5239.981348	-18.652	Pass
	10	5239.981774	-18.226	Pass
	20	5239.981558	-18.442	Pass
	30	5239.981364	-18.636	Pass
	40	5239.981159	-18.841	Pass
	50	5239.981475	-18.525	Pass
85% Vnom	20	5239.981224	-18.776	Pass
115% Vnom	20	5239.981761	-18.239	Pass

802.11n(VHT20) mode 5745
 Temperature : -- Test Date : April 08,2018
 Humidity : 65 % Test By: King Kong

Voltage(V)	Temp(°C)	Test Frequency (MHz)	Max. Deviation (KHz)	Verdict
Vnom	-20	5744.980156	-19.844	Pass
	-10	5744.980236	-19.764	Pass
	0	5744.980587	-19.413	Pass
	10	5744.980429	-19.571	Pass
	20	5744.980456	-19.544	Pass
	30	5744.980247	-19.753	Pass
	40	5744.980963	-19.037	Pass
50	5744.980365	-19.635	Pass	
85% Vnom	20	5744.980125	-19.875	Pass
115% Vnom	20	5744.980554	-19.446	Pass

802.11n(VHT20) mode 5785
 Temperature : -- Test Date : April 08,2018
 Humidity : 65 % Test By: King Kong

Voltage(V)	Temp(°C)	Test Frequency (MHz)	Max. Deviation (KHz)	Verdict
Vnom	-20	5784.988751	-11.249	Pass
	-10	5784.988582	-11.418	Pass
	0	5784.988693	-11.307	Pass
	10	5784.988485	-11.515	Pass
	20	5784.988249	-11.751	Pass
	30	5784.988367	-11.633	Pass
	40	5784.988560	-11.44	Pass
50	5784.988124	-11.876	Pass	
85% Vnom	20	5784.988063	-11.937	Pass
115% Vnom	20	5784.988247	-11.753	Pass

802.11n(VHT20) mode 5825
 Temperature : -- Test Date : April 08,2018
 Humidity : 65 % Test By: King Kong

Voltage(V)	Temp(°C)	Test Frequency (MHz)	Max. Deviation (KHz)	Verdict
Vnom	-20	5824.991567	-8.433	Pass
	-10	5824.991549	-8.451	Pass
	0	5824.991512	-8.488	Pass
	10	5824.991532	-8.468	Pass
	20	5824.991247	-8.753	Pass
	30	5824.991224	-8.776	Pass
	40	5824.991264	-8.736	Pass
50	5824.991475	-8.525	Pass	
85% Vnom	20	5824.991234	-8.766	Pass
115% Vnom	20	5824.991335	-8.665	Pass

802.11ac(VHT20) mode 5180
 Temperature : -- Test Date : April 08,2018
 Humidity : 65 % Test By: King Kong

Voltage(V)	Temp(°C)	Test Frequency (MHz)	Max. Deviation (KHz)	Verdict
Vnom	-20	5179.996351	-3.649	Pass
	-10	5179.996258	-3.742	Pass
	0	5179.996741	-3.259	Pass
	10	5179.996752	-3.248	Pass
	20	5179.996369	-3.631	Pass
	30	5179.996257	-3.743	Pass
	40	5179.996481	-3.519	Pass
	50	5179.996571	-3.429	Pass
85% Vnom	20	5179.996592	-3.408	Pass
115% Vnom	20	5179.996247	-3.753	Pass

802.11ac(VHT20) mode 5200
 Temperature : -- Test Date : April 08,2018
 Humidity : 65 % Test By: King Kong

Voltage(V)	Temp(°C)	Test Frequency (MHz)	Max. Deviation (KHz)	Verdict
Vnom	-20	5199.985431	-14.569	Pass
	-10	5199.984265	-15.735	Pass
	0	5199.984248	-15.752	Pass
	10	5199.984123	-15.877	Pass
	20	5199.984465	-15.535	Pass
	30	5199.984789	-15.211	Pass
	40	5199.984753	-15.247	Pass
	50	5199.984159	-15.841	Pass
85% Vnom	20	5199.984248	-15.752	Pass
115% Vnom	20	5199.984445	-15.555	Pass

802.11ac(VHT20) mode 5240
 Temperature : -- Test Date : April 08,2018
 Humidity : 65 % Test By: King Kong

Voltage(V)	Temp(°C)	Test Frequency (MHz)	Max. Deviation (KHz)	Verdict
Vnom	-20	5240.002423	2.423	Pass
	-10	5240.002159	2.159	Pass
	0	5240.002852	2.852	Pass
	10	5240.002421	2.421	Pass
	20	5240.002364	2.364	Pass
	30	5240.002248	2.248	Pass
	40	5240.002152	2.152	Pass
	50	5240.002616	2.616	Pass
85% Vnom	20	5240.002368	2.368	Pass
115% Vnom	20	5240.002952	2.952	Pass

802.11ac(VHT20) mode 5745
 Temperature : -- Test Date : April 08,2018
 Humidity : 65 % Test By: King Kong

Voltage(V)	Temp(°C)	Test Frequency (MHz)	Max. Deviation (KHz)	Verdict
Vnom	-20	5744.967368	-32.632	Pass
	-10	5744.967354	-32.646	Pass
	0	5744.967126	-32.874	Pass
	10	5744.967258	-32.742	Pass
	20	5744.967741	-32.259	Pass
	30	5744.967964	-32.036	Pass
	40	5744.968125	-31.875	Pass
	50	5744.967367	-32.633	Pass
85% Vnom	20	5744.967452	-32.548	Pass
115% Vnom	20	5744.967458	-32.542	Pass

802.11ac(VHT20) mode 5785
 Temperature : -- Test Date : April 08,2018
 Humidity : 65 % Test By: King Kong

Voltage(V)	Temp(°C)	Test Frequency (MHz)	Max. Deviation (KHz)	Verdict
Vnom	-20	5784.994435	-5.565	Pass
	-10	5784.994441	-5.559	Pass
	0	5784.994457	-5.543	Pass
	10	5784.994582	-5.418	Pass
	20	5784.994567	-5.433	Pass
	30	5784.994123	-5.877	Pass
	40	5784.995048	-4.952	Pass
	50	5784.994549	-5.451	Pass
85% Vnom	20	5784.994364	-5.636	Pass
115% Vnom	20	5784.994126	-5.874	Pass

802.11ac(VHT20) mode 5825
 Temperature : -- Test Date : April 08,2018
 Humidity : 65 % Test By: King Kong

Voltage(V)	Temp(°C)	Test Frequency (MHz)	Max. Deviation (KHz)	Verdict
Vnom	-20	5824.987335	-12.665	Pass
	-10	5824.988342	-11.658	Pass
	0	5824.987158	-12.842	Pass
	10	5824.987442	-12.558	Pass
	20	5824.987264	-12.736	Pass
	30	5824.987574	-12.426	Pass
	40	5824.988236	-11.764	Pass
	50	5824.987589	-12.411	Pass
85% Vnom	20	5824.987448	-12.552	Pass
115% Vnom	20	5824.987336	-12.664	Pass

802.11n(VHT40) mode	5190
Temperature : --	Test Date : April 08,2018
Humidity : 65 %	Test By: King Kong

Voltage(V)	Temp(°C)	Test Frequency (MHz)	Max. Deviation (KHz)	Verdict
Vnom	-20	5189.975015	-24.985	Pass
	-10	5189.976124	-23.876	Pass
	0	5189.976359	-23.641	Pass
	10	5189.976074	-23.926	Pass
	20	5189.975456	-24.544	Pass
	30	5189.975362	-24.638	Pass
	40	5189.975571	-24.429	Pass
	50	5189.975228	-24.772	Pass
85% Vnom	20	5189.975367	-24.633	Pass
115% Vnom	20	5189.975354	-24.646	Pass

802.11n(VHT40) mode	5230
Temperature : --	Test Date : April 08,2018
Humidity : 65 %	Test By: King Kong

Voltage(V)	Temp(°C)	Test Frequency (MHz)	Max. Deviation (KHz)	Verdict
Vnom	-20	5229.972448	-27.552	Pass
	-10	5229.972257	-27.743	Pass
	0	5229.972369	-27.631	Pass
	10	5229.972626	-27.374	Pass
	20	5229.972254	-27.746	Pass
	30	5229.972269	-27.731	Pass
	40	5229.972228	-27.772	Pass
	50	5229.972842	-27.158	Pass
85% Vnom	20	5229.972367	-27.633	Pass
115% Vnom	20	5229.972951	-27.049	Pass

802.11n(VHT40) mode	5755
Temperature : --	Test Date : April 08,2018
Humidity : 65 %	Test By: King Kong

Voltage(V)	Temp(°C)	Test Frequency (MHz)	Max. Deviation (KHz)	Verdict
Vnom	-20	5754.994432	-5.568	Pass
	-10	5754.994214	-5.786	Pass
	0	5754.994159	-5.841	Pass
	10	5754.994347	-5.653	Pass
	20	5754.994459	-5.541	Pass
	30	5754.994261	-5.739	Pass
	40	5754.994226	-5.774	Pass
50	5754.994342	-5.658	Pass	
85% Vnom	20	5754.994751	-5.249	Pass
115% Vnom	20	5754.994643	-5.357	Pass

802.11n(VHT40) mode	5795
Temperature : --	Test Date : April 08,2018
Humidity : 65 %	Test By: King Kong

Voltage(V)	Temp(°C)	Test Frequency (MHz)	Max. Deviation (KHz)	Verdict
Vnom	-20	5794.985856	-14.144	Pass
	-10	5794.985248	-14.752	Pass
	0	5794.985631	-14.369	Pass
	10	5794.985485	-14.515	Pass
	20	5794.985471	-14.529	Pass
	30	5794.986996	-13.004	Pass
	40	5794.985645	-14.355	Pass
	50	5794.985234	-14.766	Pass
85% Vnom	20	5794.985951	-14.049	Pass
115% Vnom	20	5794.986225	-13.775	Pass

802.11ac(VHT40) mode	5190
Temperature : --	Test Date : April 08,2018
Humidity : 65 %	Test By: King Kong

Voltage(V)	Temp(°C)	Test Frequency (MHz)	Max. Deviation (KHz)	Verdict
Vnom	-20	5189.981441	-18.559	Pass
	-10	5189.980124	-19.876	Pass
	0	5189.980369	-19.631	Pass
	10	5189.980554	-19.446	Pass
	20	5189.980572	-19.428	Pass
	30	5189.980592	-19.408	Pass
	40	5189.980324	-19.676	Pass
	50	5189.980361	-19.639	Pass
85% Vnom	20	5189.980257	-19.743	Pass
115% Vnom	20	5189.980851	-19.149	Pass

802.11ac(VHT40) mode	5230
Temperature : --	Test Date : April 08,2018
Humidity : 65 %	Test By: King Kong

Voltage(V)	Temp(°C)	Test Frequency (MHz)	Max. Deviation (KHz)	Verdict
Vnom	-20	5229.984756	-15.244	Pass
	-10	5229.984548	-15.452	Pass
	0	5229.984964	-15.036	Pass
	10	5229.984247	-15.753	Pass
	20	5229.984367	-15.633	Pass
	30	5229.984554	-15.446	Pass
	40	5229.984541	-15.459	Pass
	50	5229.985169	-14.831	Pass
85% Vnom	20	5229.984571	-15.429	Pass
115% Vnom	20	5229.984922	-15.078	Pass

802.11ac(VHT40) mode	5755
Temperature : --	Test Date : April 08,2018
Humidity : 65 %	Test By: King Kong

Voltage(V)	Temp(°C)	Test Frequency (MHz)	Max. Deviation (KHz)	Verdict
Vnom	-20	5754.983685	-16.315	Pass
	-10	5754.983321	-16.679	Pass
	0	5754.984159	-15.841	Pass
	10	5754.983445	-16.555	Pass
	20	5754.983267	-16.733	Pass
	30	5754.983241	-16.759	Pass
	40	5754.983234	-16.766	Pass
	50	5754.983554	-16.446	Pass
85% Vnom	20	5754.983669	-16.331	Pass
115% Vnom	20	5754.983424	-16.576	Pass

802.11ac(VHT40) mode	5795
Temperature : --	Test Date : April 08,2018
Humidity : 65 %	Test By: King Kong

Voltage(V)	Temp(°C)	Test Frequency (MHz)	Max. Deviation (KHz)	Verdict
Vnom	-20	5794.974815	-25.185	Pass
	-10	5794.974574	-25.426	Pass
	0	5794.974523	-25.477	Pass
	10	5794.974259	-25.741	Pass
	20	5794.974654	-25.346	Pass
	30	5794.974582	-25.418	Pass
	40	5794.974224	-25.776	Pass
	50	5794.974556	-25.444	Pass
85% Vnom	20	5794.974542	-25.458	Pass
115% Vnom	20	5794.974562	-25.438	Pass

802.11ac(VHT80) mode	5210
Temperature : --	Test Date : April 08,2018
Humidity : 65 %	Test By: King Kong

Voltage(V)	Temp(°C)	Test Frequency (MHz)	Max. Deviation (KHz)	Verdict
Vnom	-20	5209.969569	-30.431	Pass
	-10	5209.969541	-30.459	Pass
	0	5209.969523	-30.477	Pass
	10	5209.969548	-30.452	Pass
	20	5209.969567	-30.433	Pass
	30	5209.969554	-30.446	Pass
	40	5209.969412	-30.588	Pass
	50	5209.969582	-30.418	Pass
85% Vnom	20	5209.969657	-30.343	Pass
115% Vnom	20	5209.969224	-30.776	Pass

802.11ac(VHT80) mode	5775
Temperature : --	Test Date : April 08,2018
Humidity : 65 %	Test By: King Kong

Voltage(V)	Temp(°C)	Test Frequency (MHz)	Max. Deviation (KHz)	Verdict
Vnom	-20	5774.980542	-19.458	Pass
	-10	5774.980561	-19.439	Pass
	0	5774.980528	-19.472	Pass
	10	5774.980534	-19.466	Pass
	20	5774.980741	-19.259	Pass
	30	5774.980582	-19.418	Pass
	40	5774.980561	-19.439	Pass
	50	5774.980668	-19.332	Pass
85% Vnom	20	5774.981651	-18.349	Pass
115% Vnom	20	5774.980234	-19.766	Pass

8.5 UNDESIRABLE RADIATED SPURIOUS EMISSION

8.5.1 Applicable Standard

According to FCC Part 15.407 (b)
According to 789033 D02 Section II(G)

8.5.2 Conformance Limit

For transmitters operating in the 5.15-5.25 GHz band: All emissions outside of the 5.15-5.35 GHz band shall not exceed an e.i.r.p. of -27 dBm/MHz.

For transmitters operating in the 5.25-5.35 GHz band: All emissions outside of the 5.15-5.35 GHz band shall not exceed an e.i.r.p. of -27 dBm/MHz.

For transmitters operating in the 5.47-5.725 GHz band: All emissions outside of the 5.47-5.725 GHz band shall not exceed an e.i.r.p. of -27 dBm/MHz.

For transmitters operating in the 5.725-5.85 GHz band: All emissions within the frequency range from the band edge to 10 MHz above or below the band edge shall not exceed an e.i.r.p. of -17 dBm/MHz; for frequencies 10 MHz or greater above or below the band edge, emissions shall not exceed an e.i.r.p. of -27 dBm/MHz.

The emission measurements shall be performed using a minimum resolution bandwidth of 1 MHz. A lower resolution bandwidth may be employed near the band edge, when necessary, provided the measured energy is integrated to show the total power over 1 MHz.

Unwanted emissions below 1 GHz must comply with the general field strength limits set forth in §15.209

The emissions from an intentional radiator shall not exceed the field strength levels specified in the following table 15.209(a):

Restricted Frequency(MHz)	Field Strength ($\mu\text{V}/\text{m}$)	Field Strength ($\text{dB}\mu\text{V}/\text{m}$)	Measurement Distance
0.009-0.490	2400/F(KHz)	20 log (uV/m)	300
0.490-1.705	2400/F(KHz)	20 log (uV/m)	30
1.705-30	30	29.5	30
30-88	100	40	3
88-216	150	43.5	3
216-960	200	46	3
Above 960	500	54	3

The provisions of §15.205 apply to intentional radiators operating under this section, 15.205 Restricted bands of operation

MHz	MHz	MHz	GHz
0.090-0.110	16.42-16.423	399.9-410	4.5-5.15
10.495-0.505	16.69475-16.69525	608-614	5.35-5.46
2.1735-2.1905	16.80425-16.80475	960-1240	7.25-7.75
4.125-4.128	25.5-25.67	1300-1427	8.025-8.5
4.17725-4.17775	37.5-38.25	1435-1626.5	9.0-9.2
4.20725-4.20775	73-74.6	1645.5-1646.5	9.3-9.5
6.215-6.218	74.8-75.2	1660-1710	10.6-12.7
6.26775-6.26825	123-138	2200-2300	14.47-14.5
8.291-8.294	149.9-150.05	2310-2390	15.35-16.2
8.362-8.366	156.52475-156.52525	2483.5-2500	17.7-21.4
8.37625-8.38675	156.7-156.9	2690-2900	22.01-23.12
8.41425-8.41475	162.0125-167.17	3260-3267	23.6-24.0
12.29-12.293	167.72-173.2	3332-3339	31.2-31.8
12.51975-12.52025	240-285	3345.8-3358	36.43-36.5
12.57675-12.57725	322-335.4	3600-4400	(2)
13.36-13.41			

- Remark:
1. Emission level in $\text{dB}\mu\text{V}/\text{m}=20 \log (\text{uV}/\text{m})$
 2. Measurement was performed at an antenna to the closed point of EUT distance of meters.
 3. Only spurious frequency is permitted to locate within the Restricted Bands specified in provision of § 15.205, and the emissions located in restricted bands also comply with 15.209 limit.

8.5.3 Test Configuration

Test according to clause 6.2 radio frequency test setup

8.5.4 Test Procedure

■ Unwanted Emissions Measurements below 1000 MHz

Compliance shall be demonstrated using CISPR quasi-peak detection; however, peak detection is permitted as an alternative to quasi-peak detection.

The EUT was placed on a turn table which is 0.8m above ground plane.

And also, each emission was to be maximized by changing the polarization of receiving antenna both horizontal and vertical.

Repeat above procedures until all frequency measured was complete.

We use software control the EUT, Let EUT hopping on and transmit with highest power, All the modes have been tested and the worst result was reported.

Use the following spectrum analyzer settings:

Set RBW=120kHz for $f < 1$ GHz(30MHz to 1GHz), 200Hz for $f < 150$ KHz(9KHz to 150KHz), 9KHz for < 30 MHz (150KHz to 30KHz).

Set the VBW > RBW.

Detector = Peak.

Trace mode = max hold.

Follow the guidelines in ANSI C63.10-2013 with respect to maximizing the emission by rotating the EUT, measuring the emission while the EUT is situated in three orthogonal planes (if appropriate), adjusting the measurement antenna height and polarization, etc. A pre-amp and a high pass filter are required for this test, in order to provide the measuring system with sufficient sensitivity. Allow the trace to stabilize. The peak reading of the emission, after being corrected by the antenna factor, cable loss, pre-amp gain, etc., is the peak field strength, which must comply with the limit specified in Section 15.35(b). Submit this data. Repeat above procedures until all frequency measured was complete.

■ Unwanted Maximum peak Emissions Measurements above 1000 MHz

Maximum emission levels are measured by setting the analyzer as follows:

RBW = 1 MHz.

VBW \geq 3 MHz.

Detector = Peak.

Sweep time = auto.

Trace mode = max hold.

Allow sweeps to continue until the trace stabilizes. Note that if the transmission is not continuous, the time required for the trace to stabilize will increase by a factor of approximately $1/x$, where x is the duty cycle. For example, at 50 percent duty cycle, the measurement time will increase by a factor of two relative to measurement time for continuous transmission.

■ Unwanted Average Emissions Measurements above 1000 MHz

Method VB (Averaging using reduced video bandwidth): Alternative method.

RBW = 1 MHz.

Video bandwidth. • If the EUT is configured to transmit with duty cycle \geq 98 percent, set $VBW \leq RBW/100$ (i.e., 10 kHz) but not less than 10 Hz.

• If the EUT duty cycle is $<$ 98 percent, set $VBW \geq 1/T$, where T is defined in section II.B.1.a).

Video bandwidth mode or display mode • The instrument shall be set to ensure that video filtering is applied in the power domain. Typically, this requires setting the detector mode to RMS and setting the Average-VBW Type to Power (RMS).

• As an alternative, the analyzer may be set to linear detector mode. Ensure that video filtering is applied in linear voltage domain (rather than in a log or dB domain). Some analyzers require linear display mode in order to accomplish this. Others have a setting for Average-VBW Type, which can be set to "Voltage" regardless of the display mode.

Detector = Peak.

Sweep time = auto.

Trace mode = max hold.

Allow max hold to run for at least 50 traces if the transmitted signal is continuous or has at least 98 percent duty cycle. For lower duty cycles, increase the minimum number of traces by a factor of $1/x$, where x is the duty cycle. For example, use at least 200 traces if the duty cycle is 25 percent. (If a specific emission is demonstrated to be continuous—i.e., 100 percent duty cycle—rather than turning on and off with the transmit cycle, at least 50 traces shall be averaged.)

■ Band edge measurements.

Unwanted band-edge emissions may be measured using either of the special band-edge measurement techniques (the marker-delta or integration methods) described below. Note that the marker-delta method is primarily a radiated measurement technique that requires the 99% occupied bandwidth edge to be within 2 MHz of the authorized band edge, whereas the integration method can be used in either a radiated or conducted measurement without any special requirement with regards to the displacement of the unwanted emission(s) relative to the authorized bandwidth.

Marker-Delta Method.

The marker-delta method, as described in ANSI C63.10, can be used to perform measurements of the radiated unwanted emissions level of emissions provided that the 99% occupied bandwidth of the fundamental is within 2 MHz of the authorized band-edge.

8.5.5 Test Results

■ For Undesirable radiated Spurious Emission in UNII Band I

The voltage 120V & 240V and the modes 802.11a/n/ac has been tested and the worst result (801.11n(VHT20)) recorded as below:

● ☒ Undesirable radiated Spurious Emission Above 1GHz (1GHz to 40GHz)

Temperature :	28°C	Test Date :	April 08,2018
Humidity :	65 %	Test By:	King Kong
Test mode:	801.11n(VHT20)	Frequency(MHz):	5180

Freq. (MHz)	Ant.Pol. H/V	Field Strength (dBuV/m)	E.I.R.P (dBm)	Limit (dBm)	Over(dB)
7090.32	V	54.48	-40.75	-27	-13.75
9778.73	V	59.54	-35.69	-27	-8.69
13159.31	V	60.15	-35.08	-27	-8.08
6954.23	H	55.26	-39.97	-27	-12.97
10322.76	H	60.57	-34.66	-27	-7.66
13346.24	H	61.82	-33.41	-27	-6.41

Temperature :	28°C	Test Date :	April 08,2018
Humidity :	65 %	Test By:	King Kong
Test mode:	801.11n(VHT20)	Frequency(MHz):	5220

Freq. (MHz)	Ant.Pol. H/V	Field Strength (dBuV/m)	E.I.R.P (dBm)	Limit (dBm)	Over(dB)
7088.95	V	54.41	-40.82	-27	-13.82
8120.73	V	54.75	-40.48	-27	-13.48
13160.36	V	59.52	-35.71	-27	-8.71
6952.89	H	55.36	-39.87	-27	-12.87
10323.82	H	59.84	-35.39	-27	-8.39
13344.89	H	58.59	-36.64	-27	-9.64

Temperature :	28°C	Test Date :	April 08,2018
Humidity :	65 %	Test By:	King Kong
Test mode:	801.11n(VHT20)	Frequency(MHz):	5240

Freq. (MHz)	Ant.Pol. H/V	Field Strength (dBuV/m)	E.I.R.P (dBm)	Limit (dBm)	Over(dB)
7087.43	V	53.12	-42.11	-27	-15.11
9780.78	V	59.36	-35.87	-27	-8.87
13158.85	V	59.34	-35.89	-27	-8.89
6951.43	H	54.45	-40.78	-27	-13.78
10324.8	H	59.85	-35.38	-27	-8.38
13343.45	H	59.34	-35.89	-27	-8.89

Note: (1) All Readings are Peak Value (VBW=3MHz) and Peak Value (VBW=10Hz).
 (2) Emission Level= Reading Level+Probe Factor +Cable Loss.
 (3)EIRP[dBm] = E[dBμV/m] + 20 log(d[meters]) - 104.77
 d is the measurement distance in 3 meters

● Undesirable radiated Undesirable radiated Spurious Emission in Band Edge

Temperature :	28°C	Test Date :	April 08,2018
Humidity :	65 %	Test By:	King Kong
Test mode:	801.11n(VHT20)	Frequency(MHz):	5180

Freq. (MHz)	Ant.Pol. H/V	Field Strength (RBW=100KHz) (dBuV/m)	E.I.R.P (dBm)	Limit (dBm)	Verdict
5149.05	H	68.85	-26.38	-27	Pass
5138.55	V	68.67	-26.56	-27	Pass

Temperature :	28°C	Test Date :	April 08,2018
Humidity :	65 %	Test By:	King Kong
Test mode:	801.11n(VHT20)	Frequency(MHz):	5240

Freq. (MHz)	Ant.Pol. H/V	Field Strength (RBW=100KHz) (dBuV/m)	E.I.R.P (dBm)	Limit (dBm)	Verdict
5352.15	V	68.49	-26.74	-27	Pass
5359.05	H	68.91	-26.32	-27	Pass

Note: (1) All Readings are Peak Value (VBW=3MHz) and AV Value (VBW=10Hz).
 (2) Emission Level= Reading Level+Probe Factor +Cable Loss.
 (3)EIRP[dBm] = E[dBuV/m] + 20 log(d[meters]) - 104.77
 d is the measurement distance in 3 meters

UNII Band I

Test Model Undesirable radiated Spurious Emission in Restricted Band (5100-5150MHz)

<input checked="" type="checkbox"/> 5180	<input type="checkbox"/> 802.11a	<input checked="" type="checkbox"/> 802.11n(HT20)	<input type="checkbox"/> 802.11n(HT40)
<input type="checkbox"/> 5200	<input type="checkbox"/> 5240	Ant.Pol	H

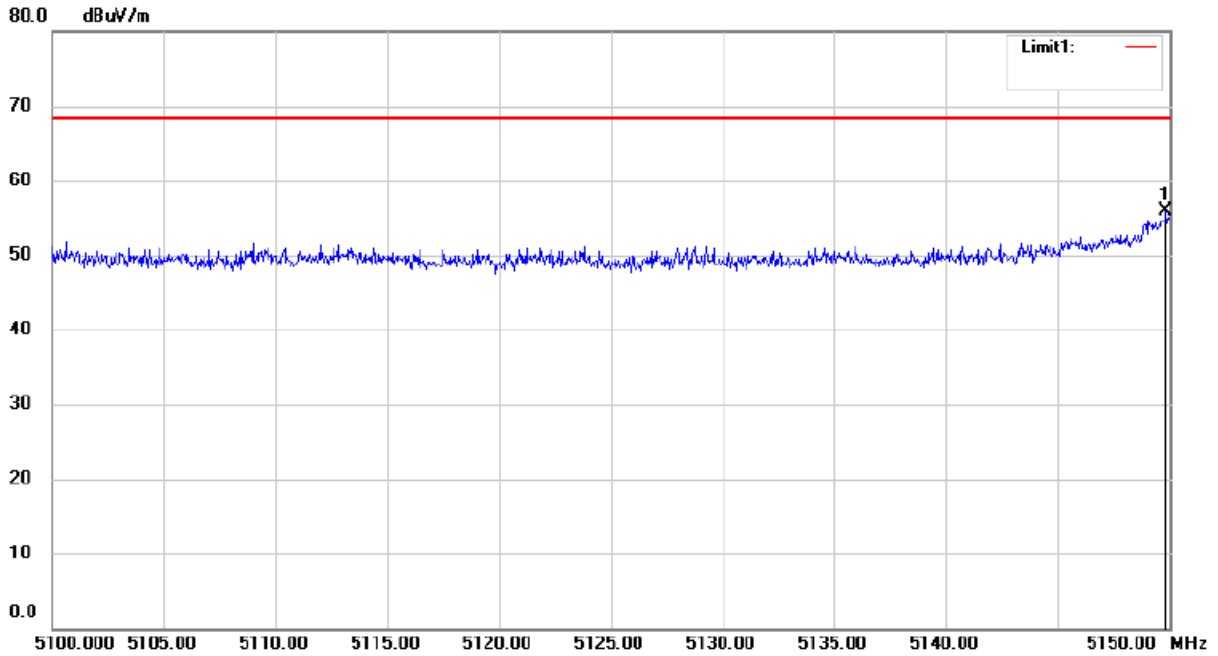

UNII Band I

Test Model Undesirable radiated Spurious Emission in Restricted Band (5100-5150MHz)

<input checked="" type="checkbox"/> 5180	<input type="checkbox"/> 802.11a	<input checked="" type="checkbox"/> 802.11n(HT20)	<input type="checkbox"/> 802.11n(HT40)
<input type="checkbox"/> 5200	<input type="checkbox"/> 5240	Ant.Pol	V

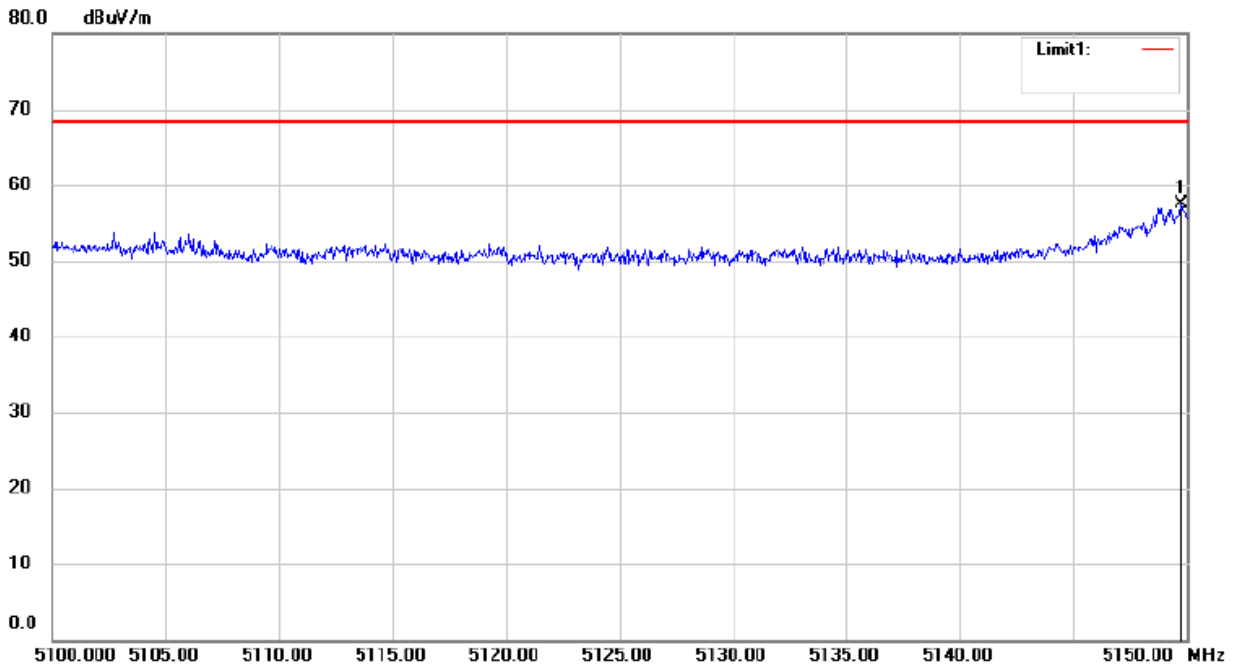

UNII Band I

Test Model Undesirable radiated Spurious Emission in Restricted Band (5350-5400MHz)

<input type="checkbox"/> 5180	<input type="checkbox"/> 802.11a	<input checked="" type="checkbox"/> 802.11n(HT20)	<input type="checkbox"/> 802.11n(HT40)
	<input type="checkbox"/> 5200	<input checked="" type="checkbox"/> 5240	Ant.Pol H

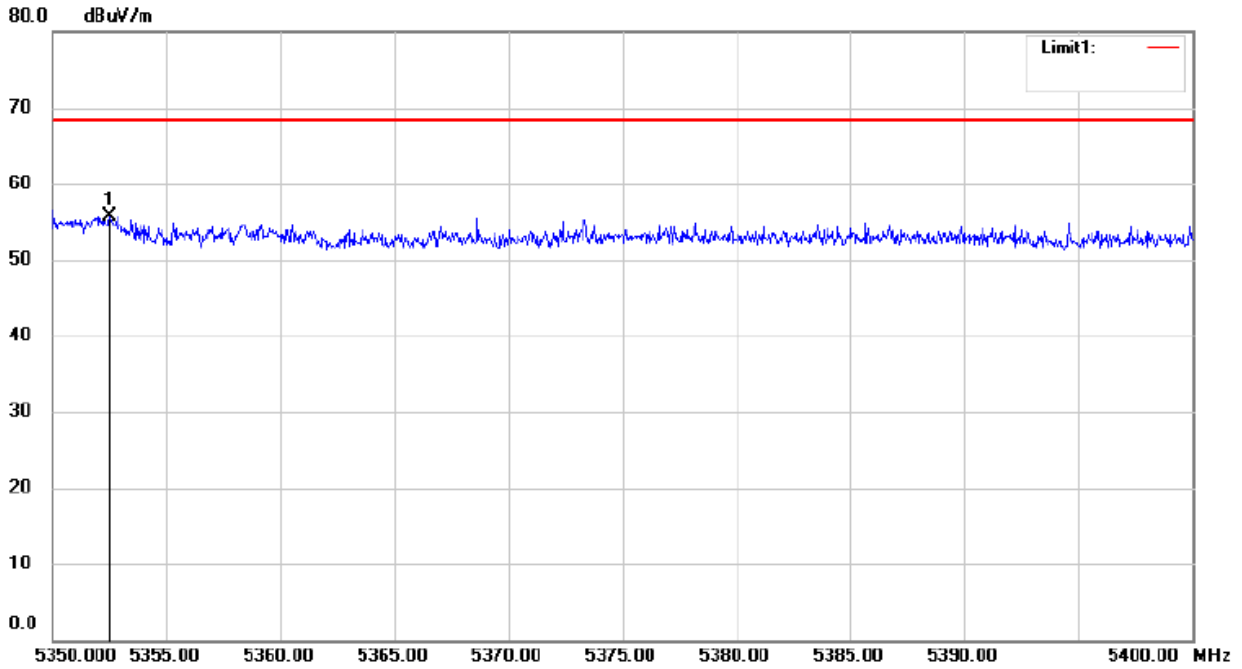

UNII Band I

Test Model Undesirable radiated Spurious Emission in Restricted Band (5350-5400MHz)

<input type="checkbox"/> 5180	<input type="checkbox"/> 802.11a	<input checked="" type="checkbox"/> 802.11n(HT20)	<input type="checkbox"/> 802.11n(HT40)
	<input type="checkbox"/> 5200	<input checked="" type="checkbox"/> 5240	Ant.Pol V

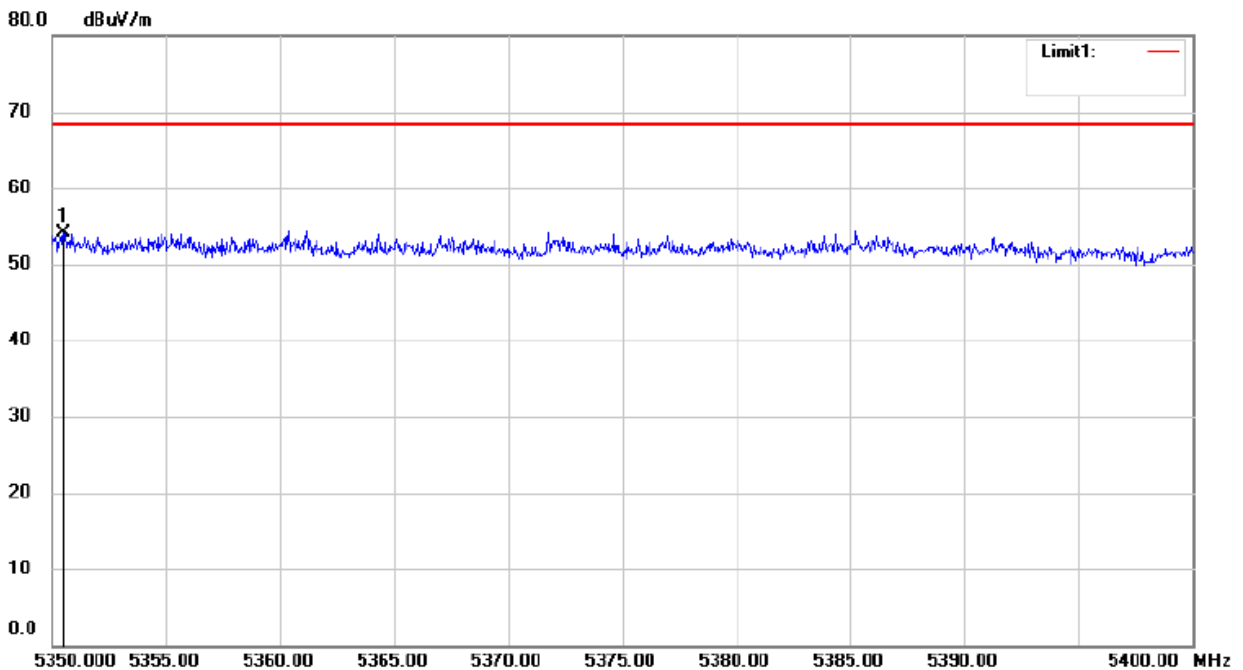

- For Undesirable radiated Spurious Emission in UNII Band III

All the modes 802.11a/n/ac has been tested and the worst result 802.11(HT20) recorded as below:

- Undesirable radiated Spurious Emission Above 1GHz (1GHz to 40GHz)

Temperature :	28°C	Test Date :	April 08,2018
Humidity :	65 %	Test By:	King Kong
Test mode:	802.11(HT20)	Frequency(MHz):	5745

Freq. (MHz)	Ant.Pol. H/V	Field Strength (dBuV/m)	E.I.R.P (dBm)	Limit (dBm)	Over(dB)
7142.69	V	50.75	-44.48	-27.00	-17.48
9838.38	V	51.24	-43.99	-27.00	-16.99
13214.11	V	67.36	-27.87	-27.00	-0.87
7004.02	H	55.74	-39.49	-27.00	-12.49
10382.46	H	60.82	-34.41	-27.00	-7.41
13398.47	H	63.36	-31.87	-27.00	-4.87

Temperature :	28°C	Test Date :	April 08,2018
Humidity :	65 %	Test By:	King Kong
Test mode:	802.11(HT20)	Frequency(MHz):	5785

Freq. (MHz)	Ant.Pol. H/V	Field Strength (dBuV/m)	E.I.R.P (dBm)	Limit (dBm)	Over(dB)
7141.34	V	45.77	-49.46	-27.00	-22.46
9837	V	46.24	-48.99	-27.00	-21.99
13215.18	V	59.25	-35.98	-27.00	-8.98
7005.12	H	48.34	-46.89	-27.00	-19.89
10381.03	H	52.85	-42.38	-27.00	-15.38
13399.45	H	55.26	-39.97	-27.00	-12.97

Temperature :	28°C	Test Date :	April 08,2018
Humidity :	65 %	Test By:	King Kong
Test mode:	802.11(HT20)	Frequency(MHz):	5825

Freq. (MHz)	Ant.Pol. H/V	Field Strength (dBuV/m)	E.I.R.P (dBm)	Limit (dBm)	Over(dB)
7142.41	V	45.75	-49.48	-27.00	-22.48
9835.63	V	46.15	-49.08	-27.00	-22.08
13216.22	V	59.34	-35.89	-27.00	-8.89
7006.17	H	47.07	-48.16	-27.00	-21.16
10379.69	H	51.58	-43.65	-27.00	-16.65
13400.51	H	54.96	-40.27	-27.00	-13.27

- Note:** (1) All Readings are Peak Value (VBW=3MHz) and Peak Value (VBW=10Hz).
 (2) Emission Level= Reading Level+Probe Factor +Cable Loss.
 (3) EIRP[dBm] = E[dBμV/m] + 20 log(d[meters]) - 104.77
 d is the measurement distance in 3 meters

- Undesirable radiated Spurious Emission in band edge

Temperature :	28°C	Test Date :	April 08,2018
Humidity :	65 %	Test By:	King Kong
Test mode:	802.11a	Frequency:	5745

Freq. (MHz)	Ant.Pol. H/V	Field Strength (RBW=100KHz) (dBuV/m)	E.I.R.P (dBm)	Limit (dBm)	Verdict
5725.00	H	50.88	-44.35	-17	PASS
5724.75	V	48.45	-46.78	-17	PASS

Temperature :	28°C	Test Date :	April 08,2018
Humidity :	65 %	Test By:	King Kong
Test mode:	802.11a	Frequency:	5825

Freq. (MHz)	Ant.Pol. H/V	Field Strength (RBW=100KHz) (dBuV/m)	E.I.R.P (dBm)	Limit (dBm)	Verdict
5881.75	H	51.26	-43.97	-17	PASS
5874.87	V	49.67	-45.56	-17	PASS

Note: (1) All Readings are Peak Value (VBW=3MHz) and AV Value (VBW=10Hz).

(2) Emission Level= Reading Level+Probe Factor +Cable Loss.

(3)EIRP[dBm] = E[dBuV/m] + 20 log(d[meters]) - 104.77

d is the measurement distance in 3 meters

UNII Band III

Test Model	Undesirable radiated <input type="checkbox"/> 802.11a	Undesirable radiated <input checked="" type="checkbox"/> 5745	Spurious Emission in Band Edge <input checked="" type="checkbox"/> 802.11n(HT20)	Spurious Emission in Band Edge <input type="checkbox"/> 802.11n(HT40)
			Ant.Pol	H

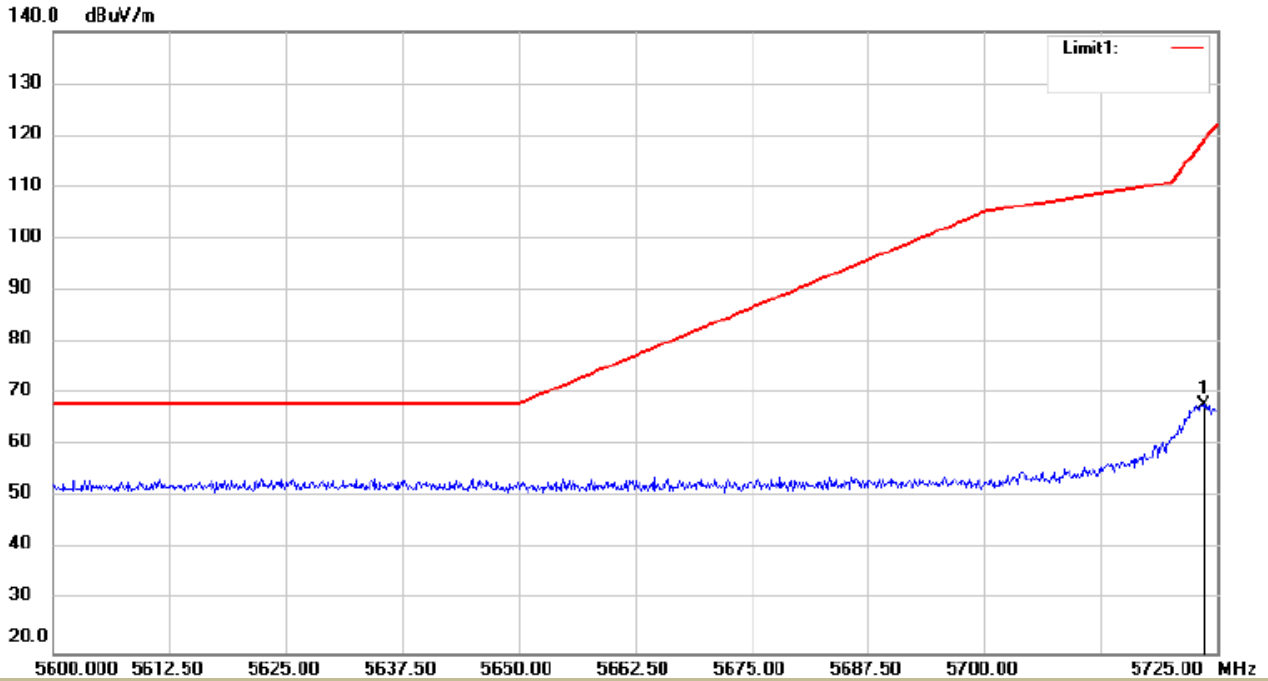

UNII Band III

Test Model	Undesirable radiated <input type="checkbox"/> 802.11a	Undesirable radiated <input checked="" type="checkbox"/> 5745	Spurious Emission in Band Edge <input checked="" type="checkbox"/> 802.11n(HT20)	Spurious Emission in Band Edge <input type="checkbox"/> 802.11n(HT40)
			Ant.Pol	V

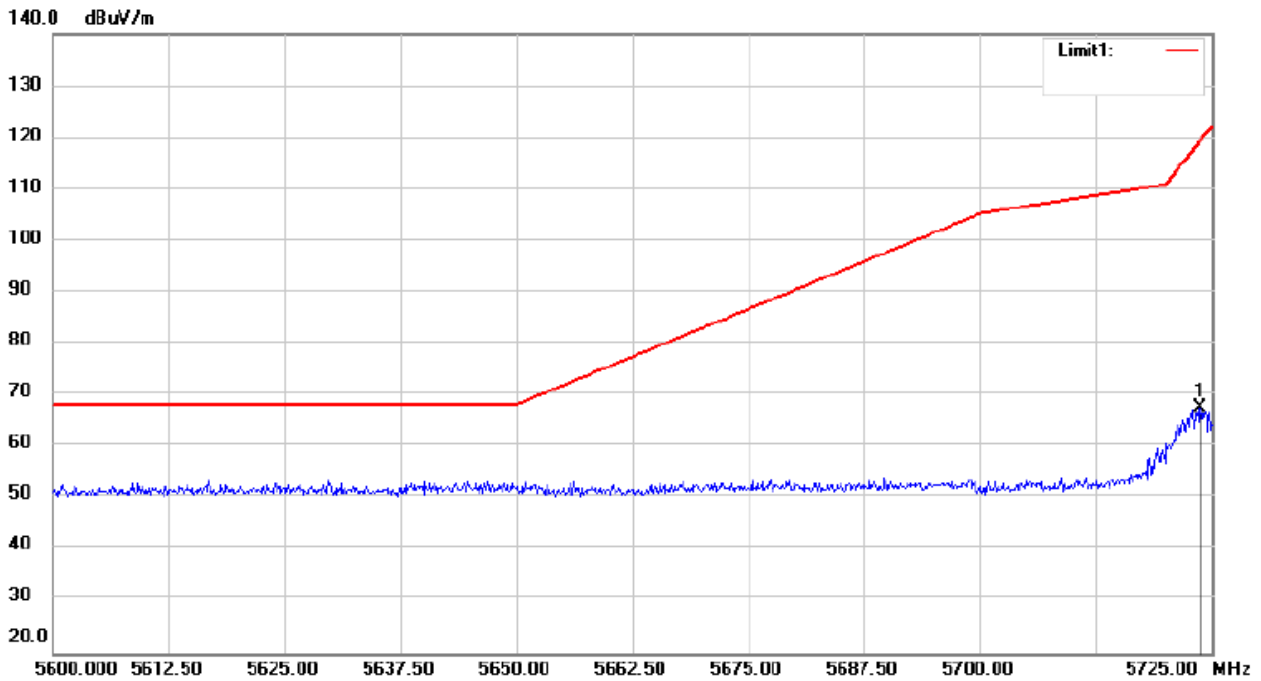

UNII Band III

Test Model	Undesirable radiated	Undesirable radiated	Spurious Emission in Band Edge
	<input type="checkbox"/> 802.11a	<input checked="" type="checkbox"/> 802.11n(HT20)	<input type="checkbox"/> 802.11n(HT40)
		<input checked="" type="checkbox"/> 5825	
			Ant.Pol: H

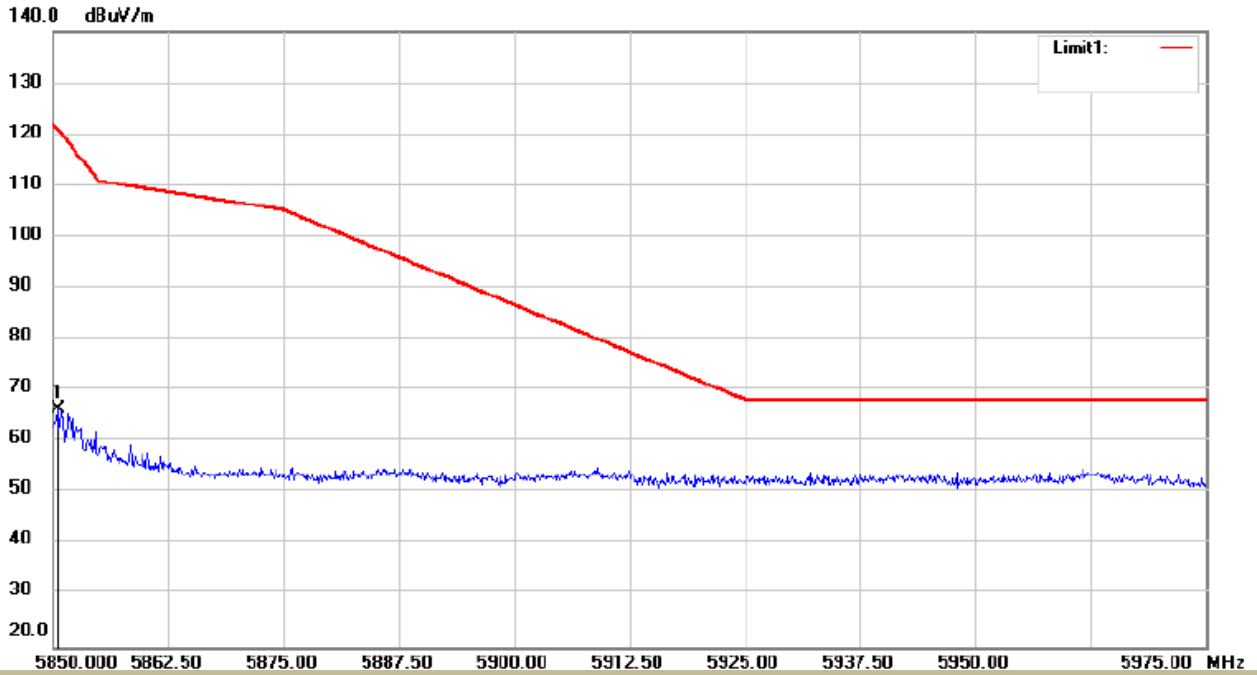

UNII Band III

Test Model	Undesirable radiated	Undesirable radiated	Spurious Emission in Band Edge
	<input type="checkbox"/> 802.11a	<input checked="" type="checkbox"/> 802.11n(HT20)	<input type="checkbox"/> 802.11n(HT40)
		<input checked="" type="checkbox"/> 5825	
			Ant.Pol: V

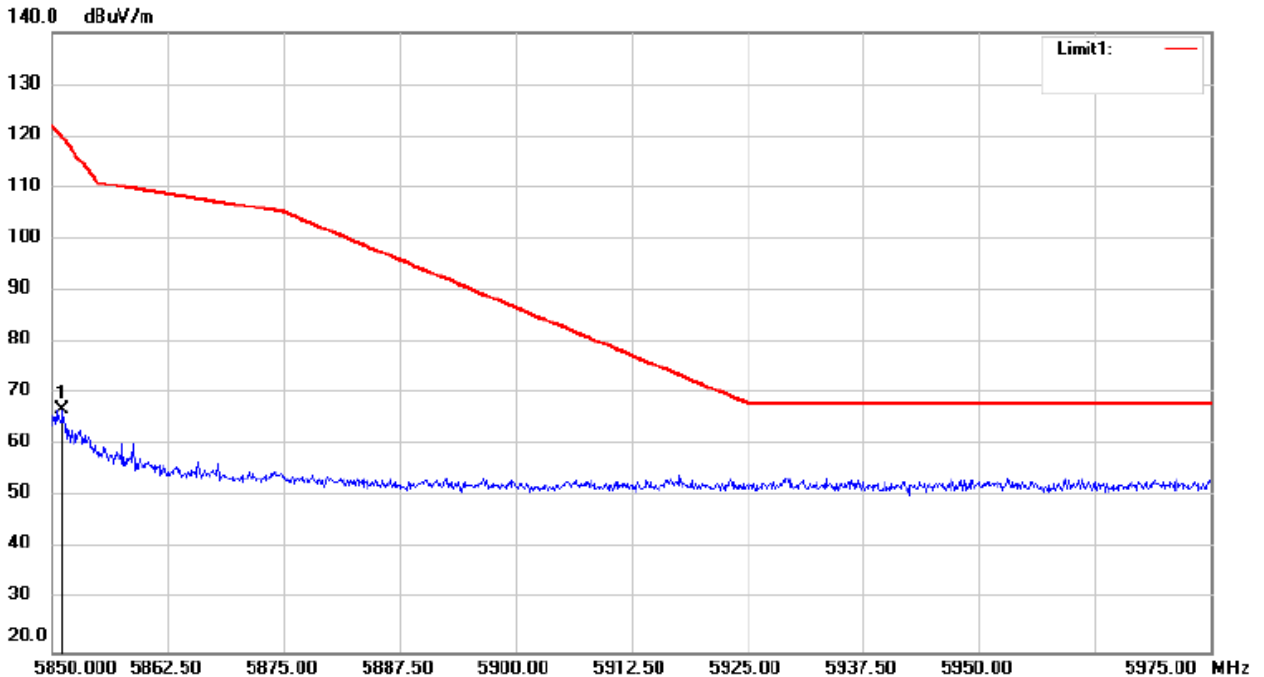

● Undesirable radiated Spurious Emission below 1GHz (30MHz to 1GHz)

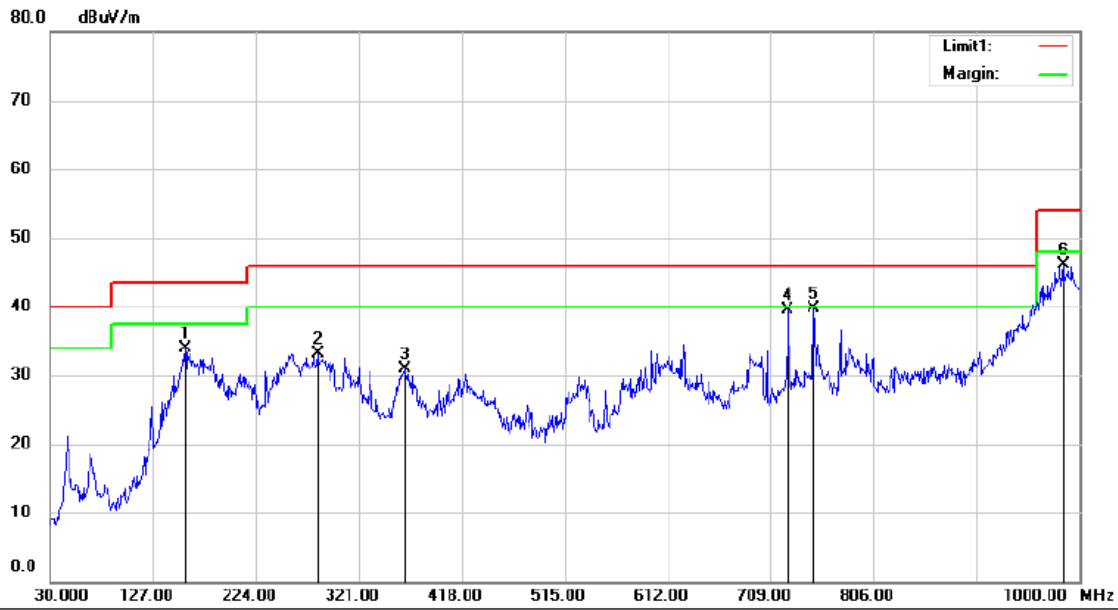

Site 3m Chamber 3# Polarization: **Horizontal** Temperature: 24 C
 Limit: (RE)FCC PART 15 CLASS B Power: AC 120V/60Hz Humidity: 53 %
 Mode:WIFI5G A20(5180MHz)
 Note:

No.	Mk.	Freq.	Reading Level	Correct Factor	Measurement	Limit	Over	Antenna Height	Table Degree	
		MHz	dBuV	dB	dBuV/m	dBuV/m	dB	cm	degree	Comment
1		157.0700	52.61	-18.61	34.00	43.50	-9.50	QP		
2		282.2000	45.98	-12.80	33.18	46.00	-12.82	QP		
3		363.6800	41.66	-10.66	31.00	46.00	-15.00	QP		
4		725.4900	42.62	-3.18	39.44	46.00	-6.56	QP		
5	*	749.7400	42.36	-2.71	39.65	46.00	-6.35	QP		
6		984.4800	44.86	1.27	46.13	54.00	-7.87	QP		

*:Maximum data x:Over limit !:over margin

Operator: LQZ

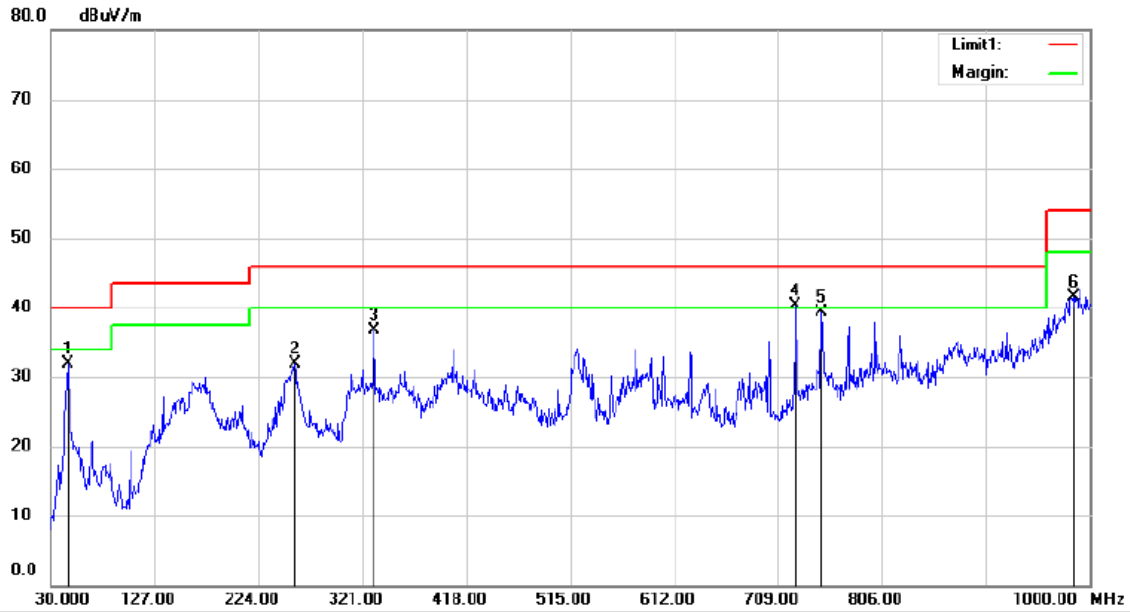

Site: 3m Chamber 3# Polarization: **Vertical** Temperature: 24 C
 Limit: (RE)FCC PART 15 CLASS B Power: AC 120V/60Hz Humidity: 53 %
 Mode: WIFI5G A20(5180MHz)
 Note:

No.	Mk.	Freq. MHz	Reading Level dBuV	Correct Factor dB	Measure- ment dBuV/m	Limit dBuV/m	Over dB	Antenna Height cm	Table Degree	Comment
1		45.5200	46.05	-14.07	31.98	40.00	-8.02	QP		
2		257.9500	45.35	-13.50	31.85	46.00	-14.15	QP		
3		331.6700	48.04	-11.30	36.74	46.00	-9.26	QP		
4	*	725.4900	43.49	-3.18	40.31	46.00	-5.69	QP		
5		749.7400	41.95	-2.71	39.24	46.00	-6.76	QP		
6		984.4800	40.17	1.27	41.44	54.00	-12.56	QP		

*:Maximum data x:Over limit !:over margin

Operator: LQZ

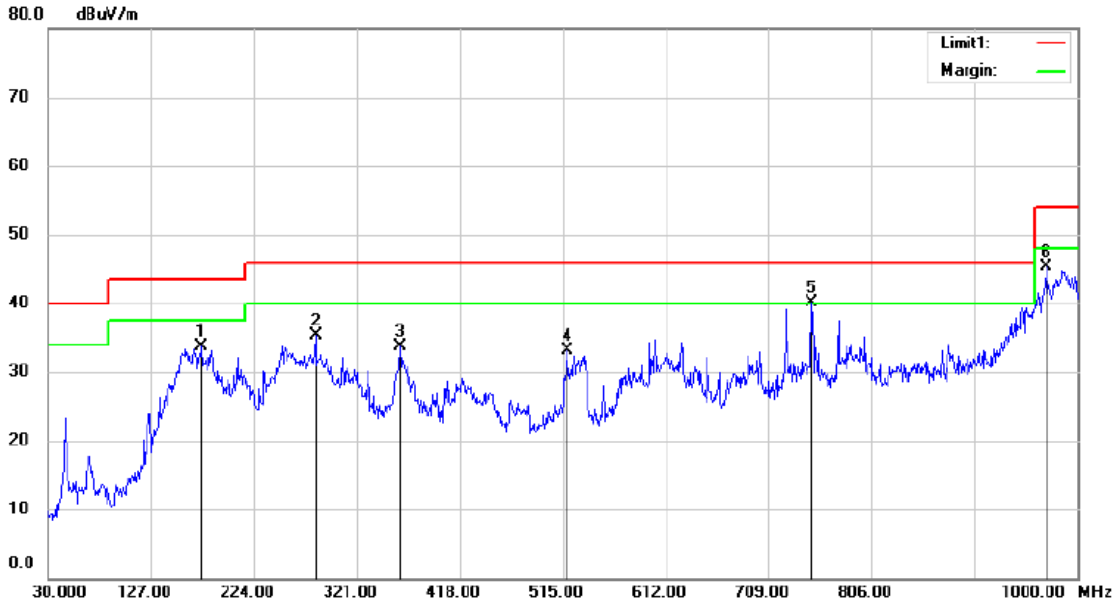

Site 3m Chamber 3# Polarization: **Horizontal** Temperature: 24 C
 Limit: (RE)FCC PART 15 CLASS B Power: AC 120V/60Hz Humidity: 53 %
 Mode:WIFI5G A20(5200MHz)
 Note:

No.	Mk.	Freq. MHz	Reading Level dBuV	Correct Factor dB	Measure- ment dBuV/m	Limit dBuV/m	Over dB	Antenna Height cm	Table Degree degree	Comment
1		174.5300	51.53	-17.84	33.69	43.50	-9.81	QP		
2		282.2000	48.08	-12.80	35.28	46.00	-10.72	QP		
3		361.7400	44.42	-10.65	33.77	46.00	-12.23	QP		
4		518.8800	40.14	-7.13	33.01	46.00	-12.99	QP		
5	*	749.7400	42.88	-2.71	40.17	46.00	-5.83	QP		
6		970.9000	44.48	0.92	45.40	54.00	-8.60	QP		

*:Maximum data x:Over limit !:over margin

Operator: LQZ

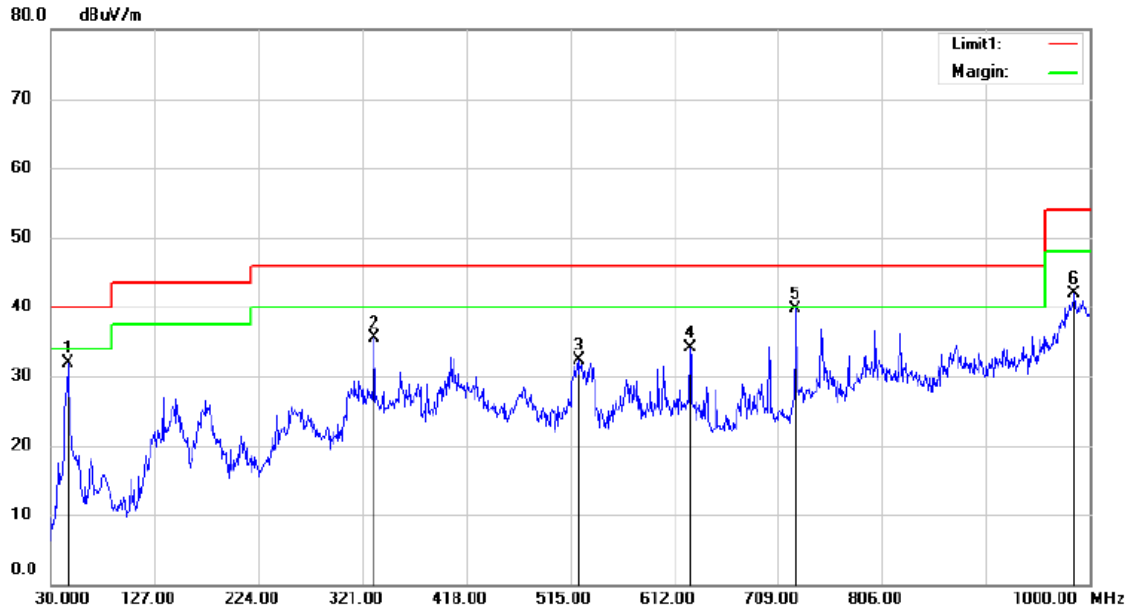

Site 3m Chamber 3# Polarization: *Vertical* Temperature: 24 C
 Mode: WIFI5G A20(5200MHz)
 Note:

No.	Mk.	Freq. MHz	Reading Level dBuV	Correct Factor dB	Measure- ment dBuV/m	Limit dBuV/m	Over dB	Antenna Height cm	Table Degree degree	Comment
1		45.5200	45.94	-14.07	31.87	40.00	-8.13			QP
2		331.6700	46.71	-11.30	35.41	46.00	-10.59			QP
3		522.7600	39.32	-6.98	32.34	46.00	-13.66			QP
4		626.5500	38.78	-4.74	34.04	46.00	-11.96			QP
5	*	725.4900	42.89	-3.18	39.71	46.00	-6.29			QP
6		985.4500	40.56	1.27	41.83	54.00	-12.17			QP

*:Maximum data x:Over limit !:over margin

Operator: LQZ

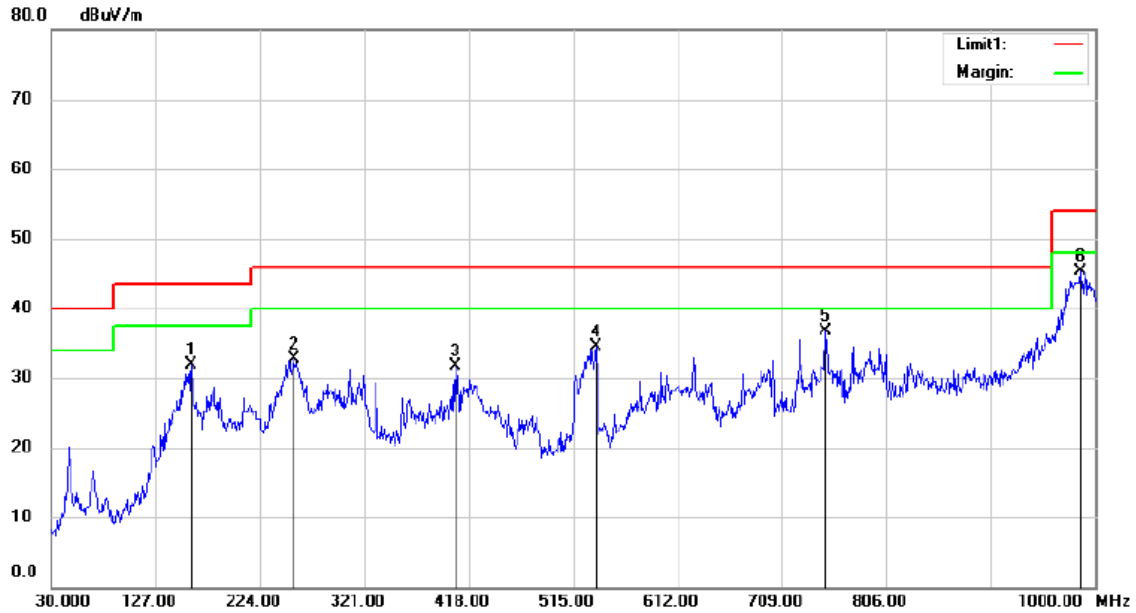

Site 3m Chamber 3# Polarization: **Horizontal** Temperature: 24 C
 Mode: WIFI5G A20(5240MHz)
 Note:

No.	Mk.	Freq. MHz	Reading Level dBuV	Correct Factor dB	Measure- ment dBuV/m	Limit dBuV/m	Over dB	Detector	Antenna Height cm	Table Degree degree	Comment
1		159.9800	50.30	-18.41	31.89	43.50	-11.61	QP			
2		255.0400	46.23	-13.51	32.72	46.00	-13.28	QP			
3		405.3900	41.25	-9.49	31.76	46.00	-14.24	QP			
4		536.3400	41.16	-6.75	34.41	46.00	-11.59	QP			
5		749.7400	39.50	-2.71	36.79	46.00	-9.21	QP			
6	*	986.4200	44.03	1.26	45.29	54.00	-8.71	QP			

*:Maximum data x:Over limit !:over margin

Operator: LQZ

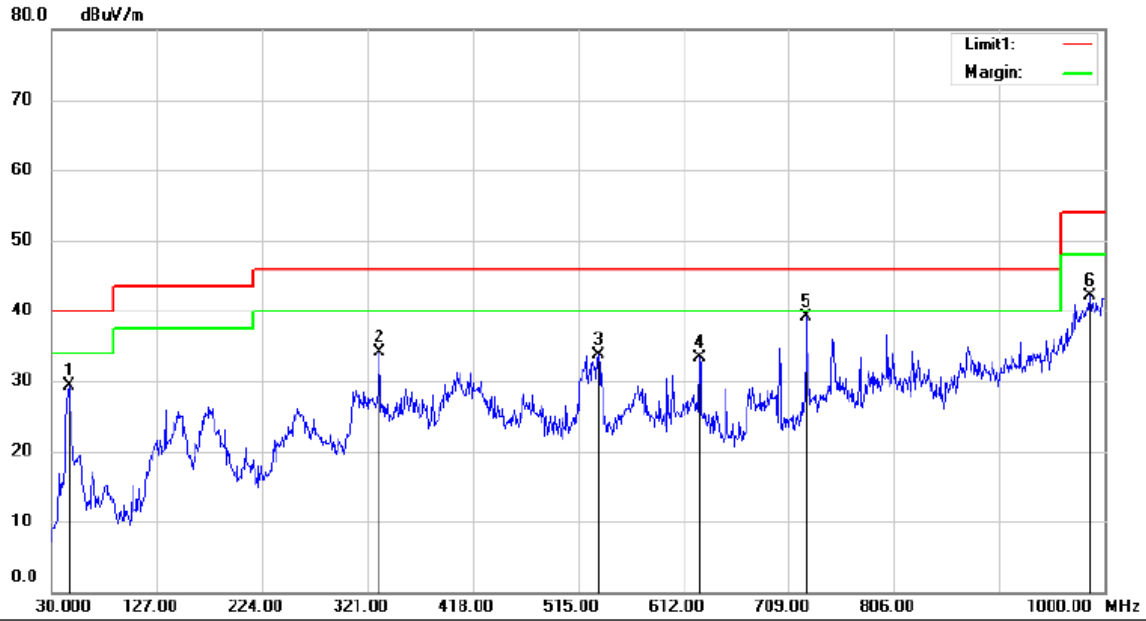

Site 3m Chamber 3# Polarization: *Vertical* Temperature: 24 C
 Mode: WIFI5G A20(5240MHz)
 Note:

No.	Mk.	Freq. MHz	Reading Level dBuV	Correct Factor dB	Measure- ment dBuV/m	Limit dBuV/m	Over dB	Detector	Antenna Height cm	Table Degree	Comment
1		45.5200	43.47	-14.07	29.40	40.00	-10.60	QP			
2		331.6700	45.48	-11.30	34.18	46.00	-11.82	QP			
3		533.4300	40.41	-6.71	33.70	46.00	-12.30	QP			
4		626.5500	38.11	-4.74	33.37	46.00	-12.63	QP			
5	*	725.4900	42.20	-3.18	39.02	46.00	-6.98	QP			
6		986.4200	40.80	1.26	42.06	54.00	-11.94	QP			

*:Maximum data x:Over limit l:over margin

Operator: LQZ

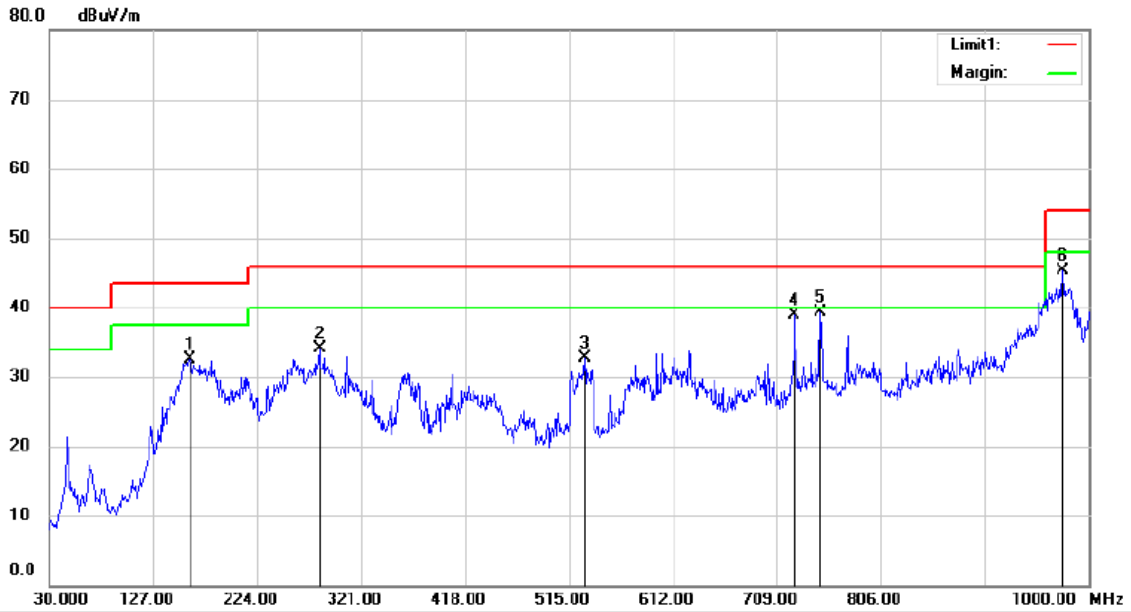

Site: 3m Chamber 3# Polarization: **Horizontal** Temperature: 24 C
 Limit: (RE)FCC PART 15 CLASS B Power: AC 120V/60Hz Humidity: 53 %
 Mode: WIFI5G A20(5745MHz)
 Note:

No.	Mk.	Freq.	Reading Level	Correct Factor	Measurement	Limit	Over	Antenna Height	Table Degree	
		MHz	dBuV	dB	dBuV/m	dBuV/m	dB	cm	degree	Comment
1		160.9500	50.96	-18.39	32.57	43.50	-10.93			QP
2		282.2000	46.88	-12.80	34.08	46.00	-11.92			QP
3		529.5500	39.32	-6.67	32.65	46.00	-13.35			QP
4		725.4900	42.08	-3.18	38.90	46.00	-7.10			QP
5	*	749.7400	42.09	-2.71	39.38	46.00	-6.62			QP
6		975.7500	44.11	1.13	45.24	54.00	-8.76			QP

*:Maximum data x:Over limit !:over margin

Operator: LQZ

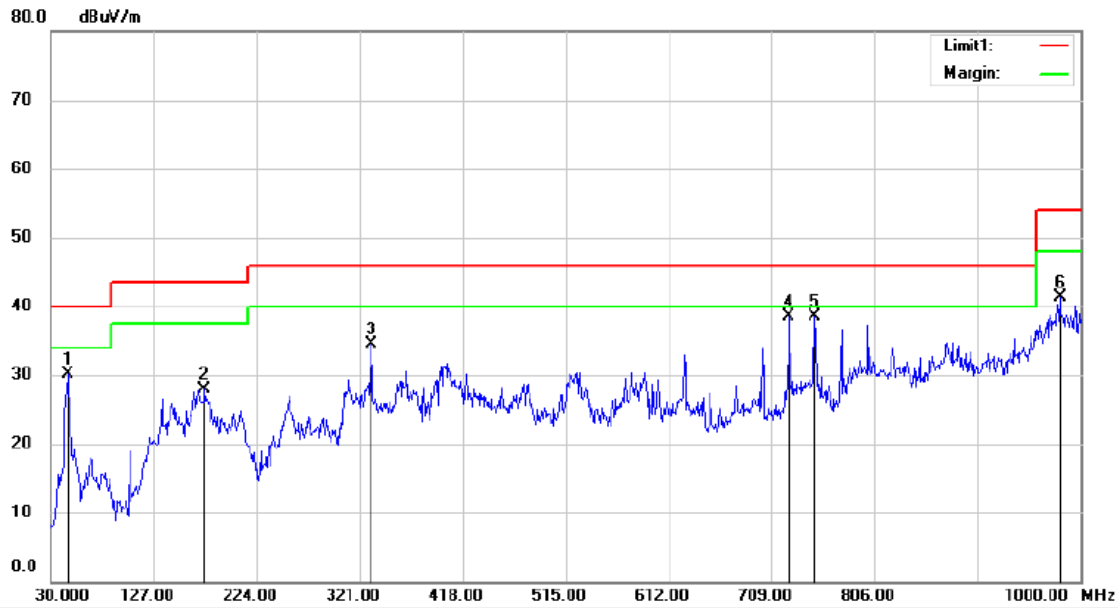

Site 3m Chamber 3# Polarization: **Vertical** Temperature: 24 C
 Limit: (RE)FCC PART 15 CLASS B Power: AC 120V/60Hz Humidity: 53 %
 Mode: WIFI5G A20(5745MHz)
 Note:

No.	Mk.	Freq. MHz	Reading Level dBuV	Correct Factor dB	Measure- ment dBuV/m	Limit dBuV/m	Over dB	Antenna Height cm	Table Degree	Comment
1		45.5200	44.26	-14.07	30.19	40.00	-9.81	QP		
2		174.5300	45.68	-17.84	27.84	43.50	-15.66	QP		
3		331.6700	45.88	-11.30	34.58	46.00	-11.42	QP		
4	*	725.4900	41.63	-3.18	38.45	46.00	-7.55	QP		
5		749.7400	41.15	-2.71	38.44	46.00	-7.56	QP		
6		980.6000	40.03	1.29	41.32	54.00	-12.68	QP		

*:Maximum data x:Over limit !:over margin

Operator: LQZ

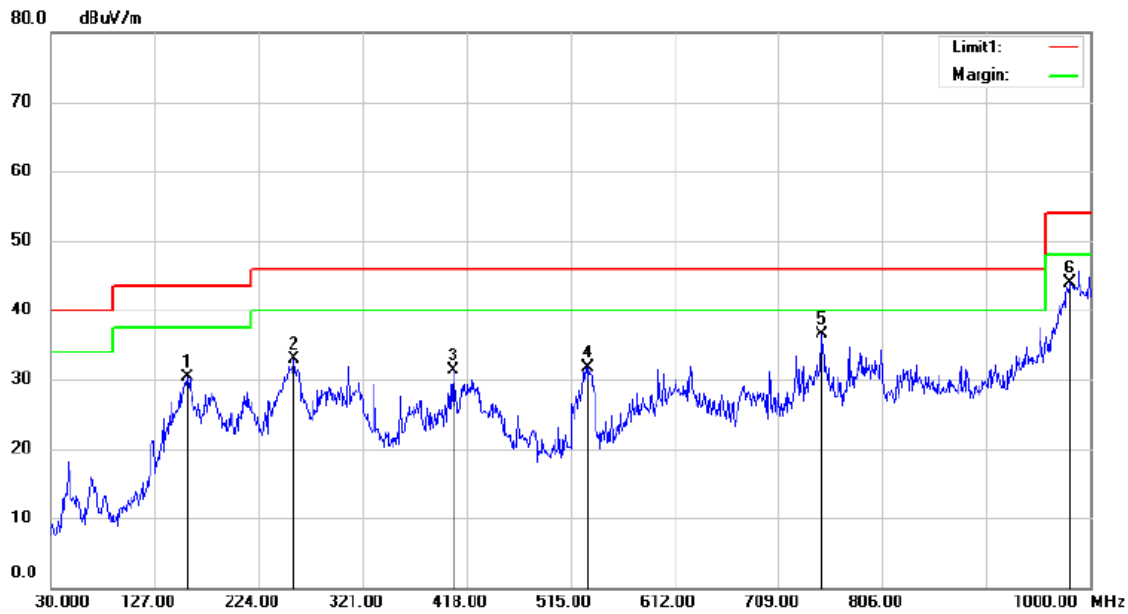

Site 3m Chamber 3# Polarization: *Horizontal* Temperature: 24 C
 Limit: (RE)FCC PART 15 CLASS B Power: AC 120V/60Hz Humidity: 53 %
 Mode:WIFI5G A20(5785MHz)
 Note:

No.	Mk.	Freq. MHz	Reading Level dBuV	Correct Factor dB	Measure- ment dBuV/m	Limit dBuV/m	Over dB	Antenna Height cm	Table Degree	Comment
1		157.0700	48.89	-18.61	30.28	43.50	-13.22	QP		
2		256.9800	46.32	-13.50	32.82	46.00	-13.18	QP		
3		405.3900	40.82	-9.49	31.33	46.00	-14.67	QP		
4		531.4900	38.48	-6.68	31.80	46.00	-14.20	QP		
5	*	749.7400	39.26	-2.71	36.55	46.00	-9.45	QP		
6		981.5700	42.70	1.29	43.99	54.00	-10.01	QP		

*:Maximum data x:Over limit !:over margin

Operator: LQZ

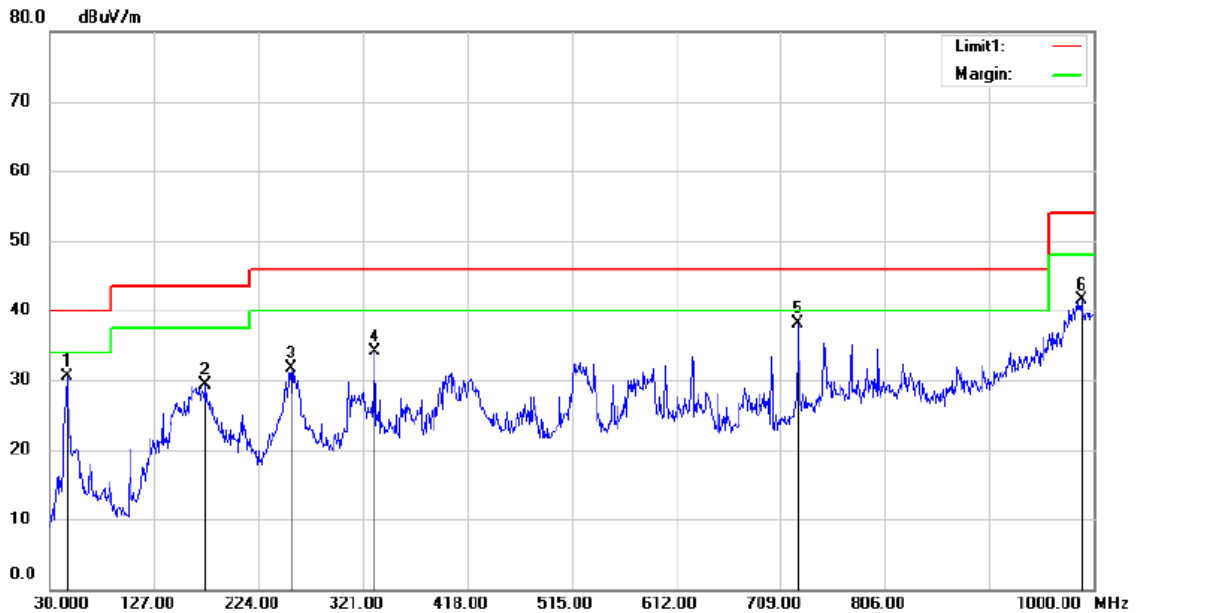

Site 3m Chamber 3# Polarization: **Vertical** Temperature: 24 C
 Limit: (RE)FCC PART 15 CLASS B Power: AC 120V/60Hz Humidity: 53 %
 Mode: WIFI5G A20(5785MHz)
 Note:

No.	Mk.	Freq.	Reading Level	Correct Factor	Measurement	Limit	Over	Antenna Height	Table Degree	Comment
		MHz	dBuV	dB	dBuV/m	dBuV/m	dB	cm	degree	
1		45.5200	44.56	-14.07	30.49	40.00	-9.51	QP		
2		174.5300	47.11	-17.84	29.27	43.50	-14.23	QP		
3		254.0700	45.25	-13.56	31.69	46.00	-14.31	QP		
4		331.6700	45.36	-11.30	34.06	46.00	-11.94	QP		
5	*	725.4900	41.20	-3.18	38.02	46.00	-7.98	QP		
6		988.3600	40.32	1.25	41.57	54.00	-12.43	QP		

*:Maximum data x:Over limit !:over margin

Operator: LQZ

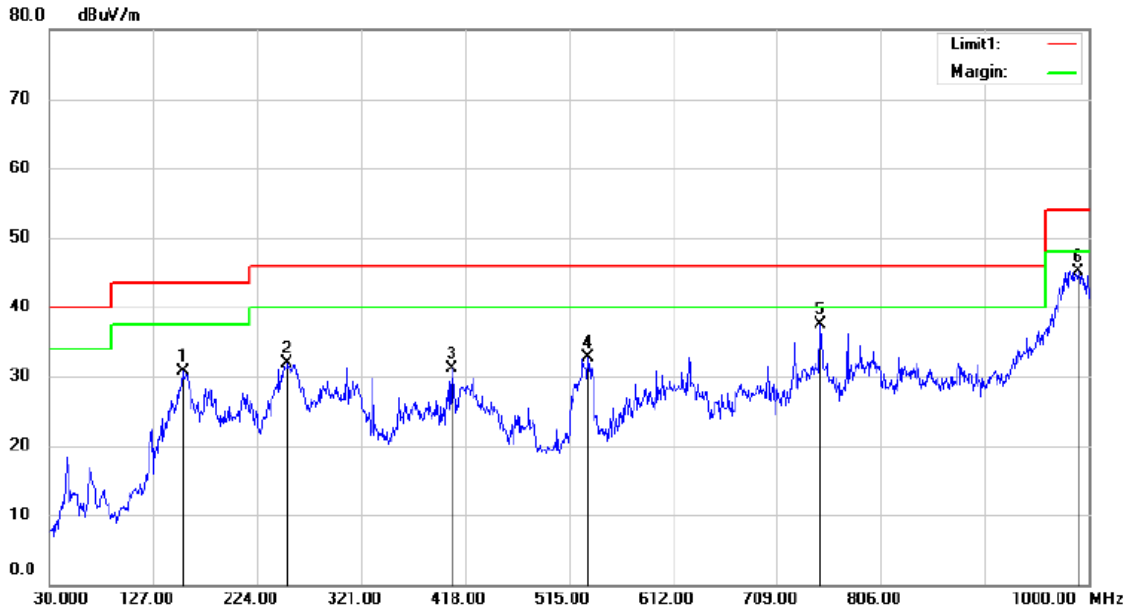

Site 3m Chamber 3# Polarization: **Horizontal** Temperature: 24 C
 Limit: (RE)FCC PART 15 CLASS B Power: AC 120V/60Hz Humidity: 53 %
 Mode: WIFI5G A20(5825MHz)
 Note:

No.	Mk.	Freq. MHz	Reading Level dBuV	Correct Factor dB	Measure- ment dBuV/m	Limit dBuV/m	Over dB	Antenna Height cm	Table Degree	Detector	Comment
1		154.1600	49.44	-18.83	30.61	43.50	-12.89			QP	
2		252.1300	45.53	-13.64	31.89	46.00	-14.11			QP	
3		405.3900	40.55	-9.49	31.06	46.00	-14.94			QP	
4		532.4600	39.50	-6.70	32.80	46.00	-13.20			QP	
5	*	749.7400	40.21	-2.71	37.50	46.00	-8.50			QP	
6		990.3000	43.91	1.23	45.14	54.00	-8.86			QP	

*:Maximum data x:Over limit !:over margin

Operator: LQZ

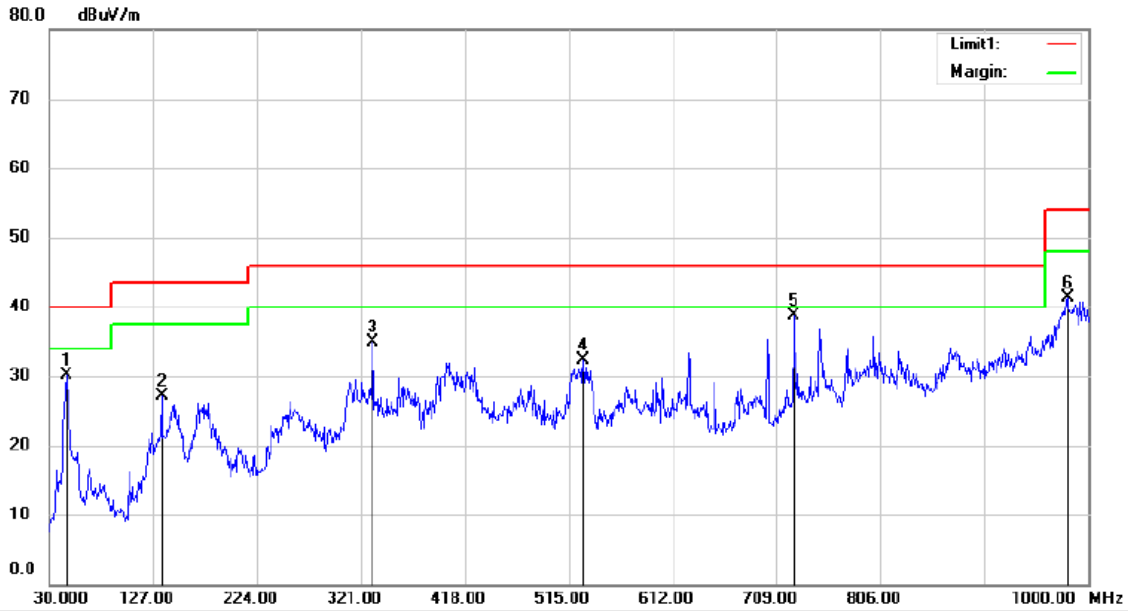

Site 3m Chamber 3# Polarization: **Vertical** Temperature: 24 C
 Limit: (RE)FCC PART 15 CLASS B Power: AC 120V/60Hz Humidity: 53 %
 Mode: WIFI5G A20(5825MHz)
 Note:

No.	Mk.	Freq.	Reading Level	Correct Factor	Measurement	Limit	Over	Antenna Height	Table Degree	
		MHz	dBuV	dB	dBuV/m	dBuV/m	dB	cm	degree	Comment
1		45.5200	44.27	-14.07	30.20	40.00	-9.80			QP
2		134.7600	46.31	-19.29	27.02	43.50	-16.48			QP
3		331.6700	46.16	-11.30	34.86	46.00	-11.14			QP
4		528.5800	39.00	-6.72	32.28	46.00	-13.72			QP
5	*	725.4900	41.94	-3.18	38.76	46.00	-7.24			QP
6		980.6000	40.02	1.29	41.31	54.00	-12.69			QP

*:Maximum data x:Over limit l:over margin

Operator: LQZ

8.6 POWER LINE CONDUCTED EMISSIONS

8.6.1 Applicable Standard

According to FCC Part 15.207(a)

8.6.2 Conformance Limit

Frequency(MHz)	Conducted Emission Limit	
	Quasi-peak	Average
0.15-0.5	66-56	56-46
0.5-5.0	56	46
5.0-30.0	60	50

Note: 1. The lower limit shall apply at the transition frequencies

2. The limit decreases in line with the logarithm of the frequency in the range of 0.15 to 0.50MHz.

8.6.3 Test Configuration

Test according to clause 6.3 conducted emission test setup

8.6.4 Test Procedure

The EUT was placed on a table which is 0.8m above ground plane.
Maximum procedure was performed on the highest emissions to ensure EUT compliance.
Repeat above procedures until all frequency measured were complete.

8.6.5 Test Results

Pass

We test the EUT at 120V and 240V, and show the worst result as bellow.

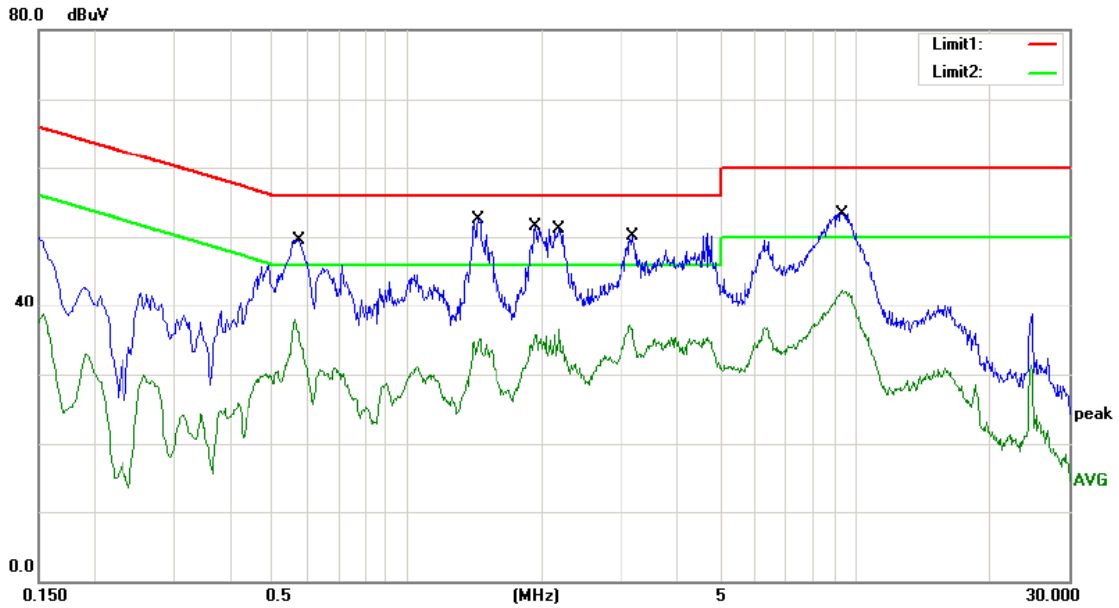

Site site #1 Phase: **L1** Temperature: 25
 Limit: (CE)FCC PART 15 C_QP Power: AC 120V/60Hz Humidity: 55 %
 Mode: WIFI (TX2412)
 Note:

No.	Mk.	Freq. MHz	Reading Level dBuV	Correct Factor dB	Measure- ment dBuV	Limit dBuV	Over dB	Detector	Comment
1		0.5740	36.36	9.84	46.20	56.00	-9.80	QP	
2		0.5740	28.04	9.84	37.88	46.00	-8.12	AVG	
3	*	1.4380	38.86	9.84	48.70	56.00	-7.30	QP	
4		1.4380	24.70	9.84	34.54	46.00	-11.46	AVG	
5		1.9380	35.96	9.84	45.80	56.00	-10.20	QP	
6		1.9380	23.66	9.84	33.50	46.00	-12.50	AVG	
7		2.1780	36.46	9.84	46.30	56.00	-9.70	QP	
8		2.1780	26.62	9.84	36.46	46.00	-9.54	AVG	
9		3.1740	36.05	9.85	45.90	56.00	-10.10	QP	
10		3.1740	26.60	9.85	36.45	46.00	-9.55	AVG	
11		9.3260	41.54	9.96	51.50	60.00	-8.50	QP	
12		9.3260	31.91	9.96	41.87	50.00	-8.13	AVG	

*:Maximum data x:Over limit l:over margin Comment: Factor build in receiver. Operator: Washington

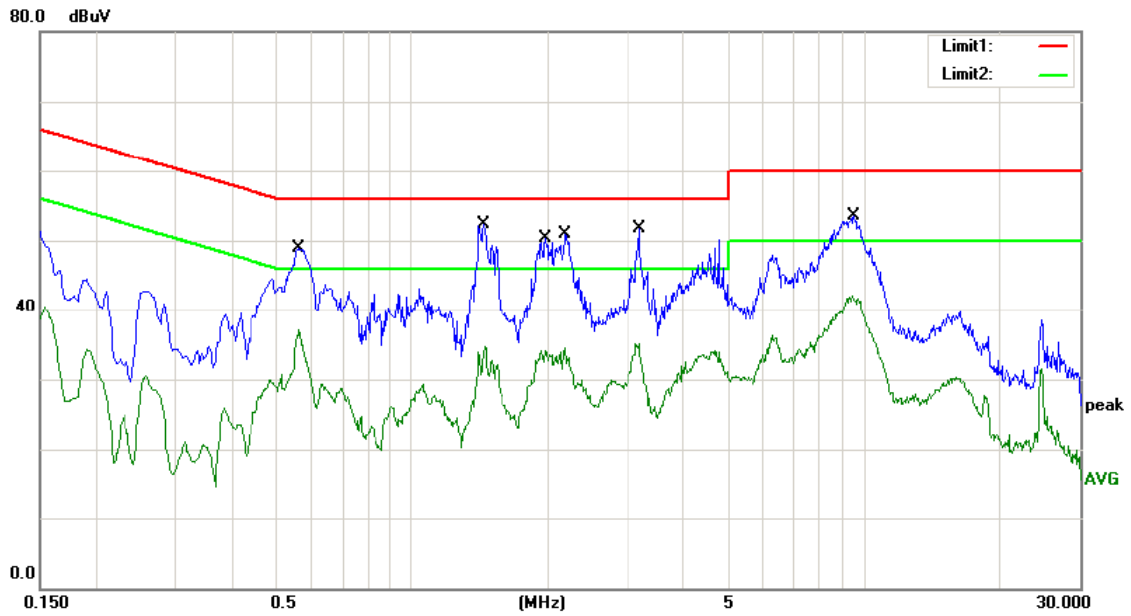

Site site #1 Phase: **N** Temperature: 25
 Limit: (CE)FCC PART 15 C QP Power: AC 120V/60Hz Humidity: 55 %
 Mode: WIFI (TX2412)
 Note:

No.	Mk.	Freq.	Reading Level	Correct Factor	Measurement	Limit	Over	Detector	Comment
		MHz	dBuV	dB	dBuV	dBuV	dB		
1		0.5620	35.46	9.84	45.30	56.00	-10.70	QP	
2		0.5620	26.36	9.84	36.20	46.00	-9.80	AVG	
3		1.4380	38.36	9.84	48.20	56.00	-7.80	QP	
4		1.4380	22.63	9.84	32.47	46.00	-13.53	AVG	
5		1.9740	37.36	9.84	47.20	56.00	-8.80	QP	
6		1.9740	22.79	9.84	32.63	46.00	-13.37	AVG	
7		2.1820	36.46	9.84	46.30	56.00	-9.70	QP	
8		2.1820	21.51	9.84	31.35	46.00	-14.65	AVG	
9	*	3.1780	38.65	9.85	48.50	56.00	-7.50	QP	
10		3.1780	24.00	9.85	33.85	46.00	-12.15	AVG	
11		9.4580	40.43	9.97	50.40	60.00	-9.60	QP	
12		9.4580	31.33	9.97	41.30	50.00	-8.70	AVG	

*:Maximum data x:Over limit !:over margin Comment: Factor build in receiver. Operator: Washington

8.7 ANTENNA APPLICATION

8.7.1 Antenna Requirement

Standard	Requirement
FCC CRF Part 15.203	An intentional radiator shall be designed to ensure that no antenna other than that furnished by the responsible party shall be used with the device. The use of a permanently attached antenna or of an antenna that uses a unique coupling to the intentional radiator shall be considered sufficient to comply with the provisions of this section. The manufacturer may design the unit so that a broken antenna can be replaced by the user, but the use of a standard antenna jack or electrical connector is prohibited. This requirement does not apply to carrier current devices or to devices operated under the provisions of §15.211, §15.213, §15.217, §15.219, or §15.221. Further, this requirement does not apply to intentional radiators that must be professionally installed, such as perimeter protection systems and some field disturbance sensors, or to other intentional radiators which, in accordance with §15.31(d), must be measured at the installation site. However, the installer shall be responsible for ensuring that the proper antenna is employed so that the limits in this part are not exceeded.

For intentional device, according to FCC 47 CFR Section 15.203, an intentional radiator shall be designed to ensure that no antenna other than that furnished by the responsible party shall be used with the device. And according to FCC 47 CFR Section 15.407 (a), if transmitting antennas of directional gain greater than 6dBi are used, the power shall be reduced by the amount in dB that the directional gain of the antenna exceeds 6dBi.

8.7.2 Result

PASS.

The EUT has a Metel antenna for BT, the max gain is 4.0 dBi;

The EUT has two Metel antenna for WIFI 2.4 Band, the max gain is 4.0 dBi;

The EUT has two Metel antenna: for WIFI 5G Band, the max gain is 5.0 dBi for WIFI 5G Band I, and the max gain is 5.0dBi for WIFI 5G Band II.

- Note:
- Antenna use a permanently attached antenna which is not replaceable.
 - Not using a standard antenna jack or electrical connector for antenna replacement
 - The antenna has to be professionally installed (please provide method of installation)

which in accordance to section 15.203, please refer to the internal photos.