

**ELECTROMAGNETIC EMISSIONS COMPLIANCE REPORT  
INTENTIONAL RADIATOR CERTIFICATION TO  
FCC PART 15 SUBPART C REQUIREMENT**

*OF*

**LED TV**

**Model No.: SE42UMT, SE42UGT, SE42XXXXXXXXXX (where X would be  
any Arabic number or English letter or blank)**

**FCC ID: 2ACWISE42UMT**

**Trademark: THTF, Fluid, Westinghouse, Seiki, Element, Panasonic**

**Report No.: ED150825031E**

**Issue Date: October 21, 2015**

*Prepared for*

**Shenyang Tongfang Multimedia Technology Co., Limited  
No.10 Nanping East Road HunNan New District Shenyang, LiaoNing  
Province P.R .China**

*Prepared by*

**DONGGUAN EMTEK CO., LTD.  
No.281, Guantai Road, Nancheng District,  
Dongguan, Guangdong, China  
TEL: 86-769-22807078  
FAX: 86-769-22807079**

**This report shall not be reproduced, except in full, without the written approval of  
DONGGUAN EMTEK CO., LTD.**

**VERIFICATION OF COMPLIANCE**

Applicant:	Shenyang Tongfang Multimedia Technology Co., Limited No.10 Nanping East Road Hunnan New District Shenyang, Liaoning Province P.R .China
Manufacturer:	Shenyang Tongfang Multimedia Technology Co., Limited No.10 Nanping East Road Hunnan New District Shenyang, Liaoning Province P.R .China
Product Description:	LED TV
Model Number:	SE42UMT, SE42UGT, SE42XXXXXXXXXX (where X would be any Arabic number or English letter or blank)
Input Rating:	AC 100-240V, 60Hz,140W

**We hereby certify that:**

The above equipment was tested by DONGGUAN EMTEK CO., LTD. The test data, data evaluation, test procedures, and equipment configurations shown in this report were made in accordance with the procedures given in ANSI C63.10-2013 and the energy emitted by the sample EUT tested as described in this report is in compliance with conducted and radiated emission limits of FCC Rules Part 15.247(2014).

Date of Test : August 25, 2015 to September 20, 2015

Prepared by :   
Ivy Huang/Editor

Reviewer :   
Alan He/Supervisor

Approved & Authorized Signer :   
Sam Lv/Manager

### Modified Information

Version	Summary	Revision Date	Report No.
Ver.1.0	Original Report	/	KAD150408030E
Ver.1.0	Changed the LED panel.	2015-10-21	ED150825031E

## Table of Contents

<b>1. GENERAL INFORMATION .....</b>	<b>5</b>
1.1 PRODUCT DESCRIPTION .....	5
<b>2. SYSTEM TEST CONFIGURATION .....</b>	<b>6</b>
2.1 EUT CONFIGURATION.....	6
2.2 EUT EXERCISE .....	6
2.3 TEST PROCEDURE.....	6
2.4 CONFIGURATION OF TESTED SYSTEM .....	6
<b>3. DESCRIPTION OF TEST MODES.....</b>	<b>7</b>
<b>4. SUMMARY OF TEST RESULTS.....</b>	<b>8</b>
<b>5. TEST METHODOLOGY .....</b>	<b>8</b>
<b>6. TEST FACILITY.....</b>	<b>8</b>
<b>7. TEST SYSTEM UNCERTAINTY .....</b>	<b>9</b>
<b>8. CONDUCTED EMISSIONS TEST .....</b>	<b>10</b>
8.1 MEASUREMENT PROCEDURE .....	10
8.2 TEST SET-UP (BLOCK DIAGRAM OF CONFIGURATION) .....	10
8.3 MEASUREMENT EQUIPMENT USED .....	10
8.4 CONDUCTED EMISSION LIMIT .....	10
8.5 MEASUREMENT RESULT.....	10
<b>9. RADIATED EMISSION TEST.....</b>	<b>15</b>
9.1 MEASUREMENT PROCEDURE .....	15
9.2 TEST SET-UP (BLOCK DIAGRAM OF CONFIGURATION) .....	16
9.3 MEASUREMENT EQUIPMENT USED .....	17
9.4 RADIATED EMISSION LIMIT .....	18
9.5 MEASUREMENT RESULT.....	19

APPENDIX I (PHOTOS OF EUT)(5PAGES)

## 1. General Information

### 1.1 Product Description

Characteristics	Description
<b>IEEE 802.11 WLAN Mode Supported</b>	<input checked="" type="checkbox"/> 802.11b(20MHz channel bandwidth) <input checked="" type="checkbox"/> 802.11g(20MHz channel bandwidth) <input checked="" type="checkbox"/> 802.11n(20MHz channel bandwidth) <input checked="" type="checkbox"/> 802.11n(40MHz channel bandwidth)
<b>Data Rate</b>	802.11 b:1,2,5.5,11Mbps; 802.11 g:6,9,12,18,24,36,48,54Mbps; 802.11n(HT20):MCS0-MCS7; 802.11n(HT40):MCS0-MCS7; 802.11n(HT40):MCS8-MCS15;
<b>MIMO Mode</b>	802.11n(HT20), 802.11n(HT40)
<b>Modulation</b>	DSSS with DBPSK/DQPSK/CCK for 802.11b; OFDM with BPSK/QPSK/16QAM/64QAM for 802.11g/n;
<b>Operating Frequency Range</b>	2412-2462MHz for 802.11b/g; 2412-2462MHz for 802.11n(HT20); 2422-2452MHz for 802.11n(HT40);
<b>Number of Channels</b>	11 channels for 802.11b/g; 11 channels for 802.11n(HT20); 7 channels for 802.11n(HT40);
<b>Transmit Power Max</b>	14.27dBm for 802.11b; 13.62dBm for 802.11g; 11.53dBm for 802.11n(HT20); 11.04dBm for 802.11n(HT40);
<b>Antenna Type</b>	2TX2RX
<b>Antenna Port</b>	<input checked="" type="checkbox"/> Ant1; <input checked="" type="checkbox"/> Ant2;
<b>Smart system</b>	<input checked="" type="checkbox"/> SISO for 802.11b/g <input checked="" type="checkbox"/> MIMO for 802.11n
<b>Antenna Gain</b>	2.0dBi ( for per antenna port Max) 5.01dBi for MIMO(Ant1+Ant2 Directional Gain)

**Note:** for more details, please refer to the User's manual of the EUT.

## 2. System Test Configuration

### 2.1 EUT Configuration

The EUT configuration for testing is installed on RF field strength measurement to meet the Commissions requirement and operating in a manner which intends to maximize its emission characteristics in a continuous normal application.

### 2.2 EUT Exercise

The Transmitter was operated in the normal operating mode. The TX frequency was fixed which was for the purpose of the measurements.

### 2.3 Test Procedure

#### 2.3.1 Conducted Emissions

The EUT is a placed on as turn table which is 0.8 m above ground plane. According to the requirements in Section 13.1.4.1 of ANSI C63.10-2013 Conducted emissions from the EUT measured in the frequency range between 0.15 MHz and 30 MHz using CISPR Quasi-Peak and average detector mode.

#### 2.3.2 Radiated Emissions

The EUT is a placed on as turn table which is 0.8 m above ground plane. The turn table shall rotate 360 degrees to determine the position of maximum emission level. EUT is set 3m away from the receiving antenna which varied from 1m to 4m to find out the highest emission. And also, each emission was to be maximized by changing the polarization of receiving antenna both horizontal and vertical. In order to find out the max. Emission, the relative positions of this hand-held transmitter (EUT) was rotated through three orthogonal axes according to the requirements in Section 13.1.4.1 of ANSI C63.10-2013.

### 2.4 Configuration of Tested System

**Fig. 2-1 Configuration of Tested System**

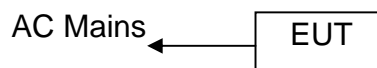

**Table 2-1 Equipment Used in Tested System**

Item	Equipment	Trademark	Model No.	FCC ID	Note
1.	LED TV	SEIKI	SE42UMT	2ACWISE42UMT	EUT

**Note:**

- (1) Unless otherwise denoted as EUT in 『Remark』 column, device(s) used in tested system is a support equipment.

### 3. Description of Test Modes

The EUT has been tested under its typical operating condition.

The EUT configuration for testing is installed on RF field strength measurement to meet the Commissions requirement and operating in a manner which intends to maximize its emission characteristics in a continuous normal application.

The Transmitter was operated in the normal operating mode. The TX frequency was fixed which was for the purpose of the measurements.

Test of channel included the lowest and middle and highest frequency to perform the test, then record on this report.

Those data rates (802.11b: 1 Mbps; 802.11g: 6 Mbps; 802.11n (HT20) : MCS0; 802.11n (HT40) : MCS8) were used for all test.

Pre-defined engineering program for regulatory testing used to control the EUT for staying in continuous transmitting and receiving mode is programmed.

Frequency and Channel list for 802.11 b/g/n (HT20):

Channel	Frequency (MHz)	Channel	Frequency (MHz)	Channel	Frequency (MHz)
1	2412	5	2432	9	2452
2	2417	6	2437	10	2457
3	2422	7	2442	11	2462
4	2427	8	2447		

Frequency and Channel list for 802.11 n (HT40):

Channel	Frequency (MHz)	Channel	Frequency (MHz)	Channel	Frequency (MHz)
3	2422	5	2432	8	2447
4	2427	6	2437	9	2452
		7	2442		

Test Frequency and Channel for 802.11 b/g/n (HT20):

Lowest Frequency		Middle Frequency		Highest Frequency	
Channel	Frequency (MHz)	Channel	Frequency (MHz)	Channel	Frequency (MHz)
1	2412	6	2437	11	2462

Test Frequency and channel for 802.11 n (HT40):

Lowest Frequency		Middle Frequency		Highest Frequency	
Channel	Frequency (MHz)	Channel	Frequency (MHz)	Channel	Frequency (MHz)
3	2422	6	2437	9	2452

#### 4. Summary of Test Results

FCC Rules	Description Of Test	Result
§15.207	AC Power Conducted Emission	Pass
§15.247(d), §15.209	Radiated Emission	Pass

#### RELATED SUBMITTAL(S) / GRANT(S):

This submittal(s) (test report) is intended for FCC ID: 2ACWISE42UMT filing to comply with Section 15.247 of the FCC Part 15, Subpart C Rules.  
The system is compliance with Subpart B is authorized under a DOC procedure

#### 5. Test Methodology

According to its specifications, the EUT must comply with the requirements of the following standards:

FCC 47 CFR Part 2, Subpart J  
FCC 47 CFR Part 15, Subpart C  
FCC KDB 558074 D01 DTS Meas Guidance v03r03  
FCC KDB 662911 D01 Multiple Transmitter Output v01  
FCC KDB 662911 D02 MIMO With Cross Polarized Antenna V01

#### 6. Test Facility

##### Site Description

EMC Lab : Accredited by FCC, June 18, 2014  
The Certificate Number is 247565

Accredited by Industry Canada, February 19, 2014  
The Certificate Number is 9444A

Name of Firm : DONGGUAN EMTEK CO., LTD.  
Site Location : No.281, Guantai Road, Nancheng District,  
Dongguan, Guangdong, China



## 7. TEST SYSTEM UNCERTAINTY

The following measurement uncertainty levels have been estimated for tests performed on the apparatus:

Parameter	Uncertainty
Radio Frequency	$\pm 1 \times 10^{-5}$
Maximum Peak Output Power Test	$\pm 1.0\text{dB}$
Conducted Emissions Test	$\pm 2.0\text{dB}$
Radiated Emission Test	$\pm 2.0\text{dB}$
Power Density	$\pm 2.0\text{dB}$
Occupied Bandwidth Test	$\pm 1.0\text{dB}$
Band Edge Test	$\pm 3\text{dB}$
All emission, radiated	$\pm 3\text{dB}$
Antenna Port Emission	$\pm 3\text{dB}$
Temperature	$\pm 0.5^\circ\text{C}$
Humidity	$\pm 3\%$

Measurement Uncertainty for a level of Confidence of 95%

## 8. Conducted Emissions Test

### 8.1 Measurement Procedure

1. The EUT was placed on a table which is 0.8m above ground plane.
2. Maximum procedure was performed on the six highest emissions to ensure EUT compliance.
3. Repeat above procedures until all frequency measured were complete.

### 8.2 Test SET-UP (Block Diagram of Configuration)

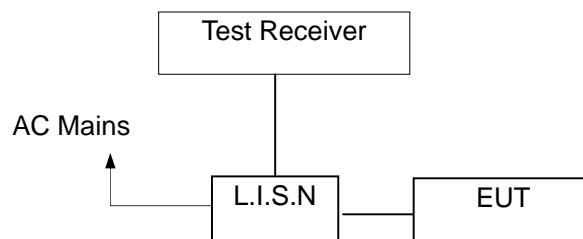

### 8.3 Measurement Equipment Used

Conducted Emission Test Site					
EQUIPMENT TYPE	MFR	MODEL NUMBER	SERIAL NUMBER	Last Cal.	Due date
Test Receiver	Rohde & Schwarz	ESCS30	100018	03/16/2015	03/15/2016
L.I.S.N	Rohde & Schwarz	ENV216	100017	03/16/2015	03/15/2016
RF Switching Unit	CDS	RSU-M2	38401	03/16/2015	03/15/2016
Coaxial Cable	CDS	79254	46107086	03/16/2015	03/15/2016

### 8.4 Conducted Emission Limit

Conducted Emission Frequency(MHz)	Quasi-peak	Average
0.15-0.5	66-56	56-46
0.5-5.0	56	46
5.0-30.0	60	50

- Note:** 1. The lower limit shall apply at the transition frequencies  
 2. The limit decreases in line with the logarithm of the frequency in the range of 0.15 to 0.50MHz.

### 8.5 Measurement Result

Please refer to following pages.

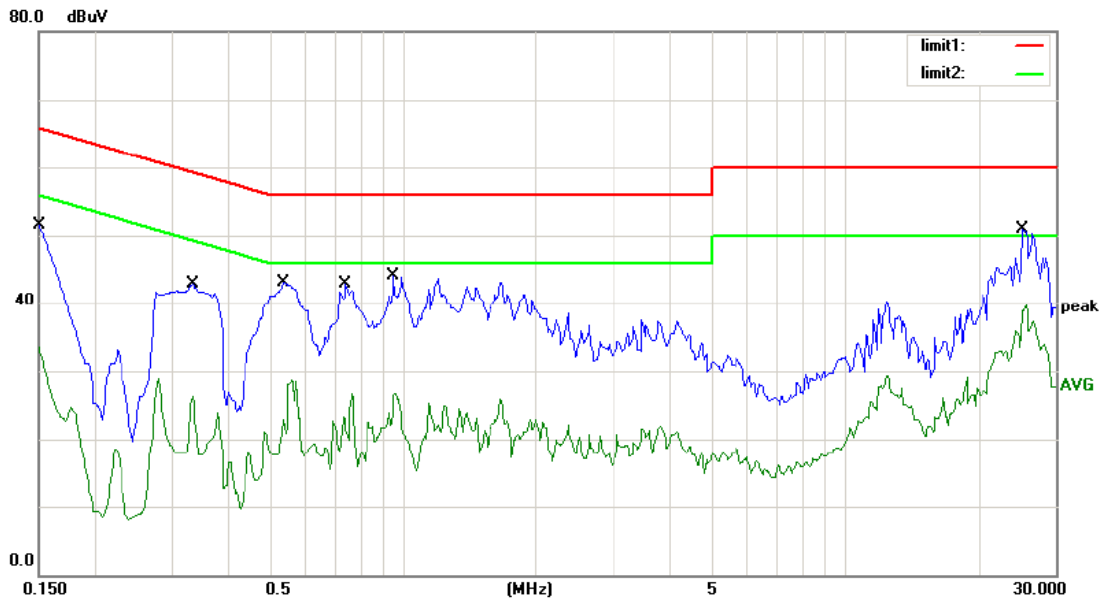

Site site #1 Phase: **L1** Temperature: 24  
 Limit: (CE)FCC PART 15 class B\_QP Power: AC 120V/60Hz Humidity: 55 %  
 Mode: TX2412  
 Note:

No.	Mk.	Freq. MHz	Reading Level dBuV	Correct Factor dB	Measure- ment dBuV	Limit dBuV	Over dB	Detector	Comment
1		0.1500	47.25	0.00	47.25	66.00	-18.75	QP	
2		0.1500	33.50	0.00	33.50	56.00	-22.50	AVG	
3		0.3345	40.28	0.00	40.28	59.34	-19.06	QP	
4		0.3345	26.31	0.00	26.31	49.34	-23.03	AVG	
5		0.5378	40.36	0.00	40.36	56.00	-15.64	QP	
6		0.5378	28.28	0.00	28.28	46.00	-17.72	AVG	
7		0.7395	38.26	0.00	38.26	56.00	-17.74	QP	
8		0.7395	26.66	0.00	26.66	46.00	-19.34	AVG	
9		0.9555	40.32	0.00	40.32	56.00	-15.68	QP	
10		0.9555	26.75	0.00	26.75	46.00	-19.25	AVG	
11	*	25.2500	50.81	0.00	50.81	60.00	-9.19	QP	
12		25.2500	39.68	0.00	39.68	50.00	-10.32	AVG	

\*:Maximum data    x:Over limit    !:over margin    Comment: Factor build in receiver.

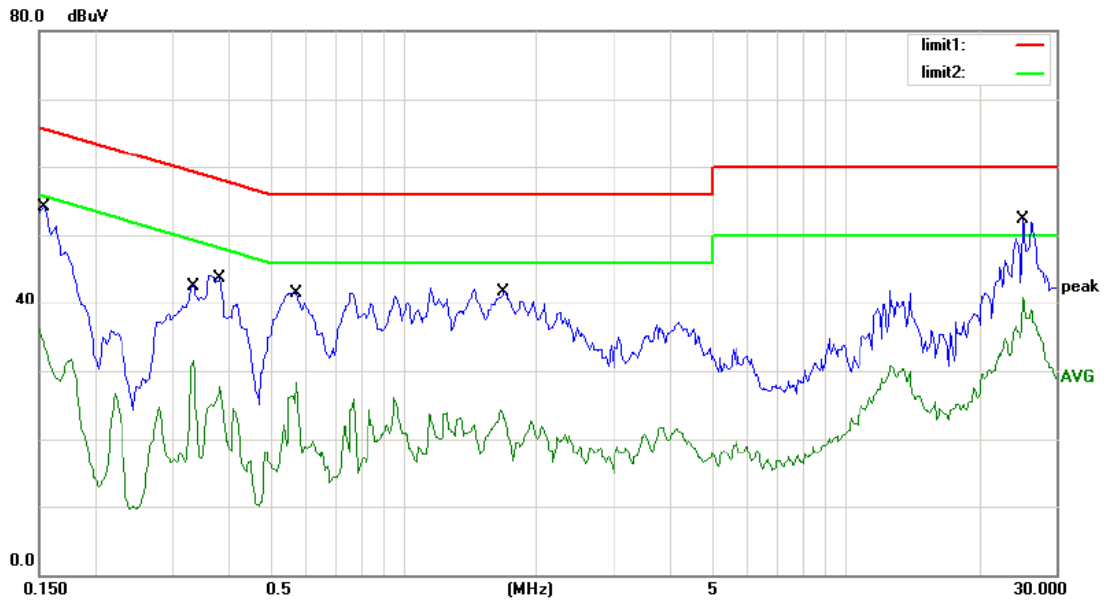

Site site #1 Phase: **N** Temperature: 24  
 Limit: (CE)FCC PART 15 class B\_QP Power: AC 120V/60Hz Humidity: 55 %  
 Mode: TX2412  
 Note:

No.	Mk.	Freq. MHz	Reading Level dBuV	Correct Factor dB	Measure- ment dBuV	Limit dBuV	Over dB	Detector	Comment
1		0.1500	50.21	0.00	50.21	66.00	-15.79	QP	
2		0.1500	36.14	0.00	36.14	56.00	-19.86	AVG	
3		0.3345	42.56	0.00	42.56	59.34	-16.78	QP	
4		0.3345	31.47	0.00	31.47	49.34	-17.87	AVG	
5		0.3840	40.25	0.00	40.25	58.19	-17.94	QP	
6		0.3840	27.66	0.00	27.66	48.19	-20.53	AVG	
7		0.5730	41.59	0.00	41.59	56.00	-14.41	QP	
8		0.5730	28.27	0.00	28.27	46.00	-17.73	AVG	
9		1.6980	38.45	0.00	38.45	56.00	-17.55	QP	
10		1.6980	24.29	0.00	24.29	46.00	-21.71	AVG	
11	*	25.2250	52.29	0.00	52.29	60.00	-7.71	QP	
12		25.2250	40.99	0.00	40.99	50.00	-9.01	AVG	

\*:Maximum data x:Over limit !:over margin Comment: Factor build in receiver.

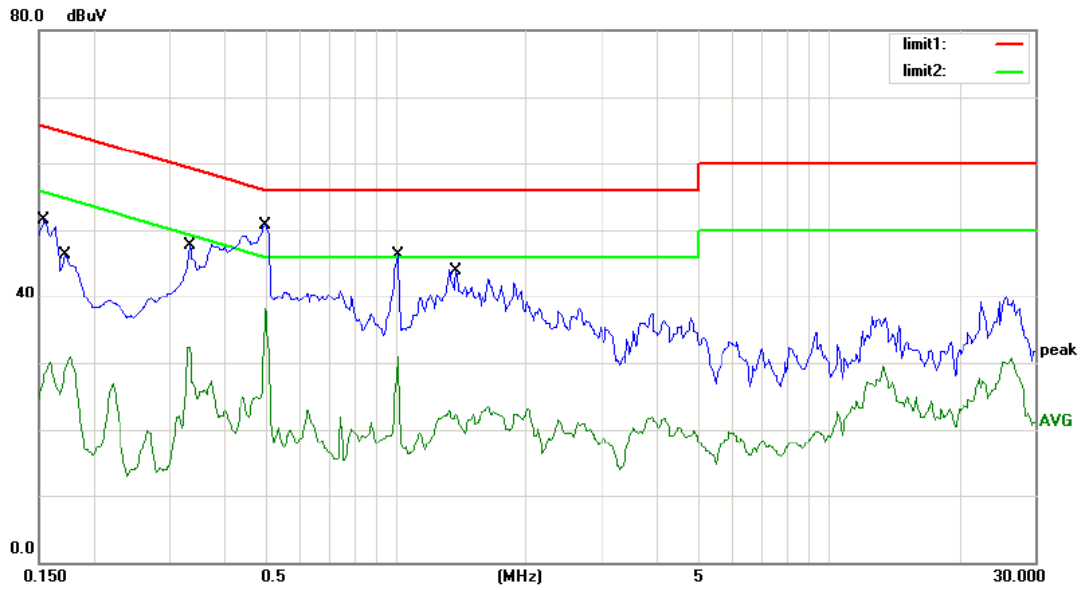

Site site #1 Phase: **L1** Temperature: 24  
 Limit: (CE)FCC PART 15 class B\_QP Power: AC 240V/50Hz Humidity: 55 %  
 Mode: TX2412  
 Note:

No.	Mk.	Freq. MHz	Reading Level dBuV	Correct Factor dB	Measure- ment dBuV	Limit dBuV	Over dB	Detector	Comment
1		0.1556	48.26	0.00	48.26	65.70	-17.44	QP	
2		0.1556	30.11	0.00	30.11	55.70	-25.59	AVG	
3		0.1725	46.32	0.00	46.32	64.84	-18.52	QP	
4		0.1725	30.94	0.00	30.94	54.84	-23.90	AVG	
5		0.3345	45.23	0.00	45.23	59.34	-14.11	QP	
6		0.3345	32.31	0.00	32.31	49.34	-17.03	AVG	
7	*	0.5010	50.78	0.00	50.78	56.00	-5.22	QP	
8		0.5010	38.09	0.00	38.09	46.00	-7.91	AVG	
9		1.0140	43.25	0.00	43.25	56.00	-12.75	QP	
10		1.0140	30.93	0.00	30.93	46.00	-15.07	AVG	
11		1.3785	36.38	0.00	36.38	56.00	-19.62	QP	
12		1.3785	21.00	0.00	21.00	46.00	-25.00	AVG	

\*:Maximum data x:Over limit !:over margin Comment: Factor build in receiver.

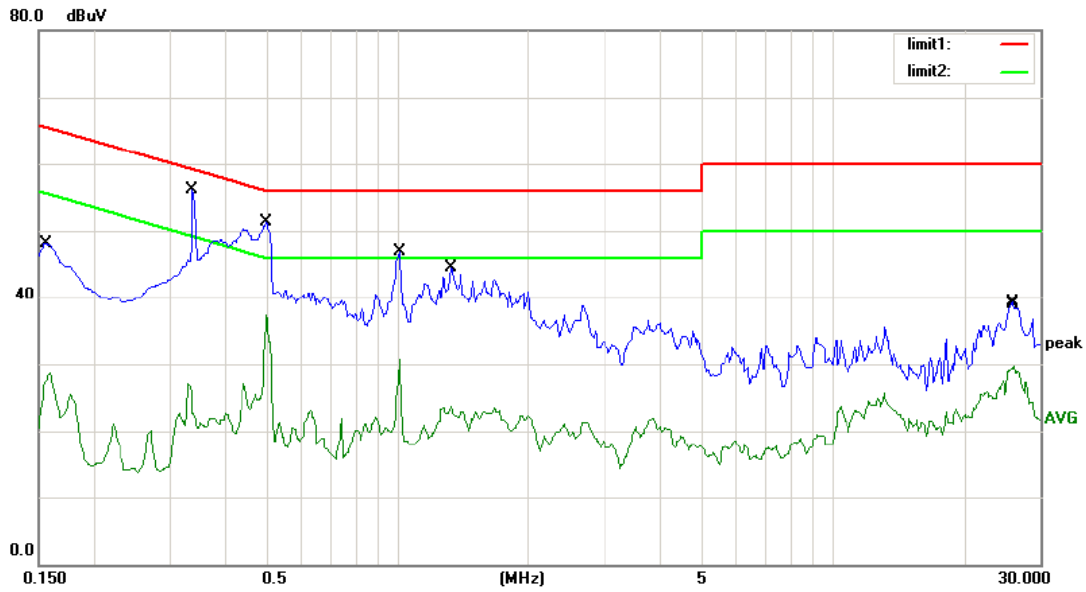

Site site #1 Phase: **N** Temperature: 24  
 Limit: (CE)FCC PART 15 class B\_QP Power: AC 240V/50Hz Humidity: 55 %  
 Mode: TX2412  
 Note:

No.	Mk.	Freq.	Reading Level	Correct Factor	Measurement	Limit	Over	Detector	Comment
		MHz	dBuV	dB	dBuV	dBuV	dB		
1		0.1573	45.12	0.00	45.12	65.61	-20.49	QP	
2		0.1573	28.76	0.00	28.76	55.61	-26.85	AVG	
3		0.3390	27.01	0.00	27.01	49.23	-22.22	AVG	
4		0.3390	40.26	0.00	40.26	59.23	-18.97	QP	
5	*	0.5010	48.32	0.00	48.32	56.00	-7.68	QP	
6		0.5010	37.33	0.00	37.33	46.00	-8.67	AVG	
7		1.0140	42.20	0.00	42.20	56.00	-13.80	QP	
8		1.0140	30.62	0.00	30.62	46.00	-15.38	AVG	
9		1.3245	38.00	0.00	38.00	56.00	-18.00	QP	
10		1.3245	23.68	0.00	23.68	46.00	-22.32	AVG	
11		25.8750	39.33	0.00	39.33	60.00	-20.67	QP	
12		26.2250	29.64	0.00	29.64	50.00	-20.36	AVG	

\*:Maximum data x:Over limit !:over margin Comment: Factor build in receiver.

## 9. Radiated Emission Test

### 9.1 Measurement Procedure

1. Below 1000MHz, The EUT was placed on a turn table which is 0.8m above ground plane, And above 1000MHz, The EUT was placed on a styrofoam table which is 1.5m above ground plane.
2. Maximum procedure was performed on the six highest emissions to ensure EUT compliance.
3. And also, each emission was to be maximized by changing the polarization of receiving antenna both horizontal and vertical.
4. Repeat above procedures until all frequency measured was complete.

When spectrum scanned from 30MHz to 1GHz setting resolution bandwidth 120KHz and video bandwidth 300KHz:

EMI Test Receiver	Setting
Attenuation	Auto
RBW	120KHz
VBW	300KHz
Detector	QP
Trace	Max hold

When spectrum scanned above 1GHz setting resolution bandwidth 1MHz, video bandwidth 3MHz:

EMI Test Receiver	Setting
Attenuation	Auto
RBW	1MHz
VBW	3MHz
Detector	Peak
Trace	Max hold

When spectrum scanned above 1GHz setting resolution bandwidth 1MHz, video bandwidth 10Hz:

EMI Test Receiver	Setting
Attenuation	Auto
RBW	1MHz
VBW	10Hz
Detector	Peak
Trace	Max hold

**9.2 Test SET-UP (Block Diagram of Configuration)**

(A) Radiated Emission Test Set-Up, Frequency Below 30MHz

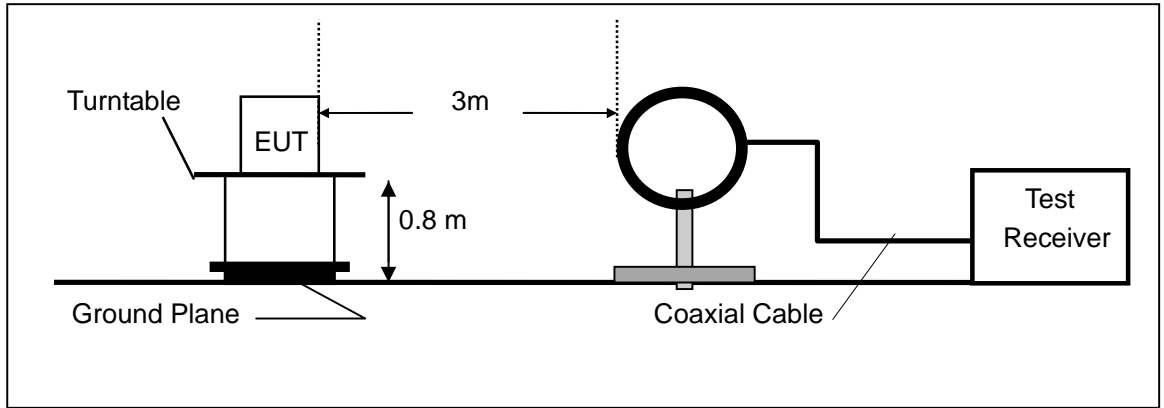

(B) Radiated Emission Test Set-Up, Frequency Below 1000MHz

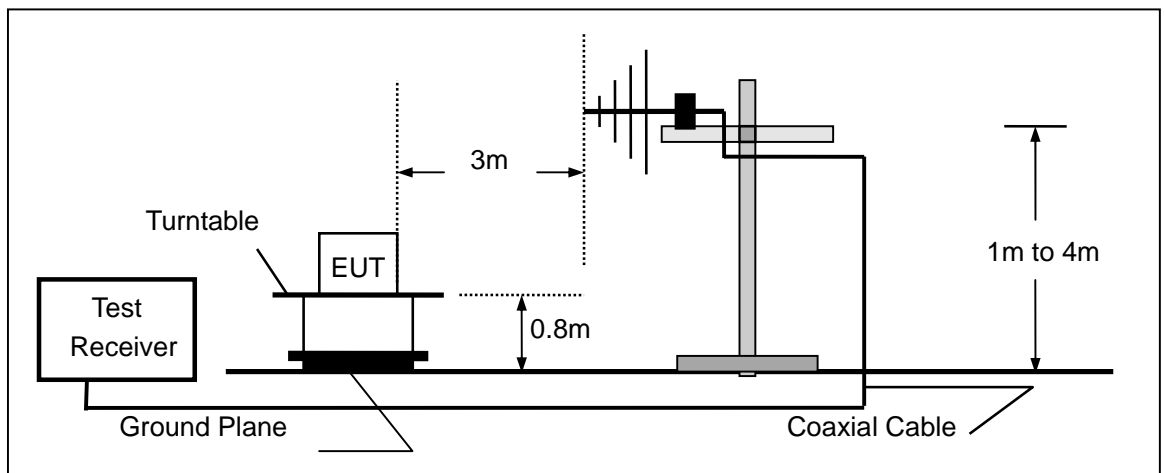



(C) Radiated Emission Test Set-Up, Frequency above 1000MHz

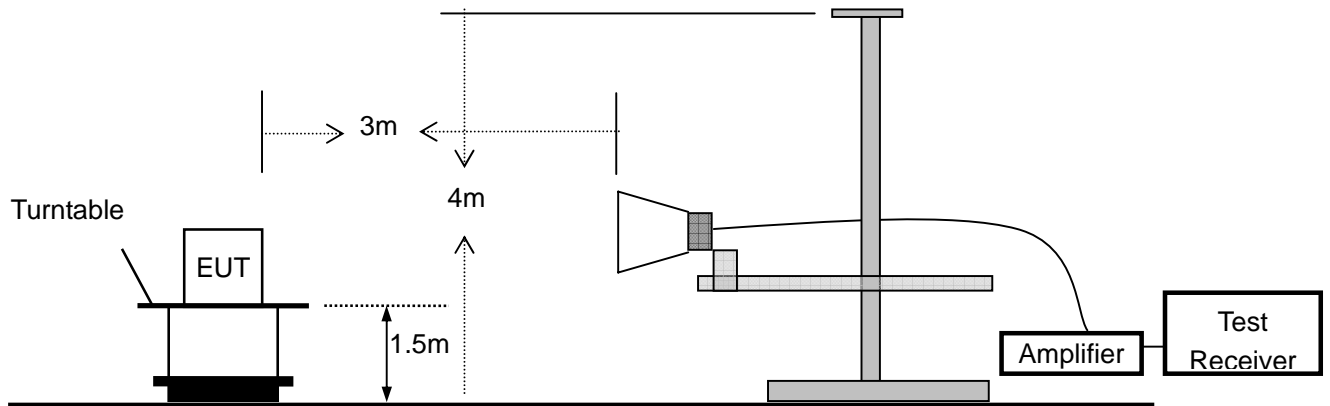

**9.3 Measurement Equipment Used**

Item	Equipment	Manufacturer	Model No.	Serial No.	Last Cal.	Cal. Interval
1.	Test Receiver	Rohde & Schwarz	ESCI	1166.5950.03	03/16/2015	1 Year
2.	Bilog Antenna	Schwarzbeck	VULB9163	000141	03/16/2015	1 Year
3.	Power Amplifier	CDS	RSU-M352	818	03/16/2015	1 Year
4.	Power Amplifier	HP	8447F	OPT H64	03/16/2015	1 Year
5.	Color Monitor	SUNSPO	SP-140A	N/A	03/16/2015	1 Year
6.	Single Line Filter	JIANLI	XL-3	N/A	03/16/2015	1 Year
7.	Single Phase Power Line Filter	JIANLI	DL-2X100B	N/A	03/16/2015	1 Year
8.	3 Phase Power Line Filter	JIANLI	DL-4X100B	N/A	03/16/2015	1 Year
9.	DC Power Filter	JIANLI	DL-2X50B	N/A	03/16/2015	1 Year
10.	Cable	Schwarzbeck	PLF-100	549489	03/16/2015	1 Year
11.	Cable	Rosenberger	CIL02	A0783566	03/16/2015	1 Year
12.	Cable	Rosenberger	RG 233/U	525178	03/16/2015	1 Year
13.	Signal Analyzer	Rohde & Schwarz	FSV30	103040	12/29/2014	1 Year
14.	Horn Antenna	Schwarzbeck	BBHA9120D	9120D-1272	12/29/2014	1 Year
15.	Power Amplifier	LUNAR EM	LNA1G18-40	J10100000081	12/29/2014	1 Year
16.	Cable	H+S	CBL-26	N/A	12/29/2014	1 Year
17.	Cable	H+S	CBL-26	N/A	12/29/2014	1 Year
18.	Cable	H+S	CBL-26	N/A	12/29/2014	1 Year

#### 9.4 Radiated Emission Limit

The emissions from an intentional radiator shall not exceed the field strength levels specified in the following table 15.209(a):

Frequencies (MHz)	Field Strength (micorvolts/meter)	Measurement Distance (meters)
0.009~0.490	2400/F(KHz)	300
0.490~1.705	24000/F(KHz)	30
1.705~30.0	30	30
30~88	100	3
88~216	150	3
216~960	200	3
Above 960	500	3

Restricted bands of operation

MHz	MHz	MHz	GHz
0.090 - 0.110	16.42 - 16.423	399.9 - 410	4.5 - 5.15
<sup>1</sup> 0.495 - 0.505	16.69475 - 16.69525	608 - 614	5.35 - 5.46
2.1735 - 2.1905	16.80425 - 16.80475	960 - 1240	7.25 - 7.75
4.125 - 4.128	25.5 - 25.67	1300 - 1427	8.025 - 8.5
4.17725 - 4.17775	37.5 - 38.25	1435 - 1626.5	9.0 - 9.2
4.20725 - 4.20775	73 - 74.6	1645.5 - 1646.5	9.3 - 9.5
6.215 - 6.218	74.8 - 75.2	1660 - 1710	10.6 - 12.7
6.26775 - 6.26825	108 - 121.94	1718.8 - 1722.2	13.25 - 13.4
6.31175 - 6.31225	123 - 138	2200 - 2300	14.47 - 14.5
8.291 - 8.294	149.9 - 150.05	2310 - 2390	15.35 - 16.2
8.362 - 8.366	156.52475 - 156.52525	2483.5 - 2500	17.7 - 21.4
8.37625 - 8.38675	156.7 - 156.9	2690 - 2900	22.01 - 23.12
8.41425 - 8.41475	162.0125 - 167.17	3260 - 3267	23.6 - 24.0
12.29 - 12.293	167.72 - 173.2	3332 - 3339	31.2 - 31.8
12.51975 - 12.52025	240 - 285	3345.8 - 3358	36.43 - 36.5
12.57675 - 12.57725	322 - 335.4	3600 - 4400	( <sup>2</sup> )

Remark 1. Emission level in dBuV/m=20 log (uV/m)

- : 2. Measurement was performed at an antenna to the closed point of EUT distance of meters.
- 3. Only spurious frequency is permitted to locate within the Restricted Bands specified in provision of § 15.205, and the emissions located in restricted bands also comply with 15.209 limit.

## 9.5 Measurement Result

### Below 30MHz:

All the modulation modes were tested the data of the test mode are recorded in the following pages.

Operation Mode:	TX Mode	Test Date :	September 10, 2015
Frequency Range:	9KHz~30MHz	Temperature :	28°C
Test Result:	PASS	Humidity :	60 %
Measured Distance:	3m	Test By:	Andy

Freq. (MHz)	Ant.Pol. H/V	Emission Level (dBuV/m)	Limit 3m (dBuV/m)	Over (dB)
--	--	--	--	--

Note: the amplitude of spurious emission that is attenuated by more than 20dB below the permissible limit has no need to be reported.

Distance extrapolation factor =  $40\log(\text{Specific distance}/\text{test distance})$  (dB);

Limit line = Specific limits(dBuV) + distance extrapolation factor.

### Below 1000MHz:

All the modulation modes were tested the data of the worst mode (ANT 1: TX 802.11b) are recorded in the following pages and the others modulation methods do not exceed the limits.

Please refer to the following test plots:

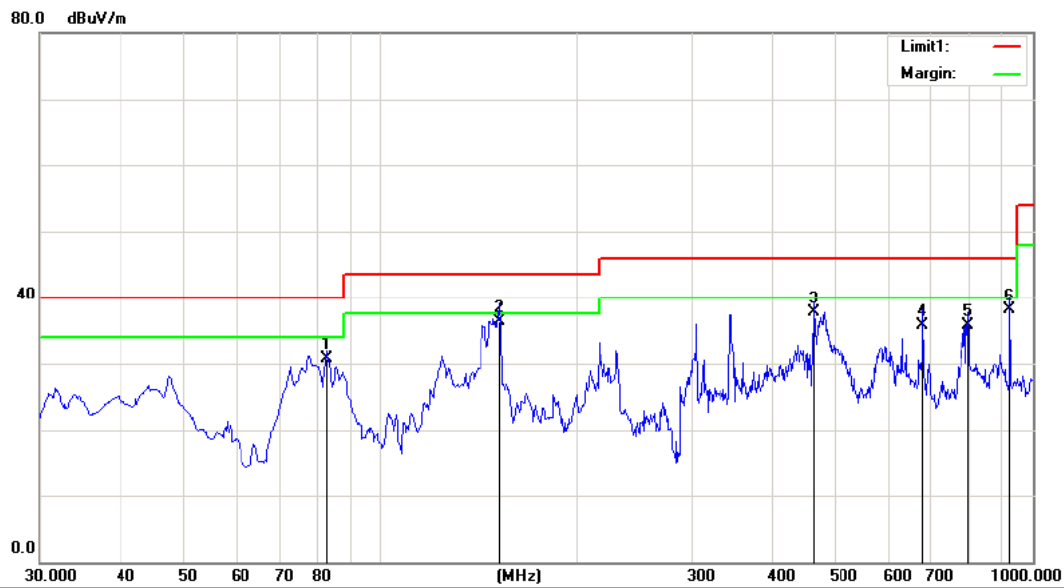

Site site #1 Polarization: **Horizontal** Temperature: 24  
 Limit: (RE)FCC PART 15 class B 3m Power: AC 120V/60Hz Humidity: 55 %  
 Mode:TX2412  
 Note:

No.	Mk.	Freq. MHz	Reading Level dBuV	Correct Factor dB	Measure- ment dBuV/m	Limit dBuV/m	Over dB	Antenna Height cm	Table Degree	Comment
1		82.3800	52.84	-22.16	30.68	40.00	-9.32	QP	0	
2	*	152.2200	54.15	-17.94	36.21	43.50	-7.29	QP	0	
3		461.6500	48.67	-10.96	37.71	46.00	-8.29	QP	0	
4		679.9000	43.27	-7.57	35.70	46.00	-10.30	QP	0	
5		796.3000	40.85	-5.23	35.62	46.00	-10.38	QP	0	
6		923.3700	40.87	-2.76	38.11	46.00	-7.89	QP	0	

\*:Maximum data x:Over limit !:over margin

Operator: John

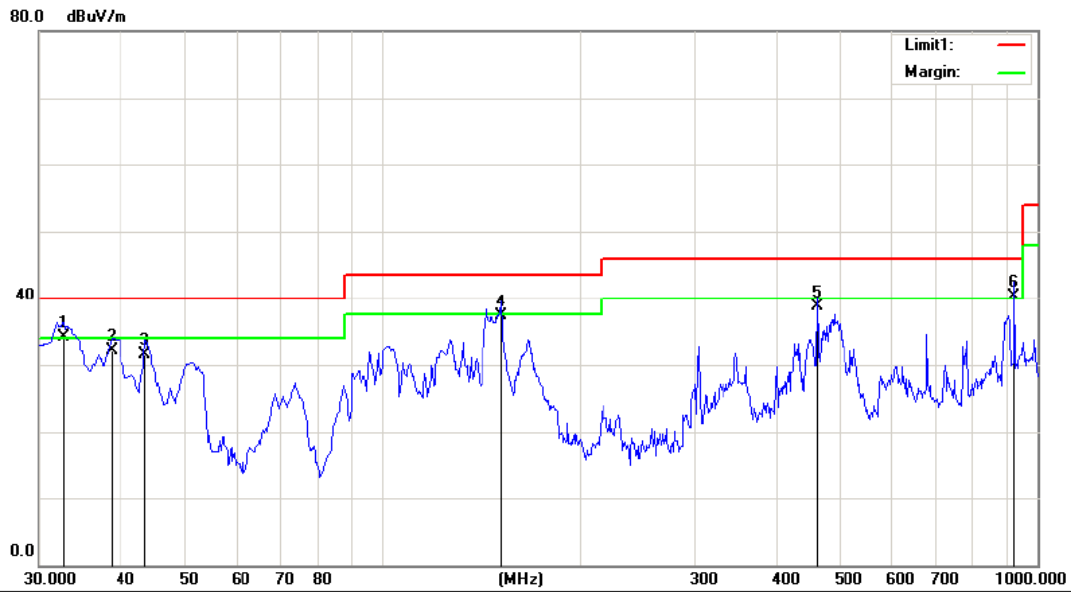

Site site #1      Polarization: **Vertical**      Temperature: 24  
 Limit: (RE)FCC PART 15 class B 3m      Power: AC 120V/60Hz      Humidity: 55 %  
 Mode:TX2412  
 Note:

No.	Mk.	Freq.	Reading Level	Correct Factor	Measurement	Limit	Over	Antenna Height	Table Degree	Comment
		MHz	dBuV	dB	dBuV/m	dBuV/m	dB	cm	degree	
1	!	32.6340	48.51	-14.50	34.01	40.00	-5.99	QP	0	
2		38.7516	45.78	-13.77	32.01	40.00	-7.99	QP	0	
3		43.5800	44.78	-13.37	31.41	40.00	-8.59	QP	0	
4		152.2200	55.24	-17.94	37.30	43.50	-6.20	QP	0	
5		461.6500	49.68	-10.99	38.69	46.00	-7.31	QP	0	
6	*	923.3700	43.14	-2.74	40.40	46.00	-5.60	QP	0	

\*:Maximum data    x:Over limit    !:over margin

Operator: John

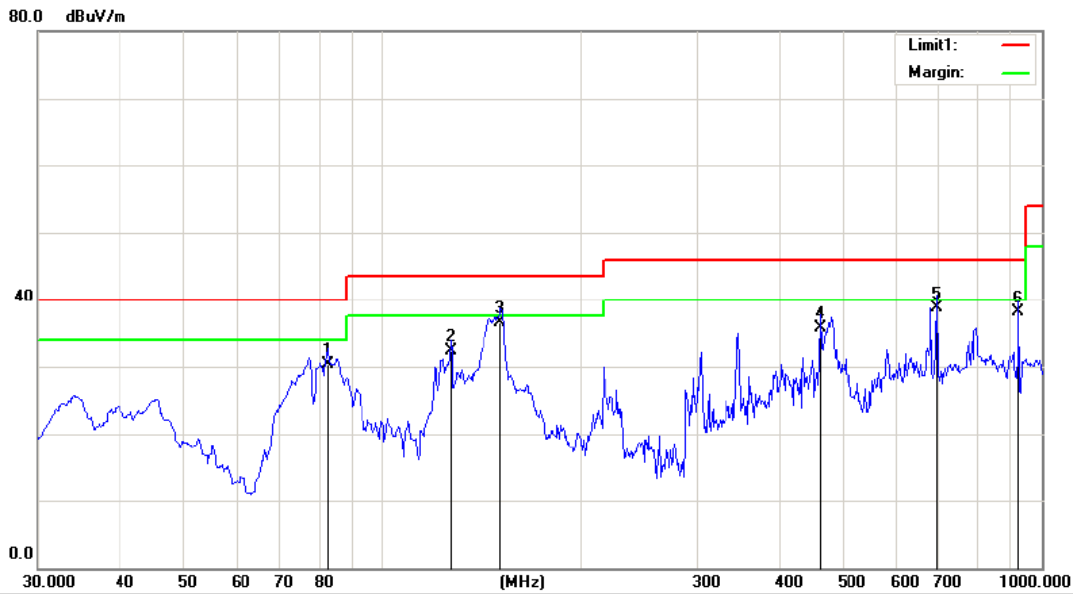

Site site #1      Polarization: **Horizontal**      Temperature: 24  
 Limit: (RE)FCC PART 15 class B 3m      Power: AC 120V/60Hz      Humidity: 55 %  
 Mode: TX2437  
 Note:

No.	Mk.	Freq.	Reading Level	Correct Factor	Measurement	Limit	Over	Antenna Height	Table Degree
		MHz	dBuV	dB	dBuV/m	dBuV/m	dB	cm	degree
1		82.3800	52.44	-22.16	30.28	40.00	-9.72	QP	0
2		127.0000	48.67	-16.34	32.33	43.50	-11.17	QP	0
3	*	151.2500	54.31	-17.85	36.46	43.50	-7.04	QP	0
4		461.6500	46.57	-10.96	35.61	46.00	-10.39	QP	0
5		692.5100	46.17	-7.37	38.80	46.00	-7.20	QP	0
6		923.3700	40.78	-2.76	38.02	46.00	-7.98	QP	0

\*:Maximum data    x:Over limit    !:over margin

Operator: John

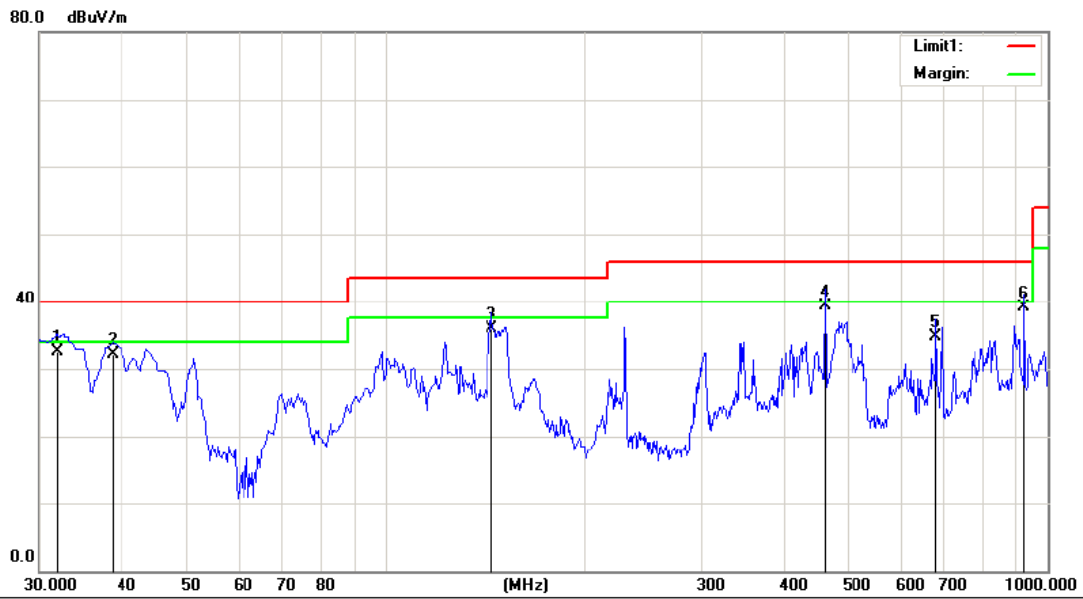

Site site #1 Polarization: **Vertical** Temperature: 24  
 Limit: (RE)FCC PART 15 class B 3m Power: AC 120V/60Hz Humidity: 55 %  
 Mode: TX2437  
 Note:

No.	Mk.	Freq.	Reading Level	Correct Factor	Measurement	Limit	Over	Antenna Height	Table Degree	
		MHz	dBuV	dB	dBuV/m	dBuV/m	dB	cm	degree	Comment
1		31.9542	47.15	-14.63	32.52	40.00	-7.48	QP	0	
2		38.7300	45.87	-13.77	32.10	40.00	-7.90	QP	0	
3		144.4600	53.24	-17.36	35.88	43.50	-7.62	QP	0	
4	*	461.6500	50.21	-10.99	39.22	46.00	-6.78	QP	0	
5		679.9000	42.34	-7.57	34.77	46.00	-11.23	QP	0	
6		923.3700	41.87	-2.74	39.13	46.00	-6.87	QP	0	

\*:Maximum data    x:Over limit    !:over margin

Operator: John

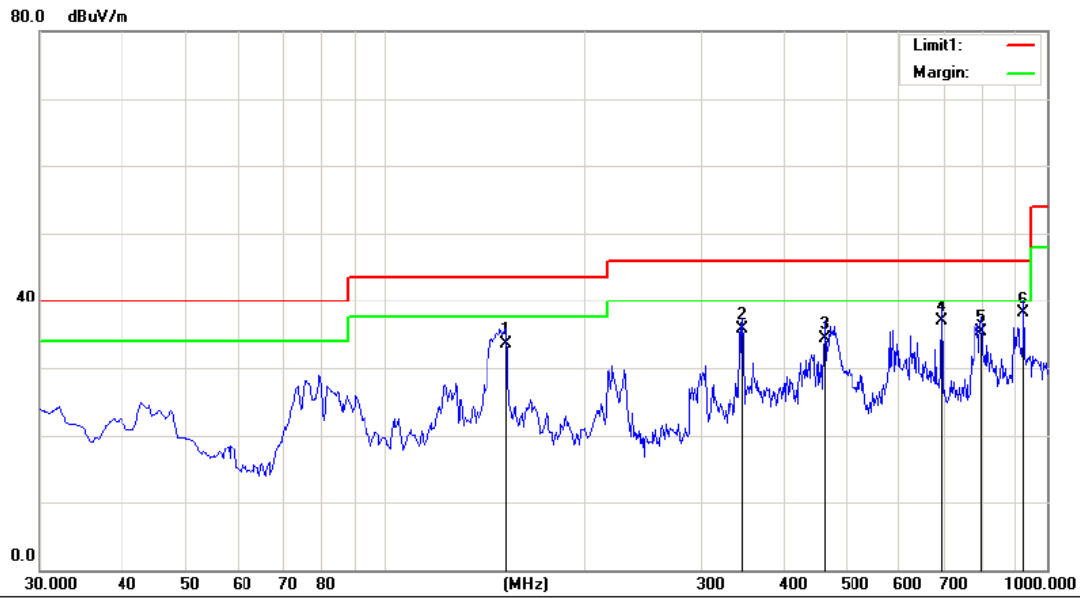

Site site #1      Polarization: **Horizontal**      Temperature: 24  
 Limit: (RE)FCC PART 15 class B 3m      Power: AC 120V/60Hz      Humidity: 55 %  
 Mode:TX2462  
 Note:

No.	Mk.	Freq. MHz	Reading Level dBuV	Correct Factor dB	Measure- ment dBuV/m	Limit dBuV/m	Over dB	Detector	Antenna Height cm	Table Degree	Comment
1		152.2200	51.47	-17.94	33.53	43.50	-9.97	QP		0	
2		347.1900	48.67	-13.01	35.66	46.00	-10.34	QP		0	
3		461.6500	45.17	-10.96	34.21	46.00	-11.79	QP		0	
4		692.5100	44.34	-7.37	36.97	46.00	-9.03	QP		0	
5		796.3000	40.51	-5.23	35.28	46.00	-10.72	QP		0	
6	*	923.3700	40.78	-2.76	38.02	46.00	-7.98	QP		0	

\*:Maximum data    x:Over limit    !:over margin

Operator: John



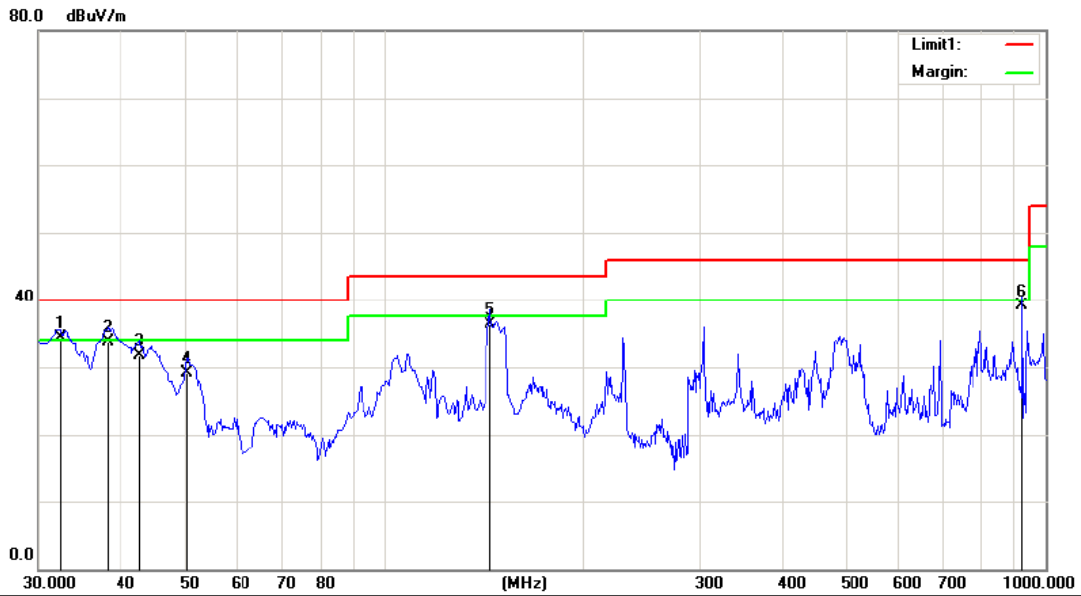

Site site #1 Polarization: **Vertical** Temperature: 24  
 Limit: (RE)FCC PART 15 class B 3m Power: AC 120V/60Hz Humidity: 55 %  
 Mode: TX2462  
 Note:

No.	Mk.	Freq.	Reading Level	Correct Factor	Measurement	Limit	Over	Antenna Height	Table Degree	Comment
		MHz	dBuV	dB	dBuV/m	dBuV/m	dB	cm	degree	
1	*	32.4060	48.78	-14.55	34.23	40.00	-5.77	QP	0	
2		38.2120	47.52	-13.81	33.71	40.00	-6.29	QP	0	
3		42.6100	45.14	-13.49	31.65	40.00	-8.35	QP	0	
4		50.3700	44.74	-15.58	29.16	40.00	-10.84	QP	0	
5		144.4600	53.64	-17.36	36.28	43.50	-7.22	QP	0	
6		923.3700	41.75	-2.74	39.01	46.00	-6.99	QP	0	

\*:Maximum data x:Over limit !:over margin

Operator: John

**Above 1000MHz:**

Operation Mode: 802.11b Lowest      Test Date : September 10, 2015  
 Test Voltage: AC 120V/60Hz      Test by: Andy

Freq. (MHz)	Ant. Pol. H/V	Emission Level(dBuV/m)		Limit 3m(dBuV/m)		Over(dB)	
		PK	AV	PK	AV	PK	AV
4824	V	64.02	46.35	74	54	-9.98	-7.65
7236	V	63.24	45.25	74	54	-10.76	-8.75
9648	V	62.05	44.01	74	54	-11.95	-9.99
12060	V	61.85	43.26	74	54	-12.15	-10.74
14472	V	59.35	42.58	74	54	-14.65	-11.42
16884	V	58.05	41	74	54	-15.95	-13
4824	H	65.35	45.36	74	54	-8.65	-8.64
7236	H	64.25	44.15	74	54	-9.75	-9.85
9648	H	63.25	43.62	74	54	-10.75	-10.38
12060	H	62.74	42.05	74	54	-11.26	-11.95
14472	H	61.04	41.58	74	54	-12.96	-12.42
16884	H	60.36	38.48	74	54	-13.64	-15.52

Operation Mode: 802.11b Middle      Test Date : September 10, 2015  
 Test Voltage: AC 120V/60Hz      Test by: Andy

Freq. (MHz)	Ant. Pol. H/V	Emission Level(dBuV/m)		Limit 3m(dBuV/m)		Over(dB)	
		PK	AV	PK	AV	PK	AV
4874	V	65.85	46.12	74	54	-8.15	-7.88
7311	V	64.15	45.02	74	54	-9.85	-8.98
9688	V	63.05	44.35	74	54	-10.95	-9.65
12185	V	62.35	43.24	74	54	-11.65	-10.76
14622	V	61.25	42.01	74	54	-12.75	-11.99
17059	V	59.35	41.59	74	54	-14.65	-12.41
4874	H	64.23	44.01	74	54	-9.77	-9.99
7311	H	63.24	43.62	74	54	-10.76	-10.38
9688	H	62.05	42	74	54	-11.95	-12
12185	H	61.72	41.39	74	54	-12.28	-12.61
14622	H	60.35	40.25	74	54	-13.65	-13.75
17059	H	59.57	39.78	74	54	-14.43	-14.22

Operation Mode: 802.11b Highest

Test Date : September 10, 2015

Test Voltage: AC 120V/60Hz

Test by: Andy

Freq. (MHz)	Ant. Pol. H/V	Emission Level(dBuV/m)		Limit 3m(dBuV/m)		Over(dB)	
		PK	AV	PK	AV	PK	AV
4924	V	64.36	45.35	74	54	-9.64	-8.65
7386	V	63.25	44.15	74	54	-10.75	-9.85
9848	V	62.15	43.25	74	54	-11.85	-10.75
12310	V	61.05	42.15	74	54	-12.95	-11.85
14772	V	60.35	41.92	74	54	-13.65	-12.08
17234	V	59.25	40.72	74	54	-14.75	-13.28
4924	H	65.35	45.36	74	54	-8.65	-8.64
7386	H	64.25	44.15	74	54	-9.75	-9.85
9848	H	63.69	43.25	74	54	-10.31	-10.75
12310	H	62.25	42.85	74	54	-11.75	-11.15
14772	H	61.42	41.69	74	54	-12.58	-12.31
17234	H	60.28	40.35	74	54	-13.72	-13.65

**All emissions not reported were more than 20dB below the specified limit or in the noise floor.**

- Note:**
- (1) All Readings are Peak Value and AV.
  - (2) Emission Level= Reading Level+Probe Factor +Cable Loss.
  - (3) Data of measurement within this frequency range shown " – " in the table above means the reading of emissions are attenuated more than 20dB below the permissible limits or the field strength is too small to be measured.

# APPENDIX I (PHOTOS OF EUT)





