



ENGLISH

FRANÇAIS

ESPAÑOL

Service Hotline:
Ligne d'assistance téléphonique:
Línea de servicio:

1-855-MY-SEIKI (1-855-697-3454)

USER MANUAL
MANUEL D'UTILISATION
MANUAL DEL USUARIO

www.SEIKI.com

SE40FY19T

LED TV



CONTENTS

Important Safety Instructions	2
Safety Information	3
Preparation	4
What's Included	4
Front View	5
Rear View	6
Installing the Stand	7
Removing the Stand for Wall-Mounting	7
Remote Control	8
Connecting External Devices	9
Customizing TV Settings	10
Initial Setup	10
Navigating the Setup Settings	11
Streaming	12
Media	13
Viewing Photos	13
Listening to Music	14
Source	14
Setup	15
Settings	15
Audio	16
Picture	17
Channel	18
Time	18
Network	19
Lock	21
Parental Control	22
Troubleshooting	24
Maintaining	25
Specification	26
Limited Warranty	27
OTT APP Service	28

IMPORTANT SAFETY INSTRUCTIONS

IMPORTANT SAFETY INSTRUCTIONS

- **Read these instructions** – All the safety and operating instructions should be read before this product is operated.
- **Keep these instructions** – The safety and operating instructions should be retained for future reference.
- **Heed all warnings** – All warnings on the appliance and in the operating instructions should be adhered to.
- **Follow all instructions** – All operating and use instructions should be followed.
- **Do not use this apparatus near water** – The appliance should not be used near water or moisture – for example, in a wet basement or near a swimming pool, and the like.
- Clean only with dry cloth.
- **Do not** block any ventilation openings. Install in accordance with the manufacturer's instructions.
- **Do not** install near any heat sources such as radiators, heat registers, stoves, or other apparatus (including amplifiers) that produce heat.
- **Do not** defeat the safety purpose of the polarized or grounding-type plug. A polarized plug has two blades with one wider than the other. A grounding-type plug has two blades and a third grounding prong. The wide blade or the third prong are provided for your safety. If the provided plug does not fit into your outlet, consult an electrician for replacement of the obsolete outlet.
- Protect the power cord from being walked on or pinched particularly at plugs, convenience receptacles, and the point where they exit from the apparatus.
- Only use attachments/accessories specified by the manufacturer.
- Use only with the cart, stand, tripod, bracket, or table specified by the manufacturer, or sold with the apparatus. When a cart is used, use caution when moving the cart/apparatus combination to avoid injury from tip-over.
- Unplug this apparatus during lightning storms or when unused for long periods of time.



- Unplug this apparatus during lightning storms or when unused for long periods of time.
- Refer all servicing to qualified service personnel. Servicing is required when the apparatus has been damaged in any way, such as the power-supply cord or plug is damaged, liquid has been spilled or objects have fallen into the apparatus, the apparatus has been exposed to rain or moisture, does not operate normally, or has been dropped.

- Please keep the unit in a well-ventilated environment.

WARNING: To reduce the risk of fire or electric shock, do not expose this apparatus to rain or moisture. The apparatus should not be exposed to dripping or splashing. Objects filled with liquids, such as vases should not be placed on apparatus.

WARNING: The batteries shall not be exposed to excessive heat such as sunshine, fire or the like.

WARNING: The mains plug is used as disconnect device, the disconnect device shall remain readily operable.

WARNING: To reduce the risk of electric shock, do not remove cover (or back) as there are no user-serviceable parts inside. Refer servicing to qualified personnel.



 This lightning flash with arrowhead symbol within an equilateral triangle is intended to alert the user to the presence of non-insulated "dangerous voltage" within the product's enclosure that may be of sufficient magnitude to constitute a risk of electric shock.

 The exclamation point within an equilateral triangle is intended to alert the user to the presence of important operating and maintenance instructions in the literature accompanying the appliance.

 This equipment is a Class II or double insulated electrical appliance. It has been designed in such a way that it does not require a safety connection to electrical earth.

 This product contains electrical or electronic materials. The presence of these materials may, if not disposed of properly, have potential adverse effects on the environment and human health. Presence of this label on the product means it should not be disposed of as unsorted waste and must be collected separately. As a consumer, you are responsible for ensuring that this product is disposed of properly.

SAFETY INFORMATION

To ensure reliable and safe operation of this equipment, please carefully read all the instructions in this user guide, especially the safety information below.

Electrical Safety

- The TV set should only be connected to a main power supply with voltage that matches the label at the rear of the product.
- To prevent overload, do not share the same power supply socket with too many other electronic components.
- Do not place any connecting wires where they may be stepped on or tripped over.
- Do not place heavy items on any connecting wire, which may damage the wire.
- Hold the main plug, not the wires, when removing from a socket.
- During a thunderstorm or when not in using the television for long periods, turn off the power switch on the back of the television.
- Do not allow water or moisture to enter the TV or power adapter. Do not use in wet, moist areas, such as bathrooms, steamy kitchens or near swimming pools.
- Pull the plug out immediately, and seek professional help if the main plug or cable is damaged, liquid is spilled onto the set, if the TV set accidentally exposed to water or moisture, if anything accidentally penetrates the ventilation slots or if the TV set does not work normally.
- Do not remove the safety covers. There are no user serviceable parts inside. Trying to service the unit yourself is dangerous and may invalidate the product's warranty. Qualified personnel must only service this apparatus.
- To avoid a battery leakage, remove batteries from the remote control, when the remote is not use for long period, or when the batteries are exhausted.
- Do not break open or throw exhausted batteries into a fire.

Physical Safety

- Do not block ventilation slots in the back cover. You may place the TV in a cabinet, but ensure at least 5cm (2") clearance all around.
- Do not tap or shake the TV screen, or you may damage the internal circuits. Take good care of the remote control.
- To clean the TV use a soft dry cloth. Do not use solvents or petroleum based fluids.
- Do not install near any heat sources such as radiators, heat registers, stoves or other apparatus (including amplifiers) that produce heat.
- Do not defeat the safety purpose of the polarized or grounding-type plug. A polarized plug has two blades with one wider than the other. A grounding plug has two blades and a third grounding prong, the wide blade, or the third prong is provided for your safety. If the provided plug does not fit into your outlet, consult an electrician for replacement of the obsolete outlet.
- Protect the power cord from being walked on or pinched particularly at plugs.
- Unplug the apparatus during lightning storms or when unused for long periods.
- Refer all servicing to a qualified service personnel. Servicing is required if the apparatus does not operate normally or if the apparatus, including the power supply cord or pulg, has been damaged in any way.
- Servicing is also required if liquid has been spilled, or objects have fallen into the apparatus; when the apparatus has been exposed to rain or moisture; or if the apparatus has been dropped.
- Always connect your television to a power outlet with protective ground connection.

PREPARATION

What's Included

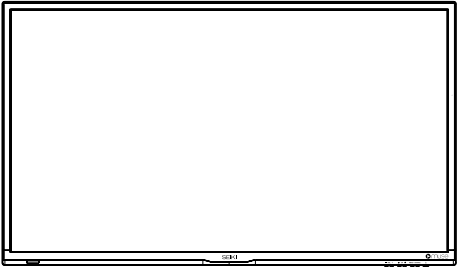

TV Set

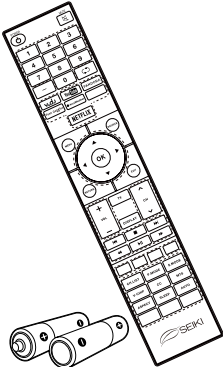

Remote Control with Batteries



TV Stand

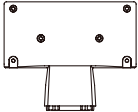

Stand Support

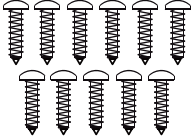

Eleven Screws



User Manual



Quick Start Guide

Front View

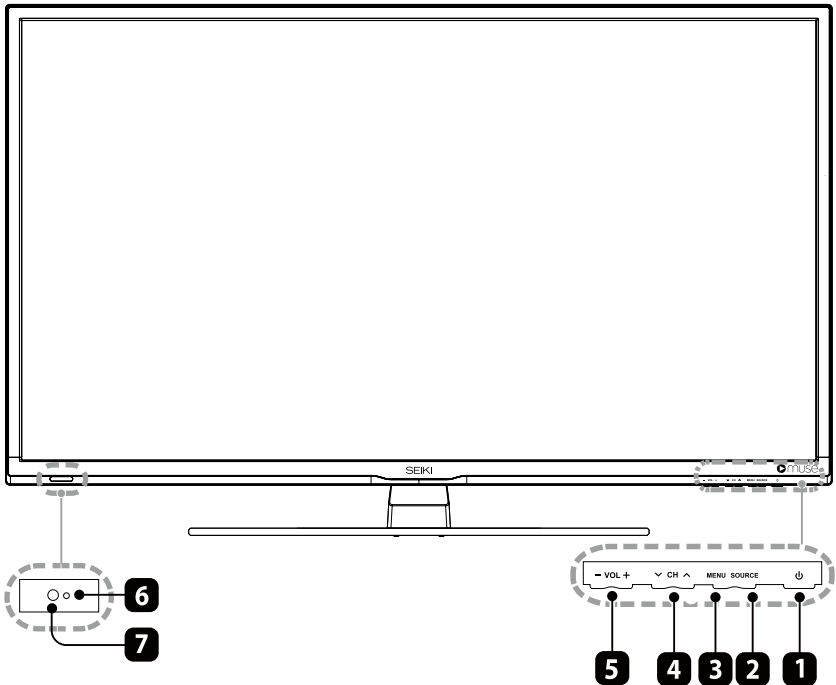

1. **POWER**
Switch the TV between On / Standby mode.
2. **SOURCE**
Press to select among different input signal sources.
3. **MENU**
Display the main menu.
4. **CH ∇/\wedge**
Press to select a channel.
5. **VOL $-/+$**
Press to adjust the volume.
6. **IR (Infrared Receiver)**
Receive IR signals from the remote control.
7. **POWER Indicator**
Illuminate blue when the TV is turned on. Illuminate red when the TV is in standby mode.

Rear View

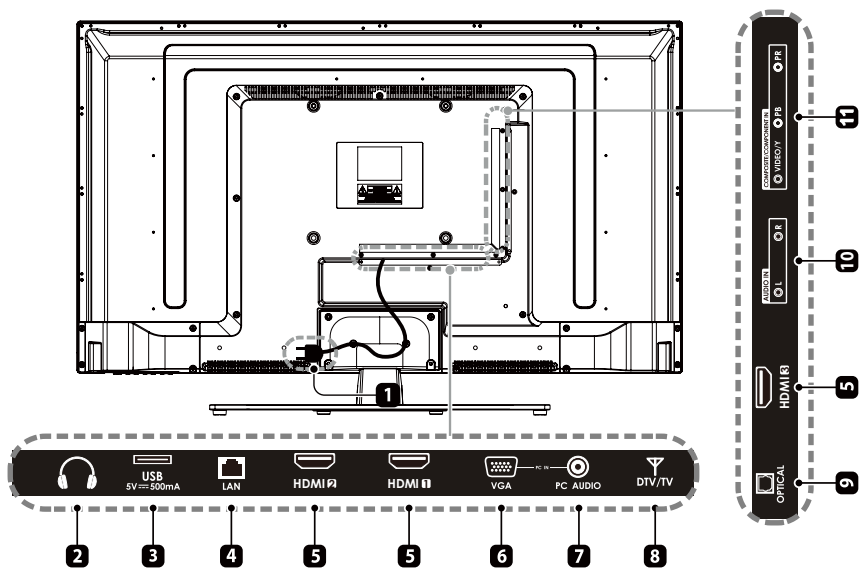

1. **Power Cord**
Connect to AC power outlet.
2. **Headphone Socket**
Connect to the Headphones.
3. **USB Port**
Connect to a USB storage device to play compatible audio and photo files.
4. **LAN**
Network connection port.
5. **HDMI Input**
Connect to a High-Definition (HD) signal input device.
6. **VGA Input**
Connect to a computer or other devices with a VGA interface.
7. **PC AUDIO Input**
Connect to a computer audio output.
8. **DTV/TV Input**
Connect to the antenna (75Ω VHF/UHF) socket with the RF coaxial cable.
9. **OPTICAL Output**
Connect a digital sound system to this jack.
10. **AUDIO Input**
Connect to the AUDIO (L/R) output sockets on external audio devices.
11. **COMPOSITE/COMPONENT IN**
Connect to AV devices with composite/component (Y/Pb/Pr) video and audio output sockets. COMPOSITE VIDEO and COMPONENT(Y/PB/PR) share with AUDIO IN (L/R).

Installing the Stand

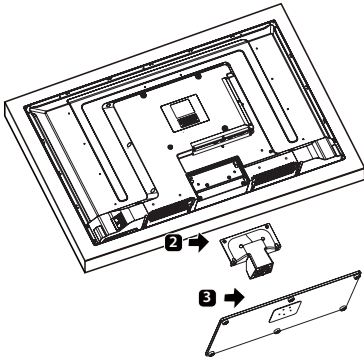

- 1. Lay the TV face down on a flat, cushioned surface to avoid damaging or scratching.
- 2. Attach the stand to the TV with six screws provided.
- 3. Attach the base to the stand with the five screws provided.

Removing the Stand for Wall-Mounting

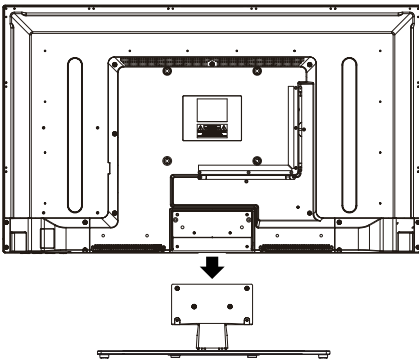

- 1. Lay the TV face down on a flat, cushioned surface to avoid damaging or scratching.
- 2. Untighten the 6 pcs screws holding the stand assembly and remove them.
- 3. Attach the wall-mount bracket to the TV using the mounting holes on the back of the TV. Mount this TV according to the instructions included in the wall-mount bracket.

WARNING: This apparatus is intended to be supported by UL Listed wall mount bracket.

Remote Control

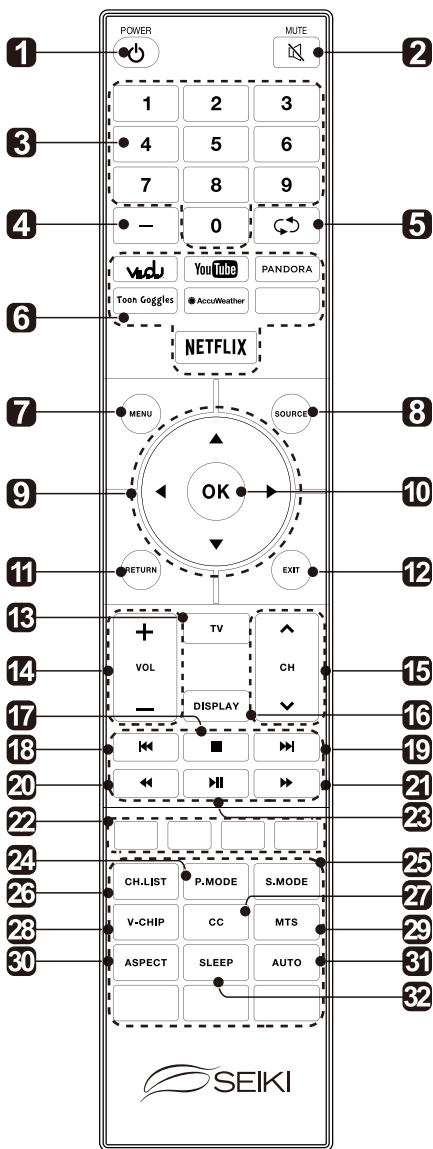

1. : Switch the TV between On and Standby mode.
2. **MUTE**: Mute and restore TV sound.
3. **0-9**: Select a program. (ATV/DTV mode)
4. *****: Enter multiple program channel number such as 2-1.
5. : Return to the previous viewing channel.
6. **APP**: Press to select the desired APP.
7. **MENU**: Display the main menu.
8. **SOURCE**: Select among the different input signal sources: TV/AV/COMPONENT/HDMI1/HDMI2/HDMI3/VGA.
9. : Allows you to navigate the on screen display menus and adjust the system settings to your preference.
10. **OK**: Confirm the selection.
11. **RETURN**: Return to previous menu.
12. **EXIT**: Exit the on screen display menu.
13. **TV**: Press to turn to TV mode.
14. **VOL+/-**: Adjust the volume.
15. **CH+/-**: Select the channel.
16. **DISPLAY**: Display the present screen information such as the current channel and input source.
17. : Stop the playback.
18. : Skip to the beginning of the previous chapter/track/photo.
19. : Skip to the beginning of the next chapter/track/photo.
20. : Reverse playback rapidly.
21. : Advance playback rapidly.
22. **COLOR BUTTONS**: Press to access directly to the corresponding function in APP service.
23. : Start playback or pause.
24. **P.MODE**: Select picture mode: dynamic/movie/user/standard.
25. **S.MODE**: Select sound mode: standard/music/movie/user.
26. **CH.LIST**: Display program list.
27. **CC**: Closed Caption selection: ON/OFF/CC On Mute.
28. **V-CHIP**: Set up parental control.
29. **MTS**: Switch among different audio channels: STEREO/MONO/SAP.
30. **ASPECT**: Select the aspect ratio settings: standard/wide/wide zoom/zoom.
31. **AUTO**: Press to adjust the picture automatically in VGA source.
32. **SLEEP**: Set the TV sleep timer: OFF/5/10.../180/240 min.

CONNECTING EXTERNAL DEVICES

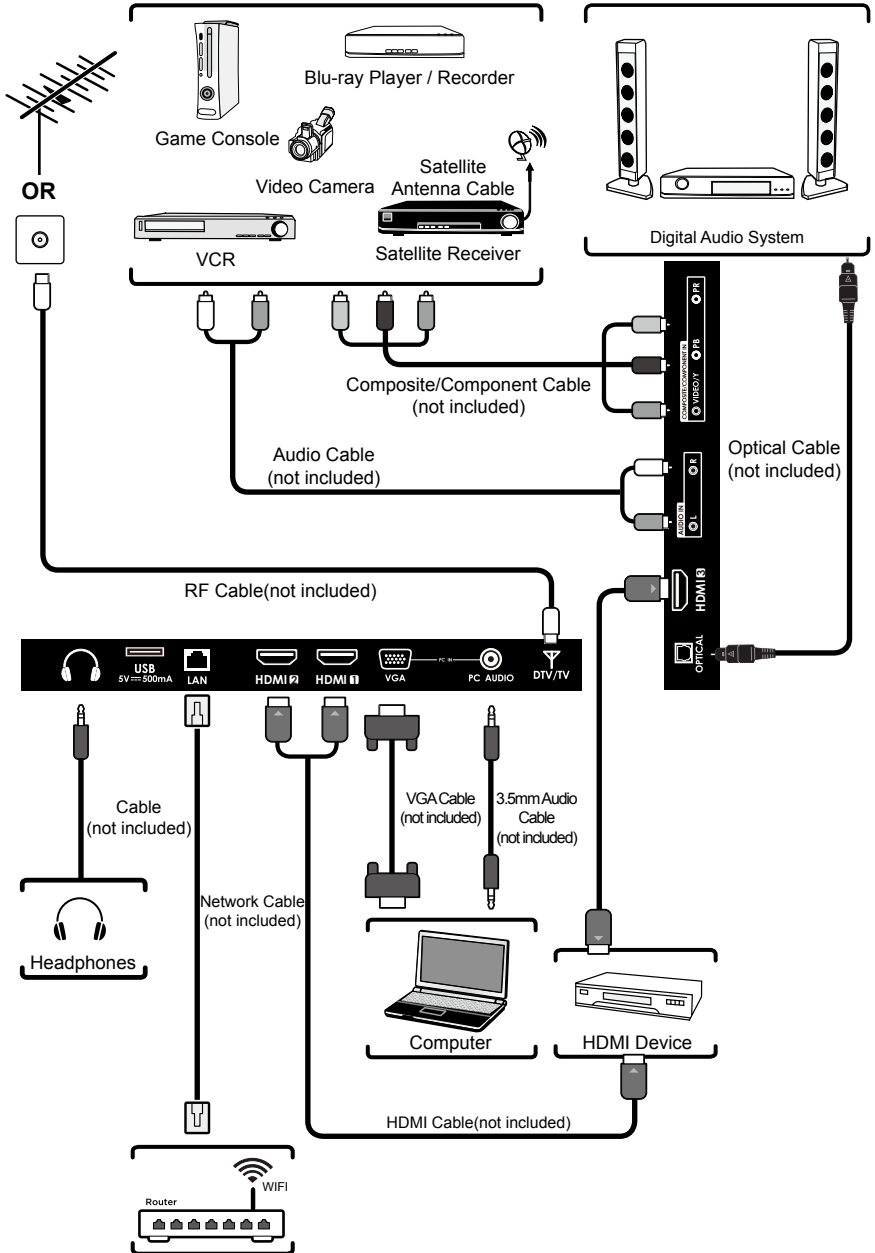

CUSTOMIZING TV SETTINGS

Initial Setup

- Connect the power cord to the power socket after you have completed all the physical connections. At this stage, the TV will enter Standby Mode and the red LED indicator will illuminate.
- In Standby Mode, press the **U** button on the main unit or on the remote control to turn the TV on. The red LED indicator will turn blue.
- The first time you turn the TV on, it will go into the Setup Wizard. Press **▲/▼** buttons to select your desired mode and press **OK** to confirm.

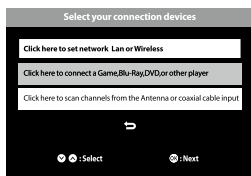
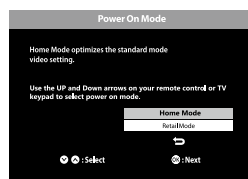
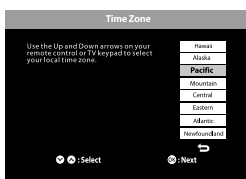

Home Mode : The picture mode will be Standard if you select this mode.

Retail Mode : Select Dynamic Mode if you would like your picture to be brighter. At times this mode may use more energy to operate the Volume/Sound Mode and Picture Mode.

- The **SLEEP-MODE Power** should be less than 1 W.

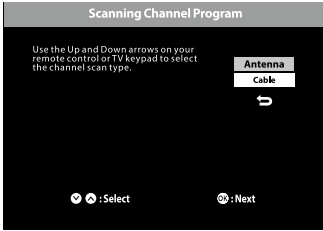

6



7

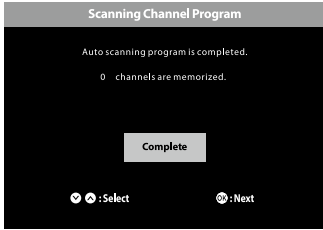

8

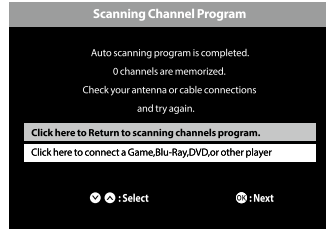

9

- If channels can not be found, this frame will be displayed automatically.

■ Navigating the Setup Settings

- Press the **MENU** button to display the main menu.
- Use **▲/▼** buttons to select **SETUP** menu and then press **◀/▶** buttons to navigate and select the available menu.

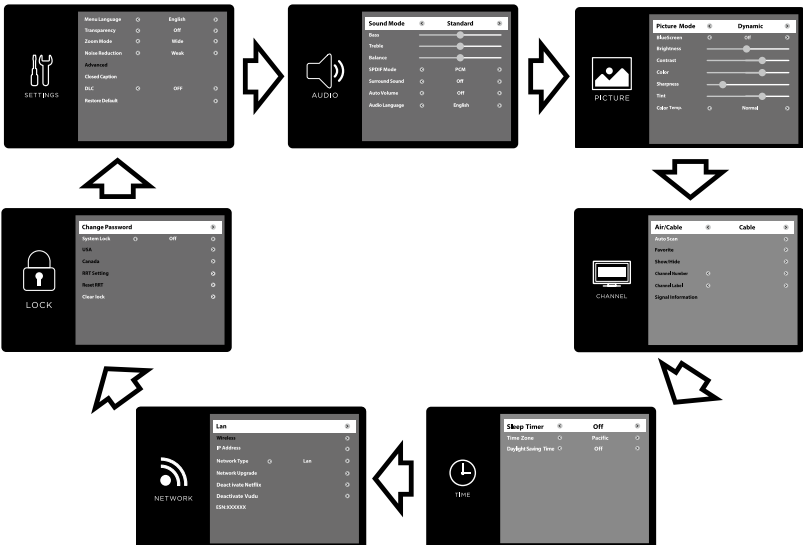

STREAMING

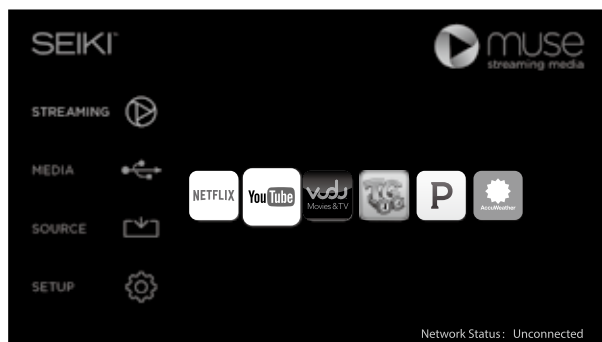

- Press the **MENU** button on the main unit or on the remote control to display the **STREAMING**. Then press ◀/▶ buttons to select the desired APP and press **OK** button to view what you want. Or press the hotkey on the remote control to enter the APP directly.

Note: After the TV connects to network, the status Unconnected will alter to Connected.

NETFLIX	Enjoys TV shows & movies streamed instantly over the Internet.
YouTube	YouTube your way on the best screen in your house.
VUDU	Discover, watch and collect the latest movies and TV shows in high quality 1080p. Free to sign up. No subscriptions, late fees or commitments.
Toongoggles	A subscription video on-demand platform that offers animated, fun and educational cartoons, engaging games and songs from all over the world and in many different languages to children.
Pandora	Free personalized radio that offers effortless and endless music enjoyment and discovery. Just start with the name of one of your favorite artists, songs, genres or composers and Pandora will do the rest. It's easy to create personalized stations that play only music you'll love.
AccuWeather	Displays the current weather conditions and the temperature anywhere in the world in centigrade or Fahrenheit.

MEDIA



NOTE: Portable storage devices(USB disk or Hard disk) should be inserted.

- Press the **MENU** button on the main unit or on the remote control and then press **▲/▼** buttons to select the **MEDIA**, and then press **OK** button to enter.

■ Viewing Photos

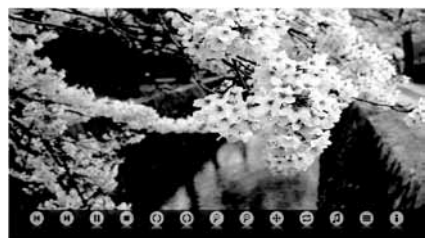
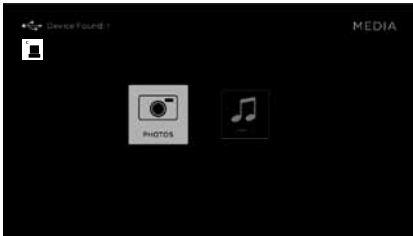

- After entering **MEDIA**, press **◀/▶** buttons to select **PHOTOS** and then select the disk type to enter. Then use **▲/▼ / ◀/▶** buttons to navigate in the picture folder and then press **OK** button enter.

Note: File format supported: **JPEG**.

■ Listening to Music

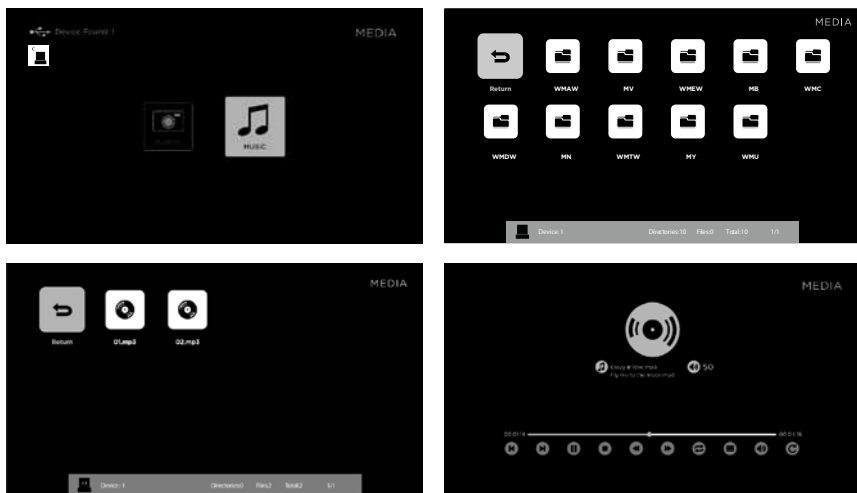

- After entering **MEDIA**, press ◀/▶ buttons to select **MUSIC** and then select the disk type to enter. Then use ▲/▼ / ◀/▶ buttons to navigate in the music folder and then press **OK** button enter.

Note: File format supported: **MP3**.

■ SOURCE



- Press the **MENU** button on the main unit or on the remote control and press ▲/▼ buttons to select the **SOURCE** menu. Then press ◀/▶ buttons to select different input sources among: **TV/ AV/ COMPONENT/ HDMI1/ HDMI2/ HDMI3/ VGA** and press **OK** button to confirm.

SETUP



- Press the **MENU** button on the main unit or on the remote control to display the main interface. Then press ▲/▼ buttons to select **SETUP** menu and press ◀/▶ button to select the desired option.

SETTINGS

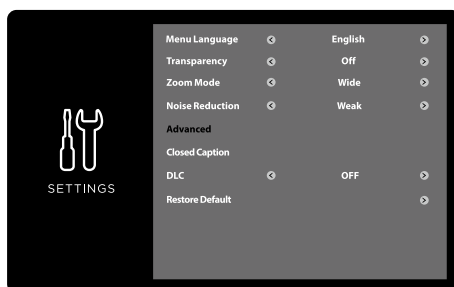

- Press ◀/▶ buttons to select **SETTINGS** menu and then press **OK** button to enter. Press ▲/▼ buttons to select the following setting options and then press ◀/▶ buttons to adjust each option's setting.

Menu Language	Select menu language : English, French or Spanish. The default on-screen menu language is English.
Transparency	Select to turn On/Off transparency function.
Zoom Mode	Select zoom mode : Wide/Wide Zoom/Zoom/Standard. Note: Different input source, the zoom mode options may differ.
Noise Reduction	Reduce the noise level of the connected device: Off/Weak/Middle/Strong.

Advanced	Adjust advanced option's setting: H-POS, V-POS, Clock, Phase or Auto. (VGA source mode only)	
Closed Caption	CC Mode	Select CC mode : On, Off or CC on Mute.
	Basic Selection	Basic Selection: CC1, CC2, CC3, CC4, Text1, Text2, Text3, Text4.
	Advanced Selection	Advanced Selection: Service1, Service2, Service3, Service4, Service5, and Service6.
	Option	Options: Mode, Font, Size, Edge Effect, Edge Color, Text Color, Background Color, Text Opacity, Background Opacity.
DLC	Select to turn On/Off the dynamic luminance control.	
Restore Default	Restore the TV to factory default settings.	

■ AUDIO

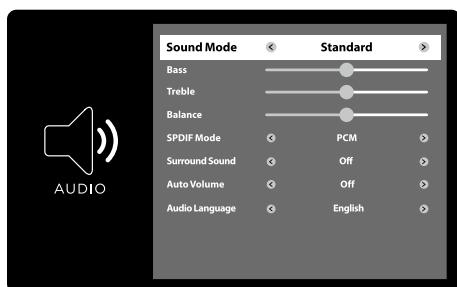

- Press ◀/▶ buttons to select **AUDIO** menu and then press **OK** button to enter. Press ▲/▼ buttons to select the following audio options and then press ◀/▶ buttons to adjust each option's setting.

Sound Mode	Allow the selection of an audio-enhancement technique: Standard/Music/Movie/User Alternative: you may press the S.MODE button to select the sound mode directly.
Bass	Control the relative intensity of lower-pitched sounds. (For User mode)
Treble	Control the relative intensity of higher-pitched sounds. (For User mode)
Balance	Adjust the relative volume of the speaker in a multiple speaker system.
SPDIF Mode	Select the digital audio output mode between RAW/PCM.
Surround Sound	Provide an enhanced listening experience.
Auto Volume	Volume levels are automatically controlled.
Audio Language	Select audio language among: English, French, Spanish

■ PICTURE

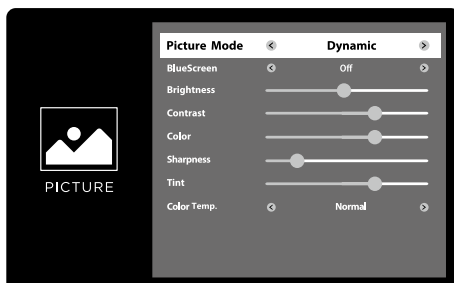

- Press ◀/▶ buttons to select **PICTURE** menu and then press **OK** button to enter. Press ▲/▼ buttons to select the following picture options and then press ◀/▶ buttons to adjust each option's setting.

Picture Mode	Cycle among picture mode: Dynamic/Movie/User/Standard. Alternative: you may press the P.MODE button to select the picture mode directly.
Blue Screen	Allow the blue background to turn On/Off during weak or no signal conditions.
Brightness	Increase or decrease the amount of white in the picture. (For User mode)
Contrast	Adjust the difference between light and dark levels in the pictures. (For User mode)
Color	Control the color intensity. (For User mode)
Sharpness	Adjust the level of crispness in the edges between light and dark areas of the picture. (For User mode)
Tint	Adjust the balance between red and green levels.
Color Temp.	Cycle among color temperatures: Cool/Normal/Warm.

■ CHANNEL

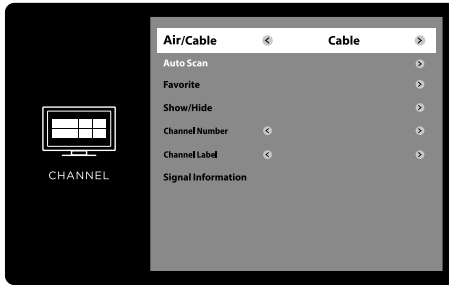

- Press ◀/▶ buttons to select **CHANNEL** menu and then press **OK** button to enter. Press ▲/▼ buttons to select the following channel options and then press ◀/▶ buttons to adjust each option's setting.

Air/Cable	Select antenna between Air and Cable.
Auto Scan	First, select your cable system from Auto/STD/IRC/HRC. Next, select the Auto Scan feature to scan your available cable channels. It will perform the auto scan if the Air antenna is selected.
Favorite	Set the selected channel as favorite channels.
Show/Hide	Show/Hide the selected channel.
Channel Number	Display the current channel name.
Channel Label	Display the current channel label.
Signal Information	Display the information of current signal.

■ TIME



- Press ◀/▶ buttons to select **TIME** menu and then press **OK** button to enter. Press ▲/▼ buttons to select the following time options and then press ◀/▶ buttons to adjust each option's setting.

Sleep Timer	Select a period of time after which the TV automatically switches to standby mode: Off/5/10/.../180/240 min. Alternative: You may press the SLEEP button repeatedly to select the number of minutes directly.
Time Zone	Select a Time Zone: Hawaii/ Alaska/ Pacific/ Mountain/ Central/ Eastern/ Atlantic/ Newfoundland.
Daylight Saving Time	Select to turn On/Off daylight saving time.

■ NETWORK

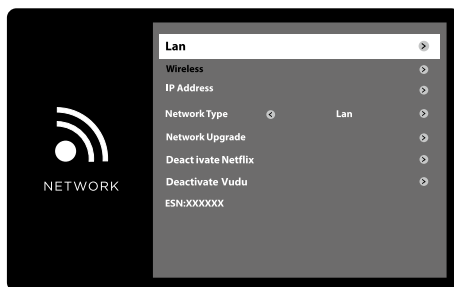

- Press ◀/▶ buttons to select **NETWORK** menu and then press **OK** button to enter. Press ▲/▼ buttons to select the following network options and then press ◀/▶ buttons to adjust each option's setting.

Lan	Connect the TV to the wired Lan: Auto Get IP/Manual Get IP.
Wireless	Connect the TV to the wireless network through searching the available Wifi.
IP Address	Display the current IP information.
Network Type	Select two types of network: Wireless or Lan.
Network Upgrade	Upgrade the TV software through the network.
Deactivate Netflix	Deactivate Netflix and clear the account information.
Deactivate Vudu	Deactivate Vudu and clear the account information.
ESN	Electronic Serial Number

Auto Upgrade

- After the TV connects to network, the system will automatically detect software version.



- If there is a new version, it will be downloaded in the background. When you want to enter the app, a menu bar will pop up reminding you that upgrade software is downloading. Please try later...

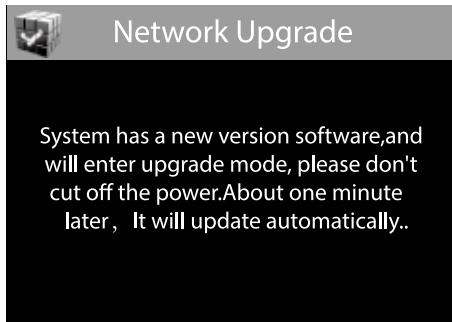

- After the download completed, it can upgrade automatically after users press the standby button.

Note: This procedure is fully automatic, and remember not to cut off the power.

Manual Upgrade

- After the TV connects to network, users can detect whether there is a new version through network manual option.

Reminder for internet connection:

- Below occasions are possible while your internet is connected to enjoy your OTT services.
- 1. Please check your internet signal strength while internet is connected, signal strength below 50 may result bad connection and non-smooth picture.
- 2. To enter OTT services, 30 second may be required for internet connection.

Recommended 10Mb above internet speed

■ LOCK

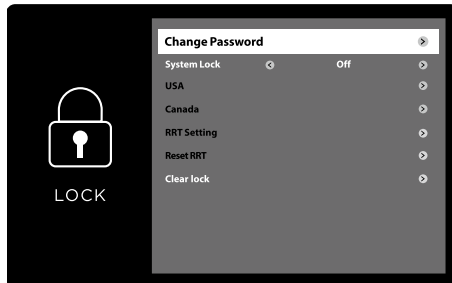

- Press ◀/▶ buttons to select **LOCK** menu and then press **OK** button to enter. Use the 0-9 buttons to input 4-digit password to enter the **LOCK** menu.
- Press ▲/▼ buttons to select the following lock options and then press ◀/▶ buttons to adjust each option's setting.

Note: the default password is "0000".

Change Password	Use 0-9 buttons to input the old password and then input the new 4-digit password. Re-enter new password for confirmation.	
System Lock	Select to turn On/Off system lock. The following options (USA, Canada, RRT Setting and Reset RRT) will only be accessible when you turn the system lock on.	
USA	TV	TV RATING: Press OK button to lock or unlock TV rating.
	MPAA	Select MPAA rating : N/A,G, PG, PG-13, R, NC-17,or X.
Canada	Canada English	Select MPAA rating for English-speaking Canada : E, C, C8+, G, PG, 14+, 18+.
	Canada French	Select MPAA rating for Quebec Canada : E, G, 8 ans+, 13 ans+, 16 ans+, 18 ans+.
RRT Setting	Set Rating Region Table.	
Reset RRT	Select to reset the RRT setting.	
Clear Lock	Clear all lock settings.	

PARENTAL CONTROL

Press the **MENU** button on the main unit or on the remote control and then press ◀/▶ buttons to select **LOCK** menu. Use the **0-9** buttons to input the 4-digit password to enter the **LOCK** menu. If used, this option feature can "block" undesirable programming from appearing on the TV. Parental Control offers the user a wide variety of options and settings that restrict or "block" the programming that can appear on the TV. Parental Control allows the user to define which program rating they consider acceptable for younger more sensitive viewer. It can be preset and turned either on or off by the user who specifies the secret 4-number code, the password. The number of hours blocked are specified. General audiences and children blocks should be both programmed into the TV's memory. Separate different viewer ratings are specified for both TV and the motion picture Industry; both rating systems should be used and based on the ages of children.

Overview

To ensure complete coverage for all TV programs, (movies and regular TV shows) choose a rating for MPAA, from the selections below, as well as ratings from the TV Parental Guidelines Rating Systems below, using the Age Block option for General Audiences, and for children. In addition, you may wish to add additional restrictions from the content block menu, and submenus examples below.

Things to Consider before Setting up Parental Control

Determine which rating you consider acceptable to the viewer. (For example, if you choose TV-PG, more restrictive ratings will be automatically blocked; the viewer will not be able to see: TV-PG, TV-14, or TV-MA rated programming.) You may block the auxiliary video source entirely. (Blocks the signal sent by the equipment, such as VCR, connected to the TV Audio/Video Input Jacks) or remain unblocked, then choose acceptable ratings. Block program "Content" based on individual parameters such as: Strong Dialog, Bad Language, Sex Scenes, Violence Scenes or Fantasy. Violent Scenes; in Content Blk option. Select a secret password, in the Set Password option, using the numbers keys on the remote control. Save the password, it is the only way to access the Parental Control menu and change rating setting, or turn off Parental Control.

- You can set different Parental Control viewing restrictions for general audiences and for children, both can be active at the same time.
- Simply specifying one content block such as Sex Scenes, will not automatically restrict the programming that appears from the video sources.
- Even if you choose to leave the AUX Inputs unblocked, the ratings you specify will automatically restrict the programming that appears from the video sources.
- You cannot disable Parental Control by disconnecting the TV from power. Block hours will be automatically reset to the original block time setting specified if power is disconnected.

PARENTAL CONTROL

• Motion Picture Association of America (MPAA) Rating System

	Grade	Meaning
G	General Audiences	Content not offensive to most viewers.
PG	Parental Guidance Suggested	Content is such that parents may not want their children to view the program.
PG-13	Parents Strongly Cautioned	Program is inappropriate for preteens, with a greater degree of offensive material suggested than a PG rated program.
R	Restricted	Not for children under 17-contains strong element of sex and/or violence.
NC-17	No children under age 17	Not for children under 17-under any circumstances. Contains strong sexual content.
X	Hard Core Films	Same as NC-17 rating.
No Rating	No Rating	MPAA did not rate

• TV Parental Guideline Rating System

	Grade	Meaning
TV-Y	All Children	Content not offensive to most viewers.
TV-Y7	Directed to Older Children	Considered suitable for children over 7- may contain fantasy violence scenes.
TV-G	General Audience	Considered suitable for all audience; children may watch unattended.
TV-PG	Parental Guidance Suggested	Suggested unsuitable for younger children-may contain suggestive language, bad language, sex and violence scenes.
TV-14	Parents Strongly Cautioned	unsuitable for children under 14 - may contain strong language, bad language, sex, and violence scenes.
TV-MA	Mature Audience Only	Adults only- may contain strong language, bad language, sex, and violence scenes.

Canadian Rating:

Canadian English is used throughout all English-speaking Canada (C, C8+, G, PG, 14+, 18+).

Canadian French is used in Quebec (G, 8 ans+, 13 ans+, 16 ans+, 18 ans+)

Note: The V-Chip will automatically block certain categories that are "more restrictive". If you block TV-Y category, then TV-Y7 will be automatically blocked. Similarly, if you block TV-G category, then all the categories in the "young adult" will be blocked (TV-G, TV-PG, TV-14, and TV-MA).

TROUBLESHOOTING

If your TV does not operate normally or cannot be turned on, please check the following troubleshooting questions. Remember also to check any other connected electronic device, such as DVD or Blu-ray player to pinpoint the problem. If the TV still fails to operate normally, please contact technical support.

The TV does not operate properly	
The TV does not respond when pressing any buttons	<ul style="list-style-type: none"> The TV may freeze up during use. Disconnect the power cord from the power socket for a few minutes. Reconnect the power cord and try to operate it again as usual.
TV cannot be switched on	<ul style="list-style-type: none"> Check that the TV is connected to the power supply. Make sure all connected AV devices are switched off before switching on your TV.
The remote control does not work	<ul style="list-style-type: none"> Check to see if there are any objects between the TV and the remote control causing an obstruction. Ensure that you are pointing the remote control directly at the TV. Ensure that the batteries are installed with the correct polarity (+ to +, - to -). Install new batteries.
Power is suddenly turned off	<ul style="list-style-type: none"> Check the power of the TV. The power supply maybe interrupted. Check if the sleep timer is set. Check whether the Auto Standby is activated.
The video function does not work	
No picture & No Sound	<ul style="list-style-type: none"> Check whether the TV is switched on. Try another channel. The problem may be caused by the broadcaster.
Picture appears slowly after switching on	<ul style="list-style-type: none"> This is normal; the image is muted during the TV startup process. Please contact your service centre if the picture has not appeared after five minutes.
No or poor color or poor picture	<ul style="list-style-type: none"> Adjust the settings in the PICTURE menu. Try another channel. The problem may be caused by the broadcaster. Check if video cables are connected properly.
Horizontal/Vertical bar or picture shaking	<ul style="list-style-type: none"> Check for local interference such as an electrical appliance or power tool.
Poor reception on some channels	<ul style="list-style-type: none"> The station or cable channel may be experiencing problems; tune to another station. Station signal may be weak, reposition the antenna for better reception. Check for sources of possible interference.
Lines or streaks in pictures	<ul style="list-style-type: none"> Check antenna (change the position of the antenna.)
No pictures when connecting HDMI	<ul style="list-style-type: none"> Check if the input source is HDMI1/HDMI2/HDMI3.
Pictures appear in wrong ratio	<ul style="list-style-type: none"> Adjust the Aspect Ratio settings in the SETUP menu or press the ASPECT button on the remote control.

TROUBLESHOOTING

The audio function does not work	
Picture OK but no sound	<ul style="list-style-type: none">• Press the VOL +/- buttons.• Sound muted? Press the MUTE button.• Try another channel. The problem may be caused by the broadcaster.
No output from one of the speakers	<ul style="list-style-type: none">• Adjust the Balance settings in the AUDIO menu.
Unusual sound from inside the TV	<ul style="list-style-type: none">• A change in ambient humidity or temperature may result in an unusual noise when the TV is switched on or off and does not indicate a fault with the TV.
No sound when connecting HDMI	<ul style="list-style-type: none">• Check if the input source is HDMI1/HDMI2/HDMI3.
Audio noise	<ul style="list-style-type: none">• Keep the RF coaxial cable away from the other connected cables.
Password	
Lost password	<ul style="list-style-type: none">• Select the SET Password setting in the LOCK menu, then enter the following master password "8899". The master password clears your previous password and allows you to enter a new password.
There is a problem in PC mode	
The signal is out of range (invalid format)	<ul style="list-style-type: none">• Adjust the resolution, horizontal frequency, or vertical frequency.
Vertical bar or stripe on background & Horizontal Noise & Incorrect position	<ul style="list-style-type: none">• Use Auto configures or adjust clock, phase, or H/V position.
Screen color is unstable or show a single color	<ul style="list-style-type: none">• Check the signal cable.• Reinstall the PC video card.

Maintaining

- Do not use your TV in areas that are too hot or too cold, because the cabinet may warp or the screen may malfunction. Your TV works best in temperatures that are comfortable to you.
- Storage temperatures are 32° to 122°F(0° to 50°C)
- Working temperatures are 32° to 95°F(0° to 35°C)
- Do not place your TV in direct sunlight or near a heat source

SPECIFICATION

Panel Size	39.5 inch diagonally
Display Type	DLED
Panel Technology	TFT
Panel 60 Hz Vs. 120 Hz	60 Hz
Display Resolution	1080P
HDMI Support	Up to 1080P
Panel Resolution	1920 x 1080
Aspect Ratio	16:9
Dynamic Contrast Ratio-Panel	5000:1
Response Time (G To G)	8.5 ms
Lamp Life (Typ. Hours)	30,000 hours
Horizontal Viewing Angle (At CR>10)	160
Vertical Viewing Angle (At CR>10)	150
Wall-mount(LxW-mm)	200*200 VESA(mm)

The FCC Wants You to Know



FCC STATEMENT

This device complies with Part 15 of the FCC Rules. Operation is subject to the following two conditions:

- (1) This device may not cause harmful interference, and
- (2) This device must accept any interference received, including interference that may cause undesired operation.

Changes or modifications not expressly approved by the party responsible for compliance could void the user's authority to operate the equipment.

NOTE: This equipment has been tested and found to comply with the limits for a Class B digital device, pursuant to Part 15 of the FCC Rules. These limits are designed to provide reasonable protection against harmful interference in a residential installation.

This equipment generates uses and can radiate radio frequency energy and, if not installed and used in accordance with the instructions, may cause harmful interference to radio communications. However, there is no guarantee that interference will not occur in a particular installation. If this equipment does cause harmful interference to radio or television reception, which can be determined by turning the equipment off and on, the user is encouraged to try to correct the interference by one or more of the following measures:

- Reorient or relocate the receiving antenna.
- Increase the separation between the equipment and receiver.
- Connect the equipment into an outlet on a circuit different from that to which the receiver is connected.
- Consult the dealer or an experienced radio/TV technician for help.

FCC Radiation Exposure Statement

This equipment complies with FCC radiation exposure limits set forth for an uncontrolled environment. This equipment should be installed and operated with minimum distance 20cm between the radiator & your body.

SEIKI LED TV's LIMITED WARRANTY TO ORIGINAL CONSUMER

52 inches and Under Screen Size Models (the "Product")

This Product (including any accessories included in the original packaging) as supplied and distributed in new condition, is warranted by **SEIKI LLC** (SEIKI) to the original consumer purchaser against defects in material and workmanship ("Warranty") as follows:

- 1. REPLACEMENT** : For a period of one (1) year from date of original consumer purchase, if this Product or any part is determined by SEIKI, or a SEIKI authorized service provider, to be defective, SEIKI will replace the Product with new or re-certified product of similar or better specification, at SEIKI's option, at no charge to the original consumer. After the one (1) year Warranty period, you must pay for all cost of Product replacement charges.
Once the Product is replaced, the warranty resume one (1) year period from the date of original consumer purchase; and will not be extended for the replacement process. Advanced Replacement option is available only with a valid US credit card for guarantee purpose.
- 2. PARTS** : For a period of one (1) year from the date of original consumer purchase, SEIKI will supply, at no charge to the original consumer, new, rebuilt or refurbished replacement parts in exchange for defective parts. After the one (1) year Warranty period, you must pay for the costs of all parts.
- 3. SHIPPING COSTS** : Notwithstanding the foregoing, the original consumer is responsible for any shipping charges incurred to ship the Product or part(s) to SEIKI or to an SEIKI authorized customer service provider, for diagnosis, repair or replacement. The consumer is responsible for securely packing the Product and utilizing a reliable carrier to transport to SEIKI authorized service provider.

To obtain Warranty Service and Troubleshooting information call our toll free customer service line at:

1-855-MY-SEIKI (1-855-697-3454)

Please have your model and serial number available along with your date of purchase.

You can also visit us online and REGISTER your SEIKI product at:

www.SEIKI.com

To receive Warranty service, the original consumer purchaser must contact SEIKI for problem determination and service procedures. **Proof of purchase in the form of a bill of sale or receipted invoice, evidencing that the Product is within the applicable Warranty period(s), MUST be presented to SEIKI, or an authorized customer service provider, in order to obtain the requested service.**

Exclusions and Limitations

This Warranty covers manufacturing defects in materials and workmanship encountered in the normal, non-commercial use of the Product, and does not cover (a) damage or failure caused by or attributable to abuse, misuse, failure to follow instructions, improper installation or maintenance, alteration, accident, or excess voltage or current; (b) improper or incorrectly performed repairs by non-authorized service facilities; (c) onsite consumer instruction or adjustments; (d) transportation, shipping, delivery, insurance, installation or set-up costs; (e) costs of product removal, transportation or reinstallation costs; (f) ordinary wear and tear, cosmetic damage or damage due to acts of nature, accident; (g) commercial use of the Product; (h) modification of, or to any part of the Product. In addition, this Warranty does not cover images "burnt" into the screen. This Warranty applies to the original consumer only and does not cover products sold AS IS or WITH ALL FAULTS, or consumables (e.g., fuses, batteries, bulbs etc.), and the Warranty is invalid if the factory-applied serial number has been altered or removed from the Product. This Warranty is valid only in the United States and Canada, and only applies to products purchased and serviced in the United States and Canada. All replaced parts and products, and products on which a refund is made, become the property of the Warrantor.

NO WARRANTIES, WHETHER EXPRESS OR IMPLIED, INCLUDING, BUT NOT LIMITED TO, ANY IMPLIED WARRANTIES OF MERCHANTABILITY OR FITNESS FOR A PARTICULAR PURPOSE, OTHER THAN THOSE EXPRESSLY DESCRIBED ABOVE SHALL APPLY. THE WARRANTOR FURTHER DISCLAIMS ALL WARRANTIES AFTER THE EXPRESS WARRANTY PERIOD STATED ABOVE. NO OTHER EXPRESS WARRANTY OR GUARANTY GIVEN BY ANY PERSON, FIRM OR ENTITY WITH RESPECT TO THE PRODUCT SHALL BE BINDING ON THE WARRANTOR. REPAIR, REPLACEMENT, OR REFUND OF THE ORIGINAL PURCHASE PRICE - AT THE WARRANTOR'S SOLE DISCRETION - ARE THE EXCLUSIVE REMEDIES OF THE CONSUMER. THE WARRANTOR SHALL NOT BE LIABLE FOR ANY INCIDENTAL OR CONSEQUENTIAL DAMAGES CAUSED BY THE USE, MISUSE OR INABILITY TO USE THE PRODUCT. NOTWITHSTANDING THE FOREGOING, CONSUMER'S RECOVERY SHALL NOT EXCEED THE PURCHASE PRICE OF THE PRODUCT SOLD BY SEIKI. THIS WARRANTY SHALL NOT EXTEND TO ANYONE OTHER THAN THE ORIGINAL CONSUMER WHO PURCHASED THE PRODUCT AND IS NOT TRANSFERABLE.

Some states do not allow the exclusion or limitation of incidental or consequential damages, or allow limitations on warranties, so the above limitations or exclusions may not apply to you. This Warranty gives you specific rights, and you may have other rights, which vary from state to state.

SEIKI LLC
c/o SEIKI Digital Customer Service
6880 Commerce Blvd., Canton, MI 48187 USA
customerservice@seikidigital.com

DO NOT SHIP PRODUCT TO THIS ADDRESS. PLEASE CONTACT CUSTOMER SERVICE TO OBTAIN SHIPPING ADDRESSES FOR SERVICE.

OTT APP SERVICE

If you want to know about these APP information or get more service. Please refer to following content.

- **Netflix**



You can call the following telephone for more help: **866-579-7172**

If your matter is regarding customer service, please refer to <https://contactus.netflix.com/help> for alternative contact information.

- **YouTube**



You can browse the following website for more help:

<https://productforums.google.com/forum#!categories/youtube/smart-tvs>

- **VUDU**



You can call the following telephone for more help: **888-554-8838**

- **TG**



You can call the following telephone for more help: **888-874-5411**

- **Pandora**



You can send E-mail to Pandora for more help: pandora-support@pandora.com

- **AccuWeather**



You can send E-mail to AccuWeather for more help: CustomerService@AccuWeather.com